



# HAC TEST REPORT

**Applicant** Yulong Computer Telecommunication  
Scientific (Shenzhen) Co., Ltd

**FCC ID** R38YL3310A

**Product** Smartphone

**Model** Coolpad 3310A

**Report No.** R1805A0223-H1

**Issue Date** June 13, 2018

TA Technology (Shanghai) Co., Ltd. tested the above equipment in accordance with the requirements in **ANSI C63.19-2011**. The test results show that the equipment tested is capable of demonstrating compliance with the requirements as documented in this report.

*Performed by: Jiangpeng Lan*

*Approved by: Kai Xu*

**TA Technology (Shanghai) Co., Ltd.**

*No.145, Jintang Rd, Tangzhen Industry Park, Pudong Shanghai, China*

*TEL: +86-021-50791141/2/3*

*FAX: +86-021-50791141/2/3-8000*



## Table of Contents

1	Test Laboratory.....	3
1.1	Notes of the Test Report.....	3
1.2	Test facility.....	3
1.3	Testing Location.....	4
1.4	Laboratory Environment.....	4
2	Statement of Compliance.....	5
3	Description of Equipment under Test.....	6
4	Test Specification and Operational Conditions.....	8
4.1	Test Specification.....	8
5	Test Information.....	9
5.1	Operational Conditions during Test.....	9
5.1.1	General Description of Test Procedures.....	9
5.2	HAC RF Measurements System Configuration.....	9
5.2.1	HAC Measurement Set-up.....	9
5.2.2	Probe System.....	10
5.2.3	Test Arch Phantom & Phone Positioner.....	11
5.3	RF Test Procedures.....	12
5.4	System Check.....	14
5.5	Average Antenna Input Power & Evaluation for Low-power Exemption.....	15
6	Test Results.....	16
6.1	ANSI C63.19-2011 Limits.....	16
6.2	Summary Test Results.....	17
7	Measurement Uncertainty.....	18
8	Main Test Instruments.....	19
	ANNEX A: System Check Results.....	20
	ANNEX B: Graph Results.....	23
	ANNEX C: E-Probe Calibration Certificate.....	47
	ANNEX D: CD835V3 Dipole Calibration Certificate.....	86
	ANNEX E: CD1880V3 Dipole Calibration Certificate.....	91
	ANNEX F: CD2600V3 Dipole Calibration Certificate.....	96
	ANNEX G: DAE4 Calibration Certificate.....	101
	ANNEX H: The EUT Appearances and Test Configuration.....	106



# 1 Test Laboratory

## 1.1 Notes of the Test Report

This report shall not be reproduced in full or partial, without the written approval of **TA Technology (Shanghai) Co., Ltd.** The results documented in this report apply only to the tested sample, under the conditions and modes of operation as described herein. Measurement Uncertainties were not taken into account and are published for informational purposes only. This report is written to support regulatory compliance of the applicable standards stated above.

## 1.2 Test facility

### **CNAS (accreditation number: L2264)**

TA Technology (Shanghai) Co., Ltd. has obtained the accreditation of China National Accreditation Service for Conformity Assessment (CNAS).

### **FCC (Designation number: CN1179, Test Firm Registration Number: 446626)**

TA Technology (Shanghai) Co., Ltd. has been listed on the US Federal Communications Commission list of test facilities recognized to perform electromagnetic emissions measurements.

### **IC (recognition number is 8510A)**

TA Technology (Shanghai) Co., Ltd. has been listed by industry Canada to perform electromagnetic emission measurement.

### **VCCI (recognition number is C-4595, T-2154, R-4113, G-10766)**

TA Technology (Shanghai) Co., Ltd. has been listed by industry Japan to perform electromagnetic emission measurement.

### **A2LA (Certificate Number: 3857.01)**

TA Technology (Shanghai) Co., Ltd. has been listed by American Association for Laboratory Accreditation to perform electromagnetic emission measurement.



### 1.3 Testing Location

Company: TA Technology (Shanghai) Co., Ltd.  
Address: No.145, Jintang Rd, Tangzhen Industry Park, Pudong Shanghai, China  
City: Shanghai  
Post code: 201201  
Country: P. R. China  
Contact: Xu Kai  
Telephone: +86-021-50791141/2/3  
Fax: +86-021-50791141/2/3-8000  
Website: <http://www.ta-shanghai.com>  
E-mail: [xukai@ta-shanghai.com](mailto:xukai@ta-shanghai.com)

### 1.4 Laboratory Environment

Temperature	Min. = 18°C, Max. = 28 °C
Relative humidity	Min. = 0%, Max. = 80%
Ground system resistance	< 0.5 $\Omega$
Ambient noise is checked and found very low and in compliance with requirement of standards. Reflection of surrounding objects is minimized and in compliance with requirement of standards.	



## 2 Statement of Compliance

Table 2.1: The Total M-rating of each tested band

Mode	Rating
CDMA BC0	<b>M4</b>
CDMA BC1	<b>M4</b>
CDMA BC10	<b>M4</b>
LTE TDD 41	<b>M4</b>
LTE – FDD & Wi-Fi	<b>M4</b>
Date of Testing: May 30, 2018	
Note: RF Emission testing for this device is required only for CDMA modes. All other applicable air-interfaces are exempt from testing in accordance with C63.19-2011 Clause 4.4 and are rated M4	

### 3 Description of Equipment under Test

#### Client Information

<b>Applicant</b>	Yulong Computer Telecommunication Scientific (Shenzhen) Co., Ltd
<b>Applicant address</b>	Coolpad Information Harbor, High-tech Industrial Park (North), Nanshan District, Shenzhen, P.R.C.
<b>Manufacturer</b>	Yulong Computer Telecommunication Scientific (Shenzhen) Co., Ltd
<b>Manufacturer address</b>	Coolpad Information Harbor, High-tech Industrial Park (North), Nanshan District, Shenzhen, P.R.C.

#### General Technologies

<b>Device Type</b>	Portable Device	
<b>State of Sample</b>	Prototype Unit	
<b>Model</b>	Coolpad 3310A	
<b>IMEI</b>	990007950008513	
<b>Hardware Version</b>	P0	
<b>Software Version</b>	3310A.SPRINT.180608.00	
<b>Antenna Type</b>	Internal Antenna	
<b>Power Class</b>	CDMA BC0/BC1/BC10: 3 LTE FDD 2/4/5/12/13/25/26:3 LTE TDD 41:3	
<b>Power Level</b>	CDMA BC0/BC1/BC10: Tested with Power Control All up bits LTE FDD 2/4/5/12/13/25/26: max power LTE TDD 41: max power	
<b>Test Modulation</b>	(CDMA) QPSK; (LTE)QPSK 16QAM;	
<b>Operating Frequency Range(s)</b>	<b>Mode</b>	<b>Tx (MHz)</b>
	CDMA BC0	824 ~ 849
	CDMA BC1	1850 ~ 1910
	CDMA BC10	817 ~ 824
	LTE FDD 2	1850 ~ 1910
	LTE FDD 4	1710 ~ 1755
	LTE FDD 5	824 ~ 849
	LTE FDD 12	699 ~ 716
	LTE FDD 13	777 ~ 787
	LTE FDD 25	1850~ 1915
	LTE FDD 26	814 ~ 849
	LTE TDD 41	2496 ~ 2690
	Wi-Fi	2412 ~ 2462
BT	2402 ~ 2480	



Accessory Equipment	
<b>Battery</b>	Manufacturer: SHENZHEN RUIDE ELECTRONIC INDUSTRIAL CO.,LTD Model: CPLD-189

Air-Interface	Band (MHz)	Type	HAC tested	Simultaneous Transmissions Note: Not to be tested	Reduced power 20.19(c)(1)	Voice Over Digital Transport (Data)
CDMA	BC0	VO	Yes	Wi-Fi or BT	NO	NA
	BC1				NO	NA
	BC10				NO	NA
LTE	FDD 2	VD	NA	Wi-Fi or BT	NO	Yes
	FDD 4	VD	NA		NO	Yes
	FDD 5	VD	NA		NO	Yes
	FDD 12	VD	NA		NO	Yes
	FDD 13	VD	NA		NO	Yes
	FDD 25	VD	NA		NO	Yes
	FDD 26	VD	NA		NO	Yes
TDD 41	VD	Yes	NO	Yes		
Wi-Fi	2450	DT	NA	CDMA, LTE	NO	NA
Bluetooth (BT)	2450	DT	NA	CDMA, LTE	NO	NA

VO Voice CMRS/PSTN Service only  
DT Digital Transport  
VD Voice CMRS/PSTN and Data Service  
#: Evaluated for MIF and Low power exemption Rating was based on concurrent voice and



## 4 Test Specification and Operational Conditions

### 4.1 Test Specification

The tests documented in this report were performed in accordance with the following:

**FCC CFR47 Part 20.19**

**ANSI C63.19-2011**

**285076 D01 HAC Guidance v05**

**285076 D02 T-Coil Testing v03**



## 5 Test Information

### 5.1 Operational Conditions during Test

#### 5.1.1 General Description of Test Procedures

The phone was tested in all normal configurations for the ear use. The EUT is mounted in the device holder equivalent as for classic dosimeter measurements. The acoustic output of the EUT shall coincide with the center point of the area formed by the dielectric wire and the middle bar of the arch's top frame. The EUT shall be moved vertically upwards until it touches the frame. The fine adjustment is possible by sliding the complete. The EUT holder is on the yellow base plate of the Test Arch phantom. These test configurations are tested at the high, middle and low frequency channels of each applicable operating mode.

A communication link is set up with a System Simulator (SS) by air link, and a call is established. The EUT is commanded to operate at maximum transmitting power.

### 5.2 HAC RF Measurements System Configuration

#### 5.2.1 HAC Measurement Set-up

These measurements are performed using the DASY5 automated dosimetric assessment system. It is made by Schmid & Partner Engineering AG (SPEAG) in Zurich, Switzerland. It consists of high precision robotics system (Stäubli), robot controller, Intel Core2 computer, near-field probe, probe alignment sensor. The robot is a six-axis industrial robot performing precise movements. Cell controller systems contain the power supply, robot controller, teach pendant (Joystick) and remote control, and are used to drive the robot motors. The Stäubli Robot is connected to the cell controller to allow software manipulation of the robot. A data acquisition electronic (DAE) circuit performs the signal amplification; signal multiplexing, AD-conversion, offset measurements, mechanical surface detection, collision detection, etc. is connected to the Electro-optical coupler (EOC). The EOC performs the conversion from the optical into digital electric signal of the DAE and transfers data to the PC plug-in card.

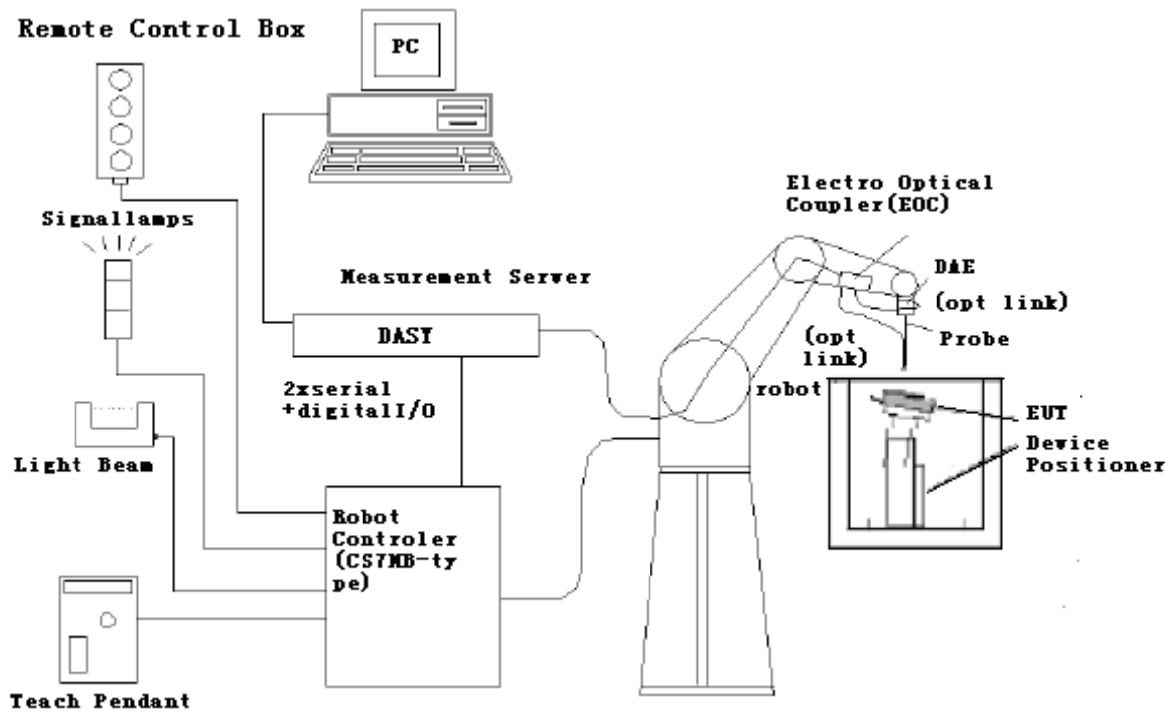

Figure 1 HAC Test Measurement Set-up

The DAE4 consists of a highly sensitive electrometer-grade preamplifier with auto-zeroing, a channel and gain-switching multiplexer, a fast 16 bit AD-converter and a command decoder and control logic unit. Transmission to the PC-card is accomplished through an optical downlink for data and status information and an optical uplink for commands and clock lines. The mechanical probe mounting device includes two different sensor systems for frontal and sidewise probe contacts. They are also used for mechanical surface detection and probe collision detection. The robot uses its own controller with a built in VME-bus computer.

### 5.2.2 Probe System

The HAC measurements were conducted with the E-Field Probe EF3DV3 and the H-Field Probe H3DV6 (manufactured by SPEAG), designed in the classical triangular configuration and optimized for dosimetric evaluation.

### E-Field Probe Description

Construction	One dipole parallel, two dipoles normal to probe axis Built-in shielding against static charges PEEK enclosure material
Calibration	In air from 100 MHz to 3.0 GHz (absolute accuracy $\pm 6.0\%$ , $k=2$ )
Frequency	40 MHz to > 6 GHz (can be extended to < 20 MHz) Linearity: $\pm 0.2$ dB (100 MHz to 3 GHz)
Directivity	$\pm 0.2$ dB in air (rotation around probe axis) $\pm 0.4$ dB in air (rotation normal to probe axis)
Dynamic Range	2 V/m to > 1000 V/m; Linearity: $\pm 0.2$ dB
Dimensions	Overall length: 330 mm (Tip: 16 mm) Tip diameter: 8 mm (Body: 12 mm) Distance from probe tip to dipole centers: 2.5 mm
Application	General near-field measurements up to 6 GHz Field component measurements Fast automatic scanning in phantoms



**Figure 2 EF3DV3 E-field Probe**

### 5.2.3 Test Arch Phantom & Phone Positioner

The Test Arch phantom should be positioned horizontally on a stable surface. Reference markings on the Phantom allow the complete setup of all predefined phantom positions and measurement grids by manually teaching three points in the robot. It enables easy and well defined positioning of the phone and validation dipoles as well as simple teaching of the robot (Dimensions: 370 x 370 x 370 mm). The Device reference point is set for the EUT at 6.3 mm, the Grid reference point is on the upper surface at the origin of the coordinates, and the “user point \Height Check 0.5 mm” is 0.5mm above the center, allowing verification of the gap of 0.5mm while the probe is positioned there.

The Phone Positioner supports accurate and reliable positioning of any phone with effect on near field  $< \pm 0.5$  dB.

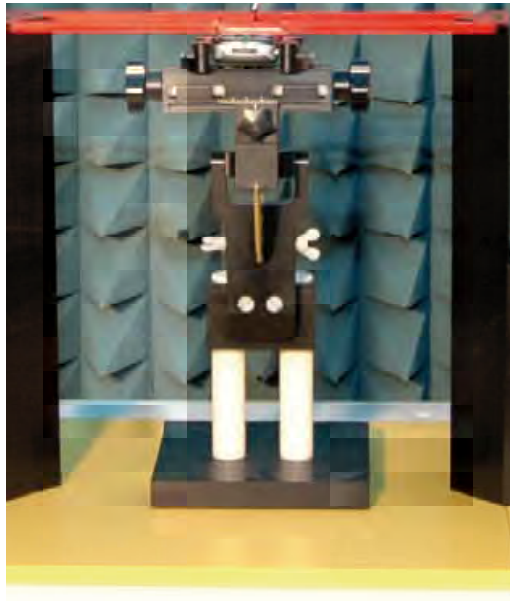

Figure 3 HAC Phantom & Device Holder

### 5.3 RF Test Procedures

The evaluation was performed with the following procedure:

1. Confirm proper operation of the field probe, probe measurement system and other instrumentation and the positioning system.
2. Position the WD in its intended test position. The gauge block can simplify this positioning. Note that a separate E-field gauge block will be needed if the center of the probe sensor elements is at different distances from the tip of the probe.
3. Configure the WD normal operation for maximum rated RF output power, at the desired channel and other operating parameters (e.g., test mode), as intended for the test.
4. The center sub-grid shall center on the center of the axial measurement point or the acoustic output, as appropriate. Locate the field probe at the initial test position in the 50 mm by 50 mm grid, which is contained in the measurement plane. If the field alignment method is used, align the probe for maximum field reception.
5. Record the reading.
6. Scan the entire 50 mm by 50 mm region in equally spaced increments and record the reading at each measurement point. The grid is 5 cm by 5 cm area that is divided into 9 evenly sized blocks or sub-grids. The distance between measurement points shall be sufficient to assure the identification of the maximum reading.
7. Identify the five contiguous sub-grids around the center sub-grid with the lowest maximum field strength readings. Thus the six areas to be used to determine the WD's highest emissions are identified and outlined for the final manual scan. Please note that a maximum of five blocks can be excluded for both E-field measurements for the WD output being measured. Stated another way, the center sub-grid and three others must be common to both the E-field measurements.
8. Identify the maximum field reading within the non-excluded sub-grids identified in Step 7.
9. Convert the maximum field strength reading identified in Step 8 to V/m or A/m, as appropriate. For probes which require a probe modulation factor, this conversion shall be done using the

appropriate probe modulation factor and the calibration.

10. Repeat Step 1 through Step 10 for both the E-field measurements.
11. Compare this reading to the categories in ANSI C63.19 Clause 8 and record the resulting category. The lowest category number listed in 8.2, Table 8.3 obtained in Step 10 for either E-field determines the M category for the audio coupling mode assessment. Record the WD category rating.



Figure 4 WD reference and plane for RF emission measurements

## 5.4 System Check

### Validation Procedure

Place a dipole antenna meeting the requirements given in ANSI C63.19 D.11 in the position normally occupied by the WD. The dipole antenna serves as a known source for an electrical output. Position the E-field probe so that:

The probes and their cables are parallel to the coaxial feed of the dipole antenna.

The probe cables and the coaxial feed of the dipole antenna approach the measurement area from opposite directions.

Position the E-field probe at a 15 mm distance from the center of the probe element to the top surface. Validation was performed to verify that measured E-field is within +/-18% from the target reference values provided by the manufacturer. "Values within +/-18% are acceptable. Of which 12% is deviation and 13% is measurement uncertainty."

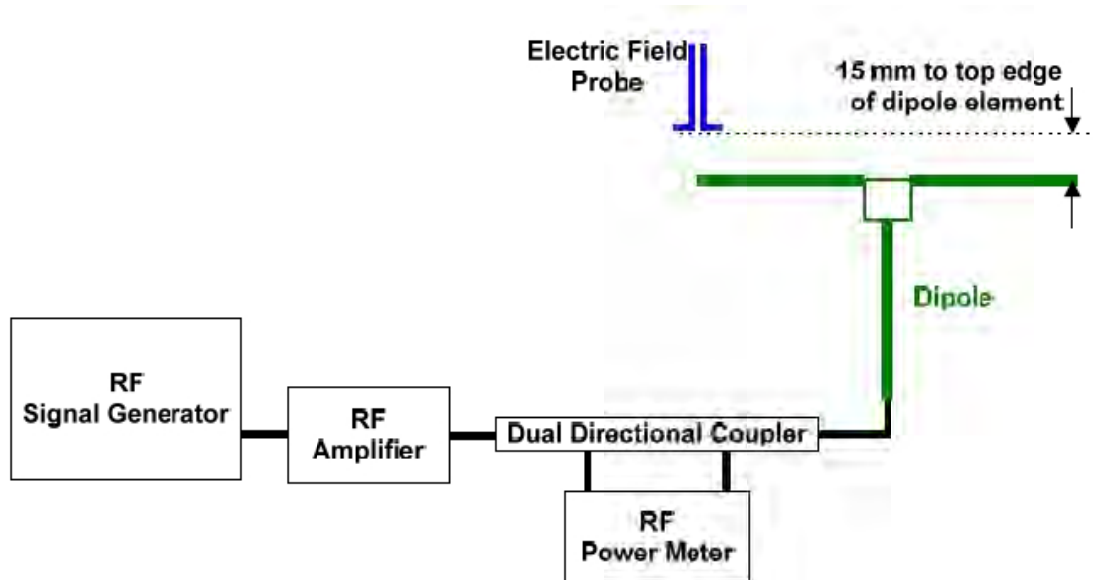

Figure 5 Dipole Validation Setup

Frequency (MHz)	Input Power (mW)	Target <sup>1</sup> Value (V/m)	Measured <sup>2</sup> Value (V/m)	Deviation <sup>3</sup> (%)	Test Date
835	100	105.8	107.3	1.42	May 30, 2018
1880	100	89.2	92.1	3.25	May 30, 2018
2600	100	86.8	87.4	0.69	May 30, 2018

### 5.5 Average Antenna Input Power & Evaluation for Low-power Exemption

An RF air interface technology of a device is exempt from testing when its average antenna input power plus its MIF is  $\leq 17$  dBm for any of its operating modes. If a device supports multiple RF air interfaces, each RF air interface shall be evaluated individually.

Band	Average Antenna Input Power (dBm) <sup>(1)</sup>	Worst Case MIF (dB)	Input Power plus its MIF (dBm)	HAC Tested
CDMA BC0	25.5	3.26	28.76	Yes
CDMA BC1	25.5	3.26	28.76	Yes
CDMA BC10	25.5	3.26	28.76	Yes
LTE FDD 2	25.0	-9.76	15.24	No
LTE FDD 4	25.0	-9.76	15.24	No
LTE FDD 5	25.0	-9.76	15.24	No
LTE FDD 12	25.0	-9.76	15.24	No
LTE FDD 13	25.0	-9.76	15.24	No
LTE FDD 25	25.0	-9.76	15.24	No
LTE FDD 26	25.0	-9.76	15.24	No
LTE TDD 41	27.5	-1.44	26.06	Yes
802.11b	17.5	-2.02	15.48	No
802.11g	14.5	0.12	14.62	No
802.11n HT20	13.5	-5.59	7.91	No

Note: 1. Max tune-up limit

2. MIF values applied in this test report were provided by the HAC equipment provider, SPEAG.



## 6 Test Results

### 6.1 ANSI C63.19-2011 Limits

Category	Telephone RF parameters < 960 MHz	Telephone RF parameters > 960 MHz
<b>Near field</b>	<b>E-field emissions</b>	
Category M1	50 to 55 dB (V/m)	40 to 45 dB (V/m)
Category M2	45 to 50 dB (V/m)	35 to 40 dB (V/m)
Category M3	40 to 45 dB (V/m)	30 to 35 dB (V/m)
Category M4	< 40 dB (V/m)	< 30 dB (V/m)





## 6.2 Summary Test Results

### Results

Band	Channel	Frequency (MHz)	E-Field Emissions dB (V/m)	Power Drift (dB)	Category	Graph Results
CDMA BC0	777	848.31	26.30	-0.02	M4	1
	384	836.52	25.99	-0.06	M4	2
	1013	824.70	25.62	-0.02	M4	3
CDMA BC1	1175	1908.75	26.40	-0.05	M4	4
	600	1880.00	26.60	-0.03	M4	5
	25	1851.25	27.27	-0.09	M4	6
CDMA BC10	684	823.1	27.43	-0.05	M4	7
	580	820.5	28.09	-0.12	M4	8
	476	817.9	23.54	-0.14	M4	9
LTE TDD 41	41490	2680	23.36	-0.05	M4	10
	40620	2593	25.37	0.17	M4	11
	39750	2506	25.82	0.02	M4	12



## 7 Measurement Uncertainty

Measurement uncertainty evaluation template for DUT HAC RF test (ANSI C63.19-2011)

Error source	Type	Uncertainty Value ( $\pm$ %)	Prob. Dist.	k	$c_i/E$	$c_i/H$	Standard Uncertainty $u_i$ ( $\pm$ %)	Degree of freedom $v_{eff}$ or $v_i$
<b>Measurement system</b>								
Probe Calibration	B	5.1	N	1	1	1	5.1	$\infty$
Axial Isotropy	B	4.7	R	1.732	1	1	2.7	$\infty$
Sensor Displacement	B	16.5	R	1.732	1	0.145	9.5	$\infty$
Boundary Effects	B	2.4	R	1.732	1	1	1.4	$\infty$
Test Arch	B	7.2	R	1.732	1	0	4.2	$\infty$
Linearity	B	4.7	R	1.732	1	1	2.7	$\infty$
Scaling to Peak Envelope Power	B	2.0	R	1.732	1	1	1.2	$\infty$
System Detection Limit	B	1.0	R	1.732	1	1	0.6	$\infty$
Readout Electronics	B	0.3	N	1	1	1	0.3	$\infty$
Response Time	B	0.8	R	1.732	1	1	0.5	$\infty$
Integration Time	B	2.6	R	1.732	1	1	1.5	$\infty$
RF Ambient Conditions	B	3.0	R	1.732	1	1	1.7	$\infty$
RF Reflections	B	12.0	R	1.732	1	1	6.9	$\infty$
Probe Positioner	B	1.2	R	1.732	1	0.67	0.7	$\infty$
Probe Positioning	A	4.7	R	1.732	1	0.67	2.7	$\infty$
Extra. And Interpolation	B	1.0	R	1.732	1	1	0.6	$\infty$
<b>Test sample related</b>								
Device Positioning Vertical	B	4.7	R	1.732	1	0.67	2.7	$\infty$
Device Positioning Lateral	B	1.0	R	1.732	1	1	0.6	$\infty$
Device Holder and Phantom	B	2.4	R	1.732	1	1	1.4	$\infty$
Power Drift	B	5.0	R	1.732	1	1	2.9	$\infty$
<b>Phantom and Setup related</b>								
Phantom Thickness	B	2.4	R	1.732	1	0.67	1.4	$\infty$
Combined standard uncertainty (%)							15.3	
Expanded Std. uncertainty on power (K=2)							30.6	
Expanded Std. uncertainty on field (K=2)							15.3	



## 8 Main Test Instruments

Name	Manufacturer	Type	Serial Number	Calibration Date	Expiration Time
Power meter	Agilent	E4417A	GB41291714	2018-05-21	2019-05-20
Power meter	Agilent	E4418B	MY50000623	2018-05-21	2019-05-20
Power sensor	Agilent	N8481H	MY50350004	2018-05-21	2019-05-20
Power sensor	Agilent	E9327A	US40441622	2018-05-21	2019-05-20
Signal Generator	Agilent	N5181A	MY50140143	2018-05-21	2019-05-20
Amplifier	INDEXSAR	IXA-020	0401	2018-05-21	2019-05-20
Universal Radio Communication Tester	R&S	CMW 500	146734	2018-05-20	2019-05-19
E-Field Probe	SPEAG	EF3DV3	4048	2018-01-09	2021-01-08
DAE	SPEAG	DAE4	1291	2017-10-31	2018-10-30
Validation Kit 835MHz	SPEAG	CD835V3	1133	2017-11-22	2019-11-21
Validation Kit 1880MHz	SPEAG	CD1880V3	1115	2017-11-22	2019-11-21
Validation Kit 2600MHz	SPEAG	CD2600V3	1016	2017-11-22	2019-11-21
Hygrothermograph	Anymetr	NT-311	20150731	2018-05-17	2019-05-16
HAC Phantom	SPEAG	SD HAC P01 BB	1117	2017-11-22	2020-11-21
Software for Test	Speag	DASY5	52.8.8.1222	/	/
Software for Tissue	Agilent	85070	E06.01.36	/	/

\*\*\*\*\*END OF REPORT \*\*\*\*\*

## ANNEX A: System Check Results

### HAC\_System Performance Check at 835MHz\_E

DUT: Dipole 835 MHz; Type: CD835V3; SN:1023

Date: 5/30/2018

Communication System: CW; Frequency: 835 MHz;Duty Cycle: 1:1

Ambient Temperature:22.3 °C

Phantom section: RF Section

DASY5 Configuration:

Sensor-Surface: 0mm (Fix Surface)

Probe: EF3DV3 – SN4048; ConvF(1, 1, 1); Calibrated: 1/8/2018

Electronics: DAE4 Sn1291; Calibrated: 10/31/2017

Phantom: HAC Test Arch with AMCC; Type: SD HAC P01 BA;

Measurement SW: DASY52, Version 52.8 (8); SEMCAD X Version 14.6.10 (7331)

**E Scan - measurement distance from the probe sensor center to CD835 Dipole = 15mm**

**/Hearing Aid Compatibility Test (41x361x1):** Measurement grid: dx=0.5000 mm, dy=0.5000 mm

Maximum value of peak Total field = 107.3 V/m

Applied MIF = 0.00 dB

Device Reference Point: 0, 0, -6.3 mm

Reference Value = 91.00 V/m; Power Drift = 0.03 dB

**Hearing Aid Near-Field Category: M4 (AWF 0 dB)**

Peak E-field in V/m

Grid 1 <b>101.20 M4</b>	Grid 2 <b>104.30 M4</b>	Grid 3 <b>101.50 M4</b>
Grid 4 <b>61.20 M4</b>	Grid 5 <b>64.23 M4</b>	Grid 6 <b>62.39 M4</b>
Grid 7 <b>104.50 M4</b>	Grid 8 <b>107.30 M4</b>	Grid 9 <b>104.30 M4</b>

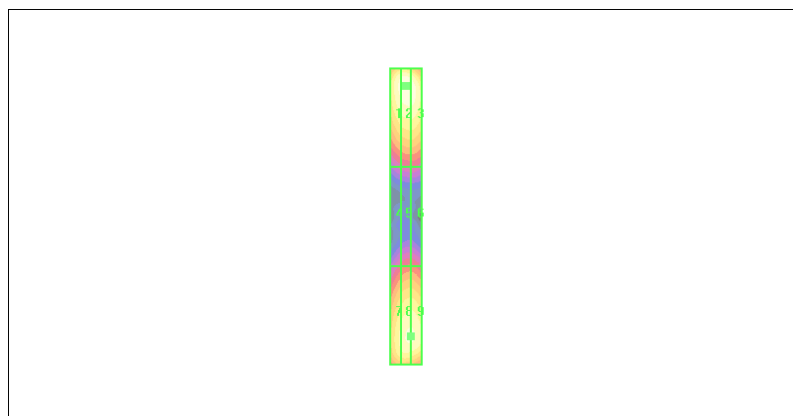
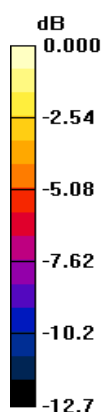



### HAC\_System Performance Check at 1880MHz\_E

DUT: Dipole 1880 MHz; Type: CD1880V3; SN: 1018

Date: 5/30/2018

Communication System: CW; Frequency: 1880 MHz;Duty Cycle: 1:1

Ambient Temperature:22.3 °C

Phantom section: RF Section

DASY5 Configuration:

Sensor-Surface: 0mm (Fix Surface)

Probe: EF3DV3 – SN4048; ConvF(1, 1, 1); Calibrated: 1/8/2018

Electronics: DAE4 Sn1291; Calibrated: 10/31/2017

Phantom: HAC Test Arch with AMCC; Type: SD HAC P01 BA;

Measurement SW: DASY52, Version 52.8 (8); SEMCAD X Version 14.6.10 (7331)

**E Scan - measurement distance from the probe sensor center to CD1880 Dipole = 15mm/Hearing Aid Compatibility Test (41x181x1):** Measurement grid: dx=0.5000 mm, dy=0.5000 mm

Maximum value of peak Total field = 92.1 V/m

Applied MIF = 0.00 dB

Device Reference Point: 0, 0, -6.3 mm

Reference Value = 86V/m; Power Drift = 0.002 dB

**Hearing Aid Near-Field Category: M2 (AWF 0 dB)**

Peak E-field in V/m

Grid 1 <b>91.78 M2</b>	Grid 2 <b>92.10 M2</b>	Grid 3 <b>91.42M2</b>
Grid 4 <b>71.76 M3</b>	Grid 5 <b>73.56 M3</b>	Grid 6 <b>71.17 M3</b>
Grid 7 <b>87.15 M2</b>	Grid 8 <b>89.46 M2</b>	Grid 9 <b>89.01 M2</b>

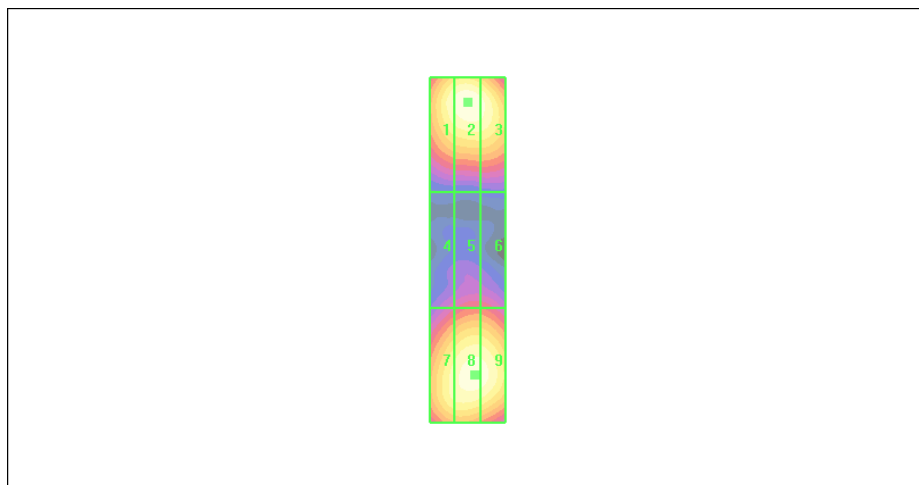
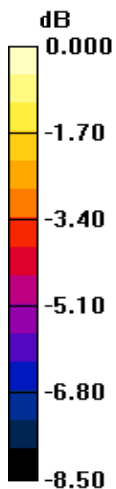



### HAC\_System Performance Check at 2600MHz\_E

DUT: Dipole 2600 MHz; Type: CD2600V3; SN: 1016

Date: 5/30/2018

Communication System: CW; Frequency: 2600 MHz;Duty Cycle: 1:1

Ambient Temperature:22.3 °C

Phantom section: RF Section

DASY5 Configuration:

Sensor-Surface: 0mm (Fix Surface)

Probe: EF3DV3 – SN4048; ConvF(1, 1, 1); Calibrated: 1/8/2018

Electronics: DAE4 Sn1291; Calibrated: 10/31/2017

Phantom: HAC Test Arch with AMCC; Type: SD HAC P01 BA;

Measurement SW: DASY52, Version 52.8 (8); SEMCAD X Version 14.6.10 (7331)

**E Scan - measurement distance from the probe sensor center to CD2600 Dipole = 15mm/Hearing Aid Compatibility Test (41x181x1):** Measurement grid: dx=0.5000 mm, dy=0.5000 mm

Maximum value of peak Total field = 87.40 V/m

Applied MIF = 0.00 dB

Device Reference Point: 0, 0, -6.3 mm

Reference Value = 71.52V/m; Power Drift = 0.01 dB

**Hearing Aid Near-Field Category: M2 (AWF 0 dB)**

Peak E-field in V/m

Grid 1 <b>83.35 M2</b>	Grid 2 <b>86.32 M2</b>	Grid 3 <b>85.70M2</b>
Grid 4 <b>79.62 M3</b>	Grid 5 <b>81.46 M3</b>	Grid 6 <b>81.15 M3</b>
Grid 7 <b>84.28 M2</b>	Grid 8 <b>87.40 M2</b>	Grid 9 <b>86.59 M2</b>

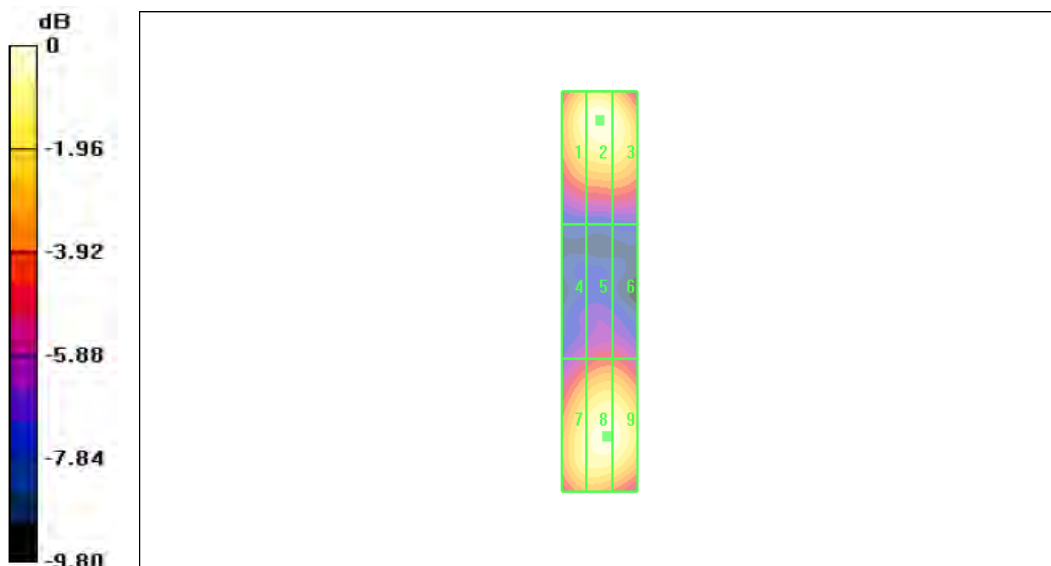



## ANNEX B: Graph Results

### Plot 1 HAC RF E-Field CDMA BC0 High

Date: 5/30/2018

Communication System: UID 10295-AAB, HAC CDMA (0); Frequency: 848.31 MHz; Duty Cycle: 1:15.8489

Ambient Temperature: 22.3 °C Phantom section: RF Section

DASY5 Configuration:

Sensor-Surface: 0mm (Fix Surface)

Probe: EF3DV3 – SN4048; ConvF(1, 1, 1); Calibrated: 1/8/2018

Electronics: DAE4 Sn1291; Calibrated: 10/31/2017

Phantom: HAC Test Arch with AMCC; Type: SD HAC P01 BA;

Measurement SW: DASY52, Version 52.8 (8); SEMCAD X Version 14.6.10 (7331)

**Coolpad 3310A CDMA BC0 HAC RF E-Field 2011 Device E-Field measurement (E-field scan for ANSI C63.19-2007 & -2011 compliance)/E Scan - ER3D: 15 mm from Probe Center to the Device High/Hearing Aid Compatibility Test (101x101x1):** Interpolated grid: dx=0.5000 mm, dy=0.5000 mm

Device Reference Point: 0, 0, -6.3 mm

Reference Value = 17.57 V/m; Power Drift = -0.02 dB

Applied MIF = 3.26 dB

RF audio interference level = 26.30 dBV/m

**Emission category: M4**

MIF scaled E-field

Grid 1 M4 26.56 dBV/m	Grid 2 M4 26.06 dBV/m	Grid 3 M4 24.54 dBV/m
Grid 4 M4 26.64 dBV/m	Grid 5 M4 26.3 dBV/m	Grid 6 M4 24.7 dBV/m
Grid 7 M4 26.59 dBV/m	Grid 8 M4 26.07 dBV/m	Grid 9 M4 24.7 dBV/m

**Cursor:**

Total = 26.64 dBV/m

E Category: M4

Location: 25, 5, 7.7 mm

Maximum value of Total (interpolated) = 21.49 V/m

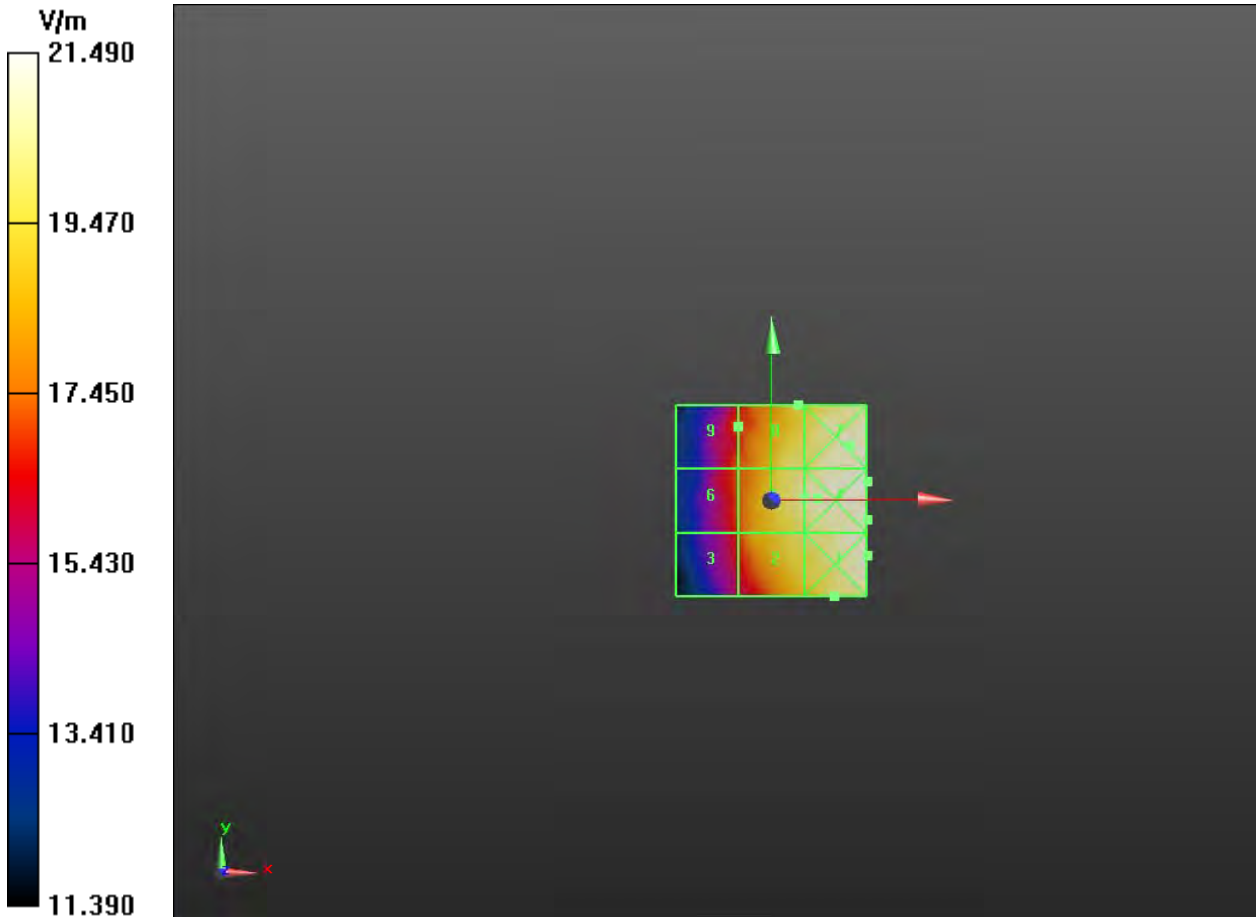



**Plot 2 HAC RF E-Field CDMA BC0 Middle**

Date: 5/30/2018

Communication System: UID 10295-AAB, HAC CDMA (0); Frequency: 836.52 MHz; Duty Cycle: 1:15.8489

Ambient Temperature: 22.3 °C

Phantom section: RF Section

DASY5 Configuration:

Sensor-Surface: 0mm (Fix Surface)

Probe: EF3DV3 – SN4048; ConvF(1, 1, 1); Calibrated: 1/8/2018

Electronics: DAE4 Sn1291; Calibrated: 10/31/2017

Phantom: HAC Test Arch with AMCC; Type: SD HAC P01 BA;

Measurement SW: DASY52, Version 52.8 (8); SEMCAD X Version 14.6.10 (7331)

**Coolpad 3310A CDMA BC0 HAC RF E-Field 2011 Device E-Field measurement (E-field scan for ANSI C63.19-2007 & -2011 compliance)/E Scan - ER3D: 15 mm from Probe Center to the Device Middle/Hearing Aid Compatibility Test (101x101x1):** Interpolated grid: dx=0.5000 mm, dy=0.5000 mm

Device Reference Point: 0, 0, -6.3 mm

Reference Value = 18.34 V/m; Power Drift = -0.06 dB

Applied MIF = 3.26 dB

RF audio interference level = 25.99 dBV/m

**Emission category: M4**

MIF scaled E-field

Grid 1 <b>M4</b> 26.64 dBV/m	Grid 2 <b>M4</b> 25.7 dBV/m	Grid 3 <b>M4</b> 24.17 dBV/m
Grid 4 <b>M4</b> 26.97 dBV/m	Grid 5 <b>M4</b> 25.99 dBV/m	Grid 6 <b>M4</b> 24.47 dBV/m
Grid 7 <b>M4</b> 26.75 dBV/m	Grid 8 <b>M4</b> 25.84 dBV/m	Grid 9 <b>M4</b> 24.32 dBV/m

**Cursor:**

Total = 26.97 dBV/m

E Category: M4

Location: 20.5, 4.5, 7.7 mm

Maximum value of Total (interpolated) = 22.32 V/m

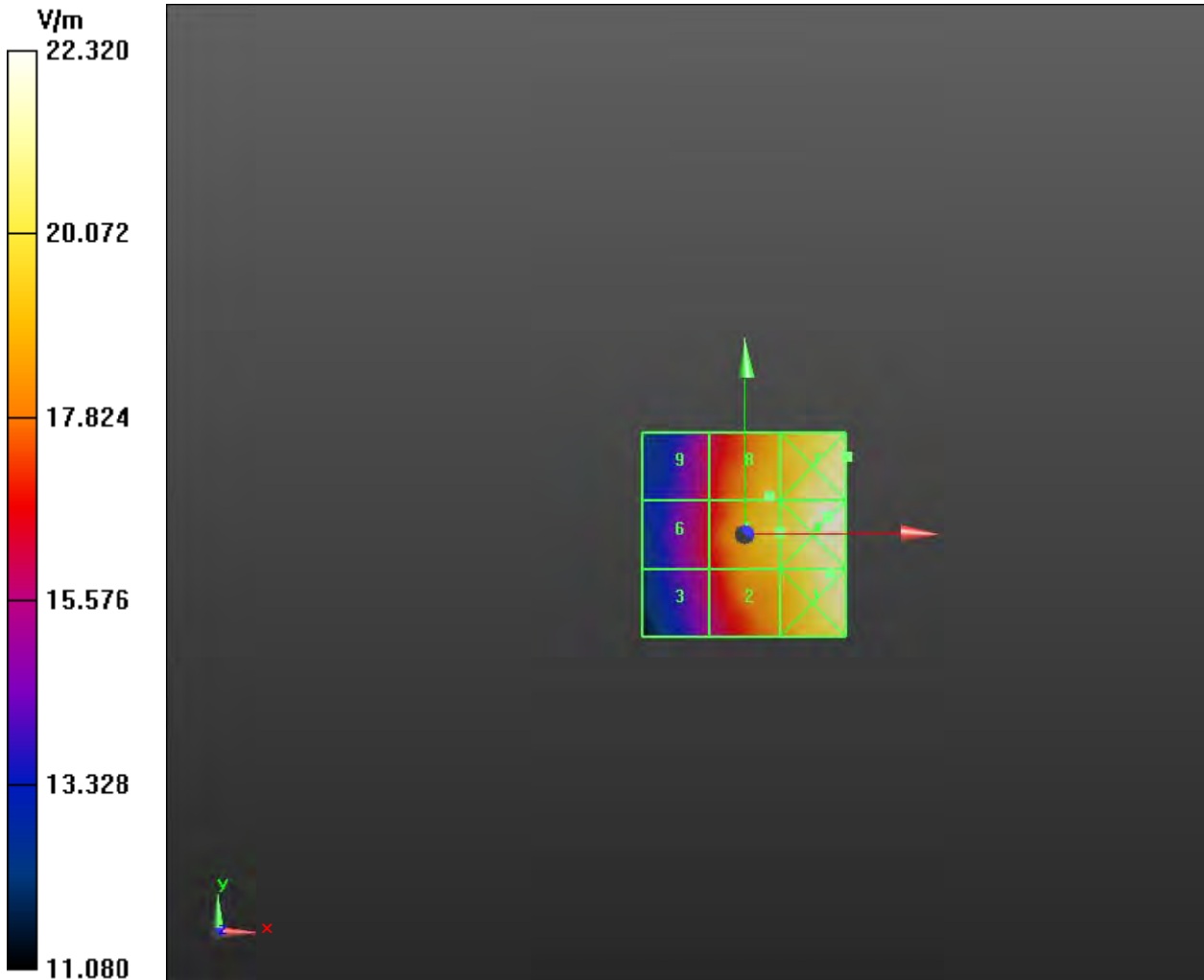

**Plot 3 HAC RF E-Field CDMA BC0 Low**

Date: 5/30/2018

Communication System: UID 10295-AAB, HAC CDMA (0); Frequency: 824.7 MHz; Duty Cycle: 1:15.8489

Ambient Temperature: 22.3 °C

Phantom section: RF Section

DASY5 Configuration:

Sensor-Surface: 0mm (Fix Surface)

Probe: EF3DV3 – SN4048; ConvF(1, 1, 1); Calibrated: 1/8/2018

Electronics: DAE4 Sn1291; Calibrated: 10/31/2017

Phantom: HAC Test Arch with AMCC; Type: SD HAC P01 BA;

Measurement SW: DASY52, Version 52.8 (8); SEMCAD X Version 14.6.10 (7331)

**Coolpad 3310A CDMA BC0 HAC RF E-Field 2011 Device E-Field measurement (E-field scan for ANSI C63.19-2007 & -2011 compliance)/E Scan - ER3D: 15 mm from Probe Center to the Device Low/Hearing Aid Compatibility Test (101x101x1):** Interpolated grid: dx=0.5000 mm, dy=0.5000 mm

Device Reference Point: 0, 0, -6.3 mm

Reference Value = 16.85 V/m; Power Drift = -0.02 dB

Applied MIF = 3.26 dB

RF audio interference level = 25.62 dBV/m

**Emission category: M4**

MIF scaled E-field

Grid 1 M4 26.03 dBV/m	Grid 2 M4 25.41 dBV/m	Grid 3 M4 23.84 dBV/m
Grid 4 M4 26.14 dBV/m	Grid 5 M4 25.62 dBV/m	Grid 6 M4 24.13 dBV/m
Grid 7 M4 26.15 dBV/m	Grid 8 M4 25.39 dBV/m	Grid 9 M4 24.03 dBV/m

**Cursor:**

Total = 26.15 dBV/m

E Category: M4

Location: 21, 9.5, 7.7 mm

Maximum value of Total (interpolated) = 20.30 V/m

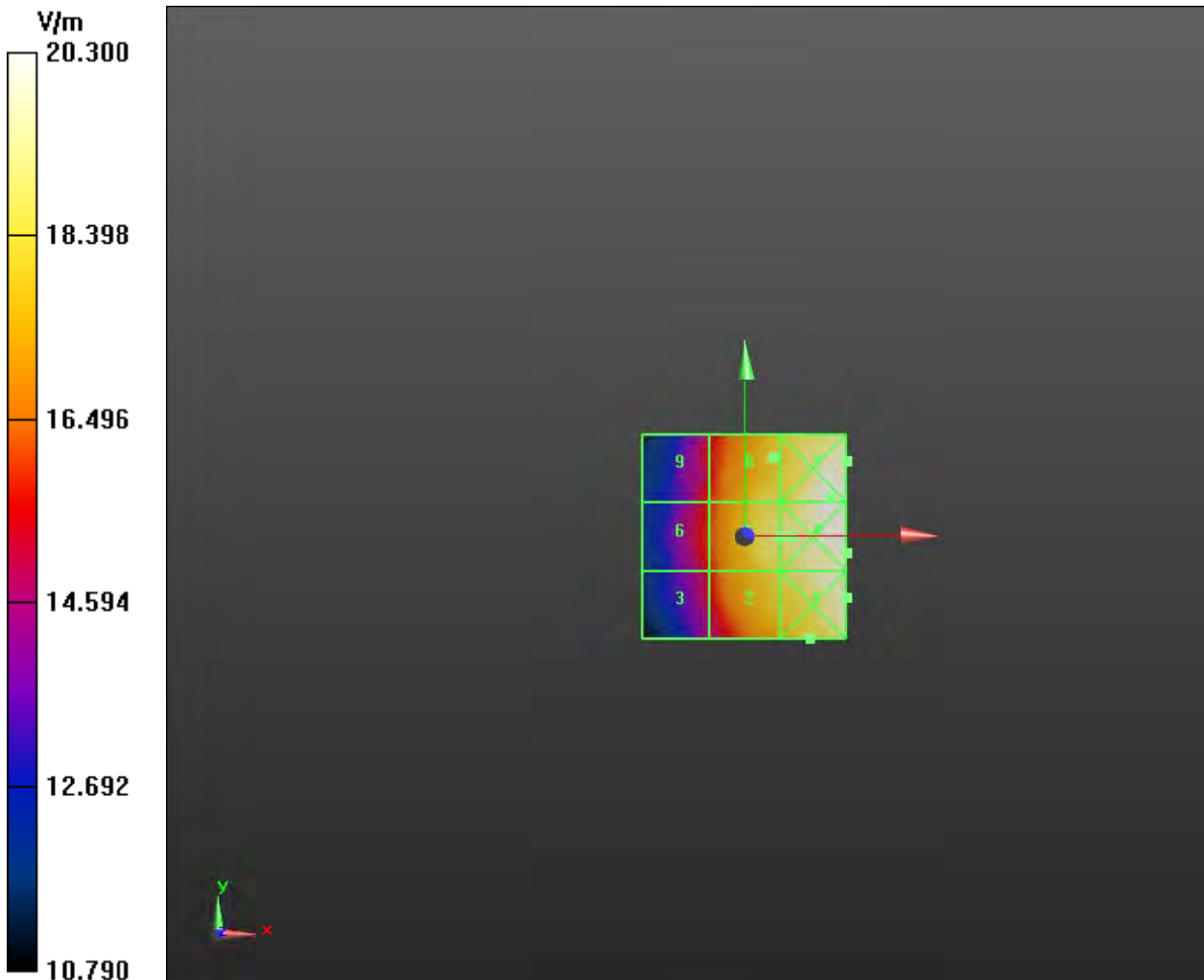



**Plot 4 HAC RF E-Field CDMA BC1 High**

Date: 5/30/2018

Communication System: UID 10295-AAB, HAC CDMA (0); Frequency: 1908.75 MHz;Duty Cycle: 1:15.8489

Ambient Temperature:22.3 °C Phantom section: RF Section

DASY5 Configuration:

Sensor-Surface: 0mm (Fix Surface)

Probe: EF3DV3 – SN4048; ConvF(1, 1, 1); Calibrated: 1/8/2018

Electronics: DAE4 Sn1291; Calibrated: 10/31/2017

Phantom: HAC Test Arch with AMCC; Type: SD HAC P01 BA;

Measurement SW: DASY52, Version 52.8 (8); SEMCAD X Version 14.6.10 (7331)

**Coolpad 3310A CDMA BC1 HAC RF E-Field 2011 Device E-Field measurement (E-field scan for ANSI C63.19-2007 & -2011 compliance)/E Scan - ER3D: 15 mm from Probe Center to the Device High/Hearing Aid Compatibility Test (101x101x1):** Interpolated grid: dx=0.5000 mm, dy=0.5000 mm

Device Reference Point: 0, 0, -6.3 mm

Reference Value = 18.28 V/m; Power Drift = -0.05 dB

Applied MIF = 3.26 dB

RF audio interference level = 26.40 dBV/m

**Emission category: M4**

MIF scaled E-field

Grid 1 M4 26.78 dBV/m	Grid 2 M4 26.12 dBV/m	Grid 3 M4 24.71 dBV/m
Grid 4 M4 26.92 dBV/m	Grid 5 M4 26.4 dBV/m	Grid 6 M4 24.91 dBV/m
Grid 7 M4 26.86 dBV/m	Grid 8 M4 26.26 dBV/m	Grid 9 M4 24.7 dBV/m

**Cursor:**

Total = 26.92 dBV/m

E Category: M4

Location: 25, 4, 7.7 mm

Maximum value of Total (interpolated) = 22.17 V/m

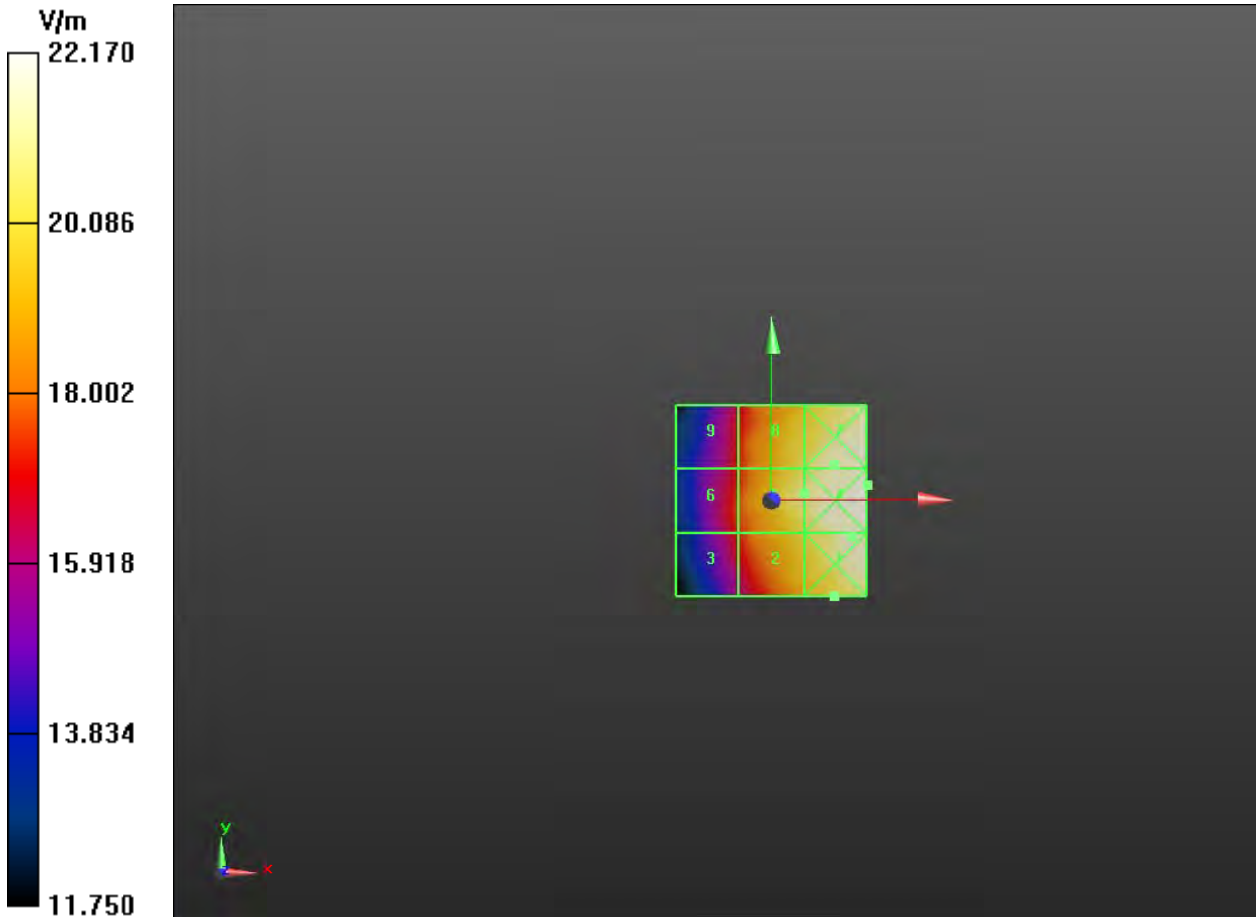



**Plot 5 HAC RF E-Field CDMA BC1 Middle**

Date: 5/30/2018

Communication System: UID 10295-AAB, HAC CDMA (0); Frequency: 1880 MHz;Duty Cycle: 1:15.8489

Ambient Temperature:22.3 °C

Phantom section: RF Section

DASY5 Configuration:

Sensor-Surface: 0mm (Fix Surface)

Probe: EF3DV3 – SN4048; ConvF(1, 1, 1); Calibrated: 1/8/2018

Electronics: DAE4 Sn1291; Calibrated: 10/31/2017

Phantom: HAC Test Arch with AMCC; Type: SD HAC P01 BA;

Measurement SW: DASY52, Version 52.8 (8); SEMCAD X Version 14.6.10 (7331)

**Coolpad 3310A CDMA BC1 HAC RF E-Field 2011 Device E-Field measurement (E-field scan for ANSI C63.19-2007 & -2011 compliance)/E Scan - ER3D: 15 mm from Probe Center to the Device Middle/Hearing Aid Compatibility Test (101x101x1):** Interpolated grid: dx=0.5000 mm, dy=0.5000 mm

Device Reference Point: 0, 0, -6.3 mm

Reference Value = 25.06 V/m; Power Drift = -0.03 dB

Applied MIF = 3.26 dB

RF audio interference level = 26.60 dBV/m

**Emission category: M4**

MIF scaled E-field

Grid 1 <b>M3</b> 33.56 dBV/m	Grid 2 <b>M4</b> 26.42 dBV/m	Grid 3 <b>M4</b> 24.73 dBV/m
Grid 4 <b>M4</b> 27.01 dBV/m	Grid 5 <b>M4</b> 26.6 dBV/m	Grid 6 <b>M4</b> 24.98 dBV/m
Grid 7 <b>M4</b> 26.95 dBV/m	Grid 8 <b>M4</b> 26.5 dBV/m	Grid 9 <b>M4</b> 24.91 dBV/m

**Cursor:**

Total = 33.56 dBV/m

E Category: M3

Location: 25, -25, 7.7 mm

Maximum value of Total (interpolated) = 47.62 V/m

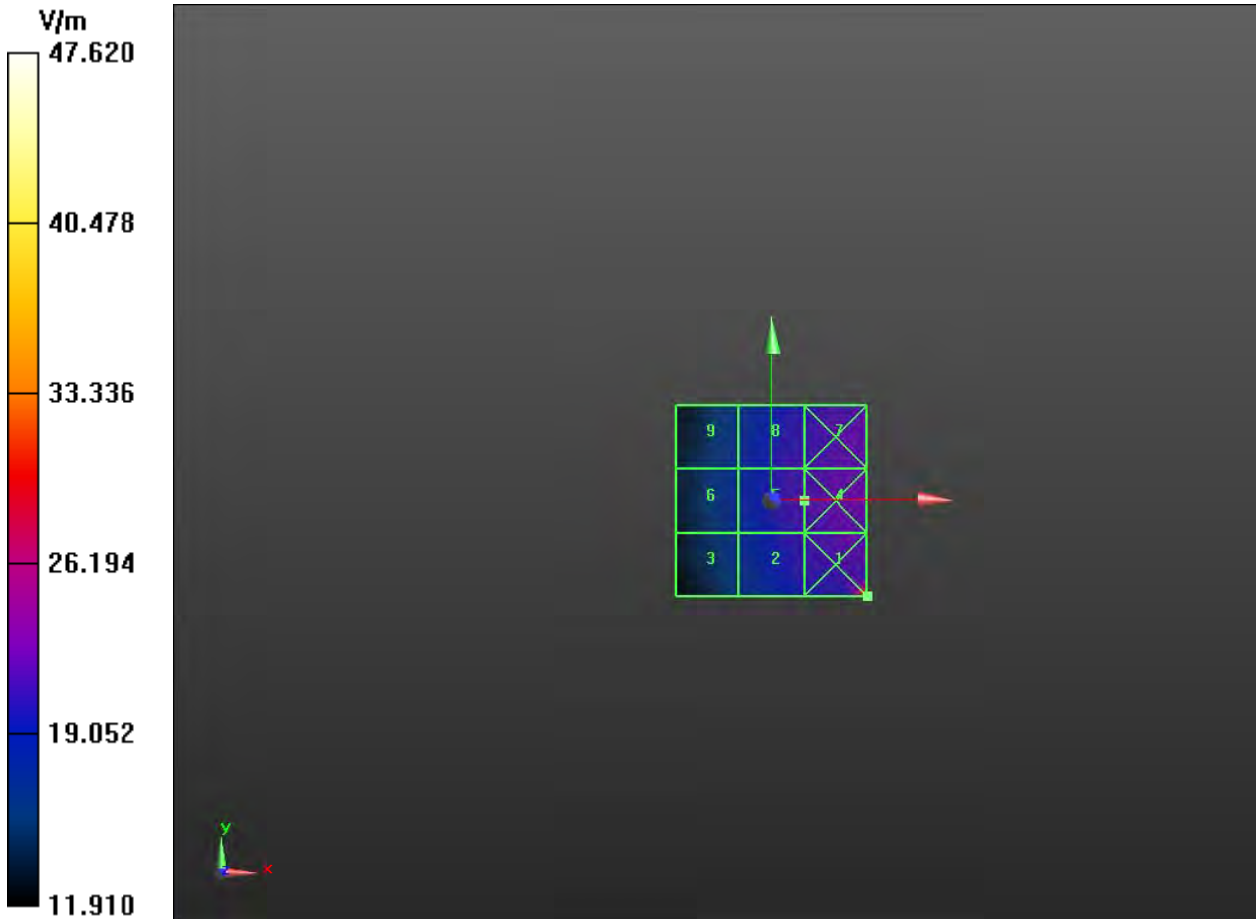





**Plot 6 HAC RF E-Field CDMA BC1 Low**

Date: 5/30/2018

Communication System: UID 10295-AAB, HAC CDMA (0); Frequency: 1851.25 MHz; Duty Cycle: 1:15.8489

Ambient Temperature: 22.3 °C Phantom section: RF Section

DASY5 Configuration:

Sensor-Surface: 0mm (Fix Surface)

Probe: EF3DV3 – SN4048; ConvF(1, 1, 1); Calibrated: 1/8/2018

Electronics: DAE4 Sn1291; Calibrated: 10/31/2017

Phantom: HAC Test Arch with AMCC; Type: SD HAC P01 BA;

Measurement SW: DASY52, Version 52.8 (8); SEMCAD X Version 14.6.10 (7331)

**Coolpad 3310A CDMA BC1 HAC RF E-Field 2011 Device E-Field measurement (E-field scan for ANSI C63.19-2007 & -2011 compliance)/E Scan - ER3D: 15 mm from Probe Center to the Device Low/Hearing Aid Compatibility Test (101x101x1): Interpolated grid: dx=0.5000 mm, dy=0.5000 mm**

Device Reference Point: 0, 0, -6.3 mm

Reference Value = 17.51 V/m; Power Drift = -0.09 dB

Applied MIF = 3.26 dB

RF audio interference level = 27.27 dBV/m

**Emission category: M4**

MIF scaled E-field

Grid 1 M4 26.68 dBV/m	Grid 2 M4 26.96 dBV/m	Grid 3 M4 15.74 dBV/m
Grid 4 M4 26.8 dBV/m	Grid 5 M4 27.27 dBV/m	Grid 6 M4 15.97 dBV/m
Grid 7 M4 26.75 dBV/m	Grid 8 M4 27.01 dBV/m	Grid 9 M4 16.27 dBV/m

**Cursor:**

Total = 27.27 dBV/m

E Category: M4

Location: 1.5, 5, 7.7 mm

Maximum value of Total (interpolated) = 23.10 V/m

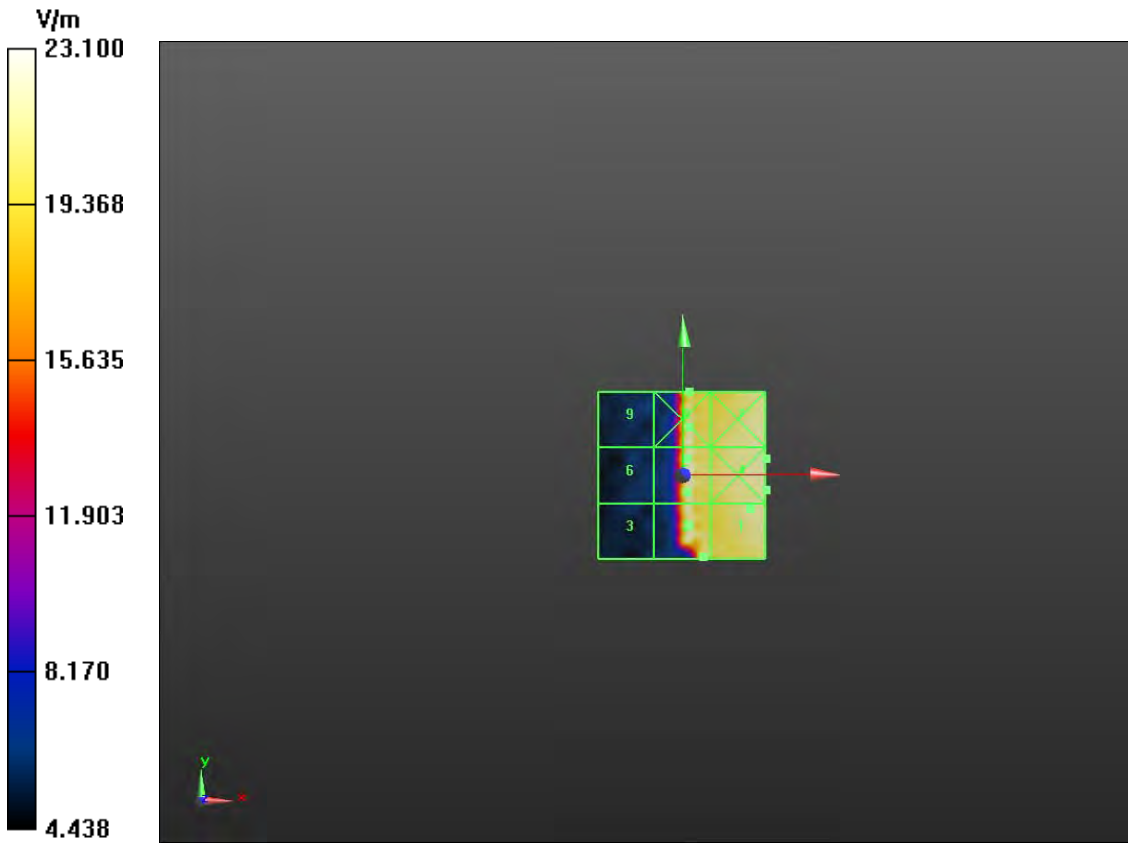



**Plot 7 HAC RF E-Field CDMA BC10 High**

Date: 5/30/2018

Communication System: UID 10295-AAB, HAC CDMA (0) (0); Frequency: 845.52 MHz;Duty Cycle: 1:15.8489

Ambient Temperature:22.3 °C

Phantom section: RF Section

DASY5 Configuration:

Sensor-Surface: 0mm (Fix Surface)

Probe: EF3DV3 – SN4048; ConvF(1, 1, 1); Calibrated: 1/8/2018

Electronics: DAE4 Sn1291; Calibrated: 10/31/2017

Phantom: HAC Test Arch with AMCC; Type: SD HAC P01 BA;

Measurement SW: DASY52, Version 52.8 (8); SEMCAD X Version 14.6.10 (7331)

**Coolpad 3310A CDMA BC10 HAC RF E-Field 2011 Device E-Field measurement (E-field scan for ANSI C63.19-2007 & -2011 compliance)/E Scan - ER3D: 15 mm from Probe Center to the Device High/Hearing Aid Compatibility Test (101x101x1):** Interpolated grid: dx=0.5000 mm, dy=0.5000 mm

Device Reference Point: 0, 0, -6.3 mm

Reference Value = 6.467 V/m; Power Drift = -0.05 dB

Applied MIF = 3.26 dB

RF audio interference level = 27.43 dBV/m

**Emission category: M4**

MIF scaled E-field

<b>Grid 1 M4</b> <b>27.35 dBV/m</b>	<b>Grid 2 M4</b> <b>27.43 dBV/m</b>	<b>Grid 3 M4</b> <b>15.35 dBV/m</b>
<b>Grid 4 M4</b> <b>27.54 dBV/m</b>	<b>Grid 5 M4</b> <b>27.43 dBV/m</b>	<b>Grid 6 M4</b> <b>16.39 dBV/m</b>
<b>Grid 7 M4</b> <b>27.65 dBV/m</b>	<b>Grid 8 M4</b> <b>27.19 dBV/m</b>	<b>Grid 9 M4</b> <b>16.72 dBV/m</b>

**Cursor:**

Total = 27.65 dBV/m

E Category: M4

Location: 12.5, 25, 7.7 mm

Maximum value of Total (interpolated) = 24.13 V/m

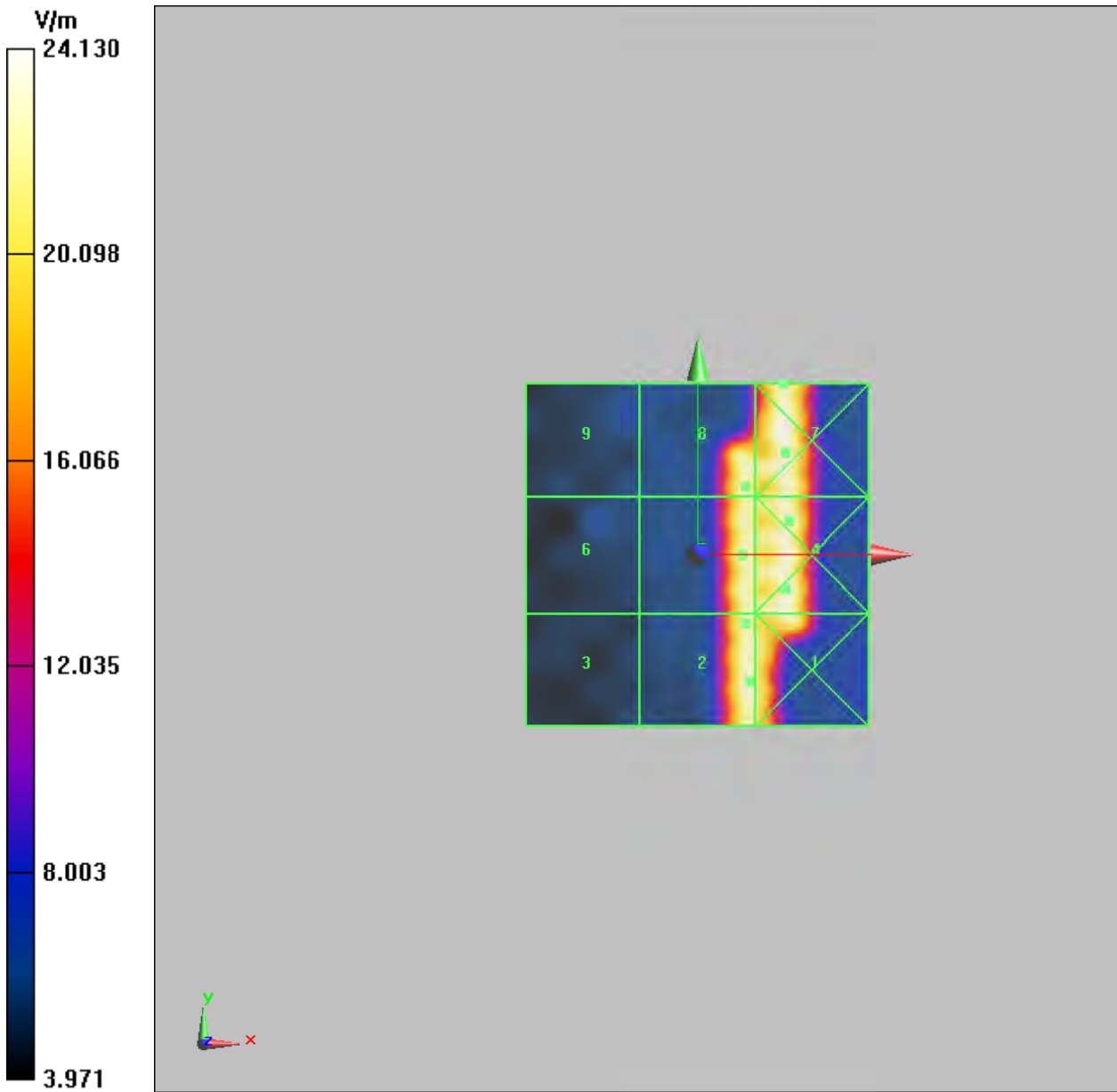

**Plot 8 HAC RF E-Field CDMA BC10 Middle**

Date: 5/30/2018

Communication System: UID 10295-AAB, HAC CDMA (0) (0); Frequency: 842.4 MHz; Duty Cycle: 1:15.8489

Ambient Temperature: 22.3 °C Phantom section: RF Section

DASY5 Configuration:

Sensor-Surface: 0mm (Fix Surface)

Probe: EF3DV3 – SN4048; ConvF(1, 1, 1); Calibrated: 1/8/2018

Electronics: DAE4 Sn1291; Calibrated: 10/31/2017

Phantom: HAC Test Arch with AMCC; Type: SD HAC P01 BA;

Measurement SW: DASY52, Version 52.8 (8); SEMCAD X Version 14.6.10 (7331)

**Coolpad 3310A CDMA BC10 HAC RF E-Field 2011 Device E-Field measurement (E-field scan for ANSI C63.19-2007 & -2011 compliance)/E Scan - ER3D: 15 mm from Probe Center to the Device Middle/Hearing Aid Compatibility Test (101x101x1):** Interpolated grid: dx=0.5000 mm, dy=0.5000 mm

Device Reference Point: 0, 0, -6.3 mm

Reference Value = 23.71 V/m; Power Drift = -0.12 dB

Applied MIF = 3.26 dB

RF audio interference level = 28.09 dBV/m

**Emission category: M4**

MIF scaled E-field

Grid 1 M4 33.85 dBV/m	Grid 2 M4 27.17 dBV/m	Grid 3 M4 24.75 dBV/m
Grid 4 M4 34.25 dBV/m	Grid 5 M4 28.09 dBV/m	Grid 6 M4 24.92 dBV/m
Grid 7 M4 36.35 dBV/m	Grid 8 M4 21.92 dBV/m	Grid 9 M4 24.78 dBV/m

**Cursor:**

Total = 36.35 dBV/m

E Category: M4

Location: 25, 18.5, 7.7 mm

Maximum value of Total (interpolated) = 65.67 V/m

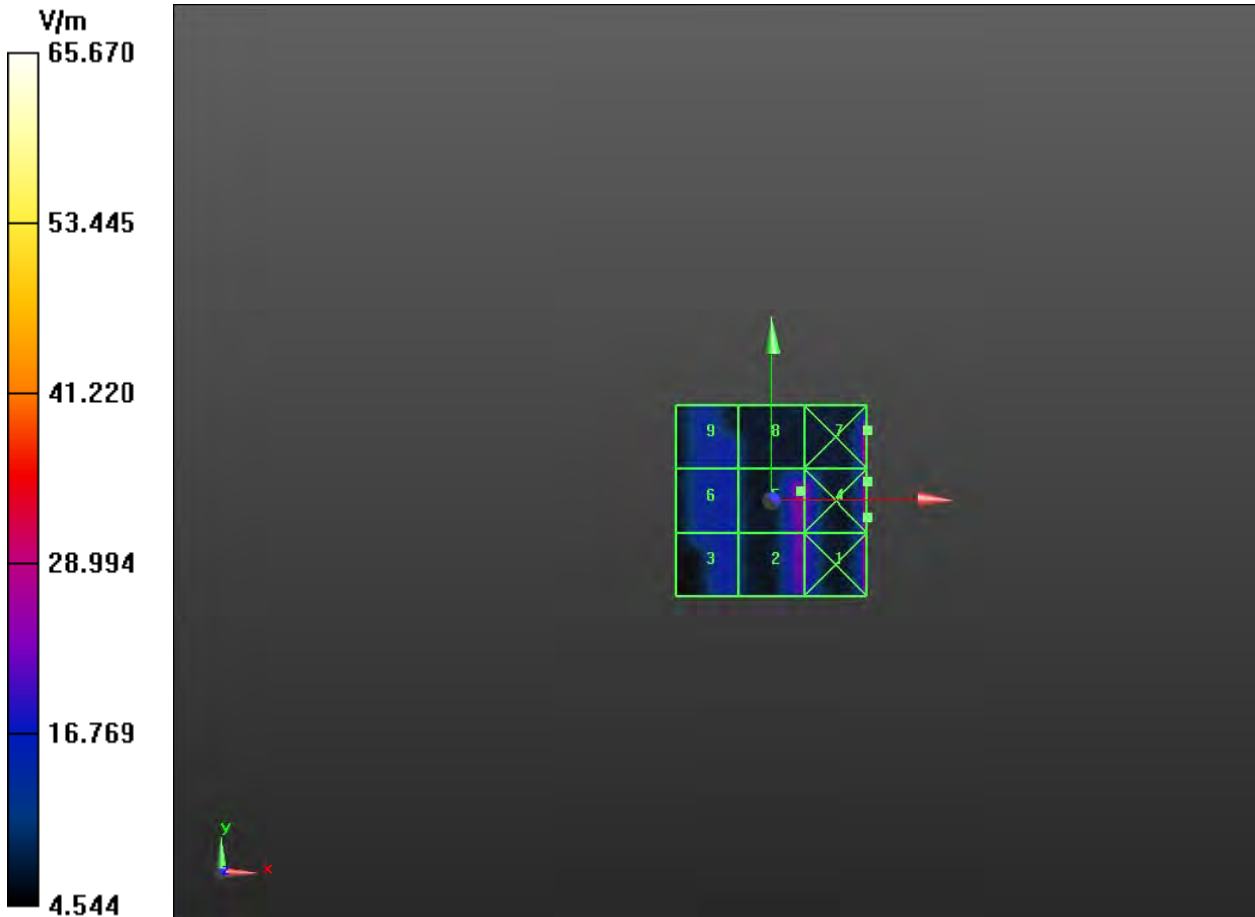



**Plot 9 HAC RF E-Field CDMA BC10 Low**

Date: 5/30/2018

Communication System: UID 10295-AAB, HAC CDMA (0) (0); Frequency: 839.28 MHz;Duty Cycle: 1:15.8489

Ambient Temperature:22.3 °C Phantom section: RF Section

DASY5 Configuration:

Sensor-Surface: 0mm (Fix Surface)

Probe: EF3DV3 – SN4048; ConvF(1, 1, 1); Calibrated: 1/8/2018

Electronics: DAE4 Sn1291; Calibrated: 10/31/2017

Phantom: HAC Test Arch with AMCC; Type: SD HAC P01 BA;

Measurement SW: DASY52, Version 52.8 (8); SEMCAD X Version 14.6.10 (7331)

**Coolpad 3310A CDMA BC10 HAC RF E-Field 2011 Device E-Field measurement (E-field scan for ANSI C63.19-2007 & -2011 compliance)/E Scan - ER3D: 15 mm from Probe Center to the Device Low/Hearing Aid Compatibility Test (101x101x1):** Interpolated grid: dx=0.5000 mm, dy=0.5000 mm

Device Reference Point: 0, 0, -6.3 mm

Reference Value = 18.12 V/m; Power Drift = -0.14 dB

Applied MIF = 3.26 dB

RF audio interference level = 23.54 dBV/m

**Emission category: M4**

MIF scaled E-field

<b>Grid 1 M4</b> <b>34.18 dBV/m</b>	<b>Grid 2 M4</b> <b>18.25 dBV/m</b>	<b>Grid 3 M4</b> <b>18.53 dBV/m</b>
<b>Grid 4 M4</b> <b>34.58 dBV/m</b>	<b>Grid 5 M4</b> <b>23.54 dBV/m</b>	<b>Grid 6 M4</b> <b>18.41 dBV/m</b>
<b>Grid 7 M4</b> <b>34.44 dBV/m</b>	<b>Grid 8 M4</b> <b>23.54 dBV/m</b>	<b>Grid 9 M4</b> <b>18.54 dBV/m</b>

**Cursor:**

Total = 34.58 dBV/m

E Category: M4

Location: 25, 5, 7.7 mm

Maximum value of Total (interpolated) = 53.57 V/m

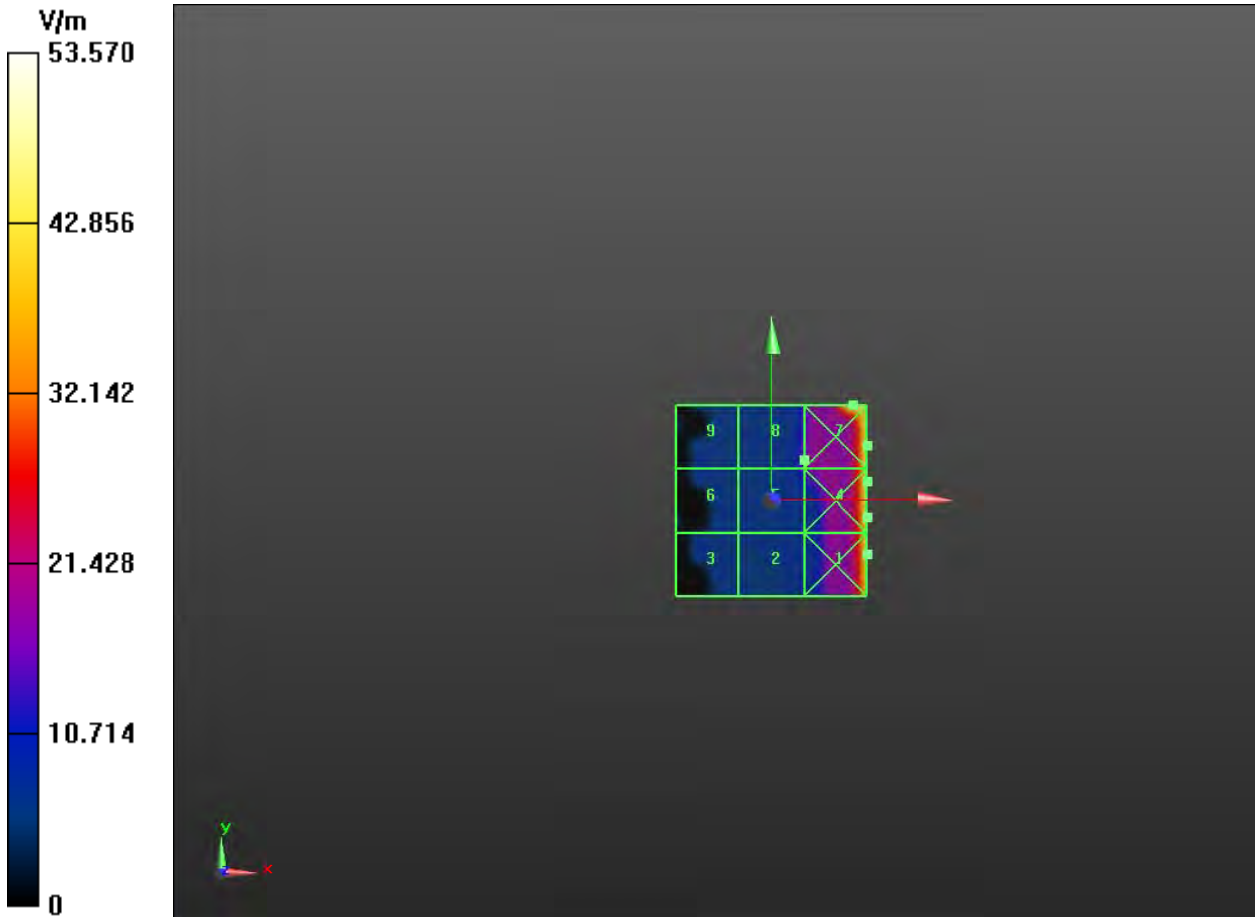



**Plot 10 HAC RF E-Field LTE Band 41 High**

Date: 5/30/2018

Communication System: UID 10647-AAC, LTE-TDD (SC-FDMA, 1 RB, 20 MHz, QPSK); Frequency: 2680 MHz; Duty Cycle: 1:8.87156

Ambient Temperature: 22.3 °C Phantom section: RF Section

DASY5 Configuration:

Sensor-Surface: 0mm (Fix Surface)

Probe: EF3DV3 – SN4048; ConvF(1, 1, 1); Calibrated: 1/8/2018

Electronics: DAE4 Sn1291; Calibrated: 10/31/2017

Phantom: HAC Test Arch with AMCC; Type: SD HAC P01 BA;

Measurement SW: DASY52, Version 52.8 (8); SEMCAD X Version 14.6.10 (7331)

**Coolpad 3310A LTE B41 1RB HAC RF E-Field/E Scan - ER3D: 15 mm from Probe Center to the Device High/Hearing Aid Compatibility Test (101x101x1):** Interpolated grid: dx=0.5000 mm, dy=0.5000 mm

Device Reference Point: 0, 0, -6.3 mm

Reference Value = 10.80 V/m; Power Drift = -0.05 dB

Applied MIF = -1.44 dB

RF audio interference level = 23.36 dBV/m

**Emission category: M4**

MIF scaled E-field

Grid 1 M4 27.48 dBV/m	Grid 2 M4 27.49 dBV/m	Grid 3 M4 25.82 dBV/m
Grid 4 M4 22.53 dBV/m	Grid 5 M4 23.36 dBV/m	Grid 6 M4 23.23 dBV/m
Grid 7 M4 23.36 dBV/m	Grid 8 M4 22.22 dBV/m	Grid 9 M4 23.29 dBV/m

Category	Limits for E-Field Emissions < 960MHz	Limits for E-Field Emissions > 960MHz
M1	50 dBV/m - 55 dB V/m	40 dBV/m - 45 dB V/m
M2	45 dBV/m - 50 dB V/m	35 dBV/m - 40 dB V/m
M3	40 dBV/m - 45 dB V/m	30 dBV/m - 35 dB V/m
M4	<40 dBV/m	<30 dBV/m

**Cursor:**

Total = 27.49 dBV/m

E Category: M4

Location: 7.5, -25, 7.7 mm

Maximum value of Total (interpolated) = 23.69 V/m

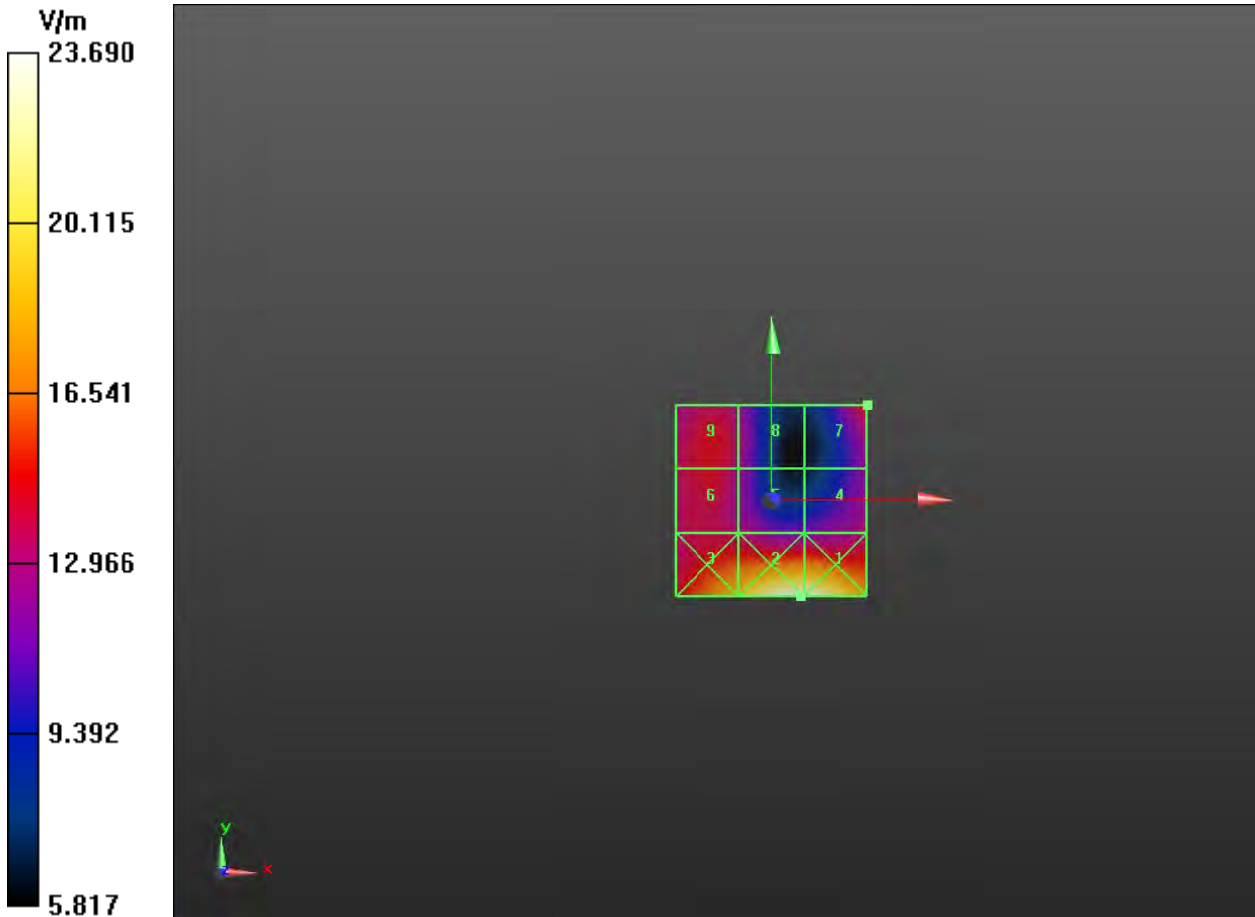



**Plot 11 HAC RF E-Field LTE Band 41 Middle**

Date: 5/30/2018

Communication System: UID 10647-AAC, LTE-TDD (SC-FDMA, 1 RB, 20 MHz, QPSK); Frequency: 2593 MHz; Duty Cycle: 1:8.87156

Ambient Temperature: 22.3 °C Phantom section: RF Section

DASY5 Configuration:

Sensor-Surface: 0mm (Fix Surface)

Probe: EF3DV3 – SN4048; ConvF(1, 1, 1); Calibrated: 1/8/2018

Electronics: DAE4 Sn1291; Calibrated: 10/31/2017

Phantom: HAC Test Arch with AMCC; Type: SD HAC P01 BA;

Measurement SW: DASY52, Version 52.8 (8); SEMCAD X Version 14.6.10 (7331)

**Coolpad 3310A LTE B41 1RB HAC RF E-Field/E Scan - ER3D: 15 mm from Probe Center to the Device Mid/Hearing Aid Compatibility Test (101x101x1):** Interpolated grid: dx=0.5000 mm, dy=0.5000 mm

Device Reference Point: 0, 0, -6.3 mm

Reference Value = 13.15 V/m; Power Drift = 0.17 dB

Applied MIF = -1.44 dB

RF audio interference level = 25.37 dBV/m

**Emission category: M4**

MIF scaled E-field

Grid 1 M4 28.59 dBV/m	Grid 2 M4 28.32 dBV/m	Grid 3 M4 25.71 dBV/m
Grid 4 M4 25.07 dBV/m	Grid 5 M4 25.37 dBV/m	Grid 6 M4 25.33 dBV/m
Grid 7 M4 25.24 dBV/m	Grid 8 M4 24.2 dBV/m	Grid 9 M4 25.37 dBV/m

**Cursor:**

Total = 28.59 dBV/m

E Category: M4

Location: 15, -25, 7.7 mm

Maximum value of Total (interpolated) = 26.87 V/m

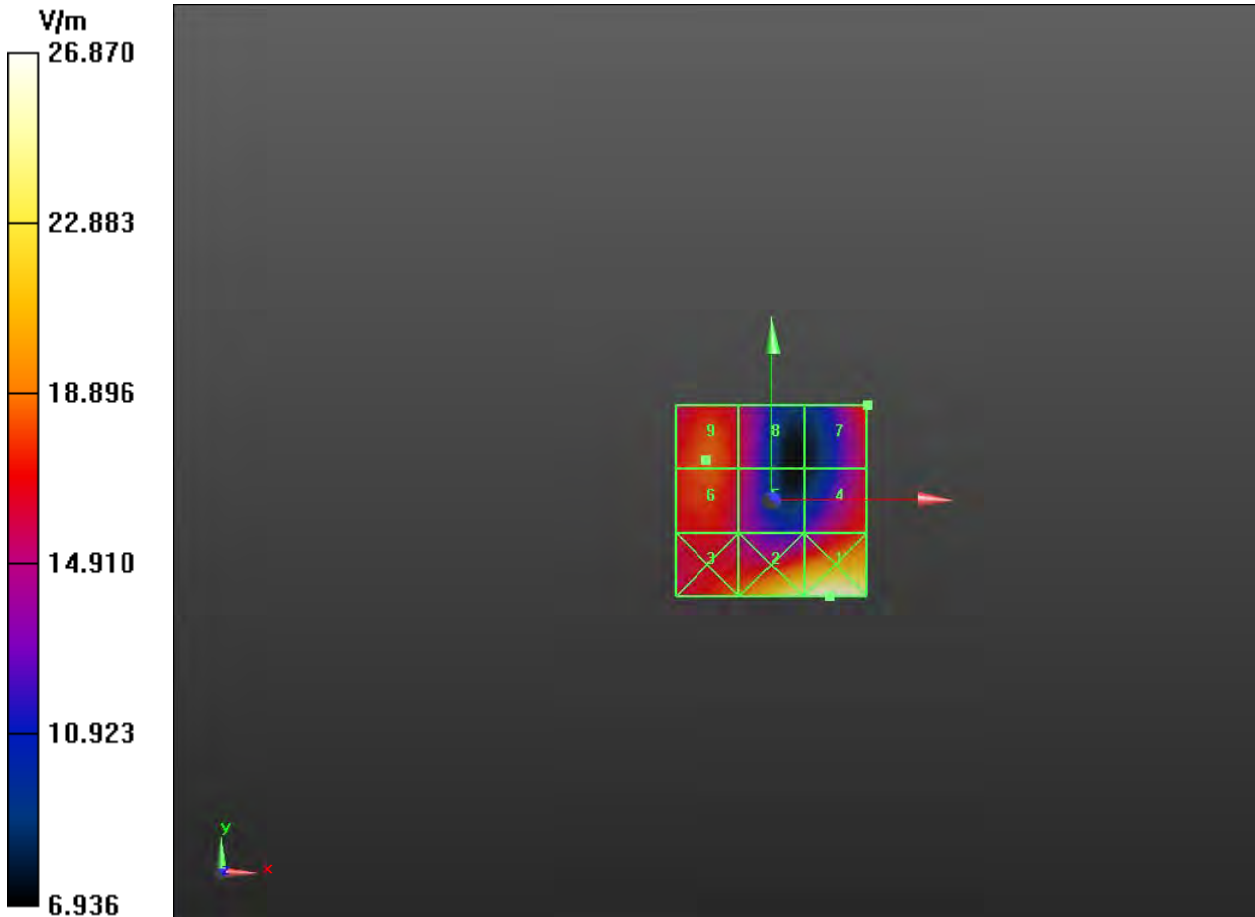



**Plot 12 HAC RF E-Field LTE Band 41 Low**

Date: 5/30/2018

Communication System: UID 10647-AAC, LTE-TDD (SC-FDMA, 1 RB, 20 MHz, QPSK); Frequency: 2506 MHz;Duty Cycle: 1:8.87156

Ambient Temperature:22.3 °C Phantom section: RF Section

DASY5 Configuration:

Sensor-Surface: 4mm (Mechanical Surface Detection)

Sensor-Surface: 0mm (Fix Surface)

Probe: EF3DV3 – SN4048; ConvF(1, 1, 1); Calibrated: 1/8/2018

Electronics: DAE4 Sn1291; Calibrated: 10/31/2017

Phantom: HAC Test Arch with AMCC; Type: SD HAC P01 BA;

Measurement SW: DASY52, Version 52.8 (8); SEMCAD X Version 14.6.10 (7331)

**Coolpad 3310A LTE B41 1RB HAC RF E-Field/E Scan - ER3D: 15 mm from Probe Center to the Device Low/Hearing Aid Compatibility Test (101x101x1):** Interpolated grid: dx=0.5000 mm, dy=0.5000 mm

Device Reference Point: 0, 0, -6.3 mm

Reference Value = 12.49 V/m; Power Drift = 0.02 dB

Applied MIF = -1.44 dB

RF audio interference level = 25.82 dBV/m

**Emission category: M4**

MIF scaled E-field

Grid 1 M4 28.59 dBV/m	Grid 2 M4 27.56 dBV/m	Grid 3 M4 25.21 dBV/m
Grid 4 M4 25.67 dBV/m	Grid 5 M4 25.82 dBV/m	Grid 6 M4 25.82 dBV/m
Grid 7 M4 24.57 dBV/m	Grid 8 M4 24.49 dBV/m	Grid 9 M4 25.81 dBV/m

**Cursor:**

Total = 28.59 dBV/m

E Category: M4

Location: 20, -25, 7.7 mm

Maximum value of Total (interpolated) = 26.88 V/m

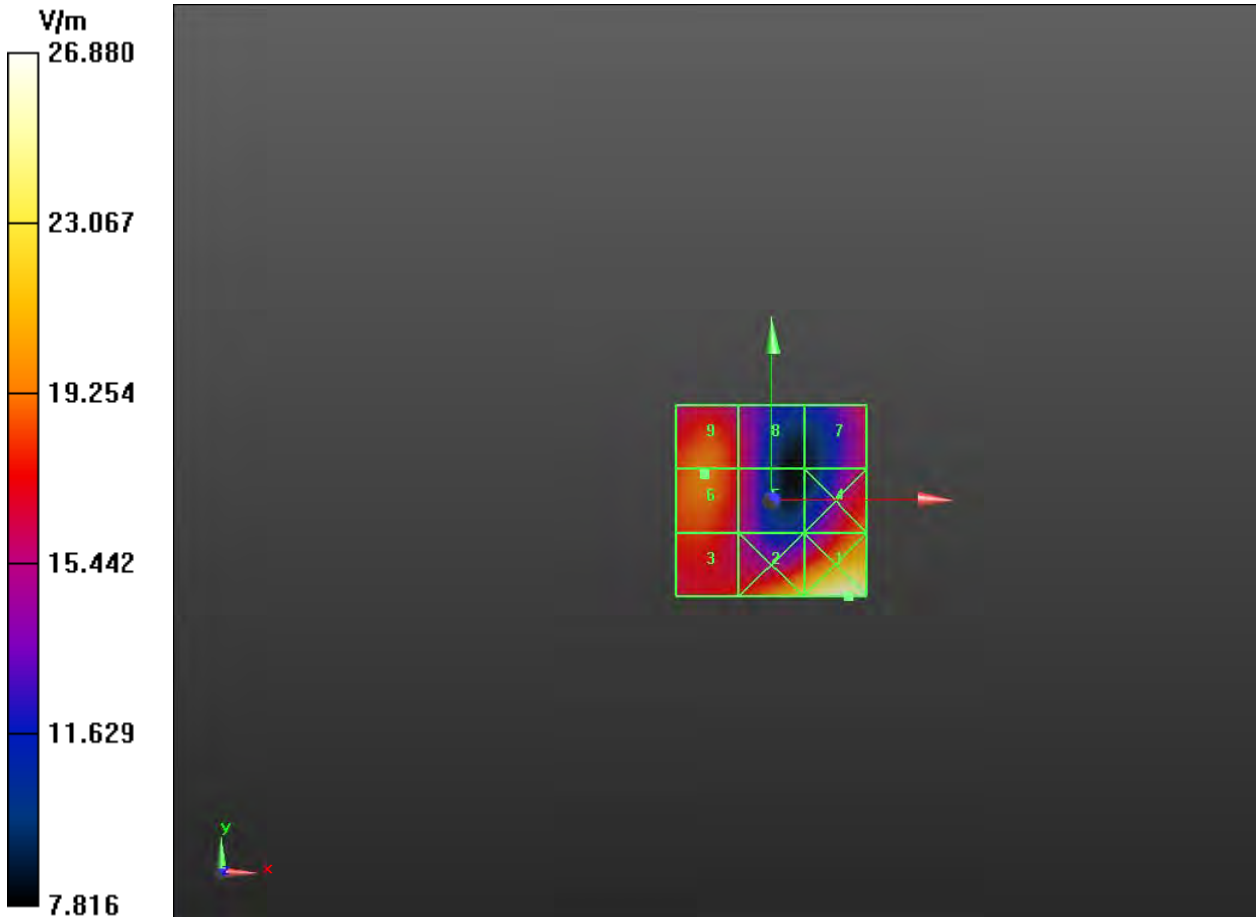



## ANNEX C: E-Probe Calibration Certificate

Calibration Laboratory of  
Schmid & Partner  
Engineering AG  
Zeughausstrasse 43, 8004 Zurich, Switzerland



S Schweizerischer Kalibrierdienst  
C Service suisse d'étalonnage  
S Servizio svizzero di taratura  
S Swiss Calibration Service

Accredited by the Swiss Accreditation Service (SAS)  
The Swiss Accreditation Service is one of the signatories to the EA  
Multilateral Agreement for the recognition of calibration certificates

Accreditation No.: SCS 0108

Client **TA-SH (Auden)**

Certificate No: **EF3-4048\_Jan18**

### CALIBRATION CERTIFICATE

Object **EF3DV3 - SN:4048**

Calibration procedure(s) **QA CAL-02.v8, QA CAL-25.v6  
Calibration procedure for E-field probes optimized for close near field  
evaluations in air**

Calibration date: **January 9, 2018**

This calibration certificate documents the traceability to national standards, which realize the physical units of measurements (SI).  
The measurements and the uncertainties with confidence probability are given on the following pages and are part of the certificate.

All calibrations have been conducted in the closed laboratory facility, environment temperature (22 ± 3)°C and humidity < 70%.

Calibration Equipment used (M&TE critical for calibration)

Primary Standards	ID	Cal Date (Certificate No.)	Scheduled Calibration
Power meter NRP	SN: 104778	04-Apr-17 (No. 217-02521/02522)	Apr-18
Power sensor NRP-Z91	SN: 103244	04-Apr-17 (No. 217-02521)	Apr-18
Power sensor NRP-Z91	SN: 103245	04-Apr-17 (No. 217-02525)	Apr-18
Reference 20 dB Attenuator	SN: S5277 (20x)	07-Apr-17 (No. 217-02528)	Apr-18
Reference Probe ER3DV6	SN: 2328	10-Oct-17 (No. ER3-2328_Oct17)	Oct-18
DAE4	SN: 789	2-Aug-17 (No. DAE4-789_Aug17)	Aug-18
Secondary Standards	ID	Check Date (in house)	Scheduled Check
Power meter E4419B	SN: GB41293874	06-Apr-16 (in house check Jun-16)	In house check: Jun-18
Power sensor E4412A	SN: MY41498087	06-Apr-16 (in house check Jun-16)	In house check: Jun-18
Power sensor E4412A	SN: 000110210	06-Apr-16 (in house check Jun-16)	In house check: Jun-18
RF generator HP 8648C	SN: US3642U01700	04-Aug-99 (in house check Jun-16)	In house check: Jun-18
Network Analyzer HP 8753E	SN: US37390585	18-Oct-01 (in house check Oct-17)	In house check: Oct-18

	Name	Function	Signature
Calibrated by:	Jeton Kastrali	Laboratory Technician	
Approved by:	Katja Pokovic	Technical Manager	

Issued: January 9, 2018

This calibration certificate shall not be reproduced except in full without written approval of the laboratory.

**Calibration Laboratory of  
Schmid & Partner  
Engineering AG**  
Zeughausstrasse 43, 8004 Zurich, Switzerland



**SCS** Schweizerischer Kalibrierdienst  
Service suisse d'étalonnage  
Servizio svizzero di taratura  
Swiss Calibration Service

Accredited by the Swiss Accreditation Service (SAS)  
The Swiss Accreditation Service is one of the signatories to the EA  
Multilateral Agreement for the recognition of calibration certificates

Accreditation No.: **SCS 0108**

**Glossary:**

NORM <sub>x,y,z</sub>	sensitivity in free space
DCP	diode compression point
CF	crest factor (1/duty_cycle) of the RF signal
A, B, C, D	modulation dependent linearization parameters
Polarization $\varphi$	$\varphi$ rotation around probe axis
Polarization $\vartheta$	$\vartheta$ rotation around an axis that is in the plane normal to probe axis (at measurement center), i.e., $\vartheta = 0$ is normal to probe axis
Connector Angle	information used in DASY system to align probe sensor X to the robot coordinate system

**Calibration is Performed According to the Following Standards:**

- a) IEEE Std 1309-2005, "IEEE Standard for calibration of electromagnetic field sensors and probes, excluding antennas, from 9 kHz to 40 GHz", December 2005
- b) CTIA Test Plan for Hearing Aid Compatibility, Rev 3.0, November 2013

**Methods Applied and Interpretation of Parameters:**

- **NORM<sub>x,y,z</sub>**: Assessed for E-field polarization  $\vartheta = 0$  for XY sensors and  $\vartheta = 90$  for Z sensor ( $f \leq 900$  MHz in TEM-cell;  $f > 1800$  MHz: R22 waveguide).
- **NORM(f)<sub>x,y,z</sub>** = NORM<sub>x,y,z</sub> \* frequency\_response (see Frequency Response Chart).
- **DCP<sub>x,y,z</sub>**: DCP are numerical linearization parameters assessed based on the data of power sweep with CW signal (no uncertainty required). DCP does not depend on frequency nor media.
- **PAR**: PAR is the Peak to Average Ratio that is not calibrated but determined based on the signal characteristics
- **A<sub>x,y,z</sub>; B<sub>x,y,z</sub>; C<sub>x,y,z</sub>; D<sub>x,y,z</sub>; VR<sub>x,y,z</sub>**: A, B, C, D are numerical linearization parameters assessed based on the data of power sweep for specific modulation signal. The parameters do not depend on frequency nor media. VR is the maximum calibration range expressed in RMS voltage across the diode.
- **Spherical isotropy (3D deviation from isotropy)**: in a locally homogeneous field realized using an open waveguide setup.
- **Sensor Offset**: The sensor offset corresponds to the offset of virtual measurement center from the probe tip (on probe axis). No tolerance required.
- **Connector Angle**: The angle is assessed using the information gained by determining the NORM<sub>x</sub> (no uncertainty required).





EF3DV3 – SN:4048

January 9, 2018

# Probe EF3DV3

## SN:4048

Manufactured: May 24, 2016  
Calibrated: January 9, 2018

Calibrated for DASY/EASY Systems  
(Note: non-compatible with DASY2 system!)



EF3DV3 – SN:4048

January 9, 2018

**DASY/EASY - Parameters of Probe: EF3DV3 - SN:4048****Basic Calibration Parameters**

	Sensor X	Sensor Y	Sensor Z	Unc (k=2)
Norm ( $\mu\text{V}/(\text{V}/\text{m})^2$ )	0.59	0.69	1.22	$\pm 10.1\%$
DCP (mV) <sup>a</sup>	97.3	98.1	94.2	

**Modulation Calibration Parameters**

UID	Communication System Name		A dB	B dB $\sqrt{\mu\text{V}}$	C	D dB	VR mV	Unc <sup>E</sup> (k=2)
0	CW	X	0.0	0.0	1.0	0.00	154.4	$\pm 3.3\%$
		Y	0.0	0.0	1.0		124.9	
		Z	0.0	0.0	1.0		121.5	

Note: For details on UID parameters see Appendix.

**Sensor Model Parameters**

	C1 fF	C2 fF	$\alpha$ V <sup>-1</sup>	T1 ms.V <sup>-2</sup>	T2 ms.V <sup>-1</sup>	T3 ms	T4 V <sup>-2</sup>	T5 V <sup>-1</sup>	T6
X	41.24	271.0	36.63	9.157	0.288	4.968	0.915	0.128	1.003
Y	64.32	421.9	36.55	15.84	1.083	4.999	1.244	0.387	1.006
Z	50.74	343.7	38.64	12.31	0.521	5.064	0.000	0.171	1.014

The reported uncertainty of measurement is stated as the standard uncertainty of measurement multiplied by the coverage factor k=2, which for a normal distribution corresponds to a coverage probability of approximately 95%.

<sup>a</sup> Numerical linearization parameter: uncertainty not required.<sup>E</sup> Uncertainty is determined using the max. deviation from linear response applying rectangular distribution and is expressed for the square of the field value.

EF3DV3 – SN:4048

January 9, 2018

### Frequency Response of E-Field (TEM-Cell:ifi110 EXX, Waveguide: R22)

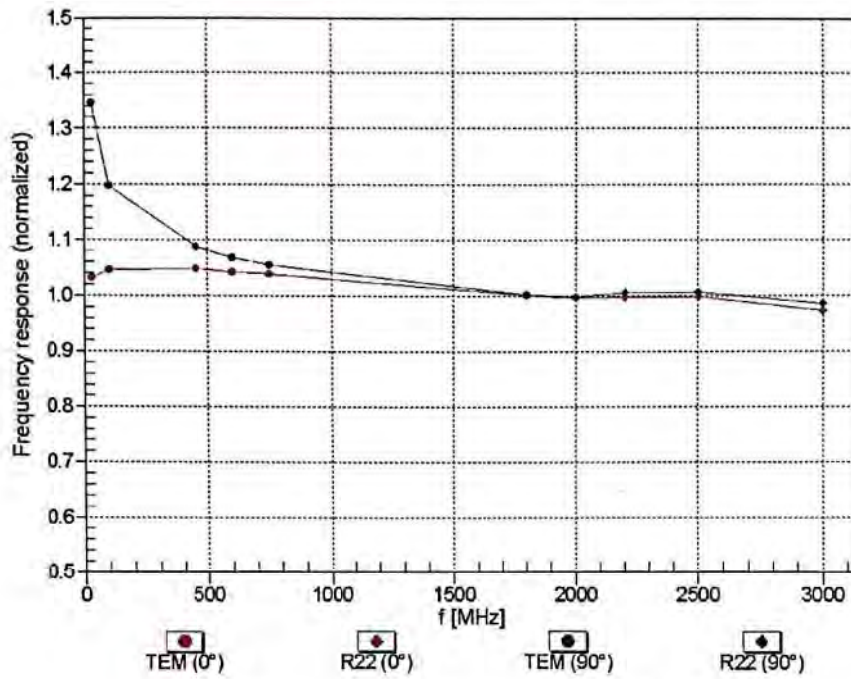

Uncertainty of Frequency Response of E-field:  $\pm 6.3\%$  (k=2)

EF3DV3 – SN:4048

January 9, 2018

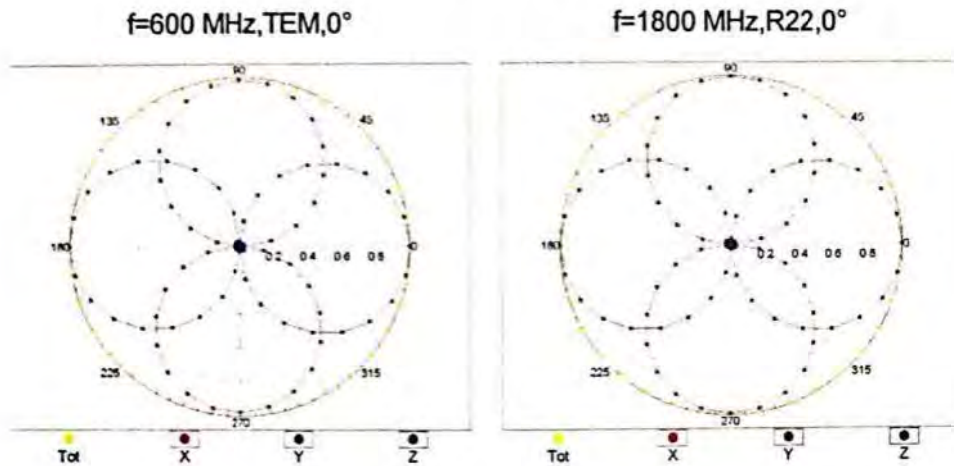
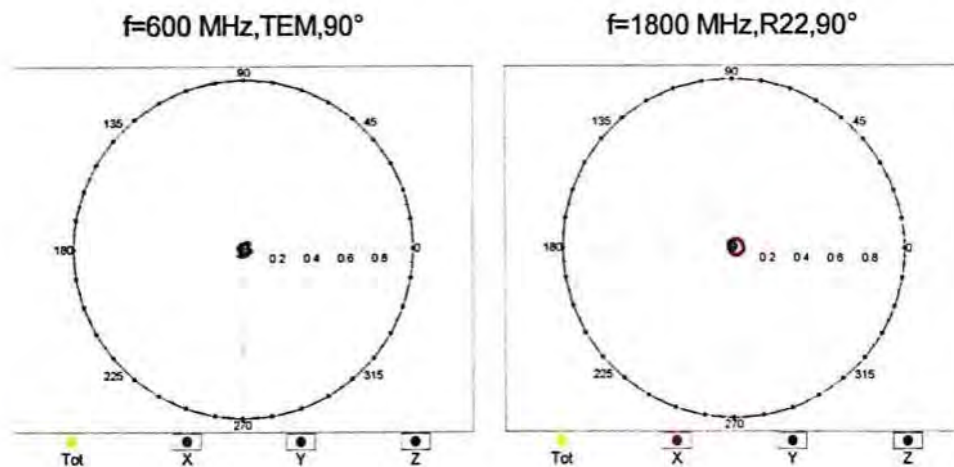
**Receiving Pattern ( $\phi$ ),  $\theta = 0^\circ$** **Receiving Pattern ( $\phi$ ),  $\theta = 90^\circ$** 

EF3DV3 – SN:4048

January 9, 2018

### Receiving Pattern ( $\phi$ ), $\vartheta = 0^\circ$

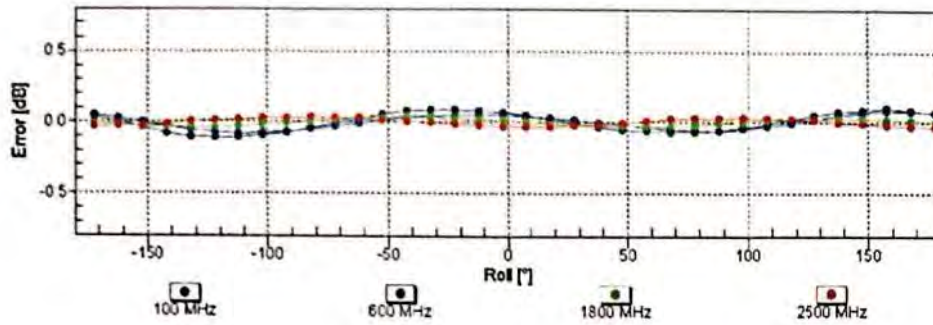
Uncertainty of Axial Isotropy Assessment:  $\pm 0.5\%$  (k=2)

### Receiving Pattern ( $\phi$ ), $\vartheta = 90^\circ$

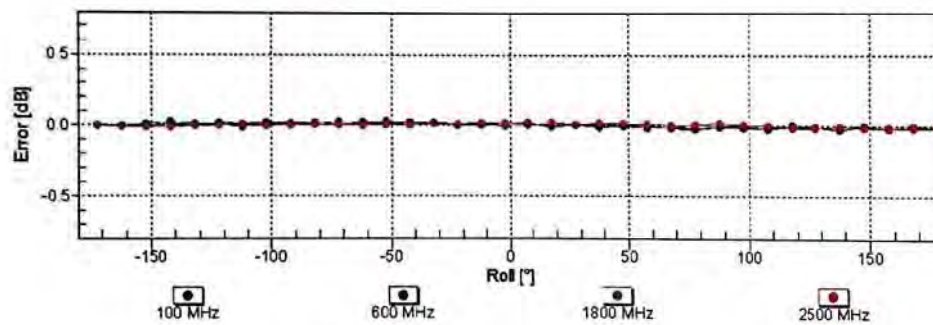
Uncertainty of Axial Isotropy Assessment:  $\pm 0.5\%$  (k=2)

EF3DV3 – SN:4048

January 9, 2018

### Dynamic Range f(E-field) (TEM cell , f = 900 MHz)

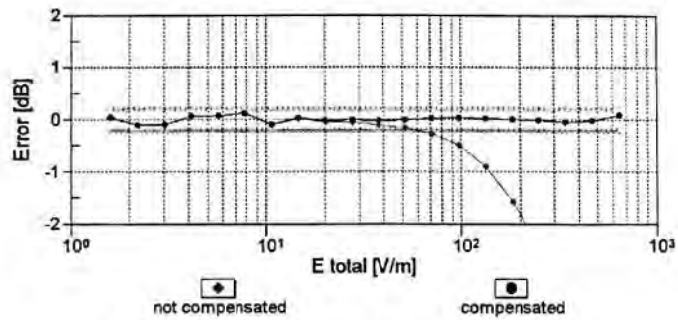
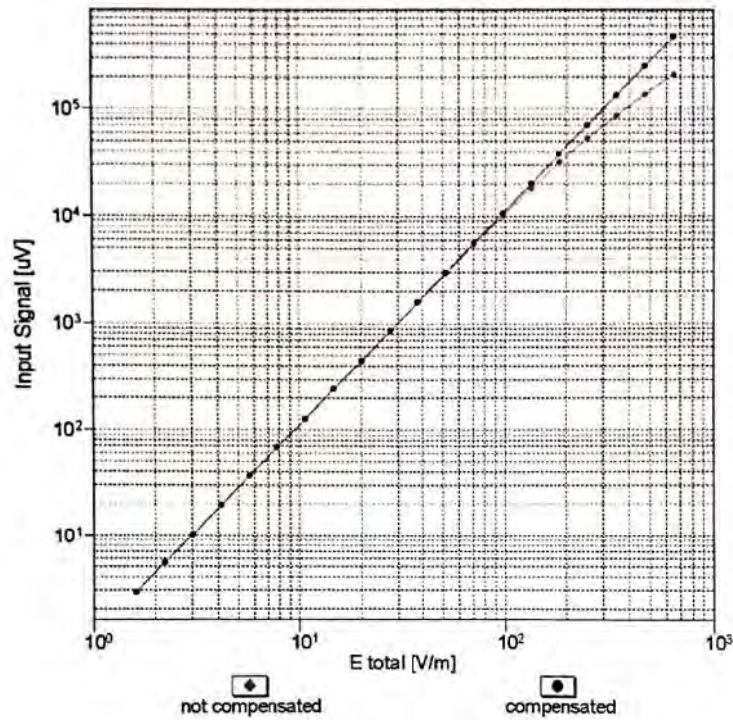

Uncertainty of Linearity Assessment: ± 0.6% (k=2)

EF3DV3 – SN:4048

January 9, 2018

### Deviation from Isotropy in Air Error ( $\phi$ , $\theta$ ), $f = 900$ MHz

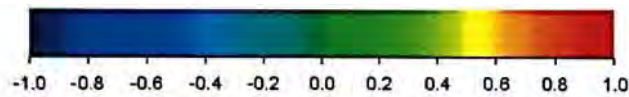
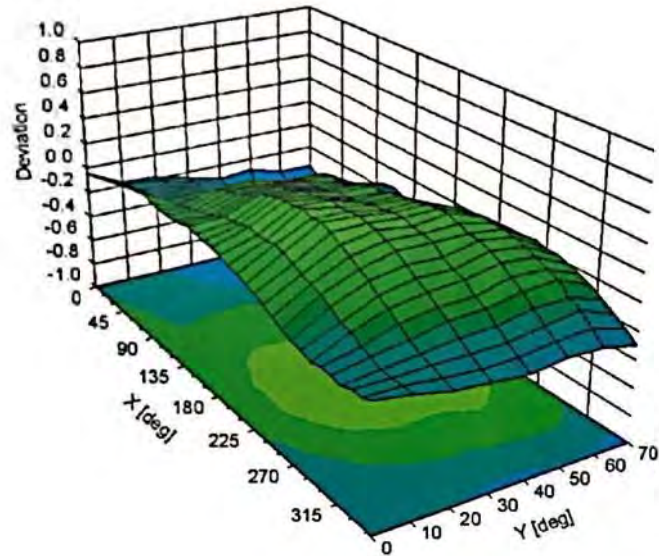

Uncertainty of Spherical Isotropy Assessment:  $\pm 2.6\%$  ( $k=2$ )



EF3DV3 – SN:4048

January 9, 2018

**DASY/EASY - Parameters of Probe: EF3DV3 - SN:4048****Other Probe Parameters**

Sensor Arrangement	Rectangular
Connector Angle (°)	-22.1
Mechanical Surface Detection Mode	enabled
Optical Surface Detection Mode	disabled
Probe Overall Length	337 mm
Probe Body Diameter	12 mm
Tip Length	25 mm
Tip Diameter	4 mm
Probe Tip to Sensor X Calibration Point	1.5 mm
Probe Tip to Sensor Y Calibration Point	1.5 mm
Probe Tip to Sensor Z Calibration Point	1.5 mm



EF3DV3 – SN:4048

January 9, 2018

**Appendix (Additional assessments outside the scope of SCS 0108)****Calibration Parameters for 3-4 GHz**

	Sensor X	Sensor Y	Sensor Z	Unc (k=2)
Norm ( $\mu\text{V}/(\text{V}/\text{m})^2$ ) <sup>x</sup>	0.68	0.76	1.35	$\pm 10.1\%$
DCP (mV) <sup>b</sup>	97.3	98.1	94.2	

**Calibration Parameters for 5-6 GHz**

	Sensor X	Sensor Y	Sensor Z	Unc (k=2)
Norm ( $\mu\text{V}/(\text{V}/\text{m})^2$ ) <sup>x</sup>	0.80	0.85	1.60	$\pm 10.1\%$
DCP (mV) <sup>b</sup>	97.3	98.1	94.2	

The reported uncertainty of measurement is stated as the standard uncertainty of measurement multiplied by the coverage factor  $k=2$ , which for a normal distribution corresponds to a coverage probability of approximately 95%.

<sup>b</sup> Numerical linearization parameter; uncertainty not required.

<sup>x</sup> Calibration procedure for frequencies above 3 GHz is pending accreditation.



EF3DV3 – SN:4048

January 9, 2018

**Appendix: Modulation Calibration Parameters**

UID	Communication System Name		A dB	B dB $\mu$ V	C	D dB	VR mV	Max Unc <sup>E</sup> (k=2)
0	CW	X	0.00	0.00	1.00	0.00	154.4	$\pm 3.3\%$
		Y	0.00	0.00	1.00		124.9	
		Z	0.00	0.00	1.00		121.5	
10010- CAA	SAR Validation (Square, 100ms, 10ms)	X	1.95	63.63	7.91	10.00	20.0	$\pm 9.6\%$
		Y	3.38	68.47	11.78		20.0	
		Z	2.85	67.62	10.80		20.0	
10011- CAB	UMTS-FDD (WCDMA)	X	1.46	75.01	19.11	0.00	150.0	$\pm 9.6\%$
		Y	1.54	74.99	19.39		150.0	
		Z	1.56	76.02	19.66		150.0	
10012- CAB	IEEE 802.11b WiFi 2.4 GHz (DSSS, 1 Mbps)	X	1.21	65.78	16.65	0.41	150.0	$\pm 9.6\%$
		Y	1.28	66.30	17.06		150.0	
		Z	1.24	66.29	17.26		150.0	
10013- CAB	IEEE 802.11g WiFi 2.4 GHz (DSSS-OFDM, 6 Mbps)	X	4.83	67.57	17.55	1.46	150.0	$\pm 9.6\%$
		Y	5.12	67.51	17.69		150.0	
		Z	5.01	67.69	17.95		150.0	
10021- DAC	GSM-FDD (TDMA, GMSK)	X	3.64	69.75	11.65	9.39	50.0	$\pm 9.6\%$
		Y	12.25	85.40	19.64		50.0	
		Z	100.00	112.14	26.34		50.0	
10023- DAC	GPRS-FDD (TDMA, GMSK, TN 0)	X	3.54	69.24	11.45	9.57	50.0	$\pm 9.6\%$
		Y	10.82	83.64	19.10		50.0	
		Z	100.00	111.91	26.29		50.0	
10024- DAC	GPRS-FDD (TDMA, GMSK, TN 0-1)	X	2.25	67.72	9.88	6.56	60.0	$\pm 9.6\%$
		Y	42.99	100.11	22.39		60.0	
		Z	100.00	110.82	24.67		60.0	
10025- DAC	EDGE-FDD (TDMA, 8PSK, TN 0)	X	21.10	123.53	48.27	12.57	50.0	$\pm 9.6\%$
		Y	46.15	141.84	52.96		50.0	
		Z	100.00	176.82	64.98		50.0	
10026- DAC	EDGE-FDD (TDMA, 8PSK, TN 0-1)	X	14.06	105.86	37.81	9.56	60.0	$\pm 9.6\%$
		Y	25.09	114.90	39.86		60.0	
		Z	29.92	126.18	45.09		60.0	
10027- DAC	GPRS-FDD (TDMA, GMSK, TN 0-1-2)	X	1.77	67.62	9.31	4.80	80.0	$\pm 9.6\%$
		Y	100.00	108.33	23.32		80.0	
		Z	100.00	110.81	23.90		80.0	
10028- DAC	GPRS-FDD (TDMA, GMSK, TN 0-1-2-3)	X	1.82	69.37	9.56	3.55	100.0	$\pm 9.6\%$
		Y	100.00	108.05	22.55		100.0	
		Z	100.00	111.44	23.49		100.0	
10029- DAC	EDGE-FDD (TDMA, 8PSK, TN 0-1-2)	X	6.25	85.88	29.41	7.80	80.0	$\pm 9.6\%$
		Y	11.87	96.86	32.85		80.0	
		Z	9.75	96.52	34.16		80.0	
10030- CAA	IEEE 802.15.1 Bluetooth (GFSK, DH1)	X	1.59	65.71	8.54	5.30	70.0	$\pm 9.6\%$
		Y	71.57	104.46	22.66		70.0	
		Z	100.00	109.30	23.53		70.0	
10031- CAA	IEEE 802.15.1 Bluetooth (GFSK, DH3)	X	0.34	61.07	4.85	1.88	100.0	$\pm 9.6\%$
		Y	100.00	106.27	20.57		100.0	
		Z	100.00	105.38	19.64		100.0	



EF3DV3 – SN:4048

January 9, 2018

10032-CAA	IEEE 802.15.1 Bluetooth (GFSK, DH5)	X	0.17	60.00	3.82	1.17	100.0	± 9.6 %
		Y	100.00	108.86	20.78		100.0	
		Z	100.00	101.01	17.04		100.0	
10033-CAA	IEEE 802.15.1 Bluetooth (PI/4-DQPSK, DH1)	X	5.85	81.94	19.13	5.30	70.0	± 9.6 %
		Y	16.24	97.75	26.14		70.0	
		Z	100.00	129.31	34.53		70.0	
10034-CAA	IEEE 802.15.1 Bluetooth (PI/4-DQPSK, DH3)	X	2.38	73.93	15.23	1.88	100.0	± 9.6 %
		Y	5.44	85.72	21.66		100.0	
		Z	13.97	100.19	25.59		100.0	
10035-CAA	IEEE 802.15.1 Bluetooth (PI/4-DQPSK, DH5)	X	1.96	72.92	14.78	1.17	100.0	± 9.6 %
		Y	3.61	81.48	20.20		100.0	
		Z	5.89	89.04	22.06		100.0	
10036-CAA	IEEE 802.15.1 Bluetooth (8-DPSK, DH1)	X	7.30	85.09	20.23	5.30	70.0	± 9.6 %
		Y	22.31	102.91	27.68		70.0	
		Z	100.00	129.58	34.66		70.0	
10037-CAA	IEEE 802.15.1 Bluetooth (8-DPSK, DH3)	X	2.22	73.19	14.92	1.88	100.0	± 9.6 %
		Y	5.30	85.39	21.50		100.0	
		Z	12.32	98.49	25.09		100.0	
10038-CAA	IEEE 802.15.1 Bluetooth (8-DPSK, DH5)	X	2.03	73.67	15.22	1.17	100.0	± 9.6 %
		Y	3.80	82.56	20.69		100.0	
		Z	6.55	90.97	22.81		100.0	
10039-CAB	CDMA2000 (1xRTT, RC1)	X	3.06	79.88	17.54	0.00	150.0	± 9.6 %
		Y	3.38	81.43	20.33		150.0	
		Z	3.57	82.07	19.25		150.0	
10042-CAB	IS-54 / IS-136 FDD (TDMA/FDM, PI/4-DQPSK, Halfrate)	X	2.15	66.09	9.28	7.78	50.0	± 9.6 %
		Y	9.21	81.57	17.15		50.0	
		Z	100.00	108.47	23.88		50.0	
10044-CAA	IS-91/EIA/TIA-553 FDD (FDMA, FM)	X	10.42	145.24	6.85	0.00	150.0	± 9.6 %
		Y	0.08	125.46	16.45		150.0	
		Z	8.80	141.34	8.03		150.0	
10048-CAA	DECT (TDD, TDMA/FDM, GFSK, Full Slot, 24)	X	3.86	66.23	11.52	13.80	20.0	± 9.6 %
		Y	7.82	76.72	18.14		20.0	
		Z	17.17	87.22	20.88		20.0	
10049-CAA	DECT (TDD, TDMA/FDM, GFSK, Double Slot, 12)	X	3.77	68.59	11.37	10.79	40.0	± 9.6 %
		Y	8.13	79.06	17.80		40.0	
		Z	23.61	93.24	21.72		40.0	
10056-CAA	UMTS-TDD (TD-SCDMA, 1.28 Mcps)	X	9.88	83.82	19.78	9.03	50.0	± 9.6 %
		Y	13.32	89.54	23.76		50.0	
		Z	84.94	120.93	32.50		50.0	
10058-DAC	EDGE-FDD (TDMA, 8PSK, TN 0-1-2-3)	X	4.47	78.61	25.67	6.55	100.0	± 9.6 %
		Y	7.80	87.87	28.89		100.0	
		Z	6.16	85.69	29.22		100.0	
10059-CAB	IEEE 802.11b WiFi 2.4 GHz (DSSS, 2 Mbps)	X	1.24	67.01	17.24	0.61	110.0	± 9.6 %
		Y	1.39	68.21	17.96		110.0	
		Z	1.32	68.22	18.29		110.0	
10060-CAB	IEEE 802.11b WiFi 2.4 GHz (DSSS, 5.5 Mbps)	X	100.00	139.25	35.66	1.30	110.0	± 9.6 %
		Y	100.00	135.73	34.78		110.0	
		Z	100.00	143.71	37.93		110.0	

Certificate No: EF3-4048\_Jan18

Page 13 of 39



EF3DV3 – SN:4048

January 9, 2018

10061-CAB	IEEE 802.11b WiFi 2.4 GHz (DSSS, 11 Mbps)	X	3.54	85.96	24.06	2.04	110.0	± 9.6 %
		Y	8.58	98.04	27.87		110.0	
		Z	14.63	112.69	33.41		110.0	
10062-CAC	IEEE 802.11a/h WiFi 5 GHz (OFDM, 6 Mbps)	X	4.67	67.66	17.10	0.49	100.0	± 9.6 %
		Y	4.94	67.56	17.19		100.0	
		Z	4.82	67.66	17.36		100.0	
10063-CAC	IEEE 802.11a/h WiFi 5 GHz (OFDM, 9 Mbps)	X	4.67	67.72	17.16	0.72	100.0	± 9.6 %
		Y	4.96	67.66	17.28		100.0	
		Z	4.84	67.78	17.46		100.0	
10064-CAC	IEEE 802.11a/h WiFi 5 GHz (OFDM, 12 Mbps)	X	4.93	67.95	17.36	0.86	100.0	± 9.6 %
		Y	5.30	68.01	17.54		100.0	
		Z	5.14	68.08	17.72		100.0	
10065-CAC	IEEE 802.11a/h WiFi 5 GHz (OFDM, 18 Mbps)	X	4.78	67.77	17.40	1.21	100.0	± 9.6 %
		Y	5.15	67.90	17.62		100.0	
		Z	5.00	67.97	17.82		100.0	
10066-CAC	IEEE 802.11a/h WiFi 5 GHz (OFDM, 24 Mbps)	X	4.78	67.74	17.53	1.46	100.0	± 9.6 %
		Y	5.17	67.94	17.78		100.0	
		Z	5.01	68.02	18.01		100.0	
10067-CAC	IEEE 802.11a/h WiFi 5 GHz (OFDM, 36 Mbps)	X	5.06	67.98	17.97	2.04	100.0	± 9.6 %
		Y	5.45	68.01	18.17		100.0	
		Z	5.31	68.20	18.46		100.0	
10068-CAC	IEEE 802.11a/h WiFi 5 GHz (OFDM, 48 Mbps)	X	5.08	67.89	18.11	2.55	100.0	± 9.6 %
		Y	5.54	68.26	18.47		100.0	
		Z	5.36	68.31	18.73		100.0	
10069-CAC	IEEE 802.11a/h WiFi 5 GHz (OFDM, 54 Mbps)	X	5.16	67.95	18.32	2.67	100.0	± 9.6 %
		Y	5.62	68.19	18.64		100.0	
		Z	5.45	68.35	18.95		100.0	
10071-CAB	IEEE 802.11g WiFi 2.4 GHz (DSSS/OFDM, 9 Mbps)	X	4.91	67.60	17.80	1.99	100.0	± 9.6 %
		Y	5.22	67.61	17.98		100.0	
		Z	5.11	67.79	18.27		100.0	
10072-CAB	IEEE 802.11g WiFi 2.4 GHz (DSSS/OFDM, 12 Mbps)	X	4.86	67.85	17.97	2.30	100.0	± 9.6 %
		Y	5.23	68.03	18.22		100.0	
		Z	5.10	68.17	18.52		100.0	
10073-CAB	IEEE 802.11g WiFi 2.4 GHz (DSSS/OFDM, 18 Mbps)	X	4.91	67.98	18.25	2.83	100.0	± 9.6 %
		Y	5.29	68.20	18.53		100.0	
		Z	5.16	68.35	18.87		100.0	
10074-CAB	IEEE 802.11g WiFi 2.4 GHz (DSSS/OFDM, 24 Mbps)	X	4.89	67.85	18.36	3.30	100.0	± 9.6 %
		Y	5.26	68.11	18.68		100.0	
		Z	5.13	68.23	19.01		100.0	
10075-CAB	IEEE 802.11g WiFi 2.4 GHz (DSSS/OFDM, 36 Mbps)	X	4.90	67.90	18.61	3.82	90.0	± 9.6 %
		Y	5.34	68.43	19.09		90.0	
		Z	5.18	68.40	19.37		90.0	
10076-CAB	IEEE 802.11g WiFi 2.4 GHz (DSSS/OFDM, 48 Mbps)	X	4.93	67.73	18.75	4.15	90.0	± 9.6 %
		Y	5.31	68.10	19.14		90.0	
		Z	5.17	68.14	19.47		90.0	
10077-CAB	IEEE 802.11g WiFi 2.4 GHz (DSSS/OFDM, 54 Mbps)	X	4.95	67.80	18.85	4.30	90.0	± 9.6 %
		Y	5.33	68.14	19.22		90.0	
		Z	5.20	68.21	19.57		90.0	



EF3DV3 – SN.4048

January 9, 2018

10081-CAB	CDMA2000 (1xRTT, RC3)	X	1.05	70.34	13.37	0.00	150.0	± 9.6 %
		Y	1.51	74.81	17.49		150.0	
		Z	1.28	72.78	15.25		150.0	
10082-CAB	IS-54 / IS-136 FDD (TDMA/FDM, PI/4-DQPSK, Fullrate)	X	0.59	60.00	3.42	4.77	80.0	± 9.6 %
		Y	1.02	60.49	4.88		80.0	
		Z	0.74	60.00	4.08		80.0	
10090-DAC	GPRS-FDD (TDMA, GMSK, TN 0-4)	X	2.26	67.72	9.89	6.56	60.0	± 9.6 %
		Y	40.86	99.57	22.28		60.0	
		Z	100.00	110.90	24.73		60.0	
10097-CAB	UMTS-FDD (HSDPA)	X	2.12	71.62	17.53	0.00	150.0	± 9.6 %
		Y	2.09	70.32	17.50		150.0	
		Z	2.09	70.96	17.56		150.0	
10098-CAB	UMTS-FDD (HSUPA, Subtest 2)	X	2.09	71.66	17.56	0.00	150.0	± 9.6 %
		Y	2.06	70.37	17.51		150.0	
		Z	2.06	71.02	17.59		150.0	
10099-DAC	EDGE-FDD (TDMA, 8PSK, TN 0-4)	X	14.22	106.09	37.87	9.56	60.0	± 9.6 %
		Y	25.12	114.86	39.84		60.0	
		Z	30.33	126.49	45.17		60.0	
10100-CAD	LTE-FDD (SC-FDMA, 100% RB, 20 MHz, QPSK)	X	3.33	72.41	18.01	0.00	150.0	± 9.6 %
		Y	3.62	72.83	18.06		150.0	
		Z	3.44	72.49	18.05		150.0	
10101-CAD	LTE-FDD (SC-FDMA, 100% RB, 20 MHz, 16-QAM)	X	3.33	68.90	16.87	0.00	150.0	± 9.6 %
		Y	3.56	69.17	16.99		150.0	
		Z	3.42	68.93	16.98		150.0	
10102-CAD	LTE-FDD (SC-FDMA, 100% RB, 20 MHz, 64-QAM)	X	3.42	68.81	16.93	0.00	150.0	± 9.6 %
		Y	3.65	69.00	17.02		150.0	
		Z	3.51	68.80	17.02		150.0	
10103-CAD	LTE-TDD (SC-FDMA, 100% RB, 20 MHz, QPSK)	X	6.00	76.22	20.60	3.98	65.0	± 9.6 %
		Y	7.22	77.12	20.81		65.0	
		Z	6.95	78.44	22.02		65.0	
10104-CAD	LTE-TDD (SC-FDMA, 100% RB, 20 MHz, 16-QAM)	X	6.12	74.74	20.85	3.98	65.0	± 9.6 %
		Y	7.62	76.82	21.69		65.0	
		Z	7.02	76.95	22.32		65.0	
10105-CAD	LTE-TDD (SC-FDMA, 100% RB, 20 MHz, 64-QAM)	X	5.79	73.50	20.62	3.98	65.0	± 9.6 %
		Y	6.98	75.02	21.23		65.0	
		Z	6.35	74.73	21.65		65.0	
10108-CAE	LTE-FDD (SC-FDMA, 100% RB, 10 MHz, QPSK)	X	2.93	72.17	18.08	0.00	150.0	± 9.6 %
		Y	3.22	72.33	18.05		150.0	
		Z	3.06	72.23	18.14		150.0	
10109-CAE	LTE-FDD (SC-FDMA, 100% RB, 10 MHz, 16-QAM)	X	2.98	69.09	16.86	0.00	150.0	± 9.6 %
		Y	3.23	69.17	17.02		150.0	
		Z	3.08	69.05	16.99		150.0	
10110-CAE	LTE-FDD (SC-FDMA, 100% RB, 5 MHz, QPSK)	X	2.44	72.08	17.92	0.00	150.0	± 9.6 %
		Y	2.70	71.86	17.99		150.0	
		Z	2.56	72.10	18.08		150.0	
10111-CAE	LTE-FDD (SC-FDMA, 100% RB, 5 MHz, 16-QAM)	X	2.74	70.64	17.26	0.00	150.0	± 9.6 %
		Y	2.93	69.99	17.42		150.0	
		Z	2.80	70.22	17.36		150.0	



EF3DV3 – SN:4048

January 9, 2018

10112-CAE	LTE-FDD (SC-FDMA, 100% RB, 10 MHz, 64-QAM)	X	3.10	69.03	16.87	0.00	150.0	± 9.6 %
		Y	3.33	68.98	16.99		150.0	
		Z	3.19	68.92	16.98		150.0	
10113-CAE	LTE-FDD (SC-FDMA, 100% RB, 5 MHz, 64-QAM)	X	2.88	70.69	17.33	0.00	150.0	± 9.6 %
		Y	3.07	69.95	17.45		150.0	
		Z	2.94	70.23	17.42		150.0	
10114-CAC	IEEE 802.11n (HT Greenfield, 13.5 Mbps, BPSK)	X	5.27	68.50	17.33	0.00	150.0	± 9.6 %
		Y	5.45	68.30	17.22		150.0	
		Z	5.47	68.77	17.59		150.0	
10115-CAC	IEEE 802.11n (HT Greenfield, 81 Mbps, 16-QAM)	X	5.58	68.78	17.48	0.00	150.0	± 9.6 %
		Y	5.91	68.93	17.55		150.0	
		Z	5.71	68.71	17.57		150.0	
10116-CAC	IEEE 802.11n (HT Greenfield, 135 Mbps, 64-QAM)	X	5.38	68.76	17.39	0.00	150.0	± 9.6 %
		Y	5.64	68.77	17.38		150.0	
		Z	5.55	68.87	17.56		150.0	
10117-CAC	IEEE 802.11n (HT Mixed, 13.5 Mbps, BPSK)	X	5.24	68.37	17.29	0.00	150.0	± 9.6 %
		Y	5.45	68.32	17.24		150.0	
		Z	5.33	68.25	17.35		150.0	
10118-CAC	IEEE 802.11n (HT Mixed, 81 Mbps, 16-QAM)	X	5.83	69.55	17.88	0.00	150.0	± 9.6 %
		Y	5.90	68.81	17.48		150.0	
		Z	5.98	69.55	18.01		150.0	
10119-CAC	IEEE 802.11n (HT Mixed, 135 Mbps, 64-QAM)	X	5.44	68.98	17.51	0.00	150.0	± 9.6 %
		Y	5.64	68.84	17.43		150.0	
		Z	5.62	69.14	17.72		150.0	
10140-CAD	LTE-FDD (SC-FDMA, 100% RB, 15 MHz, 16-QAM)	X	3.45	68.84	16.84	0.00	150.0	± 9.6 %
		Y	3.69	68.99	16.93		150.0	
		Z	3.55	68.80	16.93		150.0	
10141-CAD	LTE-FDD (SC-FDMA, 100% RB, 15 MHz, 64-QAM)	X	3.57	68.92	16.99	0.00	150.0	± 9.6 %
		Y	3.80	68.97	17.04		150.0	
		Z	3.66	68.83	17.06		150.0	
10142-CAD	LTE-FDD (SC-FDMA, 100% RB, 3 MHz, QPSK)	X	2.27	72.74	17.57	0.00	150.0	± 9.6 %
		Y	2.50	72.26	17.96		150.0	
		Z	2.38	72.70	17.89		150.0	
10143-CAD	LTE-FDD (SC-FDMA, 100% RB, 3 MHz, 16-QAM)	X	2.64	71.69	16.69	0.00	150.0	± 9.6 %
		Y	2.85	71.06	17.42		150.0	
		Z	2.71	71.33	17.06		150.0	
10144-CAD	LTE-FDD (SC-FDMA, 100% RB, 3 MHz, 64-QAM)	X	2.25	68.32	14.51	0.00	150.0	± 9.6 %
		Y	2.63	68.90	15.90		150.0	
		Z	2.43	68.64	15.24		150.0	
10145-CAE	LTE-FDD (SC-FDMA, 100% RB, 1.4 MHz, QPSK)	X	0.98	63.98	9.67	0.00	150.0	± 9.6 %
		Y	1.83	70.72	15.51		150.0	
		Z	1.30	66.67	12.12		150.0	
10146-CAE	LTE-FDD (SC-FDMA, 100% RB, 1.4 MHz, 16-QAM)	X	1.20	62.39	7.69	0.00	150.0	± 9.6 %
		Y	3.23	72.43	15.23		150.0	
		Z	2.33	70.73	13.96		150.0	
10147-CAE	LTE-FDD (SC-FDMA, 100% RB, 1.4 MHz, 64-QAM)	X	1.25	62.78	8.00	0.00	150.0	± 9.6 %
		Y	3.99	75.39	16.63		150.0	
		Z	3.45	75.89	16.27		150.0	



EF3DV3 – SN-4048

January 9, 2018

10149-CAD	LTE-FDD (SC-FDMA, 50% RB, 20 MHz, 16-QAM)	X	2.99	69.15	16.91	0.00	150.0	± 9.6 %
		Y	3.23	69.22	17.06		150.0	
		Z	3.09	69.11	17.04		150.0	
10150-CAD	LTE-FDD (SC-FDMA, 50% RB, 20 MHz, 64-QAM)	X	3.10	69.09	16.92	0.00	150.0	± 9.6 %
		Y	3.34	69.03	17.03		150.0	
		Z	3.20	68.97	17.02		150.0	
10151-CAD	LTE-TDD (SC-FDMA, 50% RB, 20 MHz, QPSK)	X	6.54	79.54	21.90	3.98	65.0	± 9.6 %
		Y	7.97	80.30	22.16		65.0	
		Z	8.13	83.17	23.96		65.0	
10152-CAD	LTE-TDD (SC-FDMA, 50% RB, 20 MHz, 16-QAM)	X	5.65	74.76	20.37	3.98	65.0	± 9.6 %
		Y	7.24	77.06	21.53		65.0	
		Z	6.66	77.40	22.16		65.0	
10153-CAD	LTE-TDD (SC-FDMA, 50% RB, 20 MHz, 64-QAM)	X	6.04	75.83	21.22	3.98	65.0	± 9.6 %
		Y	7.57	77.77	22.20		65.0	
		Z	7.02	78.26	22.89		65.0	
10154-CAE	LTE-FDD (SC-FDMA, 50% RB, 10 MHz, QPSK)	X	2.49	72.52	18.18	0.00	150.0	± 9.6 %
		Y	2.76	72.36	18.28		150.0	
		Z	2.62	72.54	18.34		150.0	
10155-CAE	LTE-FDD (SC-FDMA, 50% RB, 10 MHz, 16-QAM)	X	2.75	70.67	17.29	0.00	150.0	± 9.6 %
		Y	2.93	70.00	17.43		150.0	
		Z	2.80	70.24	17.38		150.0	
10156-CAE	LTE-FDD (SC-FDMA, 50% RB, 5 MHz, QPSK)	X	2.13	73.09	17.25	0.00	150.0	± 9.6 %
		Y	2.41	73.02	18.13		150.0	
		Z	2.27	73.32	17.82		150.0	
10157-CAE	LTE-FDD (SC-FDMA, 50% RB, 5 MHz, 16-QAM)	X	2.15	69.25	14.50	0.00	150.0	± 9.6 %
		Y	2.58	70.28	16.38		150.0	
		Z	2.40	70.09	15.57		150.0	
10158-CAE	LTE-FDD (SC-FDMA, 50% RB, 10 MHz, 64-QAM)	X	2.89	70.77	17.39	0.00	150.0	± 9.6 %
		Y	3.08	70.00	17.49		150.0	
		Z	2.95	70.29	17.47		150.0	
10159-CAE	LTE-FDD (SC-FDMA, 50% RB, 5 MHz, 64-QAM)	X	2.18	69.22	14.56	0.00	150.0	± 9.6 %
		Y	2.63	70.32	16.48		150.0	
		Z	2.39	69.85	15.54		150.0	
10160-CAD	LTE-FDD (SC-FDMA, 50% RB, 15 MHz, QPSK)	X	3.25	72.87	18.44	0.00	150.0	± 9.6 %
		Y	3.43	72.33	18.29		150.0	
		Z	3.54	73.64	18.88		150.0	
10161-CAD	LTE-FDD (SC-FDMA, 50% RB, 15 MHz, 16-QAM)	X	3.00	69.13	16.83	0.00	150.0	± 9.6 %
		Y	3.23	68.95	16.98		150.0	
		Z	3.09	68.97	16.96		150.0	
10162-CAD	LTE-FDD (SC-FDMA, 50% RB, 15 MHz, 64-QAM)	X	3.11	69.31	16.95	0.00	150.0	± 9.6 %
		Y	3.33	68.97	17.03		150.0	
		Z	3.20	69.08	17.05		150.0	
10166-CAE	LTE-FDD (SC-FDMA, 50% RB, 1.4 MHz, QPSK)	X	3.40	71.02	20.13	3.01	150.0	± 9.6 %
		Y	4.16	72.19	20.54		150.0	
		Z	3.50	70.96	20.76		150.0	
10167-CAE	LTE-FDD (SC-FDMA, 50% RB, 1.4 MHz, 16-QAM)	X	4.24	74.95	20.93	3.01	150.0	± 9.6 %
		Y	5.69	76.63	21.50		150.0	
		Z	4.07	73.90	21.30		150.0	



EF3DV3 – SN:4048

January 9, 2018

10168-CAE	LTE-FDD (SC-FDMA, 50% RB, 1.4 MHz, 64-QAM)	X	4.83	77.93	22.59	3.01	150.0	± 9.6 %
		Y	6.32	78.92	22.75		150.0	
		Z	4.49	76.24	22.69		150.0	
10169-CAD	LTE-FDD (SC-FDMA, 1 RB, 20 MHz, QPSK)	X	2.67	69.45	19.55	3.01	150.0	± 9.6 %
		Y	3.98	74.79	21.68		150.0	
		Z	2.55	68.69	20.07		150.0	
10170-CAD	LTE-FDD (SC-FDMA, 1 RB, 20 MHz, 16-QAM)	X	3.68	76.80	22.59	3.01	150.0	± 9.6 %
		Y	7.10	85.06	25.20		150.0	
		Z	3.01	73.79	22.44		150.0	
10171-AAD	LTE-FDD (SC-FDMA, 1 RB, 20 MHz, 64-QAM)	X	2.99	72.24	19.50	3.01	150.0	± 9.6 %
		Y	5.35	78.80	21.82		150.0	
		Z	2.61	70.59	19.90		150.0	
10172-CAD	LTE-TDD (SC-FDMA, 1 RB, 20 MHz, QPSK)	X	6.50	90.52	28.24	6.02	65.0	± 9.6 %
		Y	26.74	110.78	33.70		65.0	
		Z	13.98	109.40	36.62		65.0	
10173-CAD	LTE-TDD (SC-FDMA, 1 RB, 20 MHz, 16-QAM)	X	14.41	100.42	28.77	6.02	65.0	± 9.6 %
		Y	42.14	111.90	31.64		65.0	
		Z	100.00	144.19	43.15		65.0	
10174-CAD	LTE-TDD (SC-FDMA, 1 RB, 20 MHz, 64-QAM)	X	8.64	90.44	25.00	6.02	65.0	± 9.6 %
		Y	22.47	99.76	27.70		65.0	
		Z	57.04	130.14	38.90		65.0	
10175-CAE	LTE-FDD (SC-FDMA, 1 RB, 10 MHz, QPSK)	X	2.65	69.24	19.34	3.01	150.0	± 9.6 %
		Y	3.93	74.42	21.41		150.0	
		Z	2.55	68.56	19.89		150.0	
10176-CAE	LTE-FDD (SC-FDMA, 1 RB, 10 MHz, 16-QAM)	X	3.68	76.83	22.60	3.01	150.0	± 9.6 %
		Y	7.11	85.09	25.21		150.0	
		Z	3.02	73.82	22.46		150.0	
10177-CAG	LTE-FDD (SC-FDMA, 1 RB, 5 MHz, QPSK)	X	2.66	69.31	19.39	3.01	150.0	± 9.6 %
		Y	3.96	74.56	21.50		150.0	
		Z	2.55	68.60	19.93		150.0	
10178-CAE	LTE-FDD (SC-FDMA, 1 RB, 5 MHz, 16-QAM)	X	3.65	76.64	22.50	3.01	150.0	± 9.6 %
		Y	6.97	84.67	25.03		150.0	
		Z	3.00	73.64	22.35		150.0	
10179-CAE	LTE-FDD (SC-FDMA, 1 RB, 10 MHz, 64-QAM)	X	3.31	74.45	20.92	3.01	150.0	± 9.6 %
		Y	6.11	81.63	23.31		150.0	
		Z	2.81	72.29	21.13		150.0	
10180-CAE	LTE-FDD (SC-FDMA, 1 RB, 5 MHz, 64-QAM)	X	2.99	72.20	19.46	3.01	150.0	± 9.6 %
		Y	5.32	78.68	21.76		150.0	
		Z	2.61	70.55	19.86		150.0	
10181-CAD	LTE-FDD (SC-FDMA, 1 RB, 15 MHz, QPSK)	X	2.66	69.30	19.39	3.01	150.0	± 9.6 %
		Y	3.95	74.55	21.49		150.0	
		Z	2.55	68.58	19.93		150.0	
10182-CAD	LTE-FDD (SC-FDMA, 1 RB, 15 MHz, 16-QAM)	X	3.65	76.61	22.49	3.01	150.0	± 9.6 %
		Y	6.95	84.63	25.02		150.0	
		Z	2.99	73.61	22.34		150.0	
10183-AAC	LTE-FDD (SC-FDMA, 1 RB, 15 MHz, 64-QAM)	X	2.98	72.17	19.45	3.01	150.0	± 9.6 %
		Y	5.31	78.65	21.74		150.0	
		Z	2.60	70.52	19.84		150.0	





EF3DV3 – SN:4048

January 9, 2018

10184-CAD	LTE-FDD (SC-FDMA, 1 RB, 3 MHz, QPSK)	X	2.67	69.33	19.40	3.01	150.0	± 9.6 %
		Y	3.97	74.59	21.51		150.0	
		Z	2.56	68.62	19.94		150.0	
10185-CAD	LTE-FDD (SC-FDMA, 1 RB, 3 MHz, 16-QAM)	X	3.67	76.70	22.53	3.01	150.0	± 9.6 %
		Y	6.99	84.74	25.06		150.0	
		Z	3.01	73.69	22.38		150.0	
10186-AAD	LTE-FDD (SC-FDMA, 1 RB, 3 MHz, 64-QAM)	X	3.00	72.25	19.49	3.01	150.0	± 9.6 %
		Y	5.34	78.74	21.78		150.0	
		Z	2.62	70.60	19.89		150.0	
10187-CAE	LTE-FDD (SC-FDMA, 1 RB, 1.4 MHz, QPSK)	X	2.68	69.41	19.49	3.01	150.0	± 9.6 %
		Y	3.98	74.67	21.58		150.0	
		Z	2.57	68.68	20.02		150.0	
10188-CAE	LTE-FDD (SC-FDMA, 1 RB, 1.4 MHz, 16-QAM)	X	3.78	77.39	22.93	3.01	150.0	± 9.6 %
		Y	7.36	85.81	25.55		150.0	
		Z	3.08	74.23	22.72		150.0	
10189-AAE	LTE-FDD (SC-FDMA, 1 RB, 1.4 MHz, 64-QAM)	X	3.07	72.69	19.78	3.01	150.0	± 9.6 %
		Y	5.51	79.38	22.12		150.0	
		Z	2.67	70.97	20.15		150.0	
10193-CAC	IEEE 802.11n (HT Greenfield, 6.5 Mbps, BPSK)	X	4.56	67.78	16.85	0.00	150.0	± 9.6 %
		Y	4.79	67.55	16.89		150.0	
		Z	4.66	67.57	16.94		150.0	
10194-CAC	IEEE 802.11n (HT Greenfield, 39 Mbps, 16-QAM)	X	4.71	68.06	17.00	0.00	150.0	± 9.6 %
		Y	5.00	67.93	17.02		150.0	
		Z	4.84	67.90	17.08		150.0	
10195-CAC	IEEE 802.11n (HT Greenfield, 65 Mbps, 64-QAM)	X	4.75	68.09	17.02	0.00	150.0	± 9.6 %
		Y	5.04	67.94	17.03		150.0	
		Z	4.88	67.94	17.10		150.0	
10196-CAC	IEEE 802.11n (HT Mixed, 6.5 Mbps, BPSK)	X	4.55	67.81	16.86	0.00	150.0	± 9.6 %
		Y	4.82	67.66	16.94		150.0	
		Z	4.66	67.65	16.97		150.0	
10197-CAC	IEEE 802.11n (HT Mixed, 39 Mbps, 16-QAM)	X	4.73	68.07	17.01	0.00	150.0	± 9.6 %
		Y	5.02	67.95	17.03		150.0	
		Z	4.85	67.93	17.10		150.0	
10198-CAC	IEEE 802.11n (HT Mixed, 65 Mbps, 64-QAM)	X	4.75	68.10	17.03	0.00	150.0	± 9.6 %
		Y	5.05	67.96	17.04		150.0	
		Z	4.88	67.96	17.12		150.0	
10219-CAC	IEEE 802.11n (HT Mixed, 7.2 Mbps, BPSK)	X	4.50	67.85	16.83	0.00	150.0	± 9.6 %
		Y	4.77	67.69	16.91		150.0	
		Z	4.61	67.68	16.93		150.0	
10220-CAC	IEEE 802.11n (HT Mixed, 43.3 Mbps, 16-QAM)	X	4.72	68.03	17.00	0.00	150.0	± 9.6 %
		Y	5.02	67.95	17.03		150.0	
		Z	4.85	67.90	17.09		150.0	
10221-CAC	IEEE 802.11n (HT Mixed, 72.2 Mbps, 64-QAM)	X	4.76	68.03	17.01	0.00	150.0	± 9.6 %
		Y	5.05	67.89	17.03		150.0	
		Z	4.89	67.88	17.10		150.0	
10222-CAC	IEEE 802.11n (HT Mixed, 15 Mbps, BPSK)	X	5.21	68.35	17.27	0.00	150.0	± 9.6 %
		Y	5.44	68.36	17.26		150.0	
		Z	5.31	68.27	17.35		150.0	



EF3DV3 – SN:4048

January 9, 2018

10223-CAC	IEEE 802.11n (HT Mixed, 90 Mbps, 16-QAM)	X	5.58	68.87	17.55	0.00	150.0	± 9.6 %
		Y	5.94	69.16	17.69		150.0	
		Z	5.74	68.93	17.71		150.0	
10224-CAC	IEEE 802.11n (HT Mixed, 150 Mbps, 64-QAM)	X	5.25	68.46	17.25	0.00	150.0	± 9.6 %
		Y	5.47	68.38	17.18		150.0	
		Z	5.37	68.43	17.35		150.0	
10225-CAB	UMTS-FDD (HSPA+)	X	2.83	67.70	15.94	0.00	150.0	± 9.6 %
		Y	3.05	67.44	16.43		150.0	
		Z	2.91	67.51	16.24		150.0	
10226-CAA	LTE-TDD (SC-FDMA, 1 RB, 1.4 MHz, 16-QAM)	X	16.01	102.43	29.46	6.02	65.0	± 9.6 %
		Y	46.59	113.83	32.26		65.0	
		Z	100.00	144.45	43.32		65.0	
10227-CAA	LTE-TDD (SC-FDMA, 1 RB, 1.4 MHz, 64-QAM)	X	13.91	97.92	27.27	6.02	65.0	± 9.6 %
		Y	29.38	104.14	29.00		65.0	
		Z	100.00	140.58	41.36		65.0	
10228-CAA	LTE-TDD (SC-FDMA, 1 RB, 1.4 MHz, QPSK)	X	8.36	95.48	29.90	6.02	65.0	± 9.6 %
		Y	38.95	118.34	35.84		65.0	
		Z	30.22	126.68	41.56		65.0	
10229-CAB	LTE-TDD (SC-FDMA, 1 RB, 3 MHz, 16-QAM)	X	14.47	100.47	28.79	6.02	65.0	± 9.6 %
		Y	42.07	111.87	31.64		65.0	
		Z	100.00	144.15	43.14		65.0	
10230-CAB	LTE-TDD (SC-FDMA, 1 RB, 3 MHz, 64-QAM)	X	12.61	96.21	26.68	6.02	65.0	± 9.6 %
		Y	27.31	102.80	28.54		65.0	
		Z	100.00	140.43	41.25		65.0	
10231-CAB	LTE-TDD (SC-FDMA, 1 RB, 3 MHz, QPSK)	X	7.88	94.21	29.40	6.02	65.0	± 9.6 %
		Y	35.72	116.50	35.26		65.0	
		Z	27.20	124.15	40.78		65.0	
10232-CAD	LTE-TDD (SC-FDMA, 1 RB, 5 MHz, 16-QAM)	X	14.45	100.46	28.79	6.02	65.0	± 9.6 %
		Y	42.10	111.89	31.65		65.0	
		Z	100.00	144.18	43.15		65.0	
10233-CAD	LTE-TDD (SC-FDMA, 1 RB, 5 MHz, 64-QAM)	X	12.58	96.20	26.68	6.02	65.0	± 9.6 %
		Y	27.35	102.84	28.55		65.0	
		Z	100.00	140.47	41.26		65.0	
10234-CAD	LTE-TDD (SC-FDMA, 1 RB, 5 MHz, QPSK)	X	7.53	93.14	28.90	6.02	65.0	± 9.6 %
		Y	32.80	114.58	34.61		65.0	
		Z	25.36	122.26	40.12		65.0	
10235-CAD	LTE-TDD (SC-FDMA, 1 RB, 10 MHz, 16-QAM)	X	14.56	100.61	28.83	6.02	65.0	± 9.6 %
		Y	42.49	112.05	31.69		65.0	
		Z	100.00	144.20	43.16		65.0	
10236-CAD	LTE-TDD (SC-FDMA, 1 RB, 10 MHz, 64-QAM)	X	12.83	96.46	26.75	6.02	65.0	± 9.6 %
		Y	27.74	103.03	28.60		65.0	
		Z	100.00	140.35	41.21		65.0	
10237-CAD	LTE-TDD (SC-FDMA, 1 RB, 10 MHz, QPSK)	X	7.93	94.37	29.46	6.02	65.0	± 9.6 %
		Y	36.43	116.90	35.37		65.0	
		Z	27.83	124.72	40.95		65.0	
10238-CAD	LTE-TDD (SC-FDMA, 1 RB, 15 MHz, 16-QAM)	X	14.42	100.44	28.78	6.02	65.0	± 9.6 %
		Y	42.15	111.92	31.65		65.0	
		Z	100.00	144.21	43.16		65.0	



EF3DV3 – SN:4048

January 9, 2018

10239-CAD	LTE-TDD (SC-FDMA, 1 RB, 15 MHz, 64-QAM)	X	12.55	96.18	26.67	6.02	65.0	± 9.6 %
		Y	27.39	102.88	28.56		65.0	
		Z	100.00	140.51	41.28		65.0	
10240-CAD	LTE-TDD (SC-FDMA, 1 RB, 15 MHz, QPSK)	X	7.88	94.27	29.42	6.02	65.0	± 9.6 %
		Y	36.07	116.73	35.32		65.0	
		Z	27.45	124.44	40.87		65.0	
10241-CAA	LTE-TDD (SC-FDMA, 50% RB, 1.4 MHz, 16-QAM)	X	7.95	84.17	26.42	6.98	65.0	± 9.6 %
		Y	11.20	86.91	27.48		65.0	
		Z	8.58	85.75	28.34		65.0	
10242-CAA	LTE-TDD (SC-FDMA, 50% RB, 1.4 MHz, 64-QAM)	X	7.17	82.05	25.51	6.98	65.0	± 9.6 %
		Y	9.59	83.52	26.08		65.0	
		Z	7.61	82.93	27.09		65.0	
10243-CAA	LTE-TDD (SC-FDMA, 50% RB, 1.4 MHz, QPSK)	X	5.73	78.07	24.92	6.98	65.0	± 9.6 %
		Y	7.54	80.11	25.72		65.0	
		Z	6.19	78.98	26.38		65.0	
10244-CAB	LTE-TDD (SC-FDMA, 50% RB, 3 MHz, 16-QAM)	X	3.76	69.60	13.89	3.98	65.0	± 9.6 %
		Y	7.55	78.56	19.75		65.0	
		Z	7.54	81.51	21.11		65.0	
10245-CAB	LTE-TDD (SC-FDMA, 50% RB, 3 MHz, 64-QAM)	X	3.71	69.19	13.65	3.98	65.0	± 9.6 %
		Y	7.47	78.13	19.54		65.0	
		Z	7.18	80.40	20.61		65.0	
10246-CAB	LTE-TDD (SC-FDMA, 50% RB, 3 MHz, QPSK)	X	3.86	73.36	16.13	3.98	65.0	± 9.6 %
		Y	7.49	81.95	21.21		65.0	
		Z	8.11	85.27	22.26		65.0	
10247-CAD	LTE-TDD (SC-FDMA, 50% RB, 5 MHz, 16-QAM)	X	4.21	71.89	16.44	3.98	65.0	± 9.6 %
		Y	6.40	77.02	20.09		65.0	
		Z	5.88	77.35	20.08		65.0	
10248-CAD	LTE-TDD (SC-FDMA, 50% RB, 5 MHz, 64-QAM)	X	4.22	71.52	16.27	3.98	65.0	± 9.6 %
		Y	6.46	76.64	19.93		65.0	
		Z	5.82	76.67	19.79		65.0	
10249-CAD	LTE-TDD (SC-FDMA, 50% RB, 5 MHz, QPSK)	X	5.83	80.10	20.21	3.98	65.0	± 9.6 %
		Y	8.70	84.65	22.97		65.0	
		Z	10.72	90.86	25.37		65.0	
10250-CAD	LTE-TDD (SC-FDMA, 50% RB, 10 MHz, 16-QAM)	X	5.63	76.82	20.90	3.98	65.0	± 9.6 %
		Y	7.35	79.34	22.47		65.0	
		Z	6.95	80.49	23.30		65.0	
10251-CAD	LTE-TDD (SC-FDMA, 50% RB, 10 MHz, 64-QAM)	X	5.34	74.65	19.59	3.98	65.0	± 9.6 %
		Y	7.03	77.28	21.33		65.0	
		Z	6.54	77.97	21.89		65.0	
10252-CAD	LTE-TDD (SC-FDMA, 50% RB, 10 MHz, QPSK)	X	6.86	82.67	22.79	3.98	65.0	± 9.6 %
		Y	8.63	83.81	23.49		65.0	
		Z	9.69	88.90	25.95		65.0	
10253-CAD	LTE-TDD (SC-FDMA, 50% RB, 15 MHz, 16-QAM)	X	5.53	74.24	20.05	3.98	65.0	± 9.6 %
		Y	6.99	76.32	21.27		65.0	
		Z	6.45	76.66	21.81		65.0	
10254-CAD	LTE-TDD (SC-FDMA, 50% RB, 15 MHz, 64-QAM)	X	5.89	75.21	20.79	3.98	65.0	± 9.6 %
		Y	7.35	77.09	21.90		65.0	
		Z	6.81	77.53	22.49		65.0	

Certificate No: EF3-4048\_Jan18

Page 21 of 39



EF3DV3 – SN:4048

January 9, 2018

10255-CAD	LTE-TDD (SC-FDMA, 50% RB, 15 MHz, QPSK)	X	6.29	79.09	21.90	3.98	65.0	± 9.6 %
		Y	7.69	79.97	22.31		65.0	
		Z	7.73	82.54	23.95		65.0	
10256-CAA	LTE-TDD (SC-FDMA, 100% RB, 1.4 MHz, 16-QAM)	X	2.73	65.53	10.62	3.98	65.0	± 9.6 %
		Y	6.19	75.16	17.42		65.0	
		Z	5.40	75.62	17.51		65.0	
10257-CAA	LTE-TDD (SC-FDMA, 100% RB, 1.4 MHz, 64-QAM)	X	2.72	65.21	10.37	3.98	65.0	± 9.6 %
		Y	6.11	74.61	17.12		65.0	
		Z	5.08	74.29	16.82		65.0	
10258-CAA	LTE-TDD (SC-FDMA, 100% RB, 1.4 MHz, QPSK)	X	2.58	67.46	12.28	3.98	65.0	± 9.6 %
		Y	5.98	78.02	18.99		65.0	
		Z	5.09	77.14	18.16		65.0	
10259-CAB	LTE-TDD (SC-FDMA, 100% RB, 3 MHz, 16-QAM)	X	4.78	73.88	18.13	3.98	65.0	± 9.6 %
		Y	6.79	77.89	20.95		65.0	
		Z	6.35	78.67	21.31		65.0	
10260-CAB	LTE-TDD (SC-FDMA, 100% RB, 3 MHz, 64-QAM)	X	4.79	73.57	18.00	3.98	65.0	± 9.6 %
		Y	6.83	77.65	20.87		65.0	
		Z	6.31	78.18	21.11		65.0	
10261-CAB	LTE-TDD (SC-FDMA, 100% RB, 3 MHz, QPSK)	X	5.99	80.47	21.00	3.98	65.0	± 9.6 %
		Y	8.33	83.69	23.01		65.0	
		Z	9.48	88.71	25.18		65.0	
10262-CAD	LTE-TDD (SC-FDMA, 100% RB, 5 MHz, 16-QAM)	X	5.61	76.75	20.85	3.98	65.0	± 9.6 %
		Y	7.35	79.31	22.43		65.0	
		Z	6.94	80.44	23.26		65.0	
10263-CAD	LTE-TDD (SC-FDMA, 100% RB, 5 MHz, 64-QAM)	X	5.33	74.62	19.58	3.98	65.0	± 9.6 %
		Y	7.02	77.27	21.33		65.0	
		Z	6.52	77.94	21.88		65.0	
10264-CAD	LTE-TDD (SC-FDMA, 100% RB, 5 MHz, QPSK)	X	6.79	82.44	22.68	3.98	65.0	± 9.6 %
		Y	8.57	83.66	23.41		65.0	
		Z	9.58	88.65	25.84		65.0	
10265-CAD	LTE-TDD (SC-FDMA, 100% RB, 10 MHz, 16-QAM)	X	5.65	74.76	20.37	3.98	65.0	± 9.6 %
		Y	7.23	77.06	21.53		65.0	
		Z	6.65	77.40	22.17		65.0	
10266-CAD	LTE-TDD (SC-FDMA, 100% RB, 10 MHz, 64-QAM)	X	6.03	75.81	21.20	3.98	65.0	± 9.6 %
		Y	7.56	77.76	22.19		65.0	
		Z	7.01	78.24	22.88		65.0	
10267-CAD	LTE-TDD (SC-FDMA, 100% RB, 10 MHz, QPSK)	X	6.53	79.49	21.88	3.98	65.0	± 9.6 %
		Y	7.96	80.26	22.14		65.0	
		Z	8.11	83.12	23.94		65.0	
10268-CAD	LTE-TDD (SC-FDMA, 100% RB, 15 MHz, 16-QAM)	X	6.27	74.66	20.91	3.98	65.0	± 9.6 %
		Y	7.71	76.49	21.70		65.0	
		Z	7.11	76.60	22.28		65.0	
10269-CAD	LTE-TDD (SC-FDMA, 100% RB, 15 MHz, 64-QAM)	X	6.26	74.26	20.78	3.98	65.0	± 9.6 %
		Y	7.64	76.03	21.59		65.0	
		Z	7.04	76.06	22.10		65.0	
10270-CAD	LTE-TDD (SC-FDMA, 100% RB, 15 MHz, QPSK)	X	6.30	76.50	20.95	3.98	65.0	± 9.6 %
		Y	7.59	77.48	21.24		65.0	
		Z	7.30	78.77	22.41		65.0	



EF3DV3 – SN:4048

January 9, 2018

10274-CAB	UMTS-FDD (HSUPA, Subtest 5, 3GPP Rel8.10)	X	2.70	68.56	16.12	0.00	150.0	± 9.6 %
		Y	2.79	67.80	16.34		150.0	
		Z	2.74	68.13	16.29		150.0	
10275-CAB	UMTS-FDD (HSUPA, Subtest 5, 3GPP Rel8.4)	X	1.93	72.54	17.86	0.00	150.0	± 9.6 %
		Y	2.02	72.02	17.97		150.0	
		Z	1.98	72.50	18.05		150.0	
10277-CAA	PHS (QPSK)	X	2.03	61.33	5.59	9.03	50.0	± 9.6 %
		Y	3.35	64.94	9.50		50.0	
		Z	2.60	63.28	7.72		50.0	
10278-CAA	PHS (QPSK, BW 884MHz, Rolloff 0.5)	X	3.14	66.17	10.50	9.03	50.0	± 9.6 %
		Y	6.32	75.59	17.16		50.0	
		Z	5.54	74.41	15.91		50.0	
10279-CAA	PHS (QPSK, BW 884MHz, Rolloff 0.38)	X	3.22	66.42	10.68	9.03	50.0	± 9.6 %
		Y	6.52	75.94	17.35		50.0	
		Z	5.73	74.82	16.15		50.0	
10290-AAB	CDMA2000, RC1, SO55, Full Rate	X	1.62	71.70	14.06	0.00	150.0	± 9.6 %
		Y	2.42	76.19	18.04		150.0	
		Z	2.10	74.61	16.14		150.0	
10291-AAB	CDMA2000, RC3, SO55, Full Rate	X	1.00	69.85	13.13	0.00	150.0	± 9.6 %
		Y	1.45	74.25	17.24		150.0	
		Z	1.22	72.20	14.99		150.0	
10292-AAB	CDMA2000, RC3, SO32, Full Rate	X	5.32	91.53	21.20	0.00	150.0	± 9.6 %
		Y	2.87	85.95	22.18		150.0	
		Z	4.51	90.94	22.10		150.0	
10293-AAB	CDMA2000, RC3, SO3, Full Rate	X	100.00	131.73	31.79	0.00	150.0	± 9.6 %
		Y	7.74	102.49	27.96		150.0	
		Z	100.00	136.11	34.04		150.0	
10295-AAB	CDMA2000, RC1, SO3, 1/8th Rate 25 fr.	X	57.59	108.40	27.97	9.03	50.0	± 9.6 %
		Y	15.14	92.65	26.41		50.0	
		Z	100.00	124.92	34.79		50.0	
10297-AAC	LTE-FDD (SC-FDMA, 50% RB, 20 MHz, QPSK)	X	2.95	72.29	18.15	0.00	150.0	± 9.6 %
		Y	3.24	72.43	18.12		150.0	
		Z	3.07	72.34	18.21		150.0	
10298-AAC	LTE-FDD (SC-FDMA, 50% RB, 3 MHz, QPSK)	X	1.58	69.58	14.03	0.00	150.0	± 9.6 %
		Y	2.21	72.84	17.26		150.0	
		Z	1.90	71.52	15.71		150.0	
10299-AAC	LTE-FDD (SC-FDMA, 50% RB, 3 MHz, 16-QAM)	X	1.83	66.40	11.18	0.00	150.0	± 9.6 %
		Y	3.98	75.10	17.23		150.0	
		Z	3.86	77.80	18.26		150.0	
10300-AAC	LTE-FDD (SC-FDMA, 50% RB, 3 MHz, 64-QAM)	X	1.46	63.37	8.88	0.00	150.0	± 9.6 %
		Y	2.89	69.52	14.08		150.0	
		Z	2.11	68.04	13.10		150.0	
10301-AAA	IEEE 802.16e WiMAX (29:18, 5ms, 10MHz, QPSK, PUSC)	X	4.56	66.33	17.93	4.17	80.0	± 9.6 %
		Y	5.11	66.67	18.42		80.0	
		Z	4.97	66.95	18.46		80.0	
10302-AAA	IEEE 802.16e WiMAX (29:18, 5ms, 10MHz, QPSK, PUSC, 3 CTRL symbols)	X	4.99	66.70	18.53	4.96	80.0	± 9.6 %
		Y	5.61	67.45	19.24		80.0	
		Z	5.45	67.67	19.26		80.0	



EF3DV3 – SN:4048

January 9, 2018

10303-AAA	IEEE 802.16e WiMAX (31:15, 5ms, 10MHz, 64QAM, PUSC)	X	4.72	66.27	18.30	4.96	80.0	± 9.6 %
		Y	5.38	67.24	19.18		80.0	
		Z	5.19	67.34	19.12		80.0	
10304-AAA	IEEE 802.16e WiMAX (29:18, 5ms, 10MHz, 64QAM, PUSC)	X	4.56	66.25	17.85	4.17	80.0	± 9.6 %
		Y	5.14	66.90	18.54		80.0	
		Z	4.99	67.11	18.53		80.0	
10305-AAA	IEEE 802.16e WiMAX (31:15, 10ms, 10MHz, 64QAM, PUSC, 15 symbols)	X	4.00	67.07	18.92	6.02	50.0	± 9.6 %
		Y	4.95	69.48	21.03		50.0	
		Z	4.70	69.39	20.55		50.0	
10306-AAA	IEEE 802.16e WiMAX (29:18, 10ms, 10MHz, 64QAM, PUSC, 18 symbols)	X	4.39	66.50	18.88	6.02	50.0	± 9.6 %
		Y	5.18	68.05	20.35		50.0	
		Z	4.97	68.15	20.11		50.0	
10307-AAA	IEEE 802.16e WiMAX (29:18, 10ms, 10MHz, QPSK, PUSC, 18 symbols)	X	4.27	66.52	18.78	6.02	50.0	± 9.6 %
		Y	5.12	68.41	20.40		50.0	
		Z	4.88	68.35	20.09		50.0	
10308-AAA	IEEE 802.16e WiMAX (29:18, 10ms, 10MHz, 16QAM, PUSC)	X	4.24	66.70	18.91	6.02	50.0	± 9.6 %
		Y	5.08	68.56	20.51		50.0	
		Z	4.86	68.57	20.23		50.0	
10309-AAA	IEEE 802.16e WiMAX (29:18, 10ms, 10MHz, 16QAM, AMC 2x3, 18 symbols)	X	4.43	66.67	19.02	6.02	50.0	± 9.6 %
		Y	5.28	68.41	20.56		50.0	
		Z	5.04	68.45	20.31		50.0	
10310-AAA	IEEE 802.16e WiMAX (29:18, 10ms, 10MHz, QPSK, AMC 2x3, 18 symbols)	X	4.34	66.54	18.86	6.02	50.0	± 9.6 %
		Y	5.13	68.13	20.32		50.0	
		Z	4.92	68.22	20.09		50.0	
10311-AAC	LTE-FDD (SC-FDMA, 100% RB, 15 MHz, QPSK)	X	3.29	71.02	17.55	0.00	150.0	± 9.6 %
		Y	3.58	71.30	17.55		150.0	
		Z	3.40	71.03	17.57		150.0	
10313-AAA	IDEN 1:3	X	3.19	72.57	15.07	6.99	70.0	± 9.6 %
		Y	4.88	75.47	16.63		70.0	
		Z	7.03	83.17	19.85		70.0	
10314-AAA	IDEN 1:6	X	5.31	81.53	21.24	10.00	30.0	± 9.6 %
		Y	6.78	82.49	21.87		30.0	
		Z	16.29	100.28	28.18		30.0	
10315-AAB	IEEE 802.11b WiFi 2.4 GHz (DSSS, 1 Mbps, 96pc duty cycle)	X	1.13	65.91	16.77	0.17	150.0	± 9.6 %
		Y	1.17	66.14	17.04		150.0	
		Z	1.14	66.19	17.22		150.0	
10316-AAB	IEEE 802.11g WiFi 2.4 GHz (ERP-OFDM, 6 Mbps, 96pc duty cycle)	X	4.58	67.71	16.91	0.17	150.0	± 9.6 %
		Y	4.85	67.60	16.99		150.0	
		Z	4.72	67.68	17.13		150.0	
10317-AAC	IEEE 802.11a WiFi 5 GHz (OFDM, 6 Mbps, 96pc duty cycle)	X	4.58	67.71	16.91	0.17	150.0	± 9.6 %
		Y	4.85	67.60	16.99		150.0	
		Z	4.72	67.68	17.13		150.0	
10400-AAD	IEEE 802.11ac WiFi (20MHz, 64-QAM, 99pc duty cycle)	X	4.70	68.16	17.03	0.00	150.0	± 9.6 %
		Y	5.02	68.05	17.05		150.0	
		Z	4.84	68.05	17.13		150.0	
10401-AAD	IEEE 802.11ac WiFi (40MHz, 64-QAM, 99pc duty cycle)	X	5.58	68.69	17.43	0.00	150.0	± 9.6 %
		Y	5.78	68.48	17.34		150.0	
		Z	5.71	68.65	17.55		150.0	