

Preliminary Copy—Subject to Change

# **SEL-3031**

## **Serial Radio Transceiver**

### **Instruction Manual**

20181001

**SEL** SCHWEITZER ENGINEERING LABORATORIES



\* P M 3 0 3 1 - 0 1 \*

# Preliminary Copy—Subject to Change

© 2014–2018 by Schweitzer Engineering Laboratories, Inc. All rights reserved.

All brand or product names appearing in this document are the trademark or registered trademark of their respective holders. No SEL trademarks may be used without written permission. SEL products appearing in this document may be covered by U.S. and Foreign patents.

Schweitzer Engineering Laboratories, Inc. reserves all rights and benefits afforded under federal and international copyright and patent laws in its products, including without limitation software, firmware, and documentation.

The information in this document is provided for informational use only and is subject to change without notice. Schweitzer Engineering Laboratories, Inc. has approved only the English language document.

This product is covered by the standard SEL 10-year warranty. For warranty details, visit [selinc.com](http://selinc.com) or contact your customer service representative. PM3031-01

# **Table of Contents**

<b>List of Tables</b> .....	iii
<b>List of Figures</b> .....	v
<b>Preface</b> .....	vii
<b>Section 1: Introduction and Overview</b>	
Overview .....	1.1
Features, Benefits, and Applications .....	1.2
Models, Options, and Accessories .....	1.3
Product Diagrams .....	1.6
Specifications .....	1.9
<b>Section 2: Installation</b>	
Overview .....	2.1
Connections .....	2.12
Front-Panel Indicators .....	2.15
Communications .....	2.16
<b>Section 3: Job Done Examples</b>	
Overview .....	3.1
High-Speed Teleprotection or Control With MIRRORRED BITS Communications ...	3.1
Using an SEL Information Processor to Collect Relay Status and Measurements	3.6
Setting Up a Point-to-Multipoint Link Using DNP3 SCADA Protocol .....	3.10
Configuring Collocated Antennas Using SEL Hop-Sync Technology .....	3.16
<b>Section 4: Settings and Commands</b>	
PC Software .....	4.1
Settings .....	4.5
Commands .....	4.17
<b>Section 5: Performance Monitoring, Testing, and Troubleshooting</b>	
Overview .....	5.1
Monitoring Radio Performance .....	5.1
Self-Test .....	5.5
Troubleshooting .....	5.6
<b>Appendix A: Firmware and Manual Versions</b>	
Firmware .....	A.1
Instruction Manual .....	A.2

## **Appendix B: Firmware Upgrade Instructions**

Overview.....	B.1
Technical Support.....	B.5

## **Appendix C: SEL-3044 Encryption Card**

Overview.....	C.1
NIST FIPS 140-2 Level 2 Security Requirements .....	C.1
Theory of Operation—SEL Protocol.....	C.2

# List of Tables

Table 1.1	Radio Antenna and Cable Accessories .....	1.4
Table 1.2	Certifications by Country.....	1.12
Table 2.1	Fresnel Zone Diameter.....	2.3
Table 2.2	Antennas Permitted for Use With the SEL-3031 .....	2.4
Table 2.3	900-MHz Frequency Skip Zones (Part Numbers Starting With 30310).....	2.7
Table 2.4	900-MHz Frequency Skip Zones for Brazil (Part Numbers Starting With 30311).....	2.7
Table 2.5	Length vs. Loss in Coaxial Cables at 900 MHz .....	2.7
Table 2.6	Default Passwords.....	2.14
Table 2.7	Password Jumper Position .....	2.15
Table 2.8	Communications Cables for Time and Communications Connections .....	2.15
Table 2.9	Front-Panel Status Indicator LEDs .....	2.16
Table 2.10	SEL-3031 Port Description.....	2.16
Table 2.11	SEL-3031 Port Description.....	2.18
Table 4.1	ACCELERATOR QuickSet SEL-5030 Software .....	4.1
Table 4.2	Device Editor Menus .....	4.9
Table 4.3	Global Settings.....	4.11
Table 4.4	Radio Settings.....	4.12
Table 4.5	SKIP Zone Frequencies (SEL-30310) .....	4.13
Table 4.6	SKIP Zone Frequencies (SEL-30311 Brazil) .....	4.13
Table 4.7	Port Settings.....	4.16
Table 4.8	Fixed Port Settings.....	4.17
Table 4.9	DATE Command.....	4.19
Table 4.10	ID Command.....	4.20
Table 4.11	IRIG Command.....	4.20
Table 4.12	L_D Command .....	4.21
Table 4.13	PAS Command.....	4.21
Table 4.14	Factory-Default Passwords .....	4.21
Table 4.15	Valid Password Characters.....	4.22
Table 4.16	QUIT Command .....	4.23
Table 4.17	RAD Command .....	4.23
Table 4.18	SER Command .....	4.24
Table 4.19	SET Command (Change Settings).....	4.25
Table 4.20	SET Command Editing Keystrokes .....	4.25
Table 4.21	SHO Command (Show/View Settings).....	4.26
Table 4.22	STA Command (Device Self-Test Status).....	4.26
Table 4.23	STA Command Report.....	4.27
Table 4.24	TIME Command Definitions .....	4.27
Table 5.1	Device Self-Tests .....	5.5
Table 5.2	Troubleshooting Tips .....	5.6
Table A.1	Firmware Revision History.....	A.1
Table A.2	Instruction Manual Revision History.....	A.3

Preliminary Copy—Subject to Change

**This page intentionally left blank**

# List of Figures

Figure 1.1	Point-to-Point Product Overview.....	1.1
Figure 1.2	Point-to-Multipoint Product Overview .....	1.2
Figure 1.3	Radio Antenna Connections .....	1.5
Figure 1.4	SEL-3031 Dimensions .....	1.6
Figure 1.5	SEL-3031 Rack Mount (Front and Rear) .....	1.7
Figure 1.6	SEL-3031 Wall Mount (Front and Rear) .....	1.8
Figure 2.1	Fresnel Zone .....	2.2
Figure 2.2	Antenna Polarization.....	2.6
Figure 2.3	Collocated Antennas With Two Radio Links.....	2.9
Figure 2.4	Three Collocated Synchronized Radios.....	2.10
Figure 2.5	Wall-Mount and Rack-Mount Rear Connections .....	2.12
Figure 2.6	SEL-C693 Cable: Two-Wire EIA-485 Connections.....	2.17
Figure 2.7	EIA-232 and EIA-485 DB-9 Connector Pin Numbers .....	2.17
Figure 2.8	SEL-C245A Cable: SEL-3031 to Computer .....	2.19
Figure 2.9	SEL-C285 Cable: SEL-3031 to DTE Device (SEL Relays).....	2.19
Figure 2.10	SEL-C387 Cable: SEL-3031 to SEL Communications Processor With IRIG-B .....	2.20
Figure 2.11	SEL-C273A Cable: SEL-3031 Repeater and Synchronizing Cable.....	2.20
Figure 2.12	SEL-C576 Cable: Synchronizing Cable for SEL-3031 .....	2.21
Figure 2.13	USB Interface .....	2.21
Figure 3.1	SEL MIRRORED BITS Connection Example.....	3.1
Figure 3.2	SEL-3031 Port Settings for MIRRORED BITS Connection .....	3.2
Figure 3.3	SEL-351 Port Settings for MIRRORED BITS Connection .....	3.3
Figure 3.4	SEL-451 Port Settings for MIRRORED BITS Connection .....	3.4
Figure 3.5	SEL-2505 DIP Switch Settings for MIRRORED BITS Connection ....	3.5
Figure 3.6	TAR ROKA Command From an SEL-351 .....	3.5
Figure 3.7	SEL-3031 Linking Information Processors to Relays .....	3.6
Figure 3.8	SEL-3031 Port 1 Settings for Fast Messaging.....	3.7
Figure 3.9	SEL-351 Port Settings for Fast Messaging.....	3.8
Figure 3.10	Example AUTO Command Output.....	3.9
Figure 3.11	SEL-3031 Point-to-Multipoint Example .....	3.10
Figure 3.12	Radio Settings for Point-to-Multipoint.....	3.11
Figure 3.13	Port 1 Settings for Point-to-Multipoint.....	3.12
Figure 3.14	SEL-3530 RTAC DNP3 Settings .....	3.13
Figure 3.15	SEL-651R Communications Settings for P2MP .....	3.14
Figure 3.16	SEL-651R DNP Port Settings for P2MP .....	3.15
Figure 3.17	Setting up Collocated Antennas at a Repeater Location.....	3.16
Figure 3.18	SYNC Settings for Master Radio.....	3.18
Figure 4.1	Communications Menu.....	4.2
Figure 4.2	Serial Port Communications Parameters .....	4.3

Figure 4.3	Terminal Window Menu.....	4.4
Figure 4.4	Device Response to ID Command .....	4.4
Figure 4.5	Selection of Drivers.....	4.7
Figure 4.6	Update Part Number.....	4.8
Figure 4.7	New Setting Screen .....	4.8
Figure 4.8	Status Screen .....	4.10
Figure 4.9	Radio Strength and Channel Availability .....	4.11
Figure 4.10	RAD Command Response .....	4.24
Figure 4.11	Device Response to the STATUS Command .....	4.27
Figure 5.1	Example RAD Command .....	5.2
Figure 5.2	RBAD Generation .....	5.4
Figure C.1	SEL-3044 Encryption Card.....	C.1
Figure C.2	In-Band Data Packet Format .....	C.4
Figure C.3	Operation of the AES Encryption Function .....	C.5
Figure C.4	Encryption Card Location .....	C.7



# Preface

---

## Manual Overview

---

The SEL-3031 Serial Radio Transceiver manual includes the information needed to properly install and operate the product.

The scope of this manual includes specifications, installation, mechanical information, self-monitoring, and alarming.

An overview of each manual section and topics follows.

**Preface.** Describes the manual organization and conventions used to present information.

**Section 1: Introduction and Overview.** Describes the basic features and functions of the SEL-3031, and lists the specifications.

**Section 2: Installation.** Describes how to mount and wire the SEL-3031; illustrates wiring connections for various applications.

**Section 3: Job Done Examples.** Describes common SEL-3031 applications.

**Section 4: Settings and Commands.** Describes settings and commands for use with the SEL-3031.

**Section 5: Performance Monitoring, Testing, and Troubleshooting.** Lists common operating and troubleshooting questions.

**Appendix A: Firmware and Manual Versions.** Details differences between firmware versions. Provides a record of changes made to the manual.

**Appendix B: Firmware Upgrade Instructions.** Provides instructions for upgrading the firmware in the SEL-3031.

**Appendix C: SEL-3044 Encryption Card.** Describes how the encryption card operates to secure wireless data. Provides installation information.

## Safety Information

### Dangers, Warnings, and Cautions

This manual uses three kinds of hazard statements, defined as follows:

#### **DANGER**

Indicates an imminently hazardous situation that, if not avoided, **will** result in death or serious injury.

#### **WARNING**










Indicates a potentially hazardous situation that, if not avoided, **could** result in death or serious injury.

#### **CAUTION**

Indicates a potentially hazardous situation that, if not avoided, **may** result in minor or moderate injury or equipment damage.

## Safety Symbols

The following symbols are often marked on SEL products.

	 <b>CAUTION</b> Refer to accompanying documents.	 <b>ATTENTION</b> Se reporter à la documentation.
	Earth (ground)	Terre
	Protective earth (ground)	Terre de protection
	Direct current	Courant continu
	Alternating current	Courant alternatif
	Both direct and alternating current	Courant continu et alternatif
	Instruction manual	Manuel d'instructions

## Safety Marks

The following statements apply to this device.

### General Safety Marks

For use in Pollution Degree 2 environment.	Pour l'utilisation dans un environnement de Degré de Pollution 2.
Terminal Ratings Wire Materials Use copper conductors only.	Spécifications des bornes Type de filage Utiliser seulement conducteurs en cuivre.
Wire Size 12–26 AWG	Calibre de fil 12–26 AWG
Tightening Torque Terminal Blocks: 0.8 Nm (7 in-lb)	Couple de serrage Borniers : 0,8 Nm (7 livres-pouce)

### Other Safety Marks (Sheet 1 of 2)

<p><b>⚠ DANGER</b>                  Disconnect or de-energize all external connections before opening this device. Contact with hazardous voltages and currents inside this device can cause electrical shock resulting in injury or death.</p>	<p><b>⚠ DANGER</b>                  Débrancher tous les raccordements externes avant d'ouvrir cet appareil. Tout contact avec des tensions ou courants internes à l'appareil peut causer un choc électrique pouvant entraîner des blessures ou la mort.</p>
<p><b>⚠ WARNING</b>                  Have only qualified personnel service this equipment. If you are not qualified to service this equipment, you can injure yourself or others, or cause equipment damage.</p>	<p><b>⚠ AVERTISSEMENT</b>                  Seules des personnes qualifiées peuvent travailler sur cet appareil. Si vous n'êtes pas qualifiés pour ce travail, vous pourriez vous blesser avec d'autres personnes ou endommager l'équipement.</p>
<p><b>⚠ WARNING</b>                  Operator safety may be impaired if the device is used in a manner not specified by SEL.</p>	<p><b>⚠ AVERTISSEMENT</b>                  La sécurité de l'opérateur peut être compromise si l'appareil est utilisé d'une façon non indiquée par SEL.</p>
<p><b>⚠ WARNING</b>                  Atmospheric electrical charge accumulation can cause potential between the conductor and shield of the feedline, or cause lightning to strike an antenna. A lightning protector should be installed to prevent damage to equipment or injury to personnel.</p>	<p><b>⚠ AVERTISSEMENT</b>                  L'accumulation de charges électriques de type atmosphérique peut être la cause d'une différence de potentiel entre le conducteur et le blindage de la ligne d'alimentation ou peut attirer la foudre sur l'antenne. Un parafoudre devrait être installé pour prévenir les dommages à l'équipement ou les blessures au personnel.</p>

**Other Safety Marks (Sheet 2 of 2)**

<p><b>⚠ WARNING</b> Do not look into the fiber (laser) ports/connectors.</p>	<p><b>⚠ AVERTISSEMENT</b> Ne pas regarder vers l'extrémité des ports ou connecteurs de fibres pour laser.</p>
<p><b>⚠ WARNING</b> Do not look into the end of an optical cable connected to an optical output.</p>	<p><b>⚠ AVERTISSEMENT</b> Ne pas regarder vers l'extrémité d'un câble optique raccordé à une sortie optique.</p>
<p><b>⚠ WARNING</b> This device is shipped with default passwords. Default passwords should be changed to private passwords at installation. Failure to change each default password to a private password may allow unauthorized access. SEL shall not be responsible for any damage resulting from unauthorized access.</p>	<p><b>⚠ AVERTISSEMENT</b> Cet appareil est expédié avec des mots de passe par défaut. A l'installation, les mots de passe par défaut devront être changés pour des mots de passe confidentiels. Dans le cas contraire, un accès non-autorisé à l'équipement peut être possible. SEL décline toute responsabilité pour tout dommage résultant de cet accès non-autorisé.</p>
<p><b>⚠ CAUTION</b> Although the power level is low, concentrated energy from a directional antenna may pose a health hazard. Do not allow users to come closer than 23 cm (9 in) to the antenna when the transmitter is operating in indoor or outdoor environments in the 900-MHz band.</p>	<p><b>⚠ ATTENTION</b> Bien que le niveau de puissance soit bas, l'énergie concentrée d'une antenne directionnelle peut être un danger pour la santé. Ne pas autoriser les usagers à s'approcher à moins de 23 cm (9 po) de l'antenne quand l'émetteur est en opération dans un environnement intérieur ou extérieur dans la bande des 900-MHz.</p>
<p><b>⚠ CAUTION</b> The radio contains devices sensitive to electrostatic discharge (ESD). Undetectable permanent damage can result if you do not use proper ESD procedures. Ground yourself, your work surface, and this equipment before removing any cover from this equipment. If your facility is not equipped to work with these components, contact SEL about returning this device and related SEL equipment for service.</p>	<p><b>⚠ ATTENTION</b> La radio contient des circuits sensibles aux décharges électrostatiques (DES). Des dommages permanents non-décelables peuvent résulter de l'absence de précautions contre les DES. Raccordez-vous correctement à la terre, ainsi que la surface de travail et l'appareil avant d'en retirer un panneau. Si vous n'êtes pas équipés pour travailler avec ce type de composants, contacter SEL afin de retourner l'appareil pour un service en usine.</p>

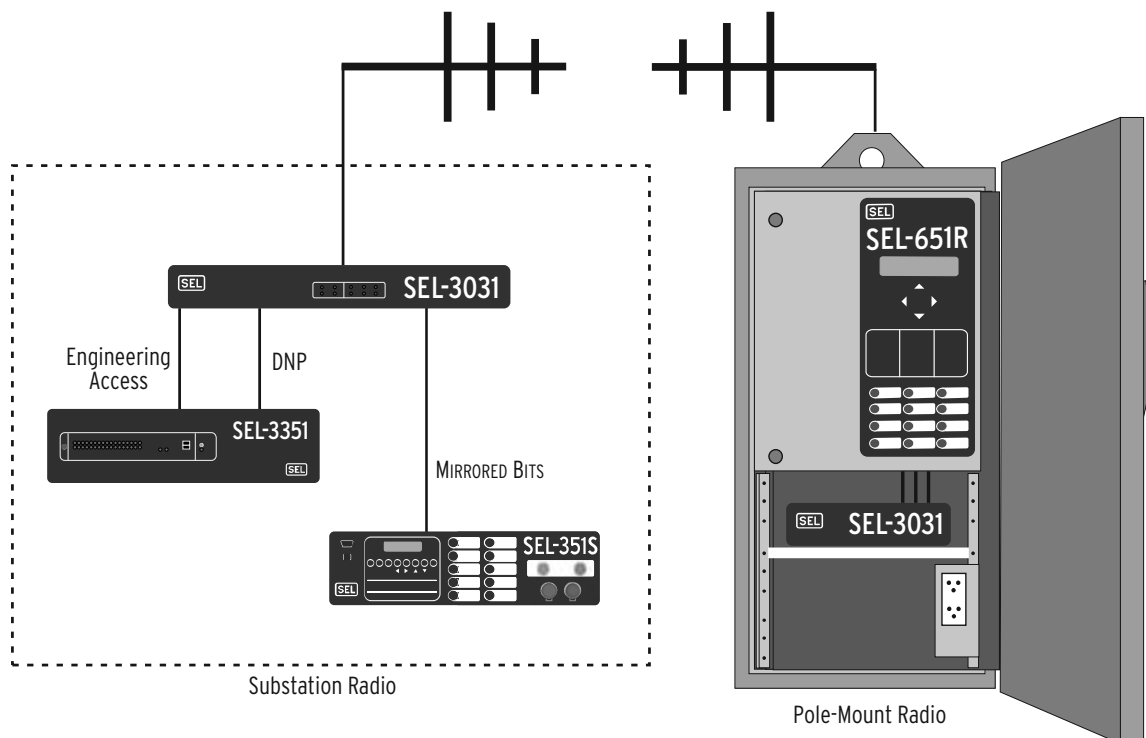
# Section 1

## Introduction and Overview

### Overview

The SEL-3031 is a 900-MHz, license-free, spread-spectrum radio. The radio operates in the ITU Region 2 ISM band of 902–928 MHz through the use of a fast frequency-hopping algorithm for noise immunity and long-distance operation.

The SEL-3031 prevents the need for multiple sets of radios or expensive dedicated fiber transmitting over long distances. *Figure 1.1* shows the flexibility of the SEL-3031 in providing DNP3 SCADA information, MIRRORING BITS<sup>®</sup> control for reclosing coordination, and engineering access to the SEL-651R Recloser Control.



**Figure 1.1 Point-to-Point Product Overview**

*Figure 1.2* shows the flexibility obtained when using the SEL-3031 in point-to-multipoint (P2MP) applications providing DNP3 or Modbus SCADA information from many remotes to one master.

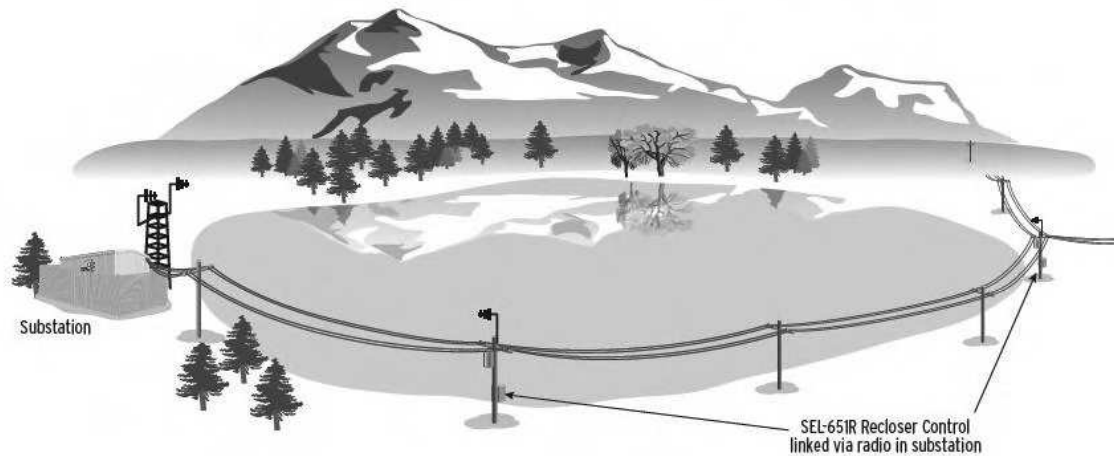


Figure 1.2 Point-to-Multipoint Product Overview

## Features, Benefits, and Applications

---

- **Dual Radio Operating Modes Provide Flexibility.** Supports point-to-point (P2P) radio operation for fast teleprotection, distribution automation, distributed generation, and economical backup protection. Apply point-to-multipoint (P2MP) radio operation for SCADA and other data-gathering from remote locations.
- **Three Ports in One Radio Reduce Costs.** Simultaneously communicates with as many as three independent ports and protocols via point-to-point radio operation.
- **Low Latency Enables Fast Control.** Transfers control commands with a typical 4.8 ms latency with SEL MIRRORED BITS<sup>®</sup> communications.
- **Strong Security Thwarts Attackers.** Protects critical data and repels malicious attacks with optional encryption card, using session authentication and strong 256-bit Advanced Encryption Standard (AES) technology.
- **Tough Radio Operates in Extreme Conditions.** Is designed, built, and tested for trouble-free operation in extreme temperature, electromagnetic interference, shock, and vibration conditions.
- **No Licensing Reduces Delays and Expenses.** Uses the license-free, 900-MHz ISM band for on-time, on-budget projects.
- **Mounting Options Simplify Installation.** Order your SEL-3031 in one of three different packages: rack-mount, wall-mount, and NEMA 3R prewired radio solution.

- **Multiple Protocols Satisfy Interconnection Requirements.** Communicate with industry-standardized byte-oriented protocols, such as DNP3, Modbus®, SEL MIRRORED BITS communications, IEEE C37.118 Synchrophasors, SEL Fast Messaging, and SEL ASCII.
- **Flexible Serial Port Options Match Integration Needs.** Order serial Port 1 as EIA-232, EIA-485, or optical fiber to easily connect to your existing devices.
- **Simple Settings Streamline Radio Commissioning.** Use ACSELERATOR QuickSet® SEL-5030 Software for all settings.
- **USB Management Port Conveniently Connects to PC.** Make settings changes, verify status information for proper installation, and verify radio performance without affecting the three serial channels.

## Models, Options, and Accessories

---

### Standard Features

- P2P and P2MP operation modes
- Three EIA-232 serial ports
- IRIG-B time code input
- Radio synchronization with collocated radios
- Power supply
  - Wall mount: 9–30 Vdc
  - Rack mount: 24–48 Vdc, 125/250 Vac or Vdc
- ACSELERATOR QuickSet software
- Protocol pass-through support
  - DNP3
  - Modbus
  - SEL MIRRORED BITS
  - SEL Fast Messaging
  - SEL ASCII
  - IEEE C37.118 Synchrophasors

### Optional Features

- One port EIA-485
- One port fiber-optic (SEL-2812 and SEL-9220 compatible)
- SEL-3044 Encryption Card
- Special frequencies for Brazil

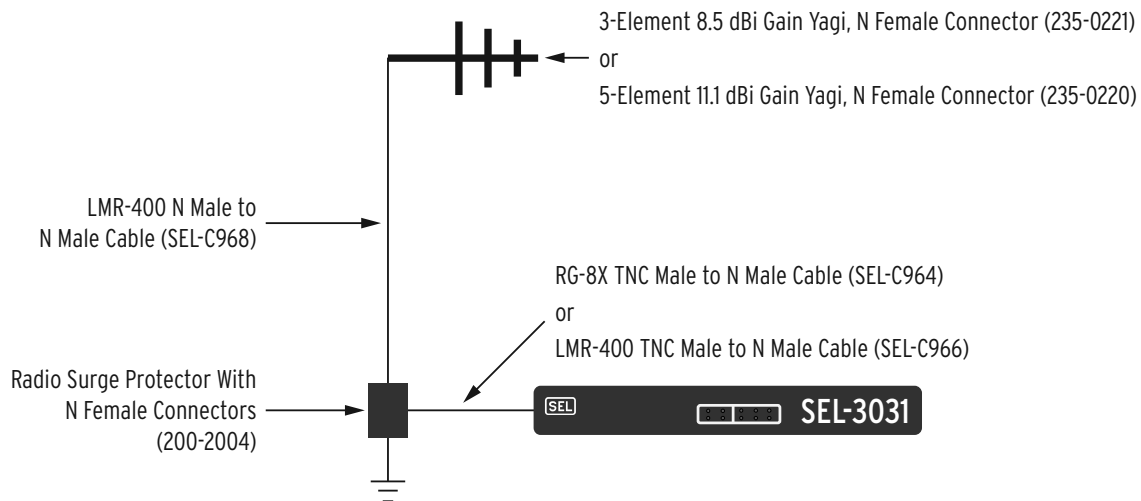
## Accessories

**Table 1.1 Radio Antenna and Cable Accessories**

Description	Part Number
<b>Feedline</b>	
RG-8X TNC Male to N Male Cable	SEL-C964
RG-8X TNC Male to TNC Male Cable	SEL-C965
LMR <sup>®</sup> -400 TNC Male to N Male Cable	SEL-C966
LMR-400 TNC Male to TNC Male Cable	SEL-C961
LMR-400 N Male to N Male Cable	SEL-C968
7/8" HELIAX <sup>®</sup> N Male to N Male Cable	SEL-C978
N Female to TNC Male Adapter	240-1809
<b>Antenna</b>	
Low-Profile 3 dBi Gain Omnidirectional, N Female Connector	235-0003
Indoor 8" Vertical, TNC Male Connector	235-0108
5-Element 11.1 dBi Gain Yagi, N Female Connector <sup>a</sup>	235-0220
3-Element 8.5 dBi Gain Yagi, N Female Connector <sup>a</sup>	235-0221
11-Element 14.15 dBi Gain Yagi, N Female Connector <sup>a</sup>	235-0222
Vertical 7.15 dBi Gain Omnidirectional, N Female Connector	235-0232
Vertical 9.15 dBi Gain Omnidirectional, N Female Connector	235-0233
<b>Antenna Mounting</b>	
Vertical Omnidirectional Mount for 14" Maximum Diameter Poles	240-0103
Yagi Mount for 14" Maximum Diameter Poles	240-0104
Mast Mount for Large Omnidirectional Antennas (1.3125" Maximum Diameter Antenna to 1.25" Maximum Diameter Mast)	240-0105
Mounting Bracket for Low-Profile Omnidirectional Radio Antennas	915900494
<b>Surge Protection</b>	
Radio Surge Protector With N Male Connectors	200-2004

<sup>a</sup> Comes equipped with pipe-mounting hardware.

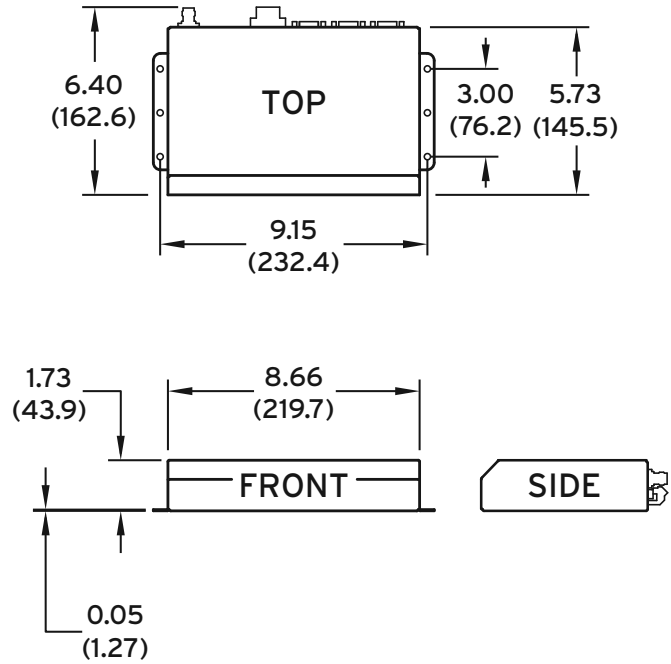




**Figure 1.3 Radio Antenna Connections**

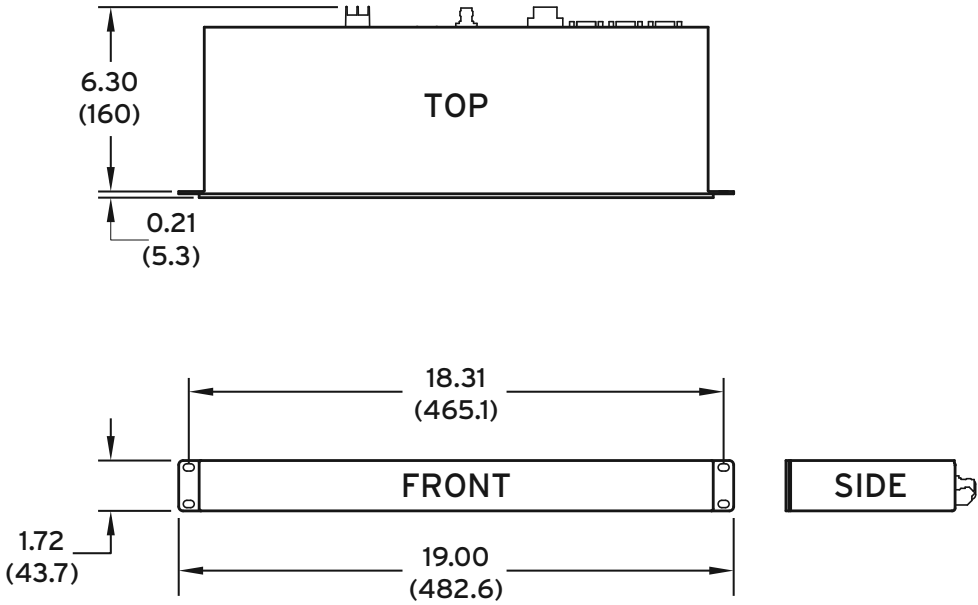
# Product Diagrams

## WALL-MOUNT CHASSIS



i9163b

## RACK-MOUNT CHASSIS



**LEGEND**  
 in  
 (mm)

Figure 1.4 SEL-3031 Dimensions

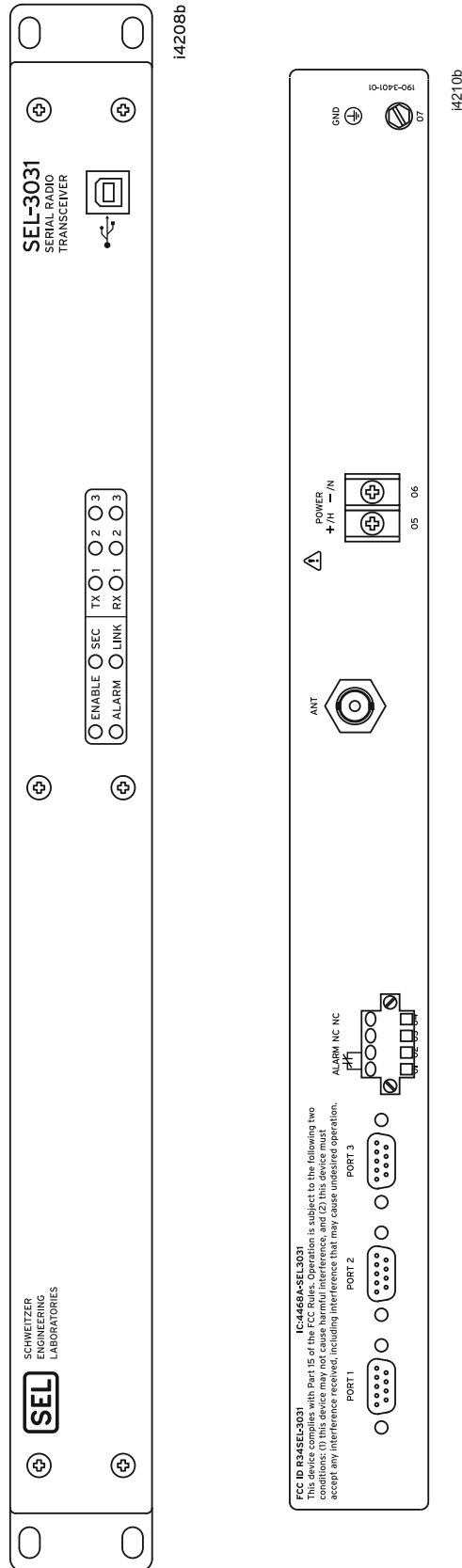
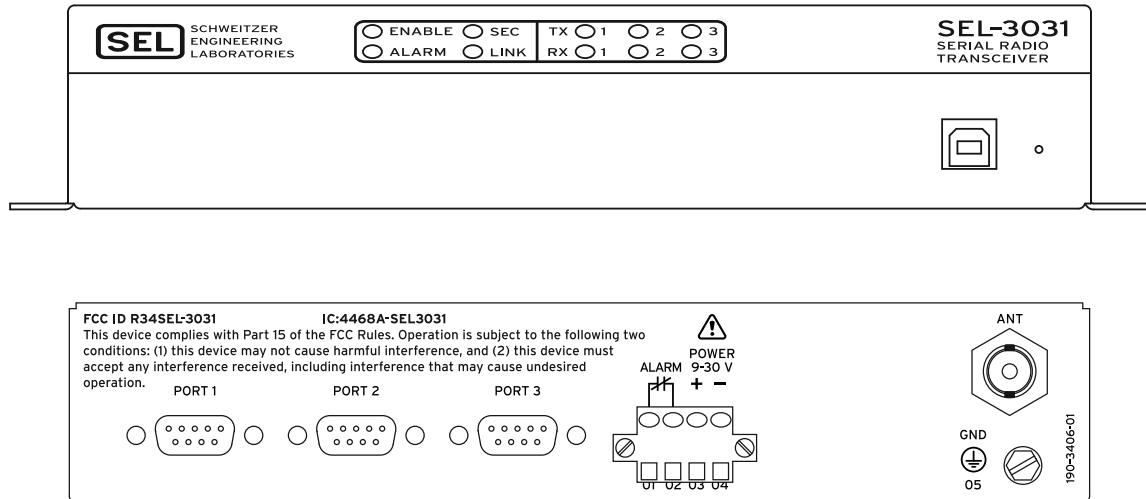


Figure 1.5 SEL-3031 Rack Mount (Front and Rear)



**Figure 1.6 SEL-3031 Wall Mount (Front and Rear)**

# Specifications

## Compliance

Designed and manufactured under an ISO 9001 certified quality management system  
 UL Listed to U.S. and Canadian safety standards (File E220228; NRAQ, NRAQ7)  
 SEP (SEL-3044 encryption card):  
 FIPS 140-2 Level 2 validated (historical, pending re-validation). FIPS certificate #1564 (consolidated certificate no. 0006).  
 Note that the current FIPS certificate is marked as historical. SEL is currently undergoing the FIPS re-validation process for the SEL-3044 card.  
 Also see *Table 1.2*.

## General

### Temperature Range

−40° to +85°C per IEC 60068-2-1 and 60068-2-2

### Operating Environment

Pollution Degree: 2  
 Relative Humidity: 5–95%, noncondensing  
 Maximum Altitude: 2000 m

### Dimensions

Wall Mount: 43.9 mm x 219.7 mm x 162.6 mm  
 (1.73 in x 8.66 in x 6.40 in)  
 Rack Mount: 43.7 mm x 482.6 mm x 160.0 mm  
 (1.72 in x 19.00 in x 6.3 in)

## Time-Code Input

### Port 2, Pins 4 and 6

Format: Demodulated IRIG-B  
 Input Impedance: 333 Ω  
 Accuracy: ±5 milliseconds

## Alarm Contact

### Form B Contact

(open when energized and passes diagnostics)

Operating Voltage: 250 Vdc or 190 Vac  
 Dielectric Test Voltage: 500 Vrms  
 Continuous Carry: 6 A

## Communications

### Communications Ports

#### Serial Port 1

Data Speed Without Encryption Card: 38400 bps (disables Port 2), 19200 bps, or 9600 bps

Data Speed With Encryption Card: 19200 bps (disables Port 2) or 9600 bps

EIA-232, EIA-485 (ordering option)

Connector: 9-Pin D-Subminiature

#### Fiber-Optic Ordering Option

Connectors: 2 ST (Tx and Rx)

Encoding SEL-2812/SEL-9220 Compatible

Wavelength: 850 nm multimode

Typical Tx Power: −13 dBm

Min. Rx Sensitivity: −29 dBm

Optical Budget: 16 dB

Compatible Fiber-Optic Core Diameter: 50, 62.5, or 200 μm

#### Serial Port 2, 3 Standard EIA-232

Data Speed Without Encryption Card: 19200 bps or 9600 bps

Data Speed With Encryption Card:	9600 bps
Connector:	9-Pin D-Subminiature

### Protocols

Modbus, DNP3, SEL MIRRORED BITS Communications (MB8), ACSELERATOR QuickSet SEL-5030 Software Support, SEL ASCII and Compressed ASCII, SEL Fast Messaging, IEEE C37.118 Synchronphasors

### Typical Latency

#### SEL-3031

MIRRORED BITS:	8.9 ms at 9600 bps 5.6 ms at 19200 bps 4.8 ms at 38400 bps
Standard:	4.9 ms at 9600 bps 4.3 ms at 19200 bps 3.8 ms at 38400 bps

#### SEL-3031 With SEL-3044 Encryption Card

MIRRORED BITS:	9.7 ms at 9600 bps 7.4 ms at 19200 bps
Standard:	5.7 ms at 9600 bps 5.3 ms at 19200 bps

### Radio

#### Transmitter

Frequency Band:	902–928 MHz ISM band
Modulation:	GFSK
Operating Mode:	Point-to-Point
RF Connector:	TNC
Power Output:	1 W (30 dBm) to 100 mW (20 dBm) in steps of 1 dBm
Channel Bandwidth:	250 kHz

#### Receiver

Sensitivity:	–97 dBm, –104 dBm with ARQ on
Bit Error Rate (BER):	<10 <sup>–6</sup> at –97 dBm
Distance:	32 km (20 mi), line of sight
Error Detection:	32-bit CRC

### Power Supply

#### Rated Supply Voltage

Wall-Mount Model:	12/24 Vdc
Low-Voltage Model:	24/48 Vdc
High-Voltage Model:	125/250 Vdc 110/240 Vac, 50/60 Hz

#### Input Voltage Range

Wall-Mount Model:	9–30 Vdc
Low-Voltage Model:	18–60 Vdc
High-Voltage Model:	85–275 Vdc; 85–264 Vac

#### Power Consumption

Wall Mount:	<5 W
Rack Mount:	<7 W

#### Power Consumption With SEL-3044 Card

Wall Mount:	<6 W
Rack Mount:	<8 W

### Type Tests

#### Communications Equipment Tests

IEEE 1613-2003

#### Environmental Tests

Enclosure Protection:	IEC 60529:2001
Vibration Resistance:	IEC 60255-21-1:1988 Class 1 Endurance Class 2 Response IEC 60255-21-3:1993 Class 2
Shock Resistance:	IEC 60255-21-2:1988 Class 1 shock withstand, bump Class 2 shock response
Cold:	IEC 60068-2-1:2007 –40°C, 16 hours

Damp Heat, Cyclic:	IEC 60068-2-30:2005 25–55°C, 6 cycles, 95% relative humidity
Dry Heat:	IEC 60068-2-2:2007 +85°C, 16 hours

**Dielectric Strength and Impulse Tests**

Dielectric (HiPot):	IEC 60255-5:2000 IEEE C37.90–2005
Impulse:	IEC 60255-5:2000 0.5 J, 5 kV

**RFI and Interference Tests**

**EMC Immunity**

Standard:	IEEE 1613, Class 2
Electrostatic Discharge:	IEC 61000-4-2:2008 8 kV contact discharge 15 kV air discharge IEEE C37.90.3–2001 8 kV contact discharge 15 kV air discharge
Radiated RF Immunity:	IEC 61000-4-3:2008 10 V/m IEEE C37.90.2–2004 35 V/m
Fast Transient, Burst Immunity:	IEC 61000-4-4:2004 4 kV @ 2.5 kHz, and 5.0 kHz for communications ports, power supply, alarm contacts
Surge Withstand Capability Immunity:	IEC 60255-22-1:2007 2.5 kV common-mode 1 kV differential-mode IEEE C37.90.1–2002 2.5 kV oscillatory, 4 kV fast transient for communications ports, power supply, alarm contacts
Conducted RF Immunity:	IEC 61000-4-6:2008 10 Vrms
Digital Radio Telephone RF Immunity:	ENV 50204-1995 Severity Level: 10 V/m at 900 MHz and 1.89 GHz

**EMC Emissions**

**Radiated Emissions**

FCC Part 15.247; ICES-001; RSS-247  
This device complies with Part 15 of the FCC rules. Operation is subject to the following two conditions:  
1. This device may not cause harmful interference, and  
2. This device must accept any interference received, including interference that may cause undesired operation.

FCC Part 15, Class A; ICES-003

Note: This equipment has been tested and found to comply with the limits for a Class A digital device, pursuant to Part 15 of the FCC Rules. These limits are designed to provide reasonable protection against harmful interference when the equipment is operated in a commercial environment.

This equipment generates, uses, and can radiate radio frequency energy and, if not installed and used in accordance with the instruction manual, may cause harmful interference to radio communications.

Operation of this equipment in a residential area is likely to cause harmful interference in which case the user will be required to correct the interference at his own expense.

FCC Section 15.21

Users manual for an intentional or unintentional radiator shall caution the user that changes or modifications not expressly approved by the party responsible for compliance could void the user's authority to operate the equipment.

**Table 1.2 Certifications by Country**

<b>Country</b>	<b>Authority</b>	<b>Reference</b>	<b>Part Number Starts With</b>
USA and Colombia	FCC	ID: R34SEL-3031	3031
Canada	IC	4468A - SEL3031	3031
Mexico	COFETEL	RCPSCE10 - 0574	3031
Brazil	ANATEL	ID: 2671-11-7001 EAN: (01)07898936514 02 8	30311



# Section 2


## Installation

---

### Overview

---

#### RF Exposure Notice

**RF EXPOSURE**  The SEL-3031 transmitter module is approved for use only with specific antenna, cable, and output power configurations that have been tested and approved for use. Modifications to the SEL-3031, the antenna system, or to the power output that have not been explicitly specified by the manufacturer are not permitted and may render the radio non-compliant with applicable regulatory authorities. The radio equipment described in this manual emits radio frequency energy. Professional installation is required. The antenna(s) for this transmitter must not be collocated or operated in conjunction with any other antenna or transmitter.

---

#### CAUTION

Although the power level is low, concentrated energy from a directional antenna may pose a health hazard. Do not allow users to come closer than 23 cm (9 in) to the antenna when the transmitter is operating in indoor or outdoor environments in the 900-MHz band.

#### FCC Part 15 Notice

---

**NOTE:** Operation is subject to the following two conditions:  
(1) this device may not cause interference, and (2) this device must accept any interference, including interference that may cause undesired operation of the device.

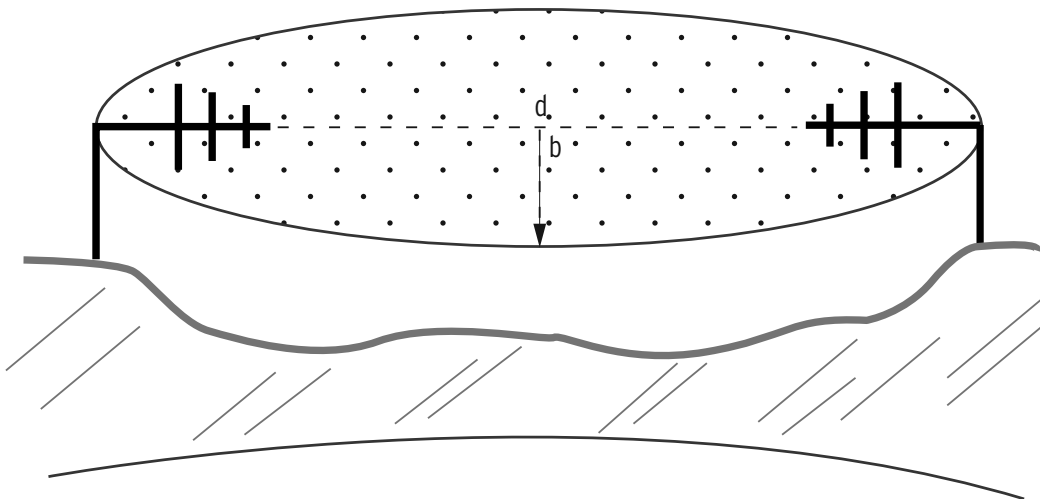
This equipment has been tested and found to comply with the limits for Class A digital devices, pursuant to FCC Part 15 Rules. These limits are designed to provide reasonable protection against harmful interference when the equipment is operated in a commercial environment. This equipment generates, uses, and radiates radio frequency energy, and if not installed and used in accordance with the instruction manual, may cause harmful interference to radio communications. Operation of this equipment in a residential environment is likely to cause harmful interference, in which case the user will be required to correct the interference at his/her own expense.

## Radio Path

Spread-spectrum radios operating in the 900-MHz ISM band are limited by line-of-sight. Radio line-of-sight is longer than optical line-of-sight because of the bending of the radio wave toward the surface of the earth. This radio horizon is typically 30 percent longer than the visual horizon. The longer the communications path, the taller the antennas must be to maintain the line-of-sight.

Obstructions in the line-of-sight will impact the performance of the radio, as the strongest radio signal is communicated directly along the radio line-of-sight.

The line-of-sight between two antennas is shaped like an ellipse (called the Fresnel zone). The point exactly halfway between the two antennas is the widest part of the ellipse, as shown in *Figure 2.1*. At 900 MHz and 304.8 m (1000 ft) apart, the Fresnel zone is 4.9 m (16 ft) in diameter. At 32 km (20 mi) apart, it is 51.8 m (170 ft) in diameter. Anything within the Fresnel zone will obstruct and reduce signal strength and availability (the ground, buildings, vegetation, etc.). *Table 2.1* depicts the maximum Fresnel zone diameter and path loss for some typical path distances.



**Figure 2.1 Fresnel Zone**

The formula used to calculate the widest distance of the Fresnel zone is as follows:

$$b = 17.32 \sqrt{d/(4f)}$$

where:

$b$  = radius of the Fresnel zone in meters

$d$  = distance between transmitter and receiver in kilometers

$f$  = frequency transmitted in GHz

**Table 2.1 Fresnel Zone Diameter**

900 MHz		
Distance Between Antennas	Fresnel Zone Diameter	Freespace Loss (dB)
304.8 m (1000 ft)	4.9 m (16 ft)	81
1.6 km (1 mi)	11.6 m (38 ft)	96
8 km (5 mi)	25.9 m (85 ft)	110
16 km (10 mi)	36.6 m (120 ft)	116
24 km (15 mi)	44.8 m (147 ft)	119
32 km (20 mi)	51.8 m (170 ft)	122
40 km (25 mi)	57.9 m (190 ft)	124

Obstructions in the Fresnel zone may also cause multipath interference because of reflective or refractive signals that may arrive at the receiver out-of-phase with the desired signal. The Fresnel zone should be 60 percent clear of obstructions for reliable radio communications. Large objects outside the Fresnel zone can cause reflections that may also affect reliable radio operation.

## Transmitted Signal

According to FCC and IC, the maximum transmitted power allowed out of an antenna is 36 dBm EIRP (Equivalent/Effective Isotropically Radiated Power). This is the amount of equivalent power transmitted equally in all directions using a theoretical isotropic antenna. EIRP takes into account the power output of the radio, line feed losses, and the gain of the antenna.

$$\text{EIRP} = \text{SEL-3031 Power Output (dBm)} - \text{line-feed loss (dB)} + \text{antenna gain (dBi)}$$

**NOTE:** Antenna/feedline configurations with net gains (antenna gain minus cable loss) greater than 8.0 dBi must have their output power limited to 341 mW. After setting the transmit power, measure the actual power.

Calculate the EIRP so you can set the proper output power on the SEL-3031 to stay in compliance with FCC and IC regulations; maximum power output from the antenna must not exceed 36 dBm. The SEL-3031 can transmit as much as 1 W or 30 dBm from the antenna port. If the calculated EIRP exceeds 36 dBm then you must reduce the power transmitted by the radio by reducing the transmit power setting TXPWR (see the TXPWR description in *Radio Settings on page 4.12* for more information). The radio is shipped with TXPWR set to 30 dBm by default and can be reduced to 20 dBm. Look up feedline loss in *Table 2.5*. After setting the transmit power, measure the actual power.

**NOTE:** This device has been designed to operate with the antennas listed in Table 2.2, and having a maximum gain of 14.1 dBi. Antennas not included in this list or having a gain greater than 14.1 dBi are strictly prohibited for use with this device. The required antenna impedance is 50 ohms. Antennas having a gain of greater than 6 dB must use a feedline with enough loss to remain compliant with the maximum 36 dBm EIRP or reduce the radio transmitted power accordingly.

For example, if you wanted to design a radio system to achieve a 32-km (20-mi) radio path and run at the highest allowed transmitted power, one way would be to use the SEL-3031 with 15.2 m (50 ft) of LMR 400, lightning arrestor, and the 5-Element Yagi with 11.1 dBi of gain. The radio would transmit 30 dBm, the feedline loss is 1.95 dB, lightning arrestor loss is 0.15 dB, and the antenna gain is 11.1 dBi. The result would be 39 dBm, which is 3 dBm higher than allowed by the FCC. You must reduce the radio transmit power setting TXPWR to 27 dBm. This would make your EIRP equal to 36 dBm. After setting the transmit power, measure the actual power.

**NOTE:** To reduce potential radio interference to other users, the antenna type and its gain should be so chosen that the equivalent isotropically radiated power (EIRP) is not more than that permitted for successful communication.

**Table 2.2 Antennas Permitted for Use With the SEL-3031**

Antenna Type	Maximum Allowed Gain
Yagi antenna	14.15 dBi or less
Omnidirectional antenna	9.15 dBi or less
Panel antenna	10.15 dBi or less

## Fade Margin

The fade margin determines the allowable signal loss between the transmitter and receiver. The fade margin is a function of system gains (transmitter power, receiver sensitivity, and antenna gain) and system losses (free space loss, losses because of the curvature of the Earth, and coaxial cable loss). Variations in temperature and humidity of the atmosphere with elevation causes the signals to bend more or bend less, resulting in fading at the receiver. The longer the path, the more likely deep fades will occur, requiring a greater fade margin. The formula to calculate free-space loss is shown below.

$$\text{Free Space Loss} = 92.4 + 20\log(f) + 20\log(d) \text{ dB}$$

where:

$f$  = frequency in GHz

$d$  = distance in km

Regional conditions also impact the probability of signal fade. Generally, mountainous terrain is more favorable, while tropical areas and those near large bodies of water are less favorable. One of the results from a site survey is the fade margin. A fade margin of 15 dB will yield good radio performance.

## Site Survey

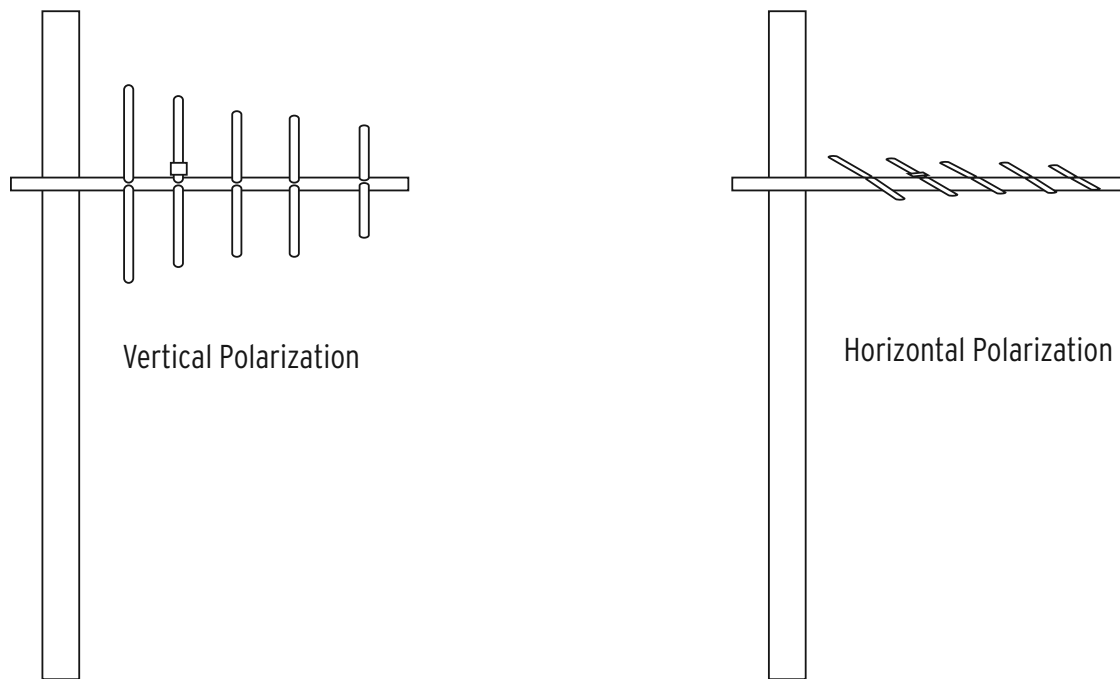
A line-of-sight path provides the most reliable transmission in all cases. As the distance increases the need for a clear path becomes more critical in creating a reliable, available radio link. If the radio path is short then a path study may not be needed. If you have a clear line-of-site to the other location without obstructions to the Fresnel zone (see *Radio Path*) then a path study is generally not needed. Longer distances may require a path study, a visual path inspection, and a spectrum analysis of the area to give a good indication of how high the antenna needs to be and how good the radio link will be.

## Radio Interference

The SEL-3031 shares a frequency spectrum with other services and FCC Part 15 (unlicensed) devices in ITU Region 2 (North, Central, and South America). This radio should not be used in Chile or Peru because of the regulations defining frequency allocation. Error-free communications may not be achievable in a given location, and some level of interference should be expected.

Consider the following points when setting up your system:

- Use directional Yagi antennas helps to narrow the radio path and provide the best path to prevent adjacent interference.
- If you suspect interference from a nearby, licensed system (such as a paging transmitter), it may be helpful to use horizontal polarization for all of the antennas in the network. Horizontal polarization can help improve signal availability but will likely increase the path loss. Horizontal polarization can provide an additional 20 dB of attenuation to interference because most other services use vertical polarization in these bands. *Figure 2.2* demonstrates antenna mounting for both vertical and horizontal polarization.



**Figure 2.2 Antenna Polarization**

- Multiple SEL-3031 systems can coexist in close proximity with minimal interference through the use of the built-in synchronism that allows you to synchronize collocated radios. The radios can be synchronized to transmit simultaneously to prevent interference from adjacent radios. See *Radio Settings on page 4.12* to learn more about synchronizing radios.
- When constant interference is present in a particular frequency zone, it may be necessary to “lock out” that zone from the SEL-3031 hopping pattern. The SEL-3031 includes a SKIP setting that removes interfered frequency zones from its hopping pattern. See *Table 4.5* for more information on the skip zones and information on how to set the SKIP setting. In the USA, Canada, Colombia, and Mexico, a maximum of six zones may be skipped, per regulatory agency rules. Check the regulatory requirements for other countries.
- The RF power output for all SEL-3031 radios in your system should be set to the lowest level necessary for reliable communications. This decreases the likelihood of causing unnecessary interference to nearby systems. See *Table 2.3* and *Table 2.4* for more information on the different frequency zones.

**Table 2.3 900-MHz Frequency Skip Zones (Part Numbers Starting With 30310)**

Zone 1	Zone 2	Zone 3	Zone 4	Zone 5	Zone 6	Zone 7	Zone 8
902.6–903.8	904.1–905.3	905.6–906.8	907.1–908.3	909.2–910.4	910.7–911.9	912.2–913.4	913.7–914.9
Zone 9	Zone 10	Zone 11	Zone 12	Zone 13	Zone 14	Zone 15	Zone 16
915.2–916.4	916.7–917.9	918.2–919.4	919.7–920.9	921.2–923.0	923.3–924.5	924.8–926.0	926.3–927.5

**Table 2.4 900-MHz Frequency Skip Zones for Brazil (Part Numbers Starting With 30311)**

Zone 1	Zone 2	Zone 3	Zone 9	Zone 10	Zone 11
902.6–903.8	904.1–905.3	905.6–906.8	915.2–916.4	916.7–917.9	918.2–919.4
Zone 12	Zone 13	Zone 14	Zone 15	Zone 16	
919.7–920.9	921.2–923.0	923.3–924.5	924.8–926.0	926.3–927.5	

## Feedlines

The feedline used with the antenna is as important as the antenna. Coaxial cables should have low attenuation and rated for outdoor use. Keep the feedline as short as possible to minimize signal loss between the radio and antenna. Times Microwave LMR<sup>®</sup>-400 or RG-8X A/U coax cables are preferred. If longer lengths or less loss is desired for the radio link then larger cable such as Andrew HELIAX<sup>®</sup> can be used. *Table 2.5* lists the signal losses (in dB) for the indicated lengths of each cable type at 900 MHz.

**Table 2.5 Length vs. Loss in Coaxial Cables at 900 MHz (Sheet 1 of 2)**

Cable Type	3.05 meters (10 feet)	12.24 meters (50 feet)	30.48 meters (100 feet)	91.44 meters (300 feet)
RG-8X A/U (SEL-C964)	0.70 dB	3.50 dB	7.0 dB	Unacceptable Loss
LMR-400 (SEL-C966)	Do not use	1.95 dB	3.90 dB	Unacceptable Loss
1/2-inch HELIAX	Do not use	1.15 dB	2.29 dB	6.87 dB
7/8-inch HELIAX	Do not use	0.64 dB	1.28 dB	3.84 dB

**Table 2.5 Length vs. Loss in Coaxial Cables at 900 MHz (Sheet 2 of 2)**

Cable Type	3.05 meters (10 feet)	12.24 meters (50 feet)	30.48 meters (100 feet)	91.44 meters (300 feet)
1-1/4-inch HELIAX	Do not use	Do not use	0.95 dB	2.85 dB
1-5/8-inch HELIAX	Do not use	Do not use	0.80 dB	2.4 dB

## Antenna System Ground

Antenna system grounding is not included in the scope of this manual. Please consult a radio systems engineer or other professional for advice on ground-system design. A well-designed system will minimize equipment damage and risk of electric shock to personnel.

### Chassis Ground



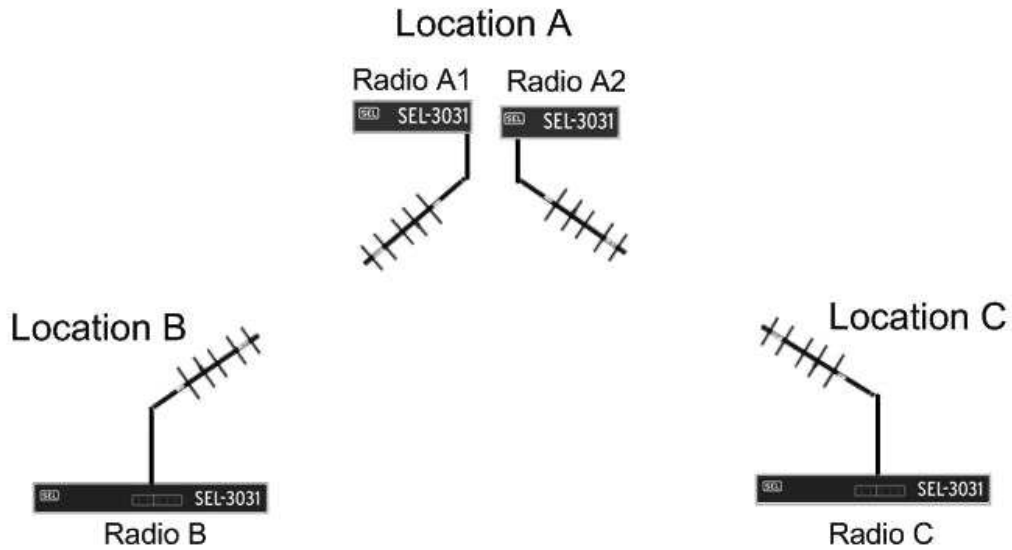
Connect the grounding terminal labeled **GND** on the rear panel to a rack frame ground or main station ground for proper safety and performance. Use 4 mm<sup>2</sup> (12 AWG) or heavier wire less than 2 m (6.6 ft) in length for this connection.

The ground connection should be made before the power connections.

## Collocated Antenna Systems

Many radio systems today consist of having multiple radios at one location. The multiple radios are needed for either directed P2P links, multiple data needing to reach different locations, or for a primary/backup scheme. In these cases, it is desirable to install the antennas on the same pole or within close proximity to reduce cost. Installing multiple antennas in close proximity operating on the same frequency band can cause large amounts of adjacent channel interference. This adjacent interference can greatly degrade the availability and dependability of each link. Take the example of two P2P links where two of the antennas are at one location and the links terminate at two different locations (see *Figure 2.3*).





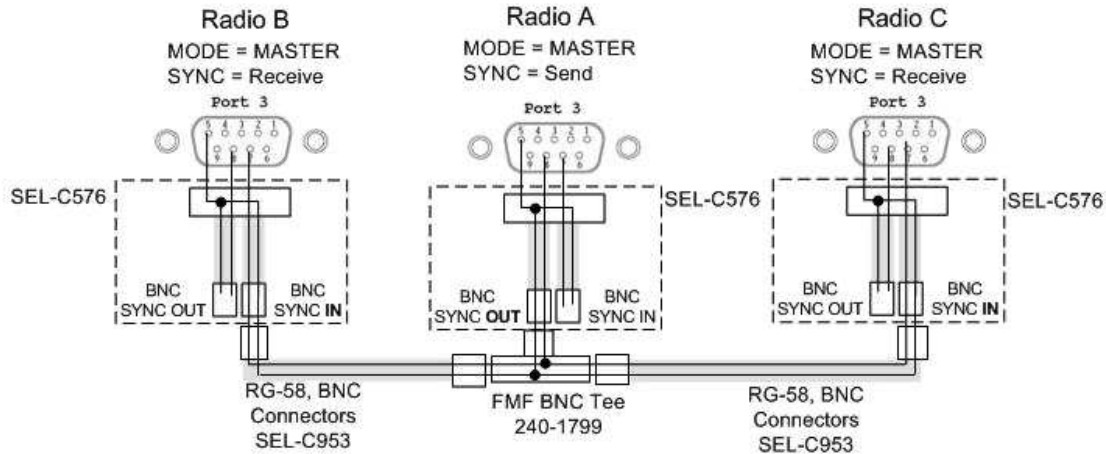
**Figure 2.3 Collocated Antennas With Two Radio Links**

In this example the radio links generally will work but at the cost of link availability and dependability. Even though the radio links are using different hop sequences, there can still be significant levels of adjacent channel interference because of the difference between the transmitted power on one antenna and the receive power on the adjacent antenna. For example, *Figure 2.3* displays two radio links with collocated antennas at Location A. If the antenna transmitting from Location A to C is transmitting at 36 dBm and at the same time the adjacent antenna on Radio A1 is receiving the signal from Location B at  $-70$ dBm, there is a 106 dBm signal difference between the two antennas. In this situation one will completely overpower the signal or greatly reduce the availability of the other. When radio transmit and receive timing cannot be coordinated to remedy this situation you need to either increase the distance separating the collocated antennas or use higher gain antennas that have narrower beams. The SEL-3031 has a better way to solve this problem by allowing collocated radios to synchronize their transmit and receive time slots and hop at exactly the same time. This will prevent the large signal difference from occurring and the collocated antennas can be placed within 2.4–3 m (8–10 ft) of each other. This technology is called SEL Hop-Sync™.

**NOTE:** If you have two or more synchronized radios and they lose synchronization the signal can be degraded to a point of loss of link. For mission critical applications make sure that the antennas are spaced far enough apart that if they lose synchronization that they will still operate with sufficient performance.

The radios are synchronized with one setting in each collocated radio and cabling between the radios. The radios use Pins 7 and 8 on Port 3 for synchronization. In this system you need to set each radio as a master. Set one radio to send the sync signal (SYNC SEND) and set the other radios to receive the sync signal (SYNC RECEIVE). If you have only two collocated radios you can use an SEL-C273A cable. This cable will have pins 7 and 8 sent between the radios that are crossed over. If you need to have more than 2 radios synchronized you will need to use cable SEL-C576. *Figure 2.4*

shows an example of how you would connect three collocated radios by using SEL-C576 cables along with BNC Tee and BNC coaxial cables. The BNC Tee and coaxial cables allow you to add more radios while utilizing one radio as the master sync radio (see *Section 3: Job Done Examples*).



**Figure 2.4 Three Collocated Synchronized Radios**

## Installing Collocated Antennas

SEL Hop-Sync™ technology provides the ability to install multiple radios at one location and mitigate the interference typically seen from adjacent antenna links. SEL Hop-Sync technology allows you to place antennas within feet of each other and still maintain a strong signal link. If the application for using the radios with SEL Hop-Sync technology is for non-critical data and the dependability is low then the antennas can be placed within 8–10 feet of each other and still provide proper operation.

The failure modes of the SEL Hop-Sync systems vary by application and by how many antennas are collocated. If you have a system with two collocated antennas using SEL Hop-Sync technology and one of the radios loses power then the system will still work properly. In the same condition, if you lose the synchronization cable between the two radios then they will interfere with each other and the radio signal will be degraded to the point of loss-of-link depending on the distance between radios. When using the radios in collocated applications with MIRRORING BITS or other critical communications, additional setup is needed to validate that if the radios become unsynchronized the radio links will still operate as expected with an acceptable level of dependability. Performing the following five steps helps to identify how far apart the antennas need to be to provide adequate link availability if synchronization is ever lost. This example follows the configuration shown on *Figure 2.4*.

- Step 1. Setup the three locations as shown in *Figure 2.3* and verify each link works independently.
- Step 2. Leave the link from Radio A1 to B on and turn the power off on Radio A2 and C.

- Step 3. Interrogate Radio A1 and issue the **RAD** command to retrieve the RSSI (Receive Signal Strength Indication) value.

---

**NOTE:** Always do Step 2 on the link that is either the longest distance or has the worst RSSI value for the system.

- Step 4. Turn off the power on Radio B. Turn on the power to **ONLY** Radio A1 and A2.

- Step 5. Set the settings in Radio A2 to link with Radio A1. Interrogate Radio A1 and retrieve the RSSI. The difference between the RSSI value in Step 3 and Step 5 needs to be equal to or less than 24 dBm.

If the difference is greater than 24 dBm then move the antenna on A2 and repeat Step 5. If the antenna separation needed to achieve 24 dBm exceeds what is practical for installation, then try one or all of the items below to improve the adjacent interference.

You can achieve a higher availability with collocated antennas when unsynchronized by:

1. Reduce the transmit power on the collocated radio if the adjacent link has a much higher signal strength with adequate fade margin.
2. Change your **SKIP** settings on one radio so the radio pairs hop at a farther distance apart on the ISM band (see *Radio Settings on page 4.12*).
3. With two located antennas, polarize one radio opposite of the other.

---

**NOTE:** If you have two collocated links aimed to exactly same location then you should polarize both vertically.

4. Change out the collocated antennas with higher gain antennas with a narrower beam and lower side angle profile.

# Connections

## Rear-Panel Connections

The physical layout of the SEL-3031 connections is shown in *Figure 2.5*.



**Figure 2.5** Wall-Mount and Rack-Mount Rear Connections

## Power Connections

The **POWER** terminals on the rear panel (labeled **+/H** and **-/N**) must connect to the correct supply voltage. The supply voltage range is located on the serial label. The wall-mount configuration accepts only 9–30 Vdc. The rack-mount configuration accepts 24–48 Vdc or 125/250 Vac or Vdc. Check the serial label for power supply information.

Do not apply power to the SEL-3031 without having a proper 50- $\Omega$  load on the antenna port. If you do not have the proper 50- $\Omega$  load connected, the radio antenna port will shut off, the alarm contact will pulse, and the **ALARM** LED will illuminate. This functionality protects the radio circuitry and indicates an antenna or cable failure. The **POWER** terminals on the rack-mount version are isolated from chassis ground. The **POWER** terminals on the wall-mount version are not isolated from chassis ground. Use 2.5 mm<sup>2</sup> (14 AWG) size wire to connect to the **POWER** terminals on the rack mount. Place an external circuit breaker or switch no more than 3 m (10 ft) from the equipment. The circuit breaker (or equivalent approved disconnect device appropriate for the country of installation) must comply with IEC 60947-1 and IEC 60947-3, be identified as the disconnect device for the equipment, and be located near the equipment. This disconnect device must interrupt both the hot (**+/H**) and the neutral (**-/N**) power leads. The maximum current rating for the power disconnect circuit breaker or overcurrent device (fuse) must be 20 A. An internal power supply fuse protects the operational power supply. Be sure to use fuses that comply with IEC 60127-2.

## Lightning Protection

### **WARNING**

Atmospheric electrical charge accumulation can cause potential between the conductor and shield of the feedline, or cause lightning to strike an antenna. A lightning protector should be installed to prevent damage to equipment or injury to personnel.

Mounting the antenna on an equipment building roof or tower is safest because the potential rise on the outside of either of these structures will approximately equal the potential on the inside. A lightning protector (Radio Surge Protector, SEL part number 200-2004) should be used to equalize the difference in potential that can occur between the center conductor and the shield of the coaxial cable between the antenna and the radio. The higher the antenna is mounted on a support structure, the greater the probability of equipment damage resulting from a lightning strike.

In all surge-protector applications, you should mount the surge protector at the building or enclosure entrance, and ground the surge-protector body. Ground the radio to the same point as the surge-protector ground to avoid ground-rise-potential damage.

When using the surge protector, order an additional SEL-C964 or SEL-C966 cable and place this cable between the SEL-3031 and the surge protector. Because the distance varies from the SEL-3031 to the surge protector, be sure to specify this cable at approximately the correct length (plus 10 to 20 percent for installation variability).

## Grounding (Earthing) Connections



You must connect the ground terminal labeled **GND** to a rack frame or switchgear ground for proper safety and performance. Use 2.5 mm<sup>2</sup> (14 AWG) wire less than 2 m (6.6 ft) in length for the ground connection.

## Serial Ports

Because all ports (1, 2, and 3) are independent, you can communicate to any combination simultaneously. All EIA-232 ports accept DB-9 male connectors. The serial port EIA-485 option for Port 1 is also a DB-9 male connector. If Port 1 is ordered with the EIA-485 option the product will ship with a DB-9-to-terminal adapter to easily wire to EIA-485 systems. Port 2 includes the IRIG-B time-code signal input (see *Table 2.8*). SEL offers fiber-optic transceivers or fiber-optic port options on Port 1 (SEL-2812 and SEL-9220 compatible fiber-optic) for connecting devices at distances over 15 meters (50 feet) where copper cable is not appropriate. The SEL-2800 family of transceivers provides fiber-optic links between devices for electrical isolation and longer distances, overcoming the limitations of electrical EIA-232 interfaces. Contact SEL for further information on these products.

## Front-Panel Jumpers

The front panels of the rack- and wall-mount configurations contain two jumpers. Access to the jumpers is different for each configuration. Note that jumper number 1 (JMP1) is for factory use only and should not be installed.

### Wall-Mount Chassis Jumper Access

From the front of the wall-mount configuration, remove the four screws located on the sides of each corner. Use a Torx® T15 size screwdriver to remove the four screws. Slide the back cover up and to the back of the unit to reveal the front jumpers. You do not need to remove the ribbon cable to change jumpers. The jumpers are located to the left of the USB connector.

### Rack-Mount Chassis Jumper Access

From the front of the rack-mount configuration, remove the front panel by loosening the six screws and removing the front panel. You will find the jumpers to the left of the USB connection.

## Password Jumper

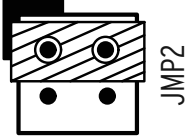
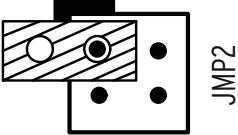
The SEL-3031 contains three levels of passwords to access and set the radio. The Level 1 password is for read access and the Level 2 password is for write access. The CAL level password moves from Access Level 2 to Access Level C (see *Access Level C on page 4.19* for more information regarding the Access Level C). The default passwords that are shipped with the SEL-3031 are shown in *Table 2.6*. Do not leave factory-default passwords in the product. See *PASSWORD Command on page 4.21* for more information on setting passwords.

**Table 2.6 Default Passwords**

Access Level	Password
1	OTTER
2	TAIL
CAL	CLARKE

If necessary, you can disable passwords by installing a jumper. Refer to *PASSWORD Command on page 4.21* for information on properly disabling and changing passwords.

**Table 2.7 Password Jumper Position**

Password Enable/Disable	Jumper Position
<p>Jumper Installed (Password Disabled) The jumper installed disables the passwords.</p>	
<p>Jumper Removed (Default) The SEL-3031 ships by default with passwords enabled.</p>	

## IRIG-B Time-Code Input

The SEL-3031 accepts a demodulated IRIG-B time signal to synchronize the internal clock with an external time source. IRIG-B is available on Port 2 utilizing Pins 4 and 6 for time communications. The SEL-3031 supports the IRIG-B002 standardized time format.

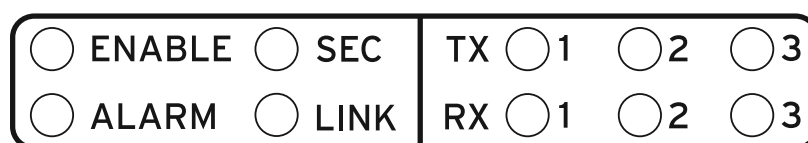
**Table 2.8 Communications Cables for Time and Communications Connections**

EIA-232 Serial Port	Connect to Device	SEL Cable No.
Port 2	IRIG-B BNC with time only	C256
	SEL communications processors and computing platform data with IRIG-B <sup>a</sup>	C387
	IRIG-B only from DB-9 on SEL-2407 <sup>®</sup>	C388

<sup>a</sup> If connecting to an SEL communications processor you must turn the 5V\_EN Global setting in the SEL-3031 to OFF.

## Front-Panel Indicators

The SEL-3031 has ten front-panel LED indicators. *Table 2.9* further describes these indicators that display the current status of the radio. The **LINK** LED indicates when the SEL-3031 has properly connected to another SEL-3031. The **SEC** LED deals with the SEL-3044 Encryption Card. See *Appendix B: Firmware Upgrade Instructions* for more information on using this card.



**Table 2.9 Front-Panel Status Indicator LEDs**

Label	Color	Description
ENABLE	Green	All self-tests are passing and unit is operational
ALARM	Red	ON: Self-test failure detected Flashing: Antenna failure
SEC	Green	ON: Encryption card detected and wireless data secured Flashing: Encryption card detected and in RESET OFF: No encryption card present or card failed
LINK	Green	Communications link established between master and remote radio
TX 1, 2, 3	Green	Serial data received by the port and transmitted out of the radio
RX 1, 2, 3	Red	Radio data received and transmitting out of serial port

## Communications

### Serial Ports

Table 2.10 shows the physical interfaces of the SEL-3031. Several options are provided for Port 1 physical interfaces, including EIA-232, EIA-485, and fiber.

**Table 2.10 SEL-3031 Port Description**

Port	Communications Interface	Location
Port 1	EIA-232, EIA-485, or fiber	Rear (Port 1 has three ordering options)
Port 2	EIA-232	Rear
Port 3	EIA-232	Rear
USB	USB 1.1	Front (management port)

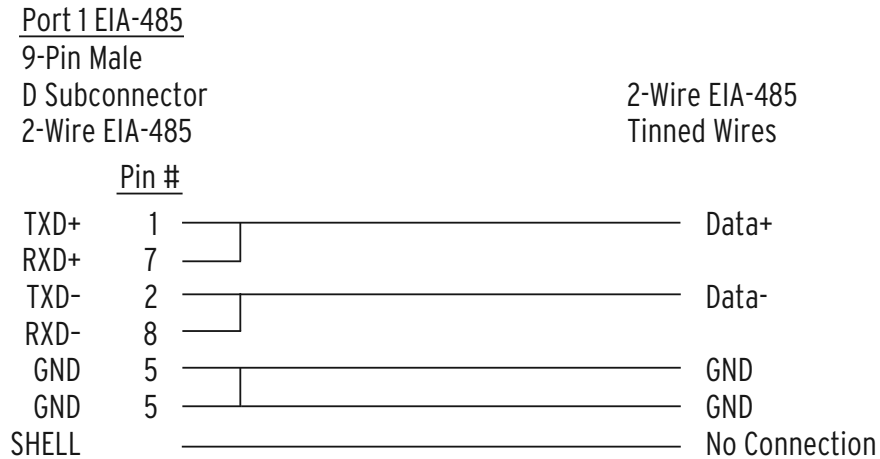
### Serial (EIA-232 and EIA-485)

Use the EIA-232 port for communications distances of  $\leq 15.2$  m (50 ft) in low-noise environments. Use the optional EIA-485 Port 1 for communications of  $\leq 1200$  m (3937 ft) maximum distance (to achieve this performance, ensure proper line termination at the receiver).

If Port 1 is an EIA-485 connection, there are two types of connections that will work on multidrop systems. Table 2.11 shows the standard pinout of a recommended four-wire EIA-485 connection. If your system only works on a two-wire EIA-485 connection, then you will need to connect Pins 1 and 7 together and Pins 2 and 8 together.

Figure 2.6 shows how to wire this configuration.





**Figure 2.6 SEL-C693 Cable: Two-Wire EIA-485 Connections**

## Fiber-Optic Serial Port

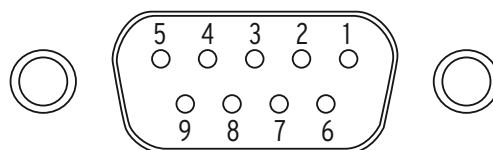
Order the fiber-optic option for Port 1 for safety and long-distance communications as far as 4 km (2.5 mi). The fiber-optic port is an SEL-2812-compatible device that can connect directly to any SEL-2812-compatible device or SEL-2812 Fiber-Optic Transceiver, using multimode fiber-optic cable with a core diameter of 50 to 200 μm. When working with this device, observe the following safety precautions:

### WARNING

- Do not look into the fiber (laser) ports/connectors.
- Do not look into the end of an optical cable connected to an optical output.
- Do not perform any procedures or adjustments that this instruction manual does not describe.
- During installation, maintenance, or testing of the optical ports, use only test equipment qualified for Class 1 laser products.
- Incorporated components, such as transceivers and laser emitters, are not user serviceable. Return units to SEL for repair or replacement.

## Port Connector and Communications Cables

Figure 2.7 shows the EIA-232 and EIA-485 DB-9 connector pin numbering for the SEL-3031.



**Figure 2.7 EIA-232 and EIA-485 DB-9 Connector Pin Numbers**

Table 2.11 shows the pin function of the serial ports.

**Table 2.11 SEL-3031 Port Description**

Pin	Port 1 EIA-232	Port 2 EIA-232	Port 3 EIA-232	Port 1 EIA-485
1	+5 Vdc	+5 Vdc	+5 Vdc	TX+
2	RXD	RXD	RXD	TX-
3	TXD	TXD	TXD	N/C
4	N/C	IRIG+	N/C	N/C
5	GND	GND	GND	GND
6	N/C	IRIG-	N/C	N/C
7	RTS	RTS	SYNC IN	RX+
8	CTS	CTS	SYNC OUT	RX-
9	N/C	N/C	N/C	N/C

## Cleaning

Use care when cleaning the SEL-3031. Perform the following steps:

- Step 1. Use a mild soap or detergent solution and a damp cloth to clean the chassis.
- Step 2. Be careful cleaning the front and rear panels because a permanent plastic sheet covers each panel.

Do not use abrasive materials, polishing compounds, or harsh chemical solvents (such as xylene or acetone) on any surface.

## Cables

<u>SEL-3031</u>			<u>PC Device</u>	
9-Pin Male			9-Pin Female	
Subminiature "D" Connector			Subminiature "D" Connector	
<u>Pin</u>				<u>Pin</u>
<u>Func.</u>	<u>Pin #</u>		<u>Pin #</u>	<u>Func.</u>
RXD	2	ORANGE	2	RXD
TXD	3	RED	3	TXD
GND	5	BLUE/SHIELD	5	GND
RTS	7	GREEN	7	RTS
CTS	8	WHITE	8	CTS

NOTE: For best results, limit the cable length to 15 m (~50 ft)

**Figure 2.8 SEL-C245A Cable: SEL-3031 to Computer**

<u>SEL-3031</u>			<u>DTE Device</u>	
9-Pin Male			No IRIG	
Subminiature "D" Connector			9-Pin Male	
			Subminiature "D" Connector	
<u>Pin</u>				<u>Pin #</u>
<u>Func.</u>	<u>Pin #</u>		<u>Pin #</u>	
RXD	2	ORANGE	2	
TXD	3	RED	3	
GND	5	BLUE/SHIELD	5	
RTS	7	GREEN	7	
CTS	8	WHITE	8	

NOTE: For best results, limit the cable length to 15 m (~50 ft)

**Figure 2.9 SEL-C285 Cable: SEL-3031 to DTE Device (SEL Relays)**

SEL-3031  
9-Pin Male  
Subminiature "D" Connector

SEL Communications Processor  
With IRIG  
9-Pin Male  
Subminiature "D" Connector

<u>Pin #</u>		<u>Pin #</u>
1	_____	1
2	_____	2
3	_____	3
4	_____	4
5	_____	5
6	_____	6
7	_____	7
8	_____	8
9	_____	9

NOTE: For best results, limit the cable length to 15 m (~50 ft)

### CAUTION

You must turn off the +5 V on Pin 1 of the SEL-3031 when connecting to a communications processor.

**Figure 2.10 SEL-C387 Cable: SEL-3031 to SEL Communications Processor With IRIG-B**

SEL-3031  
9-Pin Male  
"D" SUB CONNECTOR  
DB-9-P

SEL-3031  
9-Pin Male  
"D" SUB CONNECTOR  
DB-9-P

CABLE: 9 Conductor 22 AWG 7/30 Tinned Copper with PVC Jacket  
(Shielded: Alpha 1298C or equal; Unshielded: Alpha 1179 or equal)

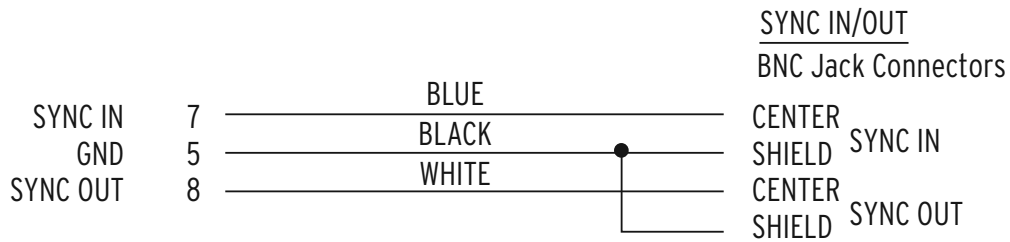
<u>Pin</u>	<u>Func.</u>	<u>Pin #</u>		<u>Pin #</u>	<u>Pin</u>	<u>Func.</u>
	RXD	2	ORANGE	3	RXD	
	TXD	3	RED	2	TXD	
	GND	5	BLUE/SHIELD	5	GND	
	SYNC IN	7	GREEN	8	SYNC IN	
	SYNC OUT	8	WHITE	7	SYNC OUT	
	SHELL		SHIELD		NO CONNECTION	

**Figure 2.11 SEL-C273A Cable: SEL-3031 Repeater and Synchronizing Cable**

SEL-3031  
9-Pin Male  
Subminiature "D" Connector

DTE Device  
9-Pin Female  
Subminiature "D" Connector

Pin	Func.	Pin #		Pin #	Pin	Func.
+5Vdc		1	BROWN	1	+5Vdc	
RXD		2	ORANGE	2	RXD	
TXD		3	RED	3	TXD	
GND		5	SHIELD	5	GND	



NOTE: For best results, limit the cable length to 15 m (~50 ft)

**Figure 2.12 SEL-C576 Cable: Synchronizing Cable for SEL-3031**

## USB Interface

The SEL-3031 uses a standard USB Type-B interface for the management port. The USB interface is used for settings management, initial radio installation, and reporting data from long-term radio statistics. The management port may be used while the SEL-3031 is in service without disrupting the radio communications. To use this interface, plug a USB Type-B cable into the radio and plug the other end into your PC. This will automatically prompt your PC to install a USB-to-serial driver that creates a virtual serial port. The virtual serial port needs to be set to 9600 bps, 8 data bits, 1 stop bit, and no parity to properly communicate with the SEL-3031. This virtual serial port can now be used with ACSELERATOR QuickSet® SEL-5030 Software to help set and view settings and obtain report information.



**Figure 2.13 USB Interface**

Preliminary Copy—Subject to Change

**This page intentionally left blank**

# Section 3

## Job Done Examples

---

### Overview

---

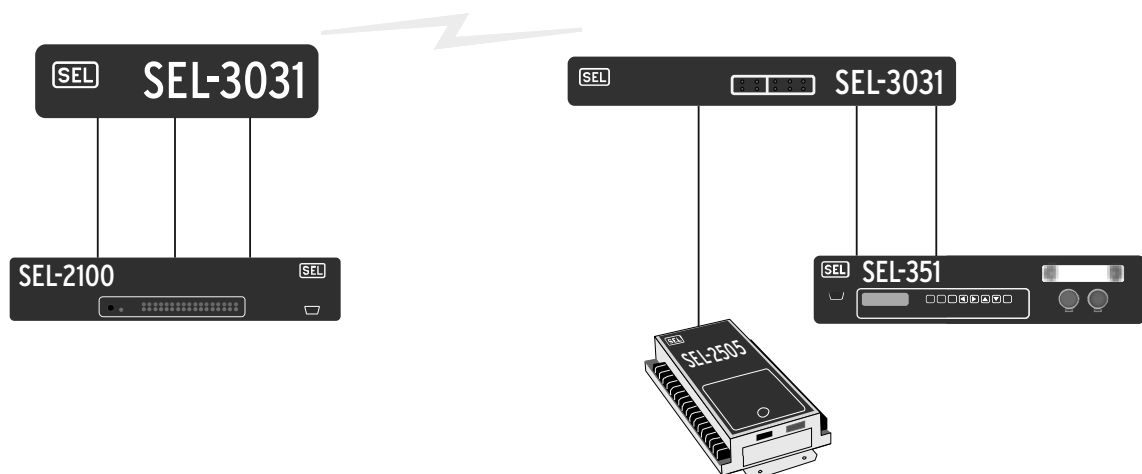
This section has four job done examples of how to easily set up the SEL-3031 for common applications. This section assumes you have established a radio link. If you are having problems setting up the radio link, refer to *Section 2: Installation* and *Section 5: Performance Monitoring, Testing, and Troubleshooting* for more information.

This section contains four Job Done examples for the following applications.

- *High-Speed Teleprotection or Control With MIRRORRED BITS Communications*
- *Using an SEL Information Processor to Collect Relay Status and Measurements*
- *Setting Up a Point-to-Multipoint Link Using DNP3 SCADA Protocol*
- *Configuring Collocated Antennas Using SEL Hop-Sync Technology*

### High-Speed Teleprotection or Control With MIRRORRED BITS Communications

---



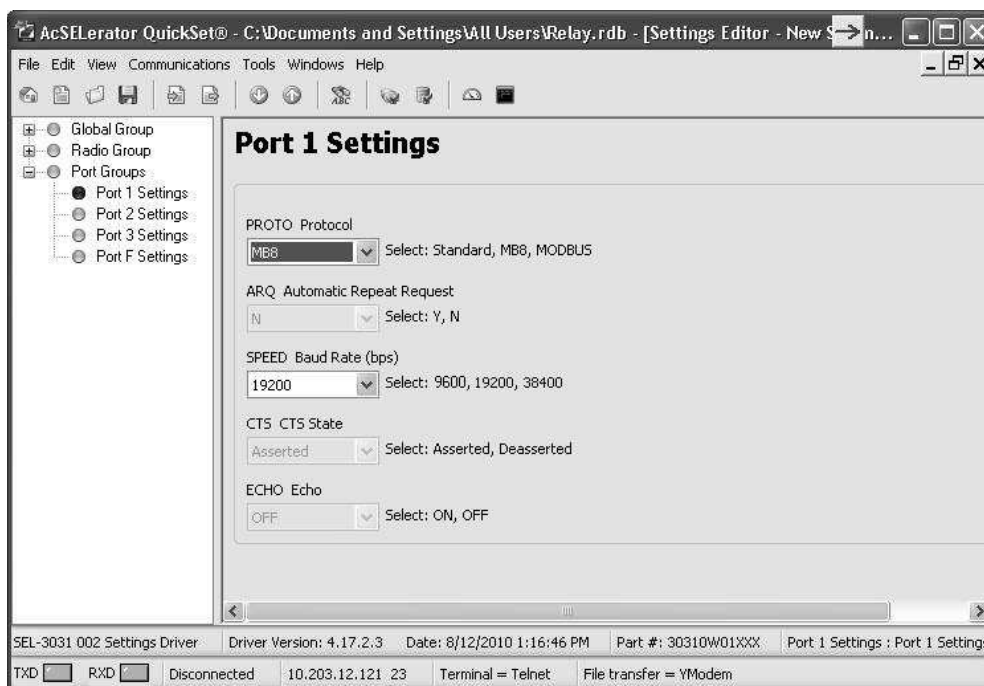
**Figure 3.1** SEL MIRRORRED BITS Connection Example

The SEL-3031 can handle as many as three connections of MIRRORED BITS<sup>®</sup> simultaneously over one radio link. For this example, there are three MIRRORED BITS channels over the SEL-3031. This example shows you how to set the radio and set different end devices to properly use the radio as a MIRRORED BITS link.

## SEL-3031 MIRRORED BITS Settings

For *Figure 3.2*, we set Port 1 on both SEL-3031 devices as a MIRRORED BITS connections.

On each radio, set the following settings on the Port 1 settings.



**Figure 3.2 SEL-3031 Port Settings for MIRRORED BITS Connection**

The SEL-3031 makes it very simple to set a MIRRORED BITS connection. Set the PROTO setting to MB8 to make it a MIRRORED BITS port. The SEL-3031 without an encryption card has data rate of 9600, 19200, or 38400 bps (8, N, 1). Setting the speed to 38400 provides the lowest latency at the cost of disabling Port 2. Port 3 can still be used for data at 9600 or 19200 bps speeds.

On Port 1 on each radio, install an SEL-C285 cable to the IED device. As an alternative, the SEL-3031 can be ordered with a fiber-optic serial port that works with SEL-2812 transceivers. If you use the fiber-optic port on the SEL-3031, the IED connection needs to be an SEL-2812MR Fiber-Optic Transceiver.



## SEL-351, SEL-311, and SEL-700 Series MIRRORED BITS Settings

The required settings for the SEL-351 are shown below. These settings are similar to all of the SEL-351, SEL-311, and SEL-700 series of relays. To establish a communications link via the radio, the most critical settings are PROTO, SPEED, RTSCTS, RXID, and TXID.

```
=>SH0 P 2 <Enter>
Port 2

PROTO = MB8A
SPEED = 19200   RTSCTS= N       RBADPU= 60       CBADPU= 1000
RXID = 1       TXID = 2       RXDFLT=XXXXXXXX
RMB1PU= 1      RMB1DO= 1      RMB2PU- 1      RMB2DO= 1
RMB3PU= 1      RMB3DO= 1      RMB4PU- 1      RMB4DO= 1
RMB5PU= 1      RMB5DO= 1      RMB6PU- 1      RMB6DO= 1
RMB7PU= 1      RMB7DO= 1      RMB8PU- 1      RMB8DO= 1
```

**Figure 3.3 SEL-351 Port Settings for MIRRORED BITS Connection**

The SEL-3031 allows you to set Port 1 to 9600, 19200, or 38400 bps (8, N, 1). If the SEL-3044 Encryption Card is used, the data rate changes to 9600 or 19200 bps (8, N, 1).

Set PROTO equal to MB8x, where x equals A or B depending on which MIRRORED BITS channel is used.

**NOTE:** This setting is slightly different in the SEL-2100 Logic Processor, SEL-3530 Real-Time Automation Controller (RTAC), and SEL-321 Relay.

Set SPEED equal to 9600, 19200, or 38400 bps (or 9600/19200 if the encryption card is installed).

Set RTSCTS (hardware handshaking) to N to disable that option.

Set the RXID equal to one and TXID equal to two at the master end. At the remote end, set the RXID equal to two and the TXID equal to one. The relays use these addresses to prevent a relay from receiving messages from a secondary MIRRORED BITS device if the paths are accidentally connected wrong. The relay only receives messages sent by a relay with the matching transmit address and vice versa.

To connect the relay to the radio, use an SEL-C285 cable (DB-9 male-to-DB-9 male straight-through). If complete electrical isolation is desired between the radio and a relay EIA-232 communications port, use the SEL-2812MR Fiber-Optic Transceiver and fiber-optic cable to connect the relay to the radio.

## SEL-400 Series MIRRORED BITS Settings

The required port settings for SEL-400 series relays are shown below. To establish communication via the radio, the most critical settings are PROTO, MBT, SPEED, STOPBIT, TXID, RXID, and TXMODE. All other settings are per the application requirements.

---

```

Protocol Selection
PROTO := MBA
Communications Settings
MBT := N      SPEED :=19200    STOPBIT := 2

Mirrored Bits Protocol Setting

TX_ID := 2      RX_ID := 1      RBADPU := 10      CBADPU := 20000
TXMODE := P      MNUM := 8      RMB1FL := P      RMB1PU := 1
RMB1DO := 1      RMB2FL := P      RMB2PU := 1      RMB2DO := 1
RMB3FL := P      RMB3PU := 1      RMB3DO := 1      RMB4FL := P
RMB4PU := 1      RMB4DO := 1      RMB5FL := P      RMB5PU := 1
RMB5DO := 1      RMB6FL := P      RMB6PU := 1      RMB6DO := 1
RMB7FL := P      RMB7PU := 1      RMB7DO := 1      RMB8FL := P
RMB8PU := 1      RMB8DO := 1

```

---

**Figure 3.4 SEL-451 Port Settings for MIRRORED BITS Connection**

Set PROTO equal to MB $x$ , where  $x$  equals A or B depending on which MIRRORED BITS channel is being used. Set MBT equal to N to disable that option.

Set SPEED equal to 19200 (or 9600 if the encryption card is installed).

Set STOPBIT equal to 2.

---

**NOTE:** If you are using the SEL-3044 Encryption Card, you must change the connected devices' RMB $x$ PU and RMB $x$ DO settings = 2 to maintain the same level of channel security as the standard MB8 protocol. This will delay operation by one processing interval but will give you a higher level of channel security.

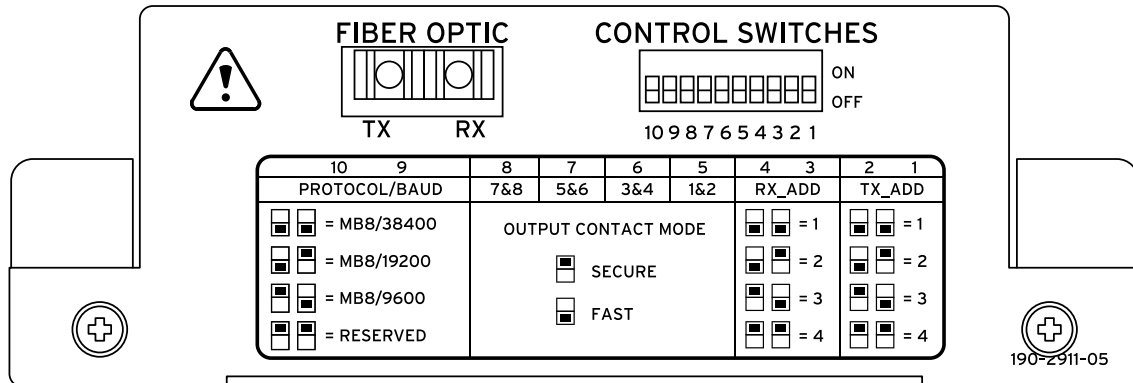
Set the RXID equal to one and TXID equal to two at the master end. At the remote end, set the RXID equal to two and the TXID equal to one. The relays use these addresses so that the master relay only receives messages sent by a relay with the matching transmit address and vice versa.

Set TXMODE equal to P (Paced).

To connect the relay to the radio, use an SEL-C285 cable (DB-9 male-to-DB-9 male straight-through). If complete electrical isolation is desired between the radio and antenna and the EIA-232 communications port of the relay, use the SEL-2812MR Fiber-Optic Transceiver and fiber-optic cable to connect the relay to the radio.

## SEL-2505 and SEL-2506 Settings

The SEL-2505 and SEL-2506 use control (DIP) switches to set the MIRRORING BITS connection. For easy installation order the SEL-2505 with the SEL-2812 fiber-optic option (SEL-2505x6xXX). Use multimode SEL-C808 or SEL-C807 ST terminated fiber-optic cable to directly connect the SEL-2505 to an SEL-3031 equipped with a fiber-optic option for Port 1. Other transceiver models can be used as long as the corresponding SEL-2800 family transceiver is used on both ends.



**Figure 3.5 SEL-2505 DIP Switch Settings for MIRRORING BITS Connection**

Set the TX\_ADD equal to one and set RX\_ADD equal to two at the local end. At the remote end, set the RXID equal to two and the TXID equal to one. The devices use these addresses so that the master relay only receives messages sent by a relay with the matching transmit address and vice versa.

Set Switch 9 and 10 equal to MB8/9600, MB8/19200, or MB8/38400 for the Protocol/Baud setting. If the SEL-3031 contains the SEL-3044 Encryption Card then the Protocol/Baud setting must be MB8/9600 or MB8/19200.

To connect the SEL-2505 to the radio, use a 62.5 μm multimode SEL-C808 or SEL-C807 fiber-optic cable. Order these cables equipped with ST® connectors and your choice of zipcord or waterproof heavy-duty jacketed fibers.

## Initial Checkout

An easy way to verify that the relays are communicating is to use the **TARget** command, as shown below.

```

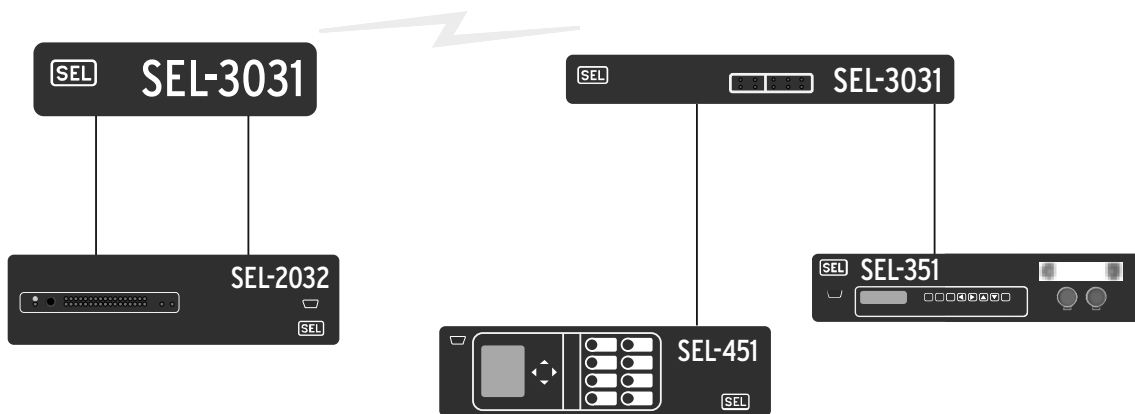
=>TAR ROKA <Enter>
LBOKB   CBADB   RBADB   ROKB   LBOKA   CBADA   RBADA   ROKA
0        0        0        0        0        0        0        1
    
```

**Figure 3.6 TAR ROKA Command From an SEL-351**

The results shown here are from an SEL-351 Relay. ROKA is asserted, meaning that the two relays have established MIRRORING BITS communication. For longer-term channel tests, use the **COM** report command available in the relay and suggestions described in *Monitoring Radio Performance on page 5.1*.

## Using an SEL Information Processor to Collect Relay Status and Measurements

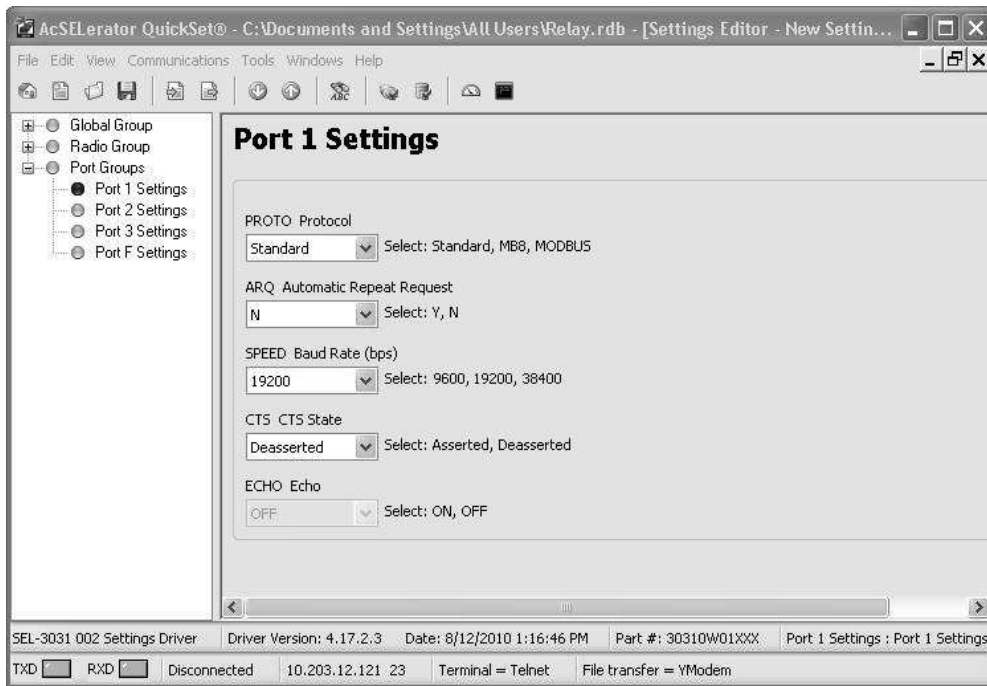
SEL information processors and computing platforms easily collect relay status and measurement information. SEL information processors include the SEL-3530 Real-Time Automation Controller, SEL-2032, SEL-2030, and SEL-2020 Communications Processors, and ruggedized SEL computers configured as intelligent servers or gateways. An SEL information processor can be used as a data collection point, port switch, and to control operations all through one serial port. The SEL-3031 serial interface allows you to obtain all of this relay information from remote IEDs through the use of the wireless connection. The example below will show you how to set the radio, relays, and communications processors to allow the Fast Messaging protocol to operate over a wireless connection.



**Figure 3.7 SEL-3031 Linking Information Processors to Relays**

### SEL-3031 Settings

The SEL-3031 requires very few inputs for setting up the serial port to the correct protocol. *Figure 3.8* shows the settings needed for Port 1.



**Figure 3.8 SEL-3031 Port 1 Settings for Fast Messaging**

The PROTO setting must be set to **Standard**. The Standard setting is the default for use on any byte-oriented protocol. The Standard setting is used with connections such as DNP3, SEL ASCII, Compressed ASCII, Fast Operate, Fast SER, and SEL Fast Meter with Configuration.

The ARQ setting should be set to Y. This allows data retransmission when an error is detected. The SPEED setting can be set 9600, 19200, or 38400 bps. If you set it to 38400, it will disable Port 2. Port 3 will still operate at 9600 or 19200 bps. The CTS1 setting should be set to **Deasserted**. This will deassert the control lines on the SEL-3031. Some protocols in devices require the control line to be in a high or low state to permit proper communication. For example, with DNP3, some remote devices will not reply back to the master until the control line is deasserted. If the control line is asserted the DNP3 device is told to wait. Again, this setting is based upon how the vendor implemented flow control in the devices. For most all SEL products this setting should always be set to **Deasserted**.

On Port 1 of each radio, install an SEL-C285 cable to the IED. As an alternative, the SEL-3031 can be ordered with a fiber-optic serial port that works with SEL-2812 transceivers. If you use the fiber port on the SEL-3031, the connection at the IED needs to be an SEL-2812MR transceiver or compatible built-in port.

## SEL-300 Series Settings

The required settings for the SEL-351 are shown in *Figure 3.9*. These settings are similar to all of the SEL-351, SEL-311, and SEL-700 series of relays. To establish a communications link via the radio, the most critical settings are PROTO, SPEED, BITS, PARITY, STOP, and RTSCTS.

---

```

=>>SH0 P 2 <Enter>
Port 2

PROTO = SEL
SPEED = 19200   BITS = 8   PARITY= N   STOP = 1
T_OUT = 10     AUTO = Y   RTSCTS= N   FASTOP= Y

=>>

```

---

**Figure 3.9 SEL-351 Port Settings for Fast Messaging**

Set **AUTO = Y** if you want the relay to send automatic messages to indicate specific conditions.

Set **FASTOP = Y** if you want the communications processor to issue control commands to the relay.

## SEL-2032/SEL-2030 Settings

The following steps demonstrate on how to set SEL-2032 to initially connect and configure an SEL-351 Relay.

- Step 1. Use the SEL-C285 cable to connect one of the SEL-2032 ports; this example uses Port 2 to Port 1 of the SEL-3031.
- Step 2. Enter Access Level 2 on the SEL-2032 and issue the **SET P 2** command to configure Port 2. The SEL-2032 prompts for the type of device connected to the port.
  - a. Enter **S** for the SEL IED.
  - b. Enter **Y** to autoconfigure the port.
  - c. Press the **<Enter>** key to confirm the configuration prompts. The SEL-2032 establishes communication with the relay; determines the type of relay, relay ID, and communications data rate; and determines if the relay is capable of Fast Meter.
  - d. Enter **Y** to save port configuration changes at the final prompt.
- Step 3. Issue the **AUTO 2** command to see what Fast Message features are supported by the SEL-351S. *Figure 3.10* shows an example output for the **AUTO** command.

---

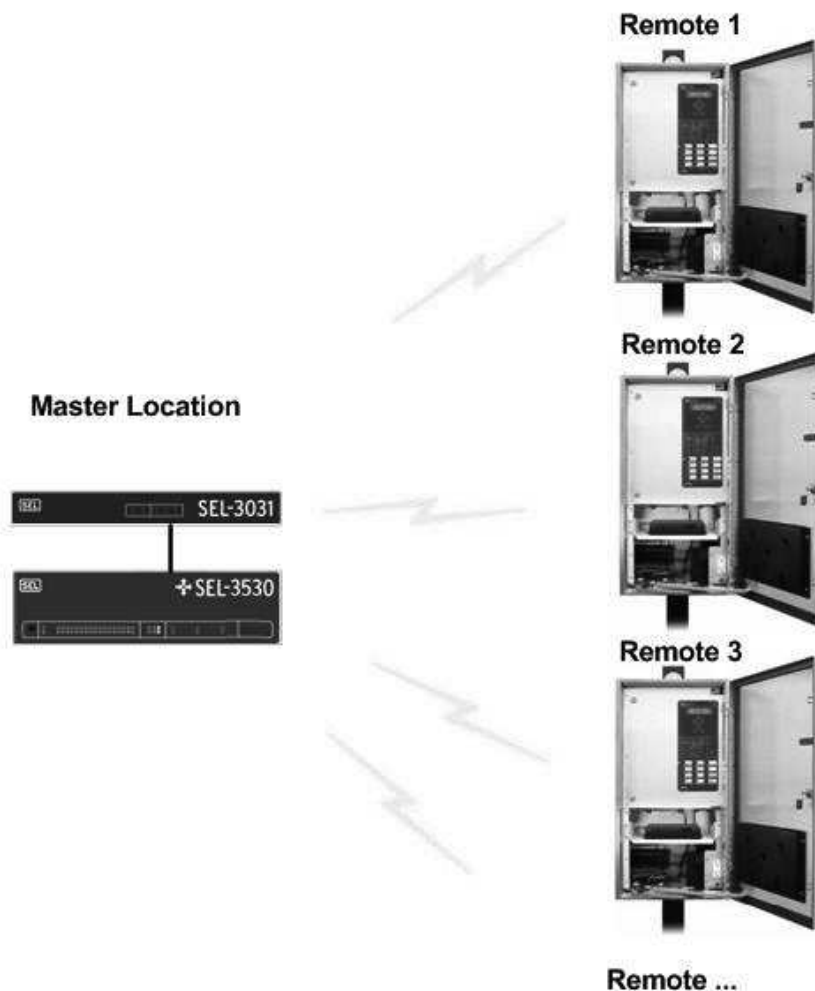
```
*>>AUTO 2 <Enter>
FID: FID=SEL-351S-7-R106-V0-Z003003-D20010110
DEVICE ID: FEEDER 1
BAUD RATE: 19200
OPERATE SUPPORT: Binary (1 Breakers, 16 Remote Bits S-C-P)
LEVEL 1 PASSWORD: OTTER
COMMANDS SUPPORTED:
B 20METER
B 20DEMAND
B 20TARGET
A 20HISTORY
A 20STATUS
A 20EVENT
A 20EVENTS
A 20EVENTL
*>>
```

---

**Figure 3.10 Example AUTO Command Output**

The **AUTO** command verifies initial configuration is set up. Refer to the *SEL-2032 Instruction Manual* for more information on setting up Fast Messaging.

## Setting Up a Point-to-Multipoint Link Using DNP3 SCADA Protocol



**Figure 3.11 SEL-3031 Point-to-Multipoint Example**

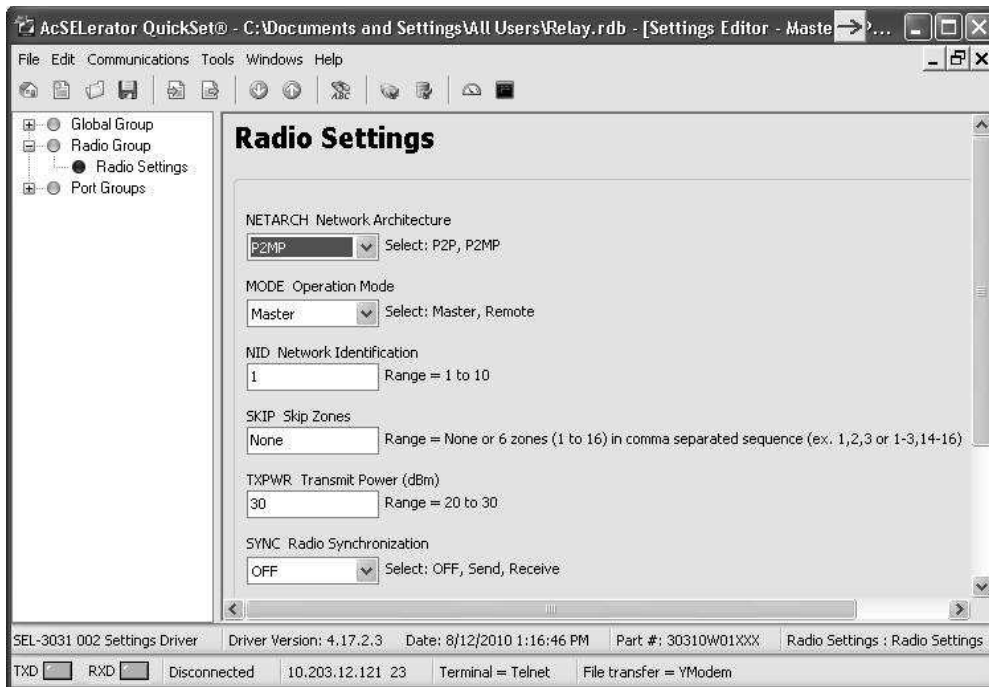
The SEL-3031 is designed to work in P2P (Point-to-Point) and P2MP (Point-to-Multipoint) modes. In P2MP mode Port 1 is the only active port. Port 2 and Port 3 are disabled in this mode. This example will show how to setup a P2MP radio connection where there is one radio at the master location connected to an SEL-3530 RTAC and the other end will be three or more remote radios connected to SEL-651R recloser controls. The protocol used in this example is DNP3. In P2MP mode, the radio works with most multidrop addressable protocols, including MODBUS.

The radios set in P2MP mode operate by allowing the master to send information to all of the remotes. Only the remote that is connected to the IED (SEL-651R) with the correct SCADA address will respond back to the master. Data will collide if the remote is not set up correctly where two remotes share the same address or sending unsolicited data. All remote radios have the ability to transmit data to the master and the protocol addressing determines which remote should respond to the master.



## SEL-3031 Settings

The SEL-3031 requires very few settings to set up the radios. This example assumes the radios have been set up and are currently linked. You should use an SEL-C285 cable to connect the SEL-3031 to the SEL-3530 RTAC and SEL-651R. If you are having problems setting up the radio link, refer to *Section 2: Installation* and *Section 5: Performance Monitoring, Testing, and Troubleshooting* for more information.



**Figure 3.12 Radio Settings for Point-to-Multipoint**

In the Radio Settings, the NETARCH setting must be set to P2MP. The P2MP mode disables Port 2 and Port 3 and allows multiple remote radios to connect to one master.

The MODE setting must be set to MASTER for the radio located at the master location connected to the RTAC. All of the remote radios must have this setting set as REMOTE.

The rest of the Radio Settings can be left to default.

**NOTE:** You must set the TXPWR correctly to stay in compliance with the FCC and IC with a maximum allowed 36 dBm EIRP transmitted signal. See Transmitted Signal on page 2.3 for more information.



**Figure 3.13 Port 1 Settings for Point-to-Multipoint**

Figure 3.13 shows the correct settings needed for creating a DNP channel for P2MP. The PROTO setting should be set to STANDARD. Setting the PROTO to Standard allows all byte-oriented multidrop protocols to pass through the port. If using MODBUS then set PROTO to MODBUS.

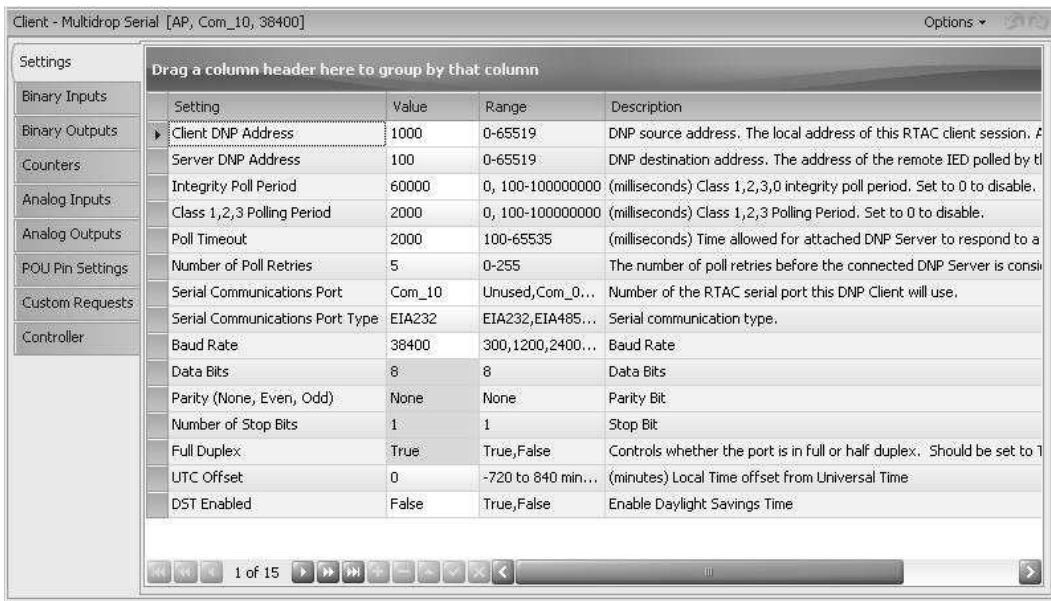
Leave the ARQ setting to Y. In P2MP mode this allows the message being sent from the remote to the master to retransmit on error. In P2MP mode this will not allow the master transmit message to retransmit on error.

The SPEED setting can be set for 9600, 19200, or 38400 bps. It is preferred to set this to 38400 to take advantage of higher throughput to reduce the overall polling time. If any of the end devices do not support 38400 then the whole system must be set down to 9600 or 19200 bps.

The CTS State should be set to DEASSERTED by default. Setting to deasserted allows proper communication with most SEL devices. If the remote device is not responding to DNP messages then this setting may need to get set to ASSERTED. Most DNP devices look at the CTS line and will not send the DNP message unless the CTS line is in an asserted or deasserted state. This setting allows you to set the line high or low to always give the device permission to transmit.

## SEL-3530 RTAC Settings

To properly set the RTAC it is best to review the SEL-3530 manual under *Section 4: DNP3*. This section explains how to setup a DNP3 connection.



**Figure 3.14 SEL-3530 RTAC DNP3 Settings**

Once a DNP port is set on the RTAC to a “Client-Multidrop Serial“ a list of settings are shown in *Figure 3.14*. One of these devices must be set for each remote SEL-651R on the system. The **Client DNP Address** in the example is set to 1000. This is the address of the RTAC DNP master. All devices set up on the RTAC must be set to communicate to the same master address. Similarly on the SEL-651R all settings for REPADR should be set to 1000.

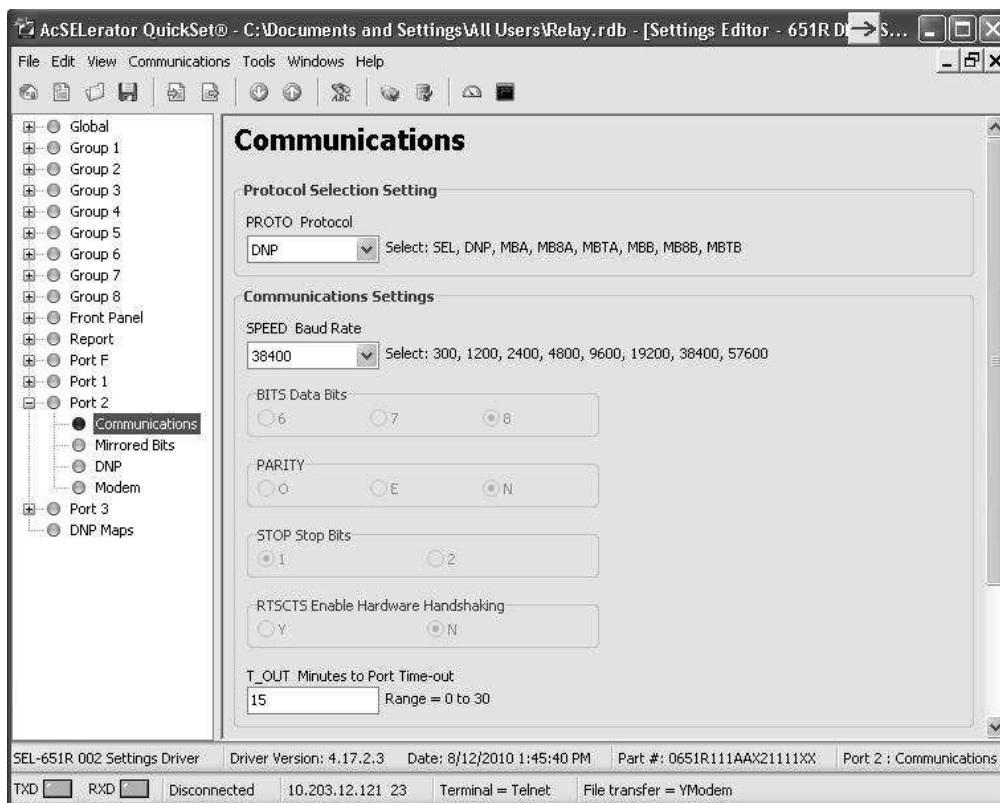
The Server DNP Address is the address of the remote SEL-651R device. Each RTAC device must have a unique address. The corresponding DNPADR in the SEL-651R must be set to the same corresponding device.

The Integrity Poll and Class polling should be set such that there is enough time to poll all remote devices in the allocated time. The more remote devices that are in a system the longer time is needed for the polling.

The Number of Poll Retries in this example is set to 5. Given the availability of the radio system will change this setting. If the SEL-3031 has a greater than 95 percent availability and the ARQ in the radio is turned on then you would not expect to see many poll retries.

The Baud Rate should be set to 38400 to match the system baud rate. The rest of the settings are either fixed or you can leave as default.

## SEL-651R Settings

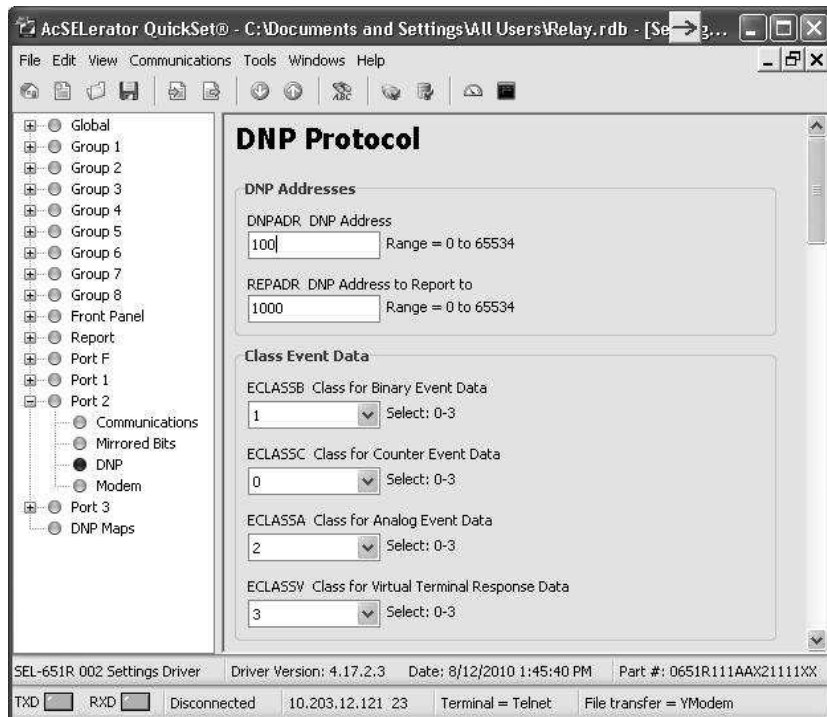


**Figure 3.15 SEL-651R Communications Settings for P2MP**

The SEL-651R has a minimum of four settings to get the link up and running. There are more settings to determine types and mapping of digital and analog data but are not needed to verify initial operation. This example only demonstrates on how to get the RTAC communicating to the SEL-651R through the SEL-3031 in P2MP mode.

*Figure 3.15* shows the first setting needed in the SEL-651R. The settings are needed in all remote SEL-651R units communicating to the RTAC. The PROTO needs to be set to DNP for the current protocol used. The SPEED needs to be set to 38400 to match the system baud rate. The rest of the settings in this group can be left as default.

*Figure 3.16* shows the settings for the DNP port set in the SEL-651R.



**Figure 3.16 SEL-651R DNP Port Settings for P2MP**

The DNPADR is set to 100 in this example. Each remote SEL-651R must be set to a unique address. This corresponding address must match the RTAC device address called “Server DNP Address”.

The REPADR is set to 1000 in this example. This is the address the SEL-651R is to report back to, otherwise called the master address. All remote SEL-651R units should be set to the same master address. All the other settings can be left as default and are not needed for initial configuration. If a different type or class of event data is needed, then more of these settings need to be changed along with settings in the RTAC. This is not covered under the scope of this example.

## Verifying Proper Operation

Once all the settings in the SEL-3031 radios, RTAC, and SEL-651R are set correctly, the next step is to verify proper operation. Easily check this by looking at the master SEL-3031 Tx and Rx LEDs on Port 1. If the Tx LED illuminates, and the Rx LED illuminates shortly after, the link is up and working. If you only see the Tx LED illuminate and not the Rx LED illuminate you either have a problem with the settings in the radio, settings problem on the SEL-651R, or you are using the wrong cable. You can also review the data LED at each remote location. These LEDs will help troubleshoot the problem. If you do not see the Tx LED on the master radio illuminating then you are either using the wrong cable or do not have the correct settings in the RTAC.

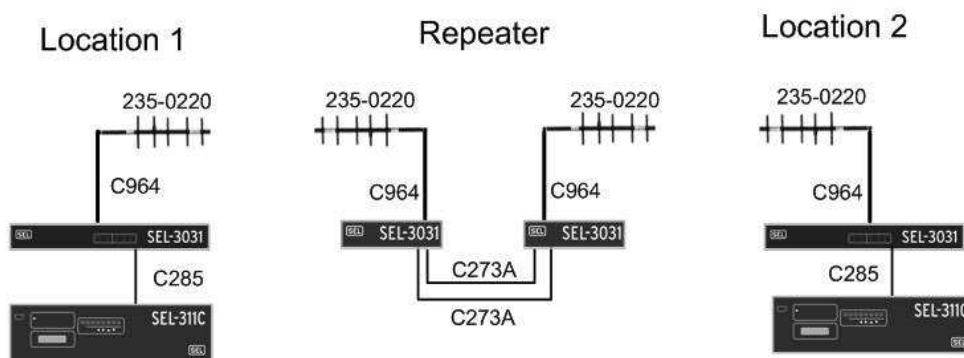
## Configuring Collocated Antennas Using SEL Hop-Sync Technology

There are radio applications that require multiple links at one location. Using multiple antennas at one location operating at the same frequency band causes interference issues with adjacent placed antennas. To improve the dependability when using collocated antennas the radio comes with SEL Hop-Sync™ technology. SEL Hop-Sync technology allows you to connect collocated antennas together and synchronizes all the radios connected so they hop at the exact same time. This greatly reduces adjacent channel noise and allows each radio to receive data without interference from the adjacent antennas.

There are three applications where collocated antennas are typically applied.

1. Setting up a repeater location where two back-to-back radios are used.
2. Setting up two links going to and from the same location as a primary/backup radio installation.
3. Creating two or more links from a central location going to separate locations.

This example will show how to set up collocated antennas in a repeater location using MIRRORED BITS. Once you understand how to setup up collocated antennas applications 2 and 3 can be easily extrapolated. See *Collocated Antenna Systems on page 2.8* for more information.



**Figure 3.17 Setting up Collocated Antennas at a Repeater Location**

Figure 3.17 is the connection diagram with the cables and antennas needed for this application. This example uses two SEL-311C relays communicating MIRRORED BITS over the radio link. The line of site between location 1 and 2 is obstructed by a hill. A repeater location is set up to transmit around the hill.

## SEL-311C and SEL-3031 Settings at Location 1 and 2

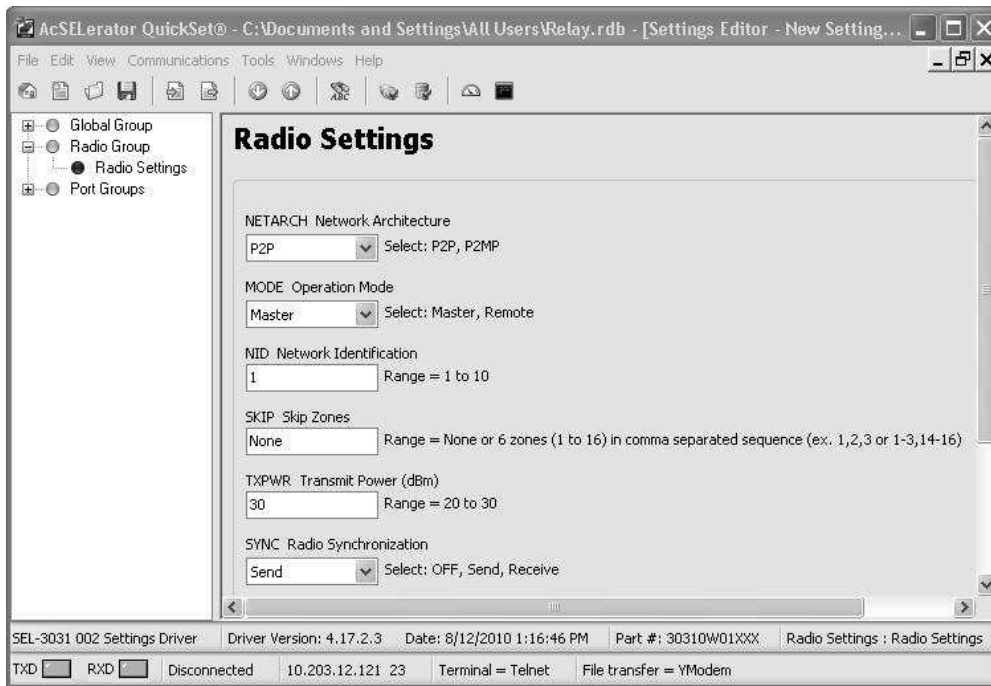
The SEL-311C serial port needs to be set to MB8 MIRRORRED BITS protocol. Follow the job done Example 1 to configure the SEL-311C and the SEL-3031 radios located at Location 1 and Location 2.

## SEL-3031 Settings at Repeater Location

Set the two collocated SEL-3031 radios at the repeater location with settings similar to the radios at Location 1 and 2. Set the radio at the Repeater location that is communicating to Location 1 the same as the setting of the SEL-3031 at Location 2. Do the same for SEL-3031 at the Repeater location communicating to Location 2 set the same as the SEL-3031 at Location 1. This setup will start as two independent P2P links. At the repeater location use an SEL-273A cable to connect Port 1 on each radio. This setup should allow the repeater link to pass information to the next radio and the relays should be communicating MIRRORRED BITS. This link will work adequately if the repeater antennas are placed far enough apart to prevent the adjacent antenna from interfering. To improve this link and to allow the antennas to be placed closer you will need to synchronize the radios.

## Synchronizing the Radios at the Repeater Location

To synchronize the system we need to synchronize the radios at the repeater location so that the collocated radios transmit and receive at the same time. To do this you must connect an SEL-273A cable between Port 3 of the radios at the repeater location. The radios will use Pin 7 and Pin 8 in the communications cable to synchronize each other. The last step to synchronizing radios is to set the SYNC setting in each of the radios at the repeater location. You must make one radio the master SYNC SEND and the other a master SYNC RECEIVE.



**Figure 3.18 SYNC Settings for Master Radio**

Figure 3.18 shows the settings for the master radio at the Repeater location. The SYNC setting for this device must be set to SEND. This tells the radio to generate a pulse to synchronize connected radios. On the second master radio at the Repeater location you must set SYNC to RECEIVE.



# Section 4

## Settings and Commands

### PC Software

ACSELERATOR QuickSet® SEL-5030 Software is a powerful settings and HMI tool that aids in setting, applying, and using the SEL-3031 and other SEL devices. This section describes how to get started with your SEL-3031 and QuickSet.

**Table 4.1 ACSELERATOR QuickSet SEL-5030 Software**

Terminal	Provides a direct connection to the SEL device. Use this communications method to interface directly with the device.
Rules-Based Settings Editor	Provides online or offline device settings that include interdependency checks. Use this feature to create and manage settings for multiple devices in a database.
Settings Database Management	Provides a database to manage multiple device settings.
Help	Provides general QuickSet and device-specific QuickSet context help.

### Setup

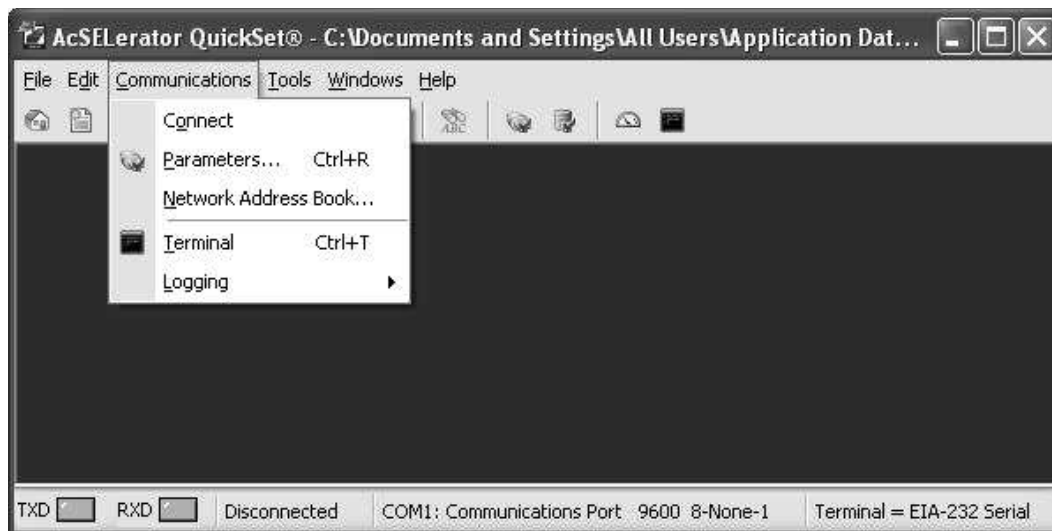
Follow the steps outlined in *Section 2: Installation* to prepare the SEL-3031 for use. Perform the following steps to initiate communications:

- Step 1. Apply power to the SEL-3031.
- Step 2. Connect a USB Type-B cable (SEL-C664) between the management port of the SEL-3031 and the PC.
- Step 3. Follow the on screen instructions and install the USB driver if not already installed.
- Step 4. Start QuickSet.

## Communications

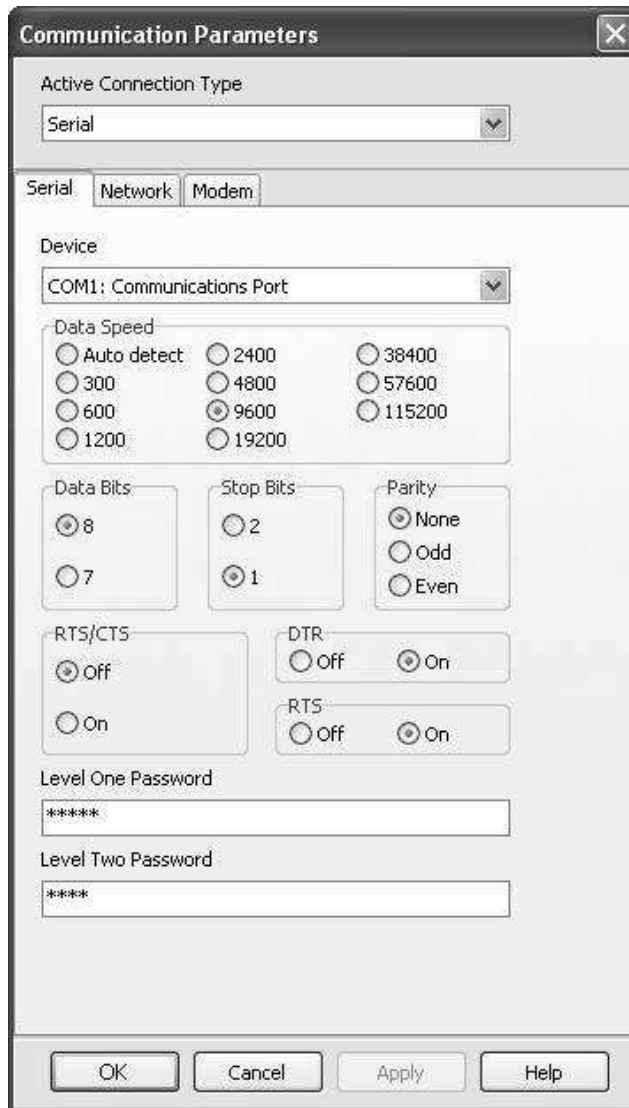
QuickSet uses the device USB management port to communicate with the SEL-3031. Perform the following steps to configure QuickSet to communicate effectively with the device.

- Step 1. Click **Communications** from the QuickSet main menu bar, as shown in *Figure 4.1*.



**Figure 4.1 Communications Menu**

- Step 2. Select **Parameters** to display the screen shown in *Figure 4.2*.

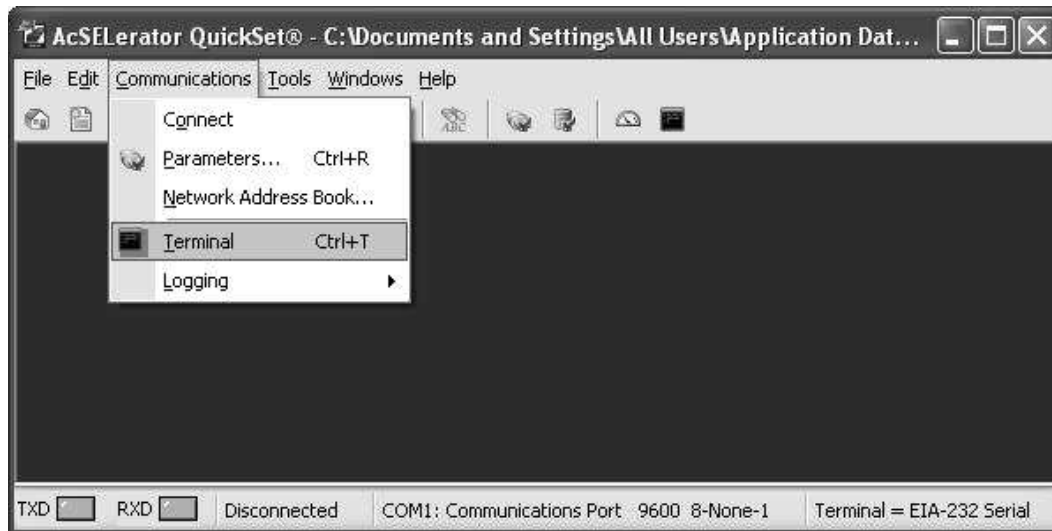


**Figure 4.2 Serial Port Communications Parameters**

- Step 3. Configure the PC port to Data Speed 9600, Data Bits 8, Stop Bits 1, and Parity None.
- Step 4. Configure QuickSet to match the SEL-3031 default settings by entering the Access Level 1 and Access Level 2 passwords in their respective text boxes.
- Step 5. Exit the menus by clicking **OK** when finished.

## Terminal Window

Select **Communications > Terminal** on the QuickSet main menu bar to open the terminal window (shown in *Figure 4.3*).



**Figure 4.3 Terminal Window Menu**

The terminal window is an ASCII interface for the device that supports a basic terminal emulation. Open the terminal window by clicking **Communications > Terminal** or by typing **<Ctrl+T>**. Verify proper communications with the device by opening a terminal window, pressing **<Enter>** a few times, and verifying that a prompt is received. If a prompt is not received, verify proper setup.

## Drivers and Part Number

After clicking **Communications > Terminal**, access the device at Access Level 1. Issue the **ID** command to receive an identification report, as shown in *Figure 4.4*.

```

=>>ID <Enter>
"FID=SEL-3031-R100-V0-Z001001-D20091009", "08DC"
"BFID=SLBT-3031-R100-V0-Z001000-D20091009", "0965"
"CID=25DC8978", "034B"
"DEVID=STATION_A", "04DB"
"DEVCODE=72", "0310"
"PARTNO=30310W01XXX", "0538"
"CONFIG=00000000", "03E3"
"SPECIAL=0", "02DE"
=>>

```

**Figure 4.4 Device Response to ID Command**

Locate and record the Z-number (Z001001) in the FID string. The first portion of the Z-number (Z001...) determines the QuickSet device settings driver version when you are creating or editing device settings files. The Device Editor driver will be discussed in more detail in *Device Editor (Editor Mode)*. Compare the part number (PARTNO = 3031XXXXXX) with the Model Option Table (MOT) to ensure correct device configuration.

# Settings

---

## Settings Database Management and Drivers

QuickSet uses a database on the PC to save device settings. QuickSet contains sets of all settings files for each device specified in the Database Manager. Choose appropriate storage backup methods and a secure location for storing database files.

### Active Database

Change the active database to the one requiring modification by selecting **File > Active Database** on the main menu bar.

### Database Manager

Select **File > Database Manager** on the main menu bar to create new databases and manage records within existing databases.

### Settings Database

- Step 1. Open the Database Manager to access the database. Click **File > Database Manager**. A dialog box will appear. The default file already configured in QuickSet is Relay.rdb. This database contains example settings files for the SEL products with which you can use QuickSet.
- Step 2. Enter descriptions of the database for each device in the Database Description and Settings Description dialog boxes.
- Step 3. Enter special operating characteristics that describe the device settings in the Settings Description dialog box. These can include radio location and communications settings.
- Step 4. Highlight one of the devices listed in Settings in Database and click **Copy** to create a new collection of settings. QuickSet will prompt for a new name. Be sure to enter a new description in the Settings Description.

### Copy/Move Settings Between Databases

- Step 1. Select **Copy/Move Settings Between Databases** to create multiple databases with the Database Manager.  
  
These databases are useful for grouping similar protection schemes or geographic areas.
- Step 2. Click **Open B** to open a device database.

- Step 3. Type the filename and click **Open**.
  - a. Highlight the device or setting in the A database.
  - b. Select **Copy** or **Move**, and click the > button to create a new device or setting in the B database.
- Step 4. Reverse this process to take devices from the B database to the A database. **Copy** creates an identical device that appears in both databases. **Move** removes the device from one database and places the device in another database.

## Create a New Database/Copy an Existing Database

To create a new database, perform the following:

- Step 1. Open **File > Database Manager** and click **Create New Database**. QuickSet will prompt you for a file name.
- Step 2. Type the new database name (and location if it differs from the previous database location), and click **Save**. QuickSet displays the message Settings [path and file name] was successfully created.
- Step 3. Click **OK**.

To copy an existing database of devices to a new database, perform the following:

- Step 1. Open **File > Database Manager** and click **Copy/Move Settings Between Databases** in the Database Manager dialog box. QuickSet will open the last active database and assign it as Database A.
- Step 2. Click **Open B**. QuickSet will prompt you for a file location. Type the new database name, click **Open**, and click **Yes**. The program will then create an empty database. Load devices into the new database as shown in *Copy/Move Settings Between Databases*.

## Settings

QuickSet allows you to create settings for one or more SEL-3031 devices. Store existing device settings downloaded from the SEL-3031 by creating a library of settings, then modify and upload these settings from the library to an SEL-3031. QuickSet makes setting the device easy and efficient and provides rules-based settings checks, commissioning, and help.

## Settings Editor

The Settings Editor shows device settings in easy-to-understand categories, and makes setting the device simple and efficient. Settings are grouped logically, and settings that are not used in the selected group are dimmed (grayed) in the QuickSet menus.

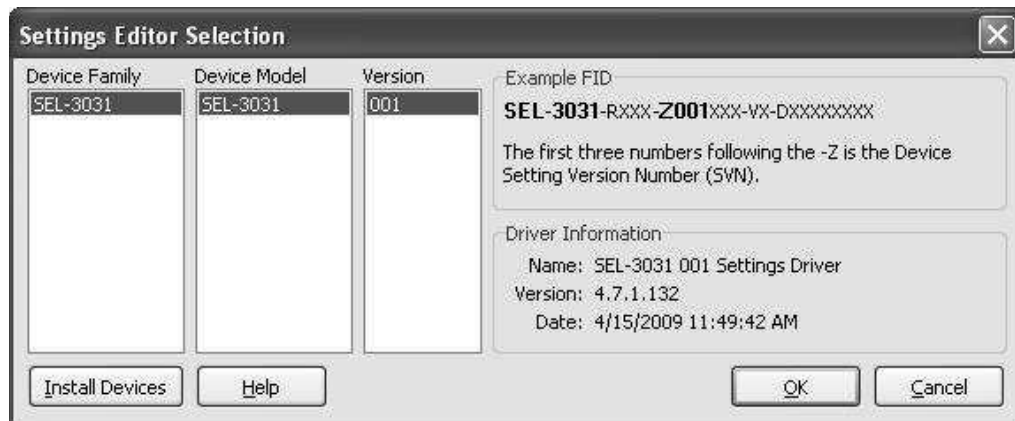
QuickSet shows all of the settings categories in the settings tree view. The settings tree view remains constant whether settings categories are enabled or disabled. However, any disabled settings are dimmed when accessed by clicking an item in the tree view.

## File Menu

QuickSet uses a database to store and manage SEL device settings. Each unique device has its own record of settings. Use the File menu to open an existing record, create and open a new record, read device settings, create an open a new record, or convert and open an existing record. This record can be opened in the Settings Editor as a Setting Form (template) or in Editor Mode.

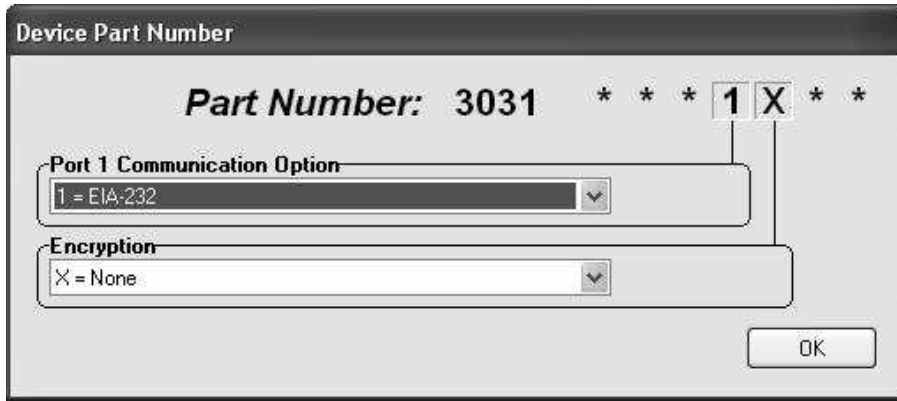
### File > New

Select **File > New** to command new settings files. QuickSet will create the new settings files from a driver that you specify in the Settings Editor Selection dialog box. QuickSet uses the Z-number in the FID string to create a particular version of settings. To get started, select **File > New** from the main menu bar, then select SEL-3031 and **001** from the Settings Editor Selection window as shown in *Figure 4.5*.



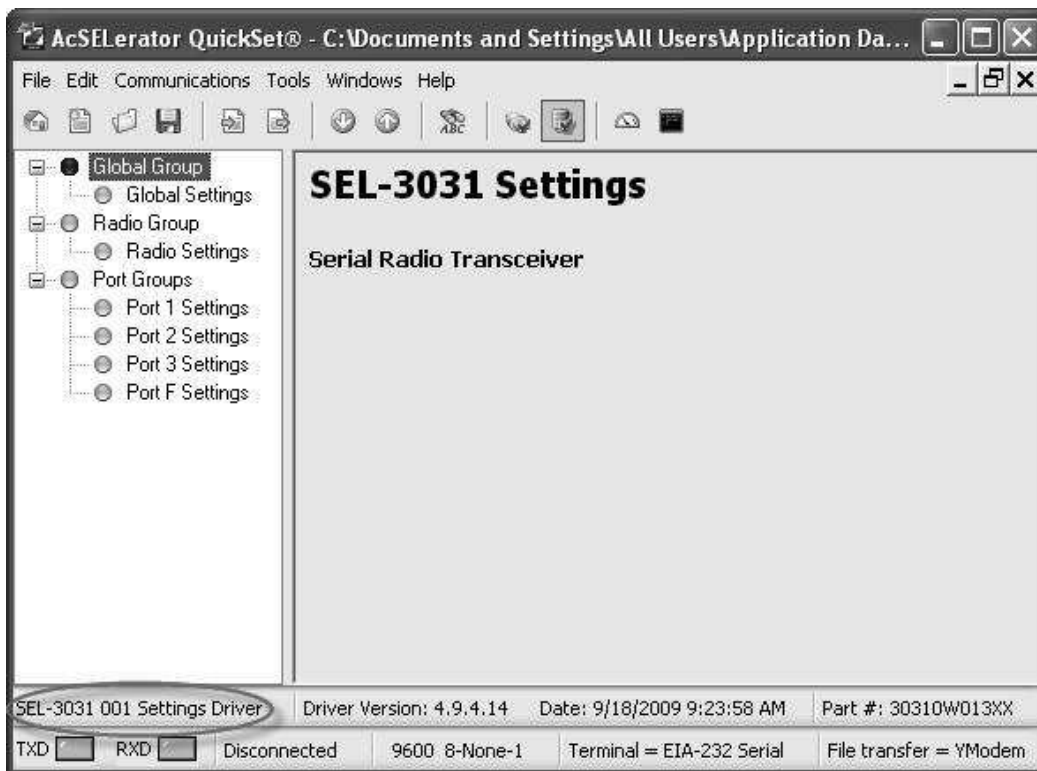
**Figure 4.5 Selection of Drivers**

After you select the device model and settings driver, QuickSet will present the Device Part Number dialog box. Use this dialog box to configure the Device Editor to produce settings for your device with options determined by the part number, as shown in *Figure 4.6*. Click **OK** when finished.



**Figure 4.6 Update Part Number**

Figure 4.6 shows the Settings Editor screen. View the bottom of the Device Editor window to verify the Settings Driver number. Compare the QuickSet Settings Driver number and the first portion of the Z-number in the FID string (this can be found by selecting **Tools > HMI > HMI > Status**). These numbers must match. QuickSet uses the first portion of the Z-number to determine which Device Editor to display.



**Figure 4.7 New Setting Screen**

## File > Open

Select **File > Open** to open an existing device from the active database folder. QuickSet prompts for a device to load into the Device Editor.



## File > Read

Select **File > Read** to cause QuickSet to read the device settings from a connected device. As QuickSet reads the device, a Transfer Status window will appear. QuickSet uses serial protocols to read settings from SEL devices.

## Device Editor (Editor Mode)

Use the Device Editor (Editor Mode) to enter and display settings. Make sure that the firmware in your radio matches the QuickSet settings driver; the driver version number in the lower left corner of the Device Editor should be equal to the first three digits following “Z” in the radio Firmware Identification (FID) string. Use the **ID** or **STA** command to easily view the FID string.

### Entering Settings

- Step 1. Click **+** in the Settings Tree View to expand and select the settings you want to change.
- Step 2. Click **Tab** to navigate through the settings, or click on a setting.
- Step 3. Right-click your mouse in the setting dialog box and select **Previous Value** to restore the previous value for a setting.
- Step 4. Right-click your mouse in the setting dialog box and select **Default Value** to restore the factory-default setting value.

If you enter a setting that is out of range or has an error, QuickSet will show the error at the bottom of the Settings Editor. Double-click the error listing to go to the setting and enter a valid input.

**Table 4.2 Device Editor Menus**

Menus	Description
<< >>	Moves from one category to the next.
Merge	Merges the open record with another record.
Compare	Compares the open record with another record.
Search	Searches for a particular setting.
Part Number	Displays part number.

### Sending Settings

Select **Save**, **Send**, or **Print Device Settings** from the File menu of the Device Editor once settings are entered into QuickSet. This will ensure that your settings are not lost.

## Options—Part Number

Select **Edit > Part Number** to change the part number if it was entered incorrectly during an earlier step.

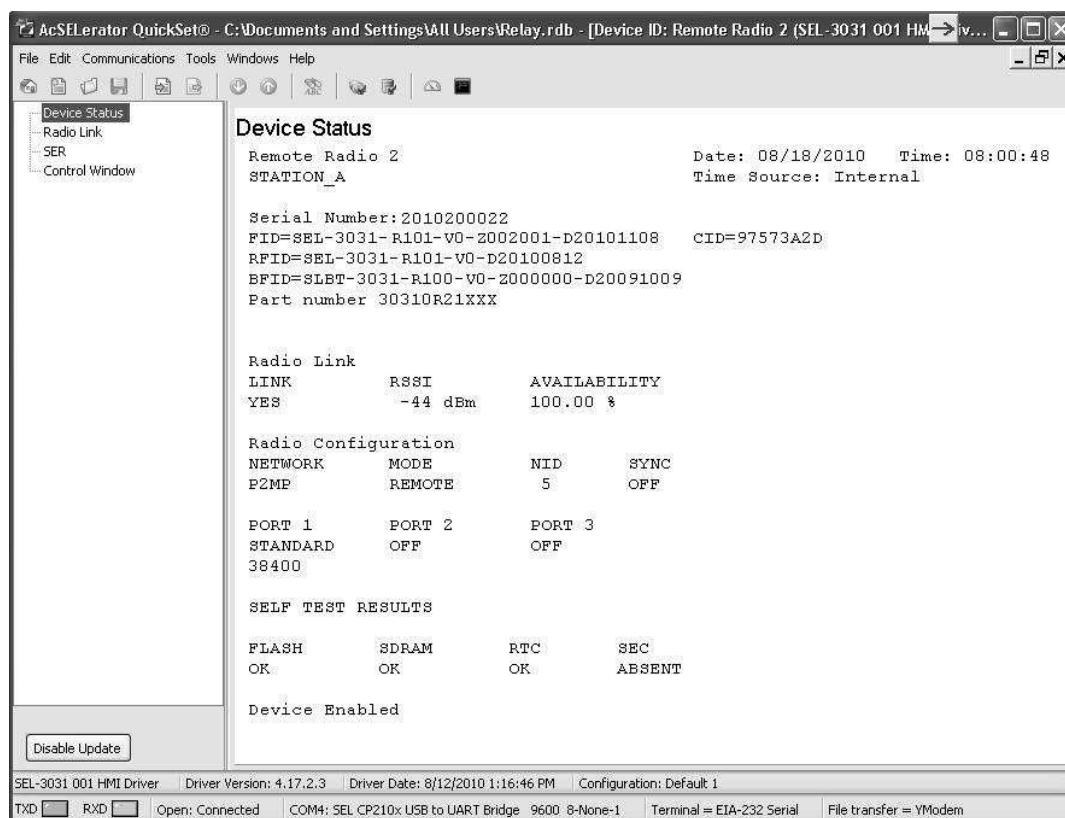
## Text Files

Select **Tools > Settings > Import** or **Tools > Settings > Export** on the Device Editor (Editor Mode) menu bar to import or export settings to or from a text file. Use this feature to create a small file that can be easily stored or sent electronically.

## Meter and Control

### Human Machine Interface (HMI)

Select **Tools > HMI > HMI** to bring up the screen shown in *Figure 4.8*. The HMI tree view shows the functions that are available from the HMI. The Meter & Control window is an easily organized view of real-time data and information stored in the SEL-3031.



**Figure 4.8** Status Screen

The Status screen provides a real-time view of the radio to which it is connected. A user can see the current status of the SEL-3031 and verify any alarm conditions.

Select the Radio Status screen to view the radio statistics. Included is the RSSI value that displays the current strength of the receive signal. This will aid in properly aiming the antenna for maximum signal strength. The “Availability” displays the overall channel availability of the link. The “Zone Availability” gives the availability of each of the 10 zones. See *Monitoring Radio Performance on page 5.1* for more information on optimizing the radio link.



**Figure 4.9 Radio Strength and Channel Availability**

The SER window displays the same information as the ASCII SER commands. The Control Window allows you to clear the SER, synchronize with IRIG, and set the time and date.

## Global Settings

Under the Global group settings category, set the device and host identifiers settings. The SEL-3031 displays the Device and Host Identifier strings at the top of the serial port commands responses, identifying messages from individual devices. Enter as many as 30 characters, including capital letters A–Z, numbers 0–9, periods, and dashes. *Table 4.3* shows the device and host identifier settings.

**Table 4.3 Global Settings (Sheet 1 of 2)**

Setting Prompt	Setting Range	Setting Name := Factory Default
Device Identifier	30 characters	DID
Host Identifier	12 characters (no spaces)	HID

**Table 4.3 Global Settings (Sheet 2 of 2)**

Setting Prompt	Setting Range	Setting Name := Factory Default
Date Format	MDY, YMD, DMY	DATE_F := MDY
Port Power	ON, OFF	5V_EN := OFF

**Date\_F** allows you to change the device date presentation format to either North American standard (Month/Day/Year), Engineering standard (Year/Month/Day), or European standard (Day/Month/Year).

**5V\_EN** enables the +5 V on Pin 1 on every EIA-232 DB-9 serial port. When this setting is on, all three ports will have +5 Vdc on Pin 1. The entire load on the +5 V must not exceed 500 mA.

## Radio Settings

**Table 4.4 Radio Settings**

Settings Prompt	Settings Range	Setting Name := Factory Default
Network Architecture	P2P, P2MP	NETARCH := P2P
Operation Mode	MASTER, REMOTE	MODE := REMOTE
Network Identification	1–10	NID := 1
Skip Zones (SEL-30310)	1–16, NONE	SKIP := NONE
Skip Zones (SEL-30311 Brazil)	1–3, 9–16, NONE	SKIP := NONE
Transmit Power	20–30 dB	TXPWR := 30
Radio Synchronization	OFF, Send, Receive	SYNC := OFF
Encryption Passphrase	8–80 Characters	KEY := NONE
Radio Address	0–65534	DEVADDR := 1
Address List of Connected Radios	Comma Separated Sequence (ex. 1,2,3 or 1–3,14–16)	RADIOLST := 0
Session Use Time-Out	10–600 seconds	SUTIMEO := 30

**NETARCH** sets the primary operation mode of the radio. P2P is the default mode which sets the radio to point-to-point mode where there is one master and one remote. In this mode all three serial ports can be used. In P2MP (point-to-multipoint) mode there can be one master and multiple remote radios. P2MP mode only uses Port 1 and disables Ports 2 and 3.

**MODE** sets the operating mode of the radio. The radio is set to REMOTE by default. In P2P mode one radio must be set as MASTER and the other must be set to REMOTE. In P2MP mode the master is located at the data collection point and all other radios in the system set to REMOTE. In P2MP mode the master transmits to all the remote radios, and only one remote can respond to the master.

**NID** sets the network address of the radio network. All radios in the same network must be set to the same NID with the same SKIP zones to properly link and communicate. If more than one radio network exists then each network must be set to a different **NID**.

**SKIP** determines which of the 16 frequency zones to skip in the SEL-3031 hopping sequence. The SEL-30310 will operate on any 10 of the 16 zones. The default setting is NONE. The SEL-30310 must use a minimum of 10 zones, a setting of NONE will force the radio automatically SKIP zones 11–16. The SEL-30311 for Brazil will operate on any 10 of the 11 Zones 1–3 and 9–16. A setting of NONE will force the SEL-30311 to automatically SKIP zone 16. The SKIP setting can contain as many as six comma-delimited zones from *Table 4.5* or *Table 4.6*. Each zone entered in this setting will set the SEL-3031 to skip that particular zone in the hopping table. This setting can help increase the availability of the radio and avoid areas of interference.

**Table 4.5 SKIP Zone Frequencies (SEL-30310)**

Zone 1	Zone 2	Zone 3	Zone 4	Zone 5	Zone 6	Zone 7	Zone 8
902.6–903.8	904.1–905.3	905.6–906.8	907.1–908.3	909.2–910.4	910.7–911.9	912.2–913.4	913.7–914.9
Zone 9	Zone 10	Zone 11	Zone 12	Zone 13	Zone 14	Zone 15	Zone 16
915.2–916.4	916.7–917.9	918.2–919.4	919.7–920.9	921.2–923.0	923.3–924.5	924.8–926.0	926.3–927.5

**Table 4.6 SKIP Zone Frequencies (SEL-30311 Brazil)**

Zone 1	Zone 2	Zone 3	Zone 9	Zone 10	Zone 11
902.6–903.8	904.1–905.3	905.6–906.8	915.2–916.4	916.7–917.9	918.2–919.4
Zone 12	Zone 13	Zone 14	Zone 15	Zone 16	
919.7–920.9	921.2–923.0	923.3–924.5	924.8–926.0	926.3–927.5	

The SEL-3031 has radio statistics to help set the SKIP setting if the availability of the radio is less than desired. To determine which frequency zones to skip, issue a **RADio C** command and let the radios run for a period of time. You will get better availability results the longer you let the radio run linked. Issue the **RADio** command to view the availability of each frequency zone. In the radio report identify the frequency zones with the lowest availability and enter these zones via the SKIP setting. If the radio zone availability is within 1 to 2 percent of each other, no SKIP setting changes are needed. The SKIP setting is for avoiding noisy occupied zones not from multipath effects that are seen by all zones. If the availability is below what is desired,

it may be because of obstacles in the way or improper antenna alignment. Issue another **RADio C** command and let the SEL-3031 run for another day then verify that the availability has increased. See *Section 5: Performance Monitoring, Testing, and Troubleshooting* for more information on how to use the SKIP setting.

**TXPWR** sets the transmitted power of the SEL-3031. The available range is 20–30 dBm (1 W). The radio transmit power is set in 1 dBm increments. The radio is shipped with a factory-default setting of 30 dBm. This setting must be used to reduce the power output if the total effective isotropically radiated power (EIRP) exceeds 36 dBm. See *Transmitted Signal on page 2.3* for more information on how to calculate and configure the maximum power output.

In the United States and Canada, the FCC and IC regulate the amount of power a radio can radiate with EIRP. The EIRP limit of radiation is 36 dBm. This value includes the power of the transmitter, cable losses, and antenna gain. If you exceed the allowed 36 dBm, you must lower the transmitted power of the radio by using the TXPWR setting, and then measure the actual power.

See *Transmitted Signal on page 2.3* for more information on determining and properly setting the TXPWR setting.

**SYNC** is used when more than one radio network exists with collocated antennas. The SYNC setting allows you to connect two or more radios together, enabling the radios to synchronize their hop sequences through the use of SEL Hop-Sync technology. SEL Hop-Sync technology synchronizes the hop sequence giving a much higher radio availability and dependability by removing adjacent antenna interference. The synchronizing allows you to install multiple antennas on the same pole and greatly reduce adjacent noise interference.

For all the collocated radios the MODE setting needs to be set as MASTER. One of the MASTER radios you set the SYNC to SEND and all of the other MASTER radios you set the SYNC to RECEIVE. You do not need to set the SYNC for the radios on the other end of the link. You only need to set the SYNC setting for the collocated radios. See *Collocated Antenna Systems on page 2.8* for more information on properly cabling and using SEL Hop-Sync technology. For SEL Hop-Sync technology to properly work, each radio at the collocated site must have the SYNC settings set correctly and a cable on Port 3 connecting all the collocated radios.

The **KEY** setting is only available if the product contains an SEL-3044 Encryption Card. The KEY setting is a passphrase that is used to generate an encryption key. The acceptable range is from 8 to 80 characters. All printable characters are accepted. If you have an encryption card, this value must be set to enable the secure wireless connection. If **MODE** equals P2MP then the DEVADDR and RADIOLST must be set with the KEY setting to allow a master to talk to multiple remotes. If **MODE** is set to P2P then only the KEY setting is needed. When the SEL-3031 is shipped with the encryption card, or added in the field, it is by default shipped in reset mode. The **SEC** LED on the front panel will flash green to show this state. The KEY setting must be set to activate the encryption card. The SEL-3031 radios will not transmit data until the SEL-3044 is set properly. The **SEC** LED will illuminate green when the KEY setting is

correctly set. The green SEC LED indicates data being set through the radio link is secured. Once the KEY setting is configured the setting can never be read back, viewed, or saved with QuickSet.

To encrypt a radio link, both radios must contain an SEL-3044 and the KEY settings must be set to the same value. See *Appendix B: Firmware Upgrade Instructions* for more information on the SEL-3044 Encryption Card. The DEVADDR and RADIOLST settings are only available if the product contains an SEL-3044 Encryption Card and the network architecture is point-to-multipoint (NETARCH = P2MP). The DEVADDR Radio Address must be a unique address from 0 to 65534. Every radio on the same network must be set to a different address. The RADIOLST is the address list of allowed connected radios. Each radio will only accept communications from radios that have the device address in the radio list. All remote radios shall have the address of the Master radio address DEVADDR. The master radio needs a list of all the remote addresses it is allowed to communicate with. You can only have one master in a P2MP network and as many as 20 remotes with the Encryption Card. Adding a second master will stop all communications.

The SUTIMEO (session use time-out) setting is only available when the SEL-3044 Encryption Card is present, NETARCH = P2MP, and MODE = MASTER. The SUTIMEO setting is used to set the maximum time the master must wait before talking with each remote in the RADIOLST setting. This setting must be set to the maximum time it will take for a SCADA master to poll all of the remote devices. Once this time is exceeded the master radio will attempt to reconnect to the remote while discarding all incoming SCADA data. This out-of-band messaging will take around 100 ms per lost device but will repeat every time the SUTIMEO expires. This timer resets each time a master receives a successful packet from the remote. If you no longer plan to communicate with a remote you should remove the device from the DEVADDR. The SUTIMEO will also set the maximum time before the master radio will recognize a new remote device added to the network. If you add a radio to an existing network, it will take as long as the SUTIMEO time before the master recognizes and authenticates the new remote.

---

**NOTE:** Do not include any addresses of radios that are not actively being used in the network. This will slow down the network with out-of-band messaging.

## Port Settings

The SEL-3031 settings allow you to configure the parameters for each of the three communications ports. The SEL-3031 comes standard with three EIA-232 ports. In P2P mode all three serial ports are active. In P2MP mode only Port 1 is active, Port 2 and 3 are disabled. Port 1 can be ordered as an EIA-232, EIA-485, or serial fiber-optic port. *Table 4.7* shows the port settings ranges and default settings for Port 1, Port 2, and Port 3.

The protocol setting defines the type of data that will be passing through the serial port. This setting automatically sets parameters in the radio to optimize best performance. In P2P mode, any of the three serial ports may be set to any of the protocols. Ports 2 and 3 are always EIA-232 ports. For example, you have three ports of MIRRORED BITS® (MB8), or any combination of MB8, MODBUS, and STANDARD.

**Table 4.7 Port Settings**

Settings Prompt	Settings Range	Setting Name := Factory Default
Protocol	STANDARD, MB8, MODBUS	PROTO := STANDARD
ARQ	Automatic Repeat Request	ARQ:=Y
SPEED	9600, 19200, 38400 (9600, 19200 with Encryption Card)	SPEED=19200 (9600 with Encryption Card)
CTS State	Asserted, Deasserted	CTS := DEASSERTED
Echo	ON, OFF	ECHO := OFF

**PROTO** sets the intended protocol used to communicate through the radio ports. Set to STANDARD for all byte-oriented protocols such as DNP3, ASCII, Synchrophasors, or file transfer. This is the default setting for PROTO and should be used unless you are using MIRRORED BITS or MODBUS. Set PROTO to MB8 to work with SEL MIRRORED BITS devices (P2P mode only). The SEL-3031 only supports MB8 MIRRORED BITS protocol in P2P mode. MIRRORED BITS MB8 is not supported when operating in point-to-multipoint (P2MP) mode. See *Section 3: Job Done Examples* for more information on setting up MIRRORED BITS. Set PROTO to MODBUS when used with Modbus protocol. MODBUS has strict character spacing rules that warrant the specific setting to properly transport the protocol. When using MODBUS in P2P or P2MP the PROTO settings must be set to MODBUS and the connected devices must be set to 8 data bits, no parity, and 1 stop bit.

**ARQ** (Automatic Repeat Request) sets the radio to repeat any radio packets that fail the data packet error checking or do not arrive at the other radio. ARQ is available when the PROTO setting is set to Standard or MODBUS. ARQ is disabled when PROTO is set to MB8. ARQ by default is set to Y. This setting should always be set to Y unless you use a protocol where time-sensitive data are necessary in an application where dropping delayed packets is preferred. In P2P mode, ARQ will repeat failed data packets traveling in both directions. In P2MP mode, only data transferring from the remote to the master will repeat upon error.



**Table 4.8 Fixed Port Settings**

Port Setting	Fixed Port Settings	Fixed Port Settings With SEL-3044 Card
Data Rate (Port 2 and 3)	settable	9600 bps
Data Bits	8	8
Parity	None	None
Stop Bit	1	1
RTS/CTS Flow Control	Off	Off

Ports 2 and 3 are fixed at 9600 bps with the SEL-3044 Encryption Card. The default setting for SPEED is 19200, or 9600 bps with the Encryption Card. If the radio is in P2P mode and the Port 1 SPEED is set to 38400 then Port 2 will be disabled. In P2MP mode only Port 1 is enabled and a setting of 9600, 19200, or 38400 bps (9600 or 19200 with the SEL-3044 Encryption Card) is allowed.

The **CTS** setting is used to set the state of the CTS (Pin 7) line on each of the ports. In most cases this setting should be set to deasserted. Most SEL devices require CTS deasserted for them to respond to DNP requests. The SEL-3031 does not support hardware flow control. It will only assert or deassert the CTS line to signal connected equipment to continue communication. If radio synchronization is enabled, SYNC ≠ OFF, then Port 3 CTS setting is disabled.

The **ECHO** setting is only enabled when Port 1 is ordered as an EIA-485 device. This setting is used to set up a two-wire versus four-wire EIA-485 connection. The default ECHO setting is set to ON, which works with four-wire EIA-485 applications. For two-wire operation, the ECHO setting must be set to OFF, and Pins 1 and 7 and Pins 2 and 8 must be connected together (see *Table 2.11*).

## Commands

### Access Levels

Issue commands to an SEL-3031 serial port to view or change device settings or retrieve information. For security, these commands are available on different password-protected access levels. Throughout this section each command description indicates the access level at which the command is available. There are four access levels in the device, offering varying levels of control.

- Access Level 0 commands are the lowest security level. Access Level 0 commands support minimum identification.
- Access Level 1 commands are for reviewing information only (e.g., status) and not for making any changes.

- Access Level 2 commands are for changing device settings.
- Access Level C (restricted access level—should be used under direction of SEL only).

Go to *Communications on page 4.2* for instructions on connecting to the SEL-3031 through the USB interface.

The virtual serial interface created from the USB port must be set to 9600 bps, 8 data bits, 1 stop bit, and no parity to communicate to the SEL-3031.

## Access Level 0

Once serial port communication is established with the SEL-3031, press **<Enter>** and you should see the following prompt:

```
=
```

**NOTE:** If you don't get the = prompt, then refer back to Communications on page 4.2 to properly connect to the SEL-3031.

This is referred to as Access Level 0. Only a few commands are available at this level. One is the **ACC** command.

Enter **ACC** at the Access Level 0 prompt:

```
=ACC <Enter>
```

The **ACC** command takes the SEL-3031 to Access Level 1.

## Access Level 1

When the SEL-3031 is in Access Level 1, the device sends the following prompt:

```
=>
```

From Access Level 1, use the **2AC** command to go to Access Level 2.

Enter **2AC** at the Access Level 1 prompt:

```
=>2AC <Enter>
```

## Access Level 2

When the device is in Access Level 2, the SEL-3031 sends the following prompt:

```
=>>
```

All of the Access Level 1 commands are available in Access Level 2. The SEL-3031 responds with `Invalid Access Level` when a command is entered from an access level lower than the required level for the command. The device responds with `Invalid Command` to commands that are not available or are entered incorrectly.

## Access Level C

The CAL access level is used exclusively by the SEL factory and SEL field service personnel to diagnose troublesome installations. A list of commands available at the CAL level is available from SEL upon request. Do not enter the CAL access level except as directed by SEL.

The CAL command allows the device to go to Access Level C . Enter the CAL command at the Access Level 2 prompt:

```
=>>CAL <Enter>
```

## ASCII Commands

The SEL-3031 includes ASCII commands and settings to properly set the SEL-3031. QuickSet provides a user-friendly interface to set the SEL-3031, but either interface can be used to set the product.

## DATE Command

Use the DATE command to view and set the date, as shown in *Table 4.9*.

**Table 4.9 DATE Command**

Command	Description	Access Level
DAT	Displays the internal clock date.	1
DAT <i>date</i>	Sets the internal clock date (DATE_F set to MDY, YMD, or DMY).	1

The device can overwrite the date entered with other time sources, such as IRIG. Enter DATE to set the internal clock date. Separate the month, day, and year parameters with slashes. Set the year in four-digit format (for dates 2000–2099).

## IDENTIFICATION Command

The **ID** command extracts device identification codes, as shown in *Table 4.10*. The **ID** command is only available as a compressed (comma-delimited) command.

**Table 4.10 ID Command**

Command	Description	Access Level
<b>ID</b>	Returns a list of device identification codes, as shown below:  <pre>=ID &lt;Enter&gt; "FID=SEL-3031-R100-V0-Z001001-D20091009", "08D2" "BFID=SLBT-3031-X307-V0-Z000000-D20091009", "0974" "CID=2B957901", "0330" "DEVID=RADIO 1", "03D9" "DEVCODE=72", "0310" "PARTNO=3031OW01XXX", "0538" "CONFIG=00000000", "03E3" "SPECIAL=0", "02DE"</pre>	1

## IRIG Command

Use the **IRI** command to read the demodulated IRIG-B time code at the management port or IRIG-B input, and to force immediate synchronization of the internal clock with the IRIG-B signal (see *Table 4.11*). If an IRIG-B signal is present at serial Port 2, the device will automatically synchronize the internal clock with the IRIG-B signal in a time period not exceeding one minute. It is not necessary to issue the **IRI** command for this automatic synchronization. If you are testing the device and do not want to wait for the one-minute synchronization, issue the **IRI** command to force the device to synchronize immediately with the IRIG-B signal. You can also use the **IRI** command to determine whether the device is properly reading the IRIG-B signal.

**Table 4.11 IRIG Command**

Command	Description	Access Level
<b>IRI</b>	Forces synchronization of internal control clock to IRIG-B time-code input.	1

To force the device to synchronize to IRIG-B, enter the following command:

```
=>IRI <Enter>
```

If the device successfully synchronizes to IRIG-B, it will send the following header and access level prompt:

```
SEL-3031                               Date: 04/12/2005   Time: 15:41:29
DEVICE
=>
```

If no IRIG-B code is present at the serial port input, or if the code cannot be read successfully, the device will respond as follows:

```
IRIG-B DATA ERROR
=>
```

## L\_D Command

Use **L\_D** to load firmware, as shown in *Table 4.12*. See *Appendix A: Firmware and Manual Versions* for information on firmware and instruction manual changes.

**Table 4.12 L\_D Command**

Command	Description	Access Level
L_D	Downloads firmware to the device.	2

## PASSWORD Command

Use **PAS** to view or change existing passwords, as shown in *Table 4.13* and *Table 4.14*.

**Table 4.13 PAS Command**

Command	Description	Access Level
PAS <i>level new passwords</i>	Sets a password for <i>new password</i> for Access Level <i>level</i> . <sup>a</sup>	2

<sup>a</sup> Parameter level represents the device Access Levels 1 or 2.

### WARNING

This device is shipped with default passwords. Default passwords should be changed to private passwords at installation. Failure to change each default password to a private password may allow unauthorized access. SEL shall not be responsible for any damage resulting from unauthorized access.

**Table 4.14 Factory-Default Passwords**

Access Level	Password
1	OTTER
2	TAIL
CAL	CLARKE

To change the password for Access Level 2 from the default password TAIL to new password Ot3579, enter the following:

```
=>>PAS 2 <Enter>
Old PW:? **** <Enter> (Enter TAIL)
New PW:? ***** <Enter> (Enter Ot3579)
Confirm PW:? ***** <Enter> (Enter Ot3579)
```

Password Changed

CAUTION: This password can be strengthened. Strong passwords do not include a name, date, acronym, or word. They consist of the maximum allowable characters, with at least one special character, number, lower-case letter, and upper-case letter. A change in password is recommended.

=>>

Similarly, use **PAS 1** to change Access Level 1 passwords. Passwords can contain as many as 12 characters. Uppercase and lowercase letters are considered different characters. Strong passwords have 12 characters with at least one special character or digit and mixed-case sensitivity, and do not form a name, date, acronym, or word. Passwords formed in this manner are less susceptible to password guessing and automated attacks. Examples of valid, distinct, strong passwords are shown below.

- #Ot3579!ljd7
- \$A24.68&,mvj
- (Ih2dcs)36dn
- \*4u-Iwg+?lf-

**Table 4.15 Valid Password Characters**

<b>Alpha</b>	A B C D E F G H I J K L M N O P Q R S T U V W X Y Z a b c d e f g h i j k l m n o p q r s t u v w x y z
<b>Numeric</b>	0 1 2 3 4 5 6 7 8 9
<b>Special</b>	! " # \$ % & ' ( ) * + , - . / : ; , = . ? @ [ \ ] ^ _ ` {   } ~

If you forget your password, you can reissue a new password by following these steps:

- Step 1. In accordance with the appropriate safety regulations, turn off the device, and see *Front-Panel Jumpers on page 2.14* for instructions on accessing the jumpers.
- Step 2. Go to *Table 2.7* to locate Jumper 2 and short the jumper as shown.
- Step 3. Go to the appropriate access level and issue **PAS x** ( $x = 1$  or  $2$ ) to enter a new password.
- Step 4. In accordance with the appropriate safety regulations, turn off the device and remove Jumper 2 to activate the password function.
- Step 5. Replace the front-panel cover and turn on the device.

## QUIT Command

Use **QUIT** to revert to Access Level 0 from either Access Level 1 or Access Level 2, as shown in *Table 4.16*.

**Table 4.16 QUIT Command**

Command	Description	Access Level
QUI	Sends you to Access Level 0.	0

Access Level 0 is the lowest access level; your SEL-3031 does not require a password check to descend to this level (or to remain at this level).

## RADIO Command

The **RAD** command is for viewing statistics and data on the radio link, as shown in *Table 4.17*. The **RAD** command provides two important types of information.

- **RSSI = Receive Signal Strength Indicator.** The RSSI shows the current strength of the receive signal from the radio. This command helps you to refine antenna positioning. The RSSI is reported in dBm and updates every time the **RAD** command is issued. The RSSI is calculated from the latest 50 frequency hops averaged over time. RSSI is very useful for optimizing performance on directional antennas and monitoring signal strength.
- **Availability.** The radio automatically calculates the availability of the overall radio link and the availability of each hopping frequency. The availability is calculated by measuring the number of good radio frames received per the number of radio frames expected. The Overall is the tallied availability of each of the frequency zones used in the current hopping table. This number is valuable for measuring overall radio availability. The SEL-3031 also calculates the availability of each zone used in the current hopping table. The radio zones displayed in the **RAD** command are based on the SKIP setting. See *Table 4.5* for more information on Skip Zones. See *Section 5: Performance Monitoring, Testing, and Troubleshooting* for more information on using the availability to set the SKIP setting for improved radio performance. The master radio in P2MP mode will only calculate availability on received packets.

**Table 4.17 RAD Command**

Command	Description	Access Level
RAD	View radio statistics	1
RAD C	Clear radio statistics	2

```

1          2          3          4          5          6          7          8
1234567890123456789012345678901234567890123456789012345678901234567890
[Common Header]

RSSI
-69 dBm

AVAILABILITY:          From 10/02/2009 17:33:21

Overall
100.00 %

Zone 1      Zone 2      Zone 3      Zone 4      Zone 5
100.00 %    100.00 %    100.00 %    100.00 %    100.00 %

Zone 6      Zone 7      Zone 8      Zone 9      Zone 10
100.00 %    100.00 %    100.00 %    100.00 %    100.00 %

```

**Figure 4.10 RAD Command Response**

## SER Command

Use **SER** to view and manage the Sequential Events Recorder report, as shown in *Table 4.18*.

**Table 4.18 SER Command**

Command	Description	Access Level
<b>SER</b>	Displays a chronological progression of all available SER rows (as many as 1024 rows); Row 1 is the most recent and Row 1024 is the oldest.	1
<b>SER row 1</b> <b>SER row 1 row 2</b> <b>SER date 1</b> <b>SER date 1 date 2</b>	Displays a chronological or reverse chronological subset of the SER rows.	1
<b>SER C</b>	Clears/resets all SER records.	2

If the requested SER report rows do not exist, the device will respond with the following:

```
NO SER data
```

## SET Command

The **SET** command is for viewing or changing device settings, as shown in *Table 4.19*. Append **TERSE** to skip the settings display after the last setting. Use this parameter to speed up the **SET** command. If you want to review the settings before saving, do not use the **TERSE** option.



**Table 4.19 SET Command (Change Settings)**

Command	Description	Access Level
SET G <i>s</i> <sup>a</sup>	Set Global settings	2
SET R <i>s</i>	Set Radio settings	2
SET P <i>s</i>	Set serial Port settings	2

<sup>a</sup> *s* = specific setting name.

Append the specific setting name you want to change in the **SET** command to immediately jump to the setting. If *s* is not entered, the device starts at the first setting. For example, to directly jump to the TXPWR setting in the Radio setting category, enter **SET R TXPWR <Enter>**. This will take you directly to the TXPWR setting. If you want to set all of the Radio settings, issue the **SET R** command and it will start at the beginning of the settings list. Enter the desired setting value or press **<Enter>** to accept the existing setting, as shown in *Table 4.20*.

**Table 4.20 SET Command Editing Keystrokes**

Press Key	Results
<Enter>	Retains the setting and moves to the next setting.
^<Enter>	Returns to the previous setting.
< <Enter>	Returns to the previous setting category.
> <Enter>	Moves to the next setting category.
END <Enter>	Exits the editing session, then prompts you to save the settings.
<Ctrl+X>	Aborts the editing session without saving changes.

The device checks each setting to ensure that it is within the allowed range. If the setting is not within the allowed range, the device generates an Out of Range message and prompts you for the setting again. When all the settings are entered, the device displays the new settings and prompts you for approval to enable them. Answer **Y <Enter>** to enable the new settings. The device is disabled for no longer than one second while saving the new settings. The **ALARM LED** illuminates momentarily and the **ENABLED LED** extinguishes while the device is disabled.

## SHOW Command

When showing settings, the radio displays the settings label and the present value from nonvolatile memory for each setting class as shown in *Table 4.21*.

**Table 4.21 SHO Command (Show/View Settings)**

Command	Description	Access Level
<b>SHO G s</b>	Show Global settings	1
<b>SHO R s</b>	Show Radio settings	1
<b>SHO P s</b>	Show serial Port settings	1

Append *s* and the specific settings name you want to view in the **SHOW** command to immediately jump to the setting. If *s* (and the settings name) is not included, the device presents settings beginning with the first in the group.

## STATUS Command

Use **STA** to display the status report, as shown in *Table 4.22*.

**Table 4.22 STA Command (Device Self-Test Status)**

Command	Description	Access Level
<b>STA n</b>	Displays the device self-test information <i>n</i> times ( <i>n</i> = 1–32767). Defaults to 1 if <i>n</i> is not specified.	1
<b>STA C</b>	Reboots the device and clears self-test warning and failure status results.	2

Refer to *Section 5: Performance Monitoring, Testing, and Troubleshooting* for self-test thresholds and corrective actions, as well as information on hardware configuration conflict resolution. *Figure 4.11* shows the device response to the **STA** command.

```

=>STA <Enter>
RADIO 1                               Date: 9/16/2010   Time: 04:29:13
STATION_A                             Time Source: Internal

Serial Number: 0000000000000000
FID=SEL-3031-R101-V0-Z002001-D20100723  CID=8BCE91D9
RFID=SEL-3031-R101-V0-D20101630
BFID=SLBT-3031-R100-V0-Z000000-D20091009
Part number 30310W01XXX

Radio Link
LINK      RSSI      AVAILABILITY
YES      -29 dBm     99.63 %

Radio Configuration
NETWORK   MODE      NID      SYNC
P2P      MASTER    5        OFF

PORT 1    PORT 2    PORT 3
STANDARD STANDARD STANDARD
19200    19200    19200

SELF TEST RESULTS

FLASH OK  SDRAM   RTC     SEC
OK        OK      OK      ABSENT

```

```
Device Enabled
=>
```

**Figure 4.11 Device Response to the STATUS Command**

Table 4.23 shows the status report definitions and message formats for each test.

**Table 4.23 STA Command Report**

Status Report Designator	Definition	Message Format
FID	Firmware identifier string	Text Data
RFID	FPGA Firmware identifier string	Text Data
BFID	SELBOOT Firmware identifier string	Text Data
Part Number	Part Number of the SEL-3031	Text Data
PORT 1, 2, 3	Protocol setting for Port 1, 2, and 3	STANDARD, MB8, MODBUS
FLASH	Nonvolatile memory integrity	OK/FAIL
SDRAM	Integrity of code that runs in RAM	OK/FAIL
RADIO	Radio module status	OK/FAIL
RTC	Real-Time Clock status	OK/FAIL
SEC	SEL-3044 Encryption Card status	OK/ABSENT/RESET/FAIL

## TIME Command

Use **TIME** to return information about the SEL-3031 internal clock, as shown in Table 4.24. You can specify hours and minutes (seconds data are optional). Separate the hours, minutes, and seconds with colons, semicolons, spaces, commas, or slashes.

**Table 4.24 TIME Command Definitions**

Command	Description	Access Level
<b>TIME</b>	Displays the present internal clock time.	1
<b>TIME</b> <i>hh:mm</i>	Sets the internal clock to <i>hh:mm</i> .	1
<b>TIME</b> <i>hh:mm:ss</i>	Sets the internal clock to <i>hh:mm:ss</i> .	1

Enter **TIME** *hh:mm* and **TIME** *hh:mm:ss* to set the internal clock time. The value *hh* is for hours 0–23; the value *mm* is for minutes 0–59; the value *ss* is for seconds 0–59. If you enter a valid time, the device will update, save the time in nonvolatile memory, and display the time entered. If you enter an invalid time, the SEL-3031 will respond with *Invalid Time*.

Preliminary Copy—Subject to Change

**This page intentionally left blank**

# Section 5

## Performance Monitoring, Testing, and Troubleshooting

---

### Overview

---

This section provides information on monitoring radio performance, testing, and troubleshooting. Because the SEL-3031 is equipped with extensive self-tests, traditional periodic test procedures may be eliminated or greatly reduced.

### Monitoring Radio Performance

---

This section describes the tools you can use to monitor and improve the radio performance. This section assumes that the radio link is up and running in service. There are several items that you can use to optimize the radio link. The first section explains how to optimize standard radio links using DNP3, Modbus<sup>®</sup>, or other byte-oriented protocols. The second section addresses monitoring the radio performance when using MIRRORRED BITS<sup>®</sup>.

### Monitoring and Improving Radio Link Performance

This section assumes the radio link is up and running with sufficient link availability. If the radio link is either not working or has very low availability view *Section 2: Installation* for information on properly installed and operating the radio.

Obtain access through the front USB port either with a terminal program or ACCELERATOR QuickSet<sup>®</sup> SEL-5030 Software. Access Level 1 and issue the **RAD** command (see *Figure 5.1*). The first value from the report is the RSSI receive signal strength indication. This is the level of received level strength of the radio given in dBm. A good radio link should have 15 dBm of margin to account for environmental conditions and signal fade. The SEL-3031 receiver is rated down to -97 dBm or -104 dBm with ARQ on. If you observe a fade margin of 15 dBm or greater then you are receiving a strong signal. If the fade margin is less than 15 dBm that does not mean the radio link will not work; it means that the performance and channel availability needs to be monitored. To increase the signal or availability numbers the radio antenna may need to be adjusted, output power increased, antenna replaced with a with a higher gain antenna, (not to exceed transmit power of 36 dBm EIRP), or the SKIP setting used to avoid zones with low availability. A path study should always be done before the

radio is installed. The RSSI value should match to the results of the path study. If the path study numbers do not match the actual results then either the data entered is incorrect or information about the locations was omitted. Contact SEL if you cannot get the calculated values to match the measured values.

---

RADIO 1	Date: 09/11/2009	Time: 10:54:26		
STATION_A	Time Source: Internal			
RSSI				
-46 dBm				
AVAILABILITY: From 09/11/2009 10:53:50				
Overall				
100.00 %				
Zone 1	Zone 2	Zone 3	Zone 4	Zone 5
100.00 %	100.00 %	100.00 %	100.00 %	100.00 %
Zone 6	Zone 7	Zone 8	Zone 9	Zone 10
100.00 %	100.00 %	100.00 %	100.00 %	100.00 %

---

**Figure 5.1 Example RAD Command**

If you are using directional antennas, verify they have identical orientation—both sides must be either polarized horizontally or vertically. Typically, a vertically polarized antenna will give better results than a horizontally polarized antenna. If the location of the radio antenna is shared with other antennas operating at the same frequency, then proper spacing and opposite polarization should be used on one set of the antennas, along with using the SKIP setting. If two or more SEL-3031 radios are collocated using SEL Hop-Sync, see *Configuring Collocated Antennas Using SEL Hop-Sync Technology on page 3.16*. See *Section 2: Installation* for more information on antenna installation. Check the aiming of the antenna while updating the **RAD** command until you get the strongest signal. This will require two people, where one person is moving the position of the antenna in small increments, while the other is monitoring the RSSI. The antenna position must be rotated on both sides to obtain the highest signal strength. The RSSI must also be reviewed on each radio. The receive strength on the remote radio will likely be different than the received strength on the master radio.

The last step to check is the availability of the radio link. The **RAD** command gives the overall availability of the link. For protection systems the desire is to have a radio link between 95 and 99.95 percent availability. This overall availability number is a great way of directly obtaining this number. If you are running MIRRORED BITS then use the availability number in the communications report in the MIRRORED BITS device.

---

**NOTE:** The radio and the MIRRORED BITS report measure availability differently. Use the radio availability numbers for proper radio installation. Use the MIRRORED BITS communications report numbers when measuring the overall availability of your protection or control communications channel.

To get a good availability reading, issue a **RAD C** command from Access Level 2. This will reset all of the availability numbers. Let the radio link run for a couple of days or longer. The longer period of time, the more accurate the numbers. After a few days have passed issue the **RAD** command and view the availability numbers. If the overall availability number is less than desired then look at the availability numbers per zone. If all of the zones are down in availability then more adjustment is needed on the antennas. If a few of the zones are down by a large percentage and the rest are acceptable then go back to the radio settings and change the SKIP zone setting. Enter the zones, as many as six, that you want to skip with the lowest availability. Issue a **RAD C** command and let the radio run for a couple of days.

---

**NOTE:** If the radio availability is above 85%, there is, at best, a marginal gain for skipping that zone.

You may need to repeat these steps before the availability reaches the desired level. Note: There are 16 zones available in the SEL-3031 where a radio link only uses a maximum of 10 zones. Skipping zones will turn on zones not previously used and may give worse performance. The default SKIP setting of NONE will make the SEL-30310 SKIP zones 11–16, or force the Brazilian SEL-30311 to skip zone 16. If the availability between the zones only varies by a few percent then changing the SKIP setting will not help. The SKIP setting is for avoiding areas with high levels of noise, not to overcome multipath propagations.

If the overall availability of most of the zones is bad (below 85%) and positioning the antenna did not help then the radio link has a large amount of interference or there is an obstruction to the Fresnel zone that is causing reflection issues. The interference can be caused by a number of items. A path study is critical to determine how good the line-of-sight is and how high the antennas need to be. If the path study results do not match your actual results you will need to make sure all of the parameters used to make the path study were correct. If the results still do not match then there is an unaccounted obstruction in the path (either buildings or trees) that is causing the decrease in availability. View *Section 2: Installation* for more information on properly installing the antenna. If the availability numbers are less than desired then the problem is within the location, interference, or multipath radio issues. If the antenna tower is not located high enough and proper steps are not done to detect noise floors or obstructions to the Fresnel zone then the availability numbers may not reach those used in the path study.

## Monitoring MIRRORED BITS Performance

When using one, two, or three ports of the SEL-3031 for MIRRORED BITS communications it is important to monitor the availability of the channel. The SEL-3031 provides channel availability information and the MIRRORED BITS devices each contain communications data for each MIRRORED BITS channel. This section describes how these work and how to optimize the MIRRORED BITS channel to achieve a high level of availability.

The end of the previous section describes how to measure the availability of the radio link. All SEL relays that have MIRRORED BITS give a full channel monitoring report that will give the unavailability and a report on all of the data drops. The SEL-3031 displays the availability and SEL MIRRORED BITS devices display the unavailability. The relationship of the two is represented below.

$$\text{Availability} = 1 - \text{Unavailability}$$

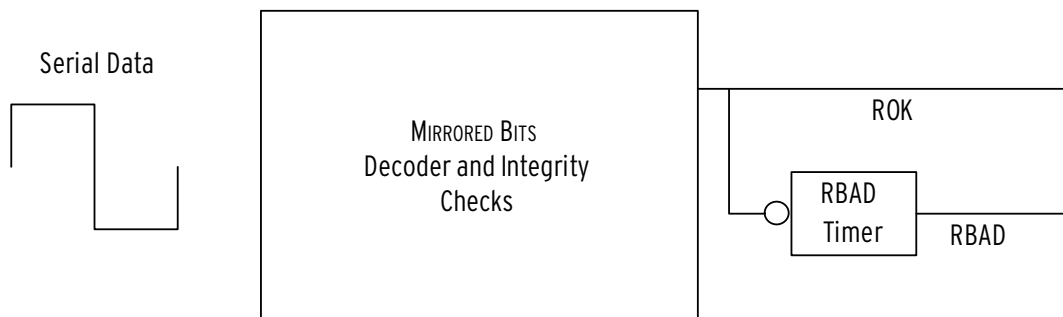
The SEL-3031 will show a lower availability than shown by the SEL relays with MIRRORED BITS. The difference lies in how the radio monitors each packet of MIRRORED BITS. Upon detecting bad packets the SEL-3031 removes the packets before they reach the relay. The relay will only declare a dropped channel if it receives bad data or after a period of time expires without seeing a new data packet. This gives the SEL-3031 a chance to ride through several bad hops, remove corrupted data, keep the channel up and operating, and minimize the amount of total unavailability as seen by the MIRRORED BITS devices.

Before you use an SEL device’s MIRRORED BITS communications report, make sure you go through *Monitoring and Improving Radio Link Performance* to verify the radio is optimized and the SKIP setting is set to avoid noisy zones.

Monitoring MIRRORED BITS performance over a radio link is critical to ensure proper operation when called upon to operate. The RBAD and CBAD bits provided in every SEL device with MIRRORED BITS can be used to alarm when the radio link is degraded below levels needed for proper operation.

- **RBADPU:** Setting for the amount of time the channel is in a failed state before setting the RBAD alarm Relay Word bit.
- **CBADPU:** Setting for the threshold of the CBAD channel availability alarm.

When a MIRRORED BITS channel is operating correctly, Relay Word bit ROK is set to 1. When the channel is disturbed, ROK drops out. The ROK bit is not recommended for use as an alarm point. ROK is a good indication of the channel’s health. If the ROK bit is toggling, this is an indication of an intermittent channel problem.



**Figure 5.2 RBAD Generation**



The RBAD bit is generated by the output of the RBAD timer. The RBAD timer is driven by the ROK signal. RBAD is the recommended bit to indicate communications alarms. Typically, a communications outage of two seconds or greater is considered an alarm condition. RBAD should be set on both MIRRORRED BITS device to the maximum length of outage before declaring an alarm.

The CBADPU setting is generated from the unavailability of the MIRRORRED BITS channel. For example, if RBADPU is set to 2 seconds and the longest channel disruption was 1 second out of every second and this occurred every 2 seconds, RBAD would not assert. RBAD would not assert because MIRRORRED BITS is not disrupted for longer than 2 seconds at any time. Relay Word bit CBAD and the CBADPU setting solves this problem. To set CBADPU there are two good options. The first option is to set it to 2000. This is a common value used based upon spread spectrum radio use in the field. The CBAD Relay Word bit will assert when the unavailability of the channel exceeds 0.02.

The other method in setting CBAD is to let the radio link run for a period of time and monitor the performance. After reviewing a month of unavailability you will be able to set CBADPU above the unavailability value.

The proper setting and use of CBAD and RBAD is important to report when the communications link has failed or has become intermittent enough to cripple proper communication. Over time, many issues can occur to cause a bad or intermittent radio link. Items such as tree growth, new building construction, or another radio added at the site or in the path of the current radio link. It is important to take CBAD and RBAD and use them in the relay to trigger an alarm condition through an output contact or have the SCADA system detect the alarm. Line-of-site radio paths can experience adverse conditions over time and it is critical to constantly monitor the radio performance to keep the availability numbers as high as possible.

## Self-Test

---

All self-tests are described in *Table 5.1*. If all diagnostic tests are passed, the **ENABLED** LED is on, the **ALARM** LED is off, and the contact output is open. If the device is disabled, the **ENABLED** LED is off, the **ALARM** LED is illuminated, and the contact output is closed.

**Table 5.1 Device Self-Tests (Sheet 1 of 2)**

Self-Test	Description	SER Message	Alarm LED	Alarm Contact
FPGA Version Mismatch	Fails if FPGA registers do not match expected.	Yes	On	Closed
Data RAM	Performs read/write tests on each section of Data RAM.	Yes	On	Closed

**Table 5.1 Device Self-Tests (Sheet 2 of 2)**

Self-Test	Description	SER Message	Alarm LED	Alarm Contact
Code RAM	Performs a comparison test against code flash.	Yes	On	Closed
Code Flash	Checksum is continually computed on code base.	No	On	Closed
Flash (Settings)	Performs a validity test every hour on the settings.	Yes	On	Closed
Processor Exception	Indicates processor failure.	Yes	On	Closed
RTC	Indicates clock chip static RAM failures.	Yes	On	Closed

## Troubleshooting

**Table 5.2 Troubleshooting Tips (Sheet 1 of 2)**

Symptom	Probable Cause	Corrective Action
ALARM LED is ON	Radio recognized a status failure.	Turn unit off, and then on, and issue the <b>STATUS</b> command. If alarm signal returns, return unit to the factory for repair.
ALARM LED flashes ON every half second.	Radio detected a VSWR error where there is an open or short on the antenna port.	Verify all connections from the antenna to the radio are secure. Verify the antenna, feedlines, or lightning arrestor is not damaged.
The SEC LED is flashing.	The SEL-3031 properly detects the encryption card but the card is in reset and doesn't have the key set.	Use QuickSet and set the KEY setting. This must be set the same on both radios.
Cannot connect to the radio through the USB port.	USB driver not installed properly.	Check for active SEL to USB drivers from your PC in Device Manager Ports section. If that does not work, uninstall and reinstall the driver and restart your PC. Make sure the SEL-3031 is powered on before plugging in the USB cable.

**Table 5.2 Troubleshooting Tips (Sheet 2 of 2)**

Symptom	Probable Cause	Corrective Action
Cannot change radio settings.	Invalid password.	Install password disable jumper and change passwords using the <b>PAS</b> command. See <i>Password Jumper on page 2.14</i> for information on how to disable passwords.
Wall-mount radio will not turn on.	The polarity of the power supply wires is reversed.	Check the correct polarity and reverse if incorrect.
The remote radio will not link up to the master.	Radio address or mode is not set correctly.	The master and remote radios must be set to the same address and have the same <b>SKIP</b> settings. Check that the master radio <b>LINK</b> light is <b>ON</b> and that the <b>NID</b> address and <b>SKIP</b> setting is set correctly on both units.
	Antennas are not pointed correctly, or there is a bad antenna cable.	Use <b>QuickSet</b> on the radio to issue the <b>RAD</b> command to check for signal strength. If the signal is low, try to re-aim both antennas to gain signal strength and check for bad antenna cables. See <i>Section 2: Installation</i> for more information on proper radio installation.

Preliminary Copy—Subject to Change

**This page intentionally left blank**

# Appendix A

## Firmware and Manual Versions

### Firmware

#### Determining the Firmware Version in Your Device

To determine the firmware version, view the status report by using the serial port **STATUS** command. The status report displays the Firmware Identification (FID) number.

The firmware version number is after the R, and the release date is after the D. For example, the following string shows firmware version number 100 with a release date of October 9, 2009:

```
FID=SEL-3031-R100-V0-Z001001-D20091009
```

Table A.1 lists the firmware versions, revision descriptions, and corresponding instruction manual date codes.

**Table A.1 Firmware Revision History (Sheet 1 of 2)**

Firmware Identification (FID) Number	Summary of Revisions	Manual Date Code
SEL-3031 Firmware Version: SEL-3031-R104-V0-Z003001-D20111228 FPGA Version: SEL-3031-R101-D20101018 SEL-3044 Firmware Version: SEL-3044-R102-V0-Z001001-D20111223  <b>Note:</b> The SEL-3044 Encryption Card can only be upgraded by sending the card back to the factory. Please contact the factory for assistance.	<ul style="list-style-type: none"> <li>➤ Fixed an issue in the SEL-3044 where the random number generator seed issued matching back-to-back samples that caused the card to stop passing data.</li> <li>➤ Fixed an issue in the SEL-3044 where time-out behavior is treated as a hard failure causing the card to stop communicating.</li> <li>➤ Corrected a key-handling issue in the SEL-3044 forcing the master to set the sequence key to 0 every time the slave requests a new key.</li> </ul>	20111228

**Table A.1 Firmware Revision History (Sheet 2 of 2)**

Firmware Identification (FID) Number	Summary of Revisions	Manual Date Code
	<ul style="list-style-type: none"> <li>➤ Fixed an issue in the SEL-3044 where the rollover of the encryption key could get repeated indefinitely and cause communications to stop.</li> <li>➤ Fixed an issue in the SEL-3044 where the master could receive a repeated message from the radio that should have been dropped, causing the SEL-3044 to stop processing incoming data.</li> </ul>	
Firmware Version: SEL-3031-R103-V0-Z003001-D20110818 FPGA Version: SEL-3031-R101-D20101018 <b>Note:</b> You must update both firmware and FPGA for proper operation.	<ul style="list-style-type: none"> <li>➤ Fixed issue that prevented the encryption card from rekeying under certain conditions, which also stopped communication.</li> <li>➤ Created Brazil frequency compatible version.</li> <li>➤ Added 9600 bps speed setting option to all ports in radios without encryption cards.</li> </ul>	20110818
Firmware Version: SEL-3031-R102	<ul style="list-style-type: none"> <li>➤ This firmware version was not production released.</li> </ul>	—
Firmware Version: SEL-3031-R101-V0-Z002001-D20101108 FPGA Version: SEL-3031-R101-D20101018 <b>Note:</b> You must update both firmware and FPGA for proper operation.	<ul style="list-style-type: none"> <li>➤ Added P2MP capability.</li> <li>➤ Added the capability to synchronize collocated radios.</li> <li>➤ Added ARQ for non-MIRRORED BITS applications.</li> <li>➤ Improved the STA command with more radio information.</li> <li>➤ Added 38400 bps option on Port 1 (19200 bps with Encryption Card).</li> </ul>	20101108
SEL-3031-R100-V0-Z001001-D20091009	<ul style="list-style-type: none"> <li>➤ Initial version.</li> </ul>	20091009

## Instruction Manual

The date code at the bottom of each page of this manual reflects the creation or revision date.

Table A.2 lists the instruction manual versions and revision descriptions. The most recent instruction manual version is listed first.

**Table A.2 Instruction Manual Revision History (Sheet 1 of 3)**

Date Code	Summary of Revisions
20181001	<p><b>Section 1</b></p> <ul style="list-style-type: none"> <li>➤ Updated <i>Specifications</i>.</li> </ul>
20180613	<p><b>Section 1</b></p> <ul style="list-style-type: none"> <li>➤ Updated <i>Table 1.1: Radio Antenna and Cable Accessories</i>.</li> </ul> <p><b>Section 2</b></p> <ul style="list-style-type: none"> <li>➤ Updated <i>Table 2.2: Antennas Permitted for Use with the SEL-3031</i>.</li> </ul> <p><b>Section 4</b></p> <ul style="list-style-type: none"> <li>➤ Updated <i>Table 4.14: Factory-Default Passwords</i>.</li> <li>➤ Updated <i>Table 4.18: SER Command</i>.</li> </ul>
20180330	<p><b>Section 1</b></p> <ul style="list-style-type: none"> <li>➤ Updated <i>Compliance in Specifications</i>.</li> </ul> <p><b>Appendix B</b></p> <ul style="list-style-type: none"> <li>➤ Updated <i>Technical Support</i>.</li> </ul>
20160804	<p><b>Section 1</b></p> <ul style="list-style-type: none"> <li>➤ Updated <i>Table 1.1: Radio Antenna and Cable Accessories</i>.</li> </ul>
20160203	<p><b>General</b></p> <ul style="list-style-type: none"> <li>➤ Updated cable information to include RG-8X.</li> </ul> <p><b>Section 1</b></p> <ul style="list-style-type: none"> <li>➤ Updated <i>Table 1.1: Radio Antenna and Cable Accessories</i>.</li> </ul>
20150203	<p><b>Preface</b></p> <ul style="list-style-type: none"> <li>➤ Updated <i>Safety Information</i>.</li> </ul> <p><b>Section 1</b></p> <ul style="list-style-type: none"> <li>➤ Updated <i>Table 1.1: Radio Antenna and Cable Accessories</i>.</li> <li>➤ Added <i>Figure 1.1: Radio Antenna Connections</i>.</li> <li>➤ Changed <i>Certifications</i> to <i>Compliance</i>, and moved it to the beginning of <i>Specifications</i>.</li> <li>➤ Added <i>Power Consumption With SEL-3044 Card in Specifications</i>.</li> <li>➤ Updated <i>Table 1.2: Government Approvals</i>.</li> </ul> <p><b>Section 2</b></p> <ul style="list-style-type: none"> <li>➤ Updated <i>Figure 2.6: SEL-C693 Cable: Two-Wire EIA-485 Connections</i>.</li> </ul> <p><b>Section 4</b></p> <ul style="list-style-type: none"> <li>➤ Added CAL Level information.</li> </ul> <p><b>Section 5</b></p> <ul style="list-style-type: none"> <li>➤ Updated fade margin and radio availability information in <i>Monitoring and Improving Radio Link Performance</i>.</li> </ul>

**Table A.2 Instruction Manual Revision History (Sheet 2 of 3)**

Date Code	Summary of Revisions
	<p><b>Appendix A</b></p> <ul style="list-style-type: none"> <li>▶ Updated <i>Table A.1: Firmware Revision History</i> with correct FPGA version.</li> </ul>
20141120	<p><b>Section 1</b></p> <ul style="list-style-type: none"> <li>▶ Updated surge protection description and part number in <i>Table 1.1</i>.</li> </ul> <p><b>Section 2</b></p> <ul style="list-style-type: none"> <li>▶ Updated surge protection information in <i>Lightning Protection</i>.</li> </ul>
20130208	<p><b>Section 1</b></p> <ul style="list-style-type: none"> <li>▶ Added UL, cUL, and FIPS 140-2 certification information to <i>Specifications</i>.</li> </ul>
20111228	<p><b>Appendix A</b></p> <ul style="list-style-type: none"> <li>▶ Updated for SEL-3031 firmware version R104.</li> <li>▶ Updated for SEL-3044 firmware version R102.</li> </ul>
20111005	<p><b>Section 1</b></p> <ul style="list-style-type: none"> <li>▶ Added certification information for Colombia to <i>Specifications</i>.</li> <li>▶ Added Brazil ANATEL Numbers to <i>Specifications</i>.</li> </ul> <p><b>Section 2</b></p> <ul style="list-style-type: none"> <li>▶ Added Colombia to list of countries allowing six skip zones.</li> </ul>
20110818	<p><b>Section 1</b></p> <ul style="list-style-type: none"> <li>▶ Added 9600 bps SPEED setting option for radios without encryption cards.</li> <li>▶ Updated port speed option and latency tables in <i>Specifications</i> to reflect 9600 bps SPEED setting option for radios without encryption cards.</li> <li>▶ Added certification information for Brazil, Mexico, and Peru to <i>Specifications</i>.</li> </ul> <p><b>Section 2</b></p> <ul style="list-style-type: none"> <li>▶ Added 9600 bps SPEED setting option for radios without encryption cards.</li> <li>▶ Added 303011Brazil locked skip frequencies.</li> <li>▶ Added <i>Table 2.4: 900 MHz Frequency Skip Zones for Brazil (part numbers starting with SEL-30311)</i>.</li> </ul> <p><b>Section 3</b></p> <ul style="list-style-type: none"> <li>▶ Added 9600 bps SPEED setting option for radios without encryption cards.</li> </ul>



**Table A.2 Instruction Manual Revision History (Sheet 3 of 3)**

Date Code	Summary of Revisions
	<p><b>Section 4</b></p> <ul style="list-style-type: none"> <li>➤ Added 9600 bps SPEED setting option for radios without encryption cards.</li> <li>➤ Added 303011Brazil locked skip frequencies.</li> <li>➤ Added <i>Table 4.6: Skip Zone Frequencies (SEL-30311 Brazil)</i>.</li> </ul> <p><b>Appendix A</b></p> <ul style="list-style-type: none"> <li>➤ Updated for firmware version R103.</li> </ul>
20101108	<p><b>Section 1</b></p> <ul style="list-style-type: none"> <li>➤ Added P2MP capability to product features.</li> <li>➤ Included additional antenna accessories in <i>Table 1.1: Radio Antenna and Cable Accessories</i>.</li> </ul> <p><b>Section 2</b></p> <ul style="list-style-type: none"> <li>➤ New SEL Sync-Hop for collocated radios.</li> <li>➤ Updated <i>Table 2.9: SEL-3031 Port Description</i> for Port 3 radio synchronizing capability.</li> <li>➤ Added <i>Figure 2.12: SEL Cable C576: Synchronizing Cable for SEL-3031</i>, new cables for synchronizing radios.</li> </ul> <p><b>Section 3</b></p> <ul style="list-style-type: none"> <li>➤ Added two more Job Done examples.</li> </ul> <p><b>Section 4</b></p> <ul style="list-style-type: none"> <li>➤ Added P2MP capability to product features.</li> <li>➤ Updated <i>Figure 4.9: Radio Strength and Channel Availability</i> with new graphical Radio Status.</li> <li>➤ Updated <i>Table 4.4: Radio Settings</i> with P2MP and synchronizing settings.</li> <li>➤ Added information on SYNC and KEY settings.</li> <li>➤ Updated <i>Table 4.6: Port Settings</i> with SPEED and ARQ.</li> </ul> <p><b>Appendix A</b></p> <ul style="list-style-type: none"> <li>➤ Updated for firmware version R101.</li> </ul> <p><b>Appendix B</b></p> <ul style="list-style-type: none"> <li>➤ Added <i>Firmware Upgrade Instructions</i>.</li> </ul>
20091009	<ul style="list-style-type: none"> <li>➤ Initial version.</li> </ul>

Preliminary Copy—Subject to Change

**This page intentionally left blank**

# Appendix B

## Firmware Upgrade Instructions

---

### Overview

---

SEL may occasionally offer firmware upgrades to improve the performance of your radio. The radio stores firmware in Flash memory; therefore, changing physical components is not necessary. A firmware loader program called SELBOOT resides in the SEL-3031. These instructions give a step-by-step procedure to upgrade the radio firmware by uploading a file from a personal computer to the radio via direct connection to the USB management port.

### Required Equipment

You will need the following to perform a firmware upgrade.

- Personal computer
- Terminal emulation software that supports the Xmodem/CRC protocol (these instructions use HyperTerminal® from a Microsoft® Windows® operating system)
- USB Type-B cable (SEL-C664 or equivalent)
- The firmware upgrade file (Rxxx3031.img)

### Firmware Upgrade Procedure

- Step 1. Connect a standard USB Type-B cable from the PC to the management port of the SEL-3031, and enter Access Level 2.
  - a. Type **ACC** <Enter>.
  - b. Enter the Access Level 1 password.
  - c. Type **2AC** <Enter>.
  - d. Enter the Access Level 2 password.
- Step 2. Start the upgrade process.
  - a. Issue the **L\_D** command to the radio.
  - b. Type **Y** <Enter> at the following prompt:

---

```
Disable device to receive firmware (Y,N) ?
```

---

- c. Type **Y** <Enter> at the following prompt:

---

Are you sure (Y, N)?

---

The radio will respond with the following message and send the !> prompt.

---

Device disabled

---

- Step 3. Issue the **BAU 115200** command. On your terminal or computer terminal program, change the terminal data rate to 115200 bps.
- Step 4. Begin the transfer of the new firmware to the radio by issuing the **REC** command.
- Step 5. Type **Y** to erase the existing firmware, or press <Enter> to abort.
- Step 6. Start the file transfer.
- Select the send file option in your communications software.
  - Use the Xmodem or 1K Xmodem protocol and send the file that contains the new firmware.

After the file transfer, the radio reboots and returns to Access Level 0. Change the terminal data rate back to 9600 bps to access the radio management port.

- Step 7. Press any key (e.g., <Enter>) when the radio sends a prompt.
- Step 8. Type **ACC** <Enter>. Enter the Access Level 1 password.

---

=>>L\_D <Enter>

Disable device to receive firmware (Y,N) ? <Enter>

Are you sure (Y/N) ? Y <Enter>

Device disabled

!>REC <Enter>

Caution! This command erases the firmware.

If you erase the firmware then new firmware

must be loaded before returning the IED to service.

Are you sure, you want to erase the existing firmware (Y/N)?

Y <Enter>

Erasing firmware.

Erase successful.

Press any key to begin transfer and then start transfer at the terminal.

---

- Step 9. Issue the **STA** command, and examine the status report for FAIL messages.

If the status report shows a FAIL message, perform the following steps.

- a. Type **2AC <Enter>**.
- b. Enter the Access Level 2 password.
- c. Type **R\_S <Enter>**.
- d. At this time you must reenter passwords.
- e. Type **ACC <Enter>**.
- f. Enter the Access Level 1 password
- g. Type **2AC <Enter>**.
- h. Enter the default Access Level 2 password.
- i. Use the **PAS** command to change the default password to your secure password (refer to the *SEL-3031 Instruction Manual*).

- Step 10. Turn the radio off and back on.

This completes the firmware upgrade instructions. If you have an FPGA configuration upgrade, continue with the following procedure.

## FPGA Configuration Upgrade Procedure

- Step 1. Connect input power.
- Step 2. Connect a standard USB Type-B cable from the PC to the management port of the SEL-3031, and enter Access Level 2.
- Step 3. Start upgrading of firmware.
  - a. Issue the **L\_D** command to the radio.
  - b. Type **Y <Enter>** at the following prompt:

---

```
Disable device to receive firmware (Y,N) ?
```

---

- c. Type **Y <Enter>** at the following prompt:

---

```
Are you sure (Y, N)?
```

---

The radio will respond with the following message and send the **!>** prompt.

---

```
Device disabled
```

---

# Preliminary Copy—Subject to Change

- Step 4. Issue the **BAU 115200** command, and change the terminal data rate to 115200.
- Step 5. Begin the transfer of the new FPGA configuration file (RTL\_Rxxx3031.cxf) to the radio by issuing the **REC FPGA** command.
- Step 6. Type **Y** to erase the existing FPGA configuration or press **<Enter>** to abort.
- Step 7. Press any key (e.g., **<Enter>**) when the radio sends a prompt.
- Step 8. Start the file transfer.
  - a. Select the send file option in your communications software.
  - b. Use the Xmodem protocol and send the file that contains the new firmware.

After the file transfer, the radio will reboot and return to Access Level 0.

- Step 9. The FPGA upgrade will cause the radio to restart (equivalent to removing and restoring power). On most PCs you will need to exit and restart the terminal program for it to re-recognize the serial port. Change the terminal data rate back to 9600 bps to access the radio management port.

---

```
=>>L_D <Enter>
Disable device to receive firmware (Y,N) ? Y <Enter>
Are you sure (Y/N) ? Y <Enter>
Device disabled

!>REC FPGA <Enter>
Caution! This command erases the FPGA.
Do not interrupt power during FPGA upload
or the device may require factory reprogramming.

Are you sure you want to erase the existing FPGA (Y/N)? Y <Enter>
Press any key to begin transfer and then start transfer at the terminal.

Completed FPGA configuration upload into RAM.
Beginning FPGA reconfiguration.
Erasing FPGA ... (15 seconds) ... Done.
Configuring FPGA.
37 .....
36 .....
35 .....
34 .....
33 .....
32 .....
31 .....
30 .....
29 .....
28 .....
27 .....
26 .....
25 .....
24 .....
23 .....
22 .....
21 .....
20 .....
19 .....
18 .....
```

```

17 .....
16 .....
15 .....
14 .....
13 .....
12 .....
11 .....
10 .....
9 .....
8 .....
7 .....
6 .....
5 .....
4 .....
3 .....
2 .....
1 .....
FPGA Configuration complete.....

```

---

The SEL-3031 now is ready for commissioning.

## Technical Support

---

We appreciate your interest in SEL products and services. If you have questions or comments, please contact us at:

Schweitzer Engineering Laboratories, Inc.  
2350 NE Hopkins Court  
Pullman, WA 99163-5603 USA  
Telephone: +1.509.338.3838  
Fax: +1.509.332.7990  
Internet: [selinc.com/support](http://selinc.com/support)  
Email: [info@selinc.com](mailto:info@selinc.com)

Preliminary Copy—Subject to Change

**This page intentionally left blank**



# Appendix C

## SEL-3044 Encryption Card

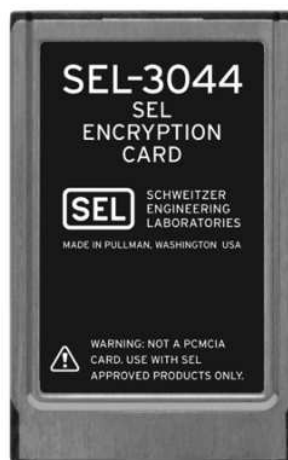
---

### Overview

---

The SEL-3044 Encryption Card is a standalone card that can be added to the SEL-3031 to encrypt the radio data being sent between SEL-3031 radio links. The SEL-3044 can be ordered at time of purchase or added as an upgrade. The SEL-3044 requires one setting to provide a very strong level of encryption over the radio link. Use of the SEL-3044 is strongly advised for any application of the SEL-3031 for critical data. If you do not use the SEL-3044, the data between the radios can be compromised. If you want to encrypt the radio link, an SEL-3044 is required in both radios.

**NOTE:** The SEL-3044 is NOT a PCMCIA card. Do not install in a laptop computer.



**Figure C.1** SEL-3044 Encryption Card

## NIST FIPS 140-2 Level 2 Security Requirements

---

The National Institute of Standards and Technology (NIST) developed the Federal Information Processing Standards (FIPS) 140-2 standard that defines the security requirements for a cryptographic module used within a security system protecting sensitive information in computer and telecommunications systems.

Protection of a cryptographic module within a security system is necessary to maintain the confidentiality and integrity of the information protected by the module. FIPS 140-2 Level 2 covers areas related to the secure design and implementation of a cryptographic module.

These areas include the following:

- Cryptographic module specification
- Cryptographic module ports and interfaces
- Roles, services, and authentication
- Finite state model
- Physical security
- Operational environment
- Cryptographic key management
- Electromagnetic interference/electromagnetic compatibility (EMI/EMC)
- Self-tests
- Design assurance
- Mitigation of other attacks

The SEL-3044 meets FIPS 140-2 Level 2 requirements and has been FIPS 140-2 validated (historical, pending re-validation). This level of data security provides assurance that best practices have been applied to the design, testing, and manufacturing of the SEL-3044.

## Theory of Operation—SEL Protocol

---

### Encryption Components

A cryptographic device consists of three components: encryption algorithm, key management, and device security functions.

### Encryption Algorithm

The Advanced Encryption Standard (AES) algorithm with a key length of 256 bits is implemented in the SEL-3044. This algorithm is a secure means of encrypting data. The AES algorithm and key length provide proven resistance to modern cryptanalysis.

## Key Management

**System key (256 bits):** The system key is set by a passphrase of 8 to 80 characters. The passphrase is used to generate a system key. The system key is used to encrypt and securely transmit unique session keys (see following text). It also provides a cryptographic authentication mechanism for rejecting session requests by unauthorized SEL-3044 devices.

**Session key (256 bits):** Session keys are used to encrypt all protected user data prior to transmission. They are produced at system startup and periodically during sessions. Session keys are generated using the process outlined by FIPS 186-2. They are produced using an integrated physical random number generator (RNG) and a statistical data whitening algorithm. Session keys are purely random and are not linked to the system key. The use of unique session keys limits the amount of data that is encrypted with a single key value, thus strengthening the system against cryptanalytical attack. The session keys are encrypted using the system key prior to being exchanged between SEL-3044 devices.

## Device Security

The SEL-3044 incorporates a hardware RNG and FIPS-approved data whitener to guarantee that all session keys contain 256 bits of entropy (i.e., completely random). This guarantees that encoded messages are protected by a true cryptographic strength of 256 bits.

Multilevel password authentication defines user security roles.

Changing the system key can only be performed by authorized users who have Access Level 2 passwords.

If required, an authorized user can reset the entire device. This allows the user to reinitialize the system key should the security parameters need to change because of IT security procedures or if the programmed system key value is lost.

**NOTE:** This process requires physical access to the SEL-3031 and cannot be done remotely.

## Security of the Transferred Data

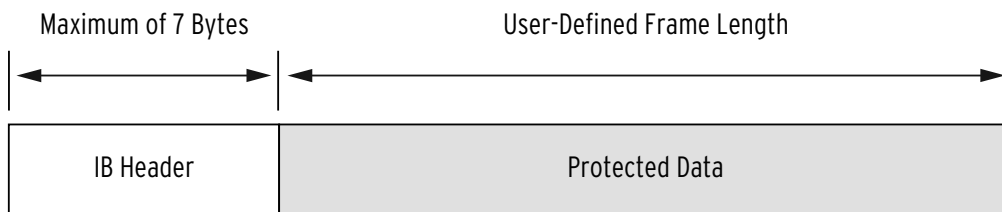
The SEL-3044 provides data encryption with a cryptographic key strength of 256 bits. The SEL-3044 RNG is designed so that all possible key values are equally likely. It is widely accepted throughout the cryptographic community that it is not realistically possible to mount a successful brute force (key guessing) attack on a 256-bit key space with technology available today.

## Application Consideration

Two messaging structures exist to establish and maintain a secure, coherent communications link between two SEL-3044 devices: In-Band (IB) frames and Out-of-Band (OOB) frames. IB frames transmit encrypted user data (i.e., data received on the trusted data interface) between the two protected devices (computer, IED, RTU, etc.). OOB frames transmit connection control data between the two SEL-3044 devices in the communications link. Control frames are required to implement key exchanges, status checks, and other functions necessary to maintain the communications link.

## In-Band Message Format

IB messages consist of the encrypted data plus the frame overhead necessary to maintain synchronization and channel security. *Figure C.2* shows the format of an IB frame. The shaded area is the encrypted data portion of the message.



**Figure C.2 In-Band Data Packet Format**

## Out-of-Band Message

Out-of-Band (OOB) messages are used to exchange control information between SEL-3044 cards. These exchanges include loss of synchronization, request for rekey, and rekey information.

**IMPORTANT:** During OOB message communication, data exchange between the devices connected to the SEL-3044 cannot occur. Communication will be temporarily halted during a rekey.

## System Settings

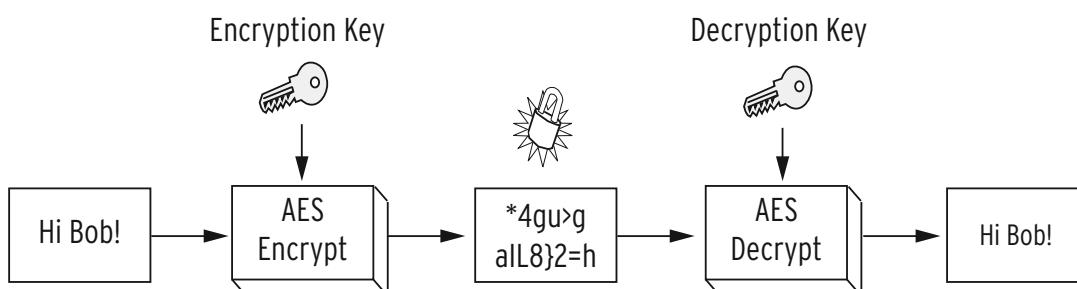
The system key provides encryption and secure transmission of unique session keys between SEL-3044 devices. It also provides a cryptographic authentication mechanism for rejecting session requests by unauthorized devices. Session keys provide encryption of all protected user data prior to transmission. An SEL-3044 produces session keys at system startup, and periodically during sessions, using the process outlined by FIPS 186-2. An integrated physical RNG and statistical data-whitening algorithm generate purely random session keys. Through the use of these unique session keys, the SEL-3044 limits the amount of data encrypted by any single key value, thus strengthening the system against attack.

**NOTE:** Both SEL-3044 transceivers that communicate with each other must share the same system key.

## AES Overview

The AES encryption function uses a 256-bit-long secret key and scrambles the contents of each frame prior to transmission to provide cryptographically strong data confidentiality.

Encryption is the process of transforming a digital message from its original form into a form that an unauthorized individual cannot interpret. The output of the encryption process is a function of the message and an encryption key (see *Figure C.3*).



**Figure C.3 Operation of the AES Encryption Function**

This encryption process must be completely reversible by an authorized individual with access to the secret decryption key. Authority to read a message is only granted by sharing knowledge of the secret decryption key. Ideally, only individuals with knowledge of the decryption key can reverse the encryption operation and interpret the protected message. There are two main classes of encryption functions. Symmetric key encryption relies on the same secret key value,  $K$ , to perform both the encryption and decryption transformations. Asymmetric key encryption, on the other hand, uses a different key for encryption and decryption for example, asymmetric encryption might use  $K_1$  for encryption and  $K_2$  for decryption. The AES encryption algorithm the SEL-3044 uses is a symmetric block cipher with an encryption/decryption key size of 256 bits.

The AES is the latest encryption standard adopted by NIST. In 1997, NIST challenged the cryptographic community to develop the next generation encryption algorithm to replace the aging DES and 3DES encryption standards. In 2000, NIST chose the Rijndael encryption algorithm as the AES encryption standard. During the evaluation of candidates for the AES standard, some of the world’s best cryptanalysts analyzed and approved Rijndael. Since its adoption in 2001, AES has proven to be very effective against known attacks, very efficient, and simple to implement.

## Frame Replay Protection

Every frame in a given session contains a sequence number field. The value in this field increments every time a frame is transmitted. The SEL-3044 will not accept any frame that contains a sequence number value that is less than, or equal to, the sequence number value received in the last frame. It is exceedingly difficult to maliciously alter the sequence number in any given frame to bypass this functionality because the sequence number field is protected by the strong cryptographic authentication mechanisms. Because of the protection these mechanisms provide, an attacker cannot capture a previously transmitted frame and resend the frame to the SEL-3044 to cause harmful actions.

## Resetting the SEL-3044

At some point it may be necessary to reset the SEL-3044. You must have access to the front USB port on the SEL-3031. The SEL-3044 must be installed in the SEL-3031 to reset. Use either ACSELERATOR QuickSet® SEL-5030 Software or a terminal interface to access the Radio settings. In the Radio settings, set the KEY setting to None, save the setting, then set a new passphrase and save.

If you have lost your passwords to access the SEL-3031, you must disable passwords by temporarily installing a jumper. Refer to *Password Jumper on page 2.14* and *Table 2.7* for information and instructions on disabling passwords.

## Installing an SEL-3044 in the SEL-3031

The SEL-3044 can be ordered at time of purchase of the radio, or it may be added later as a field upgrade. The process involves powering down the radio, removing hardware, installing the card, and setting the radio.

### CAUTION

The radio contains devices sensitive to Electrostatic Discharge (ESD). When working on the radio with the front or top cover removed, work surfaces and personnel must be properly grounded or equipment damage may result.

- Step 1. Remove the power from the radio and remove all connections from the device.
- Step 2. Rack-mount SEL-3031: Loosen the six front-panel screws and remove the front panel.  
  
Wall-mount model: Use a Torx® T15 screwdriver and remove the four screws located on the sides of each corner. Slide the cover up and back to reveal the front of the unit.
- Step 3. Between the main board and radio board there is a PCMCIA card slot. Gently slide the SEL-3044 straight into the card slot. Push firmly until it is fully seated.



**Figure C.4 Encryption Card Location**

- Step 4. Reassemble the unit in reverse order of Step 2.
- Step 5. Apply power to the unit and verify the **SEC** light is flashing. The flashing LED indicates that the SEL-3044 is functioning properly and is currently in Reset.  
  
If the **SEC** LED is not flashing, then you must turn off the unit and verify the card is properly seated in the pins.  
  
If the **SEC** LED does not flash upon your removing and restoring power and you have verified that the card is seated properly, you will need to send the radio and encryption card back for repair.
- Step 6. Use QuickSet to connect to the device and set the **KEY** setting to enable the SEL-3044.
- Step 7. The **KEY** setting must be set the same on both SEL-3031 transceivers for proper operation.

Preliminary Copy—Subject to Change

**This page intentionally left blank**



Preliminary Copy—Subject to Change

Preliminary Copy—Subject to Change



**SCHWEITZER ENGINEERING LABORATORIES, INC.**

2350 NE Hopkins Court • Pullman, WA 99163-5603 U.S.A.

Phone: +1.509.332.1890 • Fax: +1.509.332.7990

selinc.com • info@selinc.com