

## FCC 47 CFR PART 15 SUBPART E

Applicant : Control4

Product Type : 802.11ac 2x2 Wave 2 Access Point

Trade Name : pakedge

Model Number : WA-2200-1, WA-2200, WA-2200-C, WA-2200-C-1

Test Specification : FCC 47 CFR PART 15 SUBPART E  
ANSI C63.10:2013

Receive Date : Aug. 29, 2017

Test Period : Feb. 02 ~ Dec. 06, 2018

Issue Date : Dec. 24, 2018

### Issue by

A Test Lab Techno Corp.  
No. 140-1, Changan Street, Bade District,  
Taoyuan City 33465, Taiwan (R.O.C)  
Tel : +86-3-2710188 / Fax : +86-3-2710190



Taiwan Accreditation Foundation accreditation number: 1330  
Test Firm MRA designation number: TW0010

**Note:** This report shall not be reproduced except in full, without the written approval of A Test Lab Techno Corp. This document may be altered or revised by A Test Lab Techno Corp. personnel only, and shall be noted in the revision section of the document. The client should not use it to claim product endorsement by TAF, or any government agencies. The test results in the report only apply to the tested sample.



### **Revision History**

Rev.	Issue Date	Revisions	Revised By
00	Dec. 24, 2018	Initial Issue	Nina Lin

## Verification of Compliance

Issued Date: Dec. 24, 2018

Applicant : Control4  
Product Type : 802.11ac 2x2 Wave 2 Access Point  
Trade Name : pakedge  
Model Number : WA-2200-1, WA-2200, WA-2200-C, WA-2200-C-1  
FCC ID : R33WA2200  
EUT Rated Voltage : DC 12 V, 1 A  
Test Voltage : 120 Vac / 60 Hz  
Applicable Standard : FCC 47 CFR PART 15 SUBPART E  
ANSI C63.10:2013

Test Result : Complied

Performing Lab. : A Test Lab Techno Corp.  
No. 140-1, Changan Street, Bade District,  
Taoyuan City 33465, Taiwan (R.O.C)  
Tel : +86-3-2710188 / Fax : +86-3-2710190



Taiwan Accreditation Foundation accreditation number: 1330  
<http://www.atl-lab.com.tw/e-index.htm>

A Test Lab Techno Corp. tested the above equipment in accordance with the requirements set forth in the above standards. All indications of Pass/Fail in this report are opinions expressed by A Test Lab Techno Corp. based on interpretations and/or observations of test results. The test results show that the equipment tested is capable of demonstrating compliance with the requirements as documented in this report.

Approved By : Fly Lu Reviewed By : Eric Ou Yang  
(Manager) (Fly Lu) (Testing Engineer) (Eric Ou Yang)

## TABLE OF CONTENTS

<b>1</b>	<b>General Information .....</b>	<b>5</b>
1.1.	Summary of Test Result.....	5
1.2.	Measurement Uncertainty .....	6
<b>2</b>	<b>EUT Description .....</b>	<b>7</b>
<b>3</b>	<b>Test Methodology.....</b>	<b>9</b>
3.1.	Mode of Operation .....	9
3.2.	EUT Test Step.....	18
3.3.	Configuration of Test System Details .....	19
3.4.	Test Instruments .....	20
3.5.	Test Site Environment.....	21
<b>4</b>	<b>Measurement Procedure.....</b>	<b>22</b>
4.1.	AC Power Conducted Emission Measurement .....	22
4.2.	Transmitter Radiated Emissions Measurement.....	24
4.3.	Maximum Conducted Output Power Measurement.....	29
4.4.	26 dB RF Bandwidth Measurement & 99 % Occupied Bandwidth Measurement .....	30
4.5.	6 dB RF Bandwidth Measurement .....	31
4.6.	Maximum Power Spectral Density Measurement .....	32
4.7.	Frequency Stability Measurement.....	34
4.8.	Automatically discontinue transmission.....	35
4.9.	Antenna Requirement.....	35
<b>5</b>	<b>Test Results.....</b>	<b>37</b>
5.1.	AC Power Conducted Emission Measurement .....	37
5.2.	Transmitter Radiated Emissions Measurement.....	43
5.3.	Maximum Conducted Output Power Measurement.....	197
5.4.	26 dB RF Bandwidth Measurement & 99 % Occupied Bandwidth Measurement .....	202
5.5.	6dB RF Bandwidth Measurement .....	214
5.6.	Maximum Power Spectral Density Measurement .....	226
5.7.	Frequency Stability Measurement.....	260



# 1 General Information

## 1.1. Summary of Test Result

Standard	Item	Result	Remark
FCC			
15.407(b)(6) 15.207	AC Power Conducted Emission	PASS	---
15.407(b) 15.205 / 15.209	Transmitter Radiated Emissions	PASS	---
15.407(a)	Maximum Conducted Output Power	PASS	---
15.407(a)	26 dB RF Bandwidth	Reference	---
15.407(e)	6 dB RF Bandwidth	PASS	----
15.407(a)	Maximum Power Spectral Density	PASS	---
15.407(g)	Frequency Stability	PASS	---
15.407(c)	Automatically discontinue transmission	PASS	---
15.407(a) 15.203	Antenna Requirement	PASS	---

The test results of this report relate only to the tested sample(s) identified in this report.

Standard	Description
CFR47, Part 15, Subpart C	Intentional Radiators
CFR47, Part 15, Subpart E	Unlicensed National Information Infrastructure Devices
ANSI C63. 10: 2013	American National Standard of Procedures for Compliance Testing of Unlicensed Wireless Devices
KDB789033: D02	Guidelines for Compliance Testing of Unlicensed National Information Infrastructure (U-NII) Devices Part 15, Subpart E
KDB 662911 D01 v02r01	Emissions Testing of Transmitters with Multiple Outputs in the Same Band (e.g., MIMO, Smart Antenna, etc)

## 1.2. Measurement Uncertainty

Test Item	Frequency Range	Uncertainty (dB)
Conducted Emission	9 kHz ~ 150 kHz	2.7
	150 kHz ~ 30 MHz	2.7
Radiated Emission	9 kHz ~ 30 MHz	1.7
	30 MHz ~ 1000 MHz	5.7
	1000 MHz ~ 18000 MHz	5.5
	18000 MHz ~ 26500 MHz	4.8
	26500 MHz ~ 40000 MHz	4.8
Conducted Output Power		+0.27 dB / -0.28 dB
RF Bandwidth		4.96 %
Power Spectral Density		+0.71 dB / -0.77 dB
Frequency Stability		+ 2.212 x 10 <sup>-7</sup> % / - 2.170 x 10 <sup>-7</sup>
Duty Cycle		1.06 %
Time Occupancy		1.40 %



## 2 EUT Description

Applicant	Control4 11734 S. Election Road, Draper, Utah, 84020, United States			
Manufacturer	Control4 11734 S. Election Road, Draper, Utah, 84020, United States			
Product Type	802.11ac 2x2 Wave 2 Access Point			
Trade Name	pakedge			
Model No.	WA-2200-1, WA-2200, WA-2200-C, WA-2200-C-1 (*Those model numbers differ from each other in selling region.)			
FCC ID	R33WA2200			
Operate Frequency	Frequency Band		Frequency Range (MHz)	Number of Channels
	IEEE 802.11a	U-NII Band I	5180 – 5240	4
		U-NII Band III	5745 – 5825	5
	IEEE 802.11n 5 GHz 20 MHz / IEEE 802.11ac 20 MHz	U-NII Band I	5180 – 5240	4
		U-NII Band III	5745 – 5825	5
	IEEE 802.11n 5 GHz 40 MHz / IEEE 802.11ac 40 MHz	U-NII Band I	5190 – 5230	2
		U-NII Band III	5755 – 5795	2
	IEEE 802.11ac 80 MHz	U-NII Band I	5210	1
U-NII Band III		5775	1	
Modulation Type	OFDM			
Equipment Type	Master			
Antenna information	Antenna	Type	Max. Gain (dBi)	
	ANT-0	Metal PIFA Antenna	U-NII Band I	4.47
	ANT-1	Metal PIFA Antenna	U-NII Band I	5.38
	$G_{ANT}$			4.95
	ANT-0	Metal PIFA Antenna	U-NII Band III	4.86
	ANT-1	Metal PIFA Antenna	U-NII Band III	5.62
	$G_{ANT}$			5.26
Antenna Delivery	Reference section 3.1			
Frequency stability specification	$\pm 20$ ppm			
Operate Temp. Range	0 ~ +40 °C			



**EUT Modify Description :**

<p>Modify Description:</p> <p>(1) Change the applicant, applicant address, manufacturer, manufacturer address, product type, trade name, model number, FCC ID and the appearance.</p> <p>(2) Add two lightning protection components on PCB.</p> <p>(3) The appearance is removed a LAN port and a USB port.</p> <p>(4) The previous adapters are replaced with the new adapter: (Trade name: APD, Model: WB-12G12FU / Trade name: APD, Model: WB-12G12R ).</p> <p>The appearance of the product I/O Port are changed, so AC Power Conducted and Transmitter Radiated (Below 1 GHz) to be re-evaluated.</p> <p>The other test data refer to the original report : report no. 1803FR18-01</p> <p>Original Report : 1803FR18-01</p> <p>Modify: 1812FR11</p>
---

Frequency Band		RF Output Power (W)
IEEE 802.11a	U-NII Band I	0.310
	U-NII Band III	0.312
IEEE 802.11ac 20 MHz	U-NII Band I	0.298
	U-NII Band III	0.346
IEEE 802.11ac 40 MHz	U-NII Band I	0.252
	U-NII Band III	0.251
IEEE 802.11ac 80 MHz	U-NII Band I	0.113
	U-NII Band III	0.226

Beamforming on

Frequency Band		RF Output Power (W)
IEEE 802.11ac 20 MHz	U-NII Band I	0.144
	U-NII Band III	0.169
IEEE 802.11ac 40 MHz	U-NII Band I	0.123
	U-NII Band III	0.118
IEEE 802.11ac 80 MHz	U-NII Band I	0.052
	U-NII Band III	0.110

Equipment Type		
Outdoor access point	point-to-point	---
	point-to-multipoint	---
Indoor access point		V
Fixed point-to-point access points		---
Client devices		---



### 3 Test Methodology

#### 3.1. Mode of Operation

Decision of Test ATL has verified the construction and function in typical operation. All the test modes were carried out with the EUT in normal operation, which was shown in this test report and defined as:

Test Mode
Mode 1: Transmit mode
Mode 2: IEEE 802.11a Continuous TX mode
Mode 3: IEEE 802.11ac 20 MHz Continuous TX mode
Mode 4: IEEE 802.11ac 40 MHz Continuous TX mode
Mode 5: IEEE 802.11ac 80 MHz Continuous TX mode

Software used to control the EUT for staying in continuous transmitting mode was programmed.

After verification, all tests were carried out with the worst case test modes.

Note: Adapter Model Number: PS1012-120HUB100 is worst case.

Test Mode	ANT-0	ANT-1	ANT-0+1
Mode 2	V	V	V
Mode 3	V	V	V
Mode 4	V	V	V
Mode 5	V	V	V

Test Mode	Antenna Delivery		Data Rate	Band	Test Channel
	Normal	Beamforming on			
Mode 2	2TX(CDD)	---	6 M	U-NII Band I	36, 40, 44, 48
				U-NII Band III	149,153,157,161,165
Mode 3	2TX(CDD)	2TX(MIMO)	13 M	U-NII Band I	36, 40, 44, 48
				U-NII Band III	149,153,157,161,165
Mode 4	2TX(CDD)	2TX(MIMO)	27 M	U-NII Band I	38, 46
				U-NII Band III	151,159
Mode 5	2TX(CDD)	2TX(MIMO)	58.6 M	U-NII Band I	42
				U-NII Band III	155

**Duty cycle**

Test Mode	Frequency (MHz)	on time (ms)	on+off time (ms)	Duty cycle	Duty Factor (dB)	1/T Minimum VBW (kHz)
Mode 2	5180.0	2.050	2.100	0.976	0.105	0.488
Mode 3	5180.0	5.010	5.055	0.991	0.039	0.010
Mode 4	5190.0	2.430	2.490	0.976	0.106	0.412
Mode 5	5210.0	1.145	1.210	0.946	0.240	0.873

**Beamforming on**

Test Mode	Frequency (MHz)	on time (ms)	on+off time (ms)	Duty cycle	Duty Factor (dB)	1/T Minimum VBW (kHz)
Mode 3	5180.0	5.010	5.055	0.991	0.039	0.010
Mode 4	5190.0	2.430	2.490	0.976	0.106	0.412
Mode 5	5210.0	1.145	1.210	0.946	0.240	0.873

### Duty Cycle Graphs

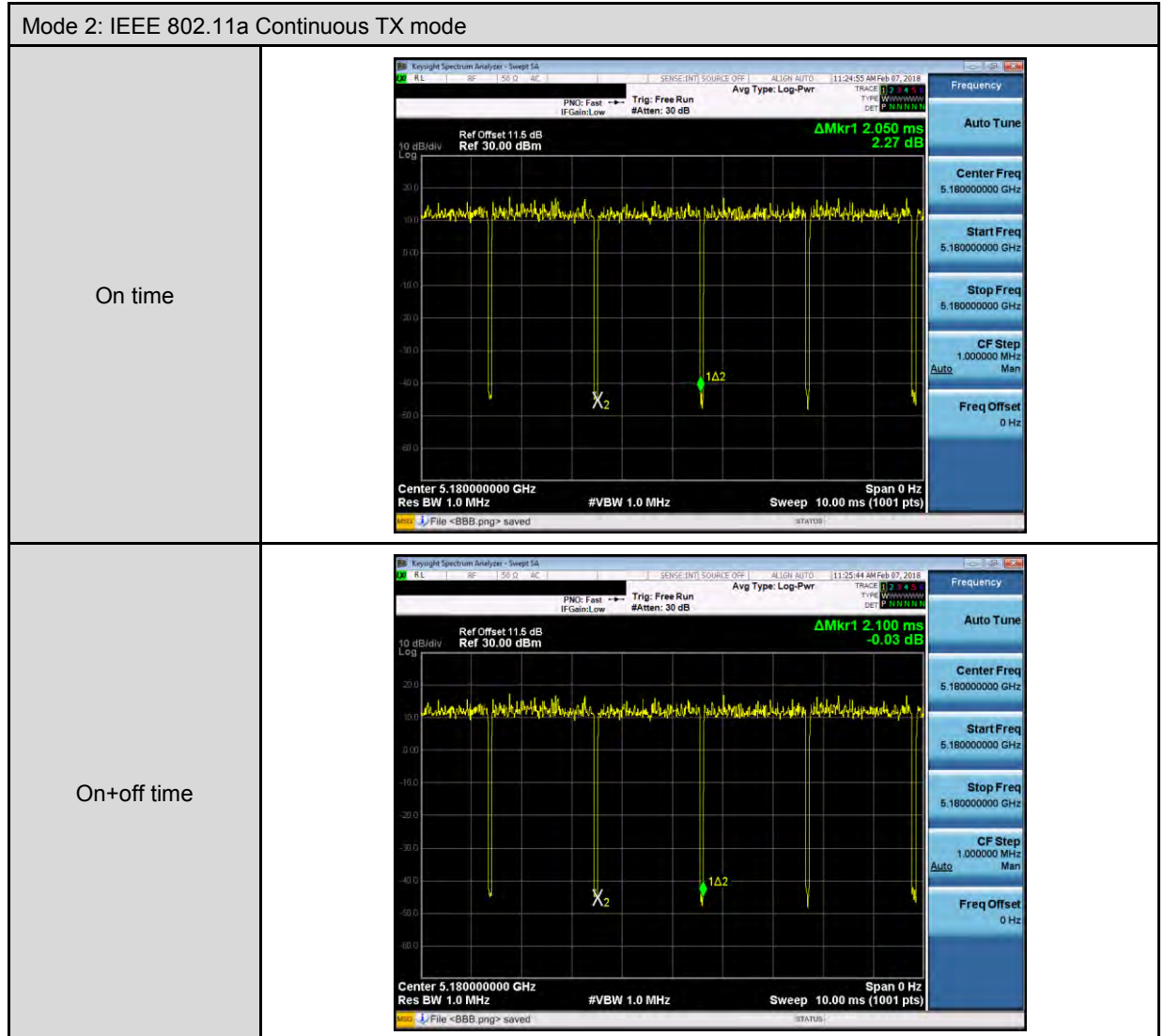

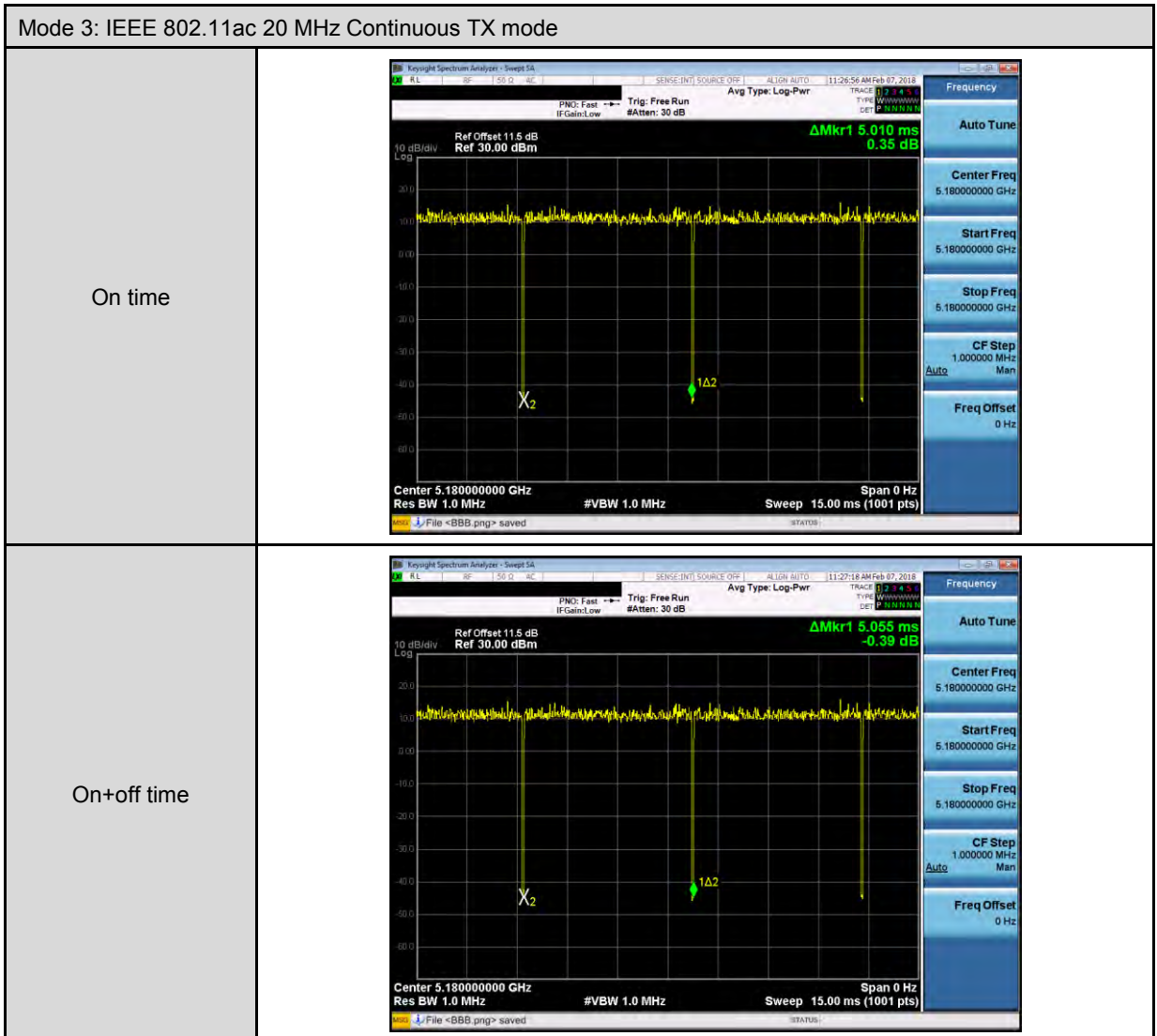

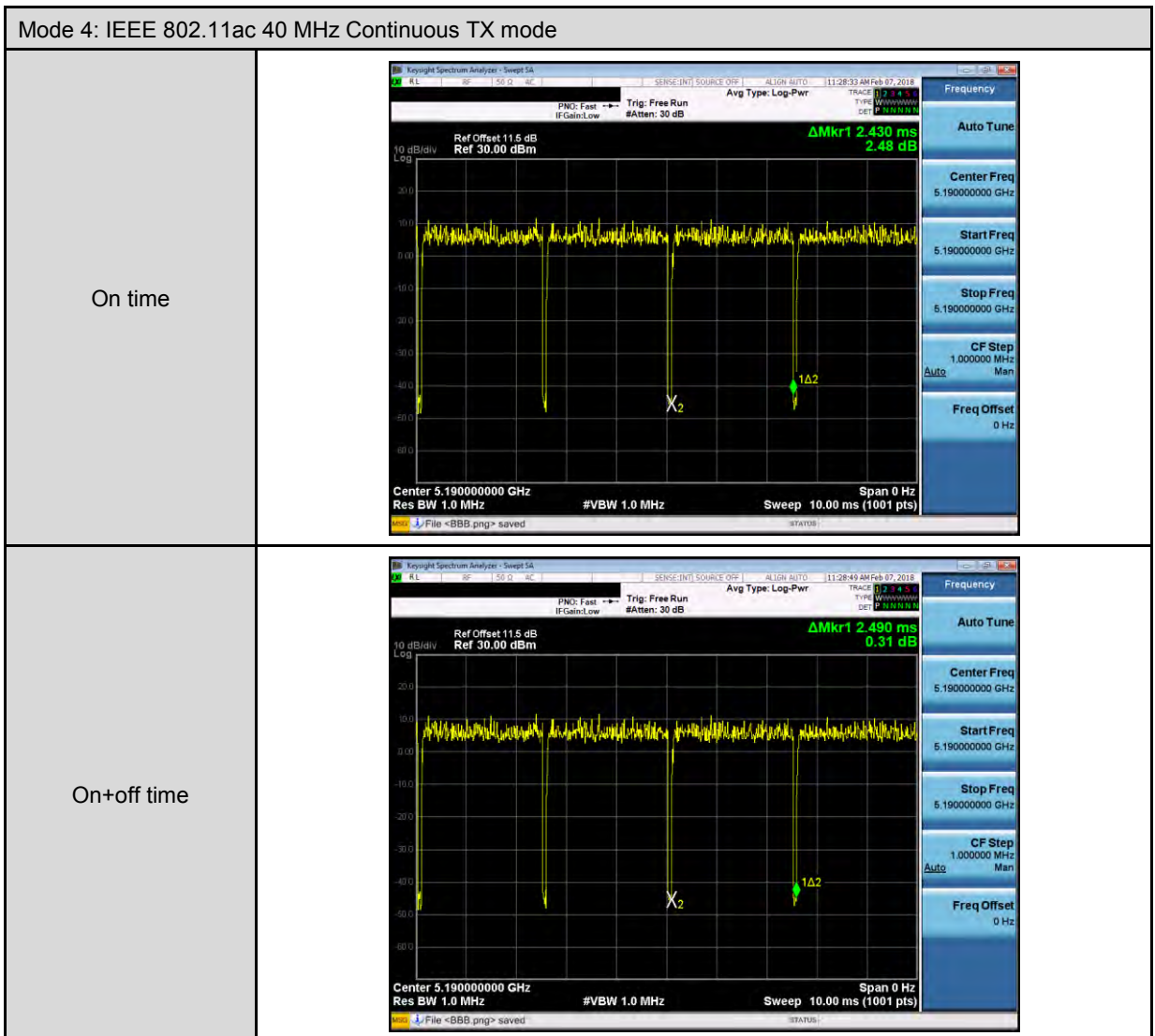



Beamforming on

Mode 3: IEEE 802.11ac 20 MHz Continuous TX mode

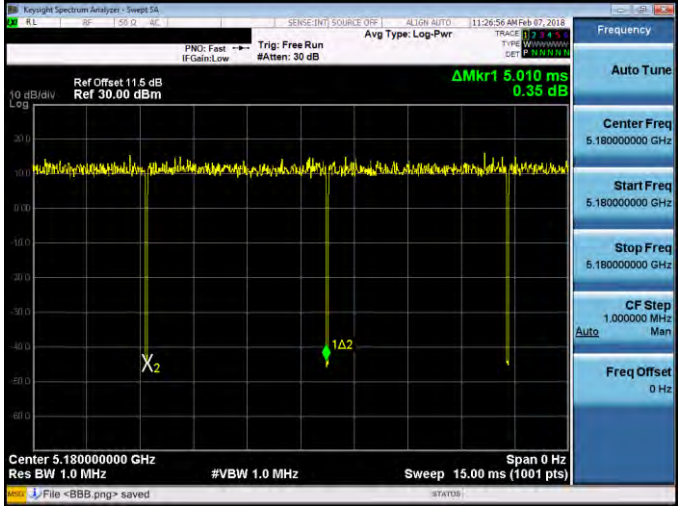
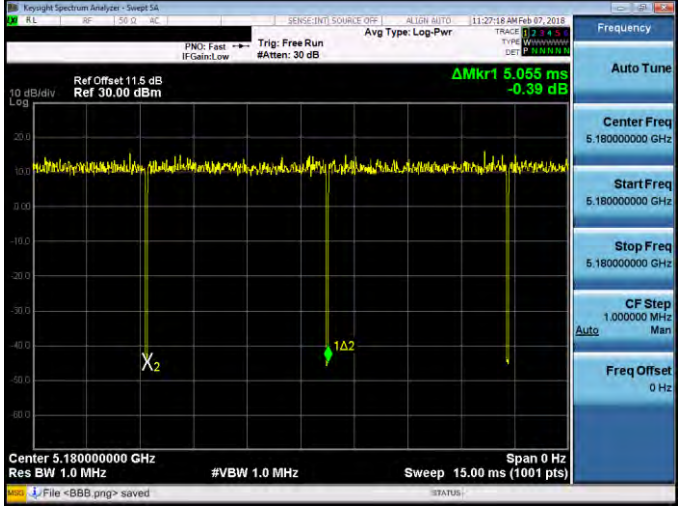
<p>On time</p>	
<p>On+off time</p>	

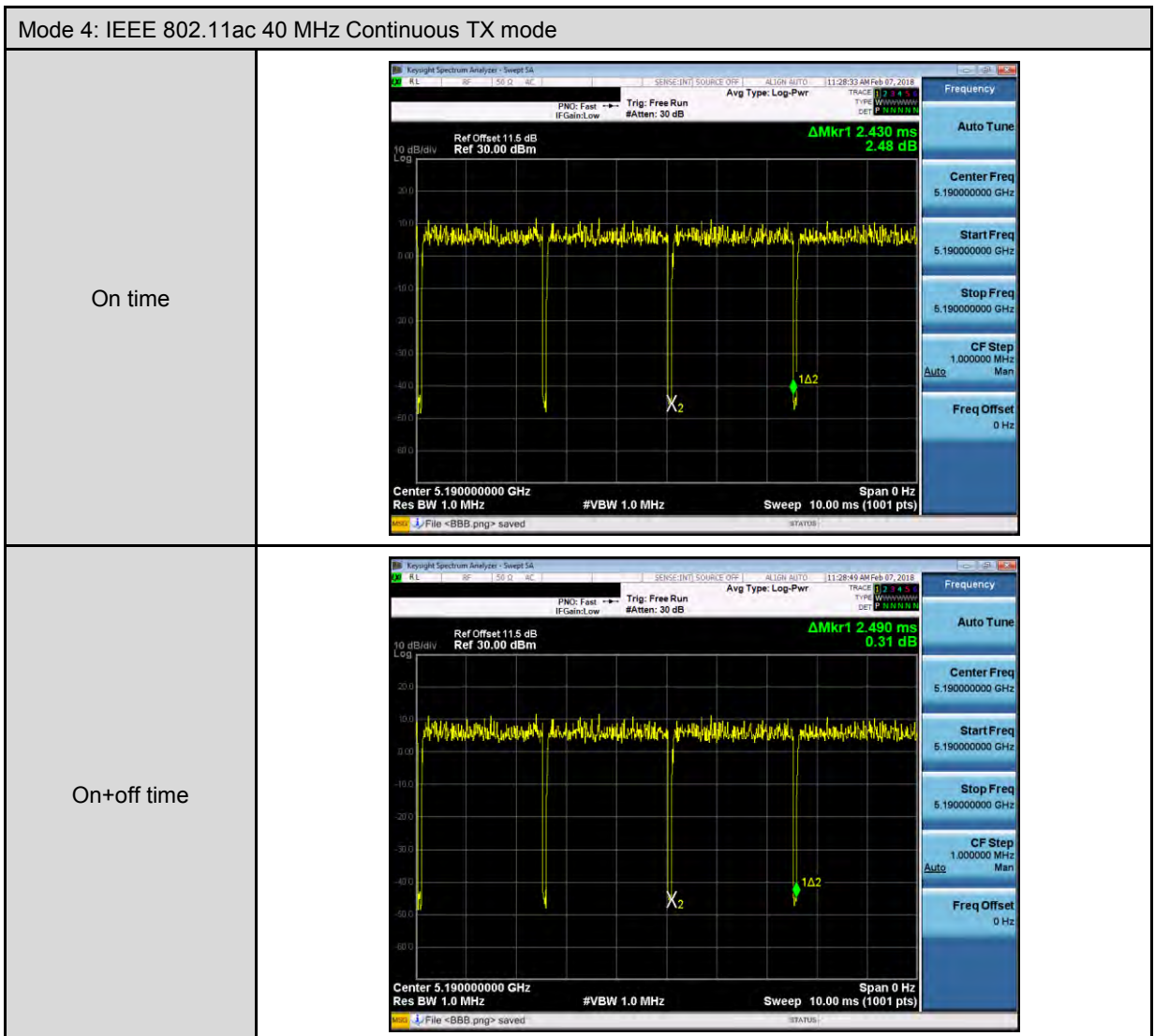







### 3.2. EUT Test Step

The EUT is operated in the engineering mode to fix the TX frequency for the purposes of measurement. According to its specifications, the EUT must comply with the requirements of Section 15.407 under the FCC Rules Part 15 Subpart E.

1.	Setup the EUT shown on "Configuration of Test System Details".
2.	Turn on the power of all equipment.
3.	Turn on TX function.
4.	EUT run test program.

Measurement Software			
No.	Description	Software	Version
1	Conducted Emission	EZ EMC	1.1.4.3
2	Radiated Emission	EZ EMC	1.1.4.4

### 3.3. Configuration of Test System Details

#### Conducted Emissions

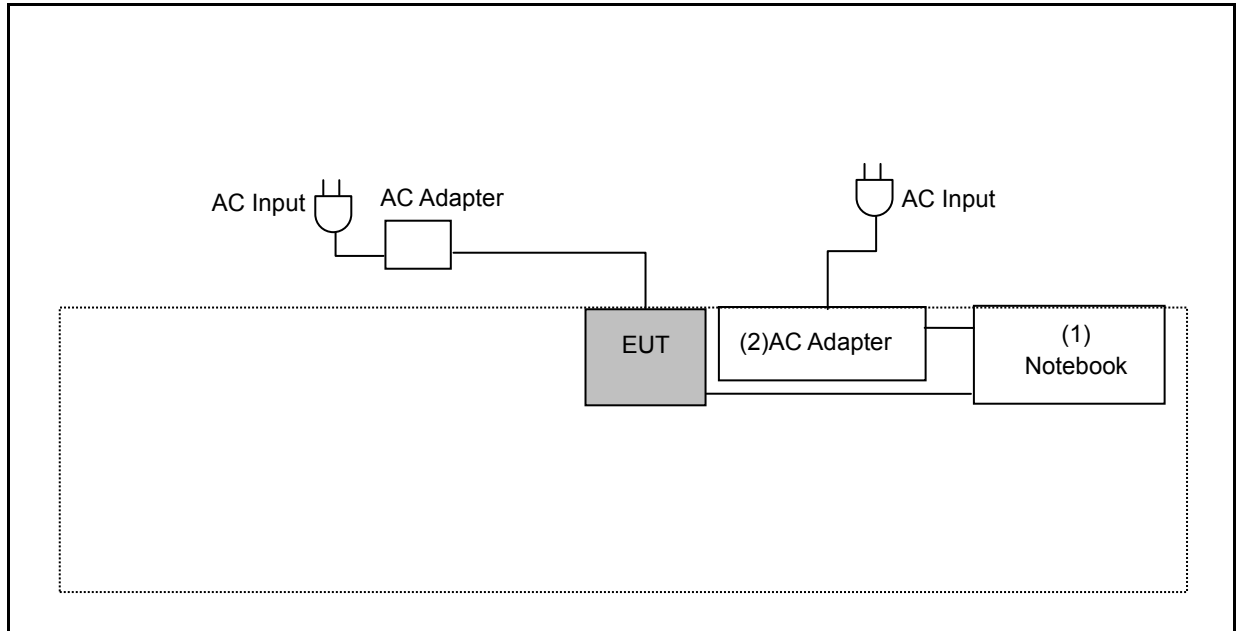

#### Radiated Emission

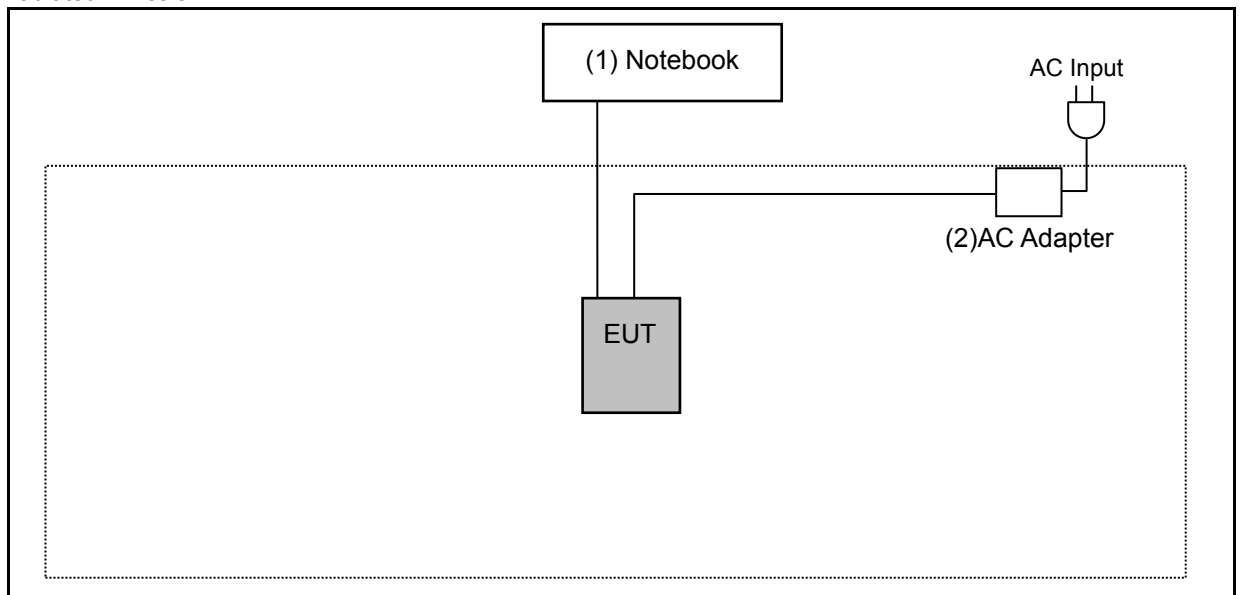

Devices Description					
	Product	Manufacturer	Model Number	Serial Number	Power Cord
(1)	Notebook	DELL	LATITUDE E5440	BRTQXY1	---
(2)	AC Adapter	DELL	HA65NM130	---	Non-Shielded, 0.8 m



### 3.4. Test Instruments

For Conducted Emission

Test Period: Dec. 06, 2018

Equipment	Manufacturer	Model Number	Serial Number	Cal. Date	Cal. Period
Test Receiver	R&S	ESCI	100367	05/21/2018	1 year
LISN	R&S	ENV216	101040	04/11/2018	1 year
LISN	R&S	ENV216	101041	03/23/2018	1 year
RF Cable	Woken	00100D1380194M	TE-02-03	05/17/2018	1 year

For Radiated Emissions

Test Period: Feb. 02 ~ Mar. 19, 2018 / Nov. 20, 2018

Equipment	Manufacturer	Model Number	Serial Number	Cal. Date	Cal. Period
Spectrum Analyzer (10 Hz~44 GHz)	Keysight	N9010A	MY52221312	01/15/2018	1 year
Pre Amplifier (1~26.5 GHz)	Agilent	8449B	3008A02237	10/16/2017	1 year
				10/16/2018	
Pre Amplifier (100 kHz~1.3 GHz)	Agilent	8447D	2944A11119	01/10/2018	1 year
Pre Amplifier (26.5~40 GHz)	EMCI	EMC2654045	980028	08/29/2017	1 year
				08/23/2018	
Pre Amplifier (1~26.5 GHz)	EMCI	EMC012645SE	980289	01/17/2018	1 year
Broadband Antenna	Schwarzbeck	VULB9168	416	10/26/2017	1 year
				10/19/2018	
Horn Antenna (1~18 GHz)	SCHWARZBECK MESS-ELEKTRONIK	BBHA9120D	9120D-550	06/20/2017	1 year
				08/23/2018	
Horn Antenna (18~40 GHz)	SCHWARZBECK MESS-ELEKTRONIK	BBHA9170	9170-320	08/07/2018	1 year
Loop Antenna	COM-POWER CORPORATION	AL-130	121014	03/13/2018	1 year



For Conducted

Test Period: Feb. 12 ~ Feb. 13, 2018

Equipment	Manufacturer	Model Number	Serial Number	Cal. Date	Cal. Period
Power Sensor	Anritsu	MA2411B	1126022	08/28/2017	1 year
Power Meter	Anritsu	ML2495A	1135009	08/28/2017	1 year
Spectrum Analyzer (10 Hz~44 GHz)	Agilent	N9010A	MY52221312	01/16/2018	1 year
Temperature & Humidity Chamber	TAICHY	MHU-225LA	980729	04/17/2017	1 year

Note: N.C.R. = No Calibration Request.

### 3.5. Test Site Environment

Items	Required (IEC 60068-1)	Actual
Temperature (°C)	15-35	26
Humidity (%RH)	25-75	60
Barometric pressure (mbar)	860-1060	990

## 4 Measurement Procedure

### 4.1. AC Power Conducted Emission Measurement

■ Limit

Frequency (MHz)	Quasi-peak	Average
0.15 - 0.5	66 to 56	56 to 46
0.50 - 5.0	56	46
5.0 - 30.0	60	50

■ Test Setup

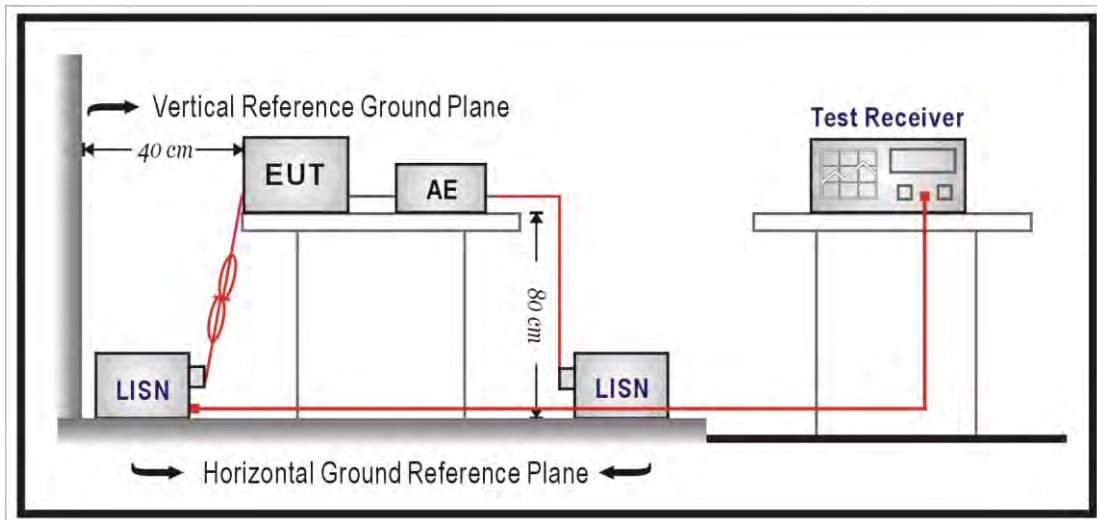

### ■ Test Procedure

The EUT and simulators are connected to the main power through a line impedance stabilization network (L.I.S.N.). This provides a  $50 \Omega // 50 \mu\text{H}$  coupling impedance for the measuring equipment. The peripheral devices are also connected to the main power through a LISN that provides a  $50 \Omega // 50 \mu\text{H}$  coupling impedance with 50 ohm termination.

Tabletop device shall be placed on a non-conducting platform, of nominal size 1 m by 1.5 m, raised 80 cm above the reference ground plane. The wall of screened room shall be located 40 cm to the rear of the EUT. Other surfaces of tabletop or floor standing EUT shall be at least 80 cm from any other ground conducting surface including one or more LISNs. For floor-standing device shall be placed under the EUT with a 12 mm insulating material.

Conducted emissions were investigated over the frequency range from 0.15 MHz to 30 MHz using a resolution bandwidth of 9 kHz. The equipment under test (EUT) shall be meet the limits in section 4.1, as applicable, including the average limit and the quasi-peak limit when using respectively, an average detector and quasi-peak detector measured in accordance with the methods described of related standard. When all of peak value were complied with quasi-peak and average limit from 150 kHz to 30 MHz then quasi-peak and average measurement was unnecessary.

The AMN shall be placed 0.8 m from the boundary of the unit under test and bonded to a ground reference plane for AMNs mounted on top of the ground reference plane. This distance is between the closest points of the AMN and the EUT. All other units of the EUT and associated equipment shall be at least 0.8 m from the AMN. If the mains power cable is longer than 1 m then the cable shall be folded back and forth at the centre of the lead to form a bundle no longer than 0.4 m. All of interconnecting cables that hang closer than 40 cm to the ground plane shall be folded back and forth in the center forming a bundle 30 cm to 40 cm long. All of EUT and AE shall be separate place more than 0.1 m. All  $50 \Omega$  ports of the LISN shall be resistively terminated into  $50 \Omega$  loads when not connected to the measuring instrument.

If the reading of the measuring receiver shows fluctuations close to the limit, the reading shall be observed for at least 15 s at each measurement frequency; the higher reading shall be recorded with the exception of any brief isolated high reading which shall be ignored.



## 4.2. Transmitter Radiated Emissions Measurement

### ■ Limit

(1) Undesirable emission limits. Except as shown in paragraph (b)(7) of this section, the maximum emissions outside of the frequency bands of operation shall be attenuated in accordance with the following limits:

(a) For transmitters operating in the 5.15-5.25 GHz band: All emissions outside of the 5.15-5.35 GHz band shall not exceed an e.i.r.p. of -27 dBm/MHz.

(b) For transmitters operating in the 5.25-5.35 GHz band: All emissions outside of the 5.15-5.35 GHz band shall not exceed an e.i.r.p. of -27 dBm/MHz.

(c) For transmitters operating in the 5.47-5.725 GHz band: All emissions outside of the 5.47-5.725 GHz band shall not exceed an e.i.r.p. of -27 dBm/MHz.

(d) For transmitters operating in the 5.725-5.85 GHz band:

(i) All emissions shall be limited to a level of -27 dBm/MHz at 75 MHz or more above or below the band edge increasing linearly to 10 dBm/MHz at 25 MHz above or below the band edge, and from 25 MHz above or below the band edge increasing linearly to a level of 15.6 dBm/MHz at 5 MHz above or below the band edge, and from 5 MHz above or below the band edge increasing linearly to a level of 27 dBm/MHz at the band edge.

(2) Limits of Radiated Emission Measurement

Emissions radiated outside of the specified bands, shall be according to the general radiated limits in 15.209 as following:

Frequency Range (MHz)	Field Strength (microvolts/meter)	Measurement Distance (meters)
0.009 ~ 0.490	2400/F(kHz)	300
0.490 ~ 1.705	24000/F(kHz)	30
1.705 ~ 30.0	30	30
30 ~ 88	10	3
88 ~ 216	150	3
216 ~ 960	200	3
Above 960	500	3

- Note:
1. The lower limit shall apply at the transition frequencies.
  2. Emission level (dBuV/m) = 20 log Emission level (uV/m).
  3. As shown in 15.35(b), for frequencies above 1000 MHz, the field strength limits are based on average detector, however, the peak field strength of any emission shall not exceed the maximum permitted average limits, specified above by more than 20 dB under any condition of modulation.



■ Setup

9 kHz ~ 30 MHz

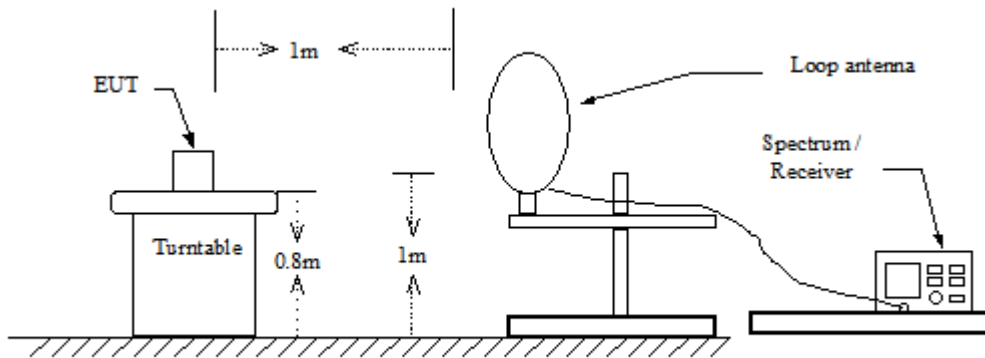

30 MHz ~ 1 GHz

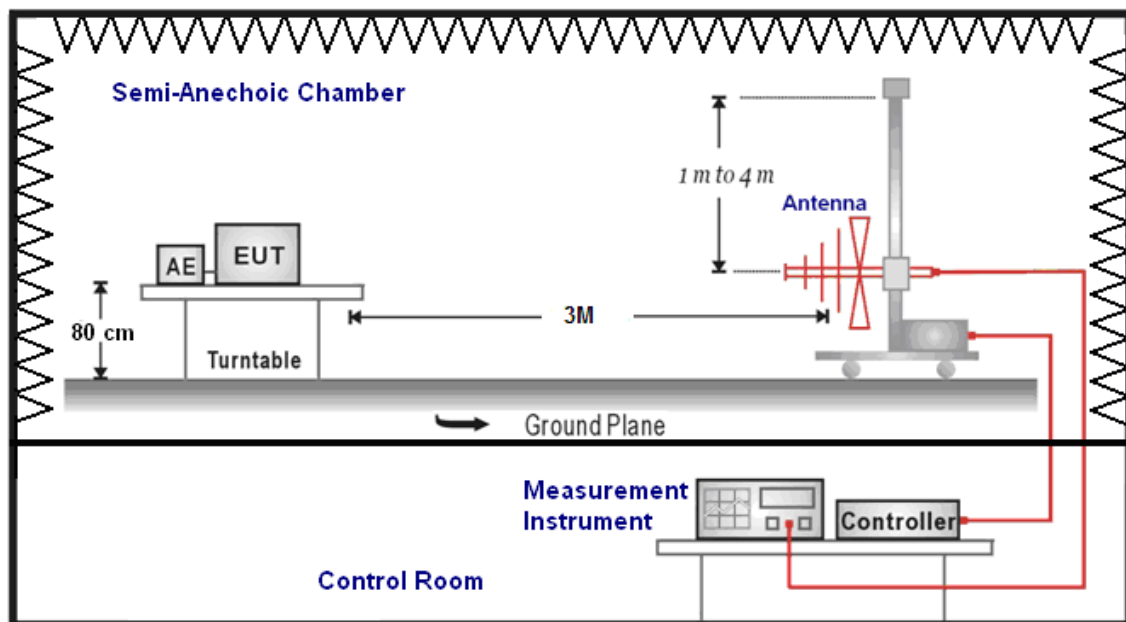

Above 1 GHz

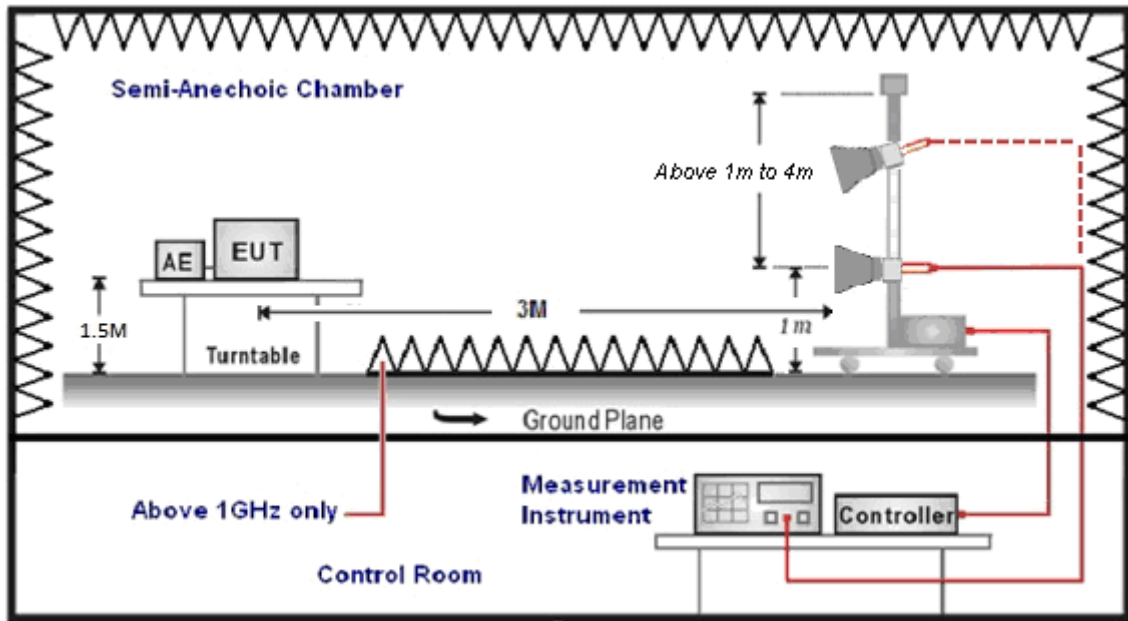

### ■ Test Procedure

Final radiation measurements were made on a three-meter, Semi Anechoic Chamber. The EUT system was placed on a nonconductive turntable which is 0.8 or 1.5 meters height (below 1 GHz use 0.8 m turntable / above 1 GHz use 1.5 m turntable), top surface 1.0 x 1.5 meter. The spectrum was examined from 250 MHz to 2.5 GHz in order to cover the whole spectrum below 10th harmonic which could generate from the EUT. During the test, EUT was set to transmit continuously & Measurements spectrum range from 9 kHz to 40 GHz is investigated.

For measurements below 1 GHz the resolution bandwidth is set to 100 kHz for peak detection measurements or 120 kHz for quasi-peak detection measurements. Peak detection is used unless otherwise noted as quasi-peak.

For restricted measurements above 1 GHz the resolution bandwidth is set to 1 MHz, and then the video bandwidth is set to 3 MHz for peak measurements and 10 Hz for average measurements when Duty cycle > 0.98 / 1/T for average measurements when Duty cycle < 0.98.

For out of band measurements above 1 GHz the resolution bandwidth is set to 1 MHz, and then the video bandwidth is set to 3 MHz for peak measurements.

A nonconductive material surrounded the EUT to supporting the EUT for standing on three orthogonal planes. At each condition, the EUT was rotated 360 degrees, and the antenna was raised and lowered from one to four meters to find the maximum emission levels. Measurements were taken using both horizontal and vertical antenna polarization.

SCHWARZBECK MESS-ELEKTRONIK Trilog-Broadband Antenna at 3 Meter and the ETS-Lindgren Double-Ridged Waveguide Horn antenna Schwarzbeck Mess-Elektronik Broadband Horn Antenna was used in frequencies 1 – 40 GHz at a distance of 3 meter. The antenna at an angle toward the source of the emission. All test results were extrapolated to equivalent signal at 3 meters utilizing an inverse linear distance extrapolation Factor (20 dB/decade).

For testing above 1 GHz, the emission level of the EUT in peak mode was 20 dB lower than average limit (that means the emission level in peak mode also complies with the limit in average mode), then testing will be stopped and peak values of EUT will be reported, otherwise, the emissions will be measured in average mode again and reported.

Appropriate preamplifiers were used for improving sensitivity and precautions were taken to avoid overloading or desensitizing the spectrum analyzer. No post – detector video filters were used in the test.

The spectrum analyzer's 6 dB bandwidth was set to 1 MHz, and the analyzer was operated in the peak detection mode, for frequencies both below and up 1 GHz. The average levels were obtained by subtracting the duty cycle correction factor from the peak readings.

The following procedures were used to convert the emission levels measured in decibels referenced to 1 microvolt (dBuV) into field intensity in micro volts per meter (uV/m).

The actual field intensity in decibels referenced to 1 microvolt in to field intensity in micro volts per meter (dBuV/m).



The actual field is intensity in referenced to 1 microvolt per meter (dBuV/m) is determined by algebraically adding the measured reading in dBuV, the antenna factor (dB), and cable loss (dB) and Subtracting the gain of preamplifier (dB) is auto calculate in spectrum analyzer.

(1) Amplitude (dBuV/m) = FI (dBuV) +AF (dBuV) +CL (dBuV)-Gain (dB)

FI= Reading of the field intensity.

AF= Antenna factor.

CL= Cable loss.

P.S Amplitude is auto calculate in spectrum analyzer.

(2) Actual Amplitude (dBuV/m) = Amplitude (dBuV)-Dis(dB)

The FCC specified emission limits were calculated according the EUT operating frequency and by following linear interpolation equations:

(a) For fundamental frequency : Transmitter Output < +30 dBm

(b) For spurious frequency : Spurious emission limits = fundamental emission limit /10

#### Measuring Instruments and setting

The following table is the setting of spectrum analyzer and receiver.

Spectrum Parameter	Setting
Attenuation	Auto
Start Frequency	1000 MHz
Stop Frequency	40 GHz
RBW/VBW(Emission in restricted band)	1 MHz / 3 MHz for Peak 1 MHz / (1/T) for Average
RBW/VBW(Emission in non-restricted band)	1 MHz / 3 MHz for Peak

### 4.3. Maximum Conducted Output Power Measurement

#### ■ Limit

Frequency Range (MHz)	FCC Maximum Conducted Output Power Limit
	Master
5.150 ~ 5.250 GHz	The lesser of 1 W (30 dBm)
5.725 ~ 5.850 GHz	The lesser of 1 W (30 dBm)

According FCC KDB 662911 D01 v02r01 – for power measurements on IEEE802.11 devices

CDD mode :

Directional Gain =  $G_{ANT} = 10 \cdot \log\{[10^{(G1/10)} + 10^{(G2/10)} + \dots + 10^{(Gn/10)}] / N_{ANT}\} = 4.95 \text{ dBi} < 6 \text{ dBi}$

\* limit shall be reduced =  $30 - 0 = 30 \text{ dBm}$  (5.150 ~ 5.250 GHz)

Directional Gain =  $G_{ANT} = 10 \cdot \log\{[10^{(G1/10)} + 10^{(G2/10)} + \dots + 10^{(Gn/10)}] / N_{ANT}\} = 5.26 \text{ dBi} < 6 \text{ dBi}$

\* limit shall be reduced =  $30 - 0 = 30 \text{ dBm}$  (5.725 ~ 5.850 GHz)

BF mode :

Directional Gain =  $G_{ANT} = 10 \cdot \log\{[10^{(G1/20)} + 10^{(G2/20)} + \dots + 10^{(Gn/20)}]^2 / N_{ANT}\} = 7.95 \text{ dBi} > 6 \text{ dBi}$

\* limit shall be reduced =  $30 - 1.95 = 28.05 \text{ dBm}$  (5.150 ~ 5.250 GHz)

Directional Gain =  $G_{ANT} = 10 \cdot \log\{[10^{(G1/20)} + 10^{(G2/20)} + \dots + 10^{(Gn/20)}]^2 / N_{ANT}\} = 8.26 > 6 \text{ dBi}$

\* limit shall be reduced =  $30 - 2.26 = 27.74 \text{ dBm}$  (5.725 ~ 5.850 GHz)

#### ■ Test Setup

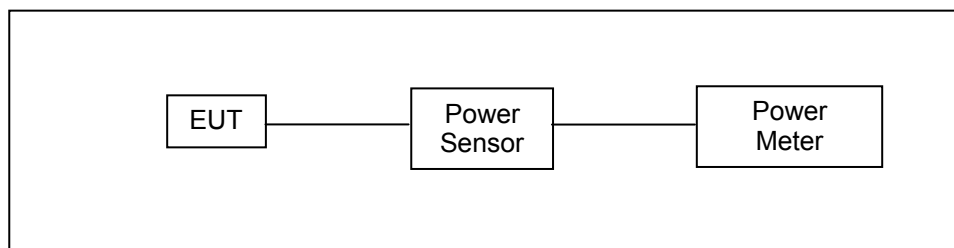

#### ■ Test Procedure

The test is performed in accordance with KDB789033: D02 General UNII Test Procedures New Rules v02r01, Guidelines for Compliance Testing of Unlicensed National Information Infrastructure (U-NII) Devices

Section (E) Maximum Conducted Output Power

3. Measurement using a Power Meter (PM)

b) Method PM-G (Measurement using a gated RF average power meter)

#### 4.4. 26 dB RF Bandwidth Measurement & 99 % Occupied Bandwidth Measurement

■ **Limit**

N/A

■ **Test Setup**

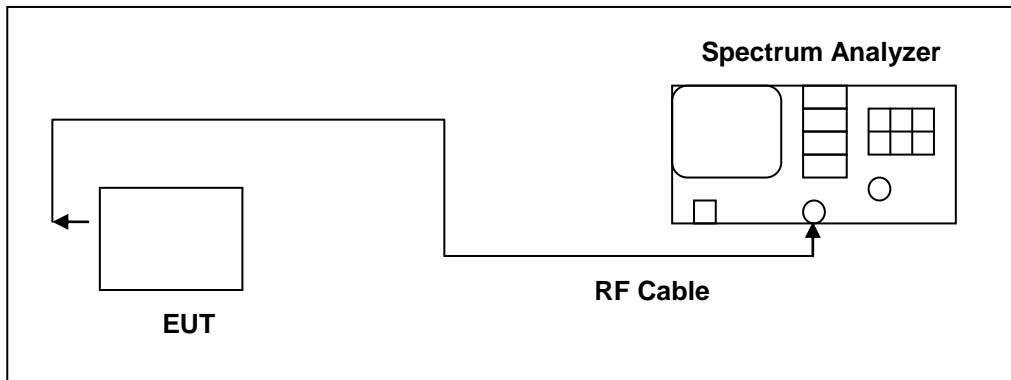

■ **Test Procedure**

The test is performed in accordance with KDB789033: D02 General UNII Test Procedures New Rules v02r01, Guidelines for Compliance Testing of Unlicensed National Information Infrastructure (U-NII) Devices - Part 15, Subpart E.

Spectrum Parameter	Setting
Attenuation	Auto
Span Frequency	>26 dB Bandwidth
RBW	Approximately 1 % of the emission bandwidth
VBW	VBW > RBW
Detector	Peak
Trace	Max Hold
Sweep Time	Auto

#### 4.5. 6 dB RF Bandwidth Measurement

- **Limit**

- **6 dB RF Bandwidth**

- Systems using digital modulation techniques may operate in the 5725~5850 MHz bands. The minimum 6 dB band-width shall be at least 500 kHz.

- **Test Setup**

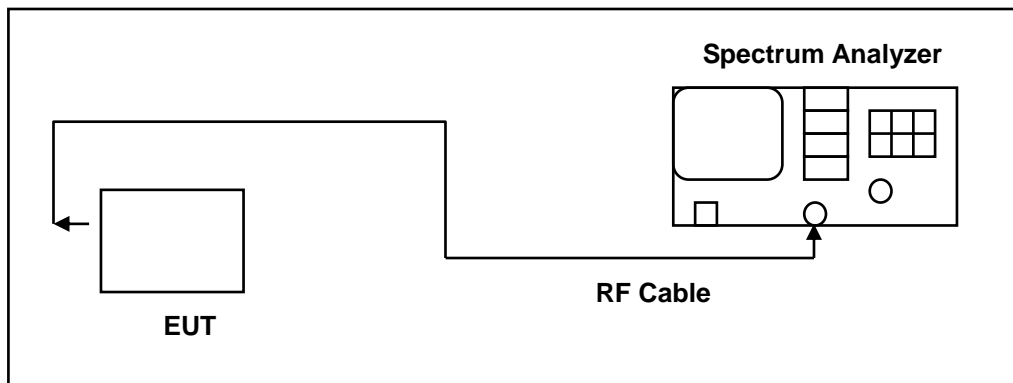

- **Test Procedure**

- **6 dB RF Bandwidth**

- The EUT tested to UNII test procedure of KDB789033 D02 for compliance to FCC 47CFR 15.407 requirements.

- The antenna port of the EUT was connected to the input of a spectrum analyzer. Analyzer RES BW was set to 100 kHz. For each RF output channel investigated, the spectrum analyzer center frequency was set to the channel carrier. A peak output reading was taken, a DISPLAY line was drawn 6 dB lower than peak level. The 6 dB bandwidth was determined from where the channel output spectrum intersected the display line.

- The test was performed at 3 channels.

#### 4.6. Maximum Power Spectral Density Measurement

■ **Limit**

Conducted power spectral density

Frequency Range (MHz)	FCC Limit
	Master
5.150 ~ 5.250 GHz	17 dBm/MHz
5.725 ~ 5.850 GHz	30 dBm/500 kHz

According FCC KDB 662911 D01 v02r01 – for power spectral density measurements on IEEE802.11 devices,

CDD/BF mode :

Directional Gain =  $10 \cdot \log\{[10^{G1/20} + 10^{G2/20} + \dots + 10^{Gn/20}]^2 / NANT\}$  = 7.95 dBi > 6dBi

\* limit shall be reduced = 17 – 1.95 = 15.05 dBm (5.150 ~ 5.250 GHz)

Directional Gain =  $10 \cdot \log\{[10^{G1/20} + 10^{G2/20} + \dots + 10^{Gn/20}]^2 / NANT\}$  = 8.26 dBi > 6dBi

\* limit shall be reduced = 30 – 2.26 = 27.74 dBm/500 kHz (5.725 ~ 5.850 GHz)

■ **Test Setup**

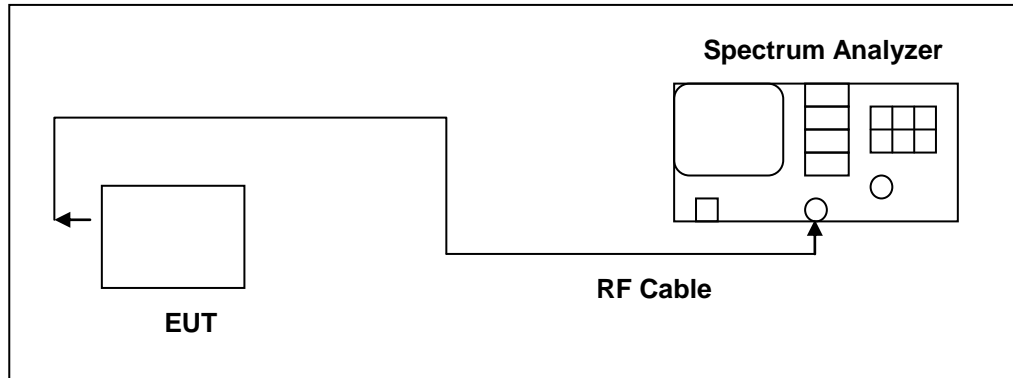



**■ Test Procedure**

The test is performed in accordance with KDB789033: D02 General UNII Test Procedures New Rules v02r01, Guidelines for Compliance Testing of Unlicensed National Information Infrastructure (U-NII) Devices - Part 15, Subpart E.

Spectrum Parameter	Setting
Attenuation	Auto
Span Frequency	Encompass the entire emissions bandwidth (EBW) of the signal
RBW	1 MHz (5725 ~ 5850 MHz use 100 kHz)
VBW	3 MHz (5725 ~ 5850 MHz use 300 kHz)
Detector	RMS
Trace	AVERAGE
Sweep Time	Auto
Trace Average	100 times
Note: If measurement bandwidth of Maximum PSD is specified in 500 kHz, add $10 \log(500 \text{ kHz}/100 \text{ kHz})$ to the measured result.	

## 4.7. Frequency Stability Measurement

### ■ Limit

Manufacturers of U-NII devices are responsible for ensuring frequency stability such that an emission is maintained within the band of operation under all conditions of normal operation as specified in the users manual.

### ■ Test Setup

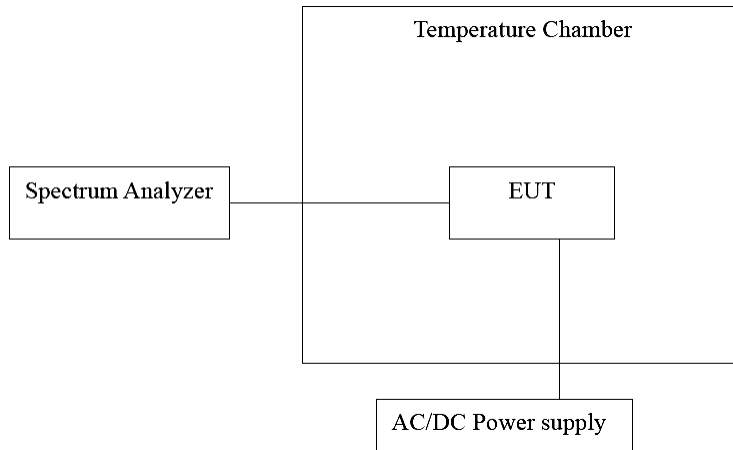

### ■ Test Procedure

1. The EUT was placed inside the environmental test chamber and powered by nominal AC/DC voltage.
2. Turn the EUT on and couple its output to a spectrum analyzer.
3. Turn the EUT off and set the chamber to the highest temperature specified.
4. Allow sufficient time (approximately 30 min) for the temperature of the chamber to stabilize.
5. Repeat step 2 and 3 with the temperature chamber set to the lowest temperature.
6. The test chamber was allowed to stabilize at +20 degree C for a minimum of 30 minutes. The supply voltage was then adjusted on the EUT from 85 % to 115 % and the frequency record.



#### **4.8. Automatically discontinue transmission**

The device shall automatically discontinue transmission in case of either absence of information to transmit or operational failure. These provisions are not intended to preclude the transmission of control or signalling information or the use of repetitive codes used by certain digital technologies to complete frame or burst intervals. Applicants shall include in their application for equipment authorization a description of how this requirement is met.

- **Declare**

While the EUT is not transmitting any information, the EUT can automatically discontinue transmission and become standby mode for power saving.

The EUT can detect the controlling signal of ACK message transmitting from remote device and verify whether it shall resend or discontinue transmission.

#### **4.9. Antenna Requirement**

- **Limit**

For intentional device, according to 15.203, an intentional radiator shall be designed to ensure that no antenna other than that furnished by the responsible party shall be used with the device.

And According to 15.407 (a), if transmitting antennas of directional gain greater than 6 dBi are used, the power shall be reduced by the amount in dB that the directional gain of the antenna exceeds 6 dBi.

- **Antenna Connector Construction**

See section 2 – antenna information.



■ **Directional Gain Calculated**

**For Maximum Conducted Output Power**

Operate Freq. Band		Directional Gain (dBi)
IEEE 802.11a	U-NII Band I	4.95
	U-NII Band III	5.26
IEEE 802.11ac 20 MHz	U-NII Band I	4.95
	U-NII Band III	5.26
IEEE 802.11ac 40 MHz	U-NII Band I	4.95
	U-NII Band III	5.26
IEEE 802.11ac 80 MHz	U-NII Band I	4.95
	U-NII Band III	5.26
Beamforming on		
IEEE 802.11ac 20 MHz	U-NII Band I	7.95
	U-NII Band III	8.26
IEEE 802.11ac 40 MHz	U-NII Band I	7.95
	U-NII Band III	8.26
IEEE 802.11ac 80 MHz	U-NII Band I	7.95
	U-NII Band III	8.26

**For Maximum Power Density**

Operate Freq. Band		Directional Gain (dBi)
IEEE 802.11a	U-NII Band I	7.95
	U-NII Band III	8.26
IEEE 802.11ac 20 MHz	U-NII Band I	7.95
	U-NII Band III	8.26
IEEE 802.11ac 40 MHz	U-NII Band I	7.95
	U-NII Band III	8.26
IEEE 802.11ac 80 MHz	U-NII Band I	7.95
	U-NII Band III	8.26
Beamforming on		
IEEE 802.11ac 20 MHz	U-NII Band I	7.95
	U-NII Band III	8.26
IEEE 802.11ac 40 MHz	U-NII Band I	7.95
	U-NII Band III	8.26
IEEE 802.11ac 80 MHz	U-NII Band I	7.95
	U-NII Band III	8.26



## 5 Test Results

### 5.1. AC Power Conducted Emission Measurement

Standard:	FCC Part 15.407	Line:	L1
Test item:	Conducted Emission	Power:	AC 120 V/60 Hz
Test Mode:	Mode 1	Temp.(°C)/Hum.(%RH):	26(°C)/60 %RH
Description:	Adapter Model Number: PS1012-120HUB100		

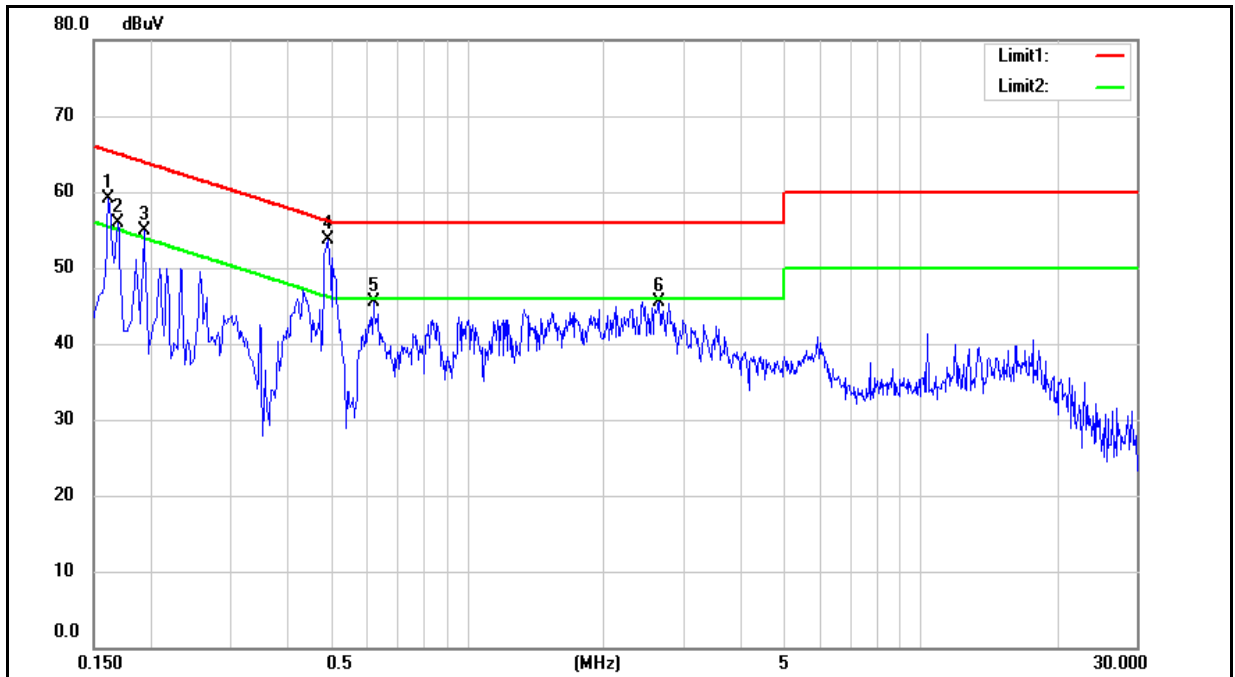

No.	Frequency (MHz)	QP reading (dBuV)	AVG reading (dBuV)	Correction factor (dB)	QP result (dBuV)	AVG result (dBuV)	QP limit (dBuV)	AVG limit (dBuV)	QP margin (dB)	AVG margin (dB)	Remark
1	0.1620	43.67	28.21	9.60	53.27	37.81	65.36	55.36	-12.09	-17.55	Pass
2	0.1700	42.90	27.92	9.60	52.50	37.52	64.96	54.96	-12.46	-17.44	Pass
3	0.1945	38.96	23.37	9.60	48.56	32.97	63.84	53.84	-15.28	-20.87	Pass
4	0.4940	42.02	33.70	9.60	51.62	43.30	56.10	46.10	-4.48	-2.80	Pass
5	0.6220	34.84	25.68	9.60	44.44	35.28	56.00	46.00	-11.56	-10.72	Pass
6	2.6580	31.39	22.37	9.69	41.08	32.06	56.00	46.00	-14.92	-13.94	Pass

Note: 1. Result = Correction factor + Reading  
 2. Correction factor = Antenna Factor + Cable loss – Pre-Amplifier gain.



Standard:	FCC Part 15.407	Line:	N
Test item:	Conducted Emission	Power:	AC 120 V/60 Hz
Test Mode:	Mode 1	Temp.(°C)/Hum.(%RH):	26(°C)/60 %RH
Description: Adapter Model Number: PS1012-120HUB100			

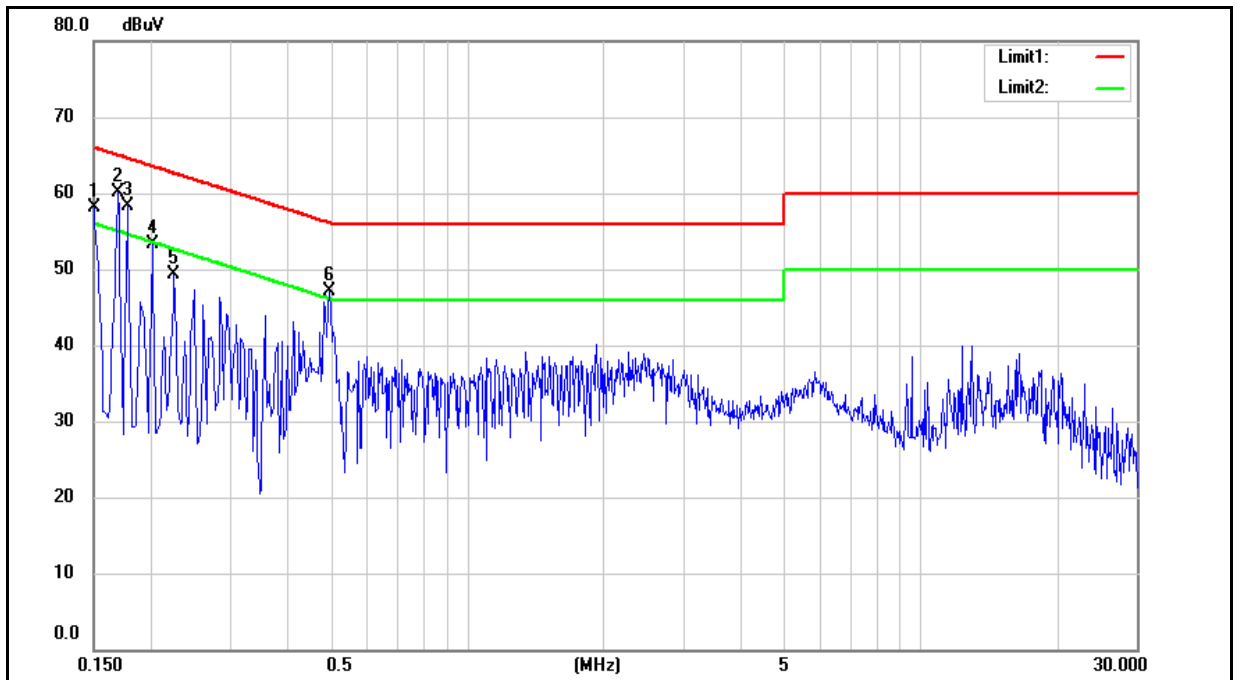

No.	Frequency (MHz)	QP reading (dBuV)	AVG reading (dBuV)	Correction factor (dB)	QP result (dBuV)	AVG result (dBuV)	QP limit (dBuV)	AVG limit (dBuV)	QP margin (dB)	AVG margin (dB)	Remark
1	0.1500	41.06	21.97	9.70	50.76	31.67	66.00	56.00	-15.24	-24.33	Pass
2	0.1700	42.36	22.97	9.71	52.07	32.68	64.96	54.96	-12.89	-22.28	Pass
3	0.1780	39.19	21.77	9.70	48.89	31.47	64.58	54.58	-15.69	-23.11	Pass
4	0.2020	37.92	20.90	9.70	47.62	30.60	63.53	53.53	-15.91	-22.93	Pass
5	0.2260	34.35	19.67	9.70	44.05	29.37	62.60	52.60	-18.55	-23.23	Pass
6	0.4980	36.04	28.53	9.71	45.75	38.24	56.03	46.03	-10.28	-7.79	Pass

Note: 1. Result = Correction factor + Reading  
 2. Correction factor = Antenna Factor + Cable loss – Pre-Amplifier gain.

Standard:	FCC Part 15.407	Line:	L1
Test item:	Conducted Emission	Power:	AC 120 V/60 Hz
Test Mode:	Mode 1	Temp.(°C)/Hum.(%RH):	26(°C)/60 %RH
Description: Adapter Model Number: WB-12G12FU			

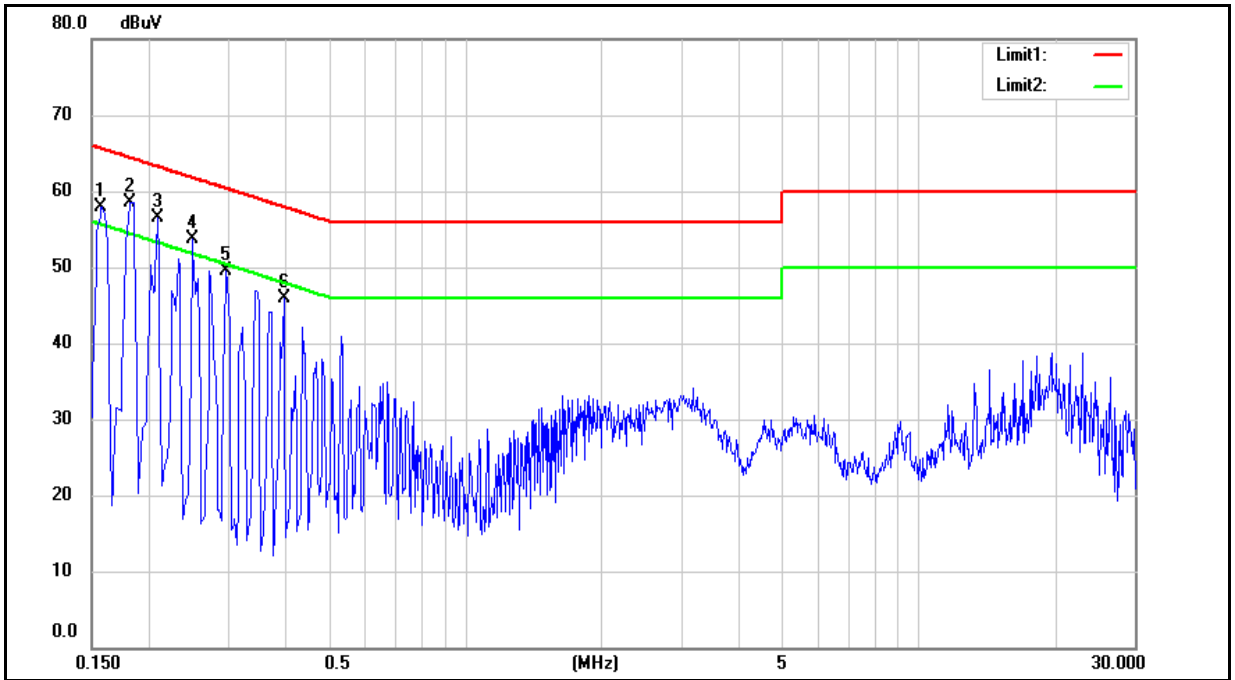

No.	Frequency (MHz)	QP reading (dBuV)	AVG reading (dBuV)	Correction factor (dB)	QP result (dBuV)	AVG result (dBuV)	QP limit (dBuV)	AVG limit (dBuV)	QP margin (dB)	AVG margin (dB)	Remark
1	0.1580	45.78	26.92	9.60	55.38	36.52	65.57	55.57	-10.19	-19.05	Pass
2	0.1820	42.24	24.15	9.60	51.84	33.75	64.39	54.39	-12.55	-20.64	Pass
3	0.2100	39.74	21.00	9.60	49.34	30.60	63.21	53.21	-13.87	-22.61	Pass
4	0.2500	35.94	16.52	9.60	45.54	26.12	61.76	51.76	-16.22	-25.64	Pass
5	0.2980	32.96	13.76	9.60	42.56	23.36	60.30	50.30	-17.74	-26.94	Pass
6	0.3980	28.48	9.95	9.60	38.08	19.55	57.90	47.90	-19.82	-28.35	Pass

Note: 1. Result = Correction factor + Reading  
 2. Correction factor = Antenna Factor + Cable loss – Pre-Amplifier gain.

Standard:	FCC Part 15.407	Line:	N
Test item:	Conducted Emission	Power:	AC 120 V/60 Hz
Test Mode:	Mode 1	Temp.(°C)/Hum.(%RH):	26(°C)/60 %RH
Description: Adapter Model Number: WB-12G12FU			

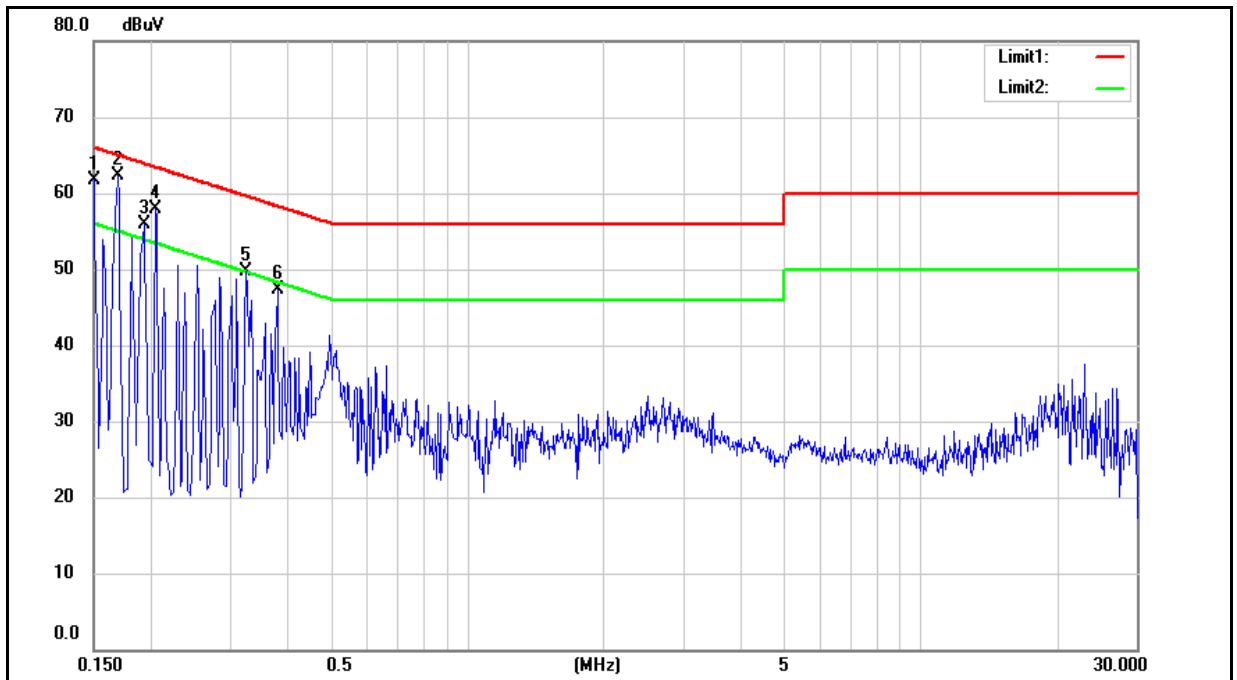

No.	Frequency (MHz)	QP reading (dBuV)	AVG reading (dBuV)	Correction factor (dB)	QP result (dBuV)	AVG result (dBuV)	QP limit (dBuV)	AVG limit (dBuV)	QP margin (dB)	AVG margin (dB)	Remark
1	0.1500	45.72	26.78	9.70	55.42	36.48	66.00	56.00	-10.58	-19.52	Pass
2	0.1700	44.37	24.77	9.71	54.08	34.48	64.96	54.96	-10.88	-20.48	Pass
3	0.1940	41.64	21.81	9.70	51.34	31.51	63.86	53.86	-12.52	-22.35	Pass
4	0.2060	40.34	20.85	9.70	50.04	30.55	63.37	53.37	-13.33	-22.82	Pass
5	0.3260	31.38	13.81	9.70	41.08	23.51	59.55	49.55	-18.47	-26.04	Pass
6	0.3820	28.96	15.82	9.71	38.67	25.53	58.24	48.24	-19.57	-22.71	Pass

Note: 1. Result = Correction factor + Reading  
 2. Correction factor = Antenna Factor + Cable loss – Pre-Amplifier gain.





Standard:	FCC Part 15.407	Line:	L1
Test item:	Conducted Emission	Power:	AC 120 V/60 Hz
Test Mode:	Mode 1	Temp.(°C)/Hum.(%RH):	26(°C)/60 %RH
Description: Adapter Model Number: WB-12G12R			

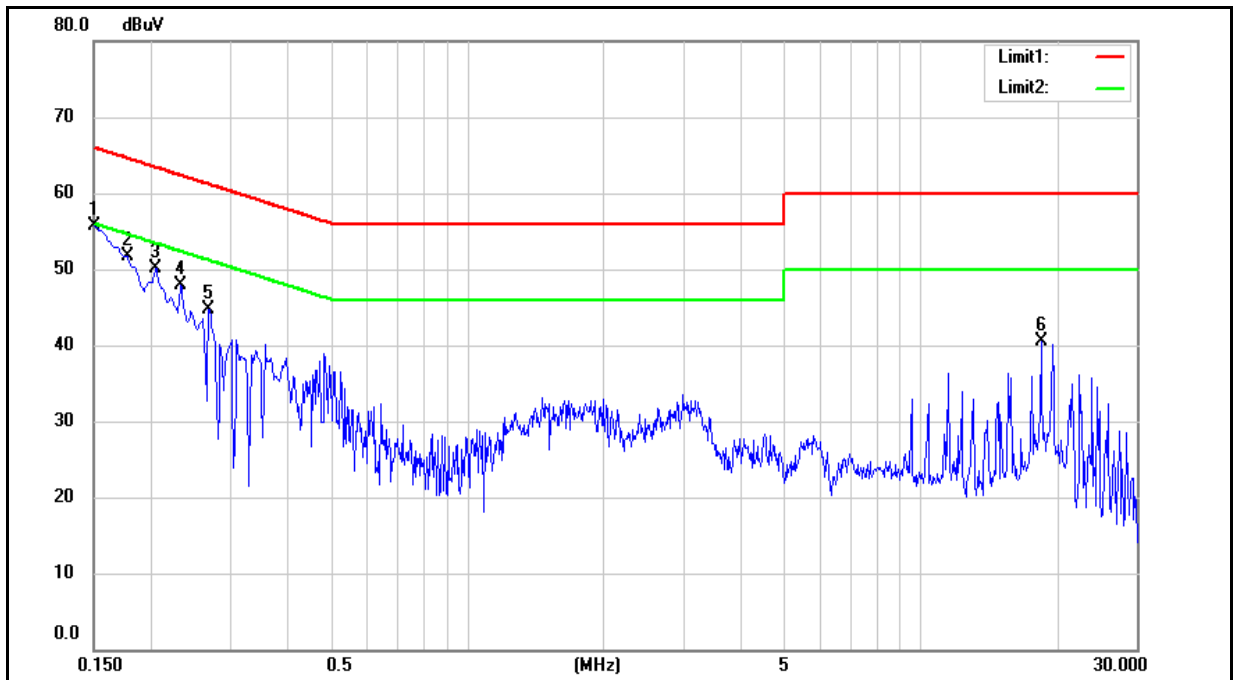

No.	Frequency (MHz)	QP reading (dBuV)	AVG reading (dBuV)	Correction factor (dB)	QP result (dBuV)	AVG result (dBuV)	QP limit (dBuV)	AVG limit (dBuV)	QP margin (dB)	AVG margin (dB)	Remark
1	0.1516	42.99	26.40	9.60	52.59	36.00	65.91	55.91	-13.32	-19.91	Pass
2	0.1780	39.83	23.40	9.60	49.43	33.00	64.58	54.58	-15.15	-21.58	Pass
3	0.2060	36.17	19.78	9.60	45.77	29.38	63.37	53.37	-17.60	-23.99	Pass
4	0.2340	32.90	16.62	9.60	42.50	26.22	62.31	52.31	-19.81	-26.09	Pass
5	0.2700	29.80	15.34	9.60	39.40	24.94	61.12	51.12	-21.72	-26.18	Pass
6	18.4420	23.31	7.19	9.95	33.26	17.14	60.00	50.00	-26.74	-32.86	Pass

Note: 1. Result = Correction factor + Reading  
 2. Correction factor = Antenna Factor + Cable loss – Pre-Amplifier gain.



Standard:	FCC Part 15.407	Line:	N
Test item:	Conducted Emission	Power:	AC 120 V/60 Hz
Test Mode:	Mode 1	Temp.(°C)/Hum.(%RH):	26(°C)/60 %RH
Description: Adapter Model Number: WB-12G12R			

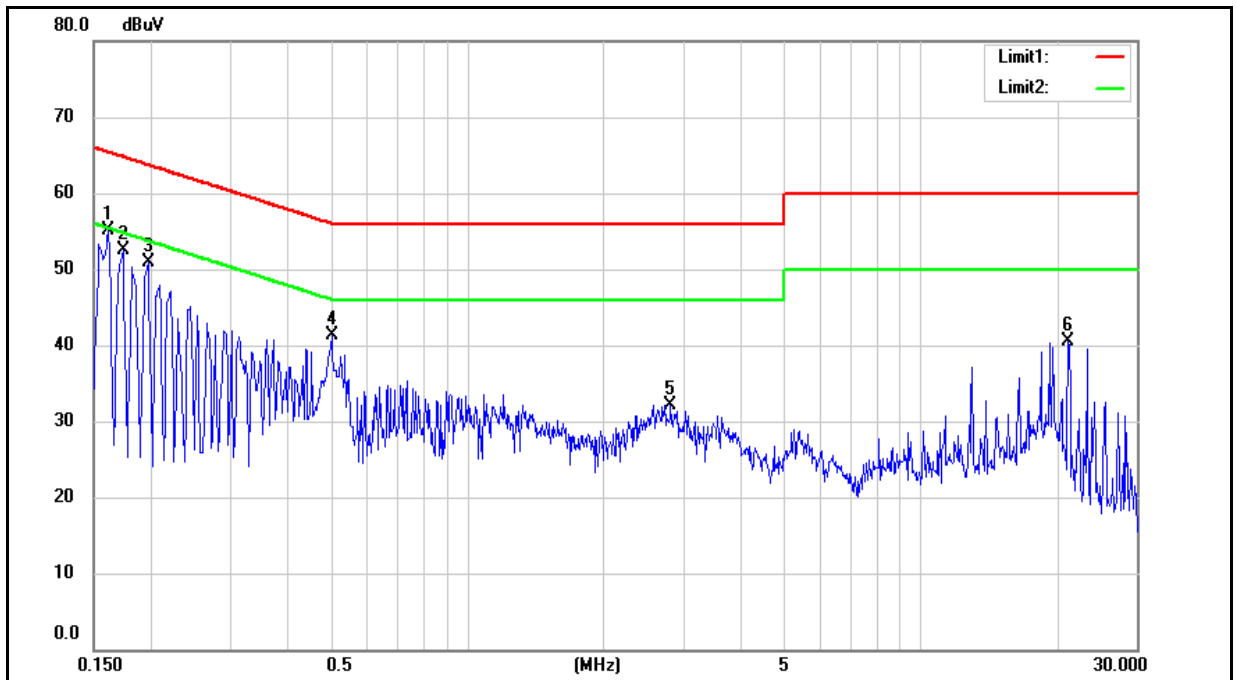

No.	Frequency (MHz)	QP reading (dBuV)	AVG reading (dBuV)	Correction factor (dB)	QP result (dBuV)	AVG result (dBuV)	QP limit (dBuV)	AVG limit (dBuV)	QP margin (dB)	AVG margin (dB)	Remark
1	0.1620	41.87	24.70	9.71	51.58	34.41	65.36	55.36	-13.78	-20.95	Pass
2	0.1740	40.40	23.22	9.71	50.11	32.93	64.77	54.77	-14.66	-21.84	Pass
3	0.1980	37.04	20.89	9.70	46.74	30.59	63.69	53.69	-16.95	-23.10	Pass
4	0.5020	28.62	24.60	9.71	38.33	34.31	56.00	46.00	-17.67	-11.69	Pass
5	2.8180	17.88	12.64	9.80	27.68	22.44	56.00	46.00	-28.32	-23.56	Pass
6	21.1900	23.11	4.55	10.21	33.32	14.76	60.00	50.00	-26.68	-35.24	Pass

Note: 1. Result = Correction factor + Reading  
 2. Correction factor = Antenna Factor + Cable loss – Pre-Amplifier gain.



## 5.2. Transmitter Radiated Emissions Measurement

Below 1 GHz

Standard:	FCC Part 15.407	Test Distance:	3 m				
Test item:	Harmonic	Power:	AC 120 V/60 Hz				
Test Mode:	Mode 1	Temp.(°C)/Hum.(%RH):	26(°C)/60 %RH				
Description:	Adapter Model Number: PS1012-120HUB100						
Frequency (MHz)	Reading (dBuV)	Correct Factor (dB/m)	Result (dBuV/m)	Limit (dBuV/m)	Margin (dB)	Remark	Ant.Polar. H / V
35.8200	45.73	-6.57	39.16	40.00	-0.84	QP	H
50.3700	40.92	-6.25	34.67	40.00	-5.33	QP	H
136.7000	41.20	-6.60	34.60	43.50	-8.90	QP	H
171.6200	39.37	-5.92	33.45	43.50	-10.05	QP	H
191.9900	42.96	-7.62	35.34	43.50	-8.16	QP	H
246.3100	35.27	-5.88	29.39	46.00	-16.61	QP	H
38.7300	41.79	-6.38	35.41	40.00	-4.59	QP	V
76.5600	44.67	-10.02	34.65	40.00	-5.35	QP	V
140.5800	42.95	-6.17	36.78	43.50	-6.72	QP	V
151.2500	43.40	-5.70	37.70	43.50	-5.80	QP	V
197.8100	45.42	-7.74	37.68	43.50	-5.82	QP	V
522.7600	32.42	0.56	32.98	46.00	-13.02	QP	V

Note:1.Result (dBuV/m) = Correct Factor (dB/m) + Reading(dBuV).

Example: 39.16=-6.57+45.73

2.Correction factor (dB/m) = Antenna Factor (dB/m) + Cable loss (dB) – Pre-Amplifier gain (dB).

3.When the peak results are less than average limit, so not need to evaluate the average.



Above 1 GHz

Standard:	FCC Part 15.407	Test Distance:	3 m
Test item:	Harmonic	Power:	AC 120 V/60 Hz
Frequency:	5180 MHz	Temp.(°C)/Hum.(%RH):	26(°C)/60 %RH
Mode:	Mode 2		
Ant.Polar.:	Horizontal		

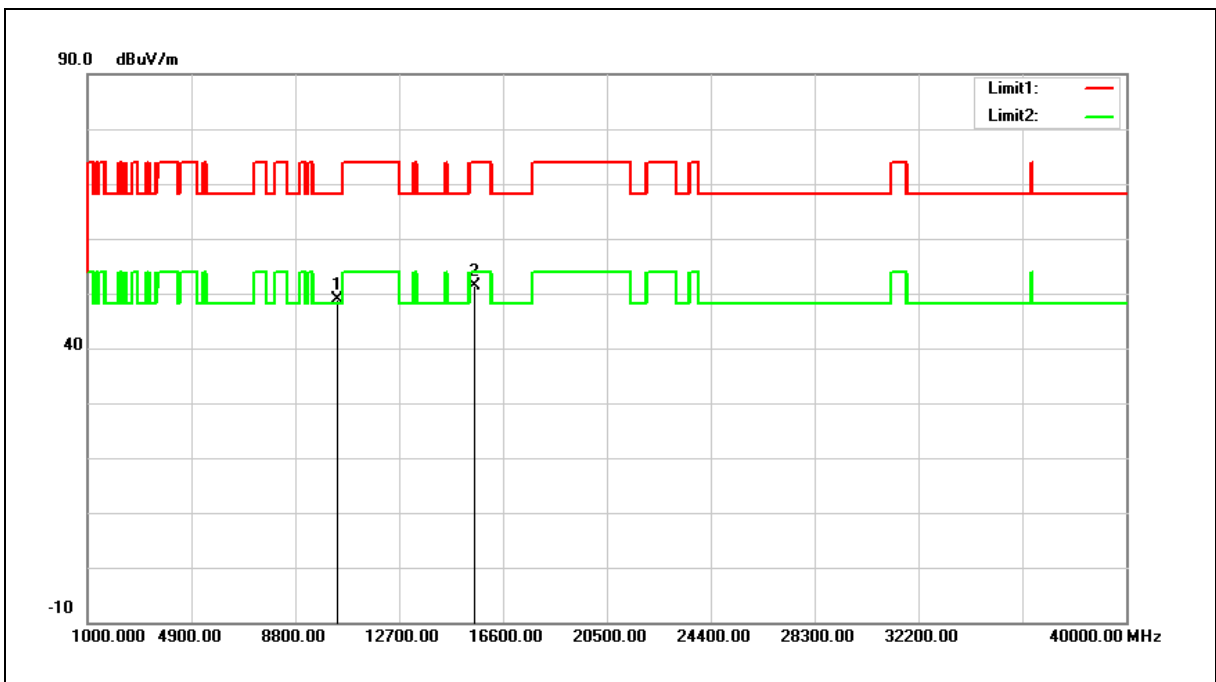

No.	Frequency (MHz)	Reading (dBuV)	Correct Factor (dB/m)	Result (dBuV/m)	Limit (dBuV/m)	Margin (dB)	Remark
1	10360.000	32.85	16.09	48.94	68.20	-19.26	peak
2	15540.000	33.14	18.35	51.49	74.00	-22.51	peak

Note:1.Result (dBuV/m) = Correct Factor (dB/m) + Reading(dBuV).

Example: 48.94=16.09+32.85

2.Correction factor (dB/m) = Antenna Factor (dB/m) + Cable loss (dB) – Pre-Amplifier gain (dB).

3.When the peak results are less than average limit, so not need to evaluate the average.



Standard:	FCC Part 15.407	Test Distance:	3 m
Test item:	Harmonic	Power:	AC 120 V/60 Hz
Frequency:	5180 MHz	Temp.(°C)/Hum.(%RH):	26(°C)/60 %RH
Mode:	Mode 2		
Ant.Polar.:	Vertical		

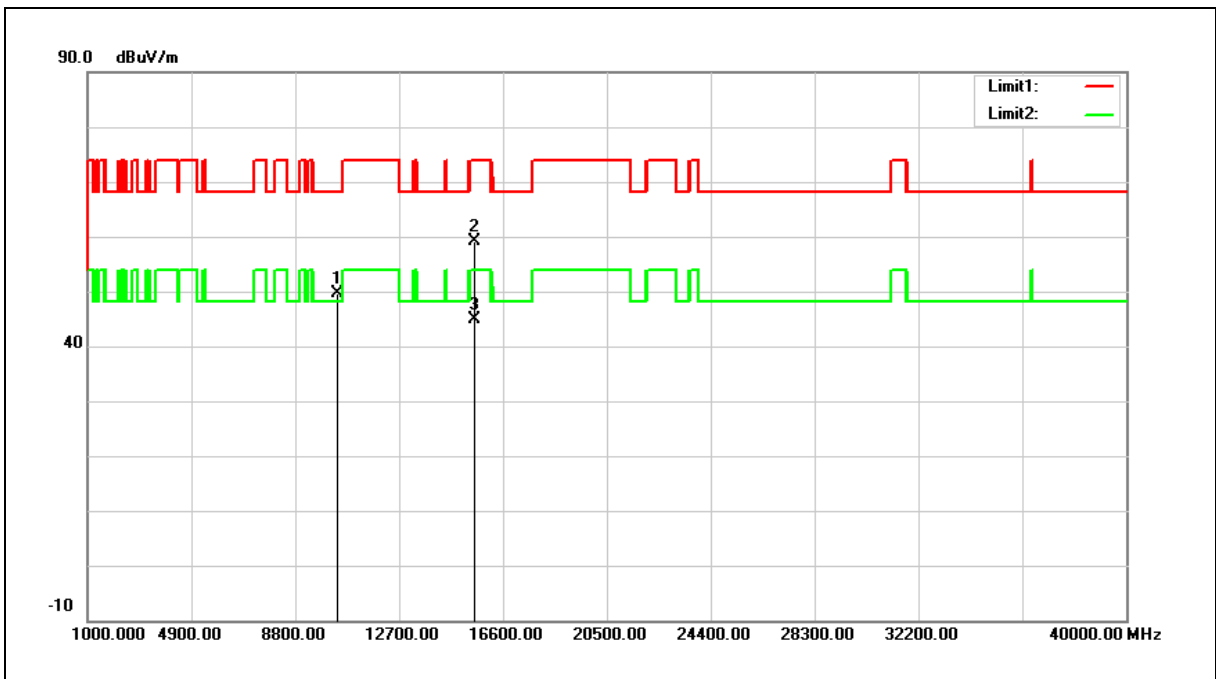

No.	Frequency (MHz)	Reading (dBuV)	Correct Factor (dB/m)	Result (dBuV/m)	Limit (dBuV/m)	Margin (dB)	Remark
1	10360.000	33.42	16.09	49.51	68.20	-18.69	peak
2	15540.000	40.74	18.35	59.09	74.00	-14.91	peak
3	15540.000	26.61	18.35	44.96	54.00	-9.04	AVG

Note:1.Result (dBuV/m) = Correct Factor (dB/m) + Reading(dBuV).

Example: 49.51=16.09+33.42

2.Correction factor (dB/m) = Antenna Factor (dB/m) + Cable loss (dB) – Pre-Amplifier gain (dB).

3.When the peak results are less than average limit, so not need to evaluate the average.



Standard:	FCC Part 15.407	Test Distance:	3 m
Test item:	Harmonic	Power:	AC 120 V/60 Hz
Frequency:	5200 MHz	Temp.(°C)/Hum.(%RH):	26(°C)/60 %RH
Mode:	Mode 2		
Ant.Polar.:	Horizontal		

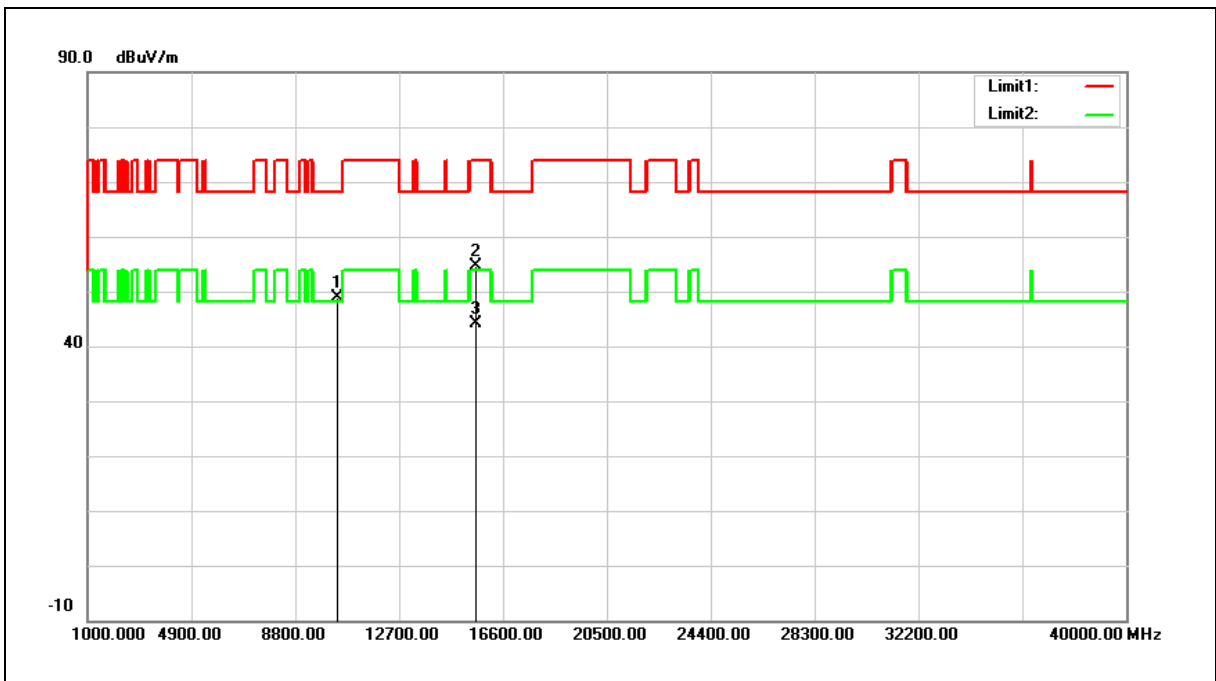

No.	Frequency (MHz)	Reading (dBuV)	Correct Factor (dB/m)	Result (dBuV/m)	Limit (dBuV/m)	Margin (dB)	Remark
1	10400.000	32.73	16.22	48.95	68.20	-19.25	peak
2	15600.000	36.35	18.19	54.54	74.00	-19.46	peak
3	15600.000	26.05	18.19	44.24	54.00	-9.76	AVG

Note:1.Result (dBuV/m) = Correct Factor (dB/m) + Reading(dBuV).

2.Correction factor (dB/m) = Antenna Factor (dB/m) + Cable loss (dB) – Pre-Amplifier gain (dB).

3.When the peak results are less than average limit, so not need to evaluate the average.



Standard:	FCC Part 15.407	Test Distance:	3 m
Test item:	Harmonic	Power:	AC 120 V/60 Hz
Frequency:	5200 MHz	Temp.(°C)/Hum.(%RH):	26(°C)/60 %RH
Mode:	Mode 2		
Ant.Polar.:	Vertical		

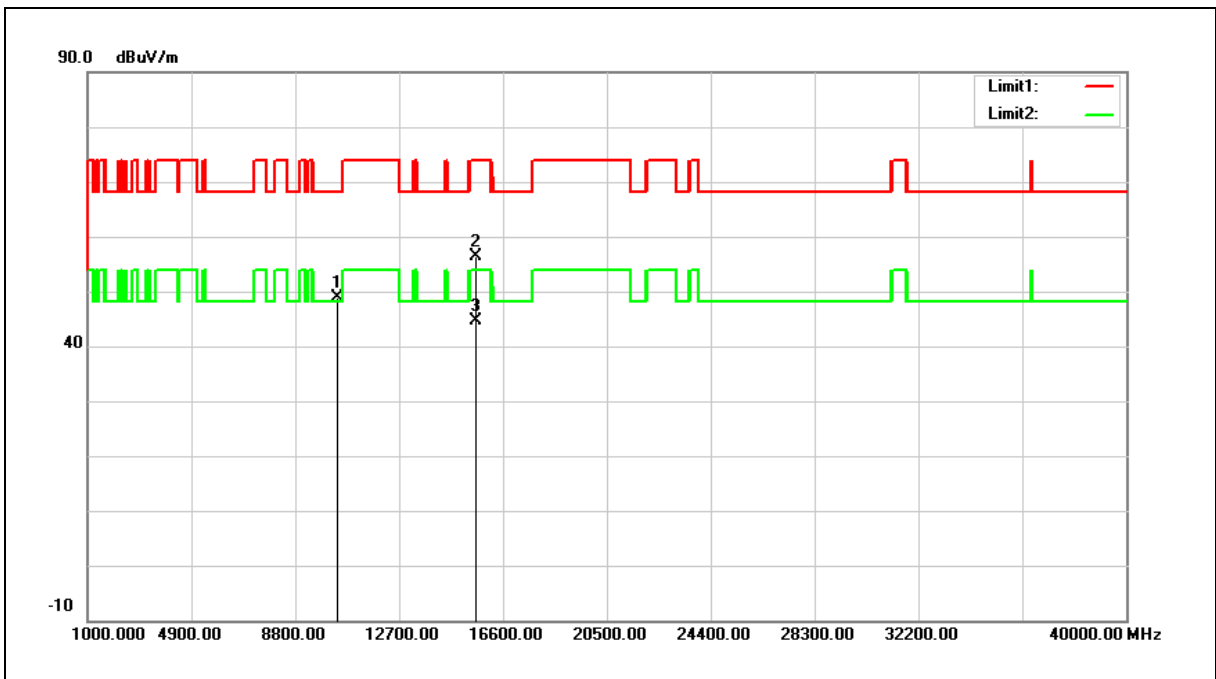

No.	Frequency (MHz)	Reading (dBuV)	Correct Factor (dB/m)	Result (dBuV/m)	Limit (dBuV/m)	Margin (dB)	Remark
1	10400.000	32.73	16.22	48.95	68.20	-19.25	peak
2	15600.000	38.28	18.19	56.47	74.00	-17.53	peak
3	15600.000	26.55	18.19	44.74	54.00	-9.26	AVG

Note:1.Result (dBuV/m) = Correct Factor (dB/m) + Reading(dBuV).

2.Correction factor (dB/m) = Antenna Factor (dB/m) + Cable loss (dB) – Pre-Amplifier gain (dB).

3.When the peak results are less than average limit, so not need to evaluate the average.



Standard:	FCC Part 15.407	Test Distance:	3 m
Test item:	Harmonic	Power:	AC 120 V/60 Hz
Frequency:	5240 MHz	Temp.(°C)/Hum.(%RH):	26(°C)/60 %RH
Mode:	Mode 2		
Ant.Polar.:	Horizontal		

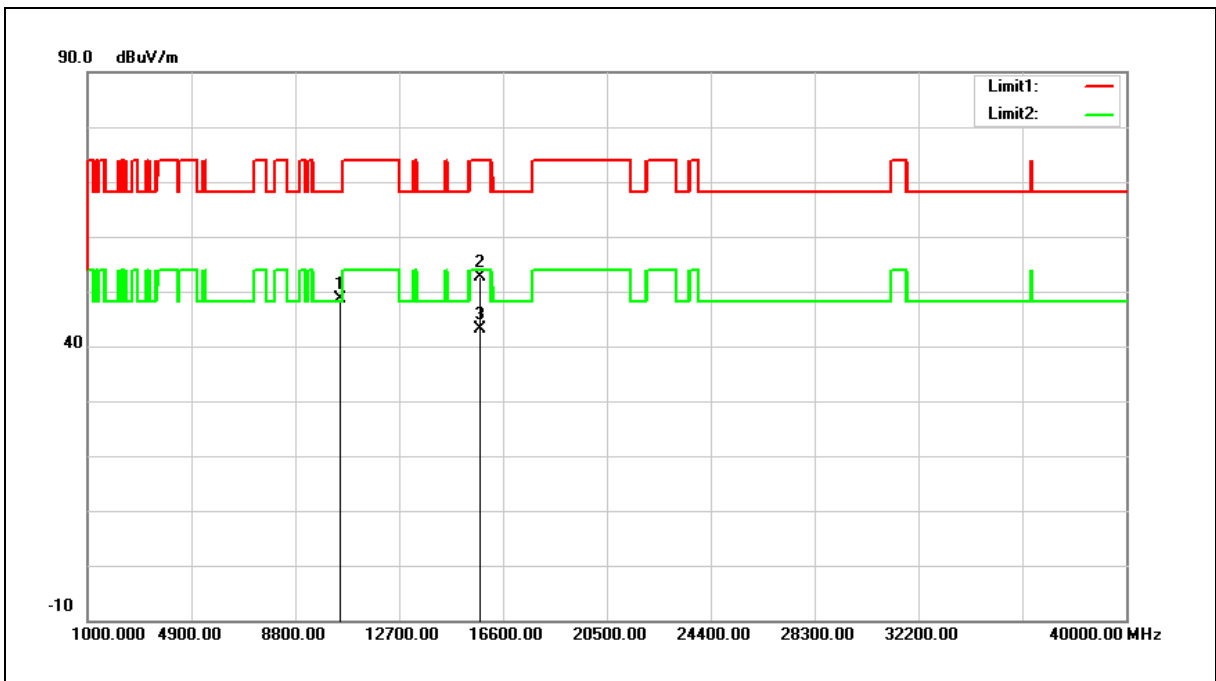

No.	Frequency (MHz)	Reading (dBuV)	Correct Factor (dB/m)	Result (dBuV/m)	Limit (dBuV/m)	Margin (dB)	Remark
1	10480.000	32.10	16.47	48.57	68.20	-19.63	peak
2	15720.000	34.67	17.88	52.55	74.00	-21.45	peak
3	15720.000	25.19	17.88	43.07	54.00	-10.93	AVG

Note:1.Result (dBuV/m) = Correct Factor (dB/m) + Reading(dBuV).

2.Correction factor (dB/m) = Antenna Factor (dB/m) + Cable loss (dB) – Pre-Amplifier gain (dB).

3.When the peak results are less than average limit, so not need to evaluate the average.





Standard:	FCC Part 15.407	Test Distance:	3 m
Test item:	Harmonic	Power:	AC 120 V/60 Hz
Frequency:	5240 MHz	Temp.(°C)/Hum.(%RH):	26(°C)/60 %RH
Mode:	Mode 2		
Ant.Polar.:	Vertical		

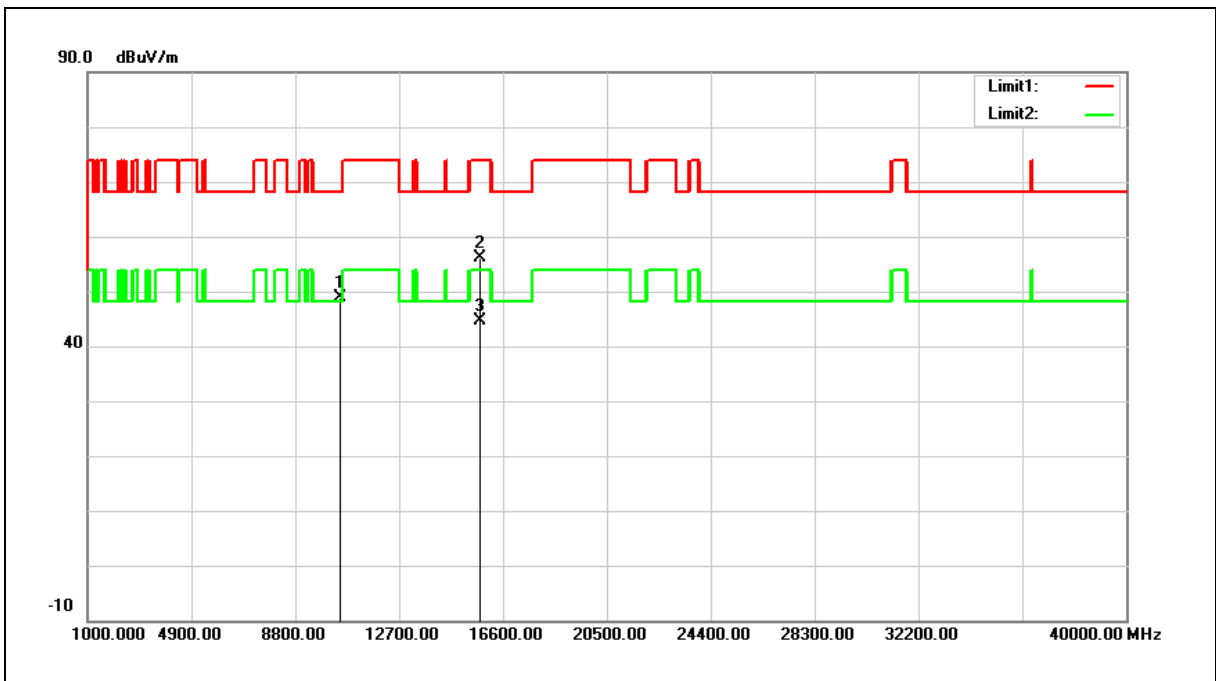

No.	Frequency (MHz)	Reading (dBuV)	Correct Factor (dB/m)	Result (dBuV/m)	Limit (dBuV/m)	Margin (dB)	Remark
1	10480.000	32.38	16.47	48.85	68.20	-19.35	peak
2	15720.000	38.20	17.88	56.08	74.00	-17.92	peak
3	15720.000	26.74	17.88	44.62	54.00	-9.38	AVG

- Note:1.Result (dBuV/m) = Correct Factor (dB/m) + Reading(dBuV).
- 2.Correction factor (dB/m) = Antenna Factor (dB/m) + Cable loss (dB) – Pre-Amplifier gain (dB).
- 3.When the peak results are less than average limit, so not need to evaluate the average.



Standard:	FCC Part 15.407	Test Distance:	3 m
Test item:	Harmonic	Power:	AC 120 V/60 Hz
Frequency:	5745 MHz	Temp.(°C)/Hum.(%RH):	26(°C)/60 %RH
Mode:	Mode 2		
Ant.Polar.:	Horizontal		

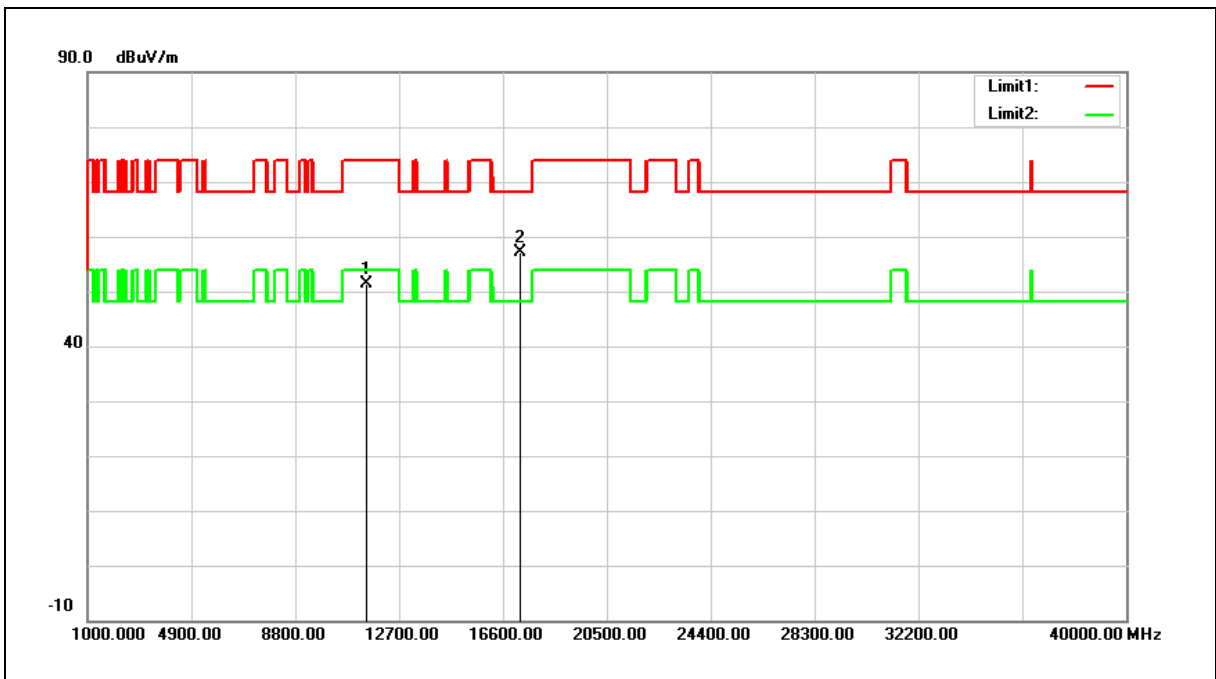

No.	Frequency (MHz)	Reading (dBuV)	Correct Factor (dB/m)	Result (dBuV/m)	Limit (dBuV/m)	Margin (dB)	Remark
1	11490.000	33.35	18.11	51.46	74.00	-22.54	peak
2	17235.000	34.16	22.86	57.02	68.20	-11.18	peak

Note: 1.Result (dBuV/m) = Correct Factor (dB/m) + Reading(dBuV).

2.Correction factor (dB/m) = Antenna Factor (dB/m) + Cable loss (dB) – Pre-Amplifier gain (dB).

3.When the peak results are less than average limit, so not need to evaluate the average.



Standard:	FCC Part 15.407	Test Distance:	3 m
Test item:	Harmonic	Power:	AC 120 V/60 Hz
Frequency:	5745 MHz	Temp.(°C)/Hum.(%RH):	26(°C)/60 %RH
Mode:	Mode 2		
Ant.Polar.:	Vertical		

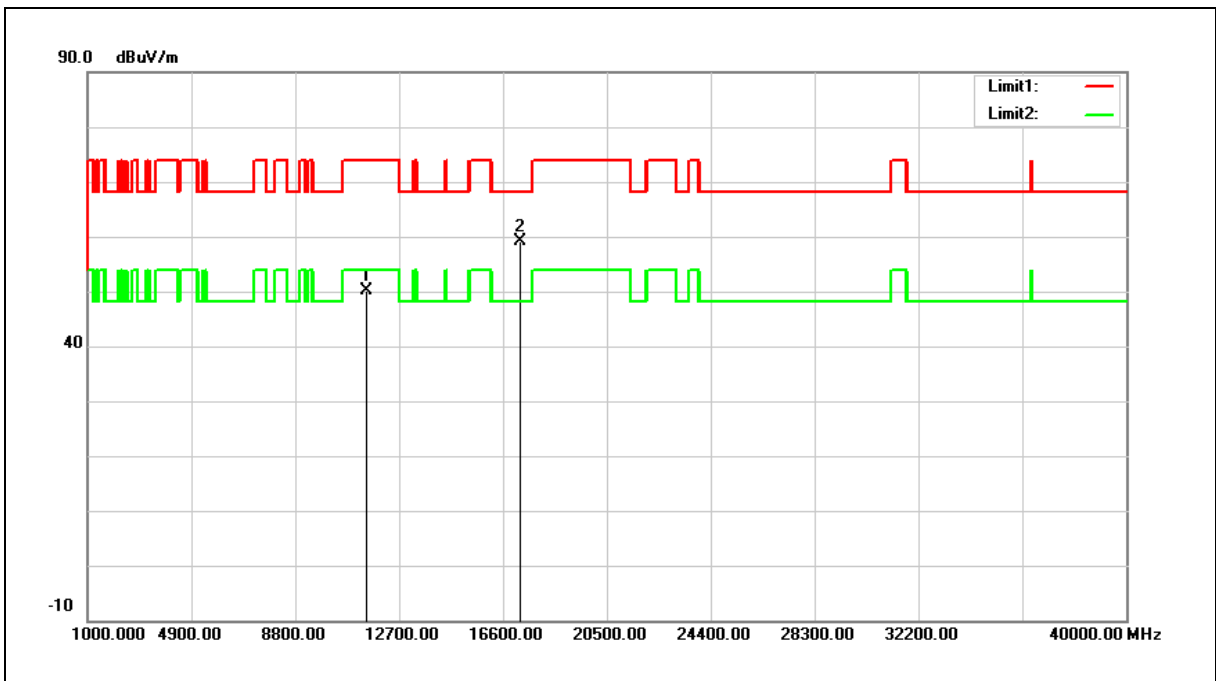

No.	Frequency (MHz)	Reading (dBuV)	Correct Factor (dB/m)	Result (dBuV/m)	Limit (dBuV/m)	Margin (dB)	Remark
1	11490.000	32.07	18.11	50.18	74.00	-23.82	peak
2	17235.000	36.31	22.86	59.17	68.20	-9.03	peak

- Note: 1.Result (dBuV/m) = Correct Factor (dB/m) + Reading(dBuV).  
 2.Correction factor (dB/m) = Antenna Factor (dB/m) + Cable loss (dB) – Pre-Amplifier gain (dB).  
 3.When the peak results are less than average limit, so not need to evaluate the average.



Standard:	FCC Part 15.407	Test Distance:	3 m
Test item:	Harmonic	Power:	AC 120 V/60 Hz
Frequency:	5785 MHz	Temp.(°C)/Hum.(%RH):	26(°C)/60 %RH
Mode:	Mode 2		
Ant.Polar.:	Horizontal		

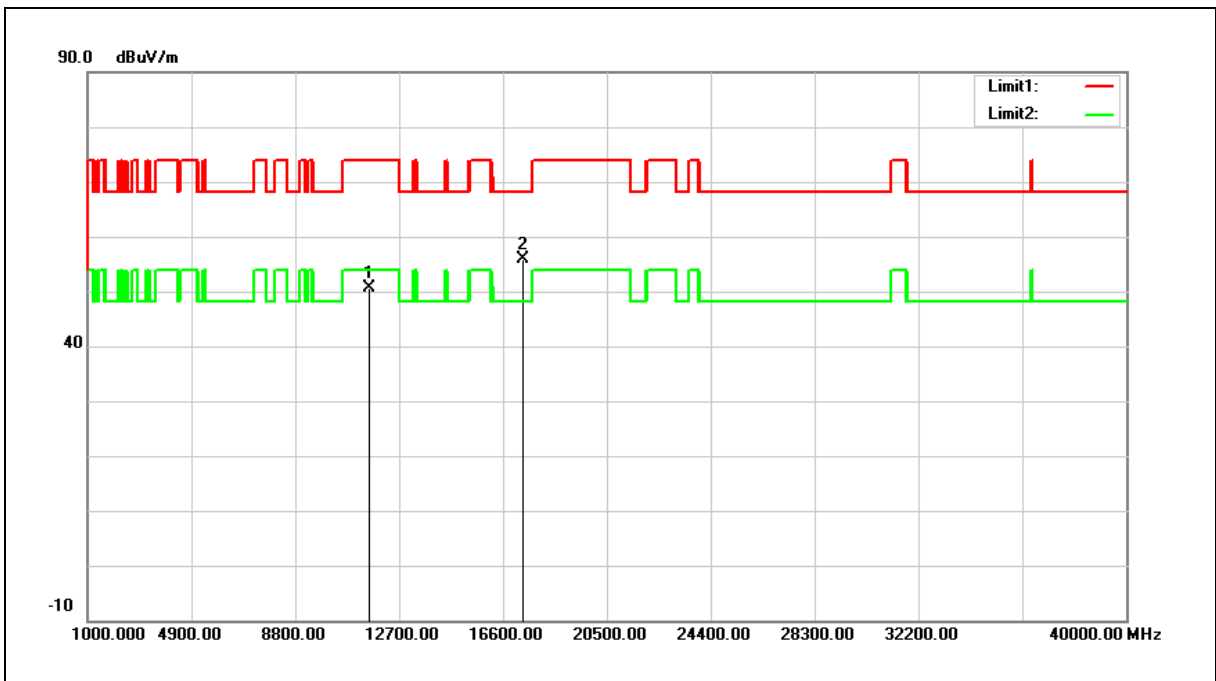

No.	Frequency (MHz)	Reading (dBuV)	Correct Factor (dB/m)	Result (dBuV/m)	Limit (dBuV/m)	Margin (dB)	Remark
1	11570.000	32.70	18.03	50.73	74.00	-23.27	peak
2	17355.000	32.38	23.45	55.83	68.20	-12.37	peak

Note:1.Result (dBuV/m) = Correct Factor (dB/m) + Reading(dBuV).

2.Correction factor (dB/m) = Antenna Factor (dB/m) + Cable loss (dB) – Pre-Amplifier gain (dB).

3.When the peak results are less than average limit, so not need to evaluate the average.



Standard:	FCC Part 15.407	Test Distance:	3 m
Test item:	Harmonic	Power:	AC 120 V/60 Hz
Frequency:	5785 MHz	Temp.(°C)/Hum.(%RH):	26(°C)/60 %RH
Mode:	Mode 2		
Ant.Polar.:	Vertical		

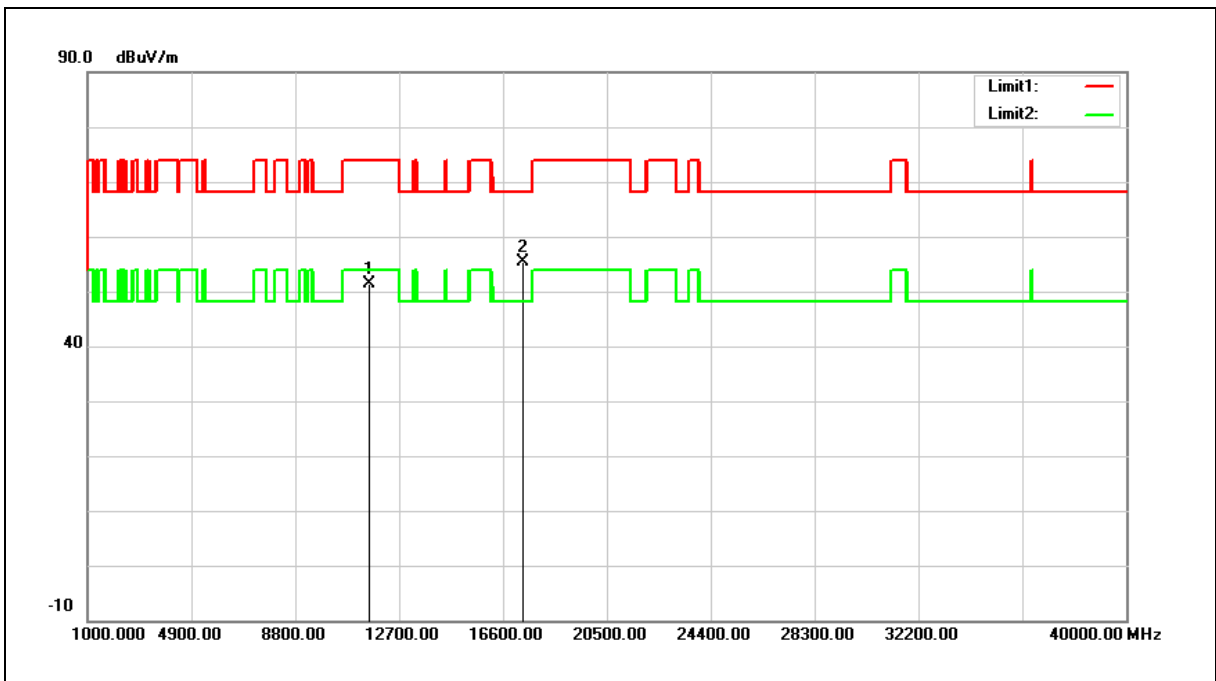

No.	Frequency (MHz)	Reading (dBuV)	Correct Factor (dB/m)	Result (dBuV/m)	Limit (dBuV/m)	Margin (dB)	Remark
1	11570.000	33.43	18.03	51.46	74.00	-22.54	peak
2	17355.000	32.01	23.45	55.46	68.20	-12.74	peak

Note:1.Result (dBuV/m) = Correct Factor (dB/m) + Reading(dBuV).

2.Correction factor (dB/m) = Antenna Factor (dB/m) + Cable loss (dB) – Pre-Amplifier gain (dB).

3.When the peak results are less than average limit, so not need to evaluate the average.



Standard:	FCC Part 15.407	Test Distance:	3 m
Test item:	Harmonic	Power:	AC 120 V/60 Hz
Frequency:	5825 MHz	Temp.(°C)/Hum.(%RH):	26(°C)/60 %RH
Mode:	Mode 2		
Ant.Polar.:	Horizontal		

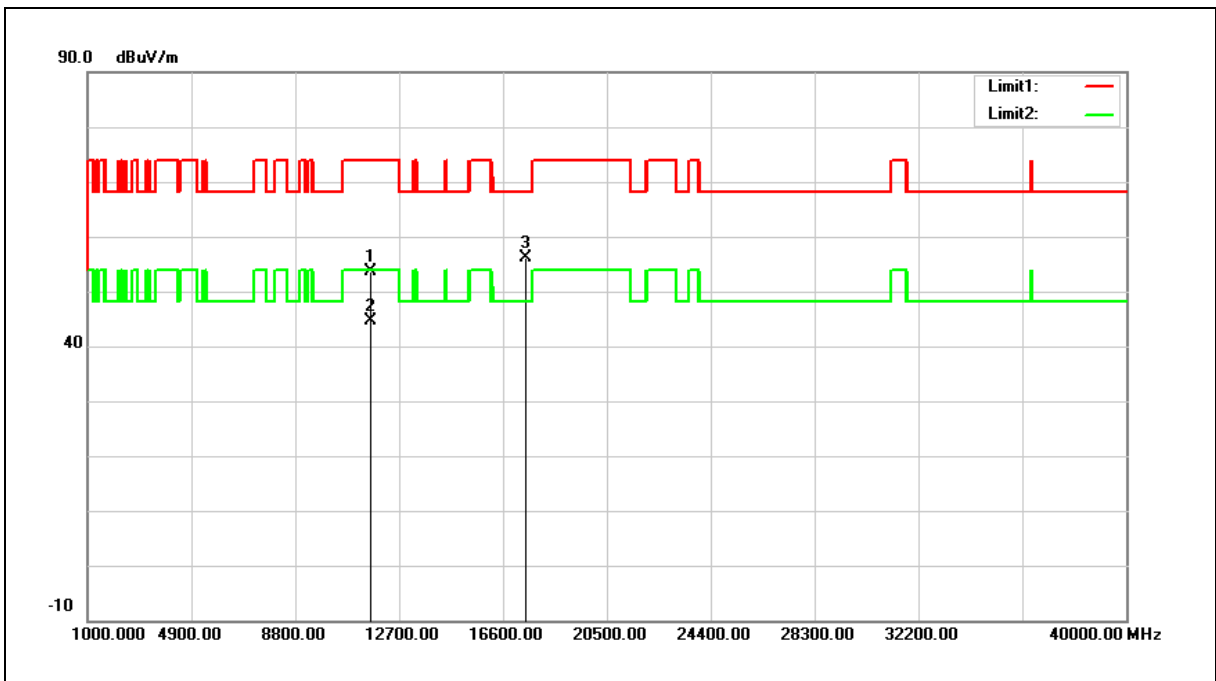

No.	Frequency (MHz)	Reading (dBuV)	Correct Factor (dB/m)	Result (dBuV/m)	Limit (dBuV/m)	Margin (dB)	Remark
1	11650.000	35.73	17.93	53.66	74.00	-20.34	peak
2	11650.000	26.62	17.93	44.55	54.00	-9.45	AVG
3	17475.000	32.09	24.04	56.13	68.20	-12.07	peak

Note:1.Result (dBuV/m) = Correct Factor (dB/m) + Reading(dBuV).

2.Correction factor (dB/m) = Antenna Factor (dB/m) + Cable loss (dB) – Pre-Amplifier gain (dB).

3.When the peak results are less than average limit, so not need to evaluate the average.



Standard:	FCC Part 15.407	Test Distance:	3 m
Test item:	Harmonic	Power:	AC 120 V/60 Hz
Frequency:	5825 MHz	Temp.(°C)/Hum.(%RH):	26(°C)/60 %RH
Mode:	Mode 2		
Ant.Polar.:	Vertical		

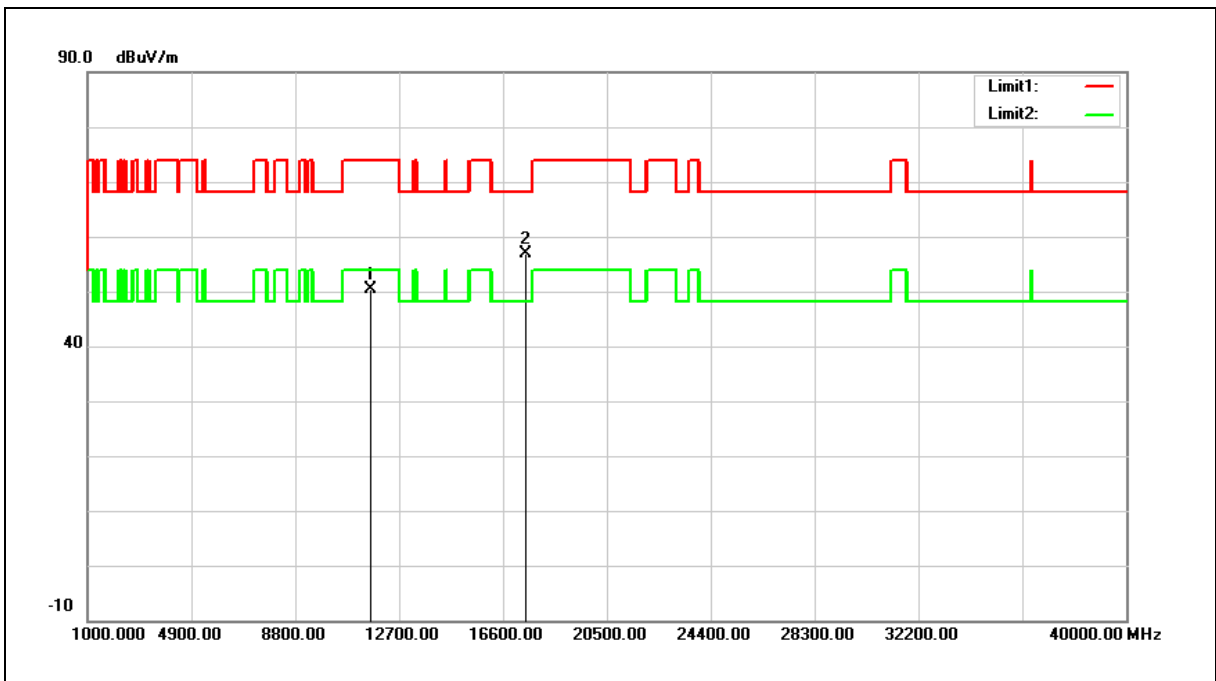

No.	Frequency (MHz)	Reading (dBuV)	Correct Factor (dB/m)	Result (dBuV/m)	Limit (dBuV/m)	Margin (dB)	Remark
1	11650.000	32.56	17.93	50.49	74.00	-23.51	peak
2	17475.000	32.81	24.04	56.85	68.20	-11.35	peak

- Note: 1.Result (dBuV/m) = Correct Factor (dB/m) + Reading(dBuV).  
 2.Correction factor (dB/m) = Antenna Factor (dB/m) + Cable loss (dB) – Pre-Amplifier gain (dB).  
 3.When the peak results are less than average limit, so not need to evaluate the average.



Standard:	FCC Part 15.407	Test Distance:	3 m
Test item:	Harmonic	Power:	AC 120 V/60 Hz
Frequency:	5180 MHz	Temp.(°C)/Hum.(%RH):	26(°C)/60 %RH
Mode:	Mode 3		
Ant.Polar.:	Horizontal		

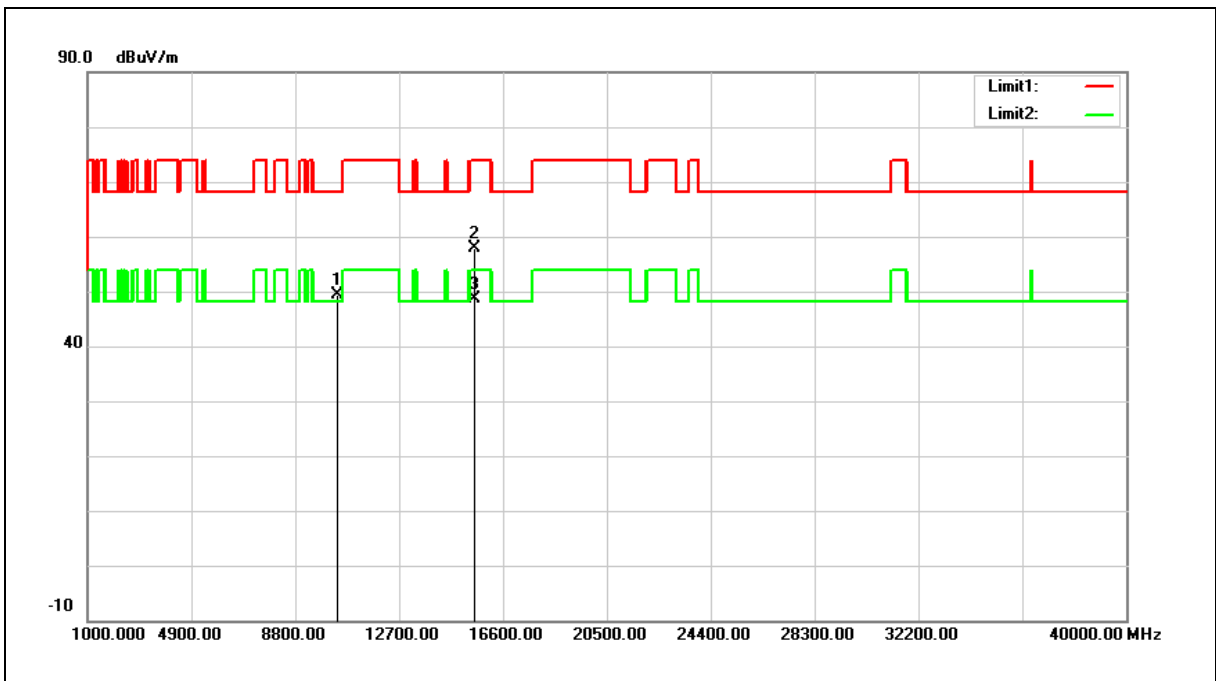

No.	Frequency (MHz)	Reading (dBuV)	Correct Factor (dB/m)	Result (dBuV/m)	Limit (dBuV/m)	Margin (dB)	Remark
1	10360.000	33.35	16.09	49.44	68.20	-18.76	peak
2	15540.000	39.59	18.35	57.94	74.00	-16.06	peak
3	15540.000	30.30	18.35	48.65	54.00	-5.35	AVG

Note:1.Result (dBuV/m) = Correct Factor (dB/m) + Reading(dBuV).

2.Correction factor (dB/m) = Antenna Factor (dB/m) + Cable loss (dB) – Pre-Amplifier gain (dB).

3.When the peak results are less than average limit, so not need to evaluate the average.





Standard:	FCC Part 15.407	Test Distance:	3 m
Test item:	Harmonic	Power:	AC 120 V/60 Hz
Frequency:	5180 MHz	Temp.(°C)/Hum.(%RH):	26(°C)/60 %RH
Mode:	Mode 3		
Ant.Polar.:	Vertical		

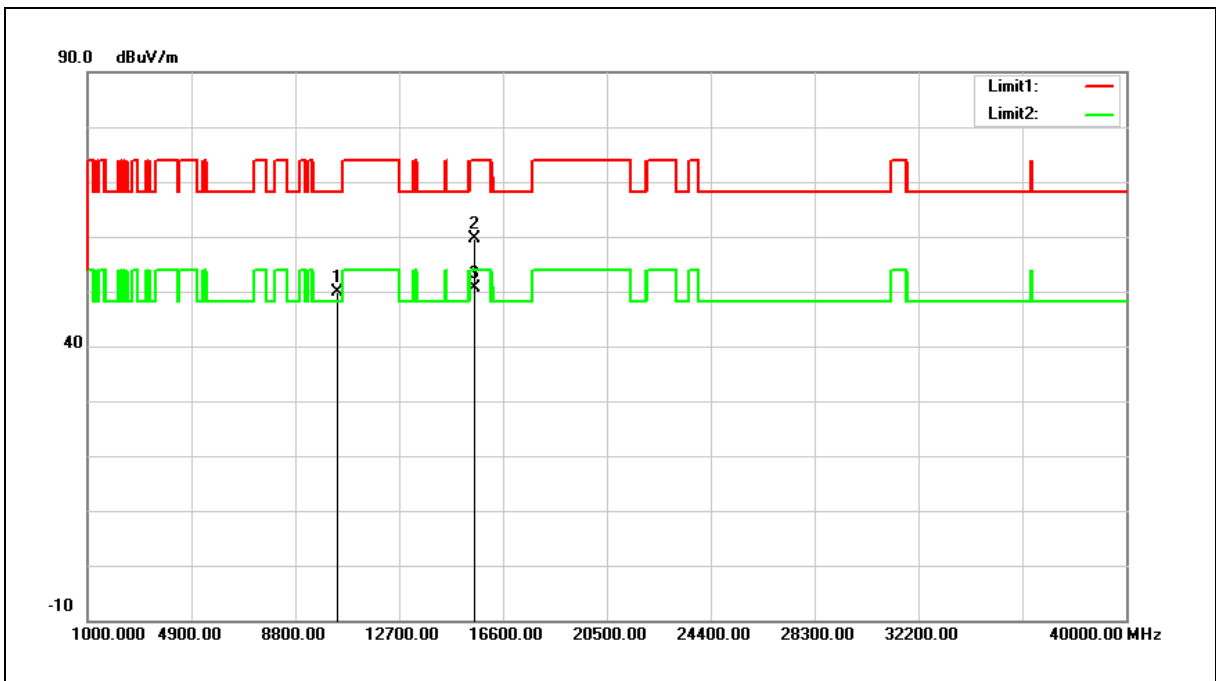

No.	Frequency (MHz)	Reading (dBuV)	Correct Factor (dB/m)	Result (dBuV/m)	Limit (dBuV/m)	Margin (dB)	Remark
1	10360.000	33.75	16.09	49.84	68.20	-18.36	peak
2	15540.000	41.28	18.35	59.63	74.00	-14.37	peak
3	15540.000	32.25	18.35	50.60	54.00	-3.40	AVG

Note:1.Result (dBuV/m) = Correct Factor (dB/m) + Reading(dBuV).

2.Correction factor (dB/m) = Antenna Factor (dB/m) + Cable loss (dB) – Pre-Amplifier gain (dB).

3.When the peak results are less than average limit, so not need to evaluate the average.



Standard:	FCC Part 15.407	Test Distance:	3 m
Test item:	Harmonic	Power:	AC 120 V/60 Hz
Frequency:	5200 MHz	Temp.(°C)/Hum.(%RH):	26(°C)/60 %RH
Mode:	Mode 3		
Ant.Polar.:	Horizontal		

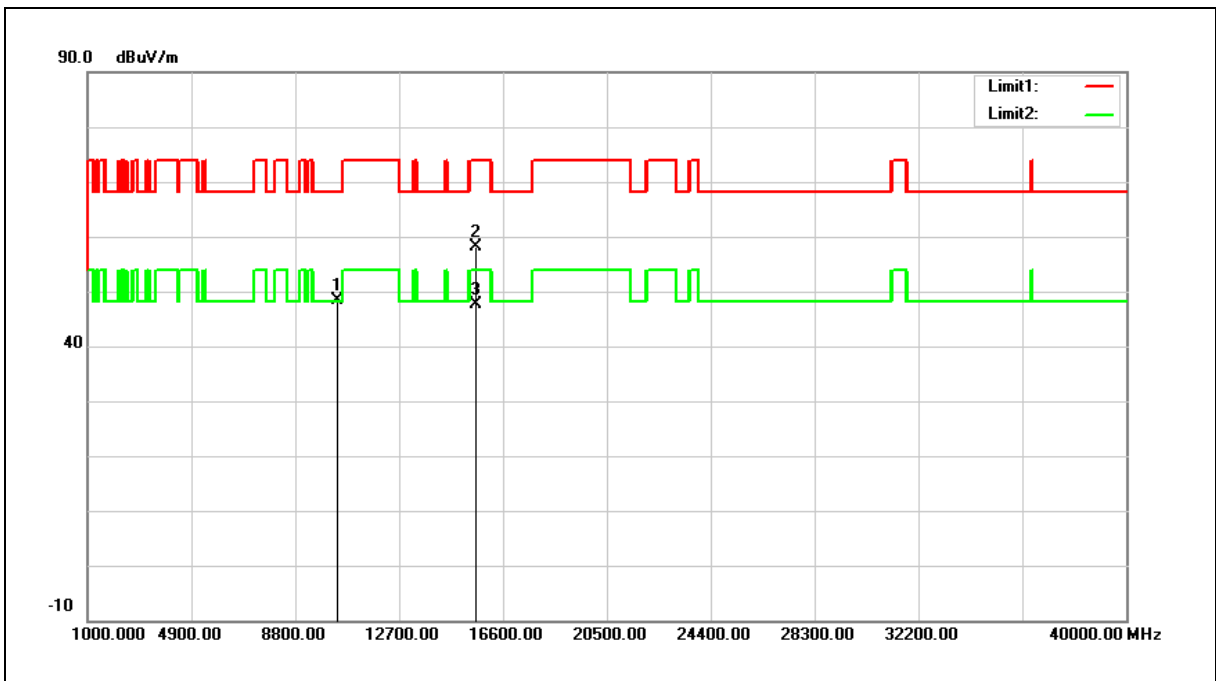

No.	Frequency (MHz)	Reading (dBuV)	Correct Factor (dB/m)	Result (dBuV/m)	Limit (dBuV/m)	Margin (dB)	Remark
1	10400.000	32.06	16.22	48.28	68.20	-19.92	peak
2	15600.000	39.84	18.19	58.03	74.00	-15.97	peak
3	15600.000	29.34	18.19	47.53	54.00	-6.47	AVG

Note:1.Result (dBuV/m) = Correct Factor (dB/m) + Reading(dBuV).

2.Correction factor (dB/m) = Antenna Factor (dB/m) + Cable loss (dB) – Pre-Amplifier gain (dB).

3.When the peak results are less than average limit, so not need to evaluate the average.



Standard:	FCC Part 15.407	Test Distance:	3 m
Test item:	Harmonic	Power:	AC 120 V/60 Hz
Frequency:	5200 MHz	Temp.(°C)/Hum.(%RH):	26(°C)/60 %RH
Mode:	Mode 3		
Ant.Polar.:	Vertical		

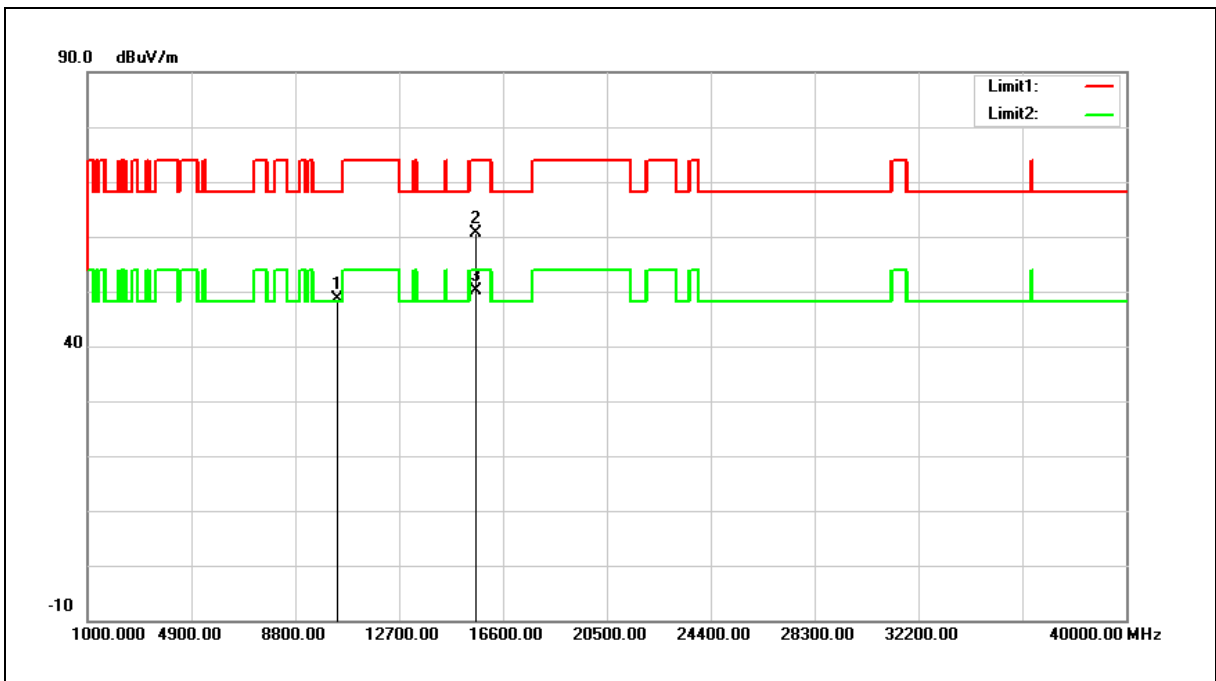

No.	Frequency (MHz)	Reading (dBuV)	Correct Factor (dB/m)	Result (dBuV/m)	Limit (dBuV/m)	Margin (dB)	Remark
1	10400.000	32.48	16.22	48.70	68.20	-19.50	peak
2	15600.000	42.48	18.19	60.67	74.00	-13.33	peak
3	15600.000	32.06	18.19	50.25	54.00	-3.75	AVG

Note:1.Result (dBuV/m) = Correct Factor (dB/m) + Reading(dBuV).

2.Correction factor (dB/m) = Antenna Factor (dB/m) + Cable loss (dB) – Pre-Amplifier gain (dB).

3.When the peak results are less than average limit, so not need to evaluate the average.



Standard:	FCC Part 15.407	Test Distance:	3 m
Test item:	Harmonic	Power:	AC 120 V/60 Hz
Frequency:	5240 MHz	Temp.(°C)/Hum.(%RH):	26(°C)/60 %RH
Mode:	Mode 3		
Ant.Polar.:	Horizontal		

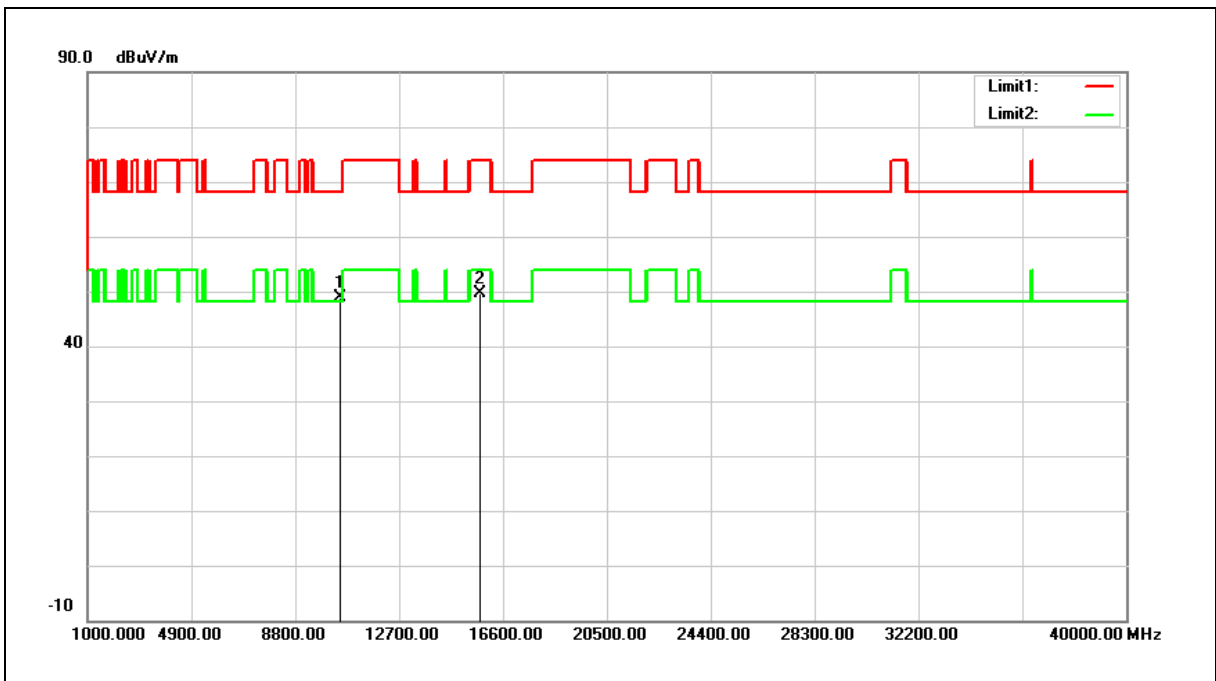

No.	Frequency (MHz)	Reading (dBuV)	Correct Factor (dB/m)	Result (dBuV/m)	Limit (dBuV/m)	Margin (dB)	Remark
1	10480.000	32.45	16.47	48.92	68.20	-19.28	peak
2	15720.000	31.87	17.88	49.75	74.00	-24.25	peak

Note:1.Result (dBuV/m) = Correct Factor (dB/m) + Reading(dBuV).

2.Correction factor (dB/m) = Antenna Factor (dB/m) + Cable loss (dB) – Pre-Amplifier gain (dB).

3.When the peak results are less than average limit, so not need to evaluate the average.



Standard:	FCC Part 15.407	Test Distance:	3 m
Test item:	Harmonic	Power:	AC 120 V/60 Hz
Frequency:	5240 MHz	Temp.(°C)/Hum.(%RH):	26(°C)/60 %RH
Mode:	Mode 3		
Ant.Polar.:	Vertical		

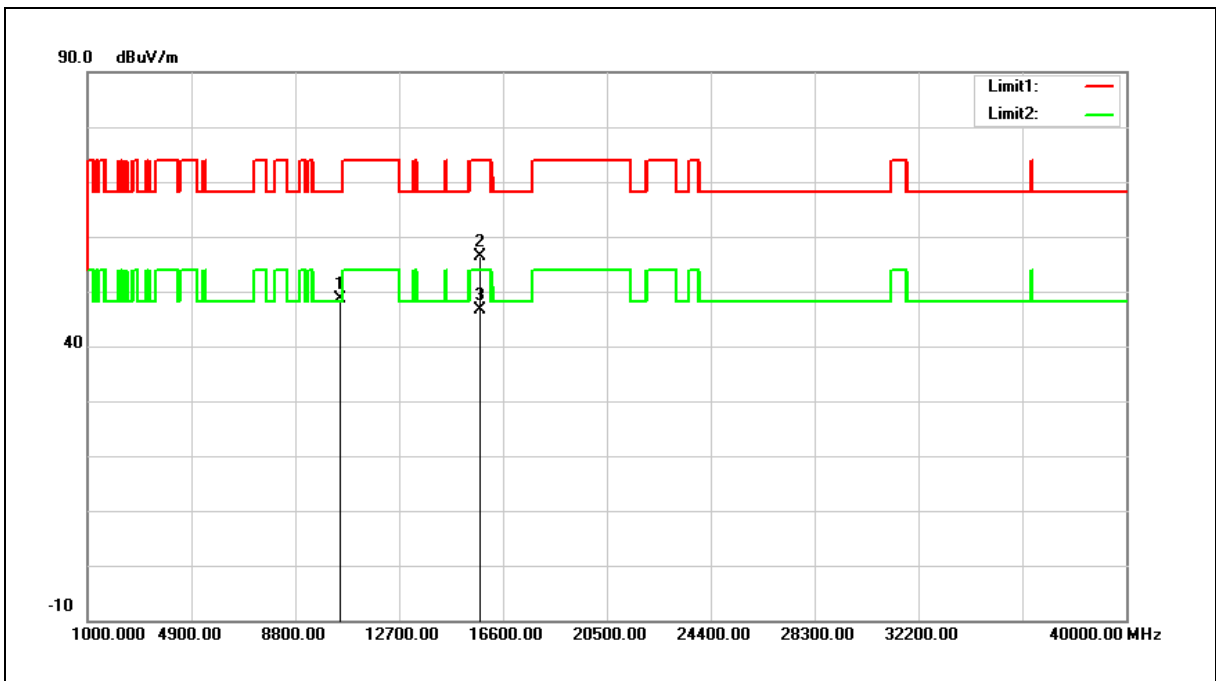

No.	Frequency (MHz)	Reading (dBuV)	Correct Factor (dB/m)	Result (dBuV/m)	Limit (dBuV/m)	Margin (dB)	Remark
1	10480.000	32.23	16.47	48.70	68.20	-19.50	peak
2	15720.000	38.39	17.88	56.27	74.00	-17.73	peak
3	15720.000	28.66	17.88	46.54	54.00	-7.46	AVG

Note:1.Result (dBuV/m) = Correct Factor (dB/m) + Reading(dBuV).

2.Correction factor (dB/m) = Antenna Factor (dB/m) + Cable loss (dB) – Pre-Amplifier gain (dB).

3.When the peak results are less than average limit, so not need to evaluate the average.



Standard:	FCC Part 15.407	Test Distance:	3 m
Test item:	Harmonic	Power:	AC 120 V/60 Hz
Frequency:	5745 MHz	Temp.(°C)/Hum.(%RH):	26(°C)/60 %RH
Mode:	Mode 3		
Ant.Polar.:	Horizontal		

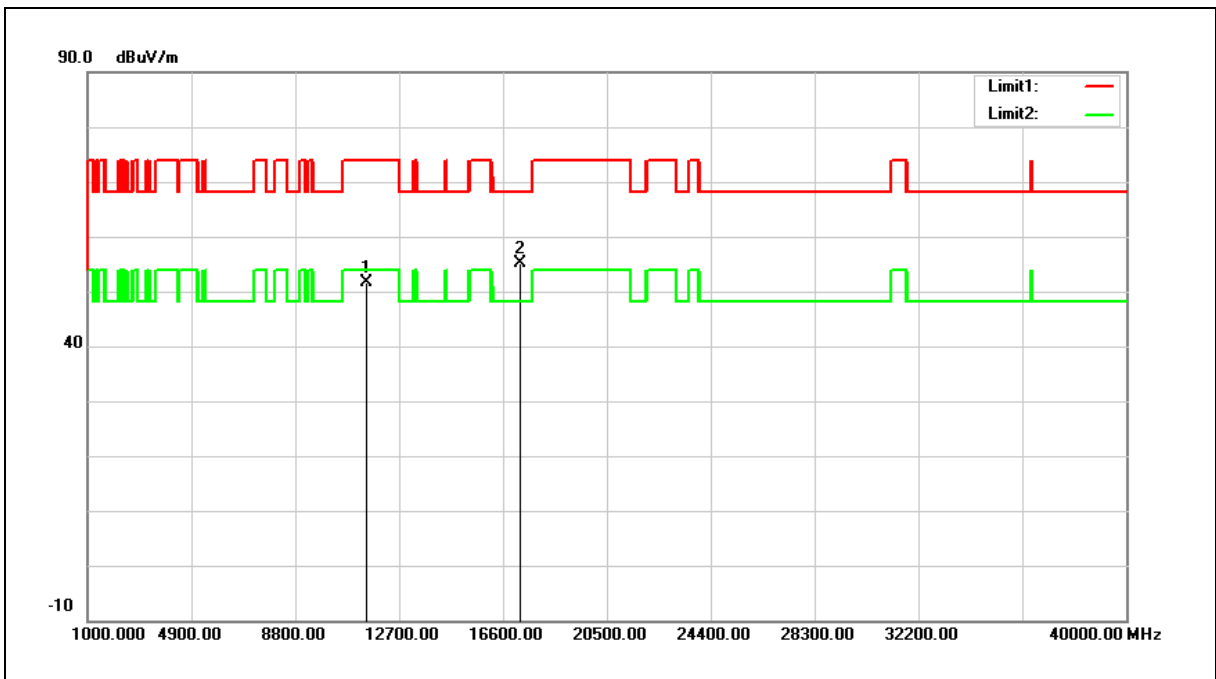

No.	Frequency (MHz)	Reading (dBuV)	Correct Factor (dB/m)	Result (dBuV/m)	Limit (dBuV/m)	Margin (dB)	Remark
1	11490.000	33.59	18.11	51.70	74.00	-22.30	peak
2	17235.000	32.25	22.86	55.11	68.20	-13.09	peak

- Note: 1.Result (dBuV/m) = Correct Factor (dB/m) + Reading(dBuV).  
 2.Correction factor (dB/m) = Antenna Factor (dB/m) + Cable loss (dB) – Pre-Amplifier gain (dB).  
 3.When the peak results are less than average limit, so not need to evaluate the average.



Standard:	FCC Part 15.407	Test Distance:	3 m
Test item:	Harmonic	Power:	AC 120 V/60 Hz
Frequency:	5745 MHz	Temp.(°C)/Hum.(%RH):	26(°C)/60 %RH
Mode:	Mode 3		
Ant.Polar.:	Vertical		

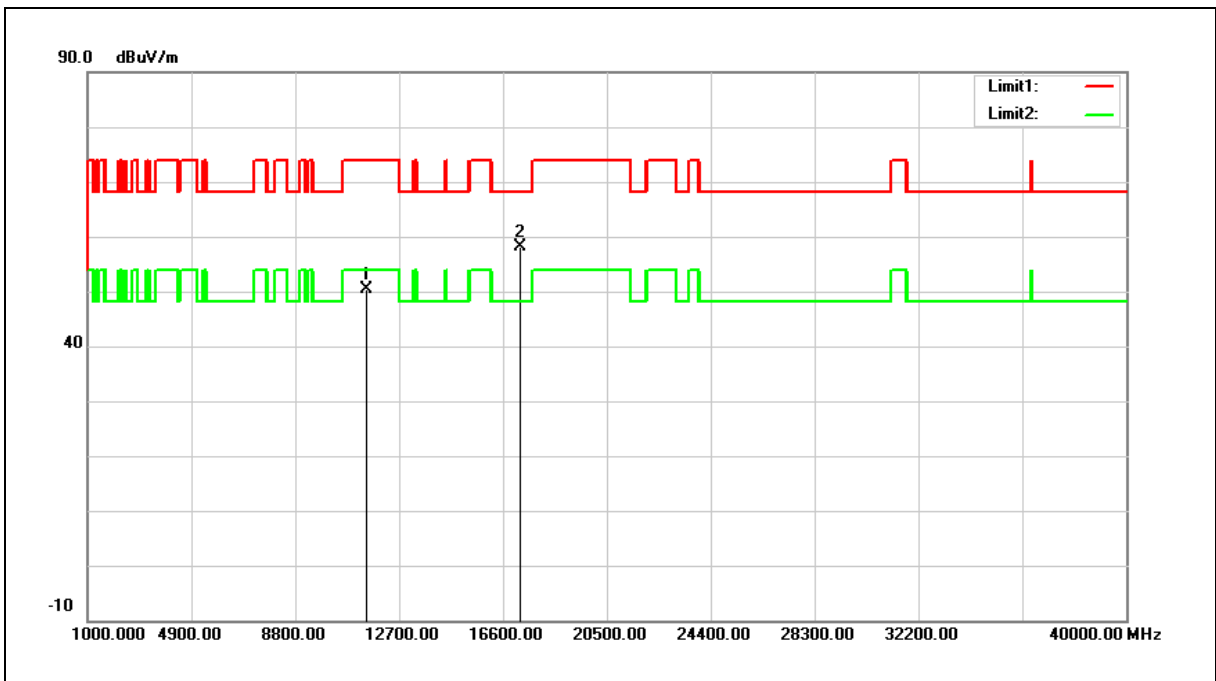

No.	Frequency (MHz)	Reading (dBuV)	Correct Factor (dB/m)	Result (dBuV/m)	Limit (dBuV/m)	Margin (dB)	Remark
1	11490.000	32.31	18.11	50.42	74.00	-23.58	peak
2	17235.000	35.15	22.86	58.01	68.20	-10.19	peak

- Note: 1.Result (dBuV/m) = Correct Factor (dB/m) + Reading(dBuV).  
 2.Correction factor (dB/m) = Antenna Factor (dB/m) + Cable loss (dB) – Pre-Amplifier gain (dB).  
 3.When the peak results are less than average limit, so not need to evaluate the average.



Standard:	FCC Part 15.407	Test Distance:	3 m
Test item:	Harmonic	Power:	AC 120 V/60 Hz
Frequency:	5785 MHz	Temp.(°C)/Hum.(%RH):	26(°C)/60 %RH
Mode:	Mode 3		
Ant.Polar.:	Horizontal		

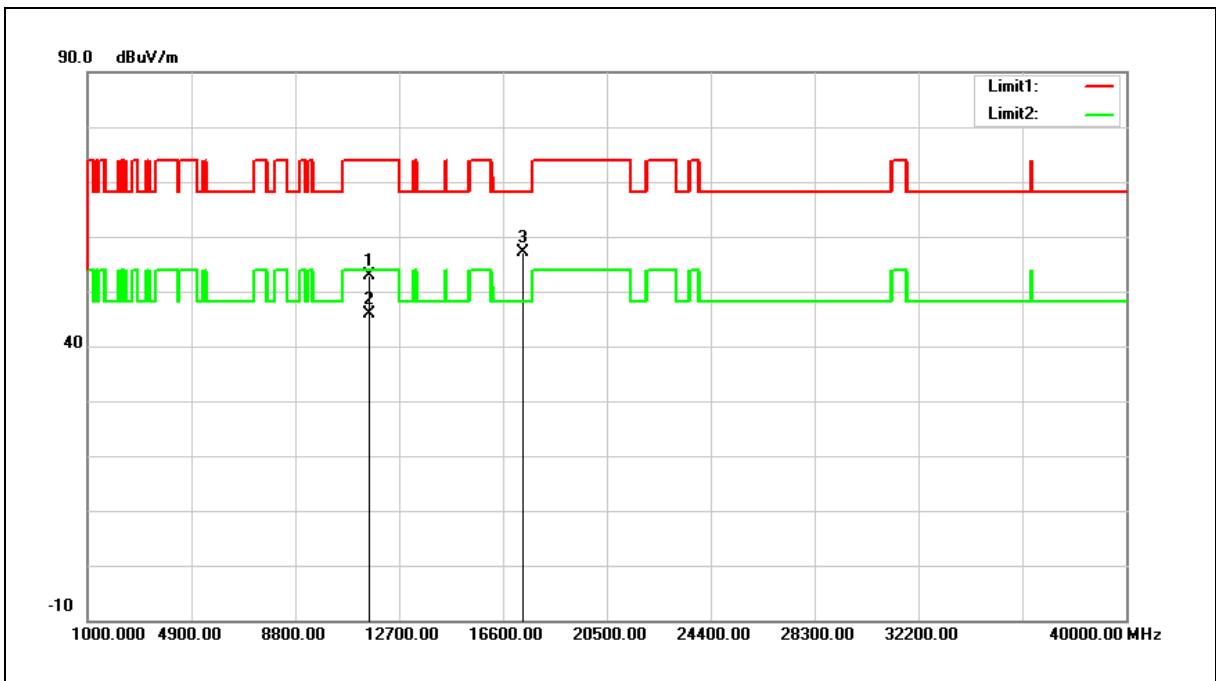

No.	Frequency (MHz)	Reading (dBuV)	Correct Factor (dB/m)	Result (dBuV/m)	Limit (dBuV/m)	Margin (dB)	Remark
1	11570.000	34.88	18.03	52.91	74.00	-21.09	peak
2	11570.000	27.85	18.03	45.88	54.00	-8.12	AVG
3	17355.000	33.70	23.45	57.15	68.20	-11.05	peak

- Note:1.Result (dBuV/m) = Correct Factor (dB/m) + Reading(dBuV).
- 2.Correction factor (dB/m) = Antenna Factor (dB/m) + Cable loss (dB) – Pre-Amplifier gain (dB).
- 3.When the peak results are less than average limit, so not need to evaluate the average.





Standard:	FCC Part 15.407	Test Distance:	3 m
Test item:	Harmonic	Power:	AC 120 V/60 Hz
Frequency:	5785 MHz	Temp.(°C)/Hum.(%RH):	26(°C)/60 %RH
Mode:	Mode 3		
Ant.Polar.:	Vertical		

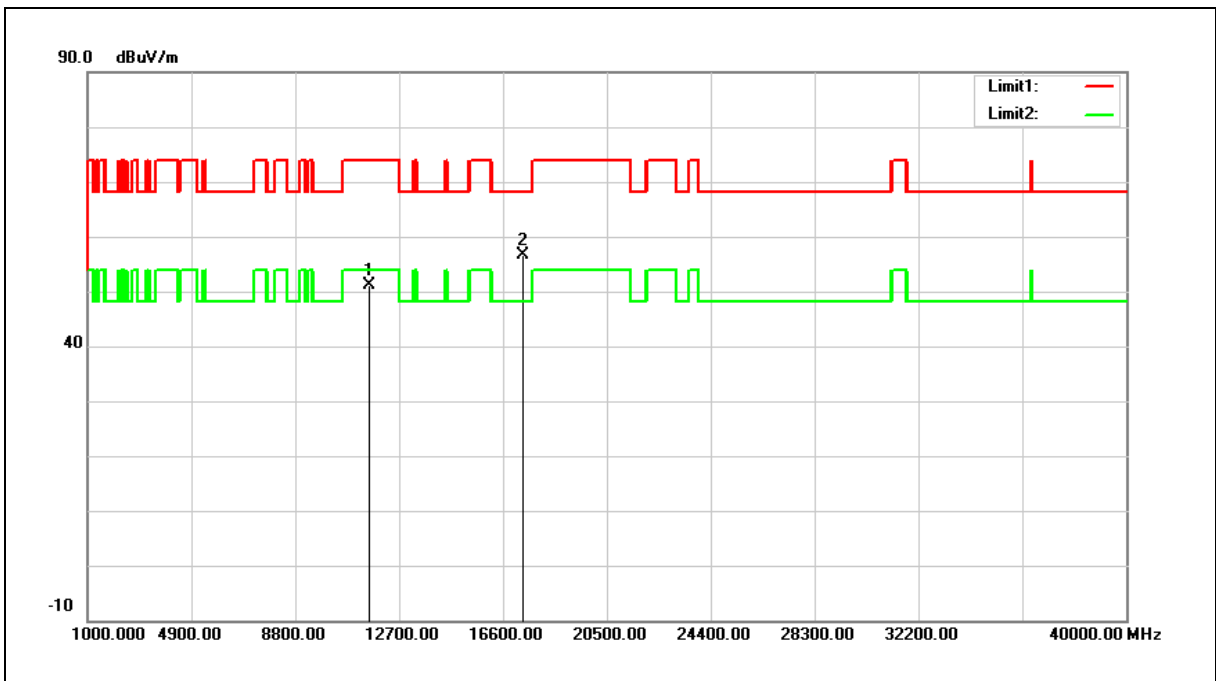

No.	Frequency (MHz)	Reading (dBuV)	Correct Factor (dB/m)	Result (dBuV/m)	Limit (dBuV/m)	Margin (dB)	Remark
1	11570.000	33.13	18.03	51.16	74.00	-22.84	peak
2	17355.000	33.23	23.45	56.68	68.20	-11.52	peak

Note: 1.Result (dBuV/m) = Correct Factor (dB/m) + Reading(dBuV).

2.Correction factor (dB/m) = Antenna Factor (dB/m) + Cable loss (dB) – Pre-Amplifier gain (dB).

3.When the peak results are less than average limit, so not need to evaluate the average.



Standard:	FCC Part 15.407	Test Distance:	3 m
Test item:	Harmonic	Power:	AC 120 V/60 Hz
Frequency:	5825 MHz	Temp.(°C)/Hum.(%RH):	26(°C)/60 %RH
Mode:	Mode 3		
Ant.Polar.:	Horizontal		

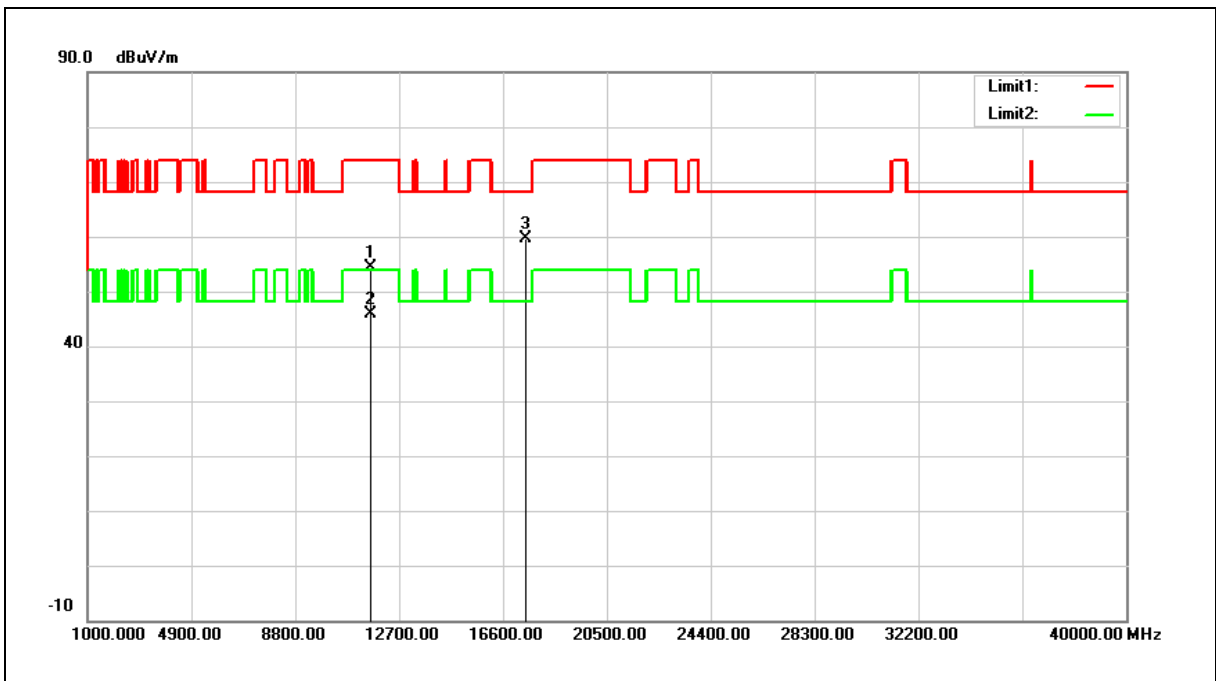

No.	Frequency (MHz)	Reading (dBuV)	Correct Factor (dB/m)	Result (dBuV/m)	Limit (dBuV/m)	Margin (dB)	Remark
1	11650.000	36.43	17.93	54.36	74.00	-19.64	peak
2	11650.000	27.84	17.93	45.77	54.00	-8.23	AVG
3	17475.000	35.59	24.04	59.63	68.20	-8.57	peak

Note:1.Result (dBuV/m) = Correct Factor (dB/m) + Reading(dBuV).

2.Correction factor (dB/m) = Antenna Factor (dB/m) + Cable loss (dB) – Pre-Amplifier gain (dB).

3.When the peak results are less than average limit, so not need to evaluate the average.



Standard:	FCC Part 15.407	Test Distance:	3 m
Test item:	Harmonic	Power:	AC 120 V/60 Hz
Frequency:	5825 MHz	Temp.(°C)/Hum.(%RH):	26(°C)/60 %RH
Mode:	Mode 3		
Ant.Polar.:	Vertical		

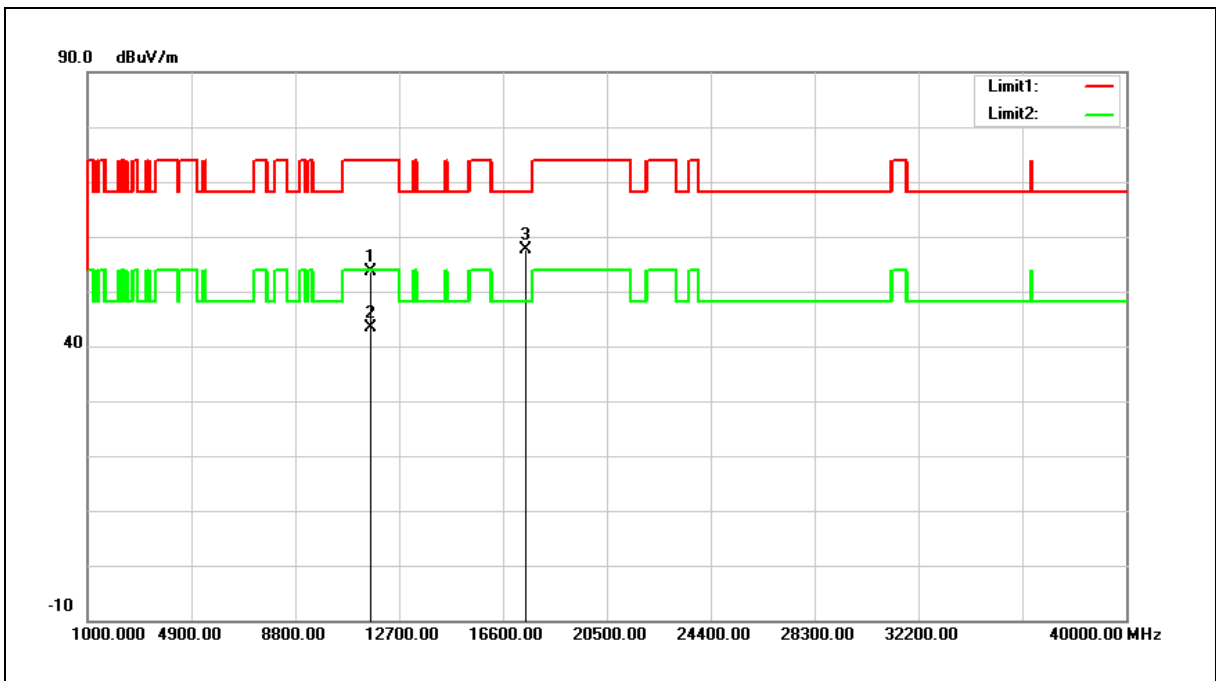

No.	Frequency (MHz)	Reading (dBuV)	Correct Factor (dB/m)	Result (dBuV/m)	Limit (dBuV/m)	Margin (dB)	Remark
1	11650.000	35.73	17.93	53.66	74.00	-20.34	peak
2	11650.000	25.56	17.93	43.49	54.00	-10.51	AVG
3	17475.000	33.51	24.04	57.55	68.20	-10.65	peak

Note:1.Result (dBuV/m) = Correct Factor (dB/m) + Reading(dBuV).

2.Correction factor (dB/m) = Antenna Factor (dB/m) + Cable loss (dB) – Pre-Amplifier gain (dB).

3.When the peak results are less than average limit, so not need to evaluate the average.



Standard:	FCC Part 15.407	Test Distance:	3 m
Test item:	Harmonic	Power:	AC 120 V/60 Hz
Frequency:	5190 MHz	Temp.(°C)/Hum.(%RH):	26(°C)/60 %RH
Mode:	Mode 4		
Ant.Polar.:	Horizontal		

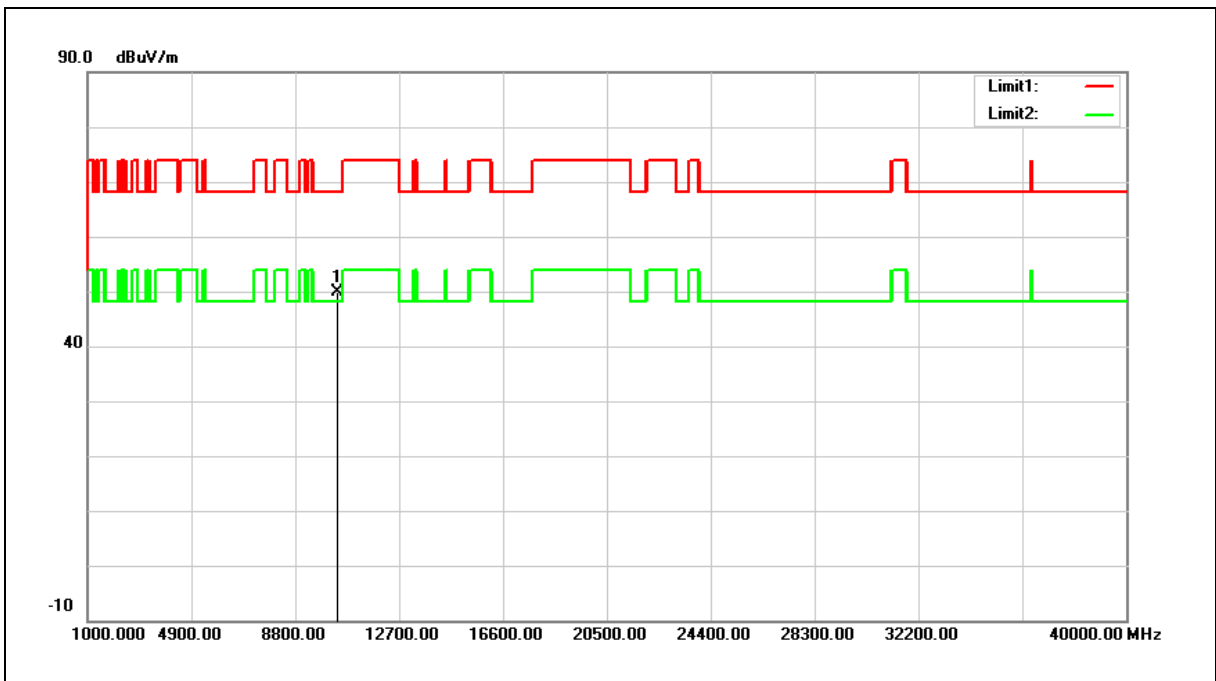

No.	Frequency (MHz)	Reading (dBuV)	Correct Factor (dB/m)	Result (dBuV/m)	Limit (dBuV/m)	Margin (dB)	Remark
1	10380.000	33.79	16.05	49.84	68.20	-18.36	peak

- Note:1.Result (dBuV/m) = Correct Factor (dB/m) + Reading(dBuV).  
 2.Correction factor (dB/m) = Antenna Factor (dB/m) + Cable loss (dB) – Pre-Amplifier gain (dB).  
 3.When the peak results are less than average limit, so not need to evaluate the average.



Standard:	FCC Part 15.407	Test Distance:	3 m
Test item:	Harmonic	Power:	AC 120 V/60 Hz
Frequency:	5190 MHz	Temp.(°C)/Hum.(%RH):	26(°C)/60 %RH
Mode:	Mode 4		
Ant.Polar.:	Vertical		

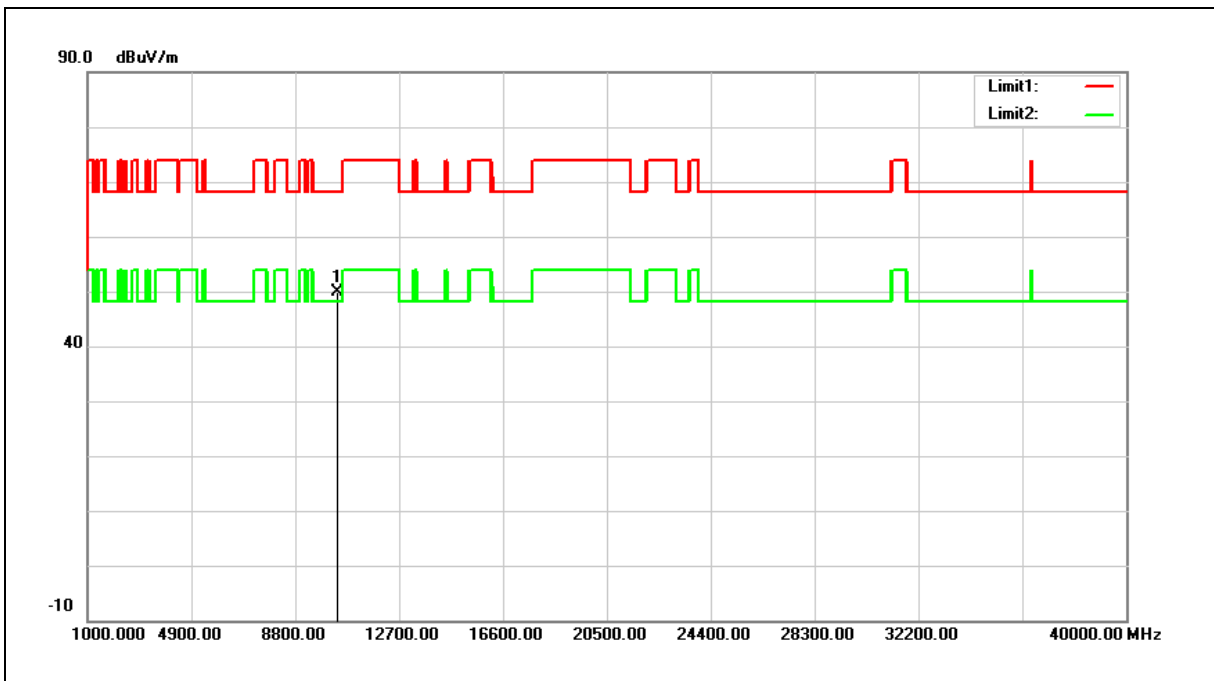

No.	Frequency (MHz)	Reading (dBuV)	Correct Factor (dB/m)	Result (dBuV/m)	Limit (dBuV/m)	Margin (dB)	Remark
1	10380.000	33.94	16.05	49.99	68.20	-18.21	peak

Note:1.Result (dBuV/m) = Correct Factor (dB/m) + Reading(dBuV).

2.Correction factor (dB/m) = Antenna Factor (dB/m) + Cable loss (dB) – Pre-Amplifier gain (dB).

3.When the peak results are less than average limit, so not need to evaluate the average.



Standard:	FCC Part 15.407	Test Distance:	3 m
Test item:	Harmonic	Power:	AC 120 V/60 Hz
Frequency:	5230 MHz	Temp.(°C)/Hum.(%RH):	26(°C)/60 %RH
Mode:	Mode 4		
Ant.Polar.:	Horizontal		

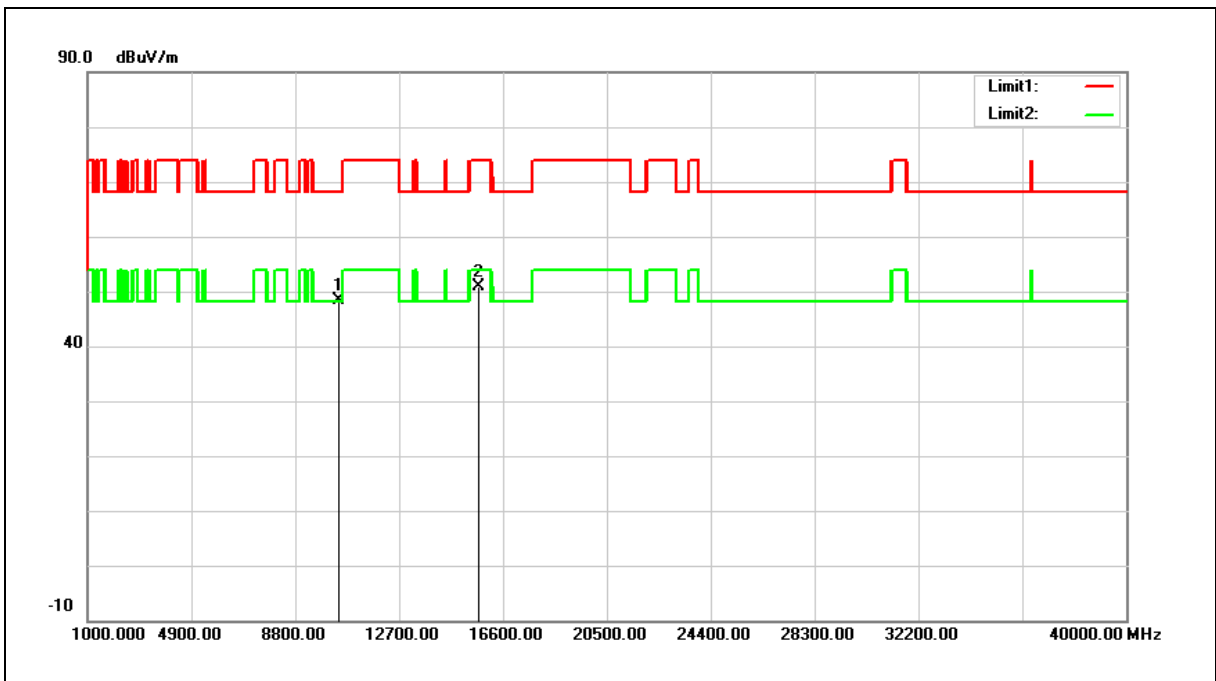

No.	Frequency (MHz)	Reading (dBuV)	Correct Factor (dB/m)	Result (dBuV/m)	Limit (dBuV/m)	Margin (dB)	Remark
1	10460.000	32.00	16.41	48.41	68.20	-19.79	peak
2	15690.000	32.88	17.96	50.84	74.00	-23.16	peak

- Note: 1.Result (dBuV/m) = Correct Factor (dB/m) + Reading(dBuV).  
 2.Correction factor (dB/m) = Antenna Factor (dB/m) + Cable loss (dB) – Pre-Amplifier gain (dB).  
 3.When the peak results are less than average limit, so not need to evaluate the average.



Standard:	FCC Part 15.407	Test Distance:	3 m
Test item:	Harmonic	Power:	AC 120 V/60 Hz
Frequency:	5230 MHz	Temp.(°C)/Hum.(%RH):	26(°C)/60 %RH
Mode:	Mode 4		
Ant.Polar.:	Vertical		

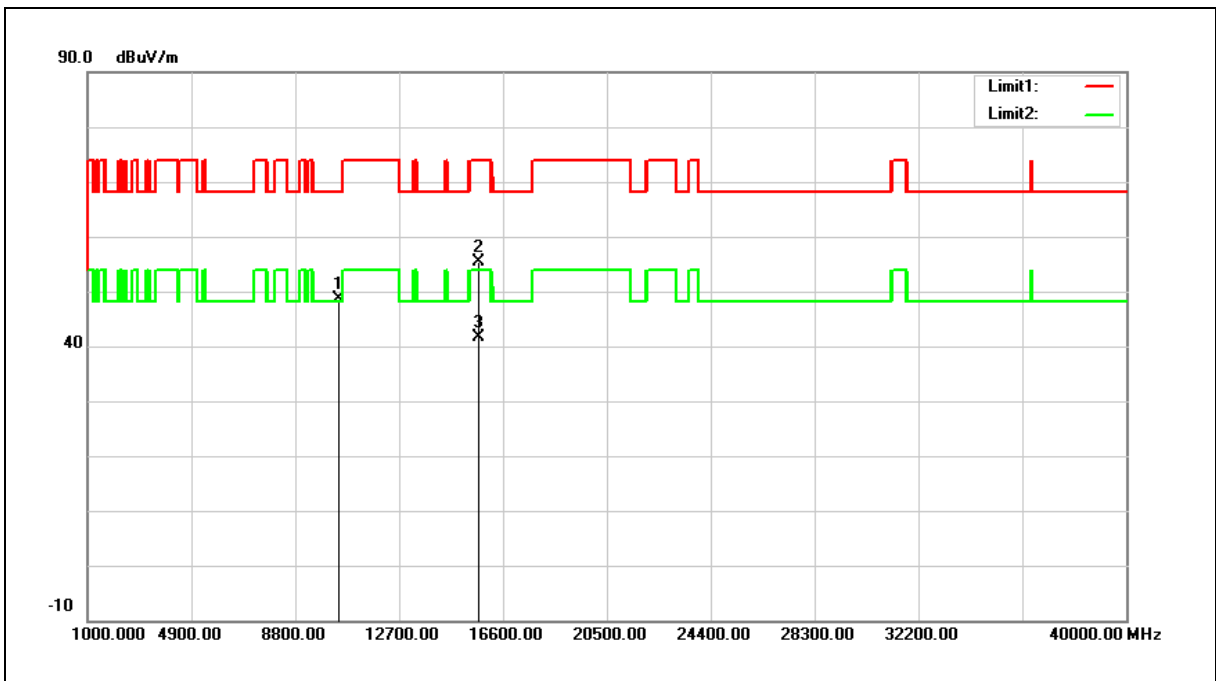

No.	Frequency (MHz)	Reading (dBuV)	Correct Factor (dB/m)	Result (dBuV/m)	Limit (dBuV/m)	Margin (dB)	Remark
1	10460.000	32.24	16.41	48.65	68.20	-19.55	peak
2	15690.000	37.39	17.96	55.35	74.00	-18.65	peak
3	15690.000	23.56	17.96	41.52	54.00	-12.48	AVG

Note:1.Result (dBuV/m) = Correct Factor (dB/m) + Reading(dBuV).

2.Correction factor (dB/m) = Antenna Factor (dB/m) + Cable loss (dB) – Pre-Amplifier gain (dB).

3.When the peak results are less than average limit, so not need to evaluate the average.



Standard:	FCC Part 15.407	Test Distance:	3 m
Test item:	Harmonic	Power:	AC 120 V/60 Hz
Frequency:	5755 MHz	Temp.(°C)/Hum.(%RH):	26(°C)/60 %RH
Mode:	Mode 4		
Ant.Polar.:	Horizontal		

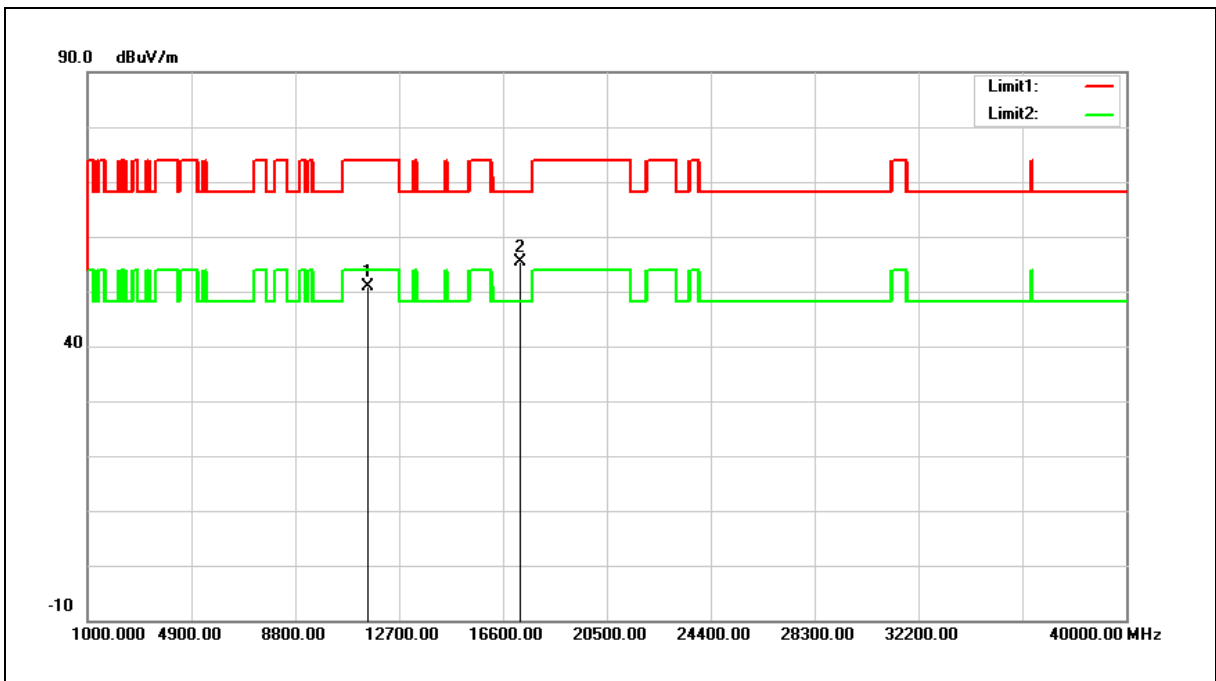

No.	Frequency (MHz)	Reading (dBuV)	Correct Factor (dB/m)	Result (dBuV/m)	Limit (dBuV/m)	Margin (dB)	Remark
1	11510.000	32.74	18.11	50.85	74.00	-23.15	peak
2	17265.000	32.37	23.00	55.37	68.20	-12.83	peak

Note: 1. Result (dBuV/m) = Correct Factor (dB/m) + Reading(dBuV).

2. Correction factor (dB/m) = Antenna Factor (dB/m) + Cable loss (dB) – Pre-Amplifier gain (dB).

3. When the peak results are less than average limit, so not need to evaluate the average.





Standard:	FCC Part 15.407	Test Distance:	3 m
Test item:	Harmonic	Power:	AC 120 V/60 Hz
Frequency:	5755 MHz	Temp.(°C)/Hum.(%RH):	26(°C)/60 %RH
Mode:	Mode 4		
Ant.Polar.:	Vertical		

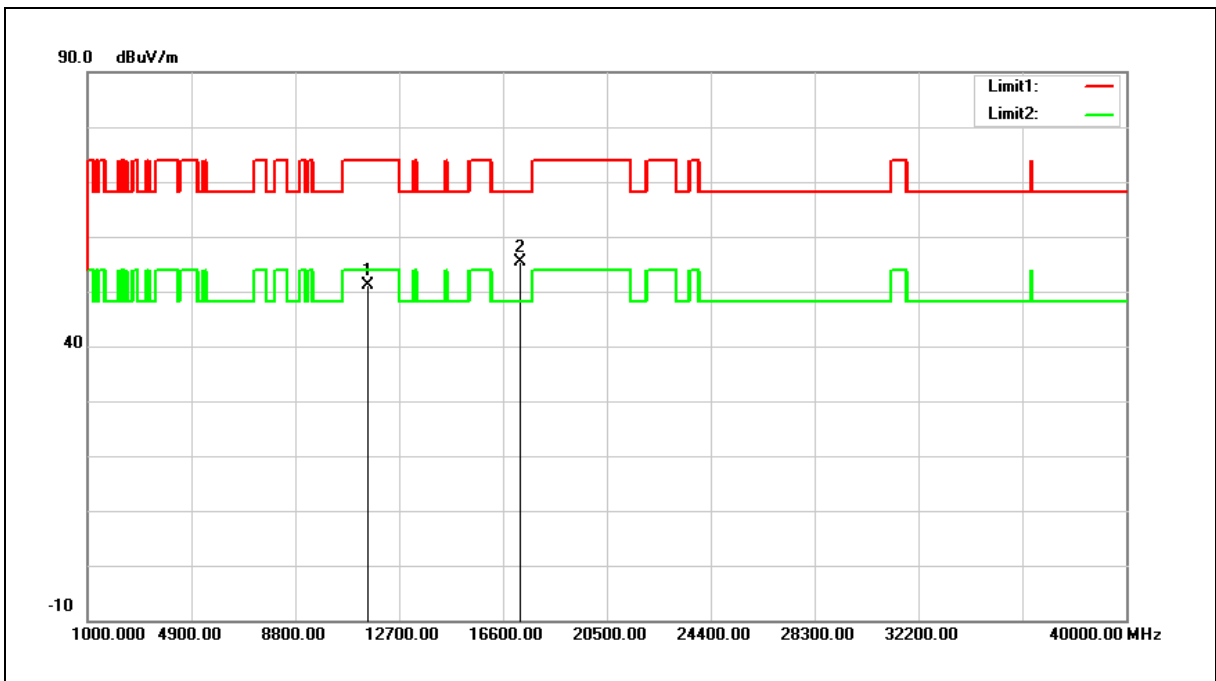

No.	Frequency (MHz)	Reading (dBuV)	Correct Factor (dB/m)	Result (dBuV/m)	Limit (dBuV/m)	Margin (dB)	Remark
1	11510.000	32.93	18.11	51.04	74.00	-22.96	peak
2	17265.000	32.41	23.00	55.41	68.20	-12.79	peak

Note: 1. Result (dBuV/m) = Correct Factor (dB/m) + Reading(dBuV).

2. Correction factor (dB/m) = Antenna Factor (dB/m) + Cable loss (dB) – Pre-Amplifier gain (dB).

3. When the peak results are less than average limit, so not need to evaluate the average.



Standard:	FCC Part 15.407	Test Distance:	3 m
Test item:	Harmonic	Power:	AC 120 V/60 Hz
Frequency:	5795 MHz	Temp.(°C)/Hum.(%RH):	26(°C)/60 %RH
Mode:	Mode 4		
Ant.Polar.:	Horizontal		

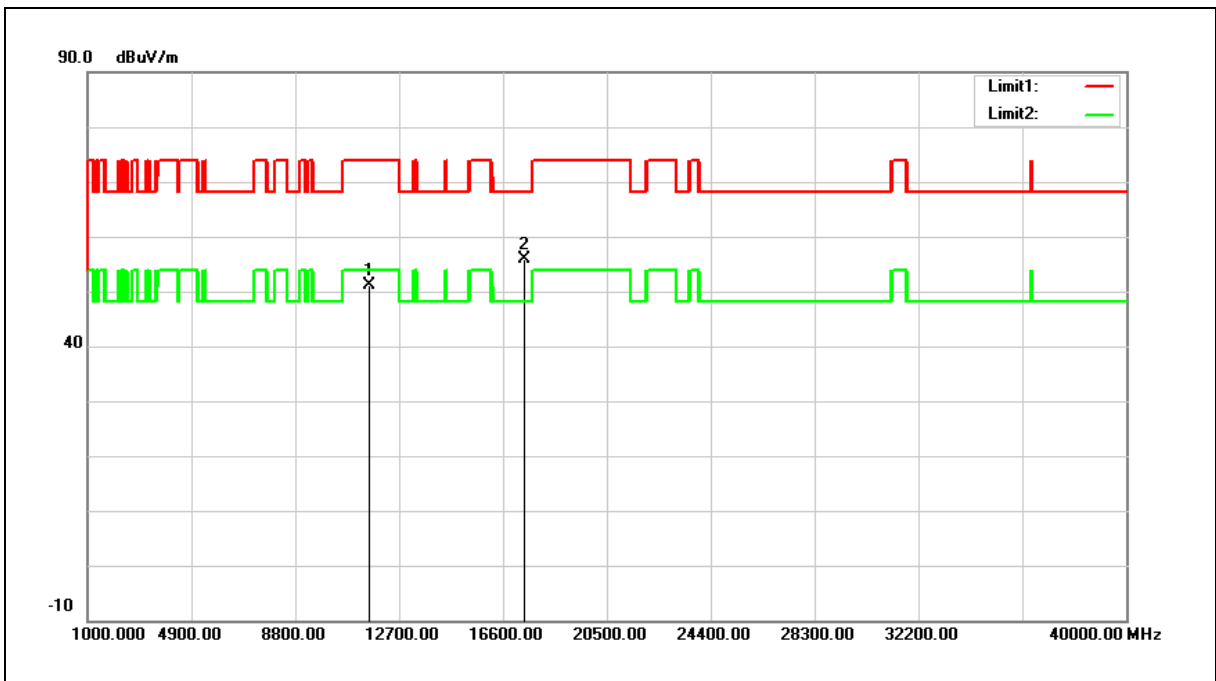

No.	Frequency (MHz)	Reading (dBuV)	Correct Factor (dB/m)	Result (dBuV/m)	Limit (dBuV/m)	Margin (dB)	Remark
1	11590.000	33.21	18.00	51.21	74.00	-22.79	peak
2	17385.000	32.25	23.60	55.85	68.20	-12.35	peak

Note: 1.Result (dBuV/m) = Correct Factor (dB/m) + Reading(dBuV).

2.Correction factor (dB/m) = Antenna Factor (dB/m) + Cable loss (dB) – Pre-Amplifier gain (dB).

3.When the peak results are less than average limit, so not need to evaluate the average.



Standard:	FCC Part 15.407	Test Distance:	3 m
Test item:	Harmonic	Power:	AC 120 V/60 Hz
Frequency:	5795 MHz	Temp.(°C)/Hum.(%RH):	26(°C)/60 %RH
Mode:	Mode 4		
Ant.Polar.:	Vertical		

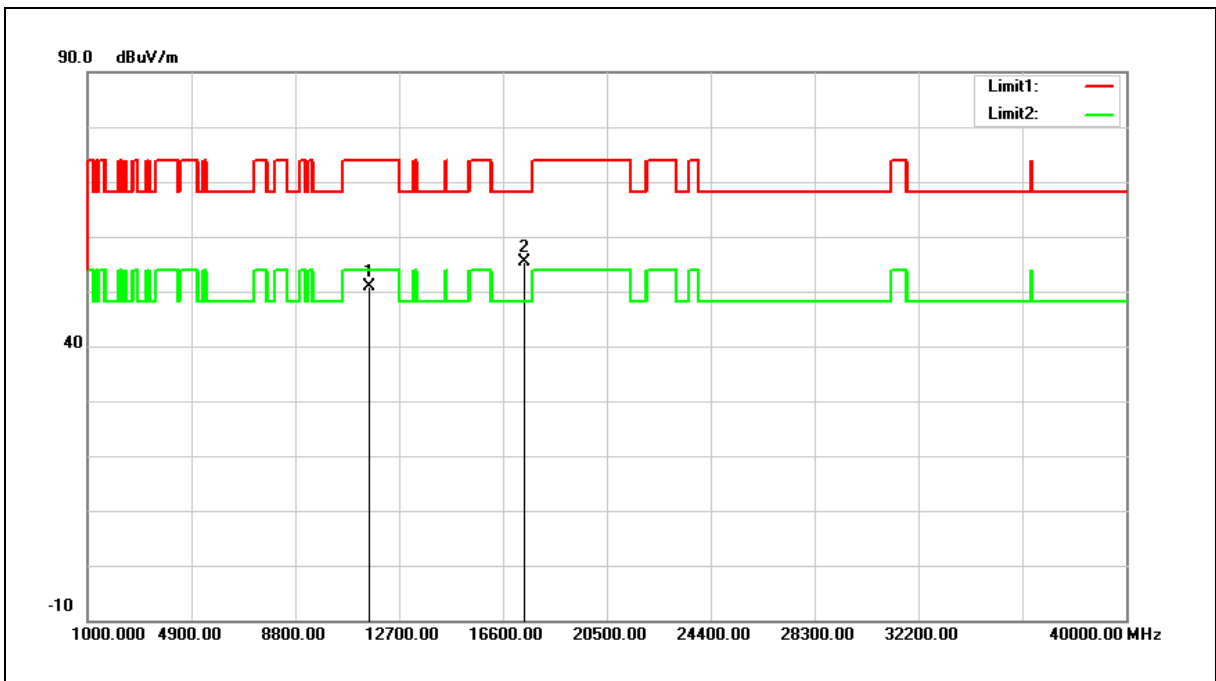

No.	Frequency (MHz)	Reading (dBuV)	Correct Factor (dB/m)	Result (dBuV/m)	Limit (dBuV/m)	Margin (dB)	Remark
1	11590.000	32.87	18.00	50.87	74.00	-23.13	peak
2	17385.000	31.75	23.60	55.35	68.20	-12.85	peak

Note: 1.Result (dBuV/m) = Correct Factor (dB/m) + Reading(dBuV).

2.Correction factor (dB/m) = Antenna Factor (dB/m) + Cable loss (dB) – Pre-Amplifier gain (dB).

3.When the peak results are less than average limit, so not need to evaluate the average.



Standard:	FCC Part 15.407	Test Distance:	3 m
Test item:	Harmonic	Power:	AC 120 V/60 Hz
Frequency:	5210 MHz	Temp.(°C)/Hum.(%RH):	26(°C)/60 %RH
Mode:	Mode 5		
Ant.Polar.:	Horizontal		

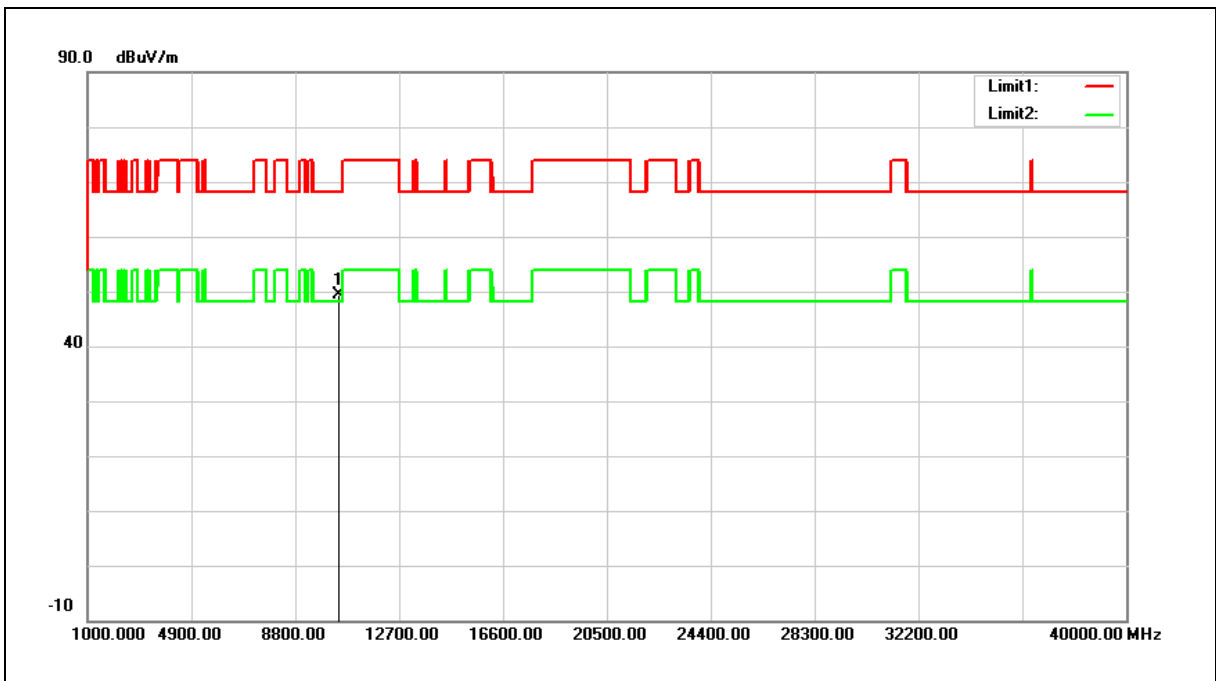

No.	Frequency (MHz)	Reading (dBuV)	Correct Factor (dB/m)	Result (dBuV/m)	Limit (dBuV/m)	Margin (dB)	Remark
1	10420.000	33.09	16.28	49.37	68.20	-18.83	peak

- Note: 1.Result (dBuV/m) = Correct Factor (dB/m) + Reading(dBuV).  
 2.Correction factor (dB/m) = Antenna Factor (dB/m) + Cable loss (dB) – Pre-Amplifier gain (dB).  
 3.When the peak results are less than average limit, so not need to evaluate the average.



Standard:	FCC Part 15.407	Test Distance:	3 m
Test item:	Harmonic	Power:	AC 120 V/60 Hz
Frequency:	5210 MHz	Temp.(°C)/Hum.(%RH):	26(°C)/60 %RH
Mode:	Mode 5		
Ant.Polar.:	Vertical		

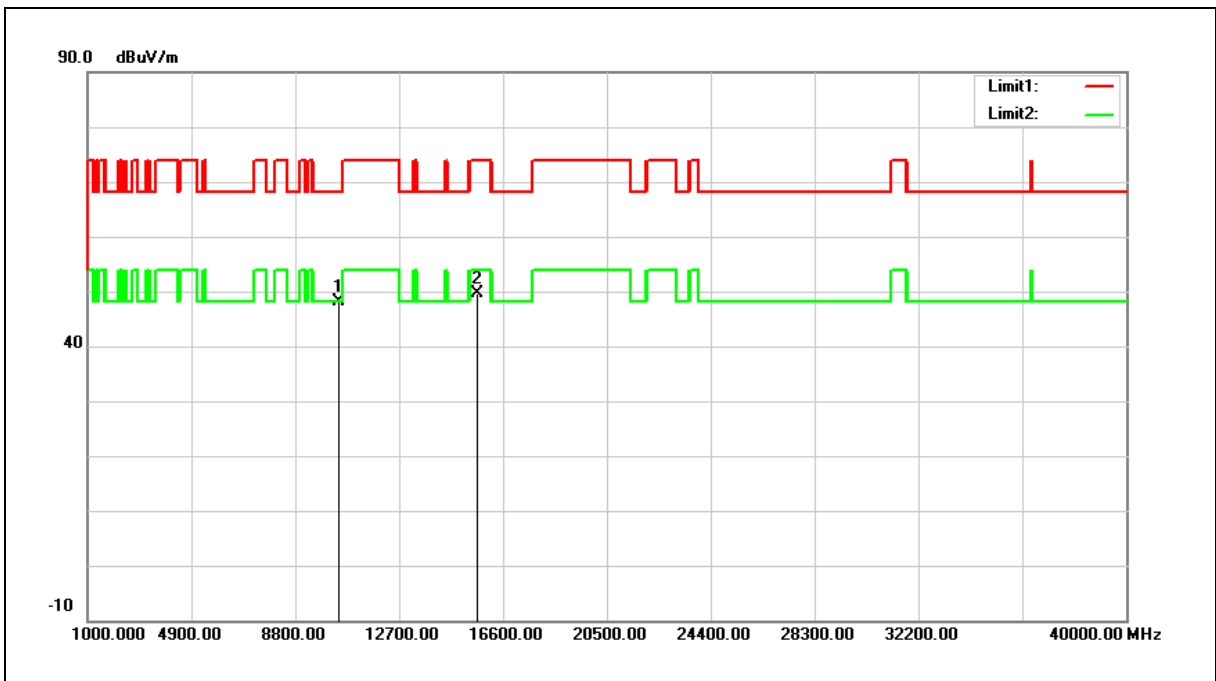

No.	Frequency (MHz)	Reading (dBuV)	Correct Factor (dB/m)	Result (dBuV/m)	Limit (dBuV/m)	Margin (dB)	Remark
1	10420.000	31.78	16.28	48.06	68.20	-20.14	peak
2	15630.000	31.47	18.11	49.58	74.00	-24.42	peak

Note: 1.Result (dBuV/m) = Correct Factor (dB/m) + Reading(dBuV).

2.Correction factor (dB/m) = Antenna Factor (dB/m) + Cable loss (dB) – Pre-Amplifier gain (dB).

3.When the peak results are less than average limit, so not need to evaluate the average.



Standard:	FCC Part 15.407	Test Distance:	3 m
Test item:	Harmonic	Power:	AC 120 V/60 Hz
Frequency:	5775 MHz	Temp.(°C)/Hum.(%RH):	26(°C)/60 %RH
Mode:	Mode 5		
Ant.Polar.:	Horizontal		

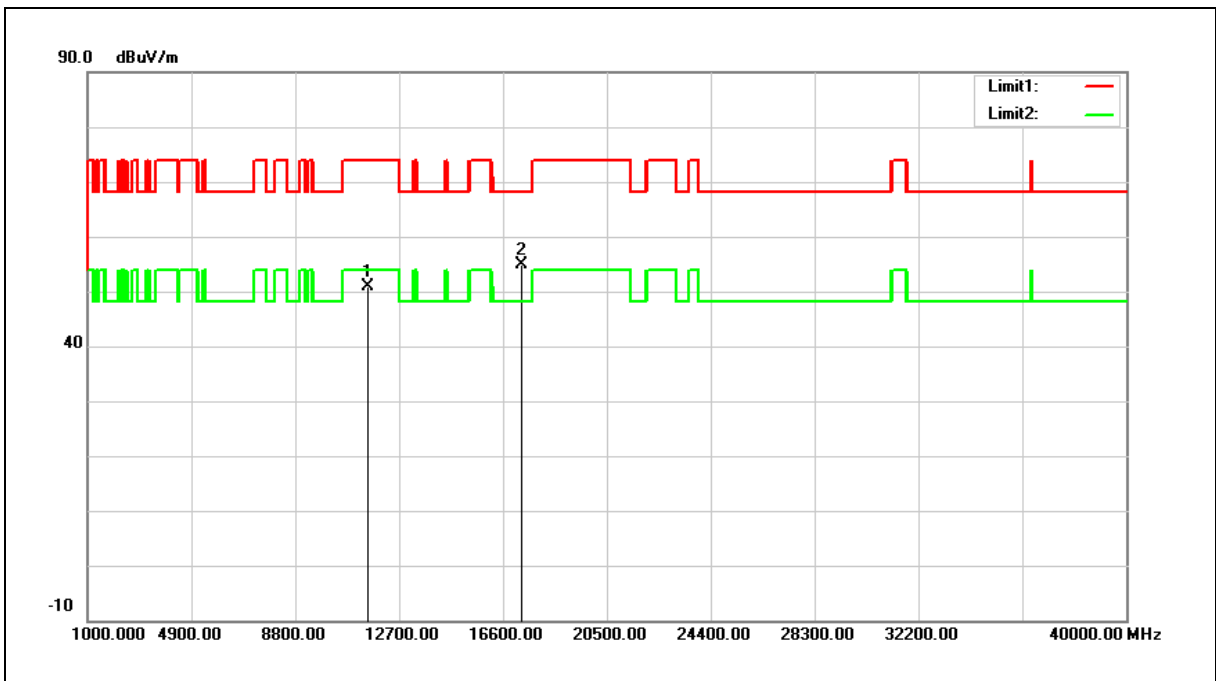

No.	Frequency (MHz)	Reading (dBuV)	Correct Factor (dB/m)	Result (dBuV/m)	Limit (dBuV/m)	Margin (dB)	Remark
1	11550.000	32.77	18.06	50.83	74.00	-23.17	peak
2	17325.000	31.62	23.30	54.92	68.20	-13.28	peak

- Note: 1.Result (dBuV/m) = Correct Factor (dB/m) + Reading(dBuV).  
 2.Correction factor (dB/m) = Antenna Factor (dB/m) + Cable loss (dB) – Pre-Amplifier gain (dB).  
 3.When the peak results are less than average limit, so not need to evaluate the average.



Standard:	FCC Part 15.407	Test Distance:	3 m
Test item:	Harmonic	Power:	AC 120 V/60 Hz
Frequency:	5775 MHz	Temp.(°C)/Hum.(%RH):	26(°C)/60 %RH
Mode:	Mode 5		
Ant.Polar.:	Vertical		

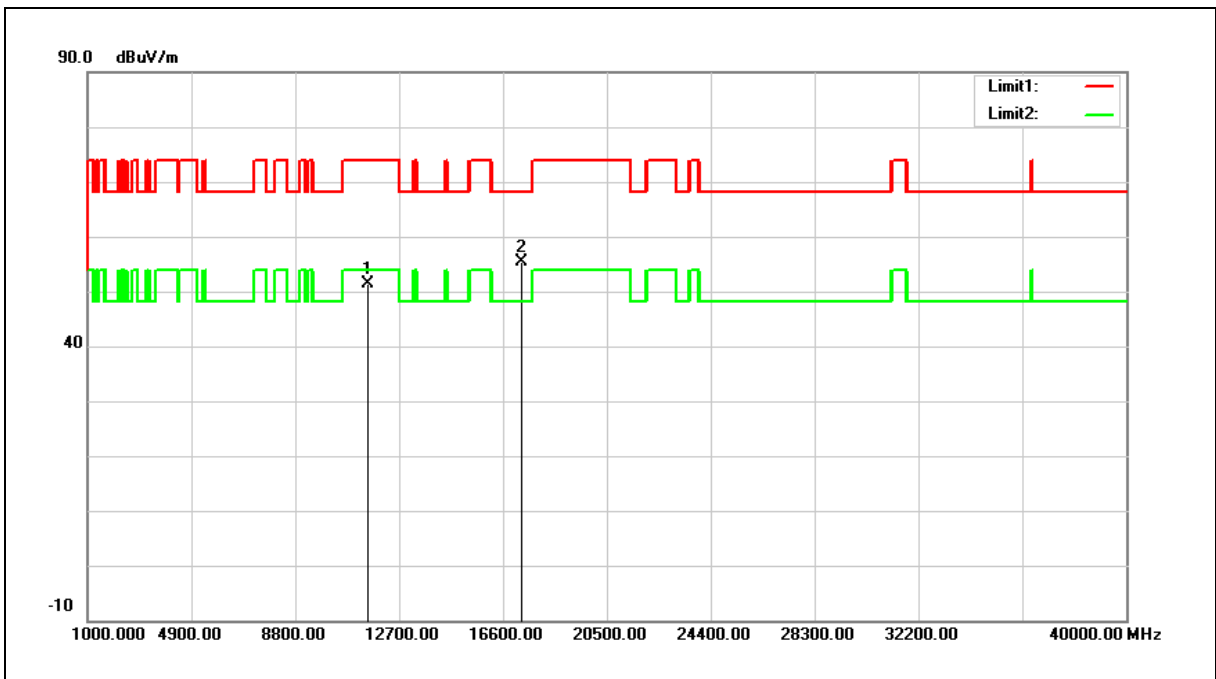

No.	Frequency (MHz)	Reading (dBuV)	Correct Factor (dB/m)	Result (dBuV/m)	Limit (dBuV/m)	Margin (dB)	Remark
1	11550.000	33.26	18.06	51.32	74.00	-22.68	peak
2	17325.000	32.16	23.30	55.46	68.20	-12.74	peak

- Note: 1.Result (dBuV/m) = Correct Factor (dB/m) + Reading(dBuV).  
 2.Correction factor (dB/m) = Antenna Factor (dB/m) + Cable loss (dB) – Pre-Amplifier gain (dB).  
 3.When the peak results are less than average limit, so not need to evaluate the average.



Standard:	FCC Part 15.407	Test Distance:	3 m
Test item:	Transmitter Unwanted Emissions	Power:	AC 120 V/60 Hz
Test Mode:	Simultaneous Transmitting (DTS+NII)	Temp.(°C)/Hum.(%RH):	26(°C)/60 %RH
Ant.Polar.:	Horizontal		

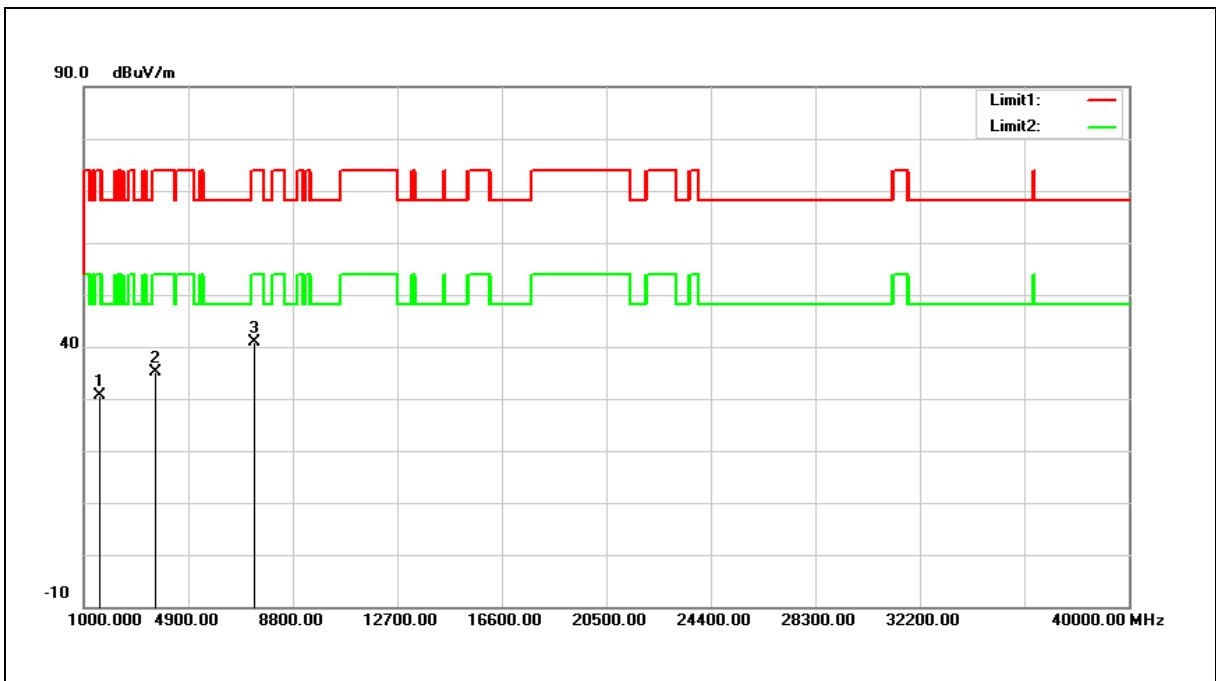

No.	Frequency (MHz)	Reading (dBuV)	Correct Factor (dB/m)	Result (dBuV/m)	Limit (dBuV/m)	Margin (dB)	Remark
1	1561.000	36.07	-5.35	30.72	74.00	-43.28	peak
2	3703.000	33.33	1.70	35.03	74.00	-38.97	peak
3	7341.000	29.23	11.54	40.77	74.00	-33.23	peak

Note:1.Result (dBuV/m) = Correct Factor (dB/m) + Reading(dBuV).

2.Correction factor (dB/m) = Antenna Factor (dB/m) + Cable loss (dB) – Pre-Amplifier gain (dB).

3. When the peak results are less than average limit, so not need to evaluate the average.





Standard:	FCC Part 15.407	Test Distance:	3 m
Test item:	Transmitter Unwanted Emissions	Power:	AC 120 V/60 Hz
Test Mode:	Simultaneous Transmitting (DTS+NII)	Temp.(°C)/Hum.(%RH):	26(°C)/60 %RH
Ant.Polar.:	Vertical		

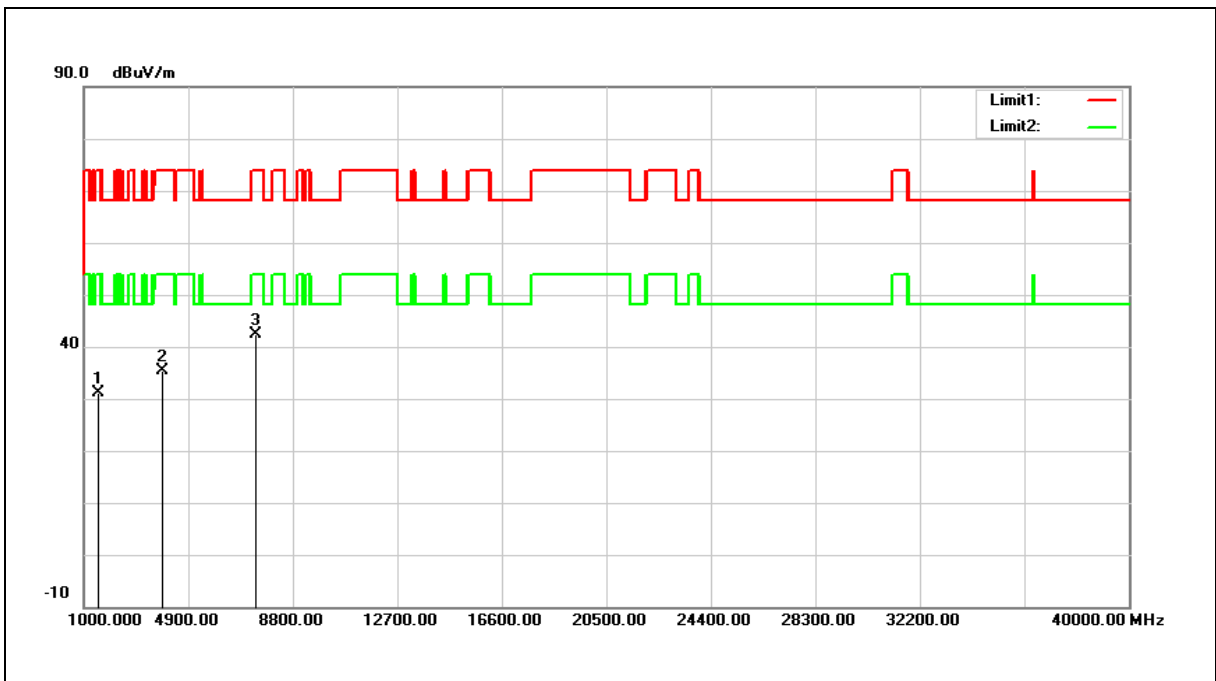

No.	Frequency (MHz)	Reading (dBuV)	Correct Factor (dB/m)	Result (dBuV/m)	Limit (dBuV/m)	Margin (dB)	Remark
1	1527.000	36.74	-5.51	31.23	74.00	-42.77	peak
2	3958.000	32.82	2.47	35.29	74.00	-38.71	peak
3	7409.000	30.68	11.71	42.39	74.00	-31.61	peak

Note:1.Result (dBuV/m) = Correct Factor (dB/m) + Reading(dBuV).

2.Correction factor (dB/m) = Antenna Factor (dB/m) + Cable loss (dB) – Pre-Amplifier gain (dB).

3. When the peak results are less than average limit, so not need to evaluate the average.



**Band Edge**

Standard:	FCC Part 15.407	Test Distance:	3 m
Test item:	Band edge	Power:	AC 120 V/60 Hz
Frequency:	5180 MHz	Temp.(°C)/Hum.(%RH):	26(°C)/60 %RH
Mode:	Mode 2		
Ant.Polar.:	Horizontal		

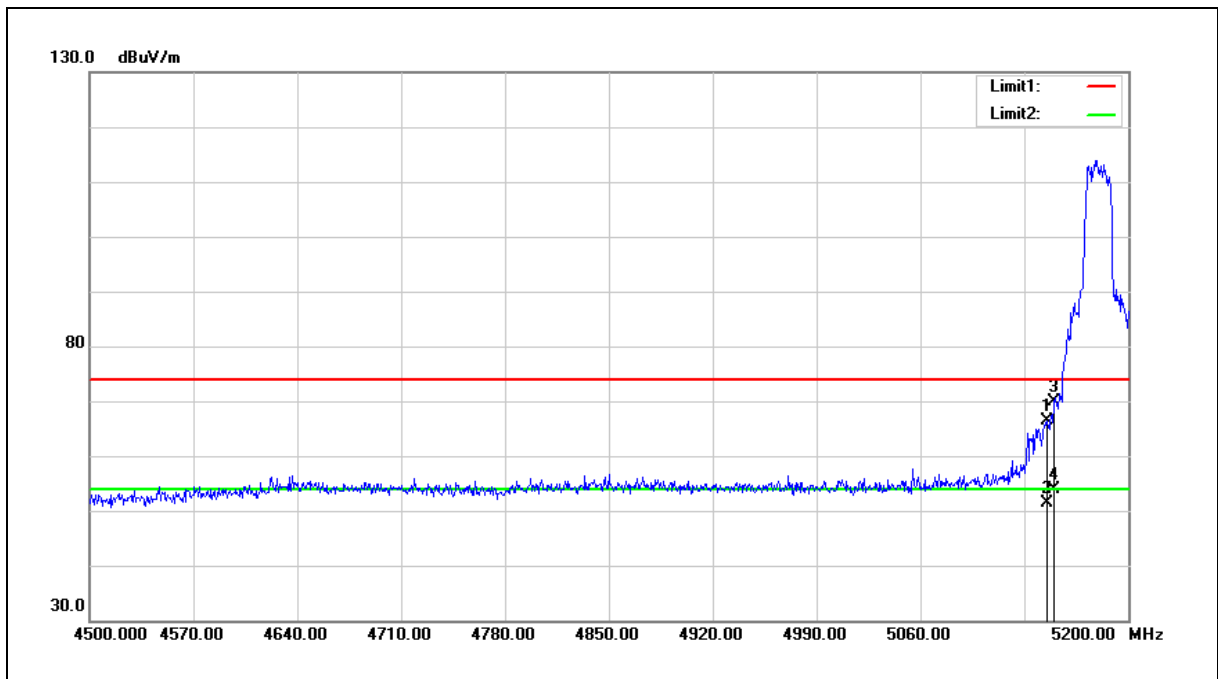

No.	Frequency (MHz)	Reading (dBuV)	Correct Factor (dB/m)	Result (dBuV/m)	Limit (dBuV/m)	Margin (dB)	Remark
1	5145.400	60.61	5.77	66.38	74.00	-7.62	peak
2	5145.400	45.69	5.77	51.46	54.00	-2.54	AVG
3	5150.000	63.99	5.78	69.77	74.00	-4.23	peak
4	5150.000	47.98	5.78	53.76	54.00	-0.24	AVG

- Note:1.Result (dBuV/m) = Correct Factor (dB/m) + Reading(dBuV).
- 2.Correction factor (dB/m) = Antenna Factor (dB/m) + Cable loss (dB) – Pre-Amplifier gain (dB).
- 3.When the peak results are less than average limit, so not need to evaluate the average.



Standard:	FCC Part 15.407	Test Distance:	3 m
Test item:	Band edge	Power:	AC 120 V/60 Hz
Frequency:	5180 MHz	Temp.(°C)/Hum.(%RH):	26(°C)/60 %RH
Mode:	Mode 2		
Ant.Polar.:	Vertical		

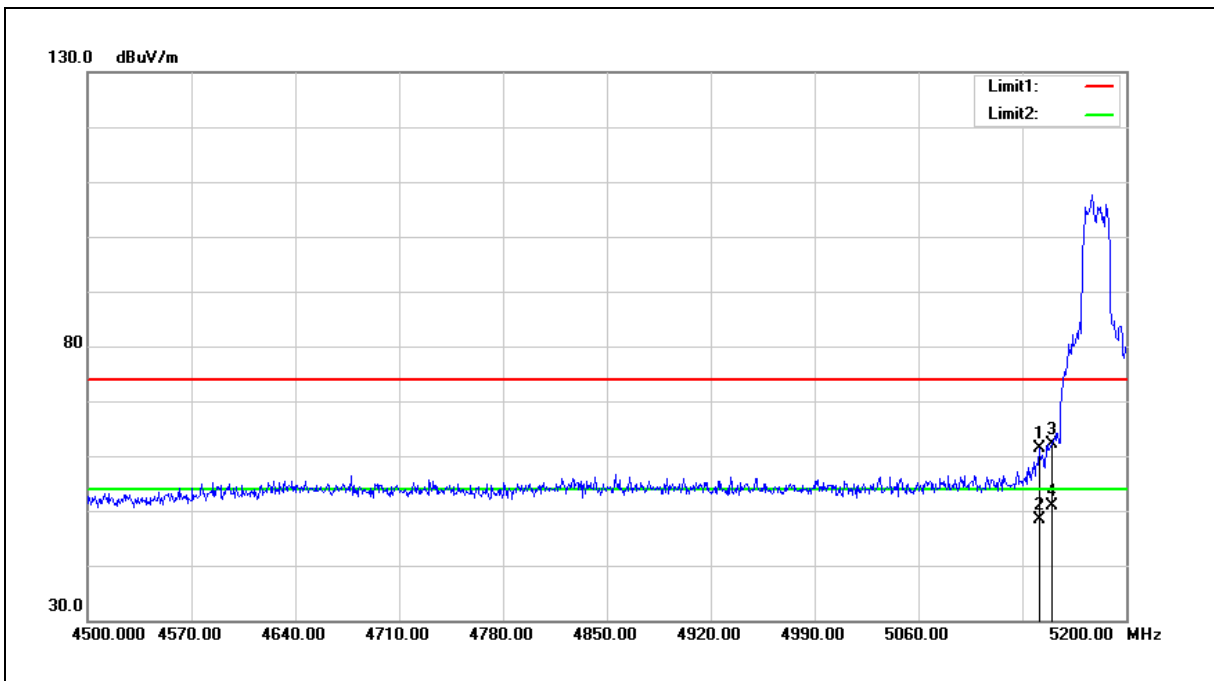

No.	Frequency (MHz)	Reading (dBuV)	Correct Factor (dB/m)	Result (dBuV/m)	Limit (dBuV/m)	Margin (dB)	Remark
1	5141.200	55.52	5.76	61.28	74.00	-12.72	peak
2	5141.200	42.67	5.76	48.43	54.00	-5.57	AVG
3	5150.000	56.29	5.78	62.07	74.00	-11.93	peak
4	5150.000	45.00	5.78	50.78	54.00	-3.22	AVG

Note:1.Result (dBuV/m) = Correct Factor (dB/m) + Reading(dBuV).

2.Correction factor (dB/m) = Antenna Factor (dB/m) + Cable loss (dB) – Pre-Amplifier gain (dB).

3.When the peak results are less than average limit, so not need to evaluate the average.



Standard:	FCC Part 15.407	Test Distance:	3 m
Test item:	Band edge	Power:	AC 120 V/60 Hz
Frequency:	5200 MHz	Temp.(°C)/Hum.(%RH):	26(°C)/60 %RH
Mode:	Mode 2		
Ant.Polar.:	Horizontal		

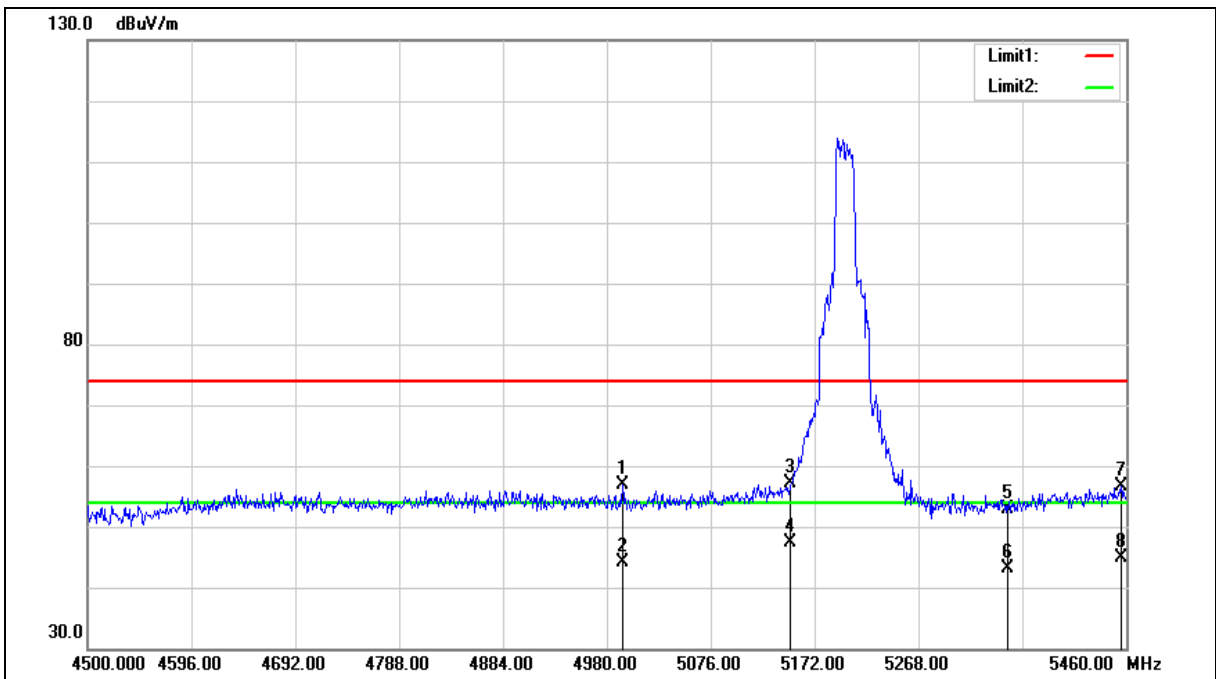



Standard:	FCC Part 15.407	Test Distance:	3 m
Test item:	Band edge	Power:	AC 120 V/60 Hz
Frequency:	5200 MHz	Temp.(°C)/Hum.(%RH):	26(°C)/60 %RH
Mode:	Mode 2		
Ant.Polar.:	Horizontal		

No.	Frequency (MHz)	Reading (dBuV)	Correct Factor (dB/m)	Result (dBuV/m)	Limit (dBuV/m)	Margin (dB)	Remark
1	4994.400	51.44	5.54	56.98	74.00	-17.02	peak
2	4994.400	38.62	5.54	44.16	54.00	-9.84	AVG
3	5150.000	51.23	5.78	57.01	74.00	-16.99	peak
4	5150.000	41.59	5.78	47.37	54.00	-6.63	AVG
5	5350.000	46.76	6.07	52.83	74.00	-21.17	peak
6	5350.000	37.09	6.07	43.16	54.00	-10.84	AVG
7	5455.200	50.48	6.22	56.70	74.00	-17.30	peak
8	5455.200	38.56	6.22	44.78	54.00	-9.22	AVG

Note:1.Result (dBuV/m) = Correct Factor (dB/m) + Reading(dBuV).

2.Correction factor (dB/m) = Antenna Factor (dB/m) + Cable loss (dB) – Pre-Amplifier gain (dB).

3.When the peak results are less than average limit, so not need to evaluate the average.



Standard:	FCC Part 15.407	Test Distance:	3 m
Test item:	Band edge	Power:	AC 120 V/60 Hz
Frequency:	5200 MHz	Temp.(°C)/Hum.(%RH):	26(°C)/60 %RH
Mode:	Mode 2		
Ant.Polar.:	Vertical		

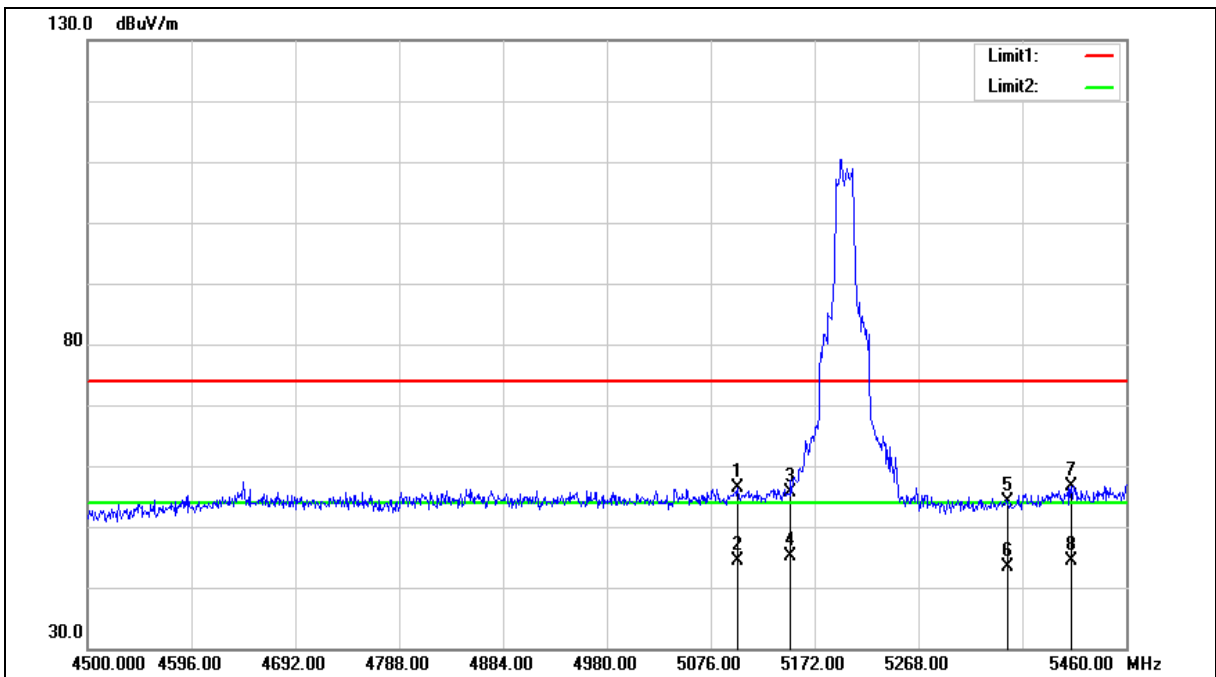



Standard:	FCC Part 15.407	Test Distance:	3 m
Test item:	Band edge	Power:	AC 120 V/60 Hz
Frequency:	5200 MHz	Temp.(°C)/Hum.(%RH):	26(°C)/60 %RH
Mode:	Mode 2		
Ant.Polar.:	Vertical		

No.	Frequency (MHz)	Reading (dBuV)	Correct Factor (dB/m)	Result (dBuV/m)	Limit (dBuV/m)	Margin (dB)	Remark
1	5100.960	50.65	5.70	56.35	74.00	-17.65	peak
2	5100.960	38.66	5.70	44.36	54.00	-9.64	AVG
3	5150.000	49.85	5.78	55.63	74.00	-18.37	peak
4	5150.000	39.46	5.78	45.24	54.00	-8.76	AVG
5	5350.000	48.16	6.07	54.23	74.00	-19.77	peak
6	5350.000	37.20	6.07	43.27	54.00	-10.73	AVG
7	5409.120	50.52	6.16	56.68	74.00	-17.32	peak
8	5409.120	38.15	6.16	44.31	54.00	-9.69	AVG

Note:1.Result (dBuV/m) = Correct Factor (dB/m) + Reading(dBuV).

2.Correction factor (dB/m) = Antenna Factor (dB/m) + Cable loss (dB) – Pre-Amplifier gain (dB).

3.When the peak results are less than average limit, so not need to evaluate the average.



Standard:	FCC Part 15.407	Test Distance:	3 m
Test item:	Band edge	Power:	AC 120 V/60 Hz
Frequency:	5240 MHz	Temp.(°C)/Hum.(%RH):	26(°C)/60 %RH
Mode:	Mode 2		
Ant.Polar.:	Horizontal		

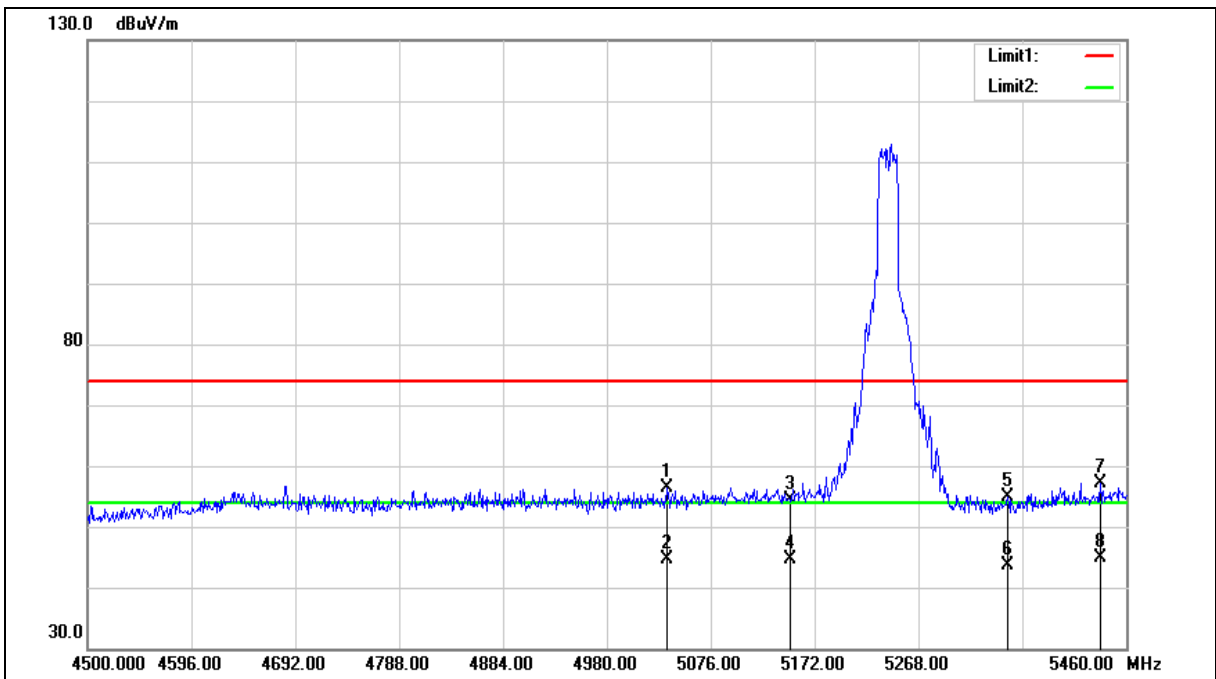





Standard:	FCC Part 15.407	Test Distance:	3 m
Test item:	Band edge	Power:	AC 120 V/60 Hz
Frequency:	5240 MHz	Temp.(°C)/Hum.(%RH):	26(°C)/60 %RH
Mode:	Mode 2		
Ant.Polar.:	Horizontal		

No.	Frequency (MHz)	Reading (dBuV)	Correct Factor (dB/m)	Result (dBuV/m)	Limit (dBuV/m)	Margin (dB)	Remark
1	5035.680	50.81	5.60	56.41	74.00	-17.59	peak
2	5035.680	38.96	5.60	44.56	54.00	-9.44	AVG
3	5150.000	48.50	5.78	54.28	74.00	-19.72	peak
4	5150.000	38.89	5.78	44.67	54.00	-9.33	AVG
5	5350.000	48.73	6.07	54.80	74.00	-19.20	peak
6	5350.000	37.50	6.07	43.57	54.00	-10.43	AVG
7	5436.000	50.96	6.20	57.16	74.00	-16.84	peak
8	5436.000	38.63	6.20	44.83	54.00	-9.17	AVG

Note:1.Result (dBuV/m) = Correct Factor (dB/m) + Reading(dBuV).

2.Correction factor (dB/m) = Antenna Factor (dB/m) + Cable loss (dB) – Pre-Amplifier gain (dB).

3.When the peak results are less than average limit, so not need to evaluate the average.



Standard:	FCC Part 15.407	Test Distance:	3 m
Test item:	Band edge	Power:	AC 120 V/60 Hz
Frequency:	5240 MHz	Temp.(°C)/Hum.(%RH):	26(°C)/60 %RH
Mode:	Mode 2		
Ant.Polar.:	Vertical		

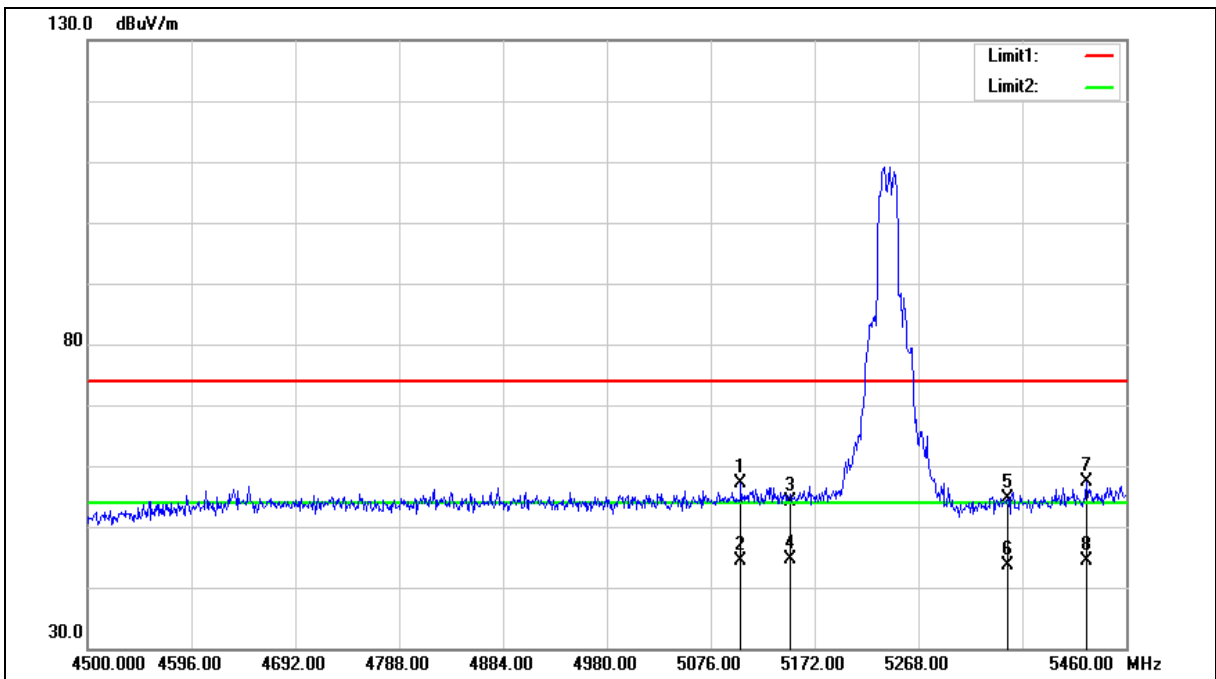



Standard:	FCC Part 15.407	Test Distance:	3 m
Test item:	Band edge	Power:	AC 120 V/60 Hz
Frequency:	5240 MHz	Temp.(°C)/Hum.(%RH):	26(°C)/60 %RH
Mode:	Mode 2		
Ant.Polar.:	Vertical		

No.	Frequency (MHz)	Reading (dBuV)	Correct Factor (dB/m)	Result (dBuV/m)	Limit (dBuV/m)	Margin (dB)	Remark
1	5103.840	51.45	5.71	57.16	74.00	-16.84	peak
2	5103.840	38.64	5.71	44.35	54.00	-9.65	AVG
3	5150.000	48.44	5.78	54.22	74.00	-19.78	peak
4	5150.000	38.85	5.78	44.63	54.00	-9.37	AVG
5	5350.000	48.67	6.07	54.74	74.00	-19.26	peak
6	5350.000	37.52	6.07	43.59	54.00	-10.41	AVG
7	5423.520	51.08	6.18	57.26	74.00	-16.74	peak
8	5423.520	38.30	6.18	44.48	54.00	-9.52	AVG

Note:1.Result (dBuV/m) = Correct Factor (dB/m) + Reading(dBuV).

2.Correction factor (dB/m) = Antenna Factor (dB/m) + Cable loss (dB) – Pre-Amplifier gain (dB).

3.When the peak results are less than average limit, so not need to evaluate the average.



Standard:	FCC Part 15.407	Test Distance:	3 m
Test item:	Band edge	Power:	AC 120 V/60 Hz
Frequency:	5745 MHz	Temp.(°C)/Hum.(%RH):	26(°C )/60 %RH
Mode:	Mode 2		
Ant.Polar.:	Horizontal		

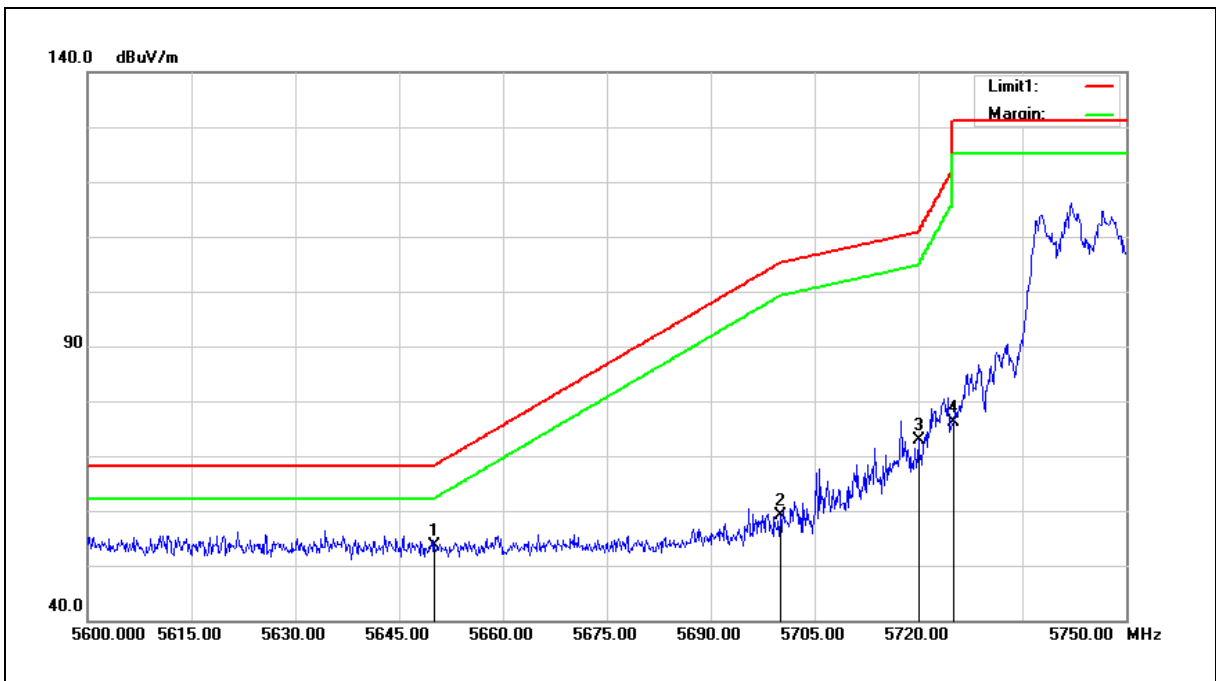

No.	Frequency (MHz)	Reading (dBuV)	Correct Factor (dB/m)	Result (dBuV/m)	Limit (dBuV/m)	Margin (dB)	Remark
1	5650.000	47.01	6.61	53.62	68.20	-14.58	peak
2	5700.000	52.48	6.71	59.19	105.20	-46.01	peak
3	5720.000	66.14	6.77	72.91	110.80	-37.89	peak
4	5725.000	69.31	6.78	76.09	122.20	-46.11	peak

- Note:1.Result (dBuV/m) = Correct Factor (dB/m) + Reading(dBuV).
- 2.Correction factor (dB/m) = Antenna Factor (dB/m) + Cable loss (dB) – Pre-Amplifier gain (dB).
- 3.When the peak results are less than average limit, so not need to evaluate the average.



Standard:	FCC Part 15.407	Test Distance:	3 m
Test item:	Band edge	Power:	AC 120 V/60 Hz
Frequency:	5745 MHz	Temp.(°C)/Hum.(%RH):	26(°C )/60 %RH
Mode:	Mode 2		
Ant.Polar.:	Vertical		

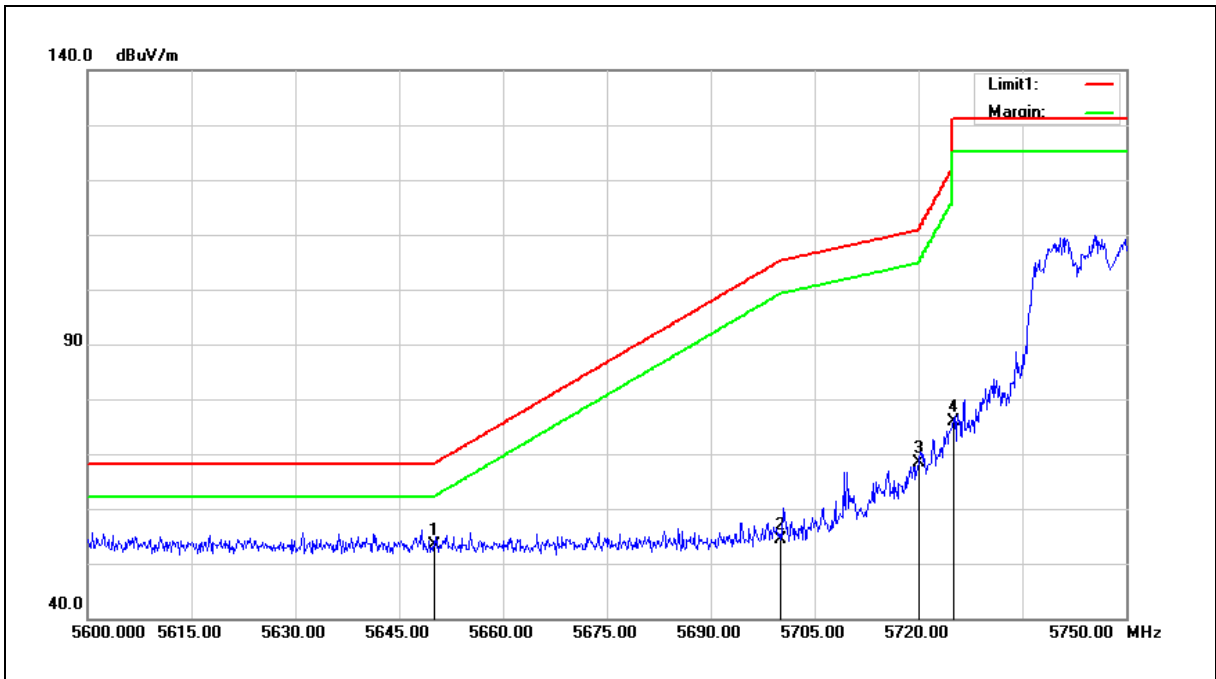

No.	Frequency (MHz)	Reading (dBuV)	Correct Factor (dB/m)	Result (dBuV/m)	Limit (dBuV/m)	Margin (dB)	Remark
1	5650.000	46.83	6.61	53.44	68.20	-14.76	peak
2	5700.000	47.76	6.71	54.47	105.20	-50.73	peak
3	5720.000	61.69	6.77	68.46	110.80	-42.34	peak
4	5725.000	69.01	6.78	75.79	122.20	-46.41	peak

Note:1.Result (dBuV/m) = Correct Factor (dB/m) + Reading(dBuV).

2.Correction factor (dB/m) = Antenna Factor (dB/m) + Cable loss (dB) – Pre-Amplifier gain (dB).

3.When the peak results are less than average limit, so not need to evaluate the average.



Standard:	FCC Part 15.407	Test Distance:	3 m
Test item:	Band edge	Power:	AC 120 V/60 Hz
Frequency:	5785 MHz	Temp.(°C)/Hum.(%RH):	26(°C)/60 %RH
Mode:	Mode 2		
Ant.Polar.:	Horizontal		

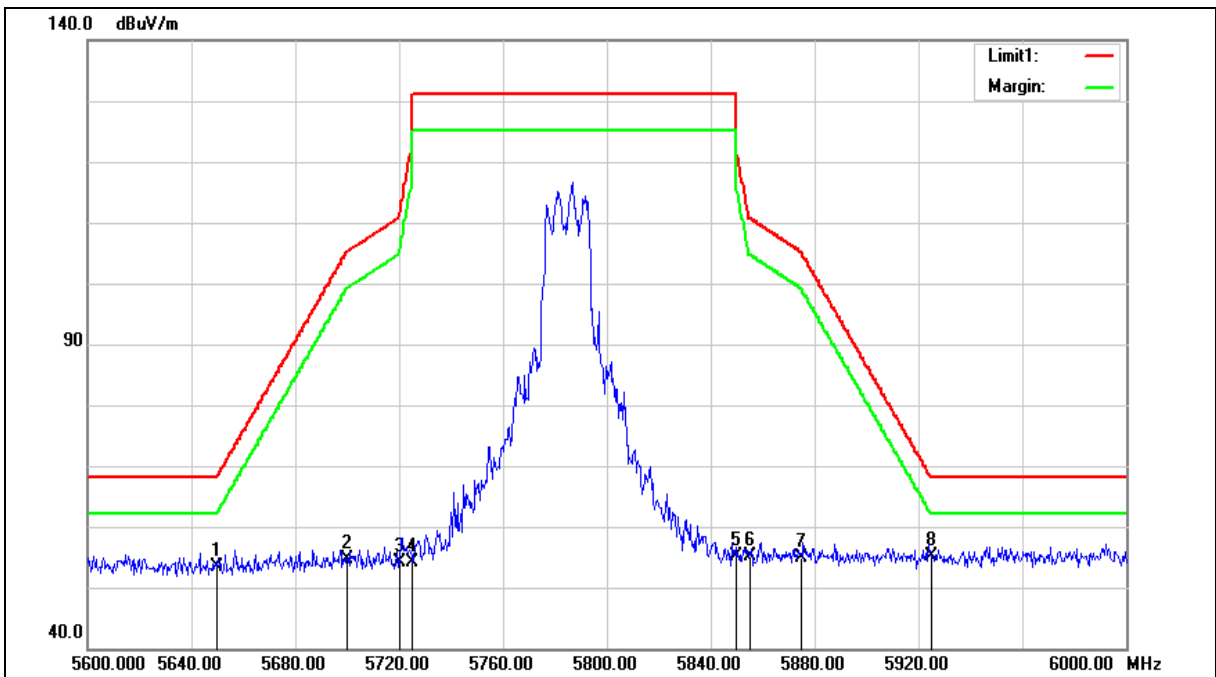



Standard:	FCC Part 15.407	Test Distance:	3 m
Test item:	Band edge	Power:	AC 120 V/60 Hz
Frequency:	5785 MHz	Temp.(°C)/Hum.(%RH):	26(°C)/60 %RH
Mode:	Mode 2		
Ant.Polar.:	Horizontal		

No.	Frequency (MHz)	Reading (dBuV)	Correct Factor (dB/m)	Result (dBuV/m)	Limit (dBuV/m)	Margin (dB)	Remark
1	5650.000	46.87	6.61	53.48	68.20	-14.72	peak
2	5700.000	47.96	6.71	54.67	105.20	-50.53	peak
3	5720.000	47.31	6.77	54.08	110.80	-56.72	peak
4	5725.000	47.45	6.78	54.23	122.20	-67.97	peak
5	5850.000	48.17	7.03	55.20	122.20	-67.00	peak
6	5855.000	48.21	7.04	55.25	110.80	-55.55	peak
7	5875.000	47.84	7.09	54.93	105.20	-50.27	peak
8	5925.000	47.97	7.20	55.17	68.20	-13.03	peak

Note:1.Result (dBuV/m) = Correct Factor (dB/m) + Reading(dBuV).

2.Correction factor (dB/m) = Antenna Factor (dB/m) + Cable loss (dB) – Pre-Amplifier gain (dB).

3.When the peak results are less than average limit, so not need to evaluate the average.



Standard:	FCC Part 15.407	Test Distance:	3 m
Test item:	Band edge	Power:	AC 120 V/60 Hz
Frequency:	5785 MHz	Temp.(°C)/Hum.(%RH):	26(°C)/60 %RH
Mode:	Mode 2		
Ant.Polar.:	Vertical		

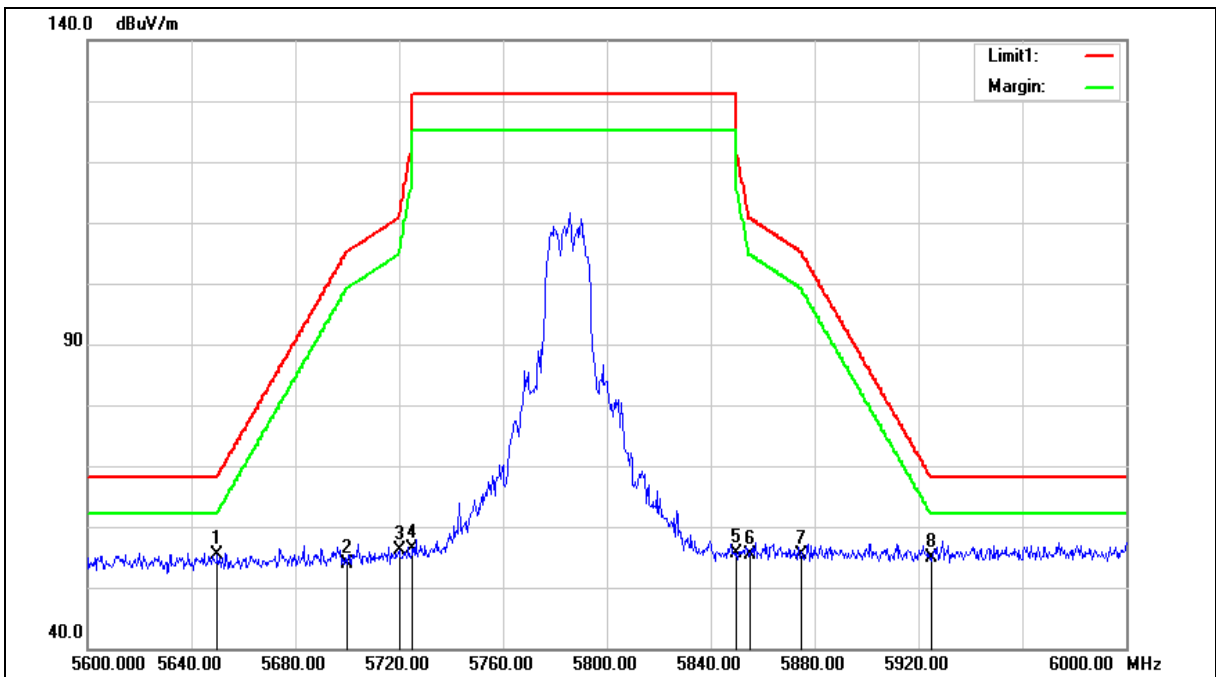





Standard:	FCC Part 15.407	Test Distance:	3 m
Test item:	Band edge	Power:	AC 120 V/60 Hz
Frequency:	5785 MHz	Temp.(°C)/Hum.(%RH):	26(°C)/60 %RH
Mode:	Mode 2		
Ant.Polar.:	Vertical		

No.	Frequency (MHz)	Reading (dBuV)	Correct Factor (dB/m)	Result (dBuV/m)	Limit (dBuV/m)	Margin (dB)	Remark
1	5650.000	48.75	6.61	55.36	68.20	-12.84	peak
2	5700.000	47.18	6.71	53.89	105.20	-51.31	peak
3	5720.000	49.30	6.77	56.07	110.80	-54.73	peak
4	5725.000	49.71	6.78	56.49	122.20	-65.71	peak
5	5850.000	48.52	7.03	55.55	122.20	-66.65	peak
6	5855.000	48.23	7.04	55.27	110.80	-55.53	peak
7	5875.000	48.39	7.09	55.48	105.20	-49.72	peak
8	5925.000	47.71	7.20	54.91	68.20	-13.29	peak

Note:1.Result (dBuV/m) = Correct Factor (dB/m) + Reading(dBuV).

2.Correction factor (dB/m) = Antenna Factor (dB/m) + Cable loss (dB) – Pre-Amplifier gain (dB).

3.When the peak results are less than average limit, so not need to evaluate the average.



Standard:	FCC Part 15.407	Test Distance:	3 m
Test item:	Band edge	Power:	AC 120 V/60 Hz
Frequency:	5825 MHz	Temp.(°C)/Hum.(%RH):	26(°C)/60 %RH
Mode:	Mode 2		
Ant.Polar.:	Horizontal		

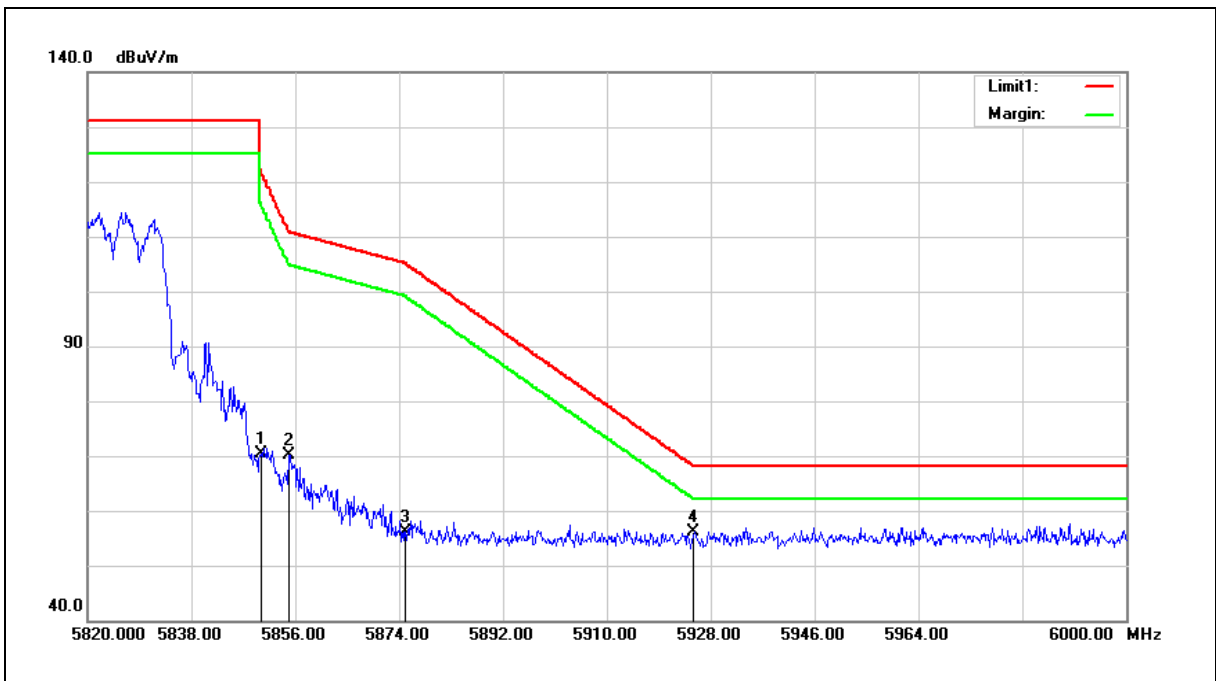

No.	Frequency (MHz)	Reading (dBuV)	Correct Factor (dB/m)	Result (dBuV/m)	Limit (dBuV/m)	Margin (dB)	Remark
1	5850.000	63.25	7.03	70.28	122.20	-51.92	peak
2	5855.000	63.13	7.04	70.17	110.80	-40.63	peak
3	5875.000	49.14	7.09	56.23	105.20	-48.97	peak
4	5925.000	48.94	7.20	56.14	68.20	-12.06	peak

Note:1.Result (dBuV/m) = Correct Factor (dB/m) + Reading(dBuV).

2.Correction factor (dB/m) = Antenna Factor (dB/m) + Cable loss (dB) – Pre-Amplifier gain (dB).

3.When the peak results are less than average limit, so not need to evaluate the average.



Standard:	FCC Part 15.407	Test Distance:	3 m
Test item:	Band edge	Power:	AC 120 V/60 Hz
Frequency:	5825 MHz	Temp.(°C)/Hum.(%RH):	26(°C)/60 %RH
Mode:	Mode 2		
Ant.Polar.:	Vertical		

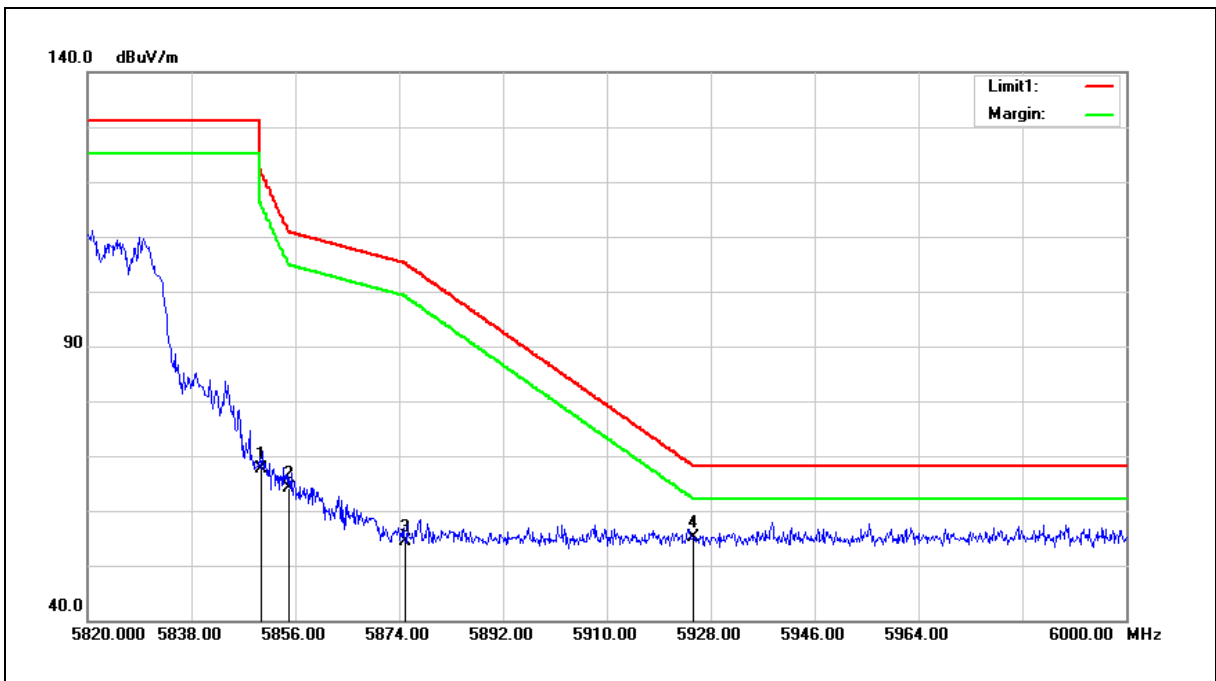

No.	Frequency (MHz)	Reading (dBuV)	Correct Factor (dB/m)	Result (dBuV/m)	Limit (dBuV/m)	Margin (dB)	Remark
1	5850.000	60.50	7.03	67.53	122.20	-54.67	peak
2	5855.000	57.14	7.04	64.18	110.80	-46.62	peak
3	5875.000	47.30	7.09	54.39	105.20	-50.81	peak
4	5925.000	47.84	7.20	55.04	68.20	-13.16	peak

- Note:1.Result (dBuV/m) = Correct Factor (dB/m) + Reading(dBuV).  
 2.Correction factor (dB/m) = Antenna Factor (dB/m) + Cable loss (dB) – Pre-Amplifier gain (dB).  
 3.When the peak results are less than average limit, so not need to evaluate the average.



Standard:	FCC Part 15.407	Test Distance:	3 m
Test item:	Band edge	Power:	AC 120 V/60 Hz
Frequency:	5180 MHz	Temp.(°C)/Hum.(%RH):	26(°C)/60 %RH
Mode:	Mode 3		
Ant.Polar.:	Horizontal		

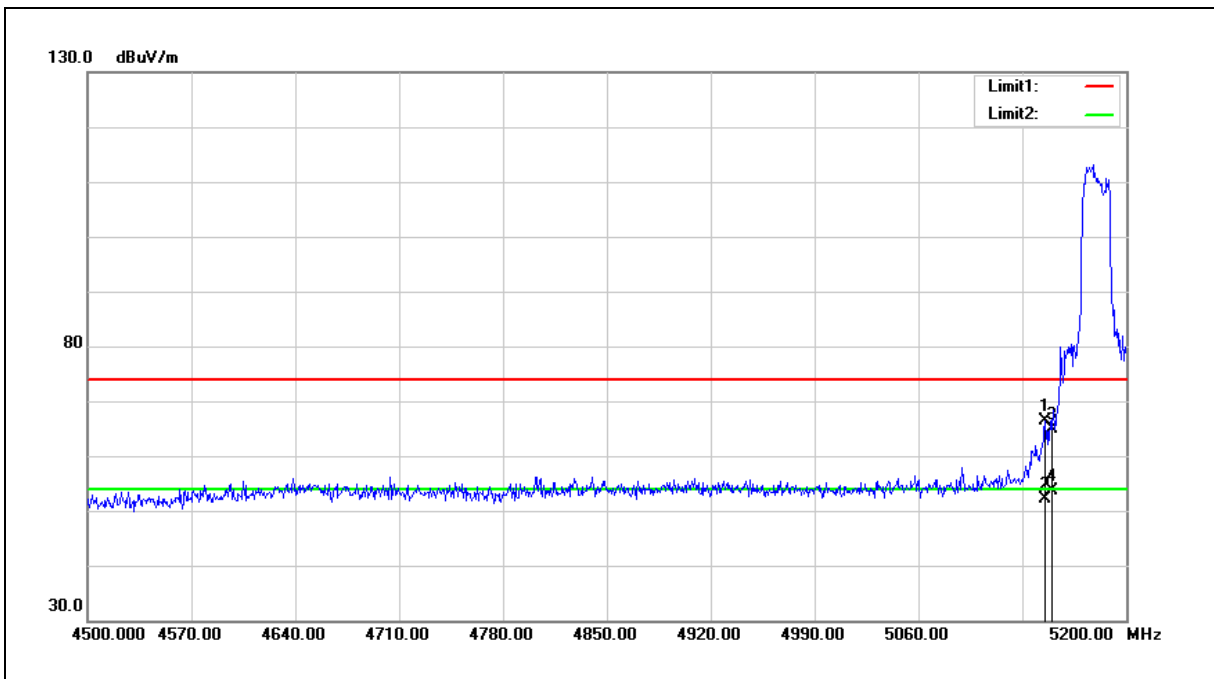

No.	Frequency (MHz)	Reading (dBuV)	Correct Factor (dB/m)	Result (dBuV/m)	Limit (dBuV/m)	Margin (dB)	Remark
1	5145.400	60.51	5.77	66.28	74.00	-7.72	peak
2	5145.400	46.45	5.77	52.22	54.00	-1.78	AVG
3	5150.000	59.11	5.78	64.89	74.00	-9.11	peak
4	5150.000	47.87	5.78	53.65	54.00	-0.35	AVG

Note:1.Result (dBuV/m) = Correct Factor (dB/m) + Reading(dBuV).

2.Correction factor (dB/m) = Antenna Factor (dB/m) + Cable loss (dB) – Pre-Amplifier gain (dB).

3.When the peak results are less than average limit, so not need to evaluate the average.



Standard:	FCC Part 15.407	Test Distance:	3 m
Test item:	Band edge	Power:	AC 120 V/60 Hz
Frequency:	5180 MHz	Temp.(°C)/Hum.(%RH):	26(°C)/60 %RH
Mode:	Mode 3		
Ant.Polar.:	Vertical		

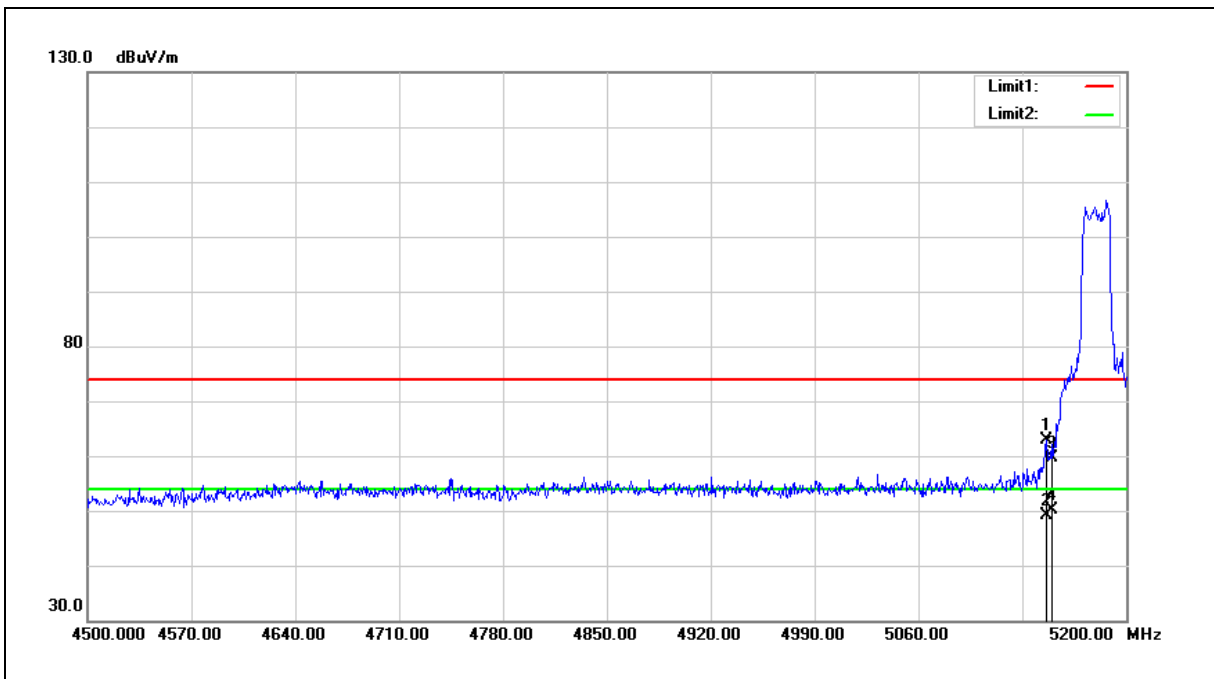

No.	Frequency (MHz)	Reading (dBuV)	Correct Factor (dB/m)	Result (dBuV/m)	Limit (dBuV/m)	Margin (dB)	Remark
1	5146.100	56.99	5.77	62.76	74.00	-11.24	peak
2	5146.100	43.34	5.77	49.11	54.00	-4.89	AVG
3	5150.000	53.93	5.78	59.71	74.00	-14.29	peak
4	5150.000	44.41	5.78	50.19	54.00	-3.81	AVG

Note:1.Result (dBuV/m) = Correct Factor (dB/m) + Reading(dBuV).

2.Correction factor (dB/m) = Antenna Factor (dB/m) + Cable loss (dB) – Pre-Amplifier gain (dB).

3.When the peak results are less than average limit, so not need to evaluate the average.



Standard:	FCC Part 15.407	Test Distance:	3 m
Test item:	Band edge	Power:	AC 120 V/60 Hz
Frequency:	5200 MHz	Temp.(°C)/Hum.(%RH):	26(°C)/60 %RH
Mode:	Mode 3		
Ant.Polar.:	Horizontal		

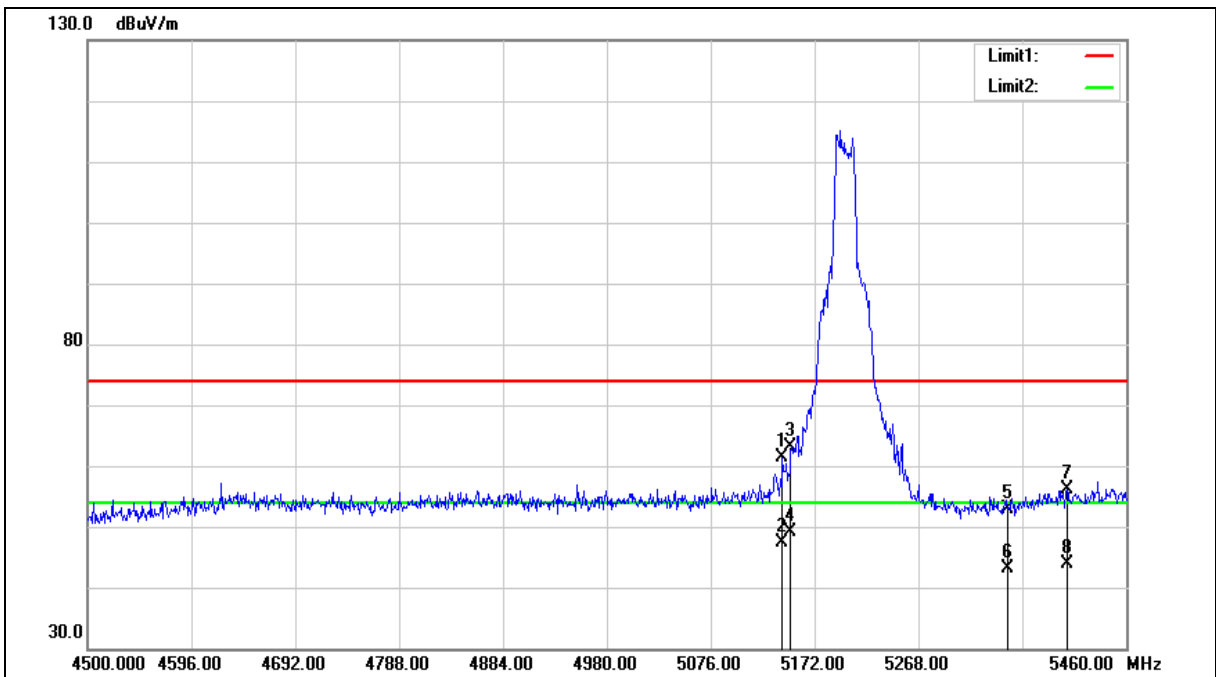



Standard:	FCC Part 15.407	Test Distance:	3 m
Test item:	Band edge	Power:	AC 120 V/60 Hz
Frequency:	5200 MHz	Temp.(°C)/Hum.(%RH):	26(°C)/60 %RH
Mode:	Mode 3		
Ant.Polar.:	Horizontal		

No.	Frequency (MHz)	Reading (dBuV)	Correct Factor (dB/m)	Result (dBuV/m)	Limit (dBuV/m)	Margin (dB)	Remark
1	5142.240	55.66	5.77	61.43	74.00	-12.57	peak
2	5142.240	41.66	5.77	47.43	54.00	-6.57	AVG
3	5150.000	57.32	5.78	63.10	74.00	-10.90	peak
4	5150.000	43.32	5.78	49.10	54.00	-4.90	AVG
5	5350.000	46.91	6.07	52.98	74.00	-21.02	peak
6	5350.000	37.00	6.07	43.07	54.00	-10.93	AVG
7	5405.280	49.90	6.15	56.05	74.00	-17.95	peak
8	5405.280	37.78	6.15	43.93	54.00	-10.07	AVG

Note:1.Result (dBuV/m) = Correct Factor (dB/m) + Reading(dBuV).

2.Correction factor (dB/m) = Antenna Factor (dB/m) + Cable loss (dB) – Pre-Amplifier gain (dB).

3.When the peak results are less than average limit, so not need to evaluate the average.



Standard:	FCC Part 15.407	Test Distance:	3 m
Test item:	Band edge	Power:	AC 120 V/60 Hz
Frequency:	5200 MHz	Temp.(°C)/Hum.(%RH):	26(°C)/60 %RH
Mode:	Mode 3		
Ant.Polar.:	Vertical		

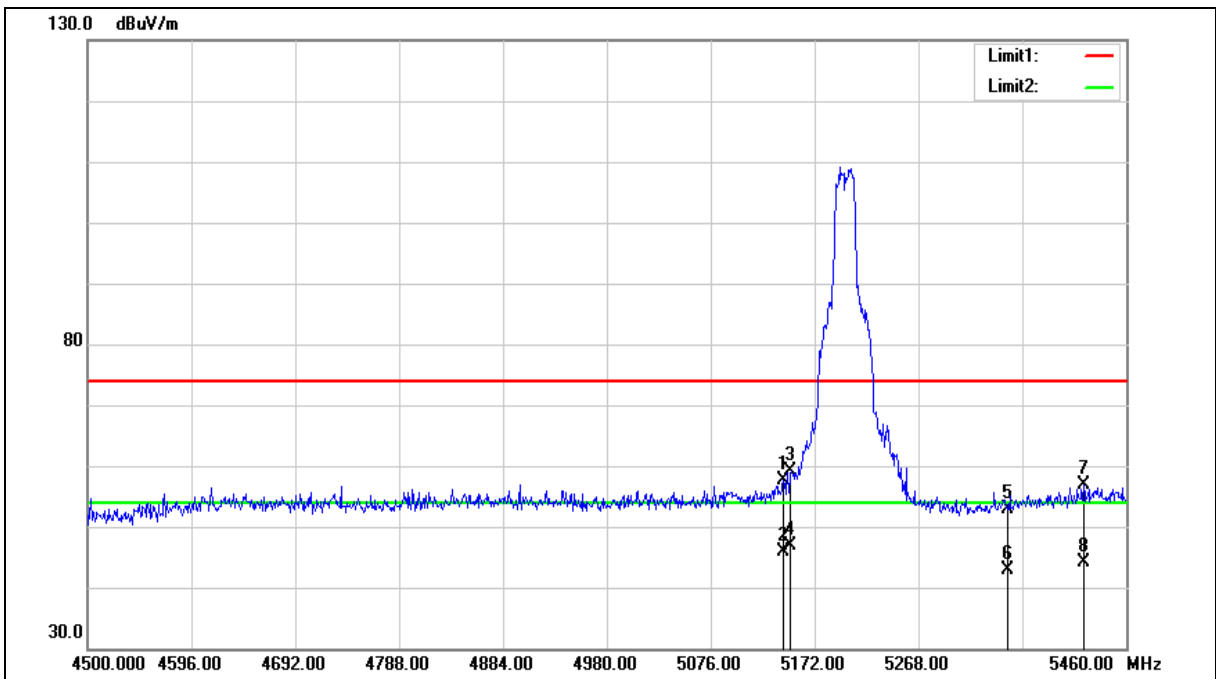





Standard:	FCC Part 15.407	Test Distance:	3 m
Test item:	Band edge	Power:	AC 120 V/60 Hz
Frequency:	5200 MHz	Temp.(°C)/Hum.(%RH):	26(°C)/60 %RH
Mode:	Mode 3		
Ant.Polar.:	Vertical		

No.	Frequency (MHz)	Reading (dBuV)	Correct Factor (dB/m)	Result (dBuV/m)	Limit (dBuV/m)	Margin (dB)	Remark
1	5143.200	51.74	5.77	57.51	74.00	-16.49	peak
2	5143.200	40.00	5.77	45.77	54.00	-8.23	AVG
3	5150.000	53.31	5.78	59.09	74.00	-14.91	peak
4	5150.000	41.14	5.78	46.92	54.00	-7.08	AVG
5	5350.000	46.83	6.07	52.90	74.00	-21.10	peak
6	5350.000	36.91	6.07	42.98	54.00	-11.02	AVG
7	5420.640	50.60	6.17	56.77	74.00	-17.23	peak
8	5420.640	38.03	6.17	44.20	54.00	-9.80	AVG

Note:1.Result (dBuV/m) = Correct Factor (dB/m) + Reading(dBuV).

2.Correction factor (dB/m) = Antenna Factor (dB/m) + Cable loss (dB) – Pre-Amplifier gain (dB).

3.When the peak results are less than average limit, so not need to evaluate the average.



Standard:	FCC Part 15.407	Test Distance:	3 m
Test item:	Band edge	Power:	AC 120 V/60 Hz
Frequency:	5240 MHz	Temp.(°C)/Hum.(%RH):	26(°C)/60 %RH
Mode:	Mode 3		
Ant.Polar.:	Horizontal		

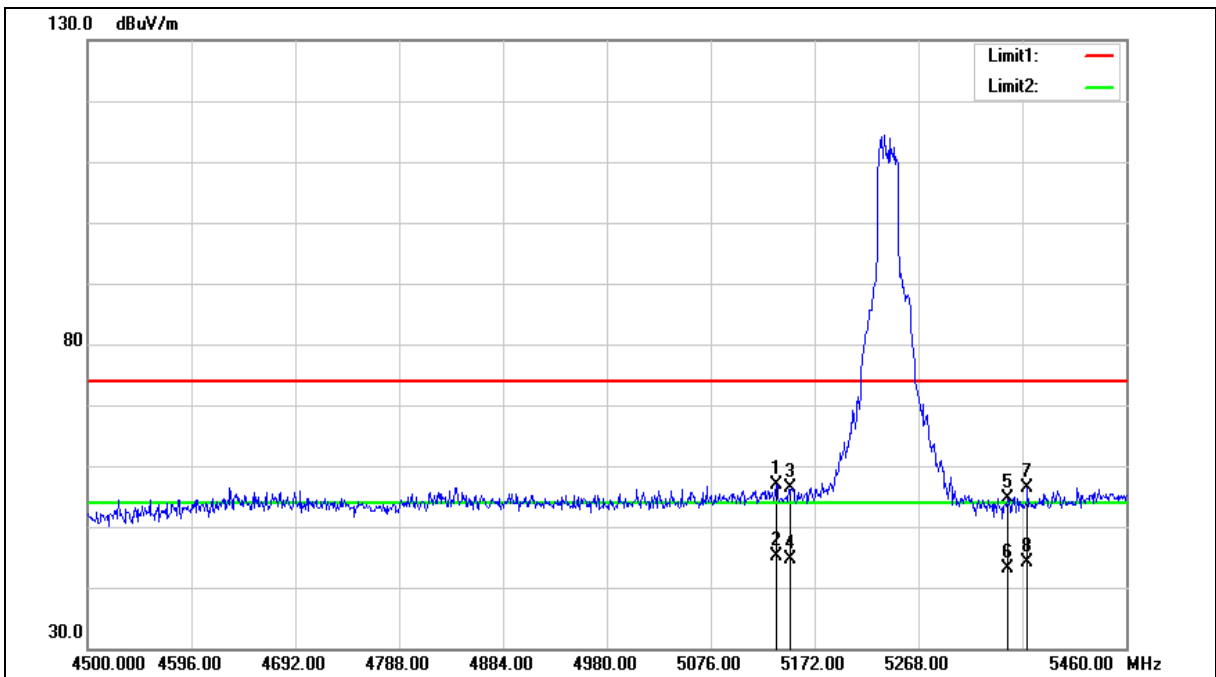



Standard:	FCC Part 15.407	Test Distance:	3 m
Test item:	Band edge	Power:	AC 120 V/60 Hz
Frequency:	5240 MHz	Temp.(°C)/Hum.(%RH):	26(°C)/60 %RH
Mode:	Mode 3		
Ant.Polar.:	Horizontal		

No.	Frequency (MHz)	Reading (dBuV)	Correct Factor (dB/m)	Result (dBuV/m)	Limit (dBuV/m)	Margin (dB)	Remark
1	5136.480	51.21	5.75	56.96	74.00	-17.04	peak
2	5136.480	39.26	5.75	45.01	54.00	-8.99	AVG
3	5150.000	50.69	5.78	56.47	74.00	-17.53	peak
4	5150.000	38.92	5.78	44.70	54.00	-9.30	AVG
5	5350.000	48.54	6.07	54.61	74.00	-19.39	peak
6	5350.000	37.17	6.07	43.24	54.00	-10.76	AVG
7	5368.800	50.34	6.10	56.44	74.00	-17.56	peak
8	5368.800	38.02	6.10	44.12	54.00	-9.88	AVG

Note:1.Result (dBuV/m) = Correct Factor (dB/m) + Reading(dBuV).

2.Correction factor (dB/m) = Antenna Factor (dB/m) + Cable loss (dB) – Pre-Amplifier gain (dB).

3.When the peak results are less than average limit, so not need to evaluate the average.



Standard:	FCC Part 15.407	Test Distance:	3 m
Test item:	Band edge	Power:	AC 120 V/60 Hz
Frequency:	5240 MHz	Temp.(°C)/Hum.(%RH):	26(°C)/60 %RH
Mode:	Mode 3		
Ant.Polar.:	Vertical		

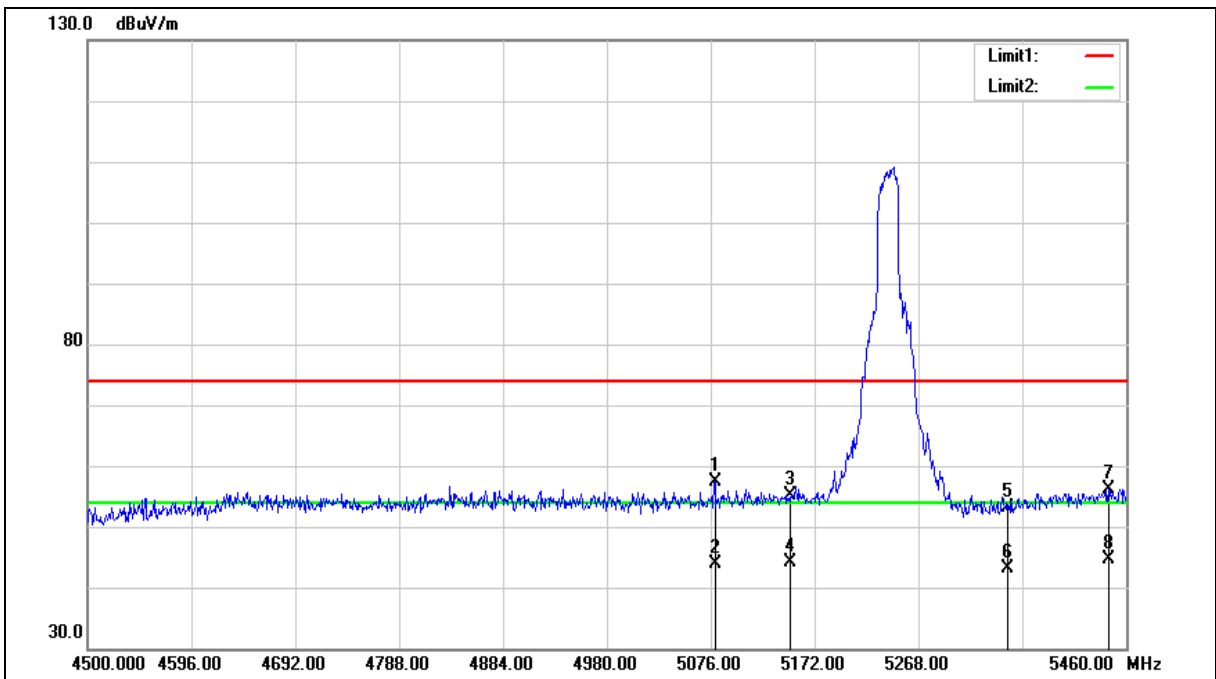



Standard:	FCC Part 15.407	Test Distance:	3 m
Test item:	Band edge	Power:	AC 120 V/60 Hz
Frequency:	5240 MHz	Temp.(°C)/Hum.(%RH):	26(°C)/60 %RH
Mode:	Mode 3		
Ant.Polar.:	Vertical		

No.	Frequency (MHz)	Reading (dBuV)	Correct Factor (dB/m)	Result (dBuV/m)	Limit (dBuV/m)	Margin (dB)	Remark
1	5079.840	51.72	5.67	57.39	74.00	-16.61	peak
2	5079.840	38.32	5.67	43.99	54.00	-10.01	AVG
3	5150.000	49.27	5.78	55.05	74.00	-18.95	peak
4	5150.000	38.45	5.78	44.23	54.00	-9.77	AVG
5	5350.000	46.97	6.07	53.04	74.00	-20.96	peak
6	5350.000	36.95	6.07	43.02	54.00	-10.98	AVG
7	5443.680	50.03	6.21	56.24	74.00	-17.76	peak
8	5443.680	38.44	6.21	44.65	54.00	-9.35	AVG

Note:1.Result (dBuV/m) = Correct Factor (dB/m) + Reading(dBuV).

2.Correction factor (dB/m) = Antenna Factor (dB/m) + Cable loss (dB) – Pre-Amplifier gain (dB).

3.When the peak results are less than average limit, so not need to evaluate the average.



Standard:	FCC Part 15.407	Test Distance:	3 m
Test item:	Band edge	Power:	AC 120 V/60 Hz
Frequency:	5745 MHz	Temp.(°C)/Hum.(%RH):	26(°C)/60 %RH
Mode:	Mode 3		
Ant.Polar.:	Horizontal		

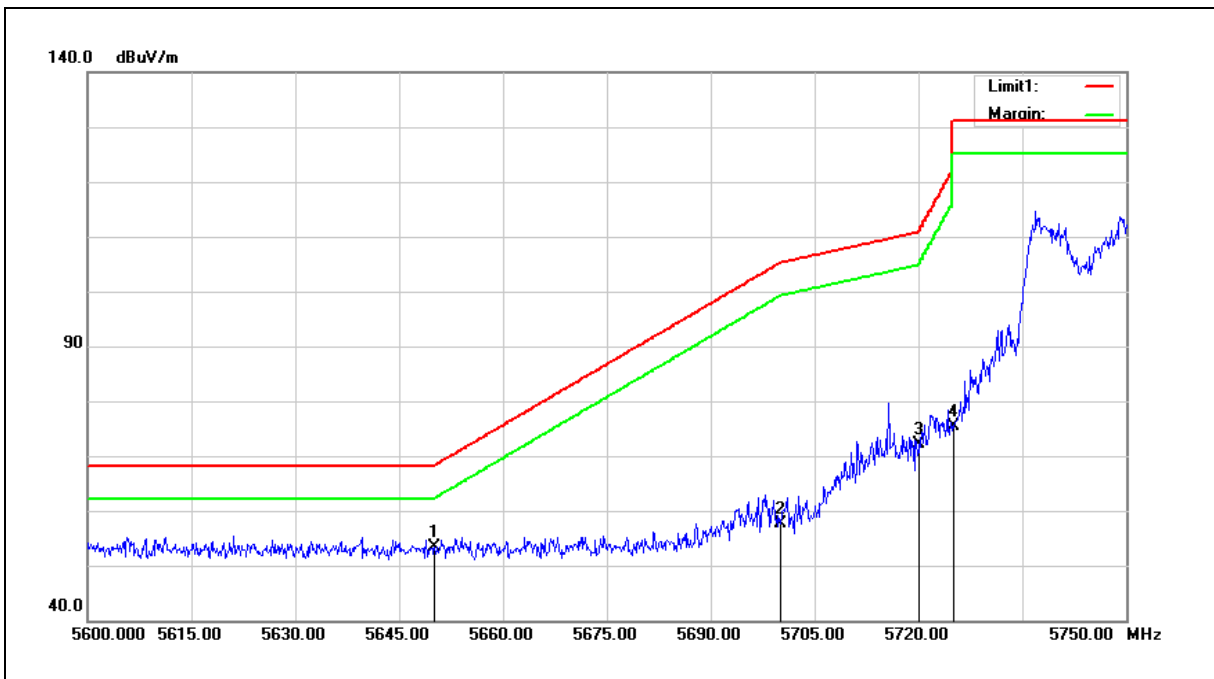

No.	Frequency (MHz)	Reading (dBuV)	Correct Factor (dB/m)	Result (dBuV/m)	Limit (dBuV/m)	Margin (dB)	Remark
1	5650.000	46.66	6.61	53.27	68.20	-14.93	peak
2	5700.000	50.92	6.71	57.63	105.20	-47.57	peak
3	5720.000	65.45	6.77	72.22	110.80	-38.58	peak
4	5725.000	68.67	6.78	75.45	122.20	-46.75	peak

Note:1.Result (dBuV/m) = Correct Factor (dB/m) + Reading(dBuV).

2.Correction factor (dB/m) = Antenna Factor (dB/m) + Cable loss (dB) – Pre-Amplifier gain (dB).

3.When the peak results are less than average limit, so not need to evaluate the average.



Standard:	FCC Part 15.407	Test Distance:	3 m
Test item:	Band edge	Power:	AC 120 V/60 Hz
Frequency:	5745 MHz	Temp.(°C)/Hum.(%RH):	26(°C )/60 %RH
Mode:	Mode 3		
Ant.Polar.:	Vertical		

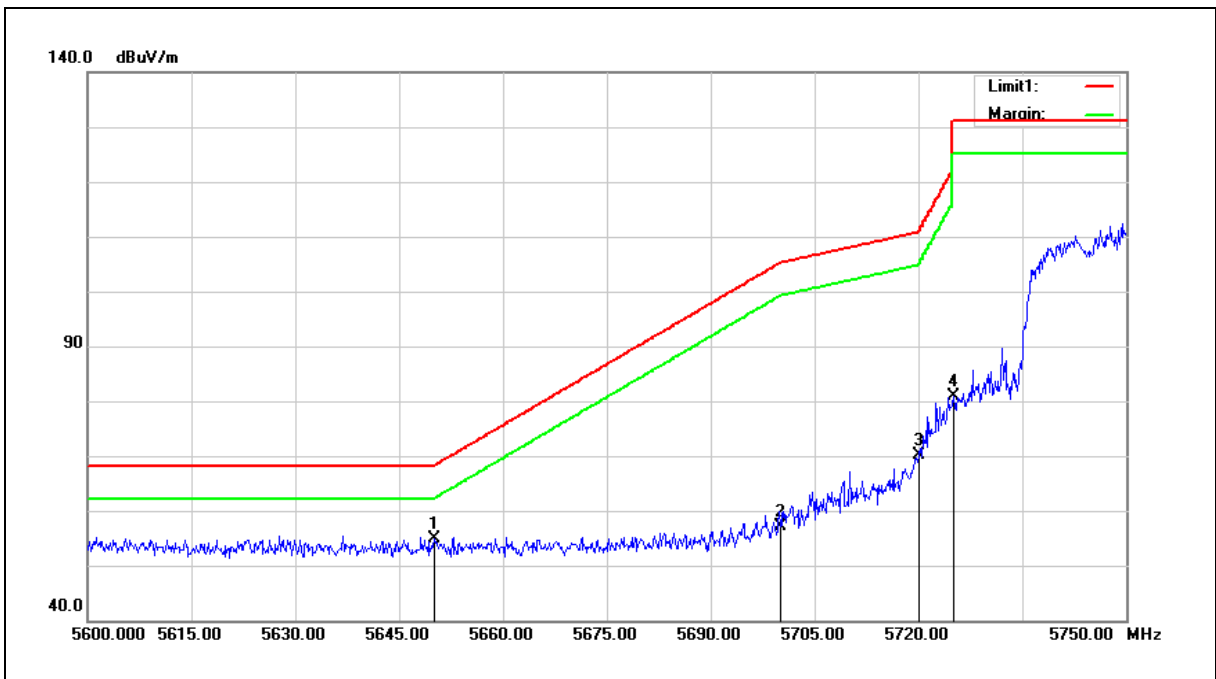

No.	Frequency (MHz)	Reading (dBuV)	Correct Factor (dB/m)	Result (dBuV/m)	Limit (dBuV/m)	Margin (dB)	Remark
1	5650.000	48.25	6.61	54.86	68.20	-13.34	peak
2	5700.000	50.38	6.71	57.09	105.20	-48.11	peak
3	5720.000	63.27	6.77	70.04	110.80	-40.76	peak
4	5725.000	74.11	6.78	80.89	122.20	-41.31	peak

Note:1.Result (dBuV/m) = Correct Factor (dB/m) + Reading(dBuV).

2.Correction factor (dB/m) = Antenna Factor (dB/m) + Cable loss (dB) – Pre-Amplifier gain (dB).

3.When the peak results are less than average limit, so not need to evaluate the average.



Standard:	FCC Part 15.407	Test Distance:	3 m
Test item:	Band edge	Power:	AC 120 V/60 Hz
Frequency:	5785 MHz	Temp.(°C)/Hum.(%RH):	26(°C)/60 %RH
Mode:	Mode 3		
Ant.Polar.:	Horizontal		

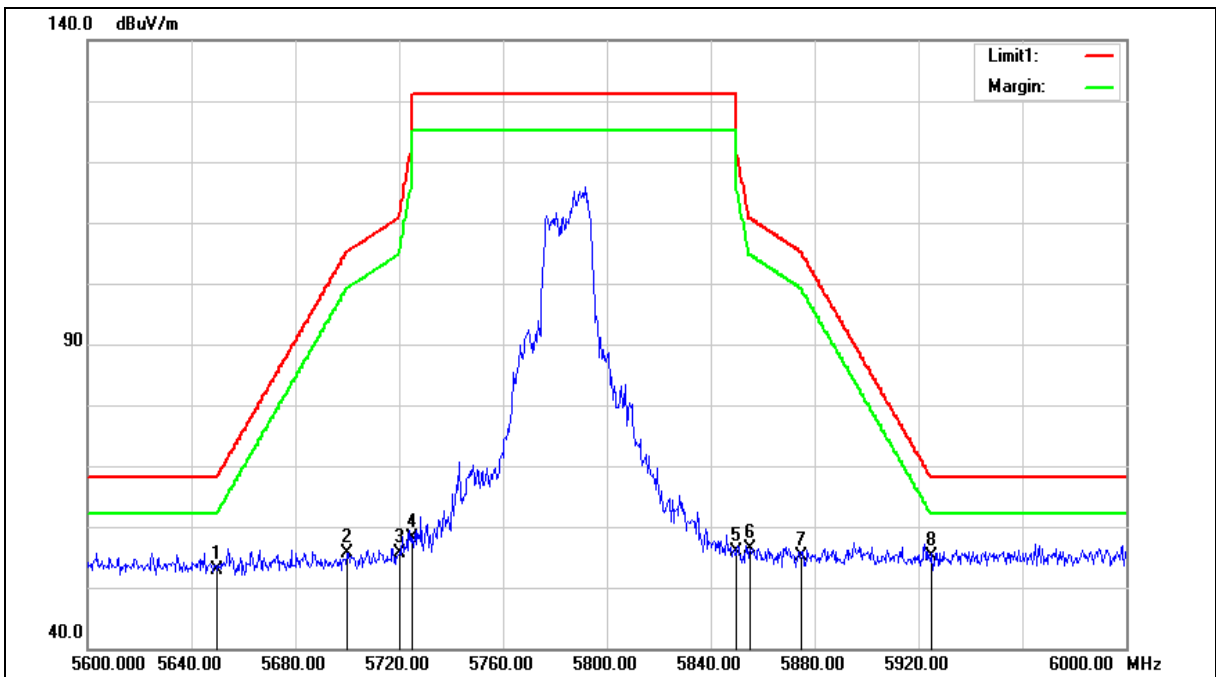





Standard:	FCC Part 15.407	Test Distance:	3 m
Test item:	Band edge	Power:	AC 120 V/60 Hz
Frequency:	5785 MHz	Temp.(°C)/Hum.(%RH):	26(°C)/60 %RH
Mode:	Mode 3		
Ant.Polar.:	Horizontal		

No.	Frequency (MHz)	Reading (dBuV)	Correct Factor (dB/m)	Result (dBuV/m)	Limit (dBuV/m)	Margin (dB)	Remark
1	5650.000	46.25	6.61	52.86	68.20	-15.34	peak
2	5700.000	48.94	6.71	55.65	105.20	-49.55	peak
3	5720.000	48.79	6.77	55.56	110.80	-55.24	peak
4	5725.000	51.42	6.78	58.20	122.20	-64.00	peak
5	5850.000	48.94	7.03	55.97	122.20	-66.23	peak
6	5855.000	49.23	7.04	56.27	110.80	-54.53	peak
7	5875.000	47.95	7.09	55.04	105.20	-50.16	peak
8	5925.000	47.87	7.20	55.07	68.20	-13.13	peak

Note:1.Result (dBuV/m) = Correct Factor (dB/m) + Reading(dBuV).

2.Correction factor (dB/m) = Antenna Factor (dB/m) + Cable loss (dB) – Pre-Amplifier gain (dB).

3.When the peak results are less than average limit, so not need to evaluate the average.



Standard:	FCC Part 15.407	Test Distance:	3 m
Test item:	Band edge	Power:	AC 120 V/60 Hz
Frequency:	5785 MHz	Temp.(°C)/Hum.(%RH):	26(°C)/60 %RH
Mode:	Mode 3		
Ant.Polar.:	Vertical		

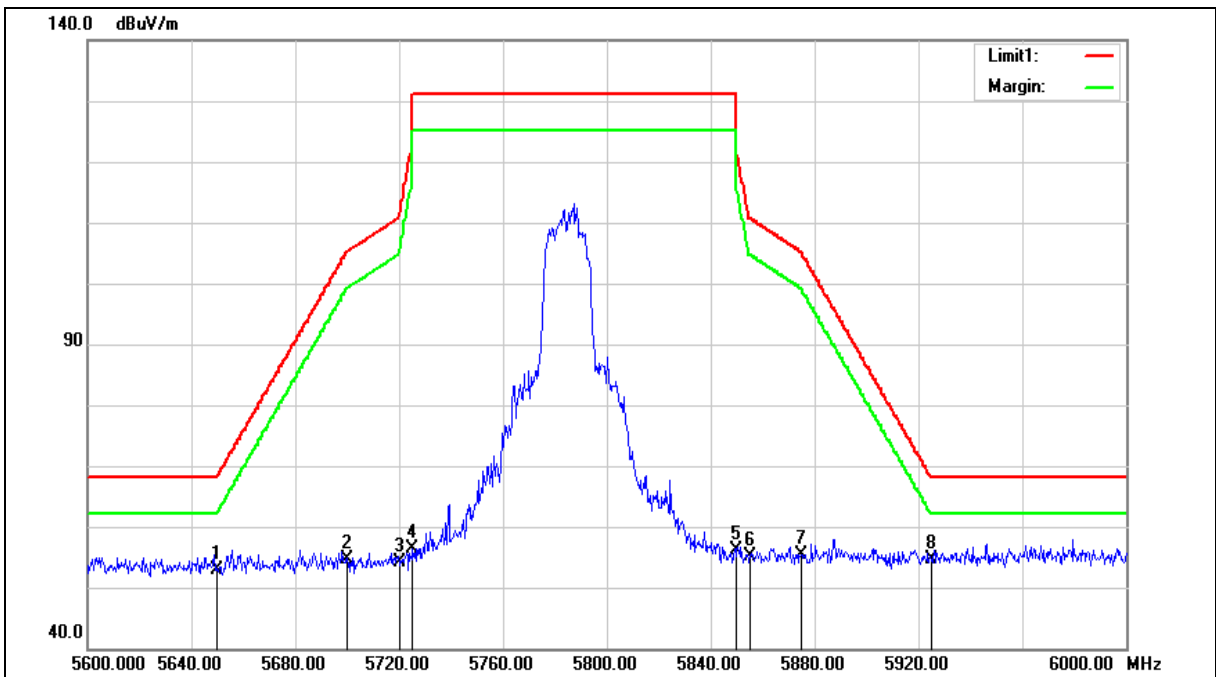



Standard:	FCC Part 15.407	Test Distance:	3 m
Test item:	Band edge	Power:	AC 120 V/60 Hz
Frequency:	5785 MHz	Temp.(°C)/Hum.(%RH):	26(°C)/60 %RH
Mode:	Mode 3		
Ant.Polar.:	Vertical		

No.	Frequency (MHz)	Reading (dBuV)	Correct Factor (dB/m)	Result (dBuV/m)	Limit (dBuV/m)	Margin (dB)	Remark
1	5650.000	46.25	6.61	52.86	68.20	-15.34	peak
2	5700.000	48.04	6.71	54.75	105.20	-50.45	peak
3	5720.000	47.33	6.77	54.10	110.80	-56.70	peak
4	5725.000	49.52	6.78	56.30	122.20	-65.90	peak
5	5850.000	49.03	7.03	56.06	122.20	-66.14	peak
6	5855.000	47.97	7.04	55.01	110.80	-55.79	peak
7	5875.000	48.35	7.09	55.44	105.20	-49.76	peak
8	5925.000	47.47	7.20	54.67	68.20	-13.53	peak

Note:1.Result (dBuV/m) = Correct Factor (dB/m) + Reading(dBuV).

2.Correction factor (dB/m) = Antenna Factor (dB/m) + Cable loss (dB) – Pre-Amplifier gain (dB).

3.When the peak results are less than average limit, so not need to evaluate the average.



Standard:	FCC Part 15.407	Test Distance:	3 m
Test item:	Band edge	Power:	AC 120 V/60 Hz
Frequency:	5825 MHz	Temp.(°C)/Hum.(%RH):	26(°C)/60 %RH
Mode:	Mode 3		
Ant.Polar.:	Horizontal		

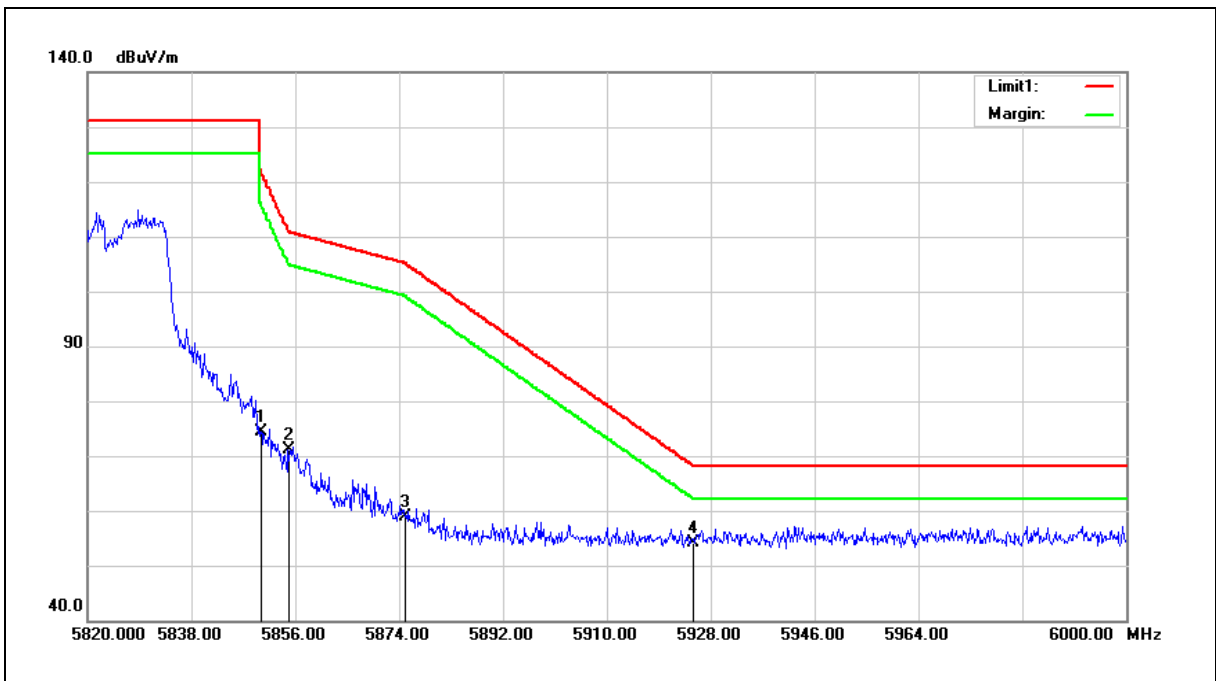

No.	Frequency (MHz)	Reading (dBuV)	Correct Factor (dB/m)	Result (dBuV/m)	Limit (dBuV/m)	Margin (dB)	Remark
1	5850.000	67.32	7.03	74.35	122.20	-47.85	peak
2	5855.000	64.01	7.04	71.05	110.80	-39.75	peak
3	5875.000	51.67	7.09	58.76	105.20	-46.44	peak
4	5925.000	46.82	7.20	54.02	68.20	-14.18	peak

Note:1.Result (dBuV/m) = Correct Factor (dB/m) + Reading(dBuV).

2.Correction factor (dB/m) = Antenna Factor (dB/m) + Cable loss (dB) – Pre-Amplifier gain (dB).

3.When the peak results are less than average limit, so not need to evaluate the average.



Standard:	FCC Part 15.407	Test Distance:	3 m
Test item:	Band edge	Power:	AC 120 V/60 Hz
Frequency:	5825 MHz	Temp.(°C)/Hum.(%RH):	26(°C)/60 %RH
Mode:	Mode 3		
Ant.Polar.:	Vertical		

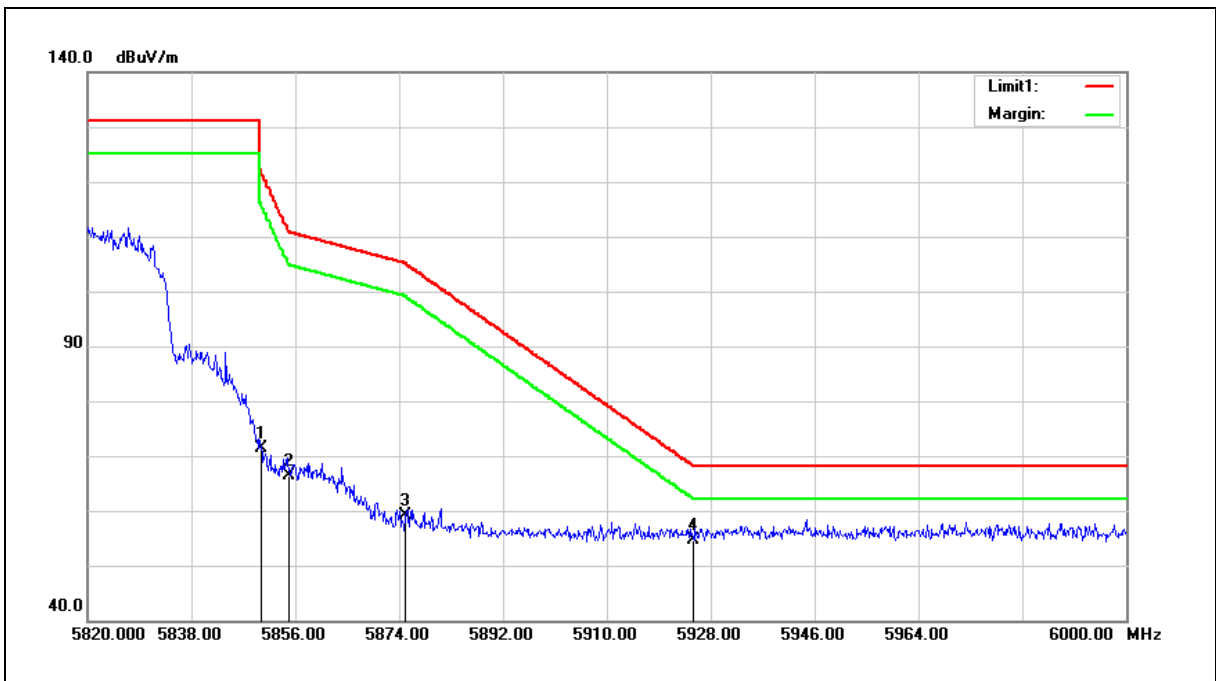

No.	Frequency (MHz)	Reading (dBuV)	Correct Factor (dB/m)	Result (dBuV/m)	Limit (dBuV/m)	Margin (dB)	Remark
1	5850.000	64.37	7.03	71.40	122.20	-50.80	peak
2	5855.000	59.36	7.04	66.40	110.80	-44.40	peak
3	5875.000	51.96	7.09	59.05	105.20	-46.15	peak
4	5925.000	47.49	7.20	54.69	68.20	-13.51	peak

Note:1.Result (dBuV/m) = Correct Factor (dB/m) + Reading(dBuV).

2.Correction factor (dB/m) = Antenna Factor (dB/m) + Cable loss (dB) – Pre-Amplifier gain (dB).

3.When the peak results are less than average limit, so not need to evaluate the average.



Standard:	FCC Part 15.407	Test Distance:	3 m
Test item:	Band edge	Power:	AC 120 V/60 Hz
Frequency:	5190 MHz	Temp.(°C)/Hum.(%RH):	26(°C)/60 %RH
Mode:	Mode 4		
Ant.Polar.:	Horizontal		

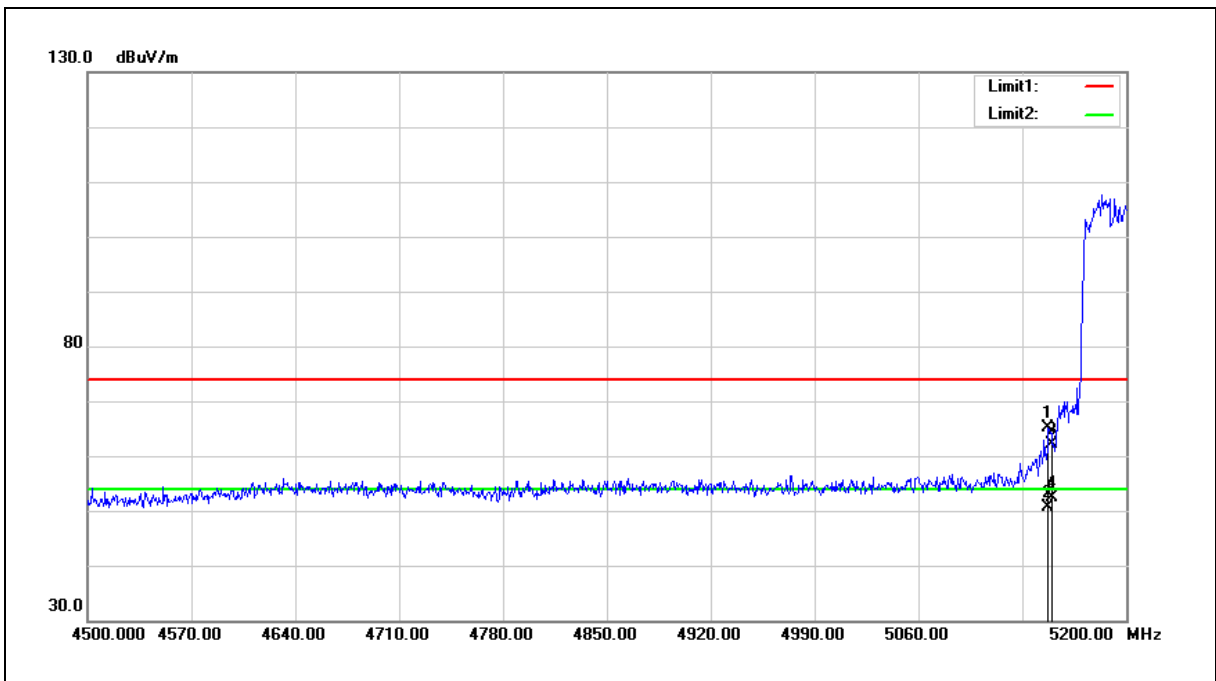

No.	Frequency (MHz)	Reading (dBuV)	Correct Factor (dB/m)	Result (dBuV/m)	Limit (dBuV/m)	Margin (dB)	Remark
1	5147.500	59.38	5.77	65.15	74.00	-8.85	peak
2	5147.500	44.89	5.77	50.66	54.00	-3.34	AVG
3	5150.000	56.41	5.78	62.19	74.00	-11.81	peak
4	5150.000	46.60	5.78	52.38	54.00	-1.62	AVG

- Note:1.Result (dBuV/m) = Correct Factor (dB/m) + Reading(dBuV).
- 2.Correction factor (dB/m) = Antenna Factor (dB/m) + Cable loss (dB) – Pre-Amplifier gain (dB).
- 3.When the peak results are less than average limit, so not need to evaluate the average.



Standard:	FCC Part 15.407	Test Distance:	3 m
Test item:	Band edge	Power:	AC 120 V/60 Hz
Frequency:	5190 MHz	Temp.(°C)/Hum.(%RH):	26(°C)/60 %RH
Mode:	Mode 4		
Ant.Polar.:	Vertical		

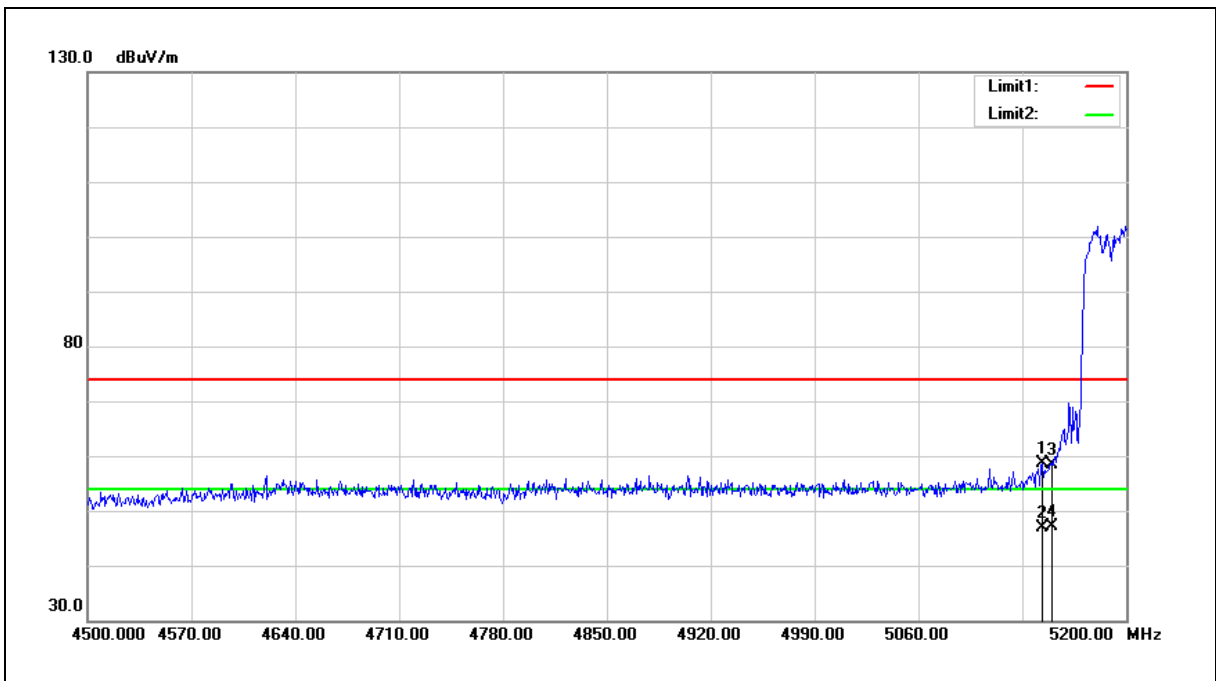

No.	Frequency (MHz)	Reading (dBuV)	Correct Factor (dB/m)	Result (dBuV/m)	Limit (dBuV/m)	Margin (dB)	Remark
1	5143.300	52.90	5.77	58.67	74.00	-15.33	peak
2	5143.300	41.07	5.77	46.84	54.00	-7.16	AVG
3	5150.000	52.68	5.78	58.46	74.00	-15.54	peak
4	5150.000	41.45	5.78	47.23	54.00	-6.77	AVG

Note:1.Result (dBuV/m) = Correct Factor (dB/m) + Reading(dBuV).

2.Correction factor (dB/m) = Antenna Factor (dB/m) + Cable loss (dB) – Pre-Amplifier gain (dB).

3.When the peak results are less than average limit, so not need to evaluate the average.



Standard:	FCC Part 15.407	Test Distance:	3 m
Test item:	Band edge	Power:	AC 120 V/60 Hz
Frequency:	5230 MHz	Temp.(°C)/Hum.(%RH):	26(°C)/60 %RH
Mode:	Mode 4		
Ant.Polar.:	Horizontal		

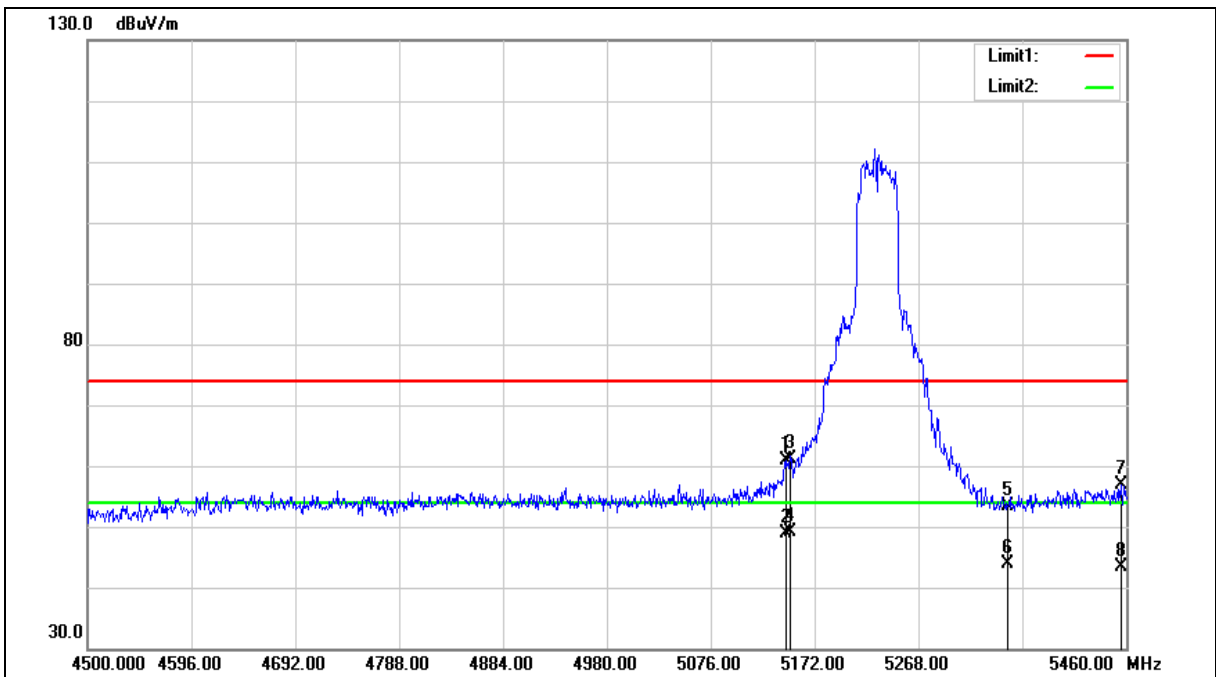





Standard:	FCC Part 15.407	Test Distance:	3 m
Test item:	Band edge	Power:	AC 120 V/60 Hz
Frequency:	5230 MHz	Temp.(°C)/Hum.(%RH):	26(°C)/60 %RH
Mode:	Mode 4		
Ant.Polar.:	Horizontal		

No.	Frequency (MHz)	Reading (dBuV)	Correct Factor (dB/m)	Result (dBuV/m)	Limit (dBuV/m)	Margin (dB)	Remark
1	5145.120	55.18	5.77	60.95	74.00	-13.05	peak
2	5145.120	43.03	5.77	48.80	54.00	-5.20	AVG
3	5150.000	55.44	5.78	61.22	74.00	-12.78	peak
4	5150.000	43.46	5.78	49.24	54.00	-4.76	AVG
5	5350.000	47.33	6.07	53.40	74.00	-20.60	peak
6	5350.000	37.89	6.07	43.96	54.00	-10.04	AVG
7	5455.200	50.69	6.22	56.91	74.00	-17.09	peak
8	5455.200	37.19	6.22	43.41	54.00	-10.59	AVG

Note:1.Result (dBuV/m) = Correct Factor (dB/m) + Reading(dBuV).

2.Correction factor (dB/m) = Antenna Factor (dB/m) + Cable loss (dB) – Pre-Amplifier gain (dB).

3.When the peak results are less than average limit, so not need to evaluate the average.



Standard:	FCC Part 15.407	Test Distance:	3 m
Test item:	Band edge	Power:	AC 120 V/60 Hz
Frequency:	5230 MHz	Temp.(°C)/Hum.(%RH):	26(°C)/60 %RH
Mode:	Mode 4		
Ant.Polar.:	Vertical		

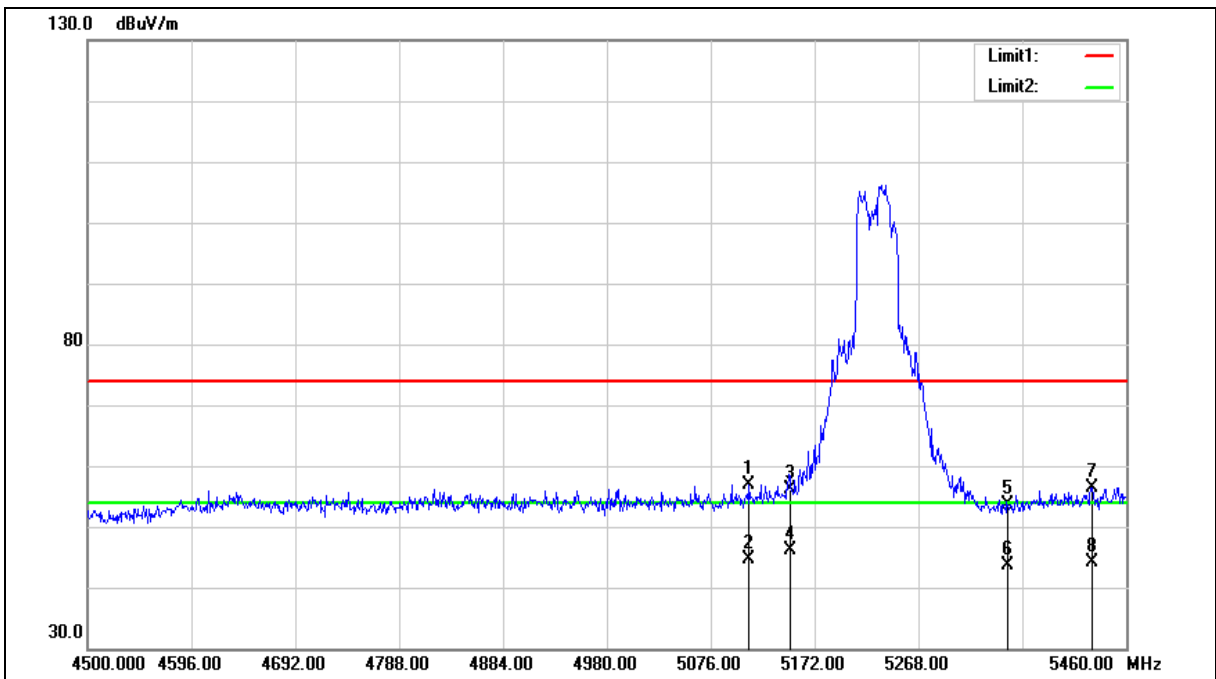



Standard:	FCC Part 15.407	Test Distance:	3 m
Test item:	Band edge	Power:	AC 120 V/60 Hz
Frequency:	5230 MHz	Temp.(°C)/Hum.(%RH):	26(°C)/60 %RH
Mode:	Mode 4		
Ant.Polar.:	Vertical		

No.	Frequency (MHz)	Reading (dBuV)	Correct Factor (dB/m)	Result (dBuV/m)	Limit (dBuV/m)	Margin (dB)	Remark
1	5111.520	51.26	5.72	56.98	74.00	-17.02	peak
2	5111.520	38.96	5.72	44.68	54.00	-9.32	AVG
3	5150.000	50.34	5.78	56.12	74.00	-17.88	peak
4	5150.000	40.28	5.78	46.06	54.00	-7.94	AVG
5	5350.000	47.50	6.07	53.57	74.00	-20.43	peak
6	5350.000	37.52	6.07	43.59	54.00	-10.41	AVG
7	5428.320	50.26	6.19	56.45	74.00	-17.55	peak
8	5428.320	37.89	6.19	44.08	54.00	-9.92	AVG

Note:1.Result (dBuV/m) = Correct Factor (dB/m) + Reading(dBuV).

2.Correction factor (dB/m) = Antenna Factor (dB/m) + Cable loss (dB) – Pre-Amplifier gain (dB).

3.When the peak results are less than average limit, so not need to evaluate the average.



Standard:	FCC Part 15.407	Test Distance:	3 m
Test item:	Band edge	Power:	AC 120 V/60 Hz
Frequency:	5755 MHz	Temp.(°C)/Hum.(%RH):	26(°C)/60 %RH
Mode:	Mode 4		
Ant.Polar.:	Horizontal		

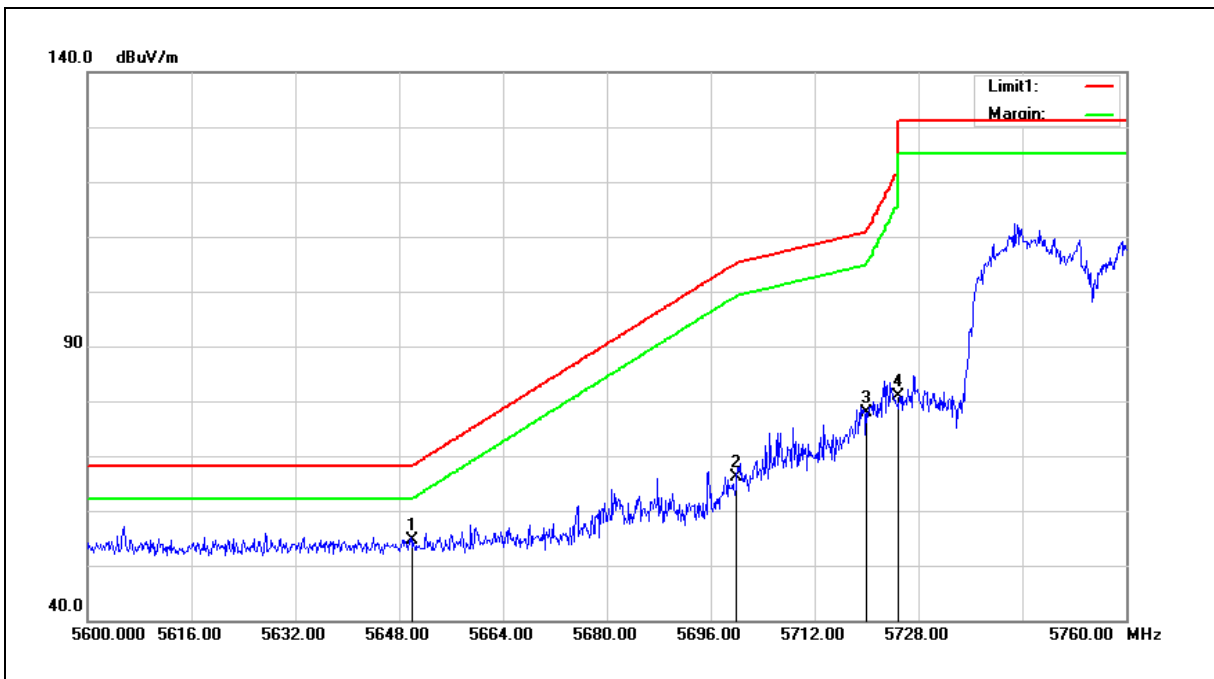

No.	Frequency (MHz)	Reading (dBuV)	Correct Factor (dB/m)	Result (dBuV/m)	Limit (dBuV/m)	Margin (dB)	Remark
1	5650.000	48.13	6.61	54.74	68.20	-13.46	peak
2	5700.000	59.46	6.71	66.17	105.20	-39.03	peak
3	5720.000	71.22	6.77	77.99	110.80	-32.81	peak
4	5725.000	74.01	6.78	80.79	122.20	-41.41	peak

Note:1.Result (dBuV/m) = Correct Factor (dB/m) + Reading(dBuV).

2.Correction factor (dB/m) = Antenna Factor (dB/m) + Cable loss (dB) – Pre-Amplifier gain (dB).

3.When the peak results are less than average limit, so not need to evaluate the average.



Standard:	FCC Part 15.407	Test Distance:	3 m
Test item:	Band edge	Power:	AC 120 V/60 Hz
Frequency:	5755 MHz	Temp.(°C)/Hum.(%RH):	26(°C)/60 %RH
Mode:	Mode 4		
Ant.Polar.:	Vertical		

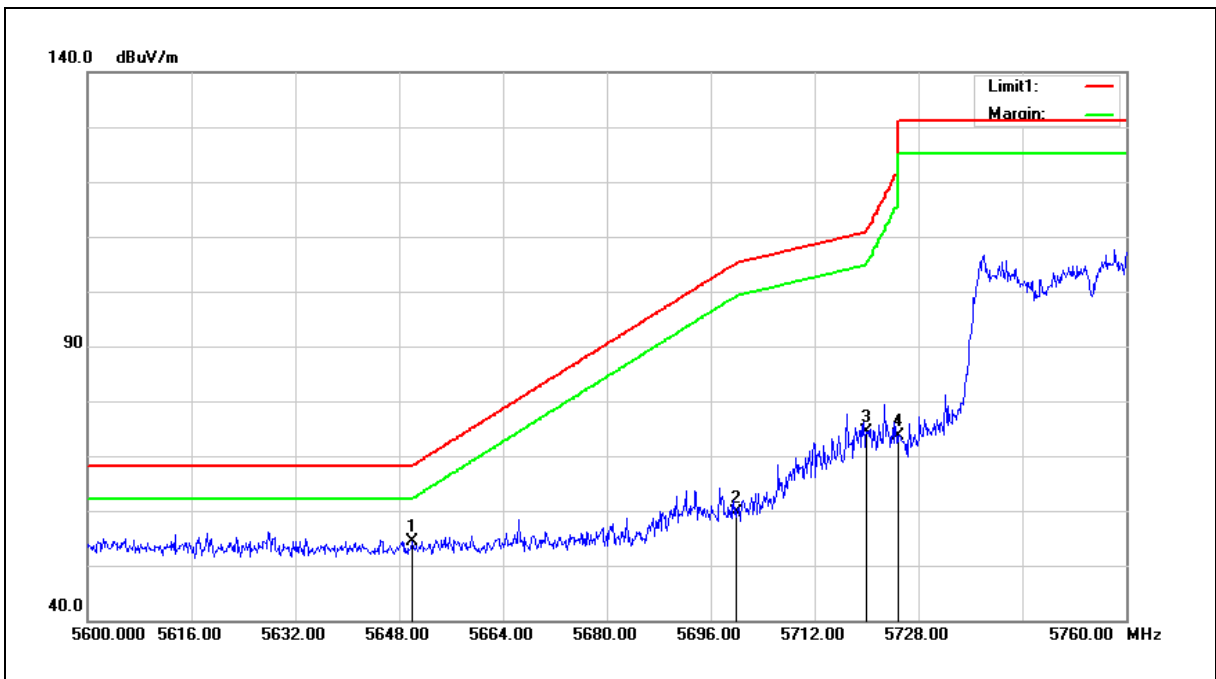

No.	Frequency (MHz)	Reading (dBuV)	Correct Factor (dB/m)	Result (dBuV/m)	Limit (dBuV/m)	Margin (dB)	Remark
1	5650.000	47.67	6.61	54.28	68.20	-13.92	peak
2	5700.000	52.87	6.71	59.58	105.20	-45.62	peak
3	5720.000	67.60	6.77	74.37	110.80	-36.43	peak
4	5725.000	66.97	6.78	73.75	122.20	-48.45	peak

Note:1.Result (dBuV/m) = Correct Factor (dB/m) + Reading(dBuV).

2.Correction factor (dB/m) = Antenna Factor (dB/m) + Cable loss (dB) – Pre-Amplifier gain (dB).

3.When the peak results are less than average limit, so not need to evaluate the average.



Standard:	FCC Part 15.407	Test Distance:	3 m
Test item:	Band edge	Power:	AC 120 V/60 Hz
Frequency:	5795 MHz	Temp.(°C)/Hum.(%RH):	26(°C)/60 %RH
Mode:	Mode 4		
Ant.Polar.:	Horizontal		

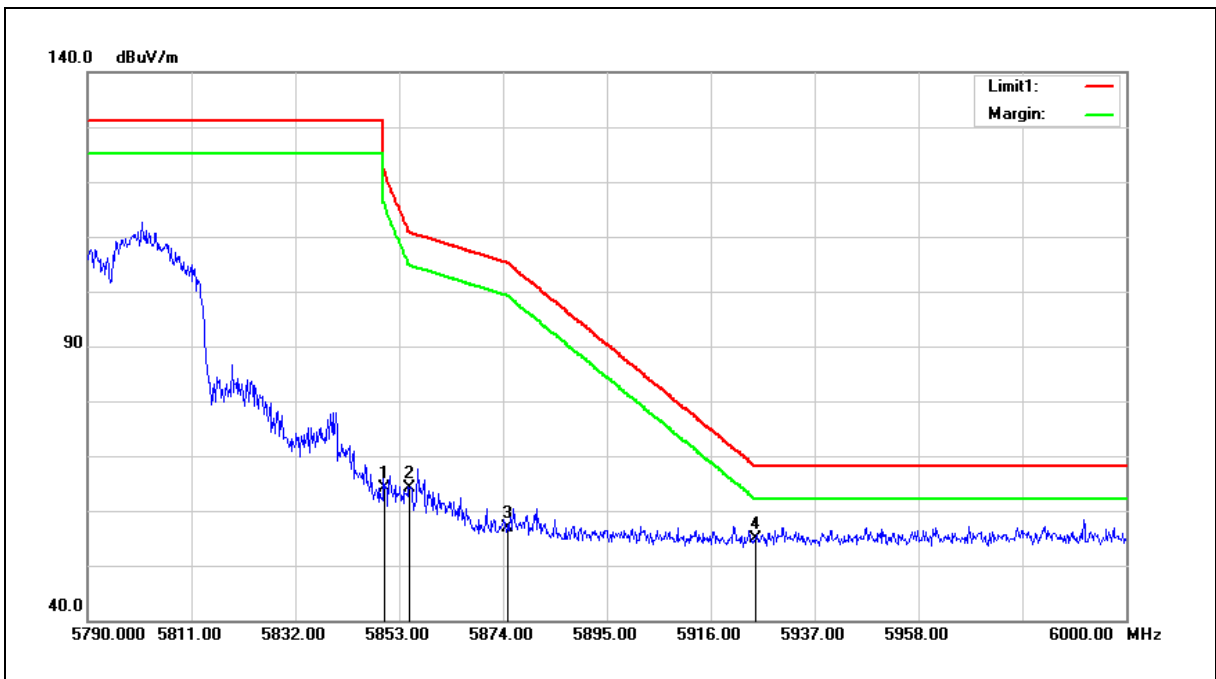

No.	Frequency (MHz)	Reading (dBuV)	Correct Factor (dB/m)	Result (dBuV/m)	Limit (dBuV/m)	Margin (dB)	Remark
1	5850.000	57.11	7.03	64.14	122.20	-58.06	peak
2	5855.000	56.98	7.04	64.02	110.80	-46.78	peak
3	5875.000	49.68	7.09	56.77	105.20	-48.43	peak
4	5925.000	47.71	7.20	54.91	68.20	-13.29	peak

- Note:1.Result (dBuV/m) = Correct Factor (dB/m) + Reading(dBuV).  
 2.Correction factor (dB/m) = Antenna Factor (dB/m) + Cable loss (dB) – Pre-Amplifier gain (dB).  
 3.When the peak results are less than average limit, so not need to evaluate the average.



Standard:	FCC Part 15.407	Test Distance:	3 m
Test item:	Band edge	Power:	AC 120 V/60 Hz
Frequency:	5795 MHz	Temp.(°C)/Hum.(%RH):	26(°C)/60 %RH
Mode:	Mode 4		
Ant.Polar.:	Vertical		

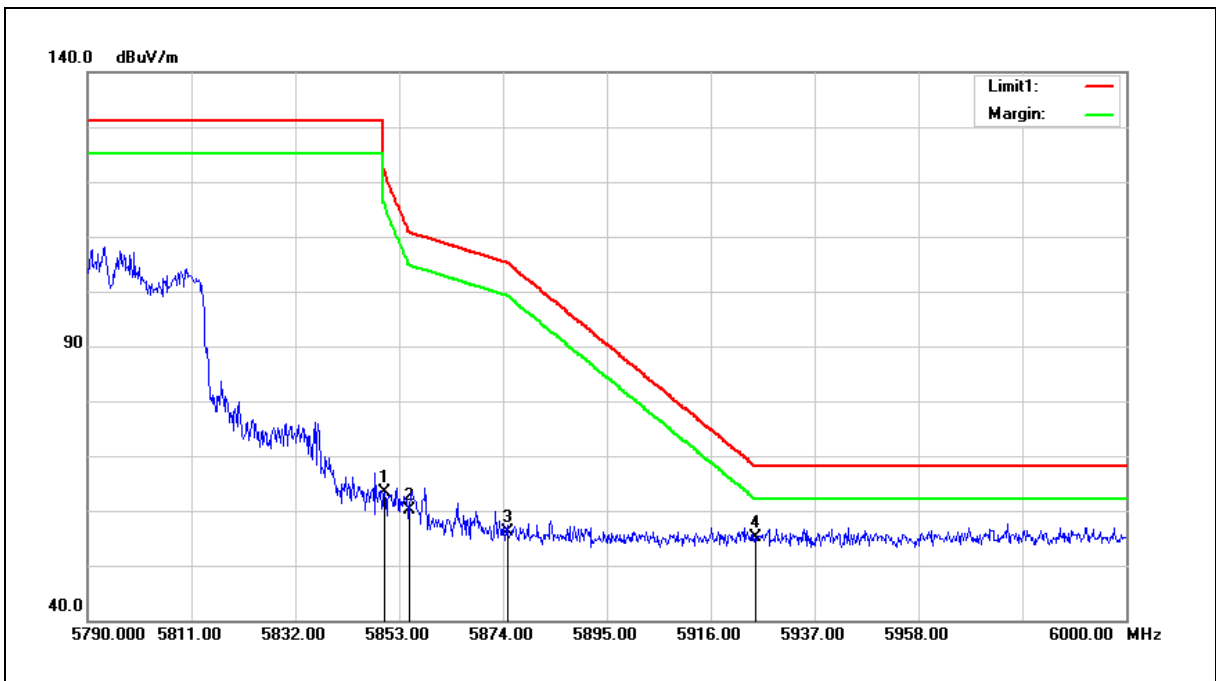

No.	Frequency (MHz)	Reading (dBuV)	Correct Factor (dB/m)	Result (dBuV/m)	Limit (dBuV/m)	Margin (dB)	Remark
1	5850.000	56.40	7.03	63.43	122.20	-58.77	peak
2	5855.000	53.21	7.04	60.25	110.80	-50.55	peak
3	5875.000	49.09	7.09	56.18	105.20	-49.02	peak
4	5925.000	47.84	7.20	55.04	68.20	-13.16	peak

Note:1.Result (dBuV/m) = Correct Factor (dB/m) + Reading(dBuV).

2.Correction factor (dB/m) = Antenna Factor (dB/m) + Cable loss (dB) – Pre-Amplifier gain (dB).

3.When the peak results are less than average limit, so not need to evaluate the average.



Standard:	FCC Part 15.407	Test Distance:	3 m
Test item:	Band edge	Power:	AC 120 V/60 Hz
Frequency:	5210 MHz	Temp.(°C)/Hum.(%RH):	26(°C)/60 %RH
Mode:	Mode 5		
Ant.Polar.:	Horizontal		

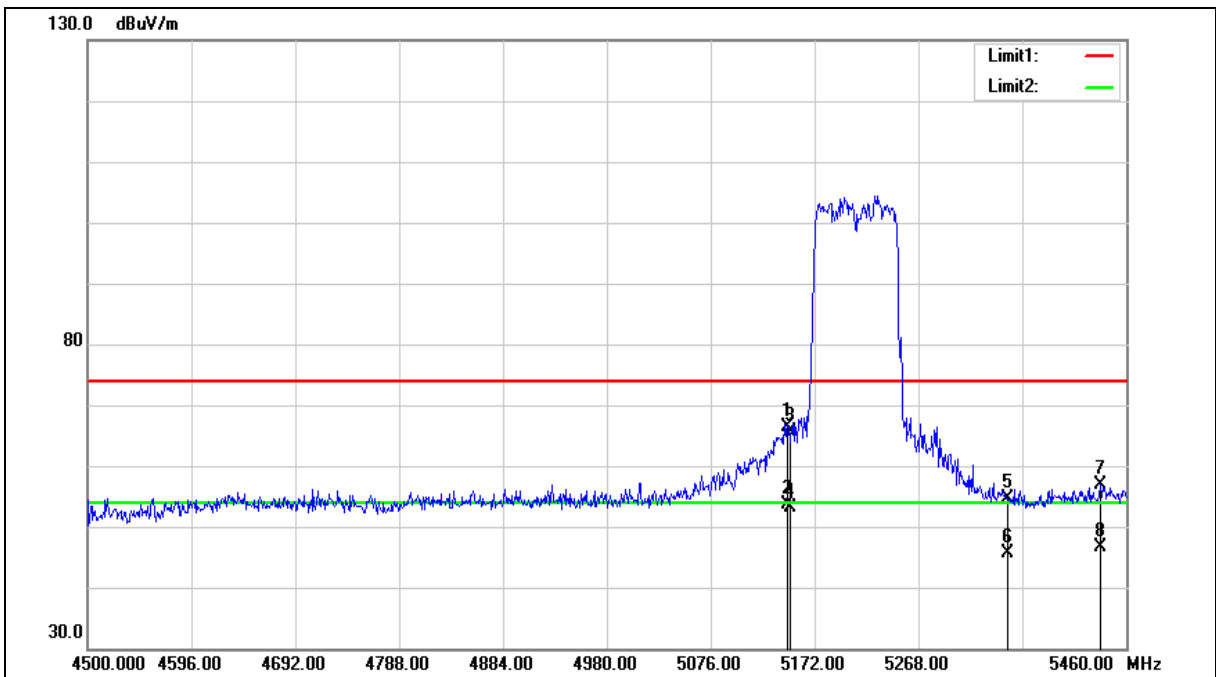





Standard:	FCC Part 15.407	Test Distance:	3 m
Test item:	Band edge	Power:	AC 120 V/60 Hz
Frequency:	5210 MHz	Temp.(°C)/Hum.(%RH):	26(°C)/60 %RH
Mode:	Mode 5		
Ant.Polar.:	Horizontal		

No.	Frequency (MHz)	Reading (dBuV)	Correct Factor (dB/m)	Result (dBuV/m)	Limit (dBuV/m)	Margin (dB)	Remark
1	5147.590	60.59	5.77	66.36	74.00	-7.64	peak
2	5147.590	47.88	5.77	53.65	54.00	-0.35	AVG
3	5150.000	59.85	5.78	65.63	74.00	-8.37	peak
4	5150.000	47.46	5.78	53.24	54.00	-0.76	AVG
5	5350.000	48.55	6.07	54.62	74.00	-19.38	peak
6	5350.000	39.46	6.07	45.53	54.00	-8.47	AVG
7	5436.000	50.78	6.20	56.98	74.00	-17.02	peak
8	5436.000	40.41	6.20	46.61	54.00	-7.39	AVG

Note:1.Result (dBuV/m) = Correct Factor (dB/m) + Reading(dBuV).

2.Correction factor (dB/m) = Antenna Factor (dB/m) + Cable loss (dB) – Pre-Amplifier gain (dB).

3.When the peak results are less than average limit, so not need to evaluate the average.



Standard:	FCC Part 15.407	Test Distance:	3 m
Test item:	Band edge	Power:	AC 120 V/60 Hz
Frequency:	5210 MHz	Temp.(°C)/Hum.(%RH):	26(°C)/60 %RH
Mode:	Mode 5		
Ant.Polar.:	Vertical		

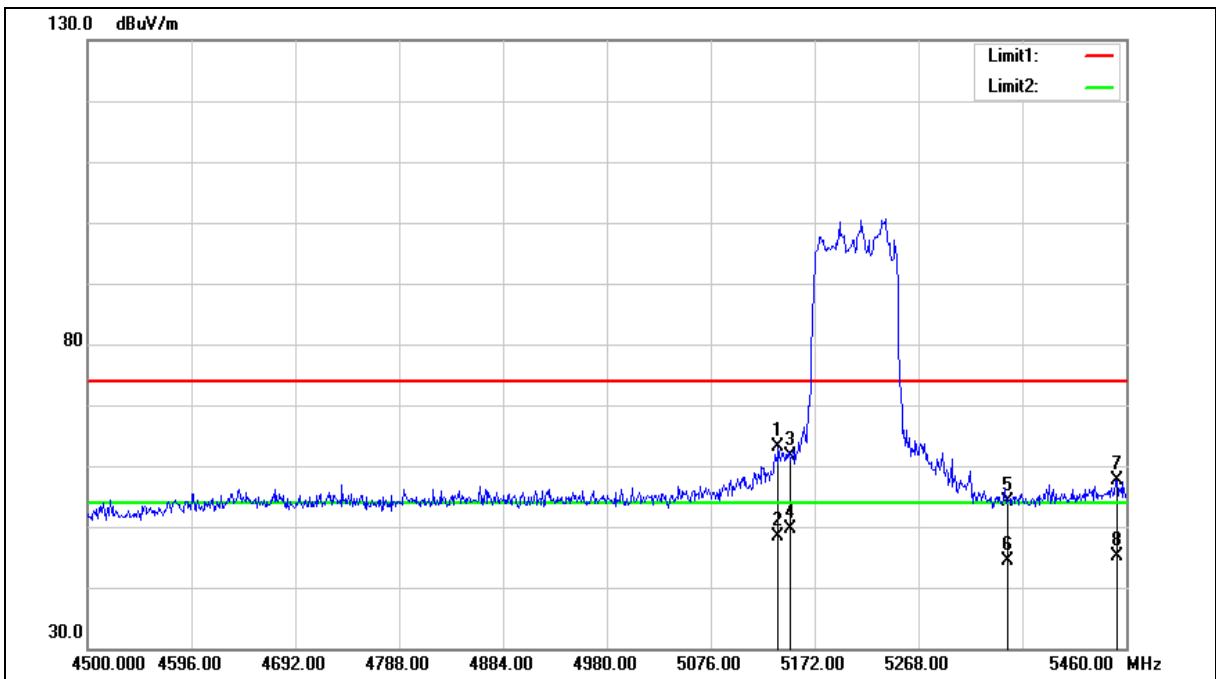



Standard:	FCC Part 15.407	Test Distance:	3 m
Test item:	Band edge	Power:	AC 120 V/60 Hz
Frequency:	5210 MHz	Temp.(°C)/Hum.(%RH):	26(°C)/60 %RH
Mode:	Mode 5		
Ant.Polar.:	Vertical		

No.	Frequency (MHz)	Reading (dBuV)	Correct Factor (dB/m)	Result (dBuV/m)	Limit (dBuV/m)	Margin (dB)	Remark
1	5138.400	57.44	5.76	63.20	74.00	-10.80	peak
2	5138.400	42.73	5.76	48.49	54.00	-5.51	AVG
3	5150.000	55.75	5.78	61.53	74.00	-12.47	peak
4	5150.000	43.94	5.78	49.72	54.00	-4.28	AVG
5	5350.000	47.95	6.07	54.02	74.00	-19.98	peak
6	5350.000	38.37	6.07	44.44	54.00	-9.56	AVG
7	5451.360	51.47	6.22	57.69	74.00	-16.31	peak
8	5451.360	39.01	6.22	45.23	54.00	-8.77	AVG

Note:1.Result (dBuV/m) = Correct Factor (dB/m) + Reading(dBuV).

2.Correction factor (dB/m) = Antenna Factor (dB/m) + Cable loss (dB) – Pre-Amplifier gain (dB).

3.When the peak results are less than average limit, so not need to evaluate the average.



Standard:	FCC Part 15.407	Test Distance:	3 m
Test item:	Band edge	Power:	AC 120 V/60 Hz
Frequency:	5775 MHz	Temp.(°C)/Hum.(%RH):	26(°C)/60 %RH
Mode:	Mode 5		
Ant.Polar.:	Horizontal		

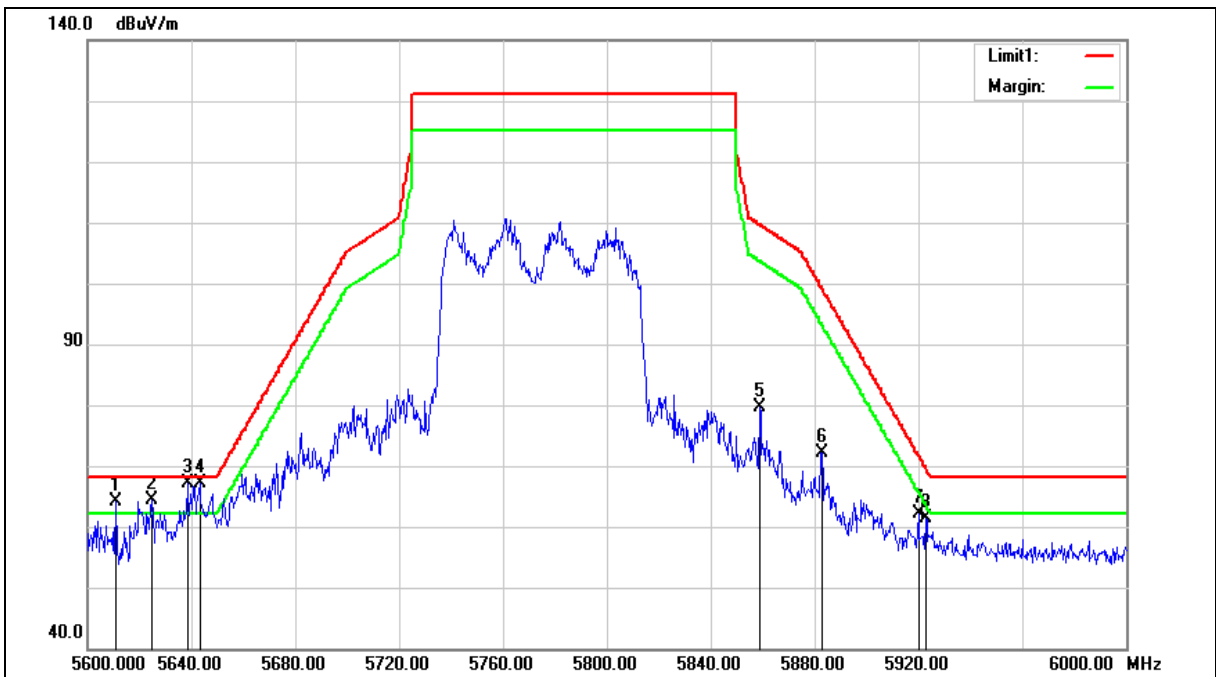



Standard:	FCC Part 15.407	Test Distance:	3 m
Test item:	Band edge	Power:	AC 120 V/60 Hz
Frequency:	5775 MHz	Temp.(°C)/Hum.(%RH):	26(°C)/60 %RH
Mode:	Mode 5		
Ant.Polar.:	Horizontal		

No.	Frequency (MHz)	Reading (dBuV)	Correct Factor (dB/m)	Result (dBuV/m)	Limit (dBuV/m)	Margin (dB)	Remark
1	5610.800	57.58	6.53	64.11	68.20	-4.09	peak
2	5624.800	57.73	6.55	64.28	68.20	-3.92	peak
3	5638.400	60.49	6.58	67.07	68.20	-1.13	peak
4	5643.200	60.64	6.59	67.23	68.20	-0.97	peak
5	5858.800	72.56	7.05	79.61	109.74	-30.13	peak
6	5882.800	64.97	7.10	72.07	99.43	-27.36	peak
7	5920.000	54.96	7.19	62.15	71.90	-9.75	peak
8	5922.800	54.12	7.19	61.31	69.83	-8.52	peak

Note:1.Result (dBuV/m) = Correct Factor (dB/m) + Reading(dBuV).

2.Correction factor (dB/m) = Antenna Factor (dB/m) + Cable loss (dB) – Pre-Amplifier gain (dB).

3.When the peak results are less than average limit, so not need to evaluate the average.



Standard:	FCC Part 15.407	Test Distance:	3 m
Test item:	Band edge	Power:	AC 120 V/60 Hz
Frequency:	5775 MHz	Temp.(°C)/Hum.(%RH):	26(°C)/60 %RH
Mode:	Mode 5		
Ant.Polar.:	Vertical		

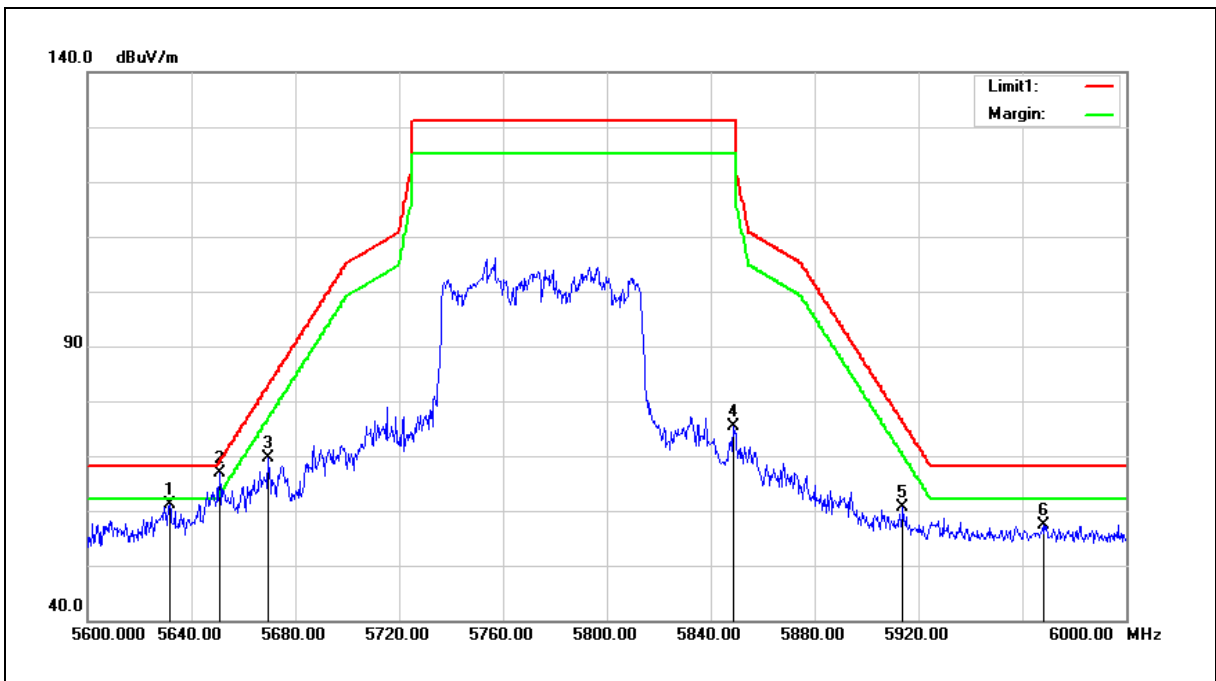

No.	Frequency (MHz)	Reading (dBuV)	Correct Factor (dB/m)	Result (dBuV/m)	Limit (dBuV/m)	Margin (dB)	Remark
1	5631.600	54.54	6.57	61.11	68.20	-7.09	peak
2	5650.800	60.18	6.61	66.79	68.79	-2.00	peak
3	5669.600	62.91	6.65	69.56	82.70	-13.14	peak
4	5848.800	68.42	7.03	75.45	131.20	-55.75	peak
5	5914.000	53.35	7.17	60.52	76.34	-15.82	peak
6	5968.000	50.07	7.29	57.36	68.20	-10.84	peak

Note:1.Result (dBuV/m) = Correct Factor (dB/m) + Reading(dBuV).

2.Correction factor (dB/m) = Antenna Factor (dB/m) + Cable loss (dB) – Pre-Amplifier gain (dB).

3.When the peak results are less than average limit, so not need to evaluate the average.



Beamforming on

Above 1GHz

Standard:	FCC Part 15.407	Test Distance:	3 m
Test item:	Harmonic	Power:	AC 120 V/60 Hz
Frequency:	5180 MHz	Temp.(°C)/Hum.(%RH):	26(°C)/60 %RH
Mode:	Mode 3		
Ant.Polar.:	Horizontal		

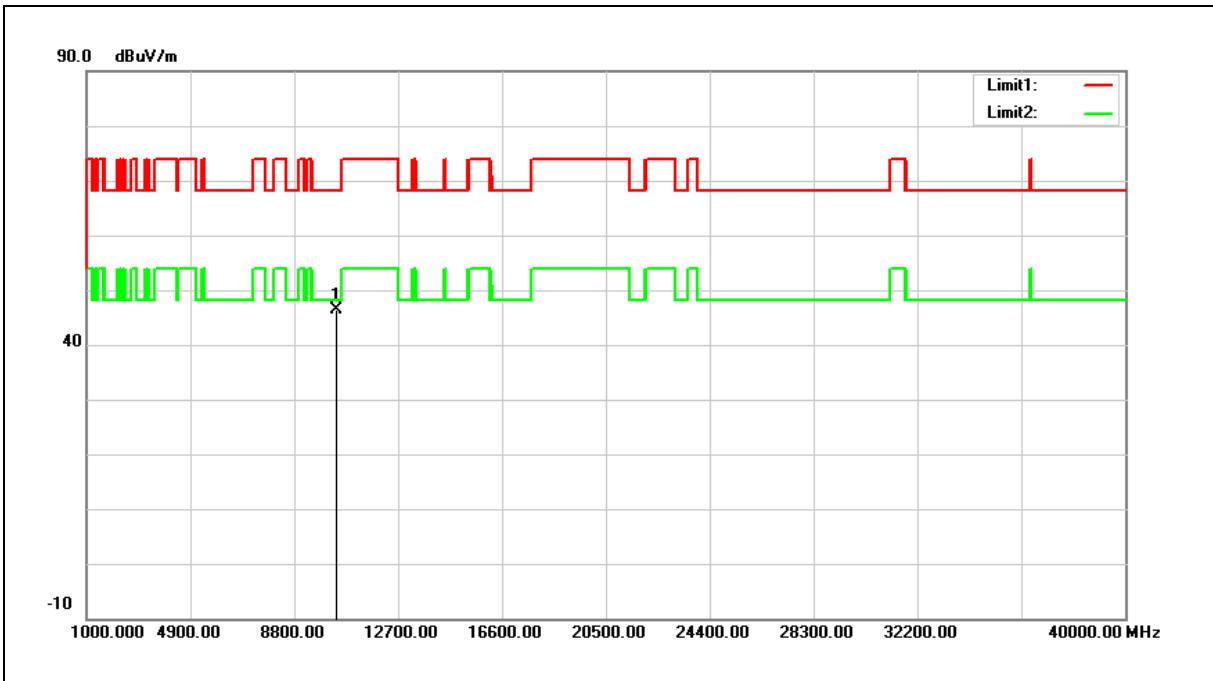

No.	Frequency (MHz)	Reading (dBuV)	Correct Factor (dB/m)	Result (dBuV/m)	Limit (dBuV/m)	Margin (dB)	Remark
1	10360.000	30.18	16.09	46.27	68.20	-21.93	peak

Note:1.Result (dBuV/m) = Correct Factor (dB/m) + Reading(dBuV).

2.Correction factor (dB/m) = Antenna Factor (dB/m) + Cable loss (dB) – Pre-Amplifier gain (dB).

3.When the peak results are less than average limit, so not need to evaluate the average.



Standard:	FCC Part 15.407	Test Distance:	3 m
Test item:	Harmonic	Power:	AC 120 V/60 Hz
Frequency:	5180 MHz	Temp.(°C)/Hum.(%RH):	26(°C)/60 %RH
Mode:	Mode 3		
Ant.Polar.:	Vertical		

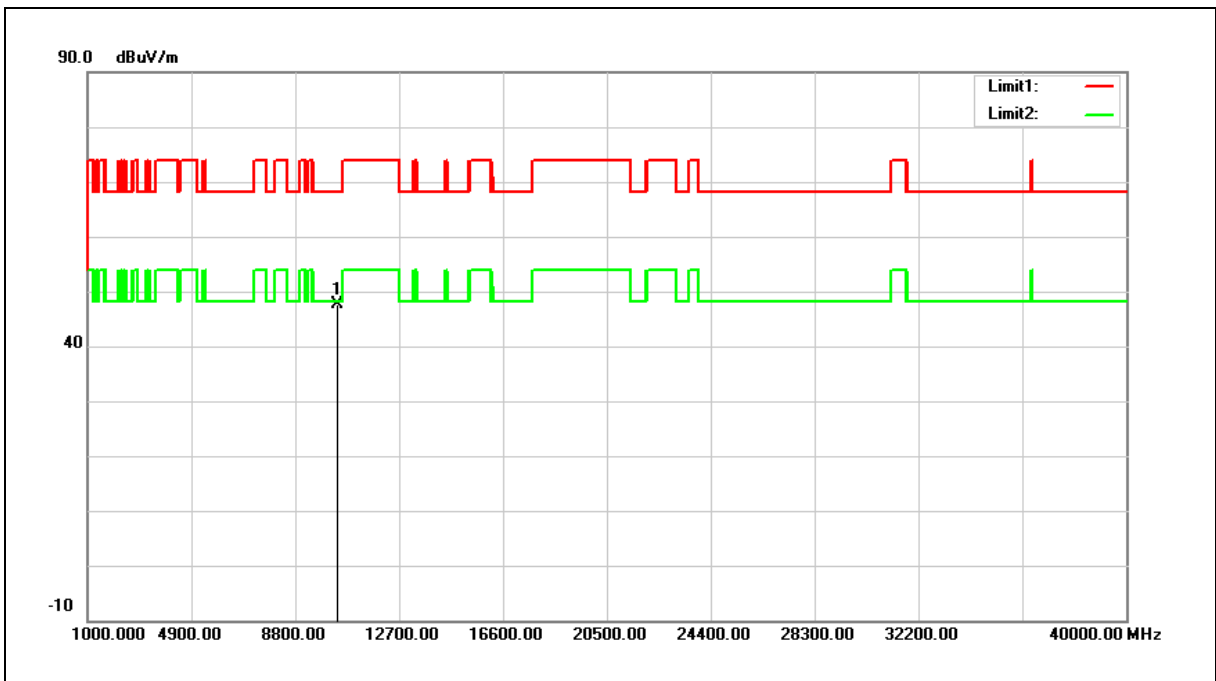

No.	Frequency (MHz)	Reading (dBuV)	Correct Factor (dB/m)	Result (dBuV/m)	Limit (dBuV/m)	Margin (dB)	Remark
1	10360.000	31.42	16.09	47.51	68.20	-20.69	peak

- Note:1.Result (dBuV/m) = Correct Factor (dB/m) + Reading(dBuV).  
 2.Correction factor (dB/m) = Antenna Factor (dB/m) + Cable loss (dB) – Pre-Amplifier gain (dB).  
 3.When the peak results are less than average limit, so not need to evaluate the average.





Standard:	FCC Part 15.407	Test Distance:	3 m
Test item:	Harmonic	Power:	AC 120 V/60 Hz
Frequency:	5200 MHz	Temp.(°C)/Hum.(%RH):	26(°C)/60 %RH
Mode:	Mode 3		
Ant.Polar.:	Horizontal		

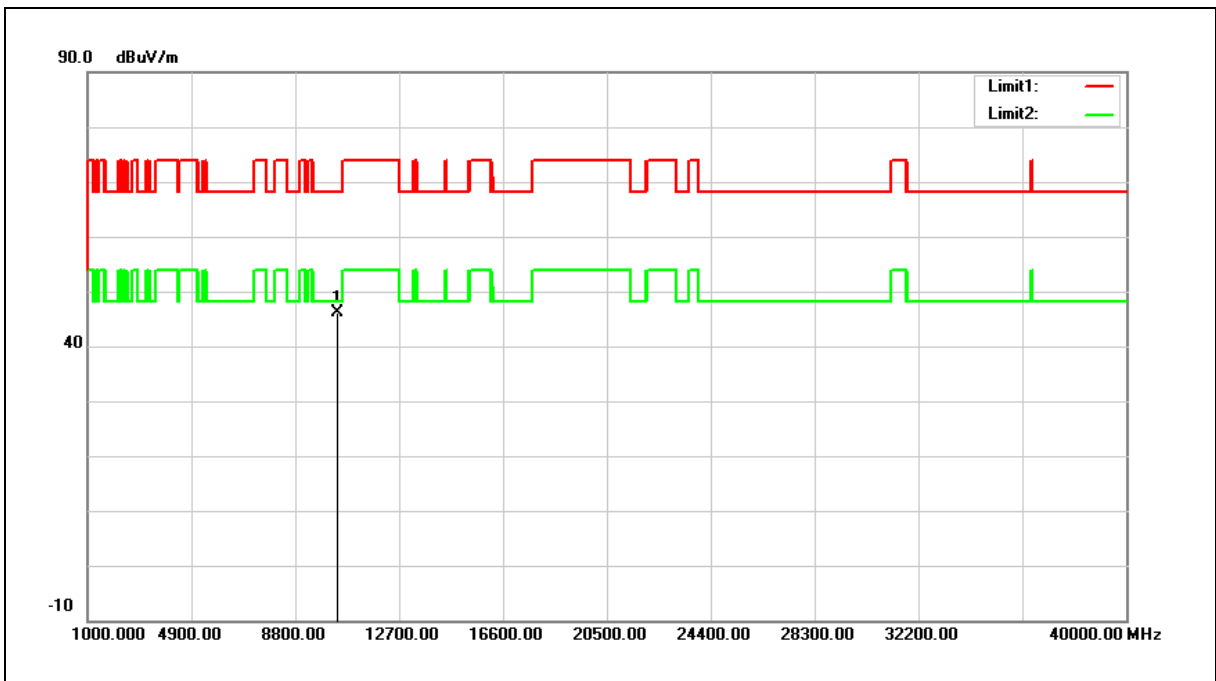

No.	Frequency (MHz)	Reading (dBuV)	Correct Factor (dB/m)	Result (dBuV/m)	Limit (dBuV/m)	Margin (dB)	Remark
1	10400.000	29.97	16.22	46.19	68.20	-22.01	peak

Note:1.Result (dBuV/m) = Correct Factor (dB/m) + Reading(dBuV).

2.Correction factor (dB/m) = Antenna Factor (dB/m) + Cable loss (dB) – Pre-Amplifier gain (dB).

3.When the peak results are less than average limit, so not need to evaluate the average.



Standard:	FCC Part 15.407	Test Distance:	3 m
Test item:	Harmonic	Power:	AC 120 V/60 Hz
Frequency:	5200 MHz	Temp.(°C)/Hum.(%RH):	26(°C)/60 %RH
Mode:	Mode 3		
Ant.Polar.:	Vertical		

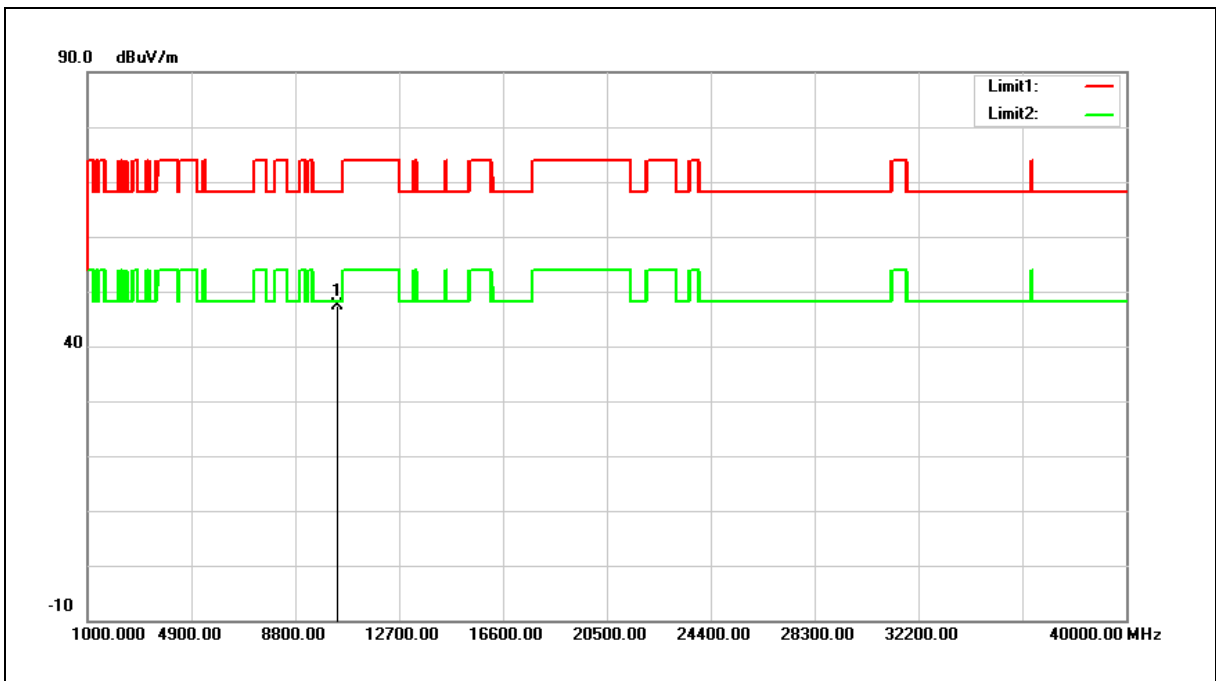

No.	Frequency (MHz)	Reading (dBuV)	Correct Factor (dB/m)	Result (dBuV/m)	Limit (dBuV/m)	Margin (dB)	Remark
1	10400.000	31.04	16.22	47.26	68.20	-20.94	peak

- Note:1.Result (dBuV/m) = Correct Factor (dB/m) + Reading(dBuV).  
 2.Correction factor (dB/m) = Antenna Factor (dB/m) + Cable loss (dB) – Pre-Amplifier gain (dB).  
 3.When the peak results are less than average limit, so not need to evaluate the average.



Standard:	FCC Part 15.407	Test Distance:	3 m
Test item:	Harmonic	Power:	AC 120 V/60 Hz
Frequency:	5240 MHz	Temp.(°C)/Hum.(%RH):	26(°C)/60 %RH
Mode:	Mode 3		
Ant.Polar.:	Horizontal		

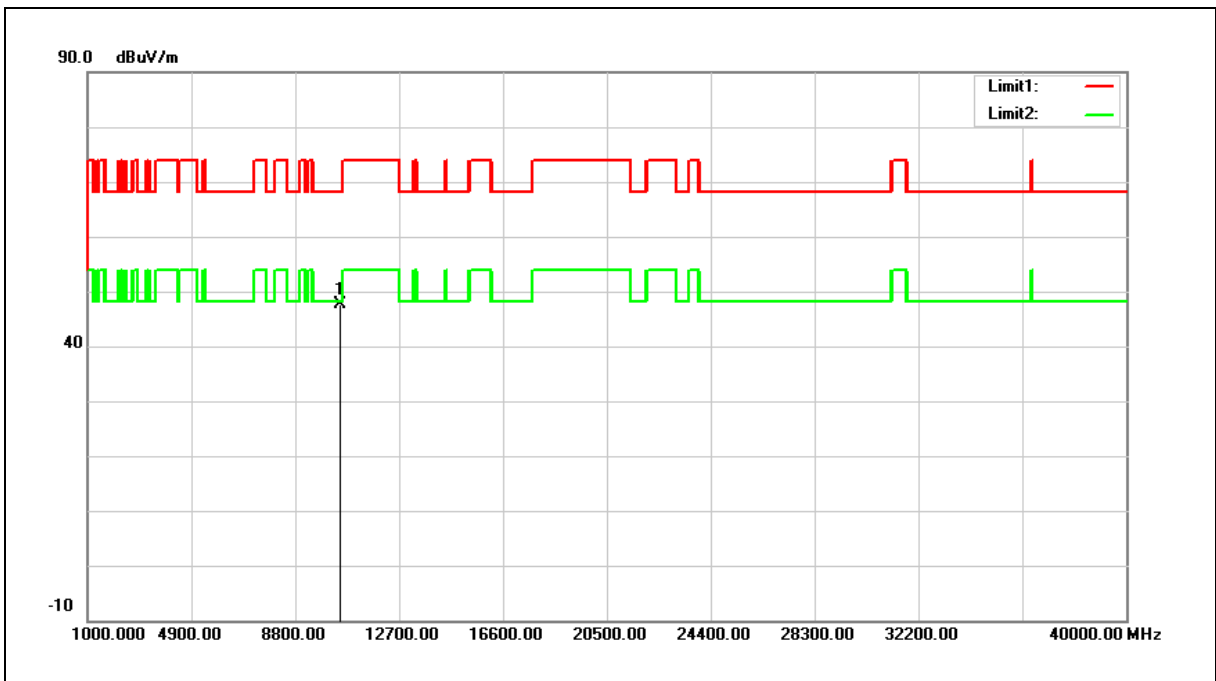

No.	Frequency (MHz)	Reading (dBuV)	Correct Factor (dB/m)	Result (dBuV/m)	Limit (dBuV/m)	Margin (dB)	Remark
1	10480.000	31.11	16.47	47.58	68.20	-20.62	peak

- Note:1.Result (dBuV/m) = Correct Factor (dB/m) + Reading(dBuV).  
 2.Correction factor (dB/m) = Antenna Factor (dB/m) + Cable loss (dB) – Pre-Amplifier gain (dB).  
 3.When the peak results are less than average limit, so not need to evaluate the average.



Standard:	FCC Part 15.407	Test Distance:	3 m
Test item:	Harmonic	Power:	AC 120 V/60 Hz
Frequency:	5240 MHz	Temp.(°C)/Hum.(%RH):	26(°C)/60 %RH
Mode:	Mode 3		
Ant.Polar.:	Vertical		

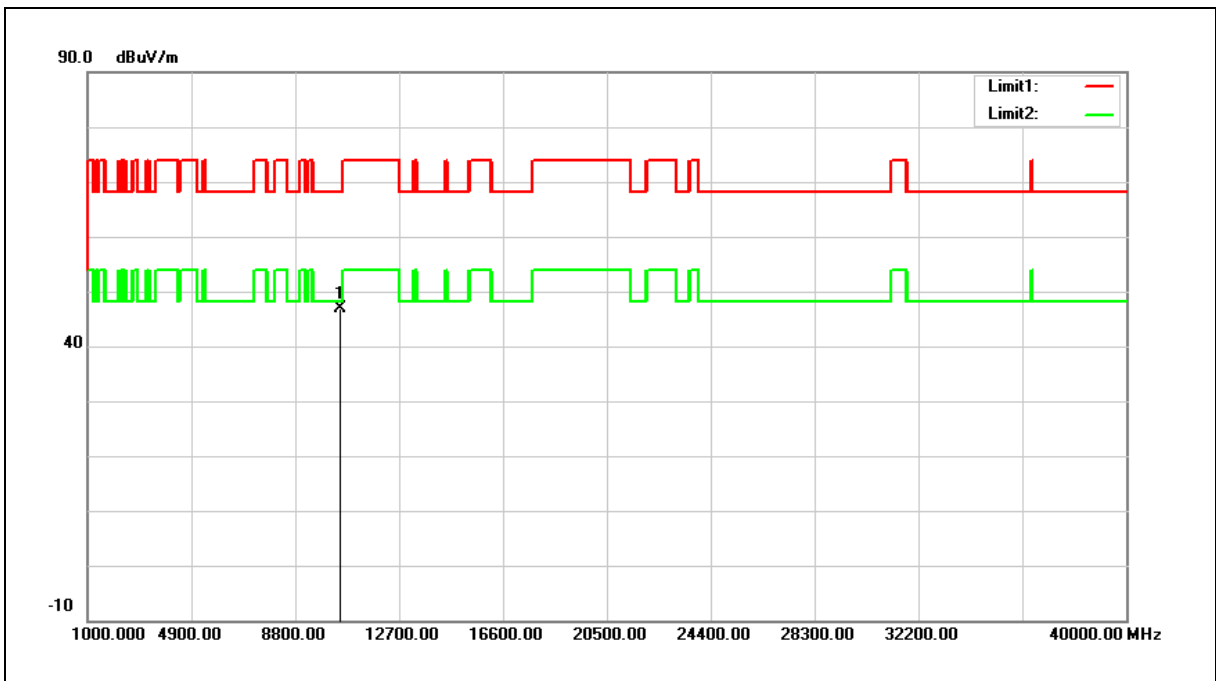

No.	Frequency (MHz)	Reading (dBuV)	Correct Factor (dB/m)	Result (dBuV/m)	Limit (dBuV/m)	Margin (dB)	Remark
1	10480.000	30.41	16.47	46.88	68.20	-21.32	peak

Note:1.Result (dBuV/m) = Correct Factor (dB/m) + Reading(dBuV).

2.Correction factor (dB/m) = Antenna Factor (dB/m) + Cable loss (dB) – Pre-Amplifier gain (dB).

3.When the peak results are less than average limit, so not need to evaluate the average.



Standard:	FCC Part 15.407	Test Distance:	3 m
Test item:	Harmonic	Power:	AC 120 V/60 Hz
Frequency:	5745 MHz	Temp.(°C)/Hum.(%RH):	26(°C)/60 %RH
Mode:	Mode 3		
Ant.Polar.:	Horizontal		

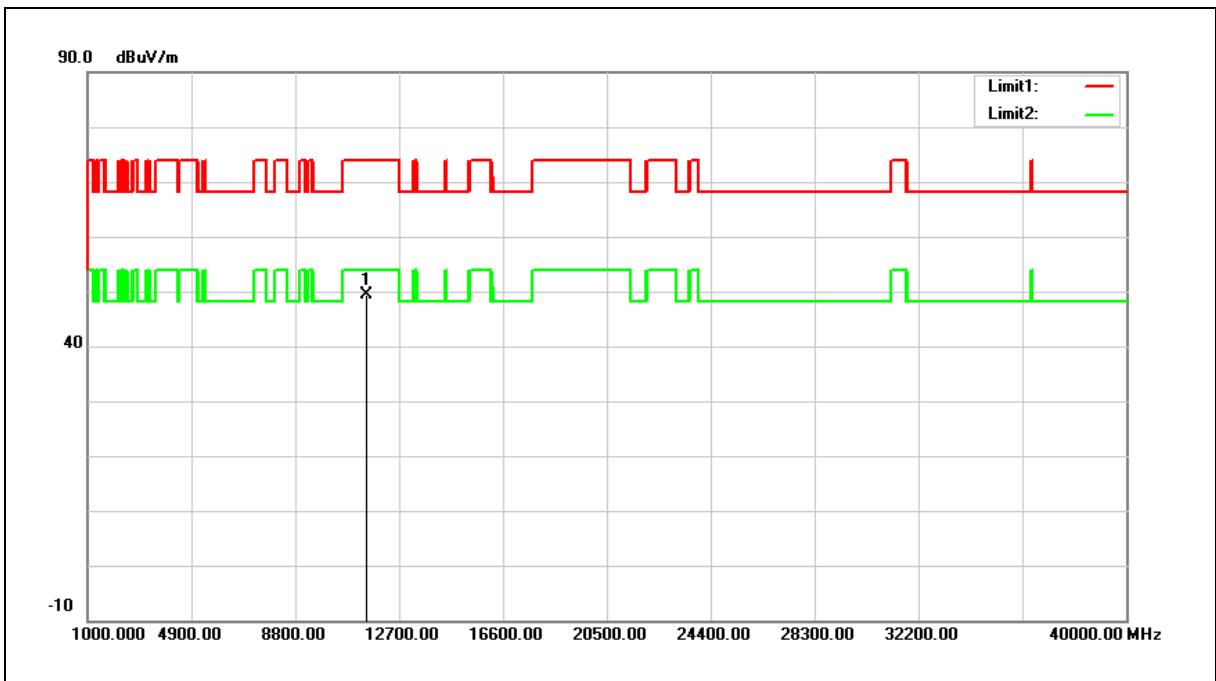

No.	Frequency (MHz)	Reading (dBuV)	Correct Factor (dB/m)	Result (dBuV/m)	Limit (dBuV/m)	Margin (dB)	Remark
1	11490.000	31.24	18.11	49.35	74.00	-24.65	peak

Note:1.Result (dBuV/m) = Correct Factor (dB/m) + Reading(dBuV).

2.Correction factor (dB/m) = Antenna Factor (dB/m) + Cable loss (dB) – Pre-Amplifier gain (dB).

3.When the peak results are less than average limit, so not need to evaluate the average.



Standard:	FCC Part 15.407	Test Distance:	3 m
Test item:	Harmonic	Power:	AC 120 V/60 Hz
Frequency:	5745 MHz	Temp.(°C)/Hum.(%RH):	26(°C)/60 %RH
Mode:	Mode 3		
Ant.Polar.:	Vertical		

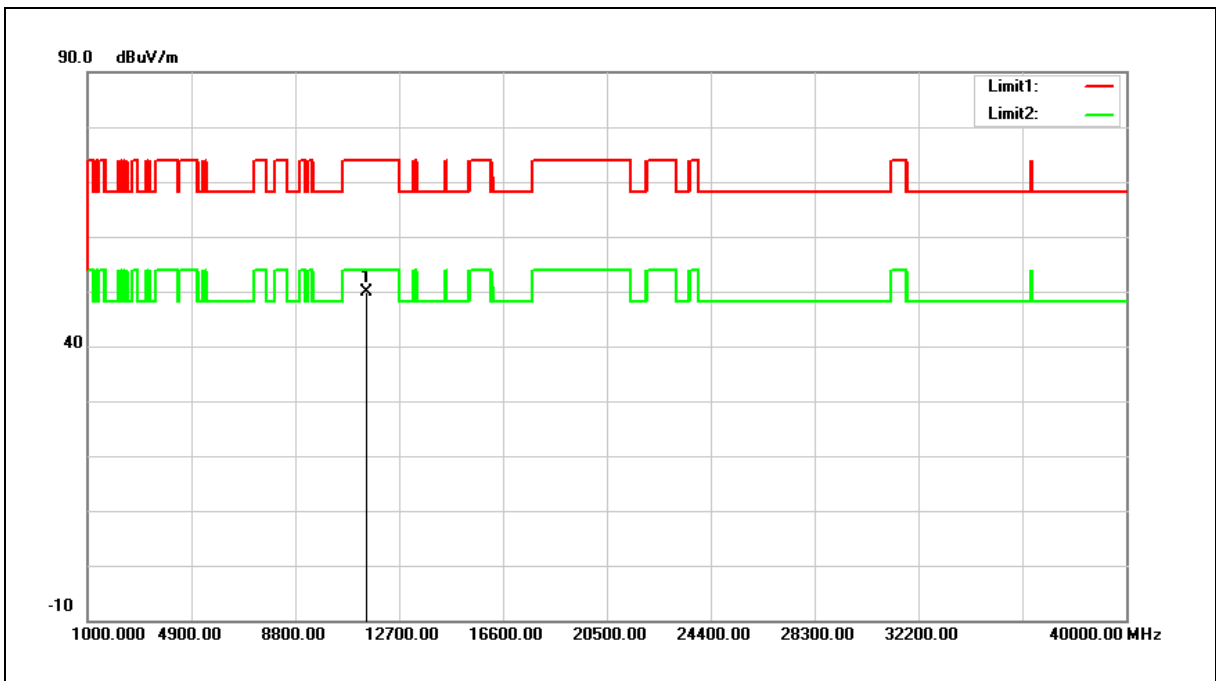

No.	Frequency (MHz)	Reading (dBuV)	Correct Factor (dB/m)	Result (dBuV/m)	Limit (dBuV/m)	Margin (dB)	Remark
1	11490.000	31.83	18.11	49.94	74.00	-24.06	peak

Note:1.Result (dBuV/m) = Correct Factor (dB/m) + Reading(dBuV).

2.Correction factor (dB/m) = Antenna Factor (dB/m) + Cable loss (dB) – Pre-Amplifier gain (dB).

3.When the peak results are less than average limit, so not need to evaluate the average.



Standard:	FCC Part 15.407	Test Distance:	3 m
Test item:	Harmonic	Power:	AC 120 V/60 Hz
Frequency:	5785 MHz	Temp.(°C)/Hum.(%RH):	26(°C)/60 %RH
Mode:	Mode 3		
Ant.Polar.:	Horizontal		

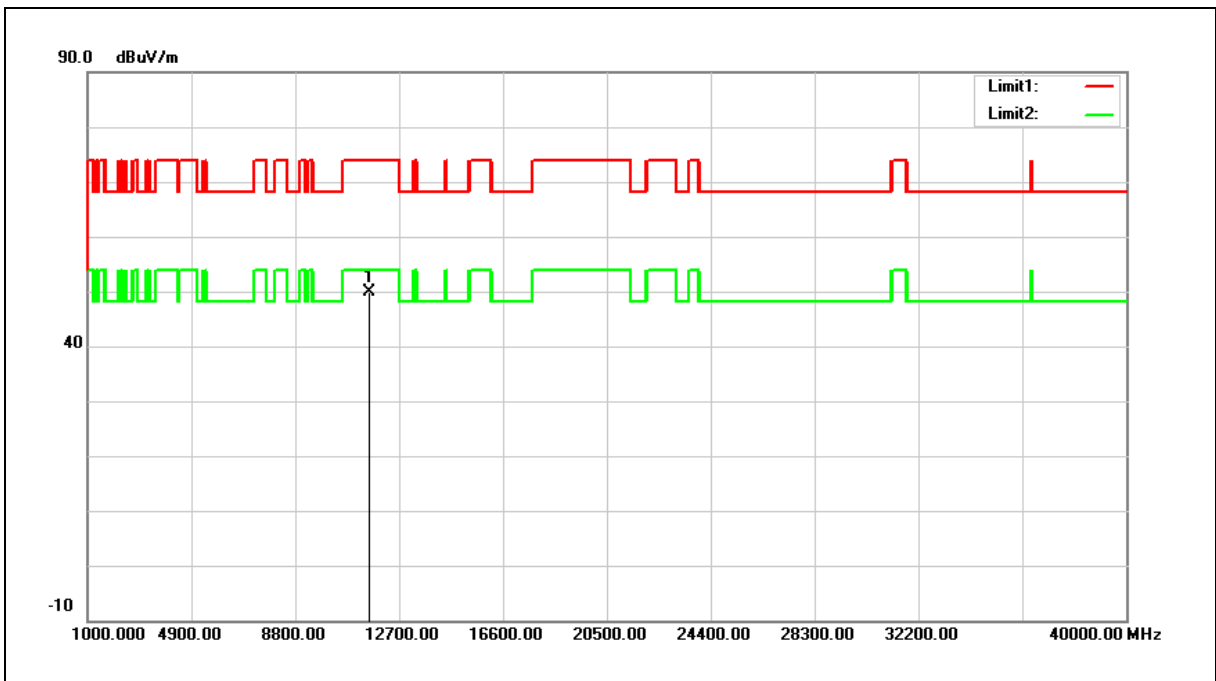

No.	Frequency (MHz)	Reading (dBuV)	Correct Factor (dB/m)	Result (dBuV/m)	Limit (dBuV/m)	Margin (dB)	Remark
1	11570.000	31.75	18.03	49.78	74.00	-24.22	peak

Note:1.Result (dBuV/m) = Correct Factor (dB/m) + Reading(dBuV).

2.Correction factor (dB/m) = Antenna Factor (dB/m) + Cable loss (dB) – Pre-Amplifier gain (dB).

3.When the peak results are less than average limit, so not need to evaluate the average.



Standard:	FCC Part 15.407	Test Distance:	3 m
Test item:	Harmonic	Power:	AC 120 V/60 Hz
Frequency:	5785 MHz	Temp.(°C)/Hum.(%RH):	26(°C)/60 %RH
Mode:	Mode 3		
Ant.Polar.:	Vertical		

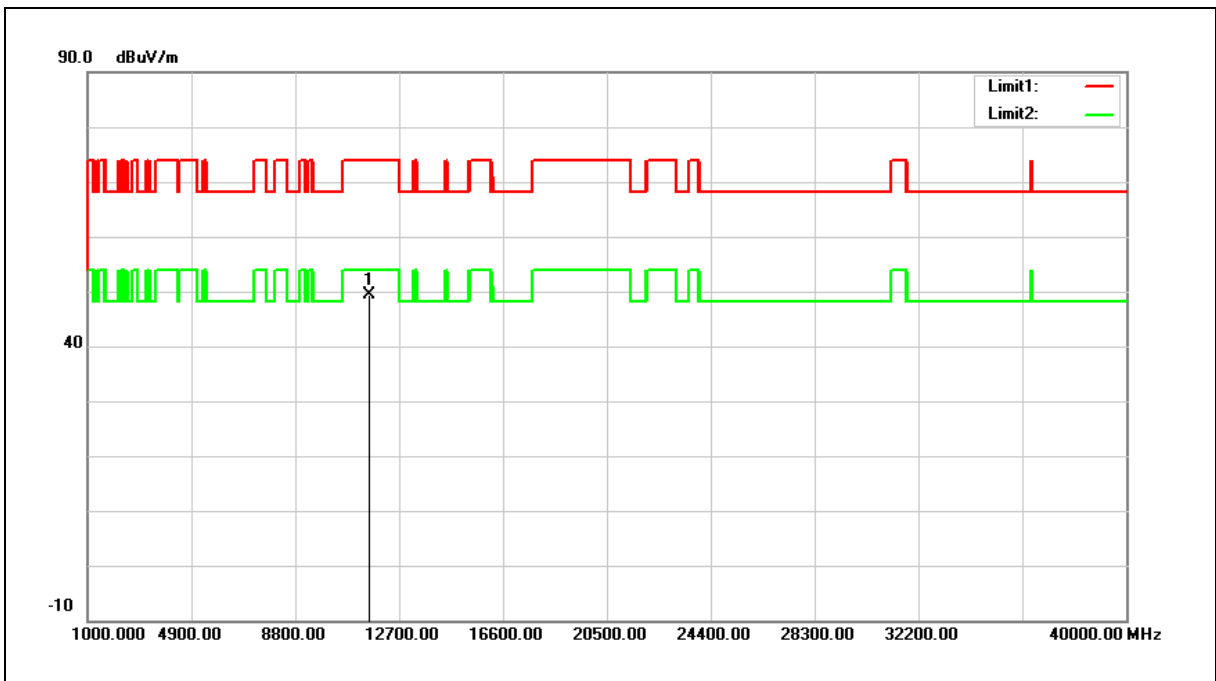

No.	Frequency (MHz)	Reading (dBuV)	Correct Factor (dB/m)	Result (dBuV/m)	Limit (dBuV/m)	Margin (dB)	Remark
1	11570.000	31.46	18.03	49.49	74.00	-24.51	peak

- Note:1.Result (dBuV/m) = Correct Factor (dB/m) + Reading(dBuV).
- 2.Correction factor (dB/m) = Antenna Factor (dB/m) + Cable loss (dB) – Pre-Amplifier gain (dB).
- 3.When the peak results are less than average limit, so not need to evaluate the average.





Standard:	FCC Part 15.407	Test Distance:	3 m
Test item:	Harmonic	Power:	AC 120 V/60 Hz
Frequency:	5825 MHz	Temp.(°C)/Hum.(%RH):	26(°C)/60 %RH
Mode:	Mode 3		
Ant.Polar.:	Horizontal		

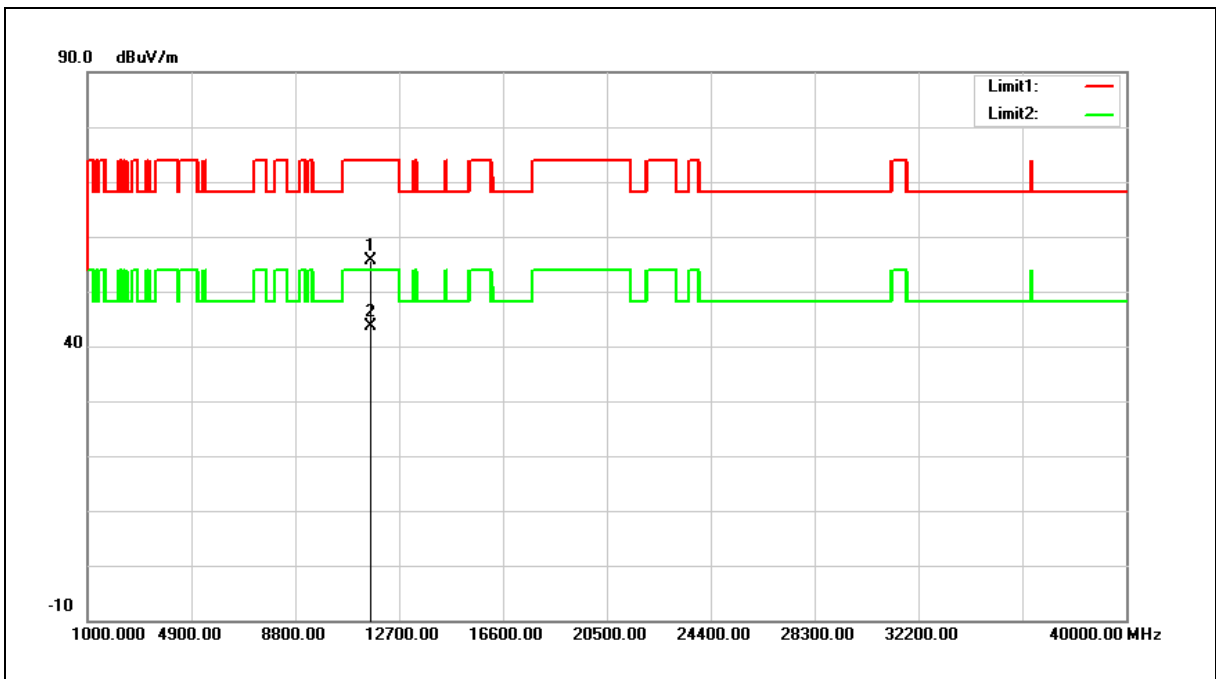

No.	Frequency (MHz)	Reading (dBuV)	Correct Factor (dB/m)	Result (dBuV/m)	Limit (dBuV/m)	Margin (dB)	Remark
1	11650.000	37.61	17.93	55.54	74.00	-18.46	peak
2	11650.000	25.65	17.93	43.58	54.00	-10.42	AVG

Note:1.Result (dBuV/m) = Correct Factor (dB/m) + Reading(dBuV).

2.Correction factor (dB/m) = Antenna Factor (dB/m) + Cable loss (dB) – Pre-Amplifier gain (dB).

3.When the peak results are less than average limit, so not need to evaluate the average.



Standard:	FCC Part 15.407	Test Distance:	3 m
Test item:	Harmonic	Power:	AC 120 V/60 Hz
Frequency:	5825 MHz	Temp.(°C)/Hum.(%RH):	26(°C)/60 %RH
Mode:	Mode 3		
Ant.Polar.:	Vertical		

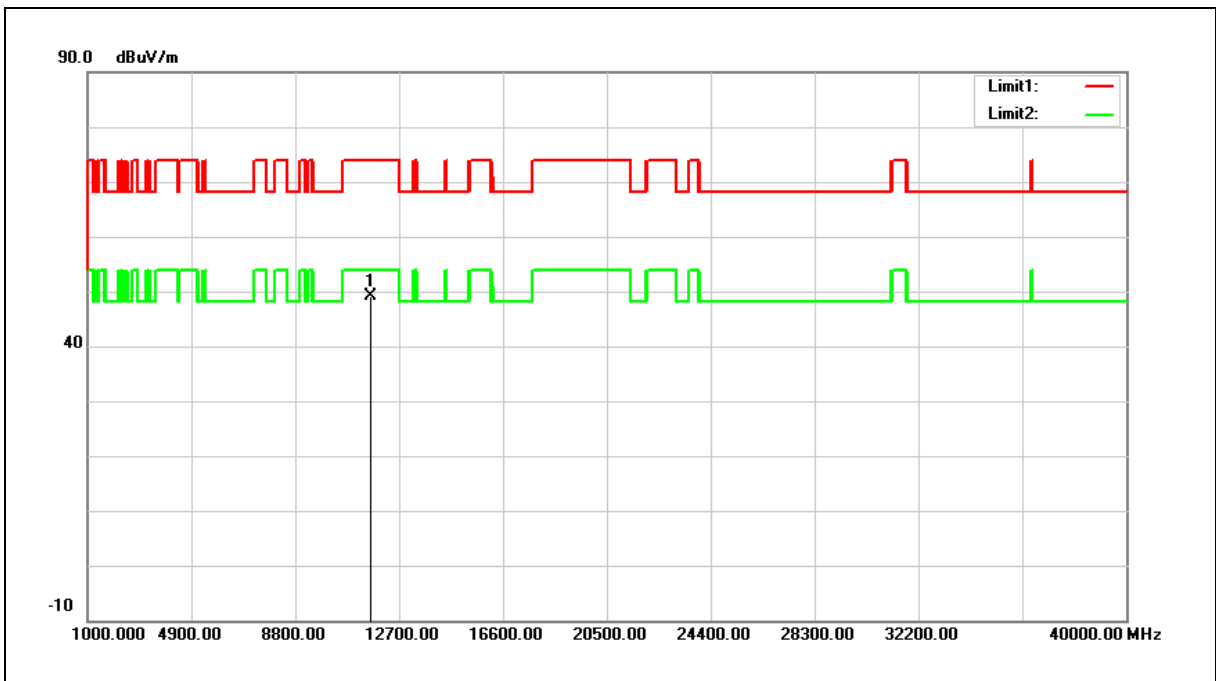

No.	Frequency (MHz)	Reading (dBuV)	Correct Factor (dB/m)	Result (dBuV/m)	Limit (dBuV/m)	Margin (dB)	Remark
1	11650.000	31.21	17.93	49.14	74.00	-24.86	peak

Note:1.Result (dBuV/m) = Correct Factor (dB/m) + Reading(dBuV).

2.Correction factor (dB/m) = Antenna Factor (dB/m) + Cable loss (dB) – Pre-Amplifier gain (dB).

3.When the peak results are less than average limit, so not need to evaluate the average.



Standard:	FCC Part 15.407	Test Distance:	3 m
Test item:	Harmonic	Power:	AC 120 V/60 Hz
Frequency:	5190 MHz	Temp.(°C)/Hum.(%RH):	26(°C)/60 %RH
Mode:	Mode 4		
Ant.Polar.:	Horizontal		

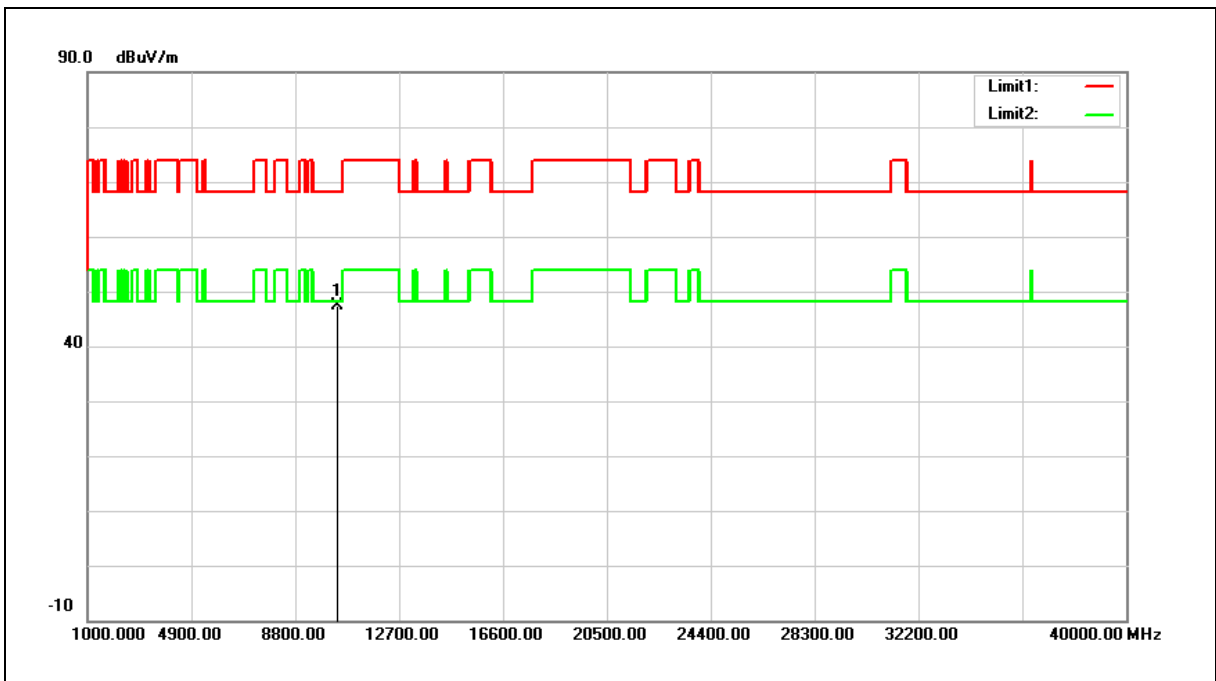

No.	Frequency (MHz)	Reading (dBuV)	Correct Factor (dB/m)	Result (dBuV/m)	Limit (dBuV/m)	Margin (dB)	Remark
1	10380.000	31.34	16.15	47.49	68.20	-20.71	peak

Note:1.Result (dBuV/m) = Correct Factor (dB/m) + Reading(dBuV).

2.Correction factor (dB/m) = Antenna Factor (dB/m) + Cable loss (dB) – Pre-Amplifier gain (dB).

3.When the peak results are less than average limit, so not need to evaluate the average.



Standard:	FCC Part 15.407	Test Distance:	3 m
Test item:	Harmonic	Power:	AC 120 V/60 Hz
Frequency:	5190 MHz	Temp.(°C)/Hum.(%RH):	26(°C)/60 %RH
Mode:	Mode 4		
Ant.Polar.:	Vertical		

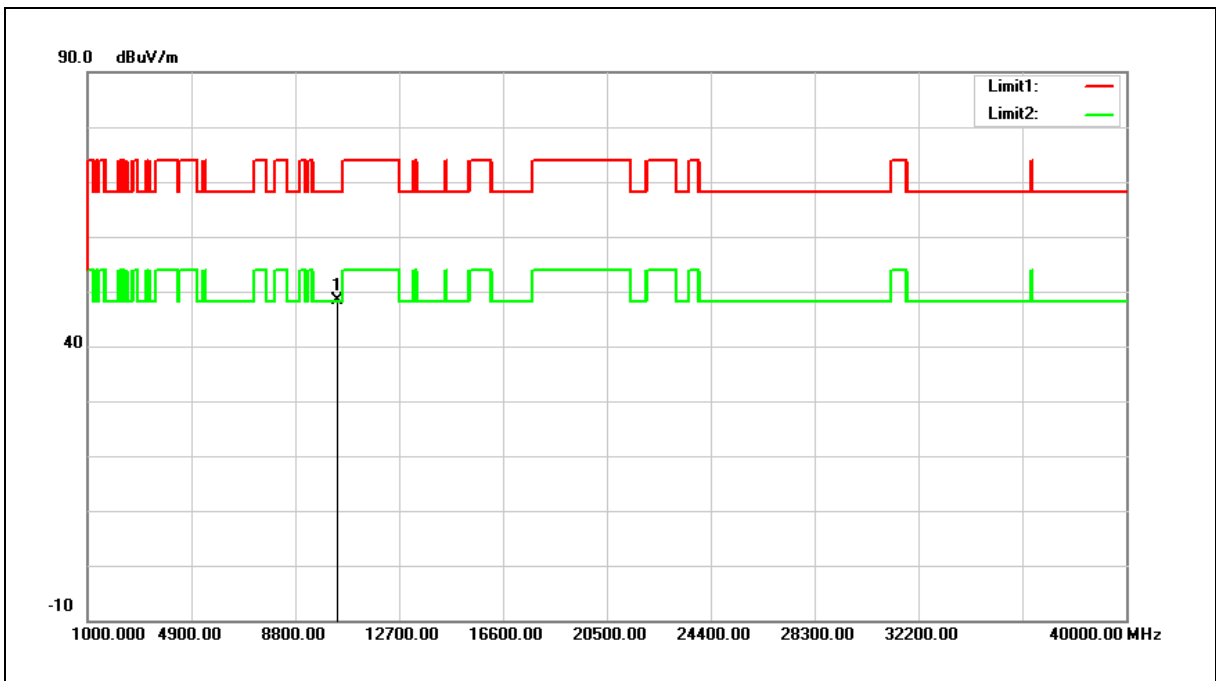

No.	Frequency (MHz)	Reading (dBuV)	Correct Factor (dB/m)	Result (dBuV/m)	Limit (dBuV/m)	Margin (dB)	Remark
1	10380.000	32.18	16.15	48.33	68.20	-19.87	peak

Note:1.Result (dBuV/m) = Correct Factor (dB/m) + Reading(dBuV).

2.Correction factor (dB/m) = Antenna Factor (dB/m) + Cable loss (dB) – Pre-Amplifier gain (dB).

3.When the peak results are less than average limit, so not need to evaluate the average.



Standard:	FCC Part 15.407	Test Distance:	3 m
Test item:	Harmonic	Power:	AC 120 V/60 Hz
Frequency:	5230 MHz	Temp.(°C)/Hum.(%RH):	26(°C)/60 %RH
Mode:	Mode 4		
Ant.Polar.:	Horizontal		

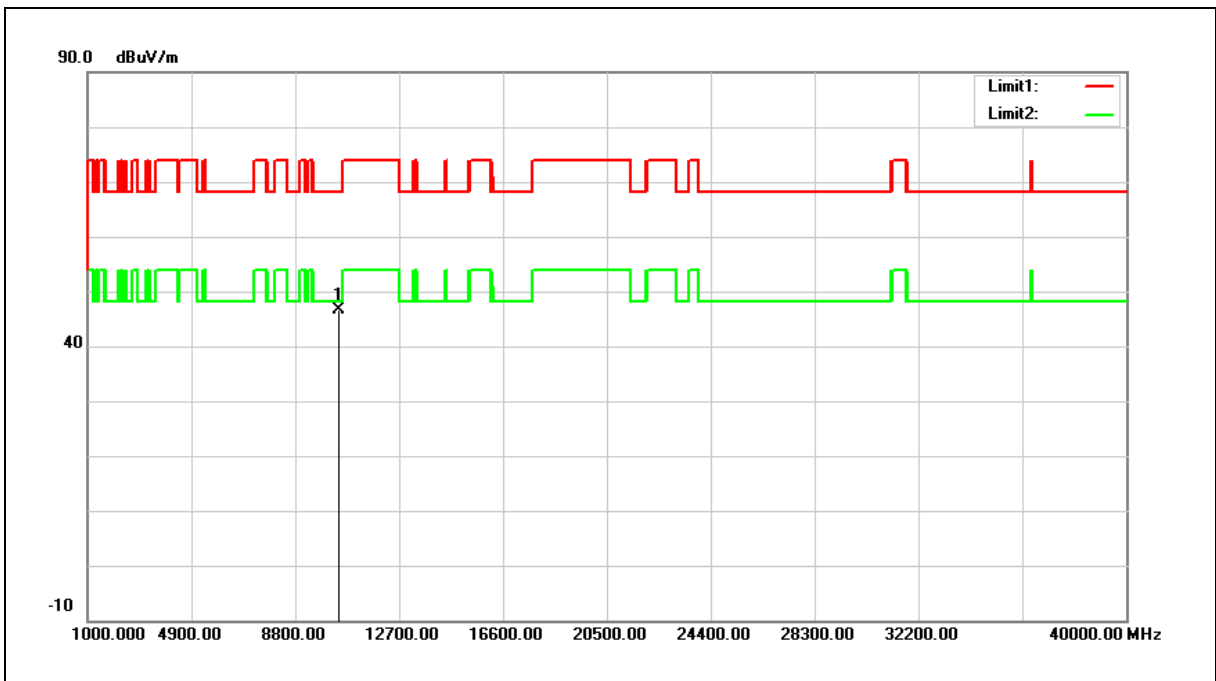

No.	Frequency (MHz)	Reading (dBuV)	Correct Factor (dB/m)	Result (dBuV/m)	Limit (dBuV/m)	Margin (dB)	Remark
1	10460.000	30.22	16.41	46.63	68.20	-21.57	peak

- Note:1.Result (dBuV/m) = Correct Factor (dB/m) + Reading(dBuV).  
 2.Correction factor (dB/m) = Antenna Factor (dB/m) + Cable loss (dB) – Pre-Amplifier gain (dB).  
 3.When the peak results are less than average limit, so not need to evaluate the average.



Standard:	FCC Part 15.407	Test Distance:	3 m
Test item:	Harmonic	Power:	AC 120 V/60 Hz
Frequency:	5230 MHz	Temp.(°C)/Hum.(%RH):	26(°C)/60 %RH
Mode:	Mode 4		
Ant.Polar.:	Vertical		

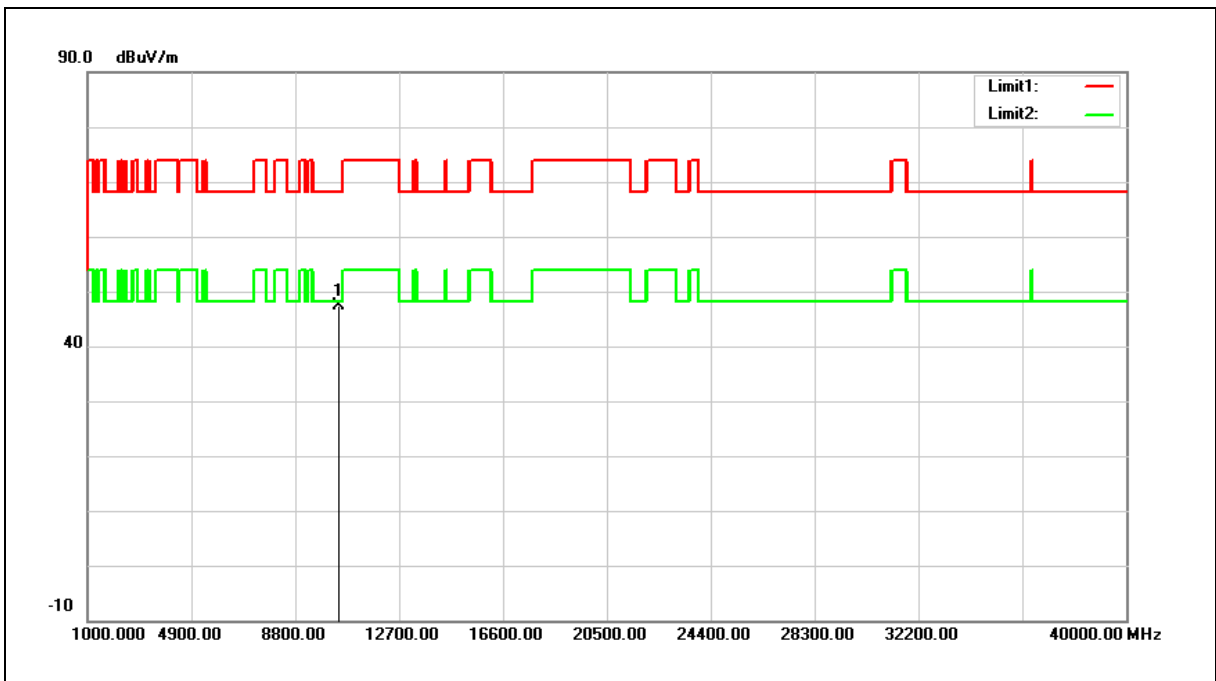

No.	Frequency (MHz)	Reading (dBuV)	Correct Factor (dB/m)	Result (dBuV/m)	Limit (dBuV/m)	Margin (dB)	Remark
1	10460.000	31.07	16.41	47.48	68.20	-20.72	peak

Note:1.Result (dBuV/m) = Correct Factor (dB/m) + Reading(dBuV).

2.Correction factor (dB/m) = Antenna Factor (dB/m) + Cable loss (dB) – Pre-Amplifier gain (dB).

3.When the peak results are less than average limit, so not need to evaluate the average.



Standard:	FCC Part 15.407	Test Distance:	3 m
Test item:	Harmonic	Power:	AC 120 V/60 Hz
Frequency:	5755 MHz	Temp.(°C)/Hum.(%RH):	26(°C)/60 %RH
Mode:	Mode 4		
Ant.Polar.:	Horizontal		

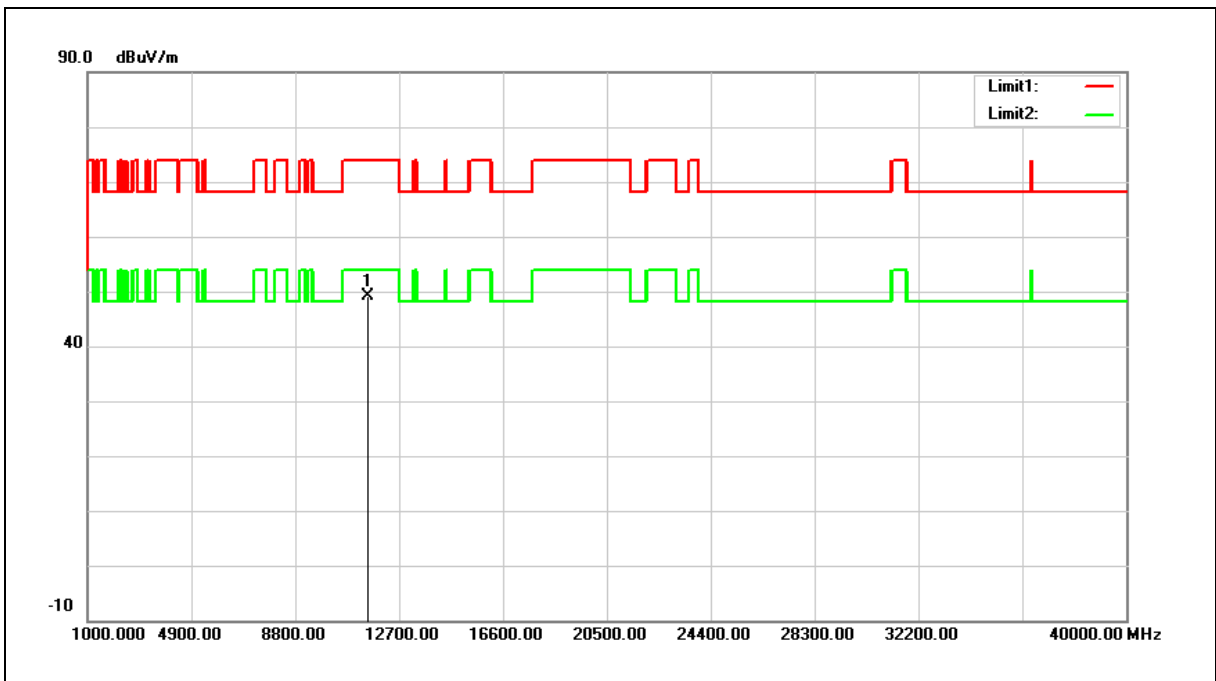

No.	Frequency (MHz)	Reading (dBuV)	Correct Factor (dB/m)	Result (dBuV/m)	Limit (dBuV/m)	Margin (dB)	Remark
1	11510.000	30.95	18.11	49.06	74.00	-24.94	peak

Note:1.Result (dBuV/m) = Correct Factor (dB/m) + Reading(dBuV).

2.Correction factor (dB/m) = Antenna Factor (dB/m) + Cable loss (dB) – Pre-Amplifier gain (dB).

3.When the peak results are less than average limit, so not need to evaluate the average.



Standard:	FCC Part 15.407	Test Distance:	3 m
Test item:	Harmonic	Power:	AC 120 V/60 Hz
Frequency:	5755 MHz	Temp.(°C)/Hum.(%RH):	26(°C)/60 %RH
Mode:	Mode 4		
Ant.Polar.:	Vertical		

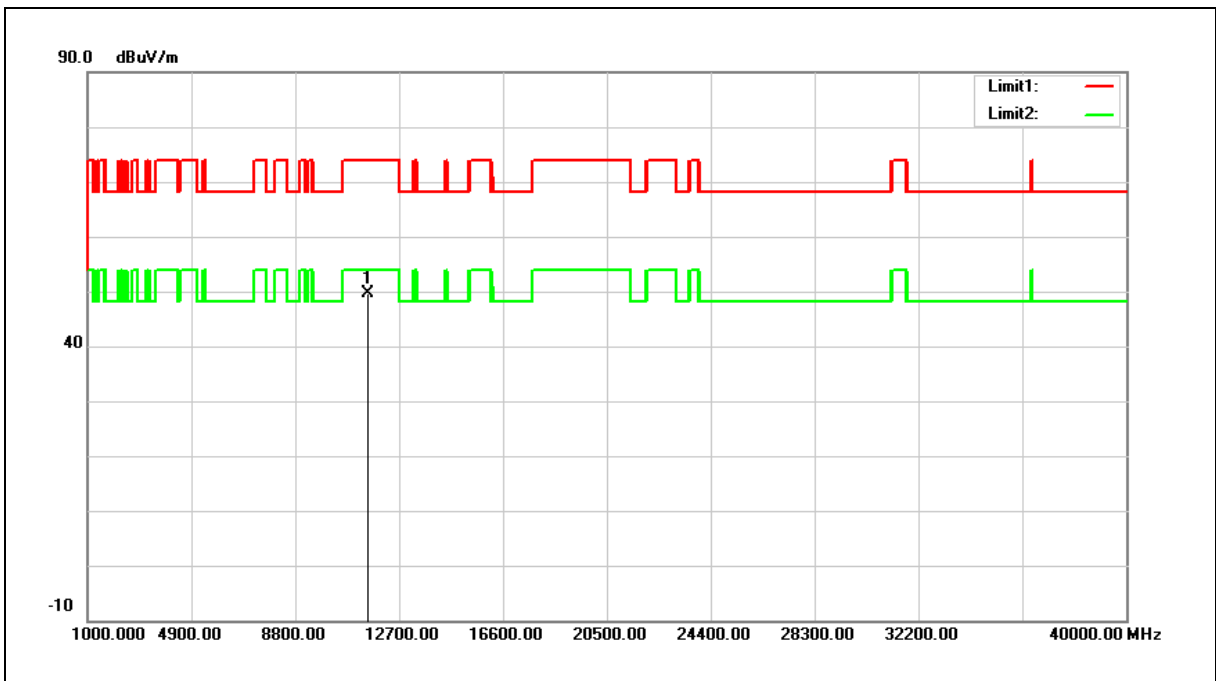

No.	Frequency (MHz)	Reading (dBuV)	Correct Factor (dB/m)	Result (dBuV/m)	Limit (dBuV/m)	Margin (dB)	Remark
1	11510.000	31.55	18.11	49.66	74.00	-24.34	peak

- Note: 1.Result (dBuV/m) = Correct Factor (dB/m) + Reading(dBuV).  
 2.Correction factor (dB/m) = Antenna Factor (dB/m) + Cable loss (dB) – Pre-Amplifier gain (dB).  
 3.When the peak results are less than average limit, so not need to evaluate the average.





Standard:	FCC Part 15.407	Test Distance:	3 m
Test item:	Harmonic	Power:	AC 120 V/60 Hz
Frequency:	5795 MHz	Temp.(°C)/Hum.(%RH):	26(°C)/60 %RH
Mode:	Mode 4		
Ant.Polar.:	Horizontal		

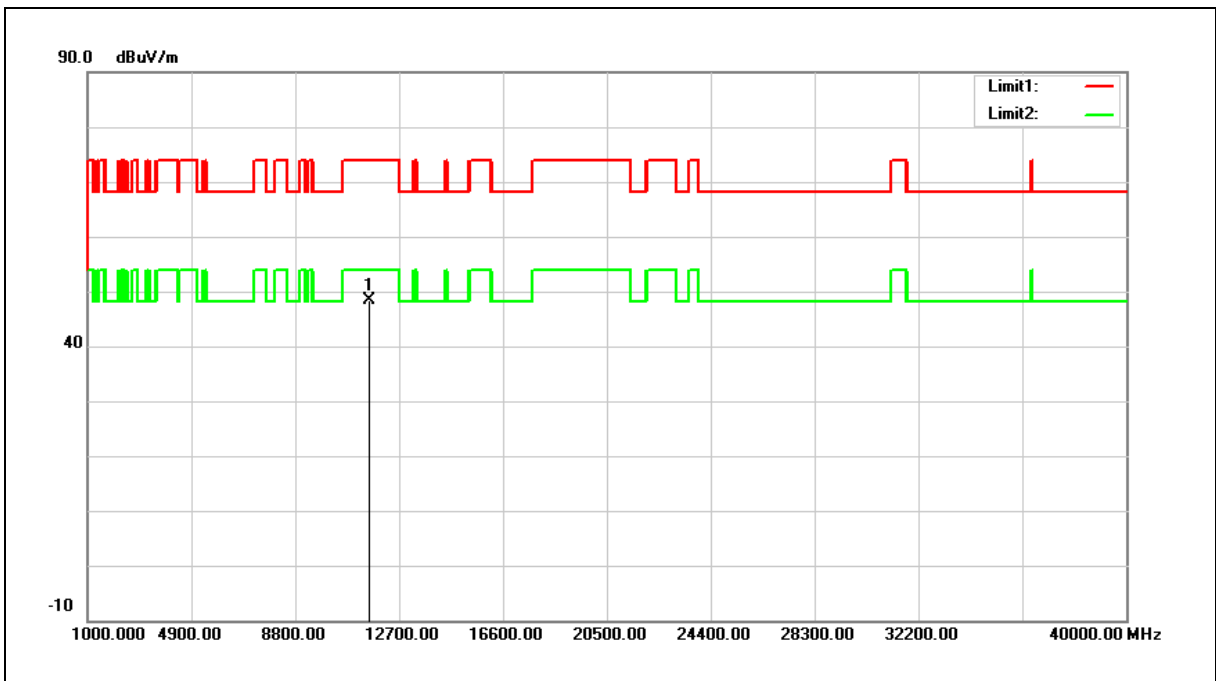

No.	Frequency (MHz)	Reading (dBuV)	Correct Factor (dB/m)	Result (dBuV/m)	Limit (dBuV/m)	Margin (dB)	Remark
1	11590.000	30.35	18.00	48.35	74.00	-25.65	peak

Note:1.Result (dBuV/m) = Correct Factor (dB/m) + Reading(dBuV).

2.Correction factor (dB/m) = Antenna Factor (dB/m) + Cable loss (dB) – Pre-Amplifier gain (dB).

3.When the peak results are less than average limit, so not need to evaluate the average.



Standard:	FCC Part 15.407	Test Distance:	3 m
Test item:	Harmonic	Power:	AC 120 V/60 Hz
Frequency:	5795 MHz	Temp.(°C)/Hum.(%RH):	26(°C)/60 %RH
Mode:	Mode 4		
Ant.Polar.:	Vertical		

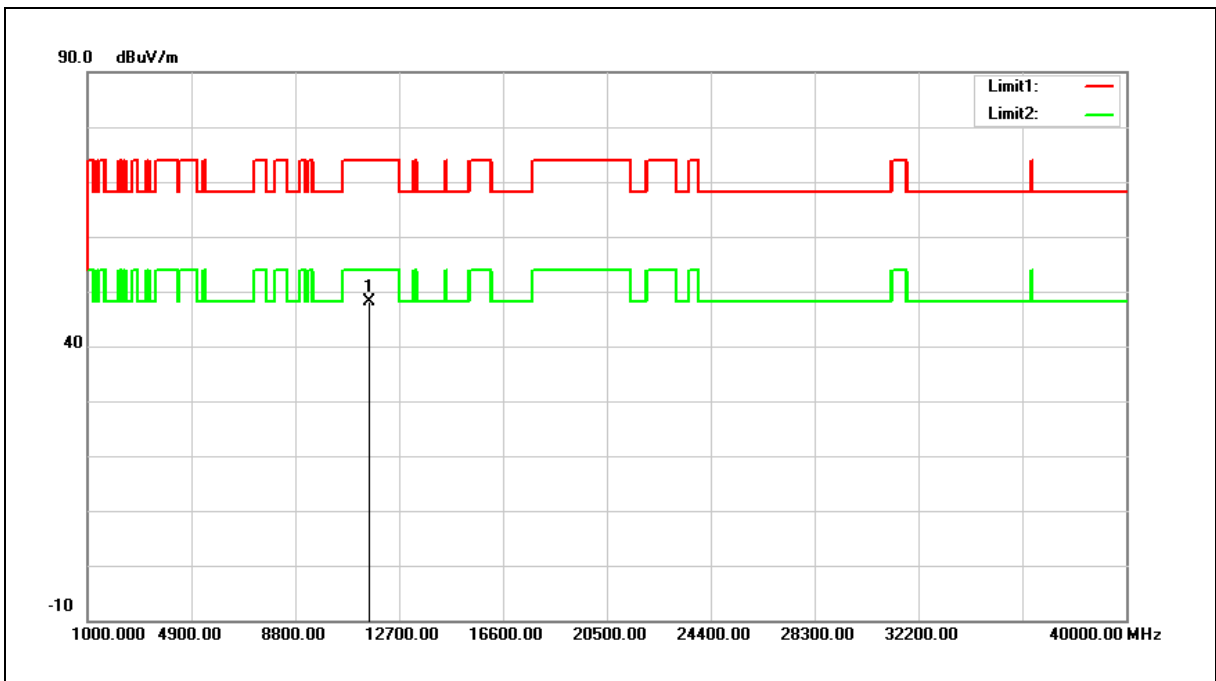

No.	Frequency (MHz)	Reading (dBuV)	Correct Factor (dB/m)	Result (dBuV/m)	Limit (dBuV/m)	Margin (dB)	Remark
1	11590.000	30.07	18.00	48.07	74.00	-25.93	peak

Note:1.Result (dBuV/m) = Correct Factor (dB/m) + Reading(dBuV).

2.Correction factor (dB/m) = Antenna Factor (dB/m) + Cable loss (dB) – Pre-Amplifier gain (dB).

3.When the peak results are less than average limit, so not need to evaluate the average.



Standard:	FCC Part 15.407	Test Distance:	3 m
Test item:	Harmonic	Power:	AC 120 V/60 Hz
Frequency:	5210 MHz	Temp.(°C)/Hum.(%RH):	26(°C)/60 %RH
Mode:	Mode 5		
Ant.Polar.:	Horizontal		

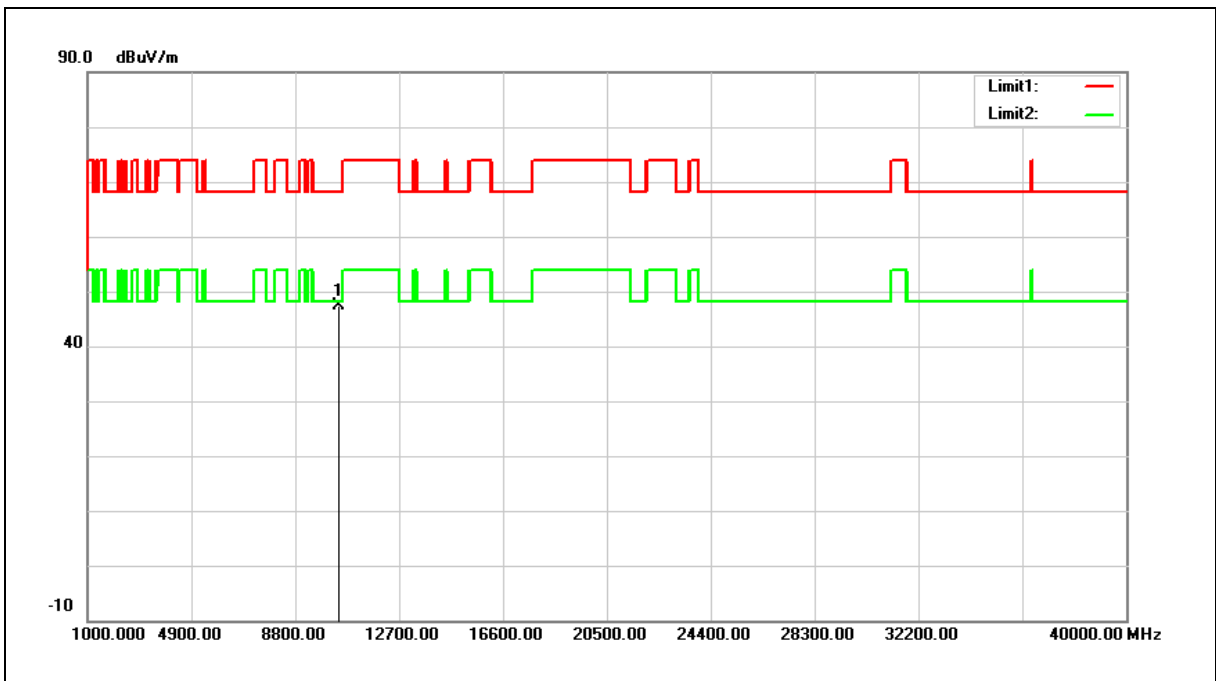

No.	Frequency (MHz)	Reading (dBuV)	Correct Factor (dB/m)	Result (dBuV/m)	Limit (dBuV/m)	Margin (dB)	Remark
1	10420.000	31.10	16.28	47.38	68.20	-20.82	peak

- Note:1.Result (dBuV/m) = Correct Factor (dB/m) + Reading(dBuV).  
 2.Correction factor (dB/m) = Antenna Factor (dB/m) + Cable loss (dB) – Pre-Amplifier gain (dB).  
 3.When the peak results are less than average limit, so not need to evaluate the average.



Standard:	FCC Part 15.407	Test Distance:	3 m
Test item:	Harmonic	Power:	AC 120 V/60 Hz
Frequency:	5210 MHz	Temp.(°C)/Hum.(%RH):	26(°C)/60 %RH
Mode:	Mode 5		
Ant.Polar.:	Vertical		

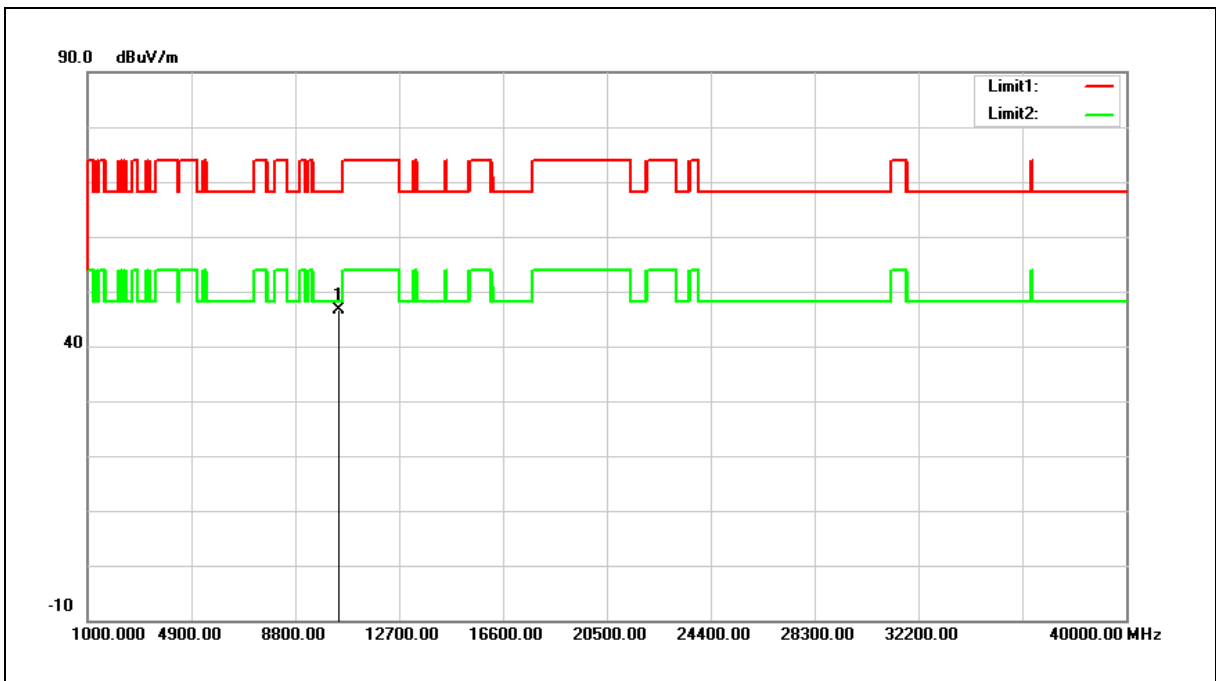

No.	Frequency (MHz)	Reading (dBuV)	Correct Factor (dB/m)	Result (dBuV/m)	Limit (dBuV/m)	Margin (dB)	Remark
1	10420.000	30.25	16.28	46.53	68.20	-21.67	peak

Note:1.Result (dBuV/m) = Correct Factor (dB/m) + Reading(dBuV).

2.Correction factor (dB/m) = Antenna Factor (dB/m) + Cable loss (dB) – Pre-Amplifier gain (dB).

3.When the peak results are less than average limit, so not need to evaluate the average.



Standard:	FCC Part 15.407	Test Distance:	3 m
Test item:	Harmonic	Power:	AC 120 V/60 Hz
Frequency:	5775 MHz	Temp.(°C)/Hum.(%RH):	26(°C)/60 %RH
Mode:	Mode 5		
Ant.Polar.:	Horizontal		

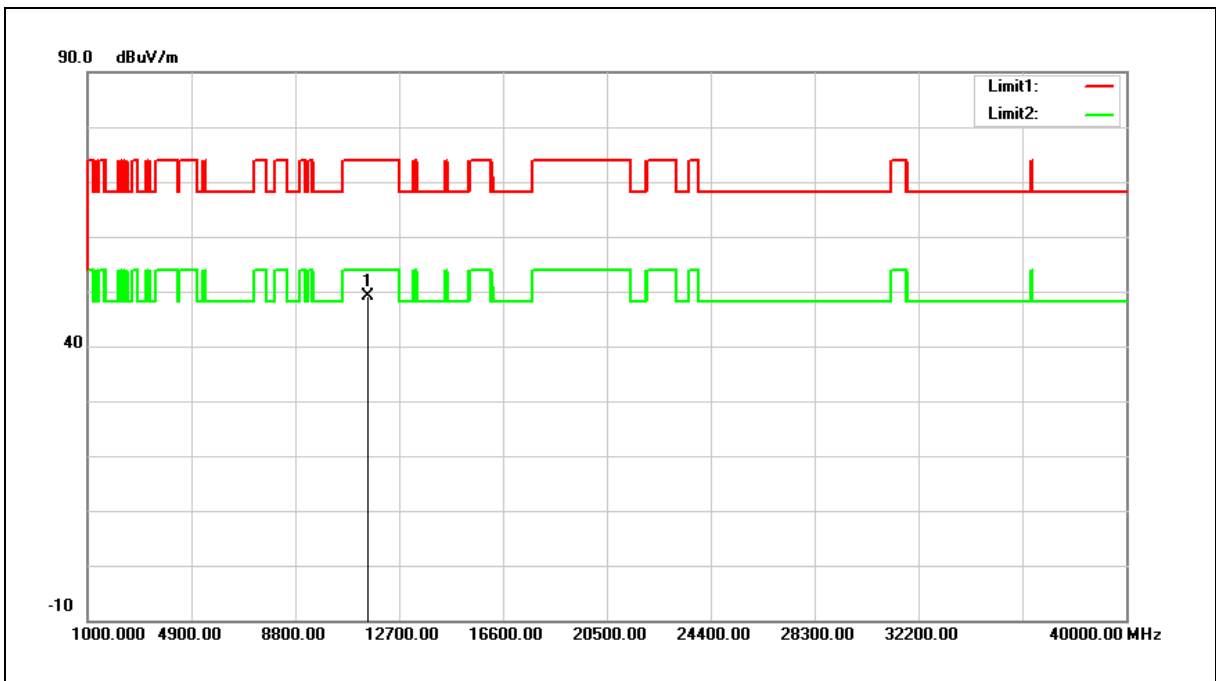

No.	Frequency (MHz)	Reading (dBuV)	Correct Factor (dB/m)	Result (dBuV/m)	Limit (dBuV/m)	Margin (dB)	Remark
1	11550.000	31.10	18.06	49.16	74.00	-24.84	peak

- Note:1.Result (dBuV/m) = Correct Factor (dB/m) + Reading(dBuV).
- 2.Correction factor (dB/m) = Antenna Factor (dB/m) + Cable loss (dB) – Pre-Amplifier gain (dB).
- 3.When the peak results are less than average limit, so not need to evaluate the average.



Standard:	FCC Part 15.407	Test Distance:	3 m
Test item:	Harmonic	Power:	AC 120 V/60 Hz
Frequency:	5775 MHz	Temp.(°C)/Hum.(%RH):	26(°C)/60 %RH
Mode:	Mode 5		
Ant.Polar.:	Vertical		

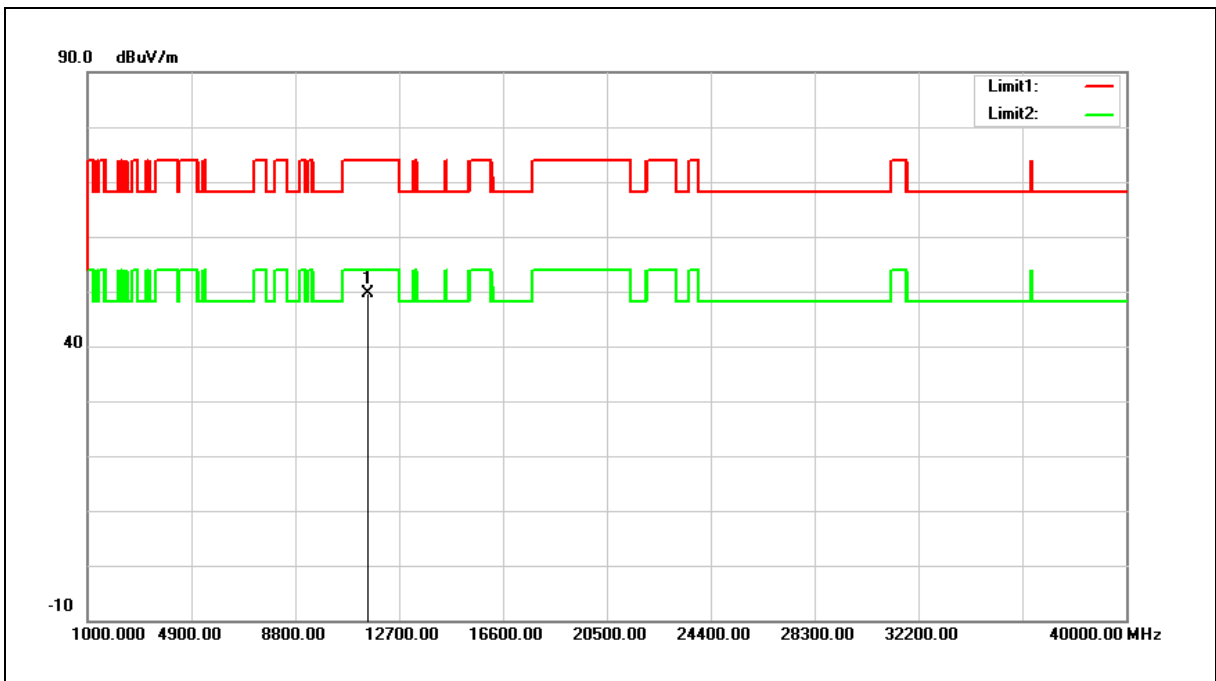

No.	Frequency (MHz)	Reading (dBuV)	Correct Factor (dB/m)	Result (dBuV/m)	Limit (dBuV/m)	Margin (dB)	Remark
1	11550.000	31.45	18.06	49.51	74.00	-24.49	peak

- Note:1.Result (dBuV/m) = Correct Factor (dB/m) + Reading(dBuV).
- 2.Correction factor (dB/m) = Antenna Factor (dB/m) + Cable loss (dB) – Pre-Amplifier gain (dB).
- 3.When the peak results are less than average limit, so not need to evaluate the average.



Standard:	FCC Part 15.407	Test Distance:	3 m
Test item:	Transmitter Unwanted Emissions	Power:	AC 120 V/60 Hz
Test Mode:	Simultaneous Transmitting (DTS+NII)	Temp.(°C)/Hum.(%RH):	26(°C)/60 %RH
Ant.Polar.:	Horizontal		

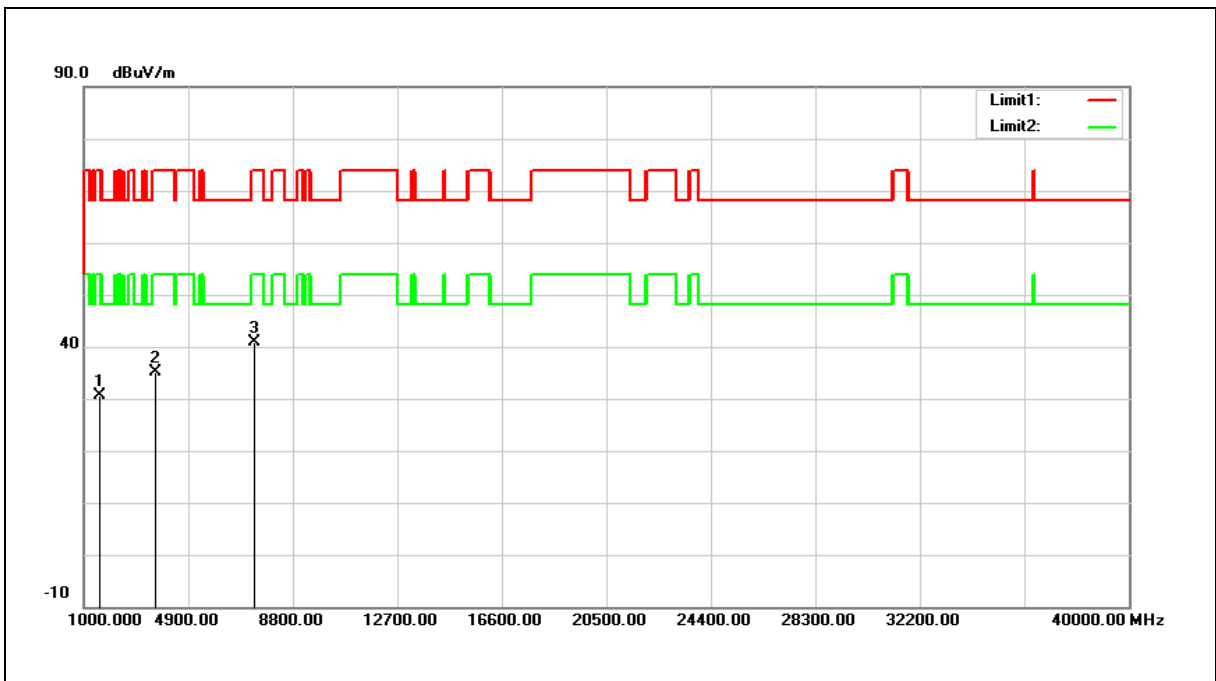

No.	Frequency (MHz)	Reading (dBuV)	Correct Factor (dB/m)	Result (dBuV/m)	Limit (dBuV/m)	Margin (dB)	Remark
1	1561.000	36.07	-5.35	30.72	74.00	-43.28	peak
2	3703.000	33.33	1.70	35.03	74.00	-38.97	peak
3	7341.000	29.23	11.54	40.77	74.00	-33.23	peak

Note:1.Result (dBuV/m) = Correct Factor (dB/m) + Reading(dBuV).

2.Correction factor (dB/m) = Antenna Factor (dB/m) + Cable loss (dB) – Pre-Amplifier gain (dB).

3. When the peak results are less than average limit, so not need to evaluate the average.



Standard:	FCC Part 15.407	Test Distance:	3 m
Test item:	Transmitter Unwanted Emissions	Power:	AC 120 V/60 Hz
Test Mode:	Simultaneous Transmitting (DTS+NII)	Temp.(°C)/Hum.(%RH):	26(°C)/60 %RH
Ant.Polar.:	Vertical		

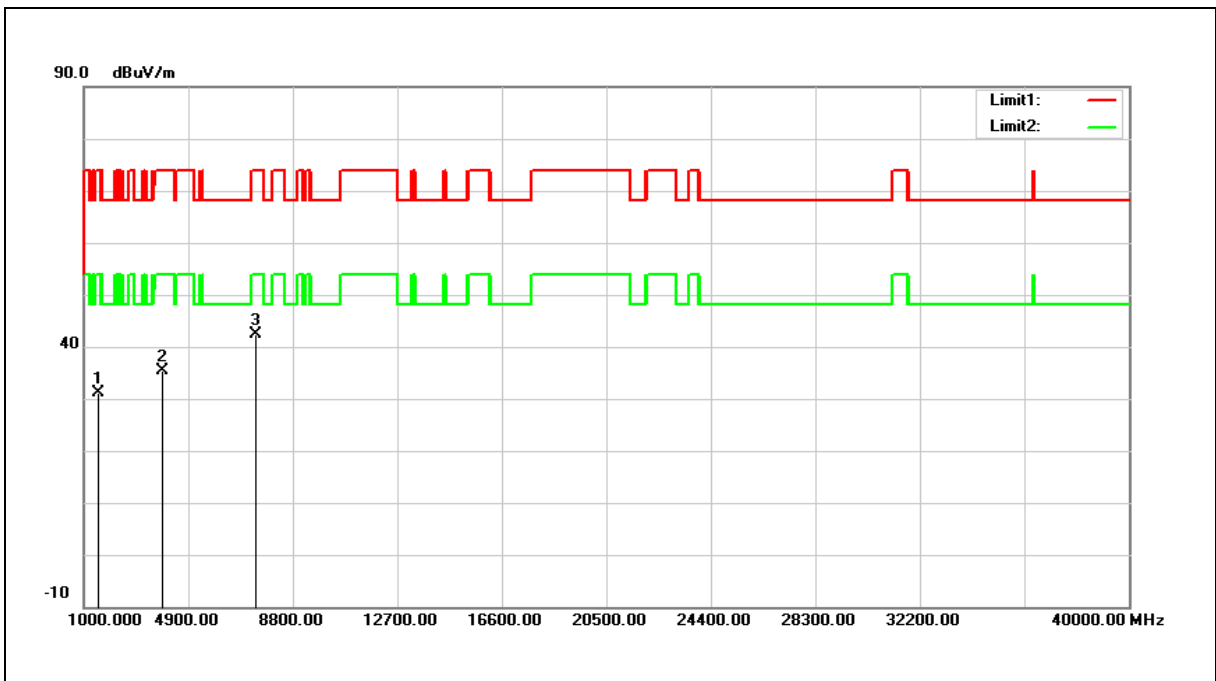

No.	Frequency (MHz)	Reading (dBuV)	Correct Factor (dB/m)	Result (dBuV/m)	Limit (dBuV/m)	Margin (dB)	Remark
1	1527.000	36.74	-5.51	31.23	74.00	-42.77	peak
2	3958.000	32.82	2.47	35.29	74.00	-38.71	peak
3	7409.000	30.68	11.71	42.39	74.00	-31.61	peak

Note:1.Result (dBuV/m) = Correct Factor (dB/m) + Reading(dBuV).

2.Correction factor (dB/m) = Antenna Factor (dB/m) + Cable loss (dB) – Pre-Amplifier gain (dB).

3. When the peak results are less than average limit, so not need to evaluate the average.





**Band Edge**

Standard:	FCC Part 15.407	Test Distance:	3 m
Test item:	Band edge	Power:	AC 120 V/60 Hz
Frequency:	5180 MHz	Temp.(°C)/Hum.(%RH):	26(°C)/60 %RH
Mode:	Mode 3		
Ant.Polar.:	Horizontal		

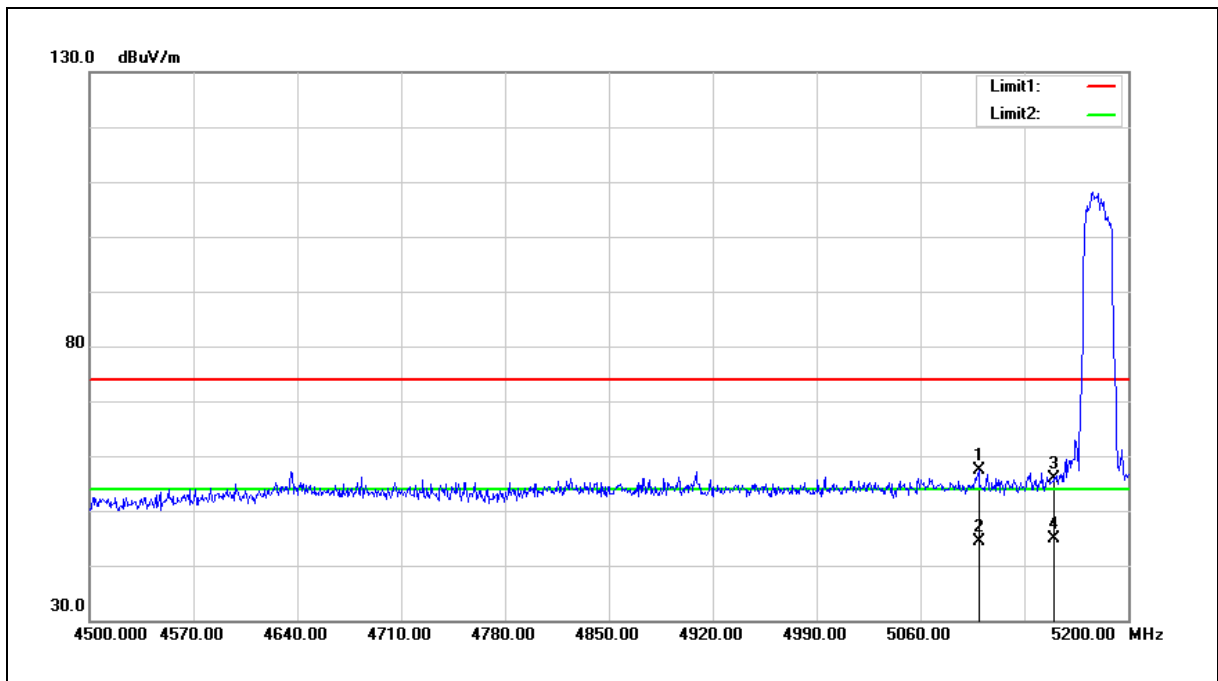

No.	Frequency (MHz)	Reading (dBuV)	Correct Factor (dB/m)	Result (dBuV/m)	Limit (dBuV/m)	Margin (dB)	Remark
1	5099.200	51.72	5.69	57.41	74.00	-16.59	peak
2	5099.200	38.58	5.69	44.27	54.00	-9.73	AVG
3	5150.000	50.16	5.78	55.94	74.00	-18.06	peak
4	5150.000	39.20	5.78	44.98	54.00	-9.02	AVG

- Note: 1.Result (dBuV/m) = Correct Factor (dB/m) + Reading(dBuV).
- 2.Correction factor (dB/m) = Antenna Factor (dB/m) + Cable loss (dB) – Pre-Amplifier gain (dB).
- 3.When the peak results are less than average limit, so not need to evaluate the average.



Standard:	FCC Part 15.407	Test Distance:	3 m
Test item:	Band edge	Power:	AC 120 V/60 Hz
Frequency:	5180 MHz	Temp.(°C)/Hum.(%RH):	26(°C)/60 %RH
Mode:	Mode 3		
Ant.Polar.:	Vertical		

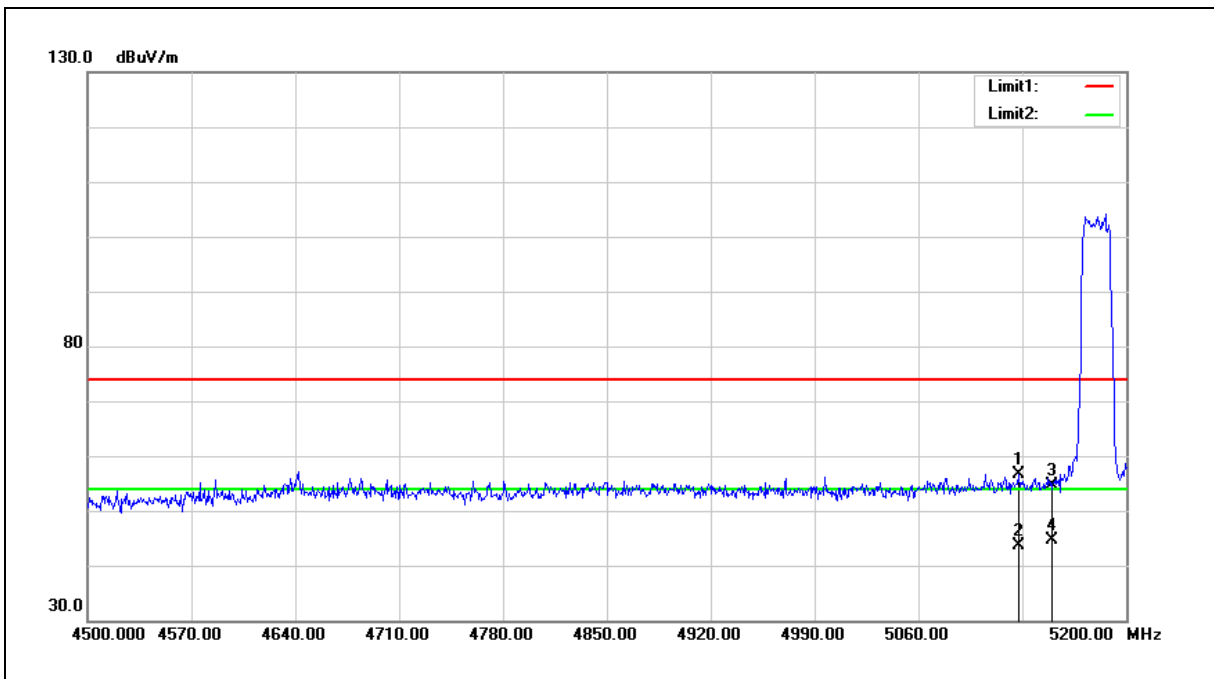

No.	Frequency (MHz)	Reading (dBuV)	Correct Factor (dB/m)	Result (dBuV/m)	Limit (dBuV/m)	Margin (dB)	Remark
1	5127.200	50.98	5.75	56.73	74.00	-17.27	peak
2	5127.200	37.98	5.75	43.73	54.00	-10.27	AVG
3	5150.000	48.83	5.78	54.61	74.00	-19.39	peak
4	5150.000	38.96	5.78	44.74	54.00	-9.26	AVG

Note:1.Result (dBuV/m) = Correct Factor (dB/m) + Reading(dBuV).

2.Correction factor (dB/m) = Antenna Factor (dB/m) + Cable loss (dB) – Pre-Amplifier gain (dB).

3.When the peak results are less than average limit, so not need to evaluate the average.



Standard:	FCC Part 15.407	Test Distance:	3 m
Test item:	Band edge	Power:	AC 120 V/60 Hz
Frequency:	5200 MHz	Temp.(°C)/Hum.(%RH):	26(°C)/60 %RH
Mode:	Mode 3		
Ant.Polar.:	Horizontal		

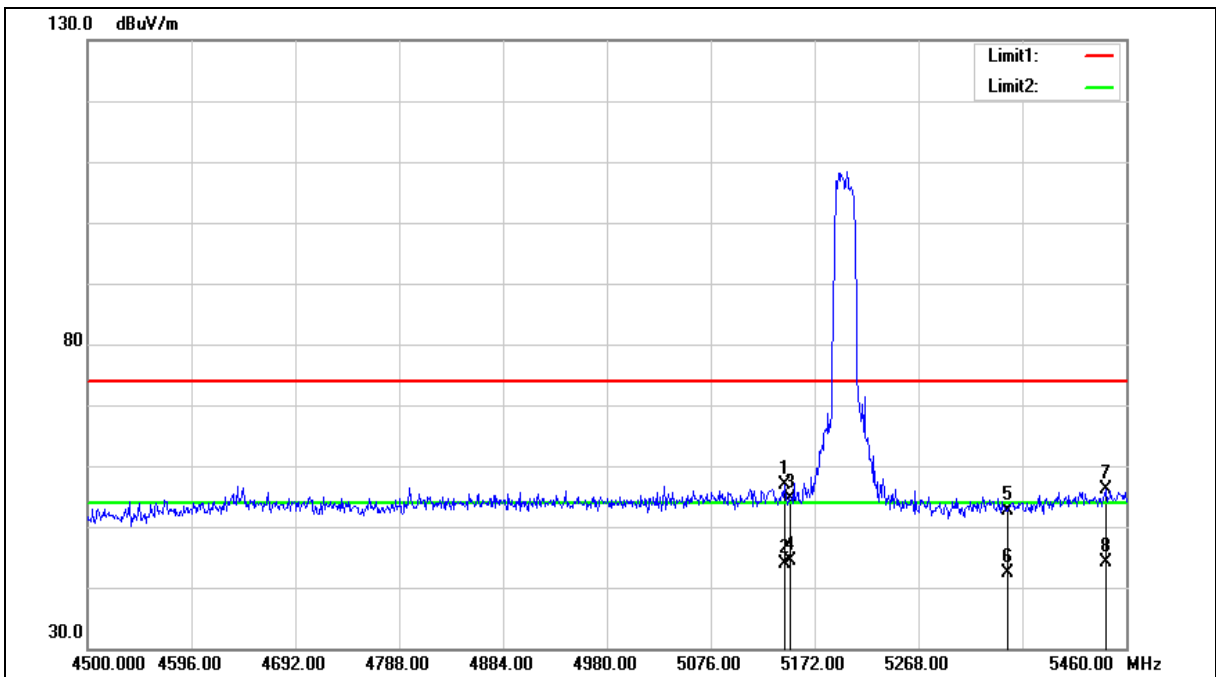



Standard:	FCC Part 15.407	Test Distance:	3 m
Test item:	Band edge	Power:	AC 120 V/60 Hz
Frequency:	5200 MHz	Temp.(°C)/Hum.(%RH):	26(°C)/60 %RH
Mode:	Mode 3		
Ant.Polar.:	Horizontal		

No.	Frequency (MHz)	Reading (dBuV)	Correct Factor (dB/m)	Result (dBuV/m)	Limit (dBuV/m)	Margin (dB)	Remark
1	5144.160	51.23	5.77	57.00	74.00	-17.00	peak
2	5144.160	38.13	5.77	43.90	54.00	-10.10	AVG
3	5150.000	48.76	5.78	54.54	74.00	-19.46	peak
4	5150.000	38.52	5.78	44.30	54.00	-9.70	AVG
5	5350.000	46.55	6.07	52.62	74.00	-21.38	peak
6	5350.000	36.38	6.07	42.45	54.00	-11.55	AVG
7	5441.760	49.88	6.21	56.09	74.00	-17.91	peak
8	5441.760	37.91	6.21	44.12	54.00	-9.88	AVG

Note:1.Result (dBuV/m) = Correct Factor (dB/m) + Reading(dBuV).

2.Correction factor (dB/m) = Antenna Factor (dB/m) + Cable loss (dB) – Pre-Amplifier gain (dB).

3.When the peak results are less than average limit, so not need to evaluate the average.



Standard:	FCC Part 15.407	Test Distance:	3 m
Test item:	Band edge	Power:	AC 120 V/60 Hz
Frequency:	5200 MHz	Temp.(°C)/Hum.(%RH):	26(°C)/60 %RH
Mode:	Mode 3		
Ant.Polar.:	Vertical		

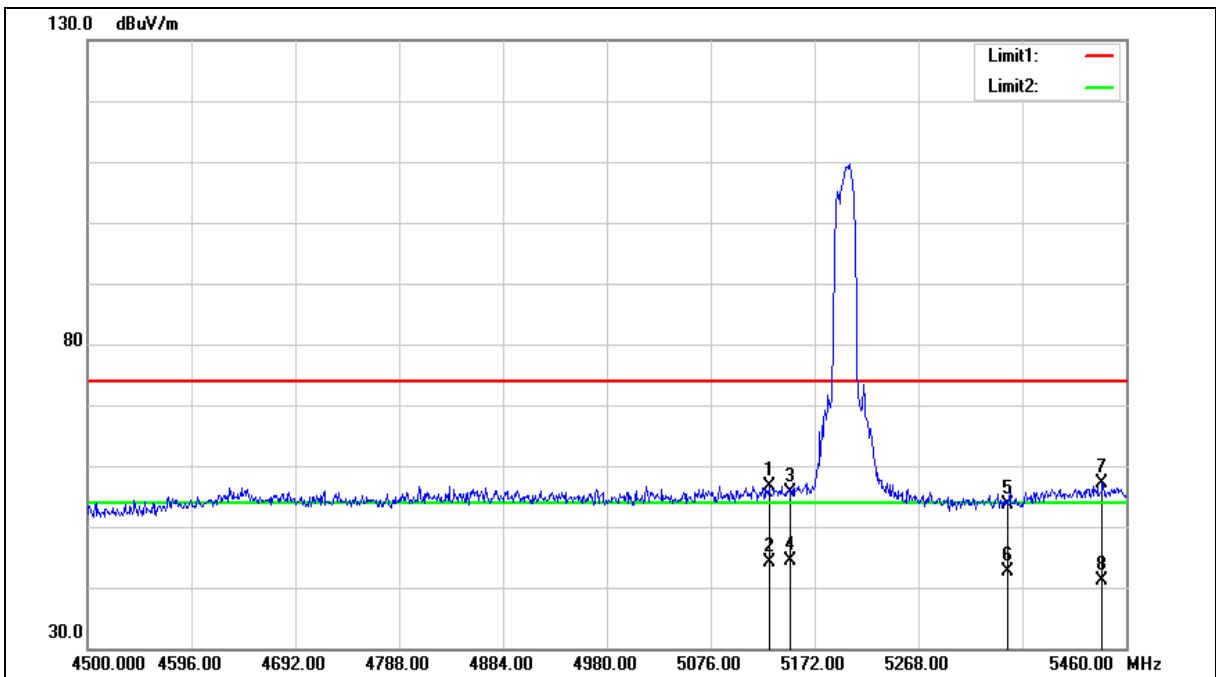



Standard:	FCC Part 15.407	Test Distance:	3 m
Test item:	Band edge	Power:	AC 120 V/60 Hz
Frequency:	5200 MHz	Temp.(°C)/Hum.(%RH):	26(°C)/60 %RH
Mode:	Mode 3		
Ant.Polar.:	Vertical		

No.	Frequency (MHz)	Reading (dBuV)	Correct Factor (dB/m)	Result (dBuV/m)	Limit (dBuV/m)	Margin (dB)	Remark
1	5129.760	50.93	5.75	56.68	74.00	-17.32	peak
2	5129.760	38.28	5.75	44.03	54.00	-9.97	AVG
3	5150.000	49.83	5.78	55.61	74.00	-18.39	peak
4	5150.000	38.64	5.78	44.42	54.00	-9.58	AVG
5	5350.000	47.62	6.07	53.69	74.00	-20.31	peak
6	5350.000	36.56	6.07	42.63	54.00	-11.37	AVG
7	5437.920	50.91	6.20	57.11	74.00	-16.89	peak
8	5437.920	34.84	6.20	41.04	54.00	-12.96	AVG

Note:1.Result (dBuV/m) = Correct Factor (dB/m) + Reading(dBuV).

2.Correction factor (dB/m) = Antenna Factor (dB/m) + Cable loss (dB) – Pre-Amplifier gain (dB).

3.When the peak results are less than average limit, so not need to evaluate the average.



Standard:	FCC Part 15.407	Test Distance:	3 m
Test item:	Band edge	Power:	AC 120 V/60 Hz
Frequency:	5240 MHz	Temp.(°C)/Hum.(%RH):	26(°C)/60 %RH
Mode:	Mode 3		
Ant.Polar.:	Horizontal		

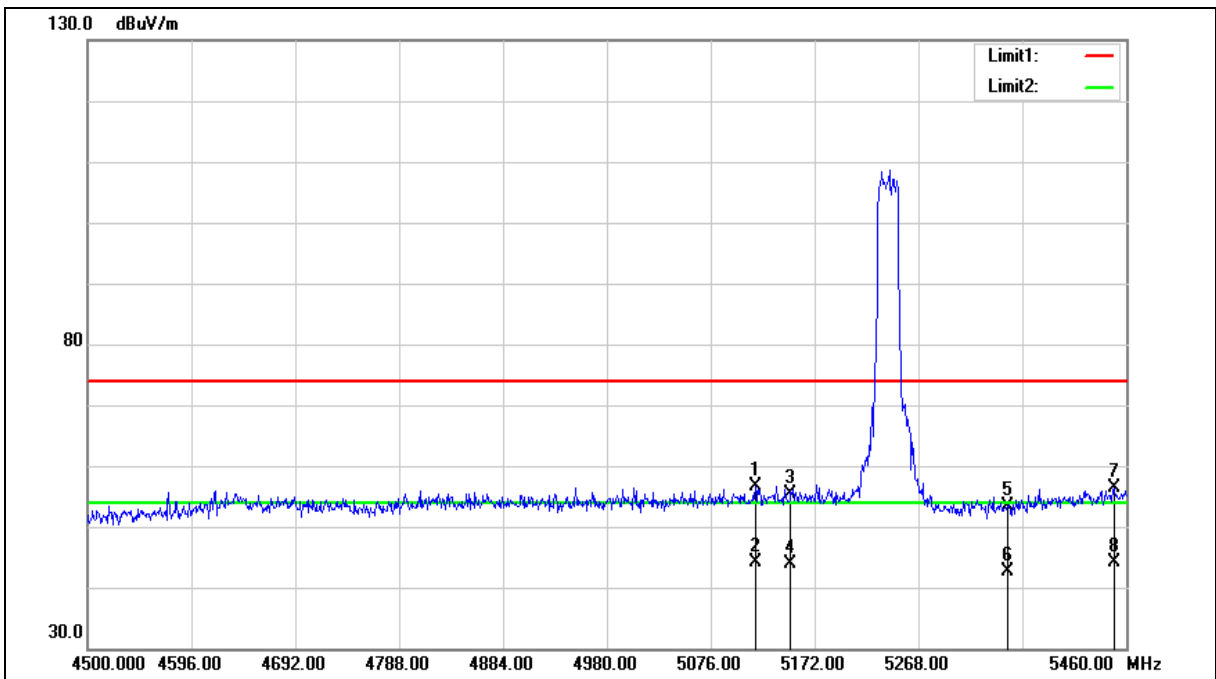



Standard:	FCC Part 15.407	Test Distance:	3 m
Test item:	Band edge	Power:	AC 120 V/60 Hz
Frequency:	5240 MHz	Temp.(°C)/Hum.(%RH):	26(°C)/60 %RH
Mode:	Mode 3		
Ant.Polar.:	Horizontal		

No.	Frequency (MHz)	Reading (dBuV)	Correct Factor (dB/m)	Result (dBuV/m)	Limit (dBuV/m)	Margin (dB)	Remark
1	5117.280	51.01	5.73	56.74	74.00	-17.26	peak
2	5117.280	38.43	5.73	44.16	54.00	-9.84	AVG
3	5150.000	49.52	5.78	55.30	74.00	-18.70	peak
4	5150.000	37.98	5.78	43.76	54.00	-10.24	AVG
5	5350.000	47.24	6.07	53.31	74.00	-20.69	peak
6	5350.000	36.54	6.07	42.61	54.00	-11.39	AVG
7	5448.480	50.11	6.22	56.33	74.00	-17.67	peak
8	5448.480	37.82	6.22	44.04	54.00	-9.96	AVG

Note:1.Result (dBuV/m) = Correct Factor (dB/m) + Reading(dBuV).

2.Correction factor (dB/m) = Antenna Factor (dB/m) + Cable loss (dB) – Pre-Amplifier gain (dB).

3.When the peak results are less than average limit, so not need to evaluate the average.





Standard:	FCC Part 15.407	Test Distance:	3 m
Test item:	Band edge	Power:	AC 120 V/60 Hz
Frequency:	5240 MHz	Temp.(°C)/Hum.(%RH):	26(°C)/60 %RH
Mode:	Mode 3		
Ant.Polar.:	Vertical		

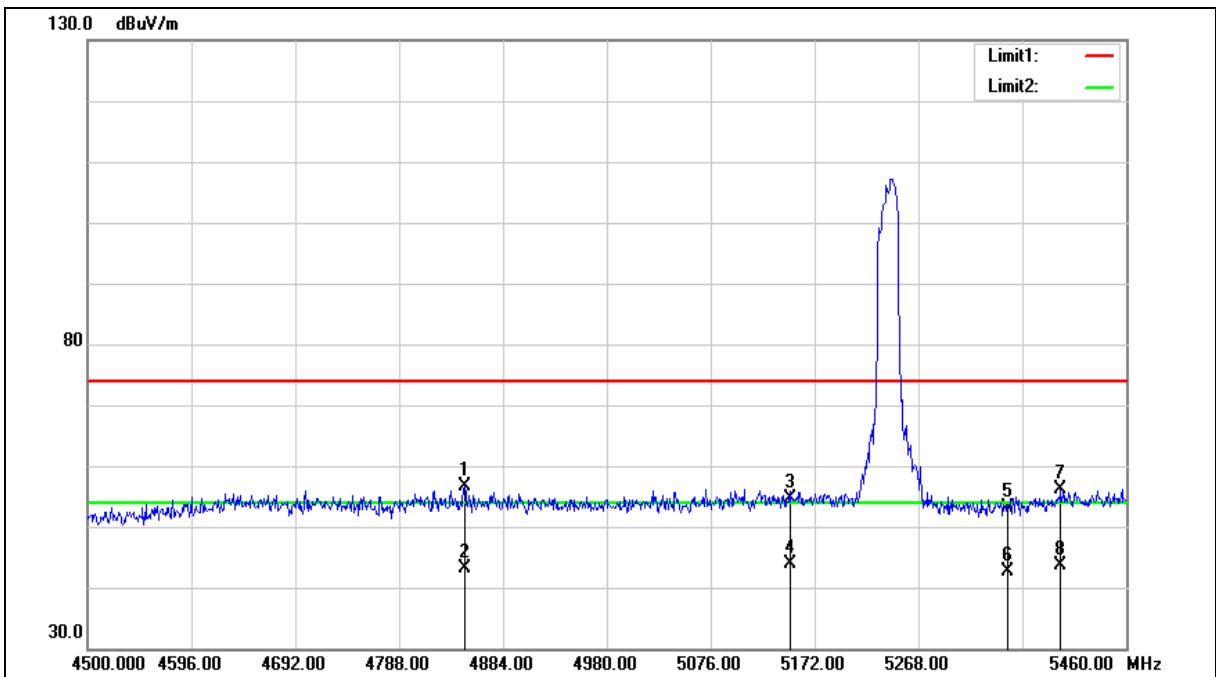



Standard:	FCC Part 15.407	Test Distance:	3 m
Test item:	Band edge	Power:	AC 120 V/60 Hz
Frequency:	5240 MHz	Temp.(°C)/Hum.(%RH):	26(°C)/60 %RH
Mode:	Mode 3		
Ant.Polar.:	Vertical		

No.	Frequency (MHz)	Reading (dBuV)	Correct Factor (dB/m)	Result (dBuV/m)	Limit (dBuV/m)	Margin (dB)	Remark
1	4848.480	51.60	5.07	56.67	74.00	-17.33	peak
2	4848.480	38.12	5.07	43.19	54.00	-10.81	AVG
3	5150.000	48.93	5.78	54.71	74.00	-19.29	peak
4	5150.000	38.00	5.78	43.78	54.00	-10.22	AVG
5	5350.000	47.02	6.07	53.09	74.00	-20.91	peak
6	5350.000	36.68	6.07	42.75	54.00	-11.25	AVG
7	5399.520	49.90	6.15	56.05	74.00	-17.95	peak
8	5399.520	37.37	6.15	43.52	54.00	-10.48	AVG

Note:1.Result (dBuV/m) = Correct Factor (dB/m) + Reading(dBuV).

2.Correction factor (dB/m) = Antenna Factor (dB/m) + Cable loss (dB) – Pre-Amplifier gain (dB).

3.When the peak results are less than average limit, so not need to evaluate the average.



Standard:	FCC Part 15.407	Test Distance:	3 m
Test item:	Band edge	Power:	AC 120 V/60 Hz
Frequency:	5745 MHz	Temp.(°C)/Hum.(%RH):	26(°C )/60 %RH
Mode:	Mode 3		
Ant.Polar.:	Horizontal		

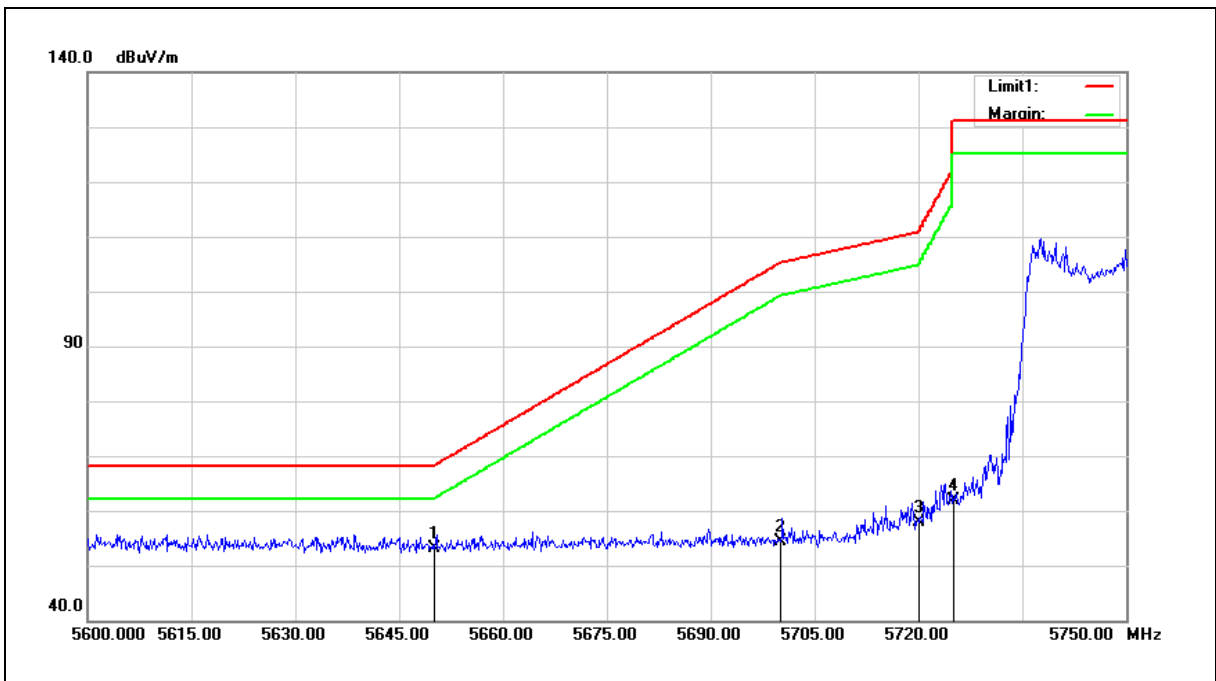

No.	Frequency (MHz)	Reading (dBuV)	Correct Factor (dB/m)	Result (dBuV/m)	Limit (dBuV/m)	Margin (dB)	Remark
1	5650.000	46.51	6.61	53.12	68.20	-15.08	peak
2	5700.000	47.69	6.71	54.40	105.20	-50.80	peak
3	5720.000	51.22	6.77	57.99	110.80	-52.81	peak
4	5725.000	55.19	6.78	61.97	122.20	-60.23	peak

Note:1.Result (dBuV/m) = Correct Factor (dB/m) + Reading(dBuV).

2.Correction factor (dB/m) = Antenna Factor (dB/m) + Cable loss (dB) – Pre-Amplifier gain (dB).

3.When the peak results are less than average limit, so not need to evaluate the average.



Standard:	FCC Part 15.407	Test Distance:	3 m
Test item:	Band edge	Power:	AC 120 V/60 Hz
Frequency:	5745 MHz	Temp.(°C)/Hum.(%RH):	26(°C )/60 %RH
Mode:	Mode 3		
Ant.Polar.:	Vertical		

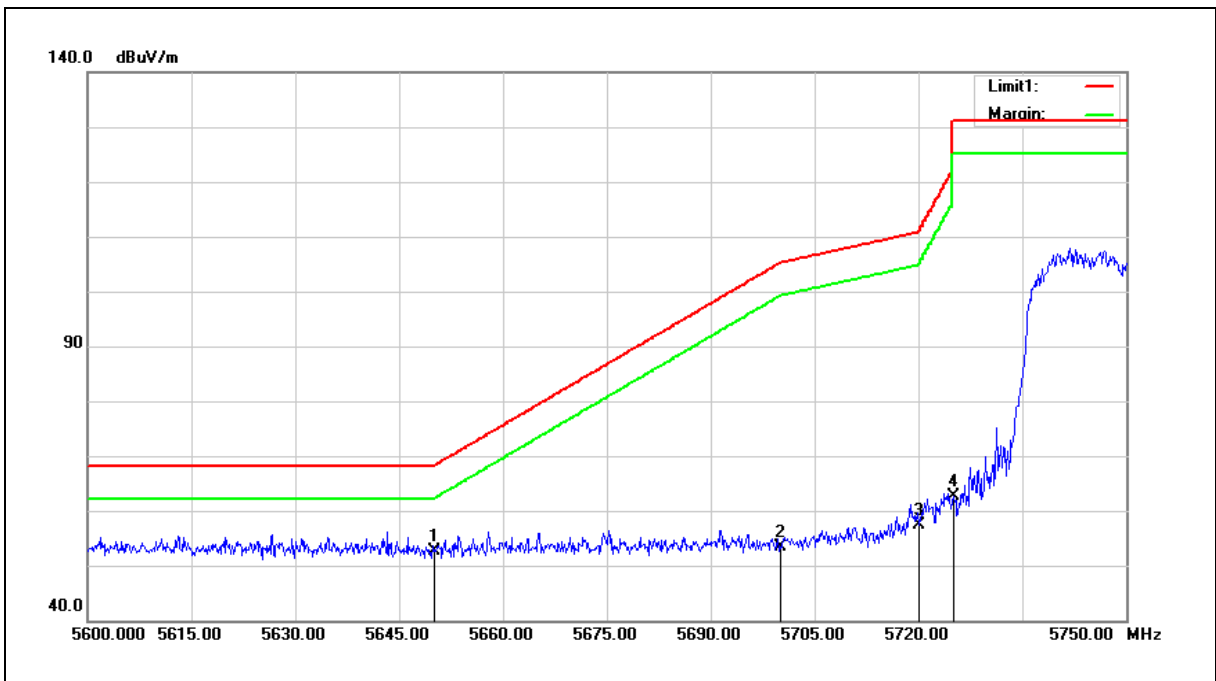

No.	Frequency (MHz)	Reading (dBuV)	Correct Factor (dB/m)	Result (dBuV/m)	Limit (dBuV/m)	Margin (dB)	Remark
1	5650.000	46.11	6.61	52.72	68.20	-15.48	peak
2	5700.000	46.56	6.71	53.27	105.20	-51.93	peak
3	5720.000	50.72	6.77	57.49	110.80	-53.31	peak
4	5725.000	55.84	6.78	62.62	122.20	-59.58	peak

Note:1.Result (dBuV/m) = Correct Factor (dB/m) + Reading(dBuV).

2.Correction factor (dB/m) = Antenna Factor (dB/m) + Cable loss (dB) – Pre-Amplifier gain (dB).

3.When the peak results are less than average limit, so not need to evaluate the average.



Standard:	FCC Part 15.407	Test Distance:	3 m
Test item:	Band edge	Power:	AC 120 V/60 Hz
Frequency:	5785 MHz	Temp.(°C)/Hum.(%RH):	26(°C)/60 %RH
Mode:	Mode 3		
Ant.Polar.:	Horizontal		

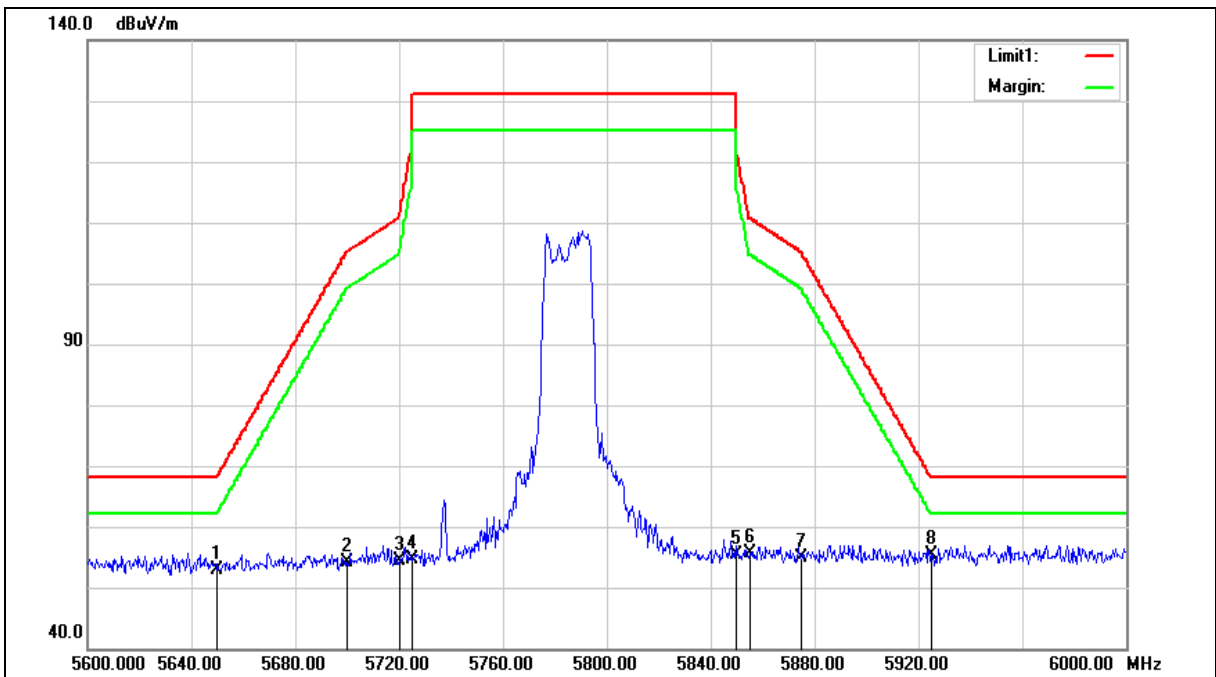



Standard:	FCC Part 15.407	Test Distance:	3 m
Test item:	Band edge	Power:	AC 120 V/60 Hz
Frequency:	5785 MHz	Temp.(°C)/Hum.(%RH):	26(°C)/60 %RH
Mode:	Mode 3		
Ant.Polar.:	Horizontal		

No.	Frequency (MHz)	Reading (dBuV)	Correct Factor (dB/m)	Result (dBuV/m)	Limit (dBuV/m)	Margin (dB)	Remark
1	5650.000	46.28	6.61	52.89	68.20	-15.31	peak
2	5700.000	47.50	6.71	54.21	105.20	-50.99	peak
3	5720.000	47.52	6.77	54.29	110.80	-56.51	peak
4	5725.000	47.86	6.78	54.64	122.20	-67.56	peak
5	5850.000	48.25	7.03	55.28	122.20	-66.92	peak
6	5855.000	48.49	7.04	55.53	110.80	-55.27	peak
7	5875.000	47.82	7.09	54.91	105.20	-50.29	peak
8	5925.000	48.28	7.20	55.48	68.20	-12.72	peak

Note:1.Result (dBuV/m) = Correct Factor (dB/m) + Reading(dBuV).

2.Correction factor (dB/m) = Antenna Factor (dB/m) + Cable loss (dB) – Pre-Amplifier gain (dB).

3.When the peak results are less than average limit, so not need to evaluate the average.



Standard:	FCC Part 15.407	Test Distance:	3 m
Test item:	Band edge	Power:	AC 120 V/60 Hz
Frequency:	5785 MHz	Temp.(°C)/Hum.(%RH):	26(°C)/60 %RH
Mode:	Mode 3		
Ant.Polar.:	Vertical		

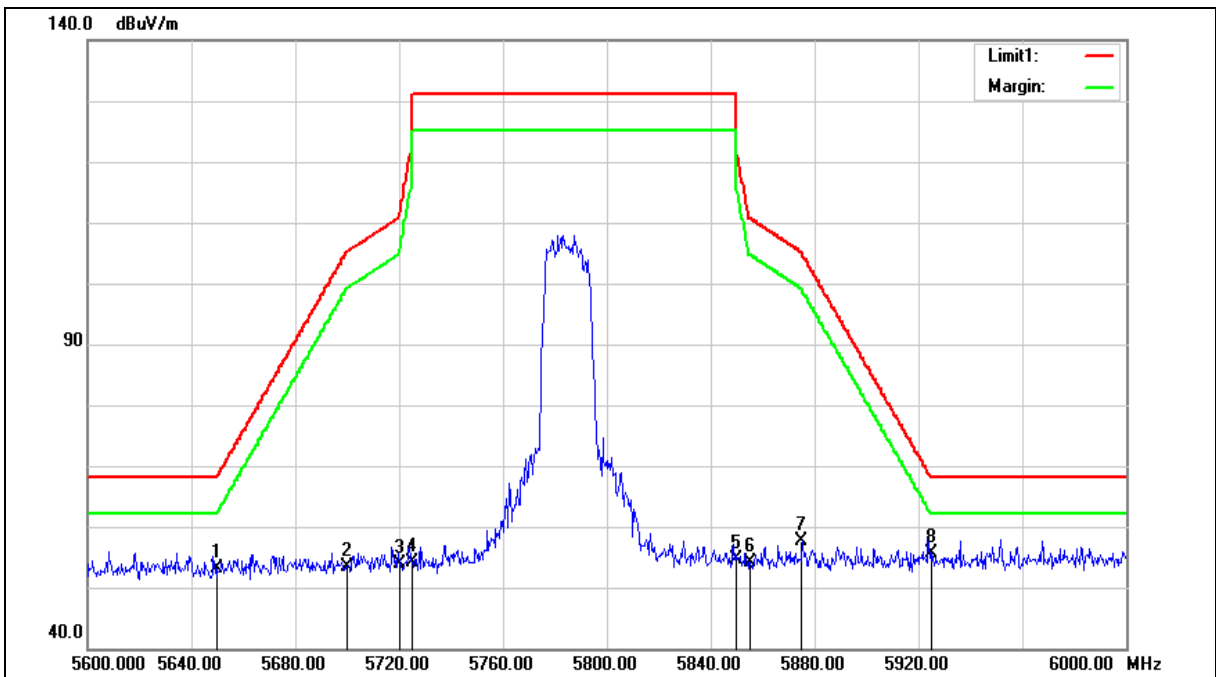



Standard:	FCC Part 15.407	Test Distance:	3 m
Test item:	Band edge	Power:	AC 120 V/60 Hz
Frequency:	5785 MHz	Temp.(°C)/Hum.(%RH):	26(°C)/60 %RH
Mode:	Mode 3		
Ant.Polar.:	Vertical		

No.	Frequency (MHz)	Reading (dBuV)	Correct Factor (dB/m)	Result (dBuV/m)	Limit (dBuV/m)	Margin (dB)	Remark
1	5650.000	46.52	6.61	53.13	68.20	-15.07	peak
2	5700.000	46.78	6.71	53.49	105.20	-51.71	peak
3	5720.000	47.20	6.77	53.97	110.80	-56.83	peak
4	5725.000	47.27	6.78	54.05	122.20	-68.15	peak
5	5850.000	47.62	7.03	54.65	122.20	-67.55	peak
6	5855.000	47.16	7.04	54.20	110.80	-56.60	peak
7	5875.000	50.66	7.09	57.75	105.20	-47.45	peak
8	5925.000	48.49	7.20	55.69	68.20	-12.51	peak

Note:1.Result (dBuV/m) = Correct Factor (dB/m) + Reading(dBuV).

2.Correction factor (dB/m) = Antenna Factor (dB/m) + Cable loss (dB) – Pre-Amplifier gain (dB).

3.When the peak results are less than average limit, so not need to evaluate the average.





Standard:	FCC Part 15.407	Test Distance:	3 m
Test item:	Band edge	Power:	AC 120 V/60 Hz
Frequency:	5825 MHz	Temp.(°C)/Hum.(%RH):	26(°C)/60 %RH
Mode:	Mode 3		
Ant.Polar.:	Horizontal		

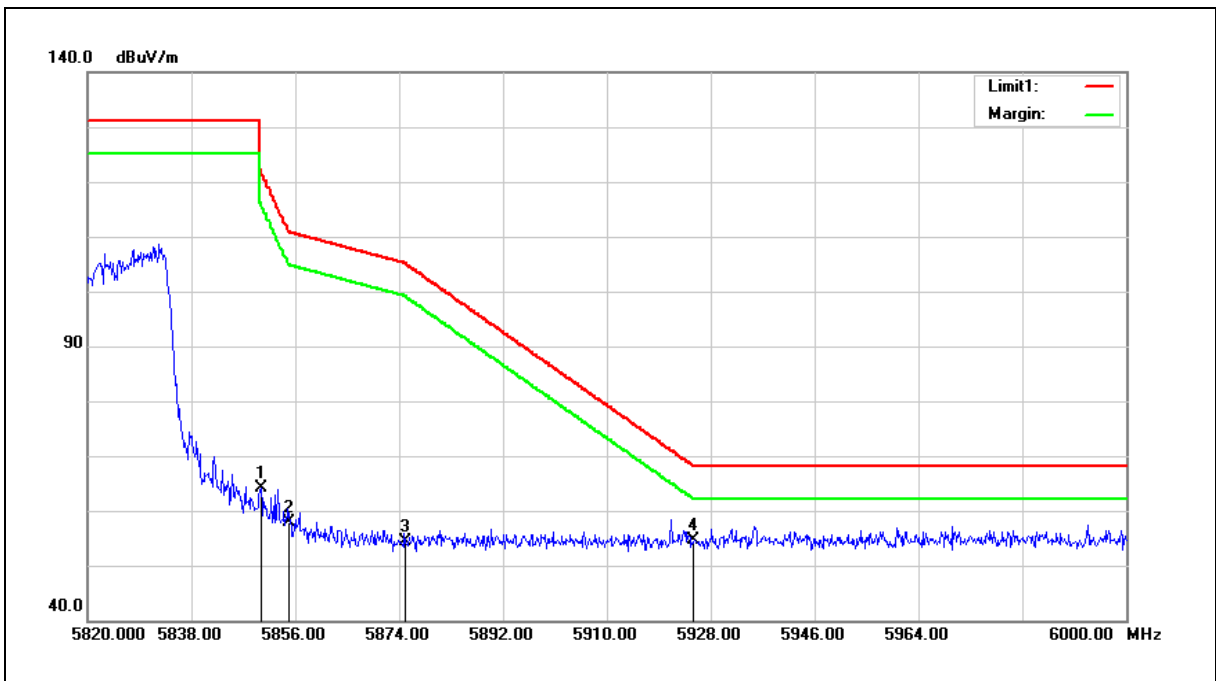

No.	Frequency (MHz)	Reading (dBuV)	Correct Factor (dB/m)	Result (dBuV/m)	Limit (dBuV/m)	Margin (dB)	Remark
1	5850.000	57.03	7.03	64.06	122.20	-58.14	peak
2	5855.000	50.86	7.04	57.90	110.80	-52.90	peak
3	5875.000	47.37	7.09	54.46	105.20	-50.74	peak
4	5925.000	47.35	7.20	54.55	68.20	-13.65	peak

Note:1.Result (dBuV/m) = Correct Factor (dB/m) + Reading(dBuV).

2.Correction factor (dB/m) = Antenna Factor (dB/m) + Cable loss (dB) – Pre-Amplifier gain (dB).

3.When the peak results are less than average limit, so not need to evaluate the average.



Standard:	FCC Part 15.407	Test Distance:	3 m
Test item:	Band edge	Power:	AC 120 V/60 Hz
Frequency:	5825 MHz	Temp.(°C)/Hum.(%RH):	26(°C)/60 %RH
Mode:	Mode 3		
Ant.Polar.:	Vertical		

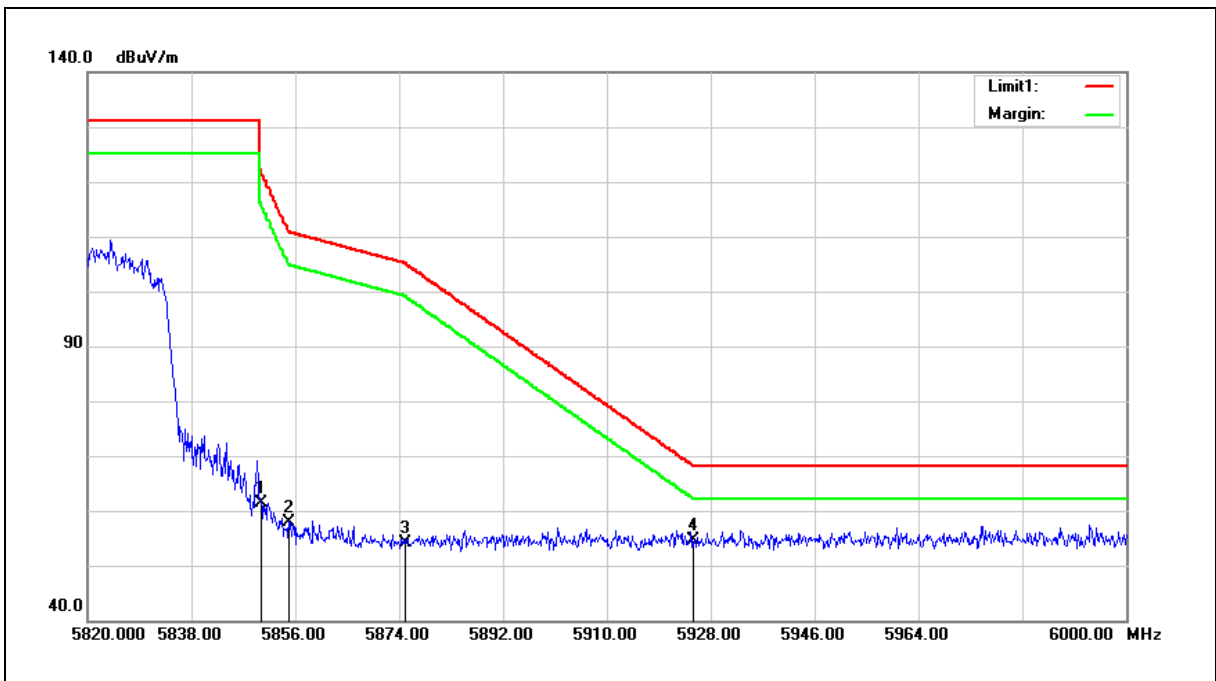

No.	Frequency (MHz)	Reading (dBuV)	Correct Factor (dB/m)	Result (dBuV/m)	Limit (dBuV/m)	Margin (dB)	Remark
1	5850.000	54.25	7.03	61.28	122.20	-60.92	peak
2	5855.000	50.88	7.04	57.92	110.80	-52.88	peak
3	5875.000	47.16	7.09	54.25	105.20	-50.95	peak
4	5925.000	47.52	7.20	54.72	68.20	-13.48	peak

Note:1.Result (dBuV/m) = Correct Factor (dB/m) + Reading(dBuV).

2.Correction factor (dB/m) = Antenna Factor (dB/m) + Cable loss (dB) – Pre-Amplifier gain (dB).

3.When the peak results are less than average limit, so not need to evaluate the average.



Standard:	FCC Part 15.407	Test Distance:	3 m
Test item:	Band edge	Power:	AC 120 V/60 Hz
Frequency:	5190 MHz	Temp.(°C)/Hum.(%RH):	26(°C)/60 %RH
Mode:	Mode 4		
Ant.Polar.:	Horizontal		

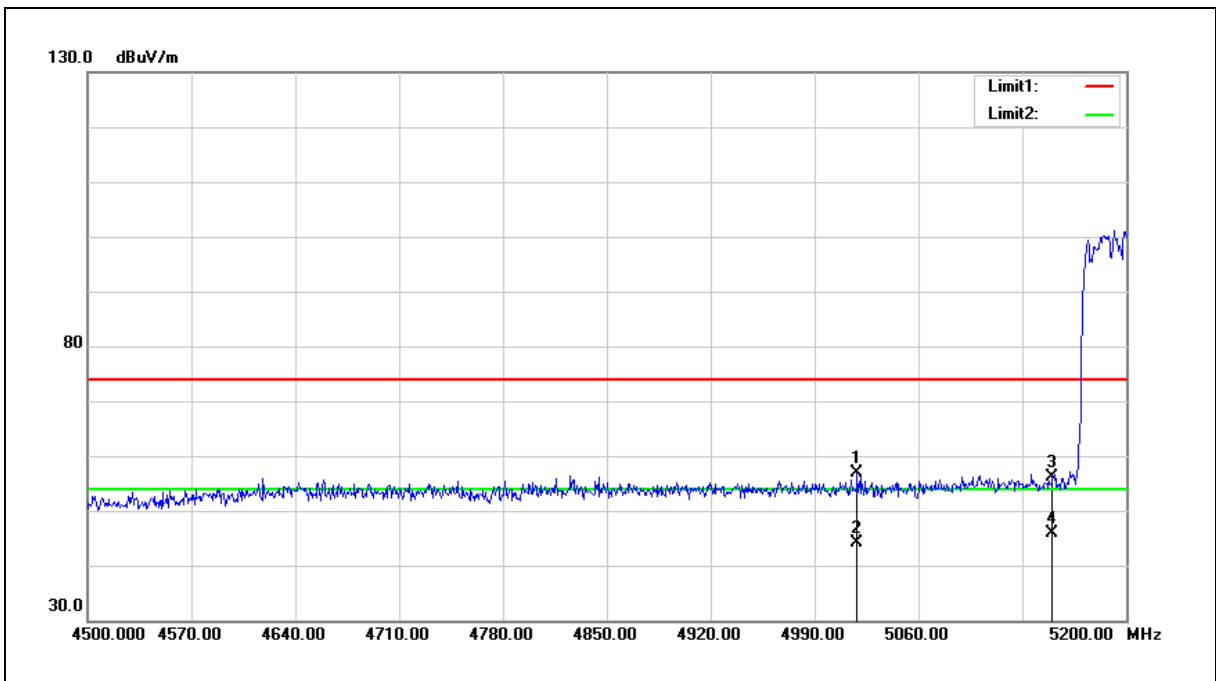

No.	Frequency (MHz)	Reading (dBuV)	Correct Factor (dB/m)	Result (dBuV/m)	Limit (dBuV/m)	Margin (dB)	Remark
1	5018.700	51.21	5.58	56.79	74.00	-17.21	peak
2	5018.700	38.53	5.58	44.11	54.00	-9.89	AVG
3	5150.000	50.46	5.78	56.24	74.00	-17.76	peak
4	5150.000	40.02	5.78	45.80	54.00	-8.20	AVG

Note:1.Result (dBuV/m) = Correct Factor (dB/m) + Reading(dBuV).

2.Correction factor (dB/m) = Antenna Factor (dB/m) + Cable loss (dB) – Pre-Amplifier gain (dB).

3.When the peak results are less than average limit, so not need to evaluate the average.



Standard:	FCC Part 15.407	Test Distance:	3 m
Test item:	Band edge	Power:	AC 120 V/60 Hz
Frequency:	5190 MHz	Temp.(°C)/Hum.(%RH):	26(°C)/60 %RH
Mode:	Mode 4		
Ant.Polar.:	Vertical		

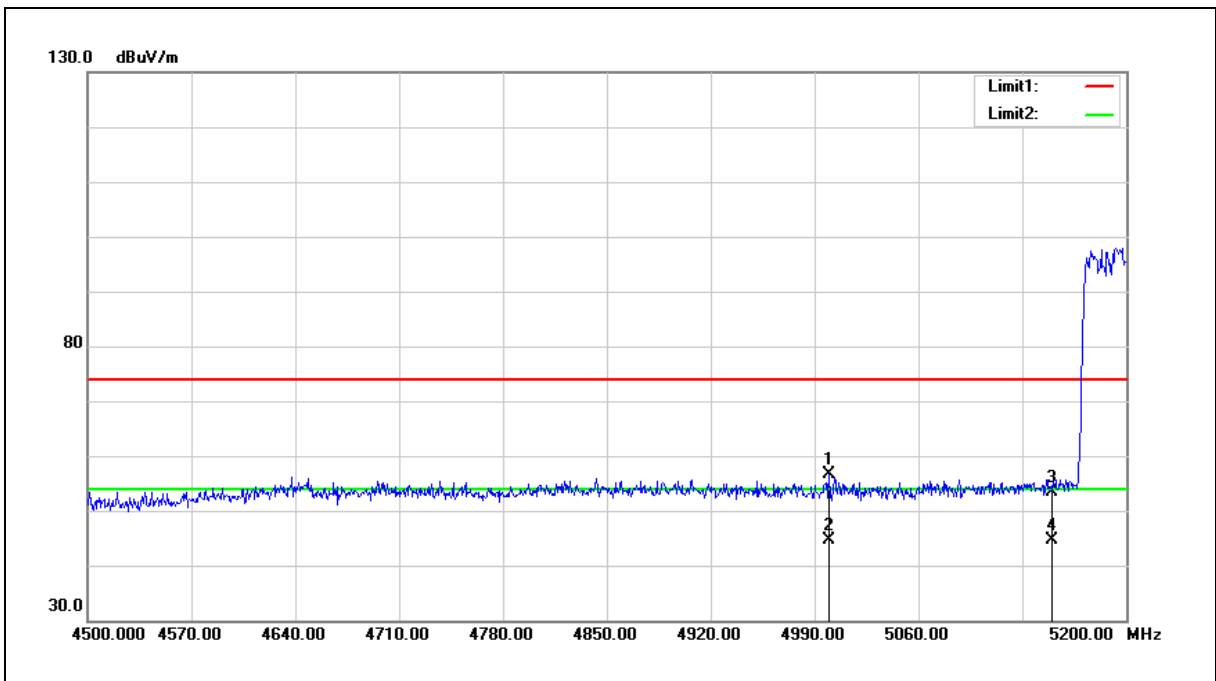

No.	Frequency (MHz)	Reading (dBuV)	Correct Factor (dB/m)	Result (dBuV/m)	Limit (dBuV/m)	Margin (dB)	Remark
1	4999.800	51.09	5.55	56.64	74.00	-17.36	peak
2	4999.800	39.08	5.55	44.63	54.00	-9.37	AVG
3	5150.000	47.69	5.78	53.47	74.00	-20.53	peak
4	5150.000	38.85	5.78	44.63	54.00	-9.37	AVG

Note:1.Result (dBuV/m) = Correct Factor (dB/m) + Reading(dBuV).

2.Correction factor (dB/m) = Antenna Factor (dB/m) + Cable loss (dB) – Pre-Amplifier gain (dB).

3.When the peak results are less than average limit, so not need to evaluate the average.



Standard:	FCC Part 15.407	Test Distance:	3 m
Test item:	Band edge	Power:	AC 120 V/60 Hz
Frequency:	5230 MHz	Temp.(°C)/Hum.(%RH):	26(°C)/60 %RH
Mode:	Mode 4		
Ant.Polar.:	Horizontal		

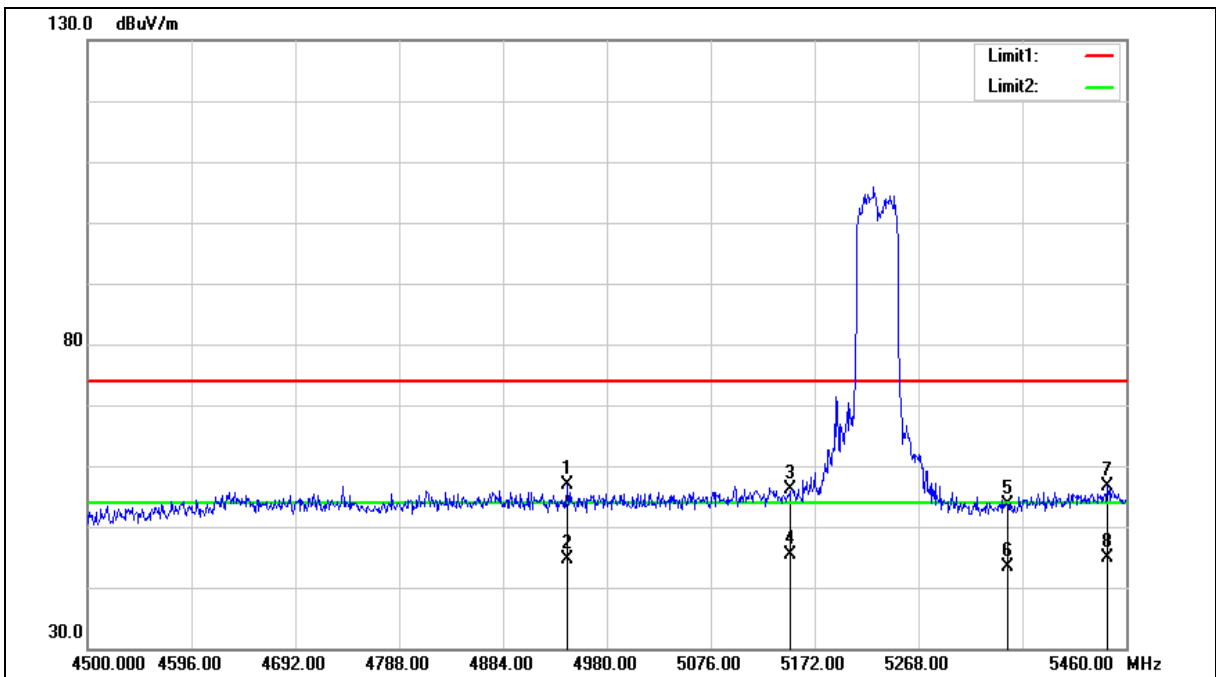



Standard:	FCC Part 15.407	Test Distance:	3 m
Test item:	Band edge	Power:	AC 120 V/60 Hz
Frequency:	5230 MHz	Temp.(°C)/Hum.(%RH):	26(°C)/60 %RH
Mode:	Mode 4		
Ant.Polar.:	Horizontal		

No.	Frequency (MHz)	Reading (dBuV)	Correct Factor (dB/m)	Result (dBuV/m)	Limit (dBuV/m)	Margin (dB)	Remark
1	4943.520	51.51	5.38	56.89	74.00	-17.11	peak
2	4943.520	39.30	5.38	44.68	54.00	-9.32	AVG
3	5150.000	50.34	5.78	56.12	74.00	-17.88	peak
4	5150.000	39.64	5.78	45.42	54.00	-8.58	AVG
5	5350.000	47.51	6.07	53.58	74.00	-20.42	peak
6	5350.000	37.19	6.07	43.26	54.00	-10.74	AVG
7	5442.720	50.34	6.21	56.55	74.00	-17.45	peak
8	5442.720	38.68	6.21	44.89	54.00	-9.11	AVG

Note:1.Result (dBuV/m) = Correct Factor (dB/m) + Reading(dBuV).

2.Correction factor (dB/m) = Antenna Factor (dB/m) + Cable loss (dB) – Pre-Amplifier gain (dB).

3.When the peak results are less than average limit, so not need to evaluate the average.



Standard:	FCC Part 15.407	Test Distance:	3 m
Test item:	Band edge	Power:	AC 120 V/60 Hz
Frequency:	5230 MHz	Temp.(°C)/Hum.(%RH):	26(°C)/60 %RH
Mode:	Mode 4		
Ant.Polar.:	Vertical		

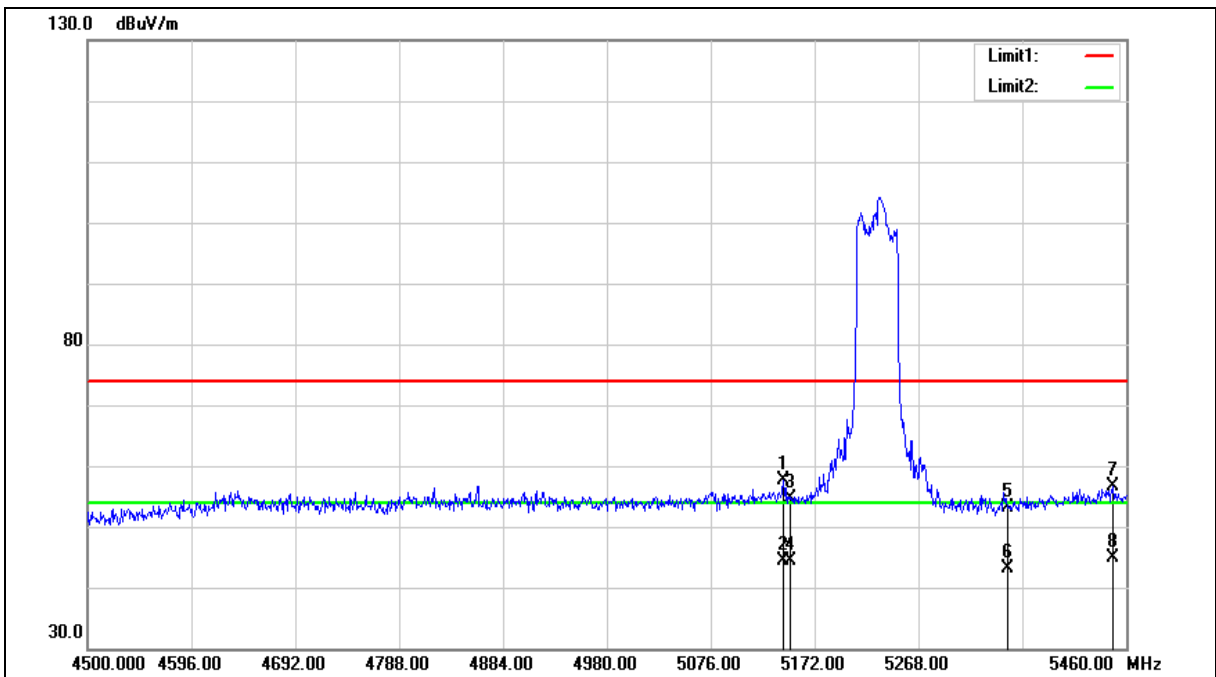



Standard:	FCC Part 15.407	Test Distance:	3 m
Test item:	Band edge	Power:	AC 120 V/60 Hz
Frequency:	5230 MHz	Temp.(°C)/Hum.(%RH):	26(°C)/60 %RH
Mode:	Mode 4		
Ant.Polar.:	Vertical		

No.	Frequency (MHz)	Reading (dBuV)	Correct Factor (dB/m)	Result (dBuV/m)	Limit (dBuV/m)	Margin (dB)	Remark
1	5143.200	51.91	5.77	57.68	74.00	-16.32	peak
2	5143.200	38.66	5.77	44.43	54.00	-9.57	AVG
3	5150.000	48.90	5.78	54.68	74.00	-19.32	peak
4	5150.000	38.56	5.78	44.34	54.00	-9.66	AVG
5	5350.000	47.12	6.07	53.19	74.00	-20.81	peak
6	5350.000	37.11	6.07	43.18	54.00	-10.82	AVG
7	5447.520	50.44	6.22	56.66	74.00	-17.34	peak
8	5447.520	38.57	6.22	44.79	54.00	-9.21	AVG

Note:1.Result (dBuV/m) = Correct Factor (dB/m) + Reading(dBuV).

2.Correction factor (dB/m) = Antenna Factor (dB/m) + Cable loss (dB) – Pre-Amplifier gain (dB).

3.When the peak results are less than average limit, so not need to evaluate the average.





Standard:	FCC Part 15.407	Test Distance:	3 m
Test item:	Band edge	Power:	AC 120 V/60 Hz
Frequency:	5755 MHz	Temp.(°C)/Hum.(%RH):	26(°C)/60 %RH
Mode:	Mode 4		
Ant.Polar.:	Horizontal		

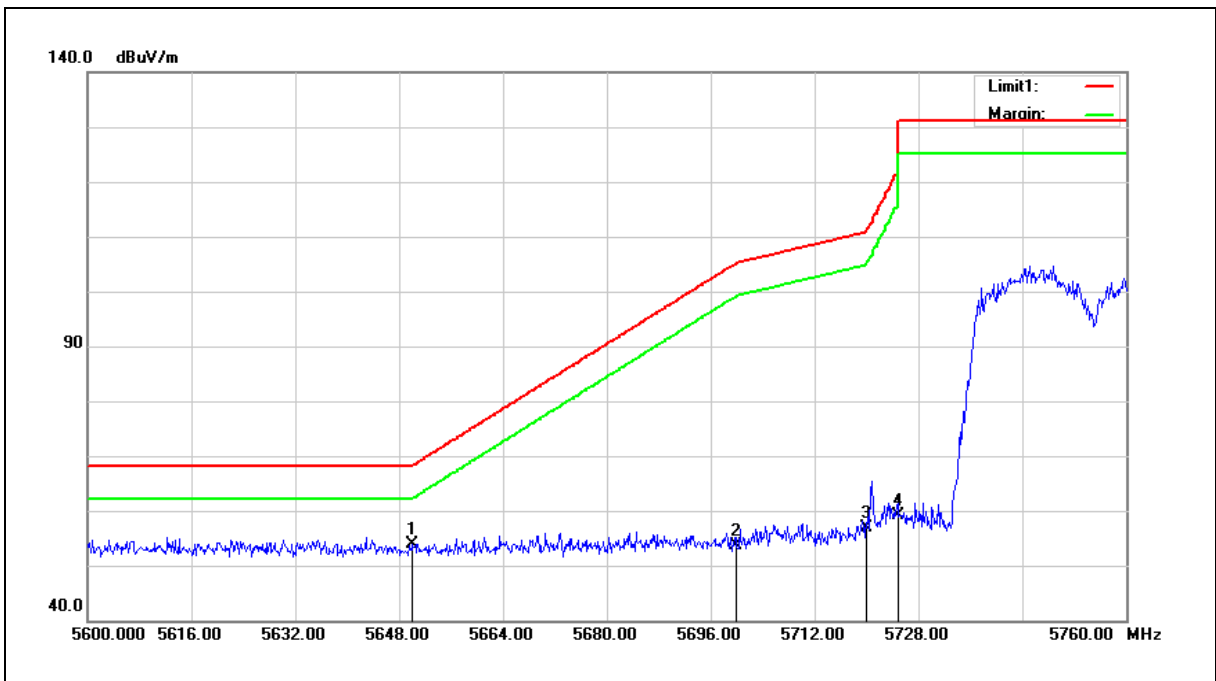

No.	Frequency (MHz)	Reading (dBuV)	Correct Factor (dB/m)	Result (dBuV/m)	Limit (dBuV/m)	Margin (dB)	Remark
1	5650.000	47.28	6.61	53.89	68.20	-14.31	peak
2	5700.000	46.89	6.71	53.60	105.20	-51.60	peak
3	5720.000	50.10	6.77	56.87	110.80	-53.93	peak
4	5725.000	52.30	6.78	59.08	122.20	-63.12	peak

Note:1.Result (dBuV/m) = Correct Factor (dB/m) + Reading(dBuV).

2.Correction factor (dB/m) = Antenna Factor (dB/m) + Cable loss (dB) – Pre-Amplifier gain (dB).

3.When the peak results are less than average limit, so not need to evaluate the average.



Standard:	FCC Part 15.407	Test Distance:	3 m
Test item:	Band edge	Power:	AC 120 V/60 Hz
Frequency:	5755 MHz	Temp.(°C)/Hum.(%RH):	26(°C )/60 %RH
Mode:	Mode 4		
Ant.Polar.:	Vertical		

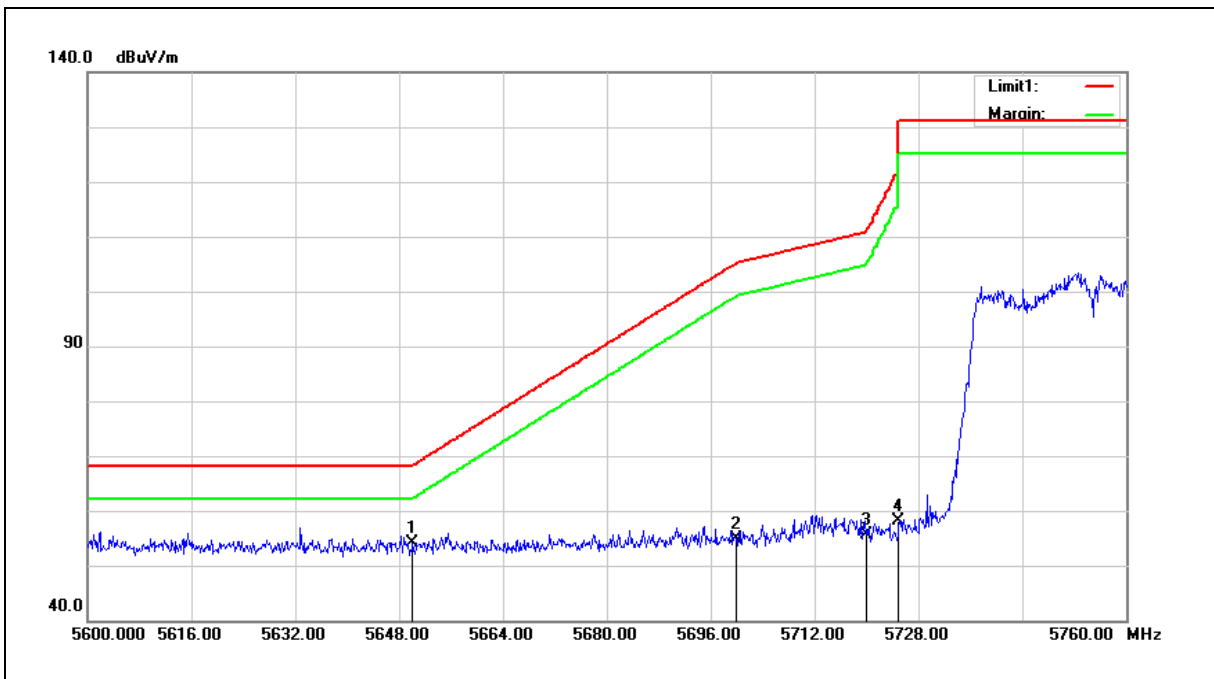

No.	Frequency (MHz)	Reading (dBuV)	Correct Factor (dB/m)	Result (dBuV/m)	Limit (dBuV/m)	Margin (dB)	Remark
1	5650.000	47.59	6.61	54.20	68.20	-14.00	peak
2	5700.000	48.18	6.71	54.89	105.20	-50.31	peak
3	5720.000	48.86	6.77	55.63	110.80	-55.17	peak
4	5725.000	51.26	6.78	58.04	122.20	-64.16	peak

Note:1.Result (dBuV/m) = Correct Factor (dB/m) + Reading(dBuV).

2.Correction factor (dB/m) = Antenna Factor (dB/m) + Cable loss (dB) – Pre-Amplifier gain (dB).

3.When the peak results are less than average limit, so not need to evaluate the average.



Standard:	FCC Part 15.407	Test Distance:	3 m
Test item:	Band edge	Power:	AC 120 V/60 Hz
Frequency:	5795 MHz	Temp.(°C)/Hum.(%RH):	26(°C)/60 %RH
Mode:	Mode 4		
Ant.Polar.:	Horizontal		

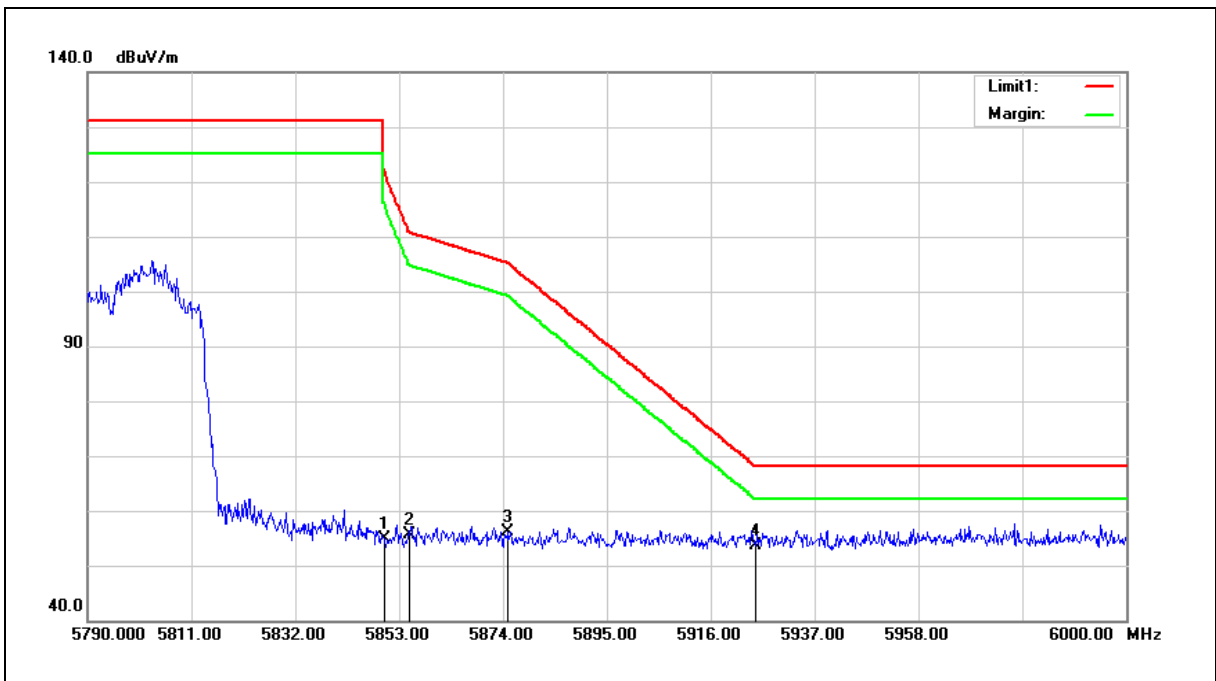

No.	Frequency (MHz)	Reading (dBuV)	Correct Factor (dB/m)	Result (dBuV/m)	Limit (dBuV/m)	Margin (dB)	Remark
1	5850.000	47.82	7.03	54.85	122.20	-67.35	peak
2	5855.000	48.50	7.04	55.54	110.80	-55.26	peak
3	5875.000	49.10	7.09	56.19	105.20	-49.01	peak
4	5925.000	46.32	7.20	53.52	68.20	-14.68	peak

Note:1.Result (dBuV/m) = Correct Factor (dB/m) + Reading(dBuV).

2.Correction factor (dB/m) = Antenna Factor (dB/m) + Cable loss (dB) – Pre-Amplifier gain (dB).

3.When the peak results are less than average limit, so not need to evaluate the average.



Standard:	FCC Part 15.407	Test Distance:	3 m
Test item:	Band edge	Power:	AC 120 V/60 Hz
Frequency:	5795 MHz	Temp.(°C)/Hum.(%RH):	26(°C)/60 %RH
Mode:	Mode 4		
Ant.Polar.:	Vertical		

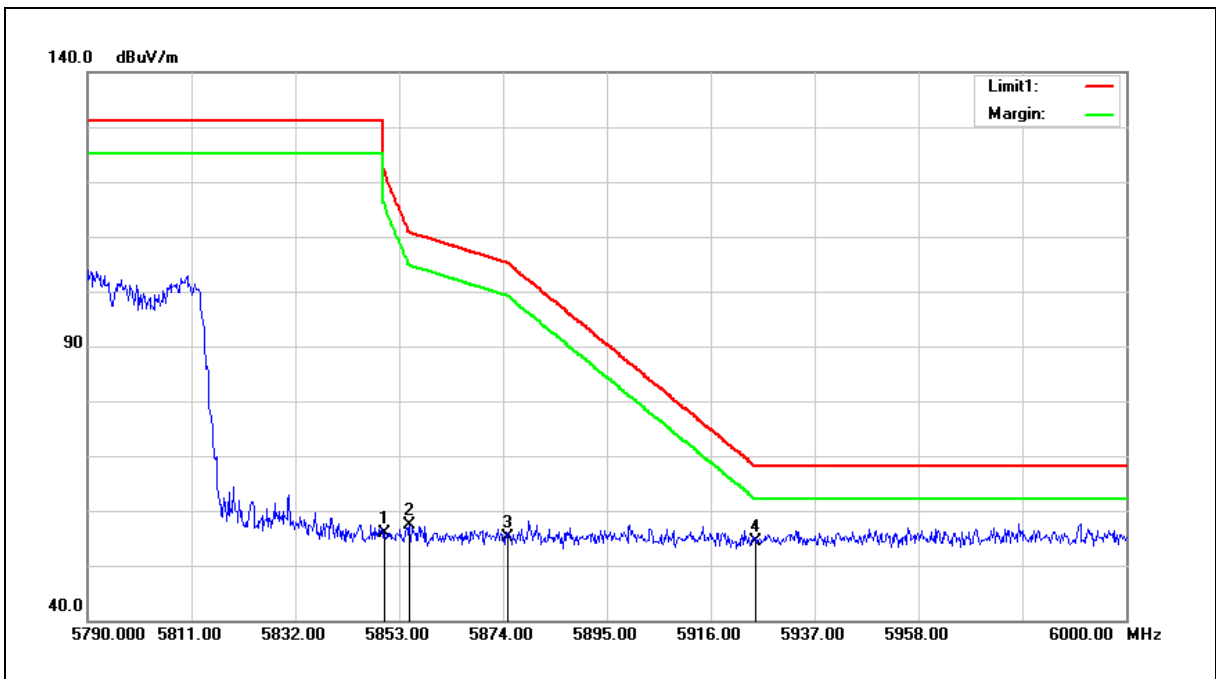

No.	Frequency (MHz)	Reading (dBuV)	Correct Factor (dB/m)	Result (dBuV/m)	Limit (dBuV/m)	Margin (dB)	Remark
1	5850.000	48.97	7.03	56.00	122.20	-66.20	peak
2	5855.000	50.37	7.04	57.41	110.80	-53.39	peak
3	5875.000	48.11	7.09	55.20	105.20	-50.00	peak
4	5925.000	47.22	7.20	54.42	68.20	-13.78	peak

Note:1.Result (dBuV/m) = Correct Factor (dB/m) + Reading(dBuV).

2.Correction factor (dB/m) = Antenna Factor (dB/m) + Cable loss (dB) – Pre-Amplifier gain (dB).

3.When the peak results are less than average limit, so not need to evaluate the average.



Standard:	FCC Part 15.407	Test Distance:	3 m
Test item:	Band edge	Power:	AC 120 V/60 Hz
Frequency:	5210 MHz	Temp.(°C)/Hum.(%RH):	26(°C)/60 %RH
Mode:	Mode 5		
Ant.Polar.:	Horizontal		

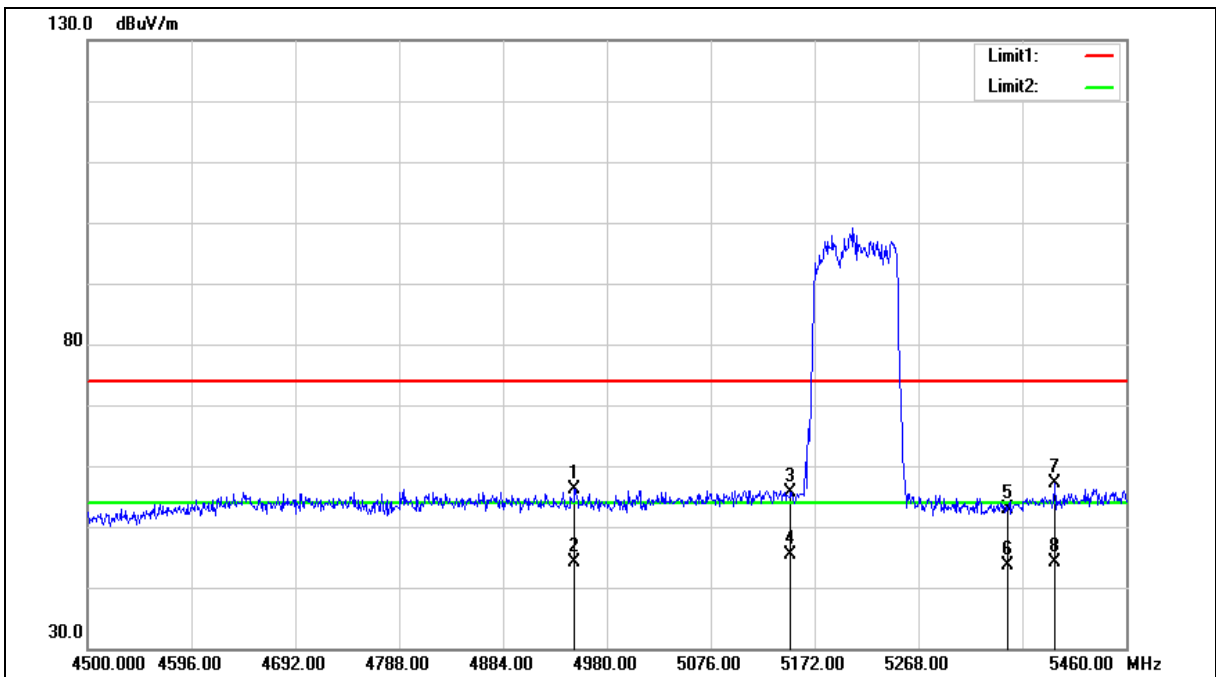



Standard:	FCC Part 15.407	Test Distance:	3 m
Test item:	Band edge	Power:	AC 120 V/60 Hz
Frequency:	5210 MHz	Temp.(°C)/Hum.(%RH):	26(°C)/60 %RH
Mode:	Mode 5		
Ant.Polar.:	Horizontal		

No.	Frequency (MHz)	Reading (dBuV)	Correct Factor (dB/m)	Result (dBuV/m)	Limit (dBuV/m)	Margin (dB)	Remark
1	4950.240	50.84	5.39	56.23	74.00	-17.77	peak
2	4950.240	38.73	5.39	44.12	54.00	-9.88	AVG
3	5150.000	49.92	5.78	55.70	74.00	-18.30	peak
4	5150.000	39.57	5.78	45.35	54.00	-8.65	AVG
5	5350.000	46.89	6.07	52.96	74.00	-21.04	peak
6	5350.000	37.66	6.07	43.73	54.00	-10.27	AVG
7	5393.760	51.09	6.14	57.23	74.00	-16.77	peak
8	5393.760	37.96	6.14	44.10	54.00	-9.90	AVG

Note:1.Result (dBuV/m) = Correct Factor (dB/m) + Reading(dBuV).

2.Correction factor (dB/m) = Antenna Factor (dB/m) + Cable loss (dB) – Pre-Amplifier gain (dB).

3.When the peak results are less than average limit, so not need to evaluate the average.



Standard:	FCC Part 15.407	Test Distance:	3 m
Test item:	Band edge	Power:	AC 120 V/60 Hz
Frequency:	5210 MHz	Temp.(°C)/Hum.(%RH):	26(°C)/60 %RH
Mode:	Mode 5		
Ant.Polar.:	Vertical		

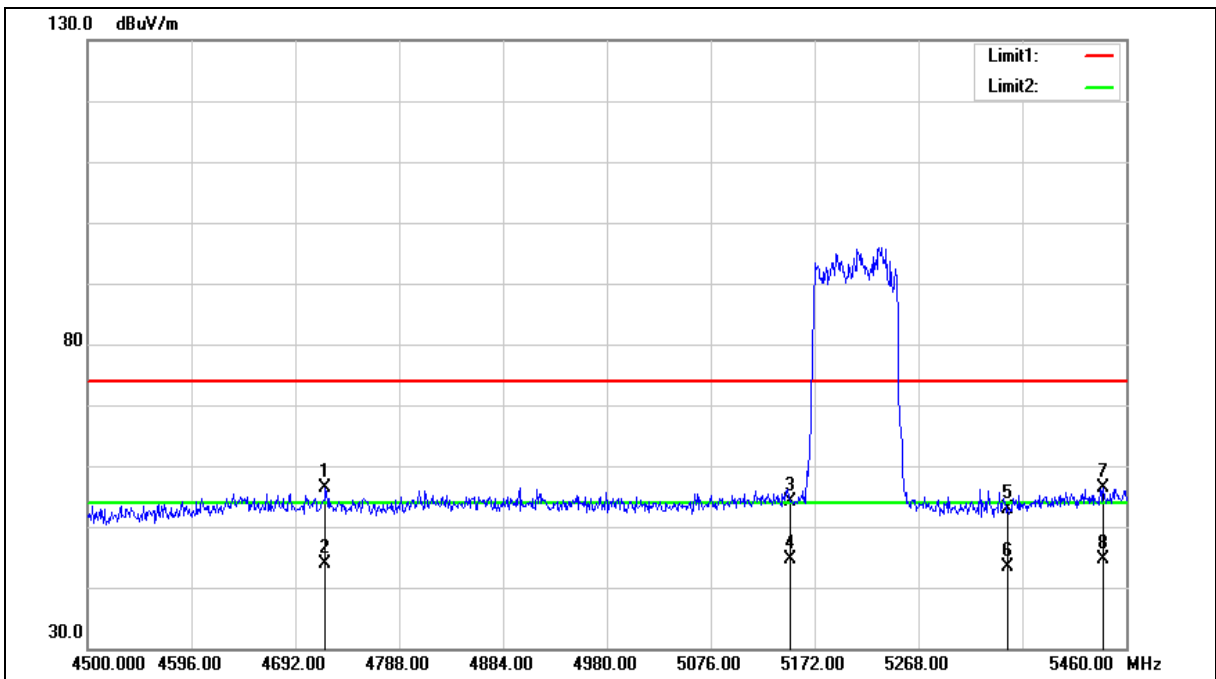



Standard:	FCC Part 15.407	Test Distance:	3 m
Test item:	Band edge	Power:	AC 120 V/60 Hz
Frequency:	5210 MHz	Temp.(°C)/Hum.(%RH):	26(°C)/60 %RH
Mode:	Mode 5		
Ant.Polar.:	Vertical		

No.	Frequency (MHz)	Reading (dBuV)	Correct Factor (dB/m)	Result (dBuV/m)	Limit (dBuV/m)	Margin (dB)	Remark
1	4719.840	51.68	4.66	56.34	74.00	-17.66	peak
2	4719.840	39.29	4.66	43.95	54.00	-10.05	AVG
3	5150.000	48.24	5.78	54.02	74.00	-19.98	peak
4	5150.000	38.84	5.78	44.62	54.00	-9.38	AVG
5	5350.000	46.88	6.07	52.95	74.00	-21.05	peak
6	5350.000	37.19	6.07	43.26	54.00	-10.74	AVG
7	5438.880	50.16	6.20	56.36	74.00	-17.64	peak
8	5438.880	38.51	6.20	44.71	54.00	-9.29	AVG

Note:1.Result (dBuV/m) = Correct Factor (dB/m) + Reading(dBuV).

2.Correction factor (dB/m) = Antenna Factor (dB/m) + Cable loss (dB) – Pre-Amplifier gain (dB).

3.When the peak results are less than average limit, so not need to evaluate the average.





Standard:	FCC Part 15.407	Test Distance:	3 m
Test item:	Band edge	Power:	AC 120 V/60 Hz
Frequency:	5775 MHz	Temp.(°C)/Hum.(%RH):	26(°C)/60 %RH
Mode:	Mode 5		
Ant.Polar.:	Horizontal		

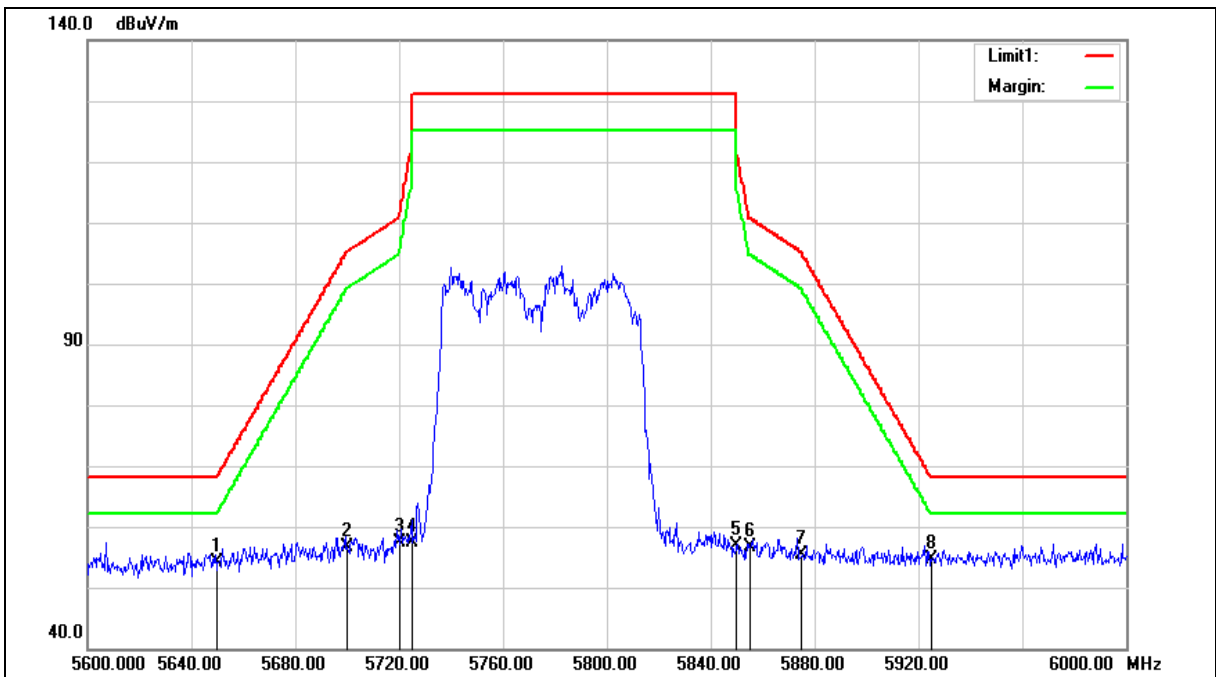



Standard:	FCC Part 15.407	Test Distance:	3 m
Test item:	Band edge	Power:	AC 120 V/60 Hz
Frequency:	5775 MHz	Temp.(°C)/Hum.(%RH):	26(°C)/60 %RH
Mode:	Mode 5		
Ant.Polar.:	Horizontal		

No.	Frequency (MHz)	Reading (dBuV)	Correct Factor (dB/m)	Result (dBuV/m)	Limit (dBuV/m)	Margin (dB)	Remark
1	5650.000	47.63	6.61	54.24	68.20	-13.96	peak
2	5700.000	49.90	6.71	56.61	105.20	-48.59	peak
3	5720.000	50.61	6.77	57.38	110.80	-53.42	peak
4	5725.000	50.55	6.78	57.33	122.20	-64.87	peak
5	5850.000	49.87	7.03	56.90	122.20	-65.30	peak
6	5855.000	49.64	7.04	56.68	110.80	-54.12	peak
7	5875.000	48.29	7.09	55.38	105.20	-49.82	peak
8	5925.000	47.47	7.20	54.67	68.20	-13.53	peak

Note:1.Result (dBuV/m) = Correct Factor (dB/m) + Reading(dBuV).

2.Correction factor (dB/m) = Antenna Factor (dB/m) + Cable loss (dB) – Pre-Amplifier gain (dB).

3.When the peak results are less than average limit, so not need to evaluate the average.



Standard:	FCC Part 15.407	Test Distance:	3 m
Test item:	Band edge	Power:	AC 120 V/60 Hz
Frequency:	5775 MHz	Temp.(°C)/Hum.(%RH):	26(°C)/60 %RH
Mode:	Mode 5		
Ant.Polar.:	Vertical		

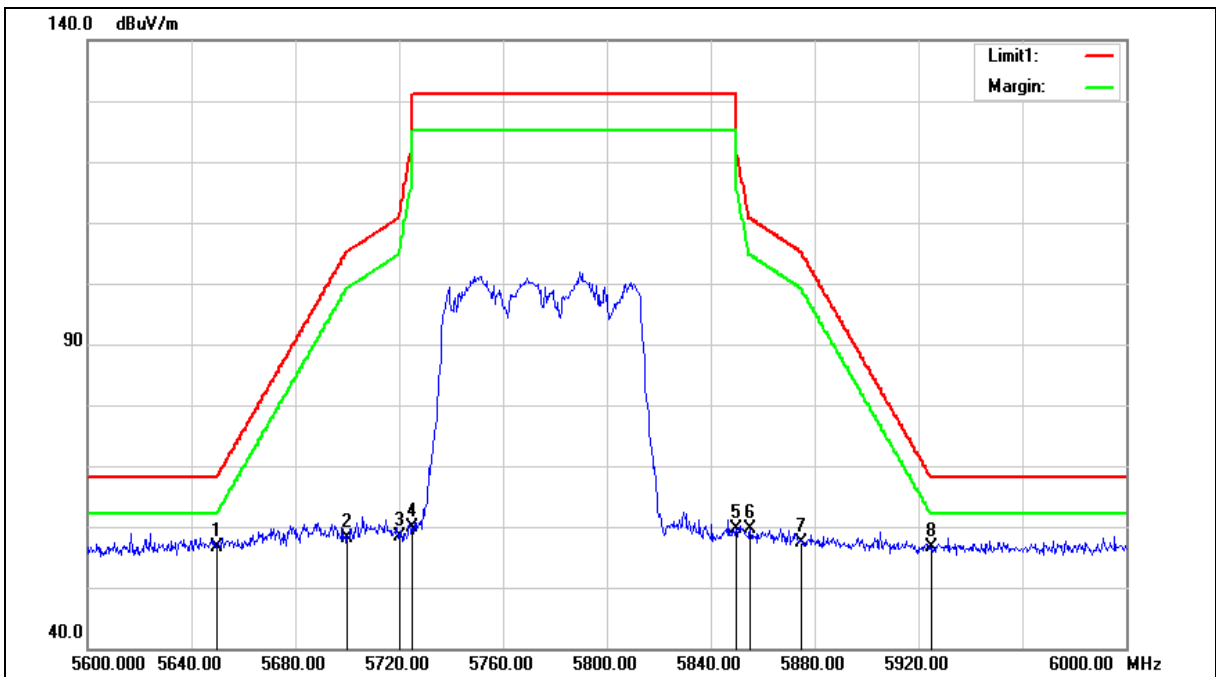



Standard:	FCC Part 15.407	Test Distance:	3 m
Test item:	Band edge	Power:	AC 120 V/60 Hz
Frequency:	5775 MHz	Temp.(°C)/Hum.(%RH):	26(°C)/60 %RH
Mode:	Mode 5		
Ant.Polar.:	Vertical		

No.	Frequency (MHz)	Reading (dBuV)	Correct Factor (dB/m)	Result (dBuV/m)	Limit (dBuV/m)	Margin (dB)	Remark
1	5650.000	50.06	6.61	56.67	68.20	-11.53	peak
2	5700.000	51.33	6.71	58.04	105.20	-47.16	peak
3	5720.000	51.49	6.77	58.26	110.80	-52.54	peak
4	5725.000	53.01	6.78	59.79	122.20	-62.41	peak
5	5850.000	52.49	7.03	59.52	122.20	-62.68	peak
6	5855.000	52.51	7.04	59.55	110.80	-51.25	peak
7	5875.000	50.25	7.09	57.34	105.20	-47.86	peak
8	5925.000	49.32	7.20	56.52	68.20	-11.68	peak

Note:1.Result (dBuV/m) = Correct Factor (dB/m) + Reading(dBuV).

2.Correction factor (dB/m) = Antenna Factor (dB/m) + Cable loss (dB) – Pre-Amplifier gain (dB).

3.When the peak results are less than average limit, so not need to evaluate the average.



### 5.3. Maximum Conducted Output Power Measurement

Test Mode		Mode 2: IEEE 802.11a Continuous TX mode						FCC Limit (dBm)
Frequency (MHz)	Data Rate	ANT-0		ANT-1		ANT-0+1		
		Max. Output Power						
		(dBm)	(W)	(dBm)	(W)	(dBm)	(W)	
5180	6 M	20.46	0.111	20.41	0.110	23.45	0.221	≤ 30
5200		21.55	0.143	21.80	0.151	24.69	0.294	
5220		21.71	0.148	22.09	0.162	<b>24.91</b>	<b>0.310</b>	
5240		21.60	0.145	21.81	0.152	24.72	0.296	
5745		22.07	0.161	21.79	0.151	<b>24.94</b>	<b>0.312</b>	≤ 30
5765		21.81	0.152	21.66	0.147	24.75	0.298	
5785		21.82	0.152	21.47	0.140	24.66	0.292	
5805		21.61	0.145	21.43	0.139	24.53	0.284	
5825		21.58	0.144	21.52	0.142	24.56	0.286	
5180		54 M	20.40	0.110	20.27	0.106	23.35	
5200	21.48		0.141	21.69	0.148	24.60	0.288	
5220	21.61		0.145	21.93	0.156	24.78	0.301	
5240	21.47		0.140	21.65	0.146	24.57	0.286	
5745	22.00		0.158	21.71	0.148	24.87	0.307	≤ 30
5765	21.68		0.147	21.55	0.143	24.63	0.290	
5785	21.70		0.148	21.39	0.138	24.56	0.286	
5805	21.52		0.142	21.37	0.137	24.46	0.279	
5825	21.53		0.142	21.44	0.139	24.50	0.282	

Note: The relevant measured result has the offset with cable loss already.



Test Mode		Mode 3: IEEE 802.11ac 20 MHz Continuous TX mode						FCC Limit (dBm)
Frequency (MHz)	Data Rate	ANT-0		ANT-1		ANT-0+1		
		Max. Output Power						
		(dBm)	(W)	(dBm)	(W)	(dBm)	(W)	
5180	13 M	20.30	0.107	19.96	0.099	23.14	0.206	≤ 30
5200		21.68	0.147	21.79	0.151	<b>24.75</b>	<b>0.298</b>	
5220		21.55	0.143	21.62	0.145	24.60	0.288	
5240		21.14	0.130	20.89	0.123	24.03	0.253	≤ 30
5745		22.61	0.182	22.13	0.163	<b>25.39</b>	<b>0.346</b>	
5765		22.54	0.179	22.02	0.159	25.30	0.339	
5785		22.36	0.172	22.02	0.159	25.20	0.331	
5805		22.31	0.170	22.39	0.173	25.36	0.344	
5825		21.97	0.157	22.44	0.175	25.22	0.333	
5180	173.4 M	20.21	0.105	19.82	0.096	23.03	0.201	≤ 30
5200		21.54	0.143	21.65	0.146	24.61	0.289	
5220		21.46	0.140	21.53	0.142	24.51	0.282	
5240		21.02	0.126	20.77	0.119	23.91	0.246	≤ 30
5745		22.53	0.179	22.06	0.161	25.31	0.340	
5765		22.42	0.175	21.96	0.157	25.21	0.332	
5785		22.30	0.170	21.95	0.157	25.14	0.326	
5805		22.19	0.166	22.27	0.169	25.24	0.334	
5825		21.85	0.153	22.32	0.171	25.10	0.324	

Note: The relevant measured result has the offset with cable loss already.



Test Mode		Mode 4: IEEE 802.11ac 40 MHz Continuous TX mode						FCC Limit (dBm)
Frequency (MHz)	Data Rate	ANT-0		ANT-1		ANT-0+1		
		Max. Output Power						
		(dBm)	(W)	(dBm)	(W)	(dBm)	(W)	
5190	27 M	17.40	0.055	17.31	0.054	20.37	0.109	≤ 30
5230		21.10	0.129	20.89	0.123	<b>24.01</b>	<b>0.252</b>	
5755		21.27	0.134	20.70	0.117	<b>24.00</b>	<b>0.251</b>	≤ 30
5795		20.76	0.119	20.33	0.108	23.56	0.227	
5190	400 M	17.29	0.054	17.20	0.052	20.26	0.106	≤ 30
5230		20.97	0.125	20.80	0.120	23.90	0.245	
5755		21.21	0.132	20.62	0.115	23.94	0.247	≤ 30
5755		20.70	0.117	20.26	0.106	23.50	0.224	

Test Mode		Mode 5: IEEE 802.11ac 80 MHz Continuous TX mode						FCC Limit (dBm)
Frequency (MHz)	Data Rate	ANT-0		ANT-1		ANT-0+1		
		Max. Output Power						
		(dBm)	(W)	(dBm)	(W)	(dBm)	(W)	
5210	58.6 M	17.41	0.055	17.60	0.058	<b>20.52</b>	<b>0.113</b>	≤ 30
5775		20.60	0.115	20.46	0.111	<b>23.54</b>	<b>0.226</b>	≤ 30
5210	866.6 M	17.33	0.054	17.52	0.056	20.44	0.111	≤ 30
5775		20.53	0.113	20.40	0.110	23.48	0.223	≤ 30

Note: The relevant measured result has the offset with cable loss already.



Beamforming on

Test Mode		Mode 3: IEEE 802.11ac 20 MHz Continuous TX mode						FCC Limit (dBm)
Frequency (MHz)	Data Rate	ANT-0		ANT-1		ANT-0+1		
		Max. Output Power						
		(dBm)	(W)	(dBm)	(W)	(dBm)	(W)	
5180	13 M	16.79	0.048	17.10	0.051	19.96	0.099	≤ 28.05
5200		18.54	0.071	18.62	0.073	<b>21.59</b>	<b>0.144</b>	
5220		18.42	0.070	18.61	0.073	21.53	0.142	
5240		17.74	0.059	17.80	0.060	20.78	0.120	
5745		19.21	0.083	19.16	0.082	22.20	0.166	≤ 27.74
5765		19.25	0.084	19.11	0.081	22.19	0.166	
5785		19.14	0.082	19.05	0.080	22.11	0.162	
5805		19.29	0.085	19.23	0.084	<b>22.27</b>	<b>0.169</b>	
5825		18.92	0.078	19.09	0.081	22.02	0.159	
5180		173.4 M	16.71	0.047	17.00	0.050	19.87	
5200	18.47		0.070	18.57	0.072	21.53	0.142	
5220	18.35		0.068	18.54	0.071	21.46	0.140	
5240	17.70		0.059	17.73	0.059	20.73	0.118	
5745	19.16		0.082	19.10	0.081	22.14	0.164	≤ 27.74
5765	19.18		0.083	19.03	0.080	22.12	0.163	
5785	19.10		0.081	18.96	0.079	22.04	0.160	
5805	19.20		0.083	19.15	0.082	22.19	0.165	
5825	18.84		0.077	19.02	0.080	21.94	0.156	

Note: The relevant measured result has the offset with cable loss already.