

Onity Serene™ Lock

User Manual

for ANSI & EURO Installations

1 Product Overview

Onity's new Serene lock combines an elegant aesthetic with state-of-the-art technology that communicates directly with the front desk via Bluetooth® through Onity's DirectKey™ technology. This document covers Serene product specifications, operation, maintenance, and regulatory information.

Serene locks are integrated with DirectKey (Bluetooth), a mobile key solution. Using a hotel-provided or downloadable app, guests can download their assigned key to their mobile devices to access their room and other access-controlled areas.



1.1 Features

- Compatible with Onity OnPortal™ front desk system
- DirectKey™ module technology allows Bluetooth access to rooms and wall readers
- Meets global standards for data privacy for all business regions
- Supports audit trail for last 3,000 openings
- Reading technology: Bluetooth and contactless RFID (ISO/ICE14443A)
- Supports Bluetooth technology, MIFARE Plus® and MIFARE Ultralight C cards
- Serene is ADA-compliant, utilizing an ADA-opening timer
- Serene utilizes card encryption as well as Bluetooth technology
- Available in a variety of finishes

1.2 General Product Specifications

Basic Specs	
Operating Temperature	-30°C to 75°C (-22°F to 167°F)
Humidity	60°C (140°F) at 95% RH (relative humidity)
Storage Temperature	-40°C to 85°C (-40°F to 185°F)
Operating Voltage	Four AA alkaline batteries
Battery Life	Approximately 2 years
Minimum Door Thickness	1.38" (35 mm)
Dimensions	See following page



Serene Dimensions

ANSI

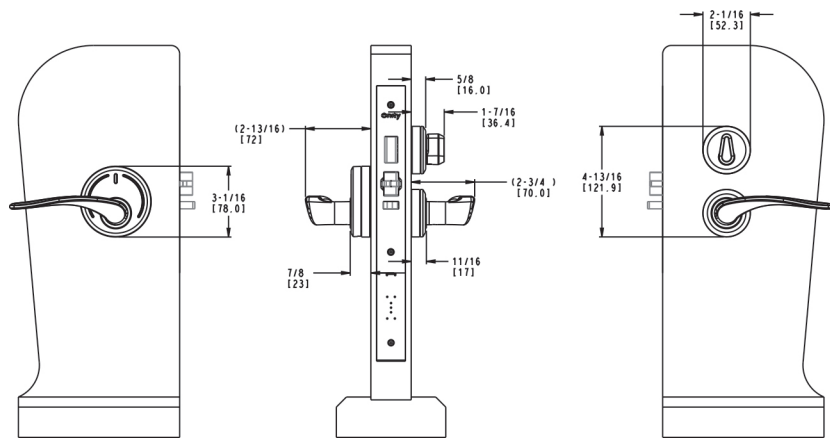

EURO

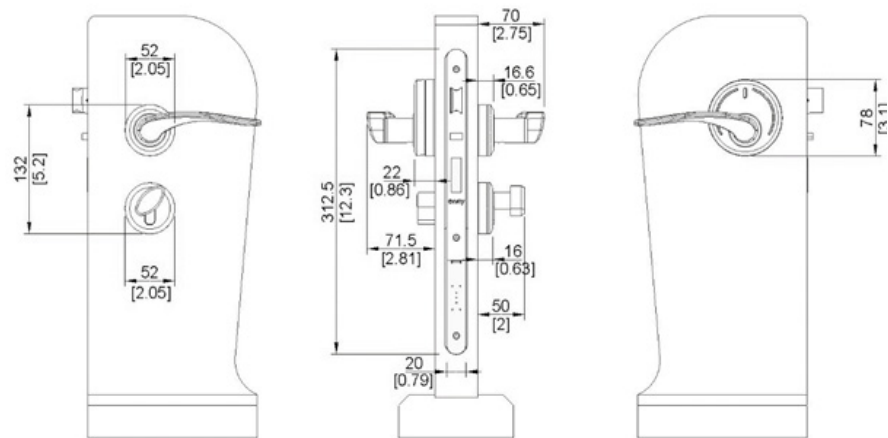

1.3 Light Indicators

General

Color	Meaning
Green	Success
Red	Failure/Error
Cyan	Payload/Lock System
Blue	Bluetooth
Purple	Mesh/Two-way RMS
Yellow	Motor Board

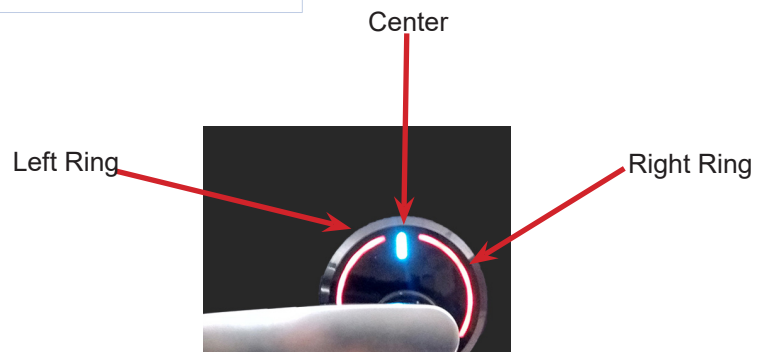

Specific Meanings

Location & Color			Blinks	Beeps	Meaning
Left Ring	Center	Right Ring			
Green	Green	Green	1 sec	High	Valid Card Data to Open
None	Green	None	Solid	None	After Valid Card Data to Open
Red	Red	Red	Solid 3 sec	Low	Invalid Data to Open/Bad Card Lockout
Orange	Orange	Orange	Blinks	None	Programming Card Used
Green	None	Red	Slow 3x	High	Cancel Card Data
Green	Green	Green	Fast 3x	High	Enter Office Mode
None	Green	None	15x	High	Lock is in Office Mode
Red	Red	Red	1x	Low	Exit Office Mode
Green/Red	Red	Red/Green	3x	None	Privacy Switch is On
Green/Red	Cyan	Red/Green	3x	Low	Card is Out of Shift
Red	Red	Red	Fast 3x	Low	Lock Blocked with Blocking Card
Green	Green	Green	3x	High	Lock Unblocked with Blocking Card
Green/Orange	Green	Orange/Green	3x	High	Valid Card and Low Battery
Orange/Red	Red	Red/Orange	3x	High	Valid Card and Critically Low Battery
Blue	Blue	Blue	1x	None	Bluetooth Open
Red	Blue	Red	1x	None	Bluetooth Error

1.4 Technical Support

For technical support, visit www.onity.com or contact your sales representative.

1.5 Referenced Documentation

For additional information, visit www.onity.net to view marketing and technical documentation.

Document Name	Document Number
Serene Lock Datasheet	Rev. 2019
Serene Lock Installation Guide ANSI	10106781P1
Serene Lock Installation Guide EURO	10106781P2

2 Serene Assembly Diagram (ANSI)

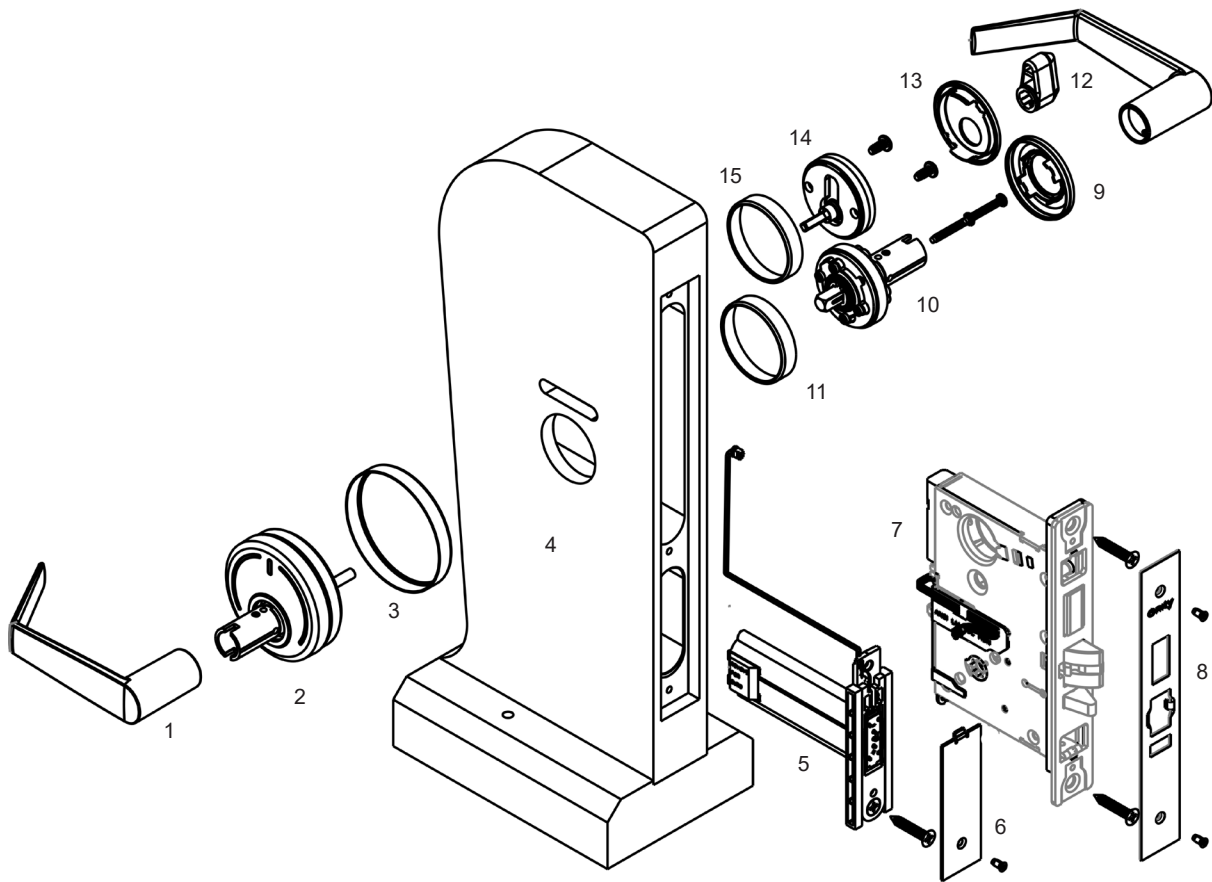

Legend

- 1 - Door lever (available in Toledo, Granada, and Wing)
- 2 - Exterior rosette (with cosmetic plastic cover)
- 3 - Exterior rosette trim ring
- 4 - Door representation
- 5 - Battery case
- 6 - Battery case faceplate
- 7 - Mortise lock case with ribbon cable
- 8 - Mortise faceplate
- 9 - Interior lever rosette cosmetic plastic cover
- 10 - Interior lever rosette
- 11 - Interior lever rosette trim ring
- 12 - Thumbturn
- 13 - Thumbturn rosette cosmetic plastic cover
- 14 - Thumbturn rosette
- 15 - Thumbturn rosette trim ring

3 Serene Assembly Diagram (EURO)

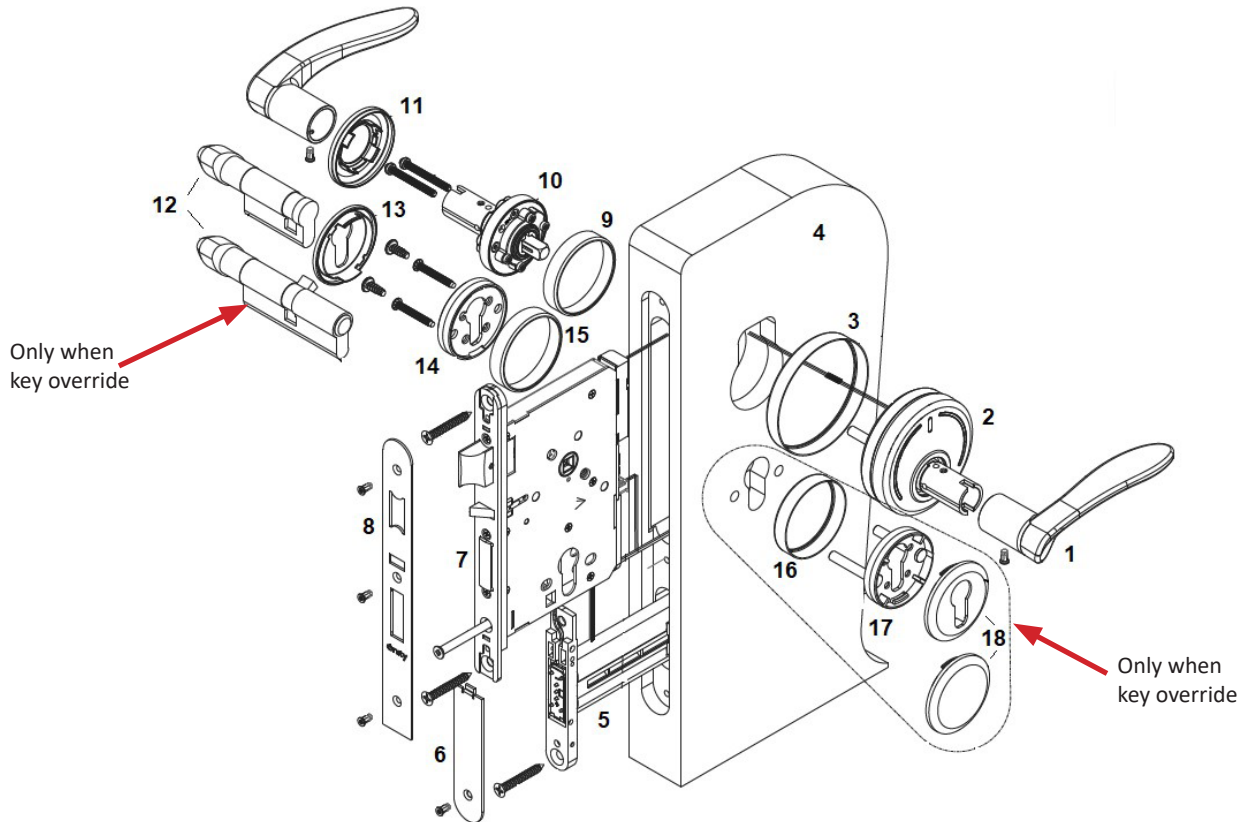

Legend

- 1 - Door lever (available in Toledo, Granada, and Wing, or approved OEM lever)
- 2 - Exterior rosette (with cosmetic plastic cover)
- 3 - Exterior rosette trim ring
- 4 - Door representation
- 5 - Battery case
- 6 - Battery case faceplate
- 7 - Mortise lock case
- 8 - Mortise faceplate
- 9 - Interior lever rosette cosmetic trim ring
- 10 - Interior lever rosette
- 11 - Interior lever rosette plastic cover
- 12 - Cylinder
- 13 - Cylinder rosette cosmetic plastic cover
- 14 - Cylinder rosette
- 15 - Cylinder rosette trim ring
- 16 - External key-override cylinder trim ring (only when key override)
- 17 - External key override cylinder rosette
- 18 - External key-override cylinder cosmetic plastic cover

3 Open the Lock

These steps are for utilizing the Onity DirectKey mobile app only. Hotel loyalty apps may function differently.

RFID Card

Step	Action
1.	Hold RFID card in front of the black rosette surrounding the door lever.
2.	While holding card in this position, touch card to rosette, then remove card.
3.	When the green LED light flashes, open the door.

Note: LED light will flash white to indicate it is “awake” and will flash green to indicate lock is open.



Bluetooth

Step	Action
Note: Download the DirectKey™ mobile app or the hotel-hosted loyalty DirectKey app from iTunes or Google Play store.	
1.	Open the DirectKey app.
2.	When physically close to the room, tap the room number on the app.

Note: LED light will flash green to indicate the card is valid and will flash blue to indicate lock is open.

3.	When the green LED light flashes, open the door.
----	--

4 General Maintenance



Caution: Exterior locks must be cleaned after major weather events such as hurricanes. Do not use harsh chemicals when cleaning locks.



Step	Action
1.	Visually inspect the lock, handle, and privacy lock for damage and replace as required.
2.	Using a clean cloth, wipe down the lock exterior, lever, and privacy lock.
3.	Use a standard cleaning card to clean the lock on a regular basis.

5 Battery Replacement

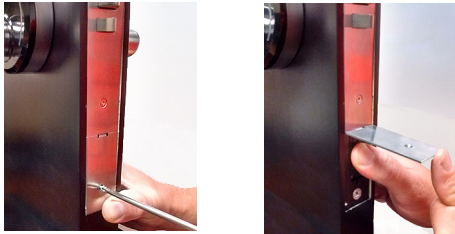

WARNINGS!

- *Use only fresh, approved, high-quality AA alkaline batteries with same type and rating.*
- *Verify that the temperature rating of the batteries matches that of the lock, as specified in Section 1.2.*
- *Never mix used and new batteries in the lock. If battery compartment or batteries exhibit signs of corrosion, replace immediately.*
- *Do not dispose batteries into fire or a hot oven, or mechanically crush or cut batteries, as it can result in an explosion.*
- *Do not leave batteries in an extremely high temperature surrounding environment as it can result in an explosion or leakage of flammable liquid or gas.*
- *Do not subject batteries to extremely low air pressure during storage as it can result in an explosion or leakage of flammable liquid or gas.*
- *Dispose of all batteries as required by local/regulatory requirements.*

Step	Action	
1.	Remove T10 screw from battery faceplate, lift faceplate up as indicated and remove.	
2.	Locate the small black plastic tab between the upper and lower battery. Gently pull on it to pull out battery compartment.	
3.	Remove batteries and dispose per local/regulatory requirements.	
4.	Push battery compartment back in. Insert new batteries to match polarity markings (+ and -) on battery compartment as indicated.	

5. Close battery compartment and re-attach battery faceplate with the T10 screw.



6. Dispose of batteries per local and regulatory requirements.

6 Emergency Battery Pack

The Serene Lock is powered by 4 AA batteries. In the event that the batteries in the door have lost power, it may be necessary to open the door using the Emergency Battery Pack.

The Emergency Battery Pack consists of a molded connector and a 9V battery.



Connector only

Connection pin



Connector with battery

The Emergency Battery Pack connects to the underside of the exterior rosette, as shown below.

IMPORTANT: Battery Pack connector pin is fragile. DO NOT FORCE the connection.

STEP	ACTION
1.	To connect Emergency Battery Pack to rosette, press connector flat to the door under rosette .
2.	Push up GENTLY to insert connector pin. DO NOT FORCE .
3.	Once connected, hold onto Emergency Battery Pack (to prevent it from falling) and use valid RFID card/device that will open the door .











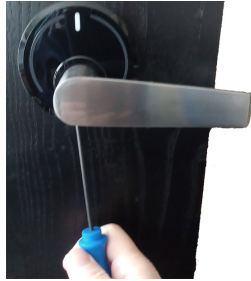

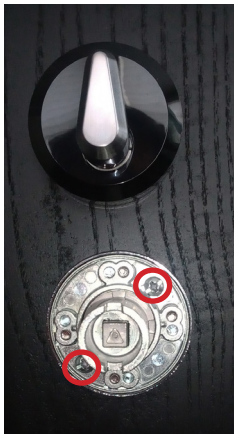
Emergency Battery Pack connected to rosette

7 Clearing the Lock



WARNING: Door **MUST** remain open while clearing the lock. If the door closes before the clear operation is complete, it cannot be opened from the outside.

Step	Action	
1.	Unscrew T10 screw on bottom of lever and remove levers from rosette post (interior and exterior).	
2.	Pull off plastic cover from interior rosette.	
3.	Remove two (2) Philips-head screws from interior rosette and pull off rosette, while supporting exterior rosette.	
<p> CAUTION: Support exterior rosette while removing interior rosette to prevent it from falling off. Do not let the rosette hang from the e-mortise cable.</p>		
4.	Pull off exterior rosette slowly; taking care not to disengage cable.	

Step	Action	
5.	Pull back gasket and insert a paper clip or small screwdriver into the hole above the cable connection on the back of the rosette base; apply light pressure.	
6.	With the clear button pressed, the center LED will illuminate white. Hold the button down until the side LED's blink red and green and you hear a beep.	
7.	Release the clear button.	
8.	After a few moments, the lock controller and the e-mortise controller will connect and flash green LED's on the right and left and yellow in the center.	
9.	Replace the exterior rosette and hold it in place while you reinstall the interior rosette.	
10.	Replace plastic rosette cover on interior rosette.	
11.	Reinstall interior and exterior levers.	

8 Regulatory Information

8.1 Model Numbers

For regulatory identification purposes, the product is assigned a Regulatory Model Number (RMN). The RMN for Serene is listed below. Do not confuse this regulatory number with the marketing name or product part numbers.

Regulatory Model Number (RMN)	Lock Family Name	Description	Commercial Model Number (CMN)
10106653P1	Serene	Serene Lock with BTLE and RFID	10106654P1

8.2 Regulatory Statements

<p>Canada (ISED)</p>	<p>This device complies with Innovation, Science and Economic Development (ISED) Canada's license-exempt RSS(s). Operation is subject to the following two conditions:</p> <ol style="list-style-type: none"> 1. This device may not cause interference. 2. This device must accept any interference, including interference that may cause undesired operation of the device. <p>Le présent appareil est conforme aux CNR d'Innovation, des Sciences et du développement économique (ISDE) applicables aux appareils radio exempts de licence. L'exploitation est autorisée aux deux conditions suivantes:</p> <ol style="list-style-type: none"> 1. l'appareil ne doit pas produire de brouillage, et 2. l'appareil doit accepter tout brouillage radioélectrique subi, même si le brouillage est susceptible d'en compromettre le fonctionnement. <p><u>Radiation Exposure Statement</u> This equipment complies with ISED radiation exposure limits set forth for an uncontrolled environment. This equipment should be installed and operated with greater than 20 cm between the radiator & your body.</p> <p><u>Déclaration d'exposition aux radiations</u> Cet équipement est conforme aux limites d'exposition aux rayonnements ISED établies pour un environnement non contrôlé. Cet équipement doit être installé et utilisé à plus de 20 cm entre le radiateur et votre corps.</p>
<p>United States (FCC)</p>	<p>This equipment has been tested and found to comply with the limits for a Class A digital device, pursuant to Part 15 of the FCC Rules. These limits are designed to provide reasonable protection against harmful interference when the equipment is operated in a commercial environment. This equipment generates, uses, and can radiate radio frequency energy and, if not installed and used in accordance with this user manual, may cause harmful interference to radio communications. Operation of this equipment in a residential area is likely to cause harmful interference, in which case the user will be required to correct the interference at his/her own expense.</p> <p>This device complies with part 15 of the FCC Rules. Operation is subject to the following two conditions:</p> <ol style="list-style-type: none"> 1. This device may not cause interference; and 2. This device must accept any interference, including interference that may cause undesired operation. <p>Changes or modifications not expressly approved by Onity Inc. could void the user's authority to operate the equipment.</p> <p>To comply with FCC RF exposure compliance requirements, the device must be installed to provide a separation distance of at least 20 cm from all persons.</p> <p><u>Radiation Exposure Statement</u> This product complies with the U.S. RF exposure limit set forth for an uncontrolled environment and is safe for intended operation as described in this manual. Further RF exposure reduction can be achieved if the product can be kept as far as possible from the user's body or the device is set to lower output power if such function is available. This transmitter must not be co-located or operating in conjunction with any other antenna or transmitter.</p>
<p>European Union (CE)</p>	<p>This Class B digital apparatus conforms to the requirements of the following EU directives:</p> <ol style="list-style-type: none"> 1. RED, 2.4GHz, Bluetooth Power class 1 (12dBm max) 2. WEEE Directive (2012/19/EC)

Brazil	 <p>ANATEL:04490-19-09598 Para maiores informações consultar: www.gov.br/anatel</p>	<div style="border: 2px solid black; padding: 5px;"> <p>“Este equipamento não tem direito à proteção contra interferência prejudicial e não pode causar interferência em sistemas devidamente autorizados”.</p> </div>
Mexico	<p>La operación de este equipo está sujeta a las siguientes dos condiciones:</p> <ol style="list-style-type: none"> 1. es posible que este equipo o dispositivo no cause interferencia perjudicial y 2. este equipo o dispositivo debe aceptar cualquier interferencia, incluyendo la que pueda causar su operación no deseada. 	

8.3 Environmental Compliance

This product adheres to environmental regulations established by the current European Union (EU) RoHS and WEEE Directives.

9 Certifications

Certifications	
<ul style="list-style-type: none"> • FCC & ISED • Electromagnetic Compatibility Directive (2014/30/EU) • Radio Equipment Directive (2014/53/EU) 	<ul style="list-style-type: none"> • BHMA 156.25 • BHMA 156.13 (Pending) • UL10C (3 hours)