

**Annex acc. to FCC Title 47 CFR Part 15
relating to
ecom GmbH
MODUL-AX5243_S**

Annex no. 5 User Manual Functional Description

**Title 47 - Telecommunication
Part 15 - Radio Frequency Devices
Subpart C – Intentional Radiators
ANSI C63.4-2014
ANSI C63.10-2013**



Deutsche
Akkreditierungsstelle
D-PL-12053-01-00



AX5043 Programming Manual

Advances High Performance ASK and FSK Narrow-Band Transceiver for 27–1050 MHz Range

ON Semiconductor®

www.onsemi.com

OVERVIEW

AX5043 is a true single chip low-power CMOS transceiver for narrow band applications. A fully integrated VCO supports carrier frequencies in the 433 MHz, 868 MHz and 915 MHz ISM band. An external VCO inductor enables carrier frequencies from 27 MHz to 1050 MHz. The on-chip transceiver consists of a fully integrated RF front-end with modulator, and demodulator. Base band data processing is implemented in an advanced and flexible communication controller that enables user friendly communication via the SPI interface.

APPLICATION NOTE

An on-chip low power oscillator as well as Wake-on-radio enable very low power standby applications. The AX5043 is also available with the AX8052F100 microcontroller in a single integrated circuit as the AX8052F143. Figure 1 shows the block diagram of the AX5043.

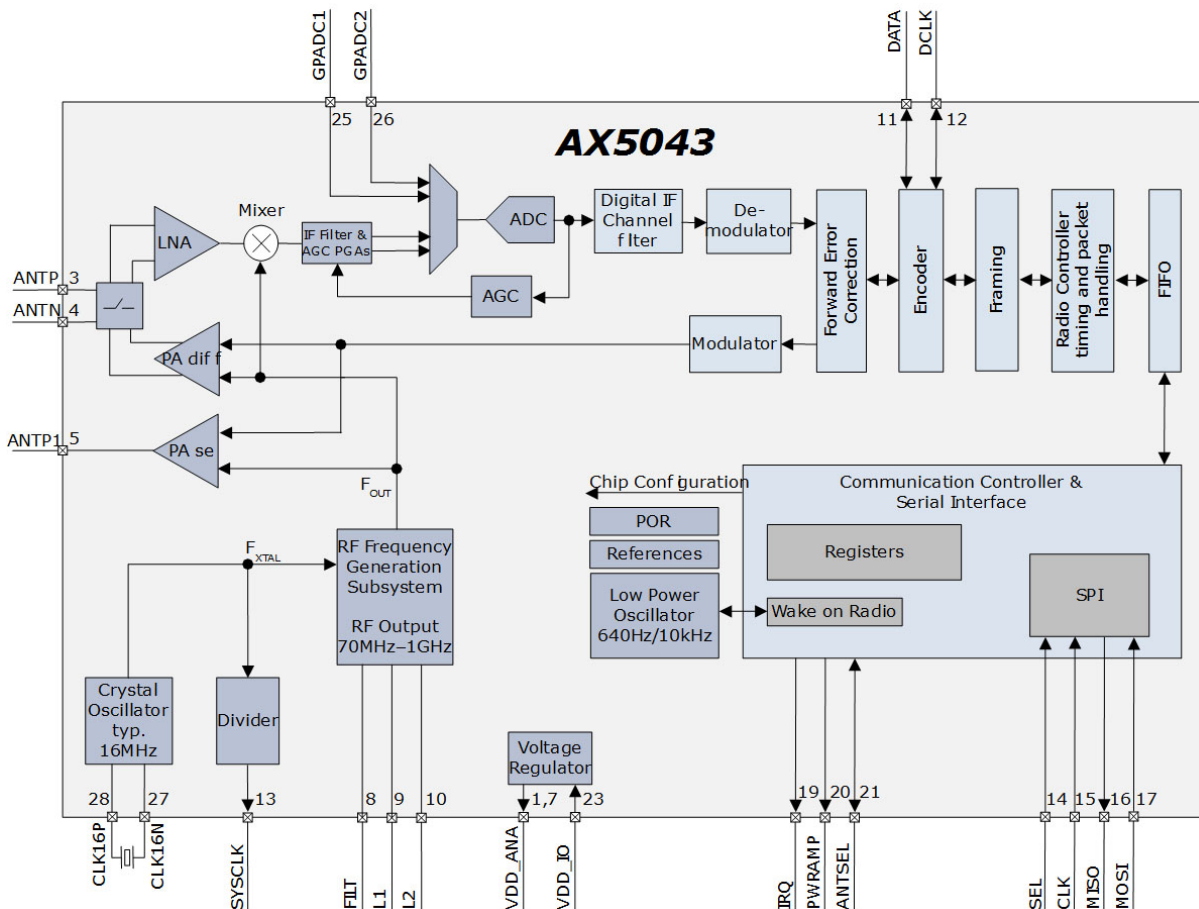

Figure 1. Block Diagram

TABLE OF CONTENTS

Overview 1

FIFO Operation 7

Programming the Chip 12

Register Overview 21

Register Details 34

References 74

AND9347/D

Connecting the AX5043 to an AX8052F100 or other Microcontroller

The AX5043 can easily be connected to an AX8052F100 or any other microcontroller. The microcontroller communicates with the AX5043 via a register file that is implemented in the AX5043 and that can be accessed serially via an industry standard Serial Peripheral Interface (SPI) protocol.

Reset is performed by the integrated power-on-reset (POR) block and can be performed manually via the register file.

The AX5043 sends and receives data via the SPI port in frames. This standard operation mode is called frame mode.

In frame mode, the internal communication controller performs frame delimiting, and data is received and transmitted via a 256 Byte FIFO, accessible via the register file. The FIFO is shared between receive and transmit. Figure 2 shows the corresponding diagram. Connecting the interrupt line is highly recommended, though not strictly required. With the AX8052F100, it is also recommended to connect the SYSCLK line. This allows the Microcontroller to run from the precise crystal clock of the AX5043, or to calibrate its internal oscillators from against this clock.

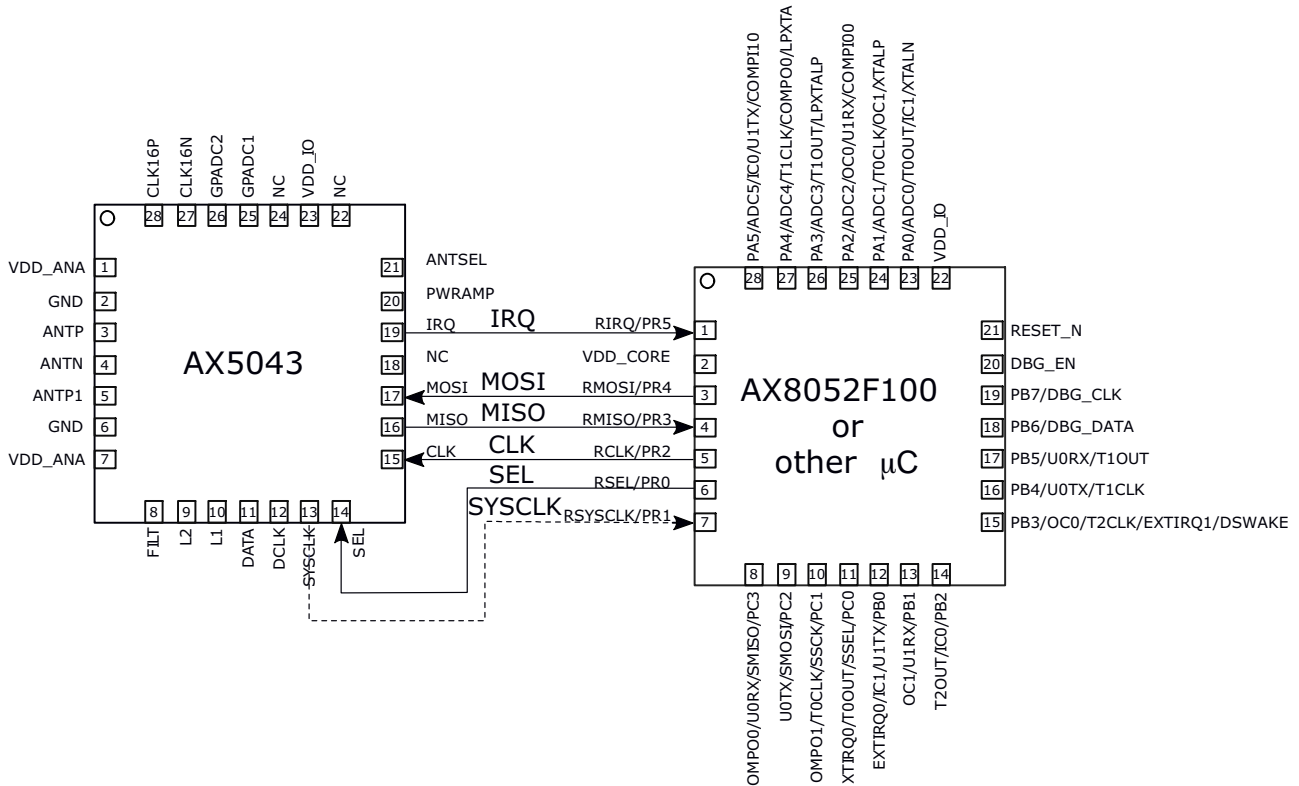

Figure 2. Connecting AX5043 to AX8052F100 or other μ C

AND9347/D

Pin Function Descriptions

Table 1. PIN FUNCTION DESCRIPTION

Symbol	Pin(s)	Type	Description
VDD_ANA	1	P	Analog power output, decouple to neighboring GND
GND	2	P	Ground, decouple to neighboring VDD_ANA
ANTP	3	A	Differential antenna input/output
ANTN	4	A	Differential antenna input/output
ANTP1	5	A	Single-ended antenna output
GND	6	P	Ground, decouple to neighboring VDD_ANA
VDD_ANA	7	P	Analog power output, decouple to neighboring GND
FILT	8	A	Optional synthesizer filter
L2	9	A	Optional synthesizer inductor
L1	10	A	Optional synthesizer inductor
DATA	11	I/O	In wire mode: Data in-out/output Can be programmed to be used as a general purpose I/O pin Selectable internal 65 kΩ pull-up resistor
DCLK	12	I/O	In wire mode: Clock output Can be programmed to be used as a general purpose I/O pin Selectable internal 65 kΩ pull-up resistor
SYSCLK	13	I/O	Default functionality: Crystal oscillator (or divided) clock output Can be programmed to be used as a general purpose I/O pin Selectable internal 65 kΩ pull-up resistor
SEL	14	I	Serial peripheral interface select
CLK	15	I	Serial peripheral interface clock
MISO	16	O	Serial peripheral interface data output
MOSI	17	I	Serial peripheral interface data input
NC	18	N	Must be left unconnected
IRQ	19	O	Default functionality: Transmit and receive interrupt Can be programmed to be used as a general purpose I/O pin Selectable internal 65 kΩ pull-up resistor
PWRAMP	20	I/O	Default functionality: Power amplifier control output Can be programmed to be used as a general purpose I/O pin Selectable internal 65 kΩ pull-up resistor
ANTSEL	21	I/O	Default functionality: Diversity antenna selection output Can be programmed to be used as a general purpose I/O pin Selectable internal 65 kΩ pull-up resistor
NC	22	N	Must be left unconnected
VDD_IO	23	P	Power supply 1.8 V – 3.6 V
NC	24	N	Must be left unconnected
GPADC1	25	A	GPADC input
GPADC2	26	A	GPADC input
CLK16N	27	A	Crystal oscillator input/output
CLK16P	28	A	Crystal oscillator input/output
GND	Center Pad	P	Ground on center pad of QFN, must be connected

A = analog signal
 I = digital input signal
 O = digital output signal
 I/O = digital input/output signal
 N = not to be connected
 P = power or ground

All digital inputs are Schmitt trigger inputs, digital input and output levels are LVCMOS/LVTTL compatible and 5 V tolerant.

AND9347/D

SPI Register Access

Registers are accessed via a synchronous Serial Peripheral Interface (SPI). Most Registers are 8 bits wide and accessed using the waveforms as detailed in Figure 3. These

waveforms are compatible to most hardware SPI master controllers, and can easily be generated in software. MISO changes on the falling edge of CLK, while MOSI is latched on the rising edge of CLK.

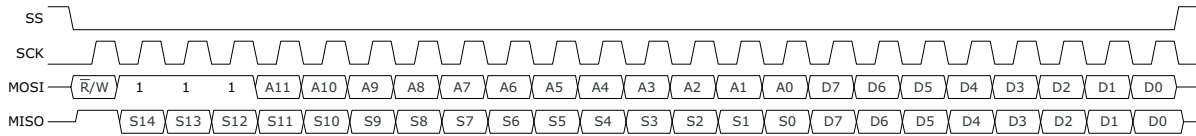

Figure 3. SPI 8bit Long Address Read/Write Access

The most important registers are at the beginning of the address space, i.e. at addresses less than 0x70. These

registers can be accessed more efficiently using the short address form, which is detailed in Figure 4.

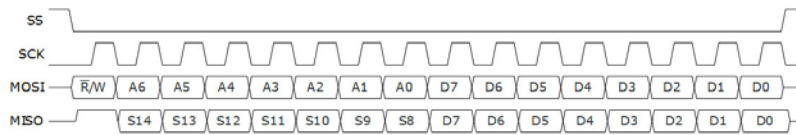

Figure 4. SPI 8bit Read/Write Access

Some registers are longer than 8 bits. These registers can be accessed more quickly than by reading and writing individual 8 bit parts. This is illustrated in Figure 5. Accesses are not limited by 16 bits either, reading and writing data

bytes can be continued as long as desired. After each byte, the address counter is incremented by one. Also, this access form also works with long addresses.

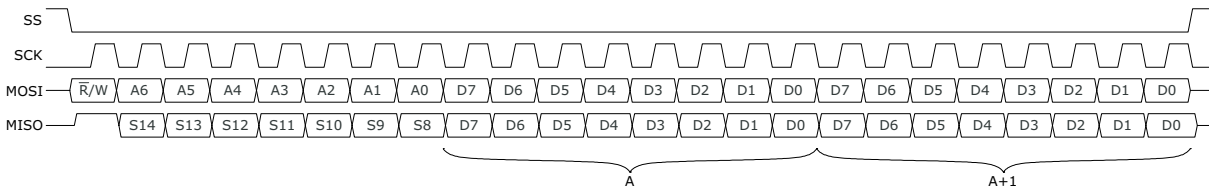

Figure 5. SPI 16bit Read/Write Access

During the address phase of the access, the chip outputs the most important status bits. This feature is designed to speed up software decision on what to do in an interrupt

handler. The table below shows which register bit is transmitted during the status timeslots.

Table 2. SPI STATUS BITS

SPI Bit Cell	Status	Register Bit
0	-	1 (when transitioning out of deep sleep, this bit transitions from 0→1 when the power becomes ready)
1	S14	PLL LOCK
2	S13	FIFO OVER
3	S12	FIFO UNDER
4	S11	THRESHOLD FREE (FIFO Free > FIFO threshold)
5	S10	THRESHOLD COUNT (FIFO count > FIFO threshold)
6	S9	FIFO FULL
7	S8	FIFO EMPTY
8	S7	PWRGOOD (not BROWNOUT)
9	S6	PWR INTERRUPT PENDING
10	S5	RADIO EVENT PENDING
11	S4	XTAL OSCILLATOR RUNNING

Table 2. SPI STATUS BITS (continued)

SPI Bit Cell	Status	Register Bit
12	S3	WAKEUP INTERRUPT PENDING
13	S2	LPOSC INTERRUPT PENDING
14	S1	GPADC INTERRUPT PENDING
15	S0	undefined

Note that bit cells 8–15 (S7...S0) are only available in two address byte SPI access formats.

Deep Sleep

The chip can be programmed into deep sleep mode. In deep sleep mode, the chip is completely switched off, which results in very low leakage power. All registers lose their programming.

To enter deep sleep mode, write the deep sleep encoding into bits 3:0 of PWRMODE. At the rising edge of the SEL line, the chip will enter deep sleep mode.

To exit deep sleep mode, lower the SEL line. This will initiate startup and reset of the chip. Then poll the MISO line. The MISO line will be held low during initialization, and will rise to high at the end of the initialization, when the chip becomes ready for further operation.

Address Space

The address space has been allocated as follows. Addresses from 0x000 to 0x06F are reserved for “dynamic registers”, i.e. registers that are expected to be frequently accessed during normal operation, as they can be efficiently accessed using single address byte SPI accesses. Addresses from 0x070 to 0x0FF have been left unused (they could only be accessed using the two address byte SPI format). Addresses from 0x100 to 0x1FF have been reserved for physical layer parameter registers, for example receiver, transmitter, PLL, crystal oscillator. Addresses from 0x200 to 0x2FF have been reserved for medium access parameters, such as framing, packet handling. Addresses from 0x300 to 0x3FF have been reserved for special functions, such as GPADC.

FIFO OPERATION

The AX5043 features a 256 Byte FIFO. The same FIFO is used for both reception and transmission. During transmit, only the write port is accessible by the microcontroller. During receive, only the read port is accessible by the microcontroller. Otherwise, both ports are accessible through the register file.

In order to prevent transmitting premature data, the FIFO contains three pointers. Data is read at the read pointer, up to the write pointer. Data is written to the write ahead pointer. The write pointer is not updated when data is written, therefore, new data is not immediately visible to the consumer. Writing the COMMIT command to the FIFOSTAT register copies the write ahead pointer to the write pointer, thus making the written data visible to the

receiver. Writing the ROLLBACK command to the FIFOSTAT register sets the write ahead pointer to the write pointer, thus discarding data written to the FIFO. During transmit, this means that the transmitter will only consider data written to the FIFO after the commit command. During receive, this feature is used by the receiver to store packet data before it is known whether the CRC check passes. FIFOCOUNT reports the number of bytes that can be read without causing an underflow. FIFOFREE reports the number of bytes that can be written without causing an overflow. FIFOCOUNT and FIFOFREE do not add up to 256 Bytes whenever there are uncommitted bytes in the FIFO. Figure 6 illustrates this.

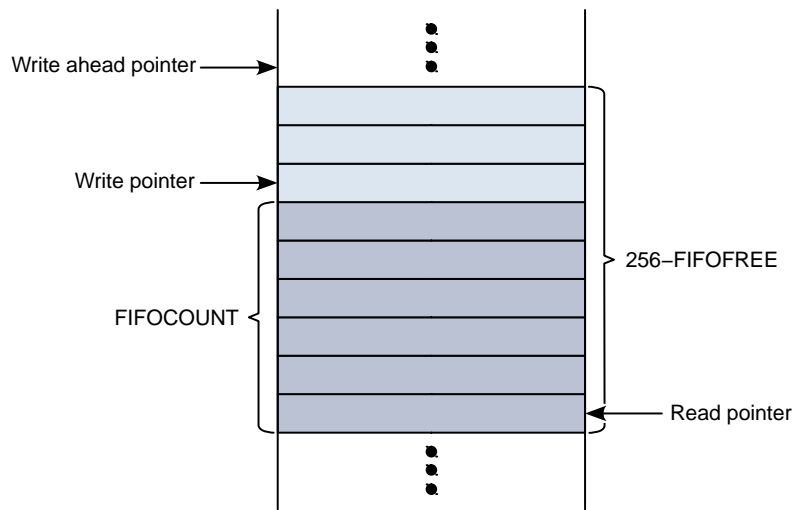

Figure 6. FIFO Pointer

FIFO Chunk Encoding

In order to distinguish meta-data (such as RSSI) from receive or transmit data, FIFO contents are organized as chunks. Chunks consist of a header that encodes the chunk length as well as the payload data format.

Each chunk starts with a single byte header. The header encodes the length of a chunk, and indicates the data it contains. The top 3 bits encode the length (or optionally refer to an additional length byte after the header byte), and the bottom 5 bits indicate what payload data the chunk contains. The following table lists the encoding of the length bits (top 3 bits of the first chunk header byte). Figure 7 shows the chunk header byte encoding.

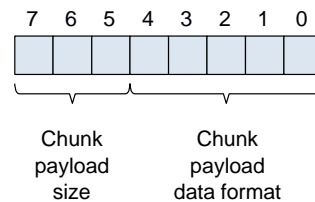

Figure 7. FIFO Header byte Format

The following table lists the chunk payload size encoding:

Table 3. CHUNK PAYLOAD SIZE ENCODING

Top Bits	Chunk Payload Size
000	No payload
001	Single byte payload
010	Two byte payload
011	Three byte payload

Table 3. CHUNK PAYLOAD SIZE ENCODING (continued)

Top Bits	Chunk Payload Size
100	Invalid
101	Invalid
110	Invalid
111	Variable length payload; payload size is encoded in the following length byte the length byte is part of the header (and not included in length), everything after the length byte is included in the length

The following table lists the chunk types and their encodings. The Hdr Byte column lists the complete FIFO Chunk Header Byte, consisting of the length and data format encodings.

Table 4. CHUNK TYPES AND THEIR ENCODINGS

Name	Dir	Hdr. Byte	Description
		7-0	

No Payload Commands

NOP	T	00000000	No Operation
-----	---	----------	--------------

One Byte Payload Commands

RSSI	R	00110001	RSSI
TXCTRL	T	00111100	Transmit Control (Antenna, Power Amp)

Two Byte Payload Commands

FREQOFFS	R	01010010	Frequency Offset
ANTRSSI2	R	01010101	Background Noise Calculation RSSI

Three Byte Payload Commands

REPEATDATA	T	01100010	Repeat Data
TIMER	R	01110000	Timer
RFFREQOFFS	R	01110011	RF Frequency Offset
DATARATE	R	01110100	Datarate
ANTRSSI3	R	01110101	Antenna Selection RSSI

Variable Length Payload Commands

DATA	TR	11100001	Data
TXPWR	T	11111101	Transmit Power

Direction: T = Transmit, R = Receive

NOP Command

Table 5. NOP COMMAND

7	6	5	4	3	2	1	0
0	0	0	0	0	0	0	0

The NOP command will be discarded without effect by the transmitter. The receiver will not generate NOP commands.

RSSI Command

Table 6. RSSI COMMAND

7	6	5	4	3	2	1	0
0	0	0	0	0	0	0	0
RSSI							

The RSSI command will only be generated by the receiver at the end of a packet if bit STRSSI is set in register PKTSTOREFLAGS. The encoding is the same as that of the RSSI register.

TXCTRL Command

Table 7. TXCTRL COMMAND

7	6	5	4	3	2	1	0
0	0	1	1	1	1	0	0
0	SETT X	TXSE	TXDI FF	SETA NT	ANTS TATE	SETP A	PAST ATE

The TXCTRL command allows certain aspects of the transmitter to be changed on the fly. If SETTX is set, TXSE and TXDIFF are copied into the register MODCFG4. If SETANT is set, ANTSTATE is copied into register DIVERSITY. If SETPA is set, PASTATE is copied into register PWRAMP.

FREQOFFS Command

Table 8. FREQOFFS COMMAND

7	6	5	4	3	2	1	0
0	1	0	1	0	0	1	0
FREQOFFS1							
FREQOFFS0							

The FREQOFFS command will only be generated by the receiver at the end of a packet if bit STFOFFS is set in register PKTSTOREFLAGS. The encoding is the same as that of the TRKFREQ register.

ANTRSSI2 Command

Table 9. ANTRSSI2 COMMAND

7	6	5	4	3	2	1	0
0	1	0	1	0	1	0	1
RSSI							
BGNDNOISE							

The ANTRSSI2 command will be generated by the receiver when it is idle if bit STANTRSSI is set in register PKTSTOREFLAGS. If DIVENA is set in register DIVERSITY, the ANTRSSI3 command is generated instead. The encoding of the RSSI field is the same as that of the RSSI register. The BGNDNOISE field contains an estimate of the background noise.

REPEATDATA Command

Table 10. REPEATDATA COMMAND

7	6	5	4	3	2	1	0
0	1	1	0	0	0	1	0
0	0	UNENC	RAW	NOCRC	RESIDUE	PKTEND	PKTSTART
REPEATCNT							
DATA							

The REPEATDATA command allows the efficient transmission of repetitive data bytes. The DATA byte given in the payload is repeated REPEATCNT times. See DATA command for a description of the flag byte. This command is especially handy for constructing preambles.

TIMER Command

Table 11. TIMER COMMAND

7	6	5	4	3	2	1	0
0	1	1	1	0	0	0	0
TIMER2							
TIMER1							
TIMER0							

The TIMER command will only be generated by the receiver at the start of a packet if bit STTIMER is set in register PKTSTOREFLAGS. The payload is a copy of the μ s timer TIMER register. This command enables exact packet timing for example for frequency hopping systems.

RFFREQOFFS Command

Table 12. RFFREQOFFS COMMAND

7	6	5	4	3	2	1	0
0	1	1	1	0	0	1	1
RFFREQOFFS2							
RFFREQOFFS1							
RFFREQOFFS0							

The RFFREQOFFS command will only be generated by the receiver at the end of a packet if bit STRFOFFS is set in register PKTSTOREFLAGS. The encoding is the same as that of the TRKRFFREQ register.

DATARATE Command

Table 13. DATARATE COMMAND

7	6	5	4	3	2	1	0
0	1	1	1	0	1	0	0
DATARATE2							
DATARATE1							
DATARATE0							

The DATARATE command will only be generated by the receiver at the end of a packet if bit STDTR is set in register PKTSTOREFLAGS. The encoding is the same as that of the TRKDATARATE register.

ANTRSSI3 Command

Table 14. ANTRSSI3 COMMAND

7	6	5	4	3	2	1	0
0	1	1	1	0	1	0	1
ANTORSSI2							
ANTORSSI1							
ANTORSSI0							

The ANTRSSI3 command will be generated by the receiver when it is idle if bit STANTRSSI is set in register PKTSTOREFLAGS. If DIVENA is not set in register DIVERSITY, the ANTRSSI2 command is generated instead. The encoding of the ANTORSSI and ANT1RSSI fields are the same as that of the RSSI register. The BGNDNOISE field contains an estimate of the background noise.

DATA Command

The DATA command transports actual transmit and receive data. While the basic format is the same for transmit and receive, the semantics of the flag byte differs.

Table 15. TRANSMIT DATA FORMAT

7	6	5	4	3	2	1	0
1	1	1	0	0	0	0	1
LENGTH							
0	0	UNENC	RAW	NOCRC	RESIDUE	PKTEND	PKTSTART
DATA							

LENGTH includes the flags byte as well as all DATA bytes.

Setting RAW to one causes the DATA to bypass the framing mode, but still pass through the encoder.

Setting UNENC to one causes the DATA to bypass the framing mode, as well as the encoder, except for inversion. UNENC has priority over RAW.

Setting NOCRC suppresses the generation of the CRC bytes.

Setting RESIDUE allows the transmission of a number of data bits that is not a multiple of eight. All but the last data byte are transmitted as if RESIDUE was not set. The last byte however contains only 7 bits or less. The transmitter looks for the highest bit set. This is considered the stop bit. Only bits below the stop bit are transmitted. If the MSBFIRST in register PKTADDRCFG is set, the algorithm

is reversed, i.e. the lowest bit set is considered the stop bit and bits above the stop bit are transmitted.

PKTSTART and PKTEND bits enable the transmission of packets that are larger than the FIFO size. If PKTSTART is set, the radio packet starts at the beginning of the DATA command payload. If PKTEND is set, the radio packet ends at the end of the DATA command payload. If PKTSTART is not set, this command is the continuation of a previous DATA command. If PKTEND is not set, the packet is continued with the next DATA command.

PKTSTART in RAW mode causes the DATA bytes to be aligned to DiBit boundaries in 4-FSK mode.

For example, to transmit 20 bits of an alternating 0–1 pattern as a preamble, the following bytes should be written to the FIFO (MSBFIRST = 0 in register PKTADDRCFG is assumed):

Table 16. FIFO COMMAND

0xE1	FIFO Command
0x04	Length Byte
0x24	Flag Byte: Unencoded, to ensure 0–1 remains 0–1, and Residue set, because the number of bits transmitted is not a multiple of 8
0xAA	Alternating 0–1 bits
0xAA	Alternating 0–1 bits
0x1A	Alternating 0–1 bits; Bit 4 is the “Stop” bit

Table 17. RECEIVE DATA FORMAT

7	6	5	4	3	2	1	0
1	1	1	0	0	0	0	1
LENGTH							
0	ABORT	SIZEFAIL	ADDRFAIL	CRCFAIL	RESIDUE	PKTEND	PKTSTART
DATA							

ABORT is set if the packet has been aborted. An ABORT sequence is a sequence of seven or more consecutive one bits when HDLC [1] framing is used. Note that if ACCTABRT is not set in register PKTACCEPTFLAGS, then aborted packets are silently dropped.

SIZEFAIL is set if the packet does not pass the size checks. Size checks are implemented using the PKTLENCFG, PKTLENOFFSET and PKTMAXLEN registers. Note that if ACCTSZF is not set in register PKTACCEPTFLAGS, then packets with an invalid size are silently dropped.

ADDRFAIL is set if the packet does not pass the address checks. Address checks are implemented using the

PKTADDRCFG, PKTADDR and PKTADDRMASK registers. Note that if ACCTADDRF is not set in register PKTACCEPTFLAGS, then packets which do not match the programmed address are silently dropped.

CRCFAIL is set if the packet does not pass the CRC check. Note that if ACCTCRCF is not set in register PKTACCEPTFLAGS, then packets which fail the CRC check are silently dropped.

RESIDUE, PKTEND and PKTSTART work identical as in transmit mode, see above.

The receiver generates chunks up to PKTCHUNKSIZE bytes. If PKTMAXLEN is larger than PKTCHUNKSIZE, multiple chunks may be generated for one packet. Since

AND9347/D

CRC and size checks may only be performed at the end of the packet, only the last chunk can be dropped at failure of one of those tests. It is therefore important that the microcontroller receiver routine clears its receive buffer at the beginning of DATA commands whose PKTSTART bit is set, as the buffer may still contain bytes from erroneous packets.

TXPWR Command

Table 18. TXPWR COMMAND

7	6	5	4	3	2	1	0
1	1	1	1	0	0	1	0
LENGTH = 10							
TXPWRCOEFFA (7:0)							
TXPWRCOEFFA (15:8)							
TXPWRCOEFFB (7:0)							
TXPWRCOEFFB (15:8)							
TXPWRCOEFFC (7:0)							
TXPWRCOEFFC (15:8)							
TXPWRCOEFFD (7:0)							
TXPWRCOEFFD (15:8)							
TXPWRCOEFFE (7:0)							
TXPWRCOEFFE (15:8)							

The TXPWR command allows the transmit power to be changed on the fly. This command updates the TXPWRCOEFFA, TXPWRCOEFFB, TXPWRCOEFFC, TXPWRCOEFFD and TXPWRCOEFFE registers.

PROGRAMMING THE CHIP

Power Modes

To enable the lowest possible application power consumption, the AX5043 allows to shut down its circuits

when not needed. This is controlled by the PWRMODE register. Idd values are typical; for exact values, please refer to the AX5043 datasheet [2].

Table 19. PWRMODE REGISTER STATES

PWRMODE register	Name	Description	Typical Idd
0000	POWERDOWN	Powerdown; all circuits powered down except for the register file	400 nA
0001	DEEPSLEEP	Deep Sleep Mode; Chip is fully powered down until SEL is lowered again; loses all register contents	50 nA
0101	STANDBY	Crystal Oscillator enabled	230 μ A
0111	FIFOON	FIFO and Crystal Oscillator enabled	310 μ A
1000	SYNTHRX	Synthesizer running, Receive Mode	5 mA
1001	FULLRX	Receiver Running	7–11 mA
1011	WORRX	Receiver Wake-on-Radio Mode	500 nA
1100	SYNTHTX	Synthesizer running, Transmit Mode	5 mA
1101	FULLTX	Transmitter Running	6–70 mA

The following list explains the typical programming flow. Preparation:

1. Reset the Chip. Set SEL to high for at least 1 μ s, then low. Wait until MISO goes high. Set, and then clear, the RST bit of register PWRMODE.
2. Set the PWRMODE register to POWERDOWN.
3. Program parameters. It is recommended that suitable parameters are calculated using the AX_RadioLab tool available from Axsem.
4. Perform auto-ranging, to ensure the correct VCO range setting.

The chip is now ready for transmit and receive operations.

FIFO Power Management

The FIFO is powered down during POWERDOWN and DEEPSLEEP modes (Register PWRMODE). The FIFO EMPTY and FIFO FULL bits (Register FIFOSTAT), as well as the FIFOCOUNT and FIFOFREE registers read zero. Reads from the FIFO will return undefined data, and writes to the FIFO will be lost.

In the receive case, the FIFO is automatically powered on when the chip PWRMODE is set to FULLRX. The FIFO should be emptied before the PWRMODE is set to POWERDOWN. In Wake-on-radio or POWERDOWN

mode, the FIFO is automatically kept powered until it is emptied by the microprocessor.

In the transmit case, PWRMODE should first be set to FULLTX. Before writing to the FIFO, the microprocessor must ensure that the SVMODEM bit is high in Register POWSTAT, to ensure that the on-chip voltage regulator supplying the FIFO has finished starting up. The transmitter remains idle until the contents of the FIFO are committed (unless the FIFO AUTO COMMIT bit is set in Register FIFOSTAT).

Autoranging

Whenever the frequency changes, the synthesizer VCO should be set to the correct range using the built-in auto-ranging. A re-ranging of the VCO is required if the frequency change required is larger than 5 MHz in the 868/915 MHz band or 2.5 MHz in the 433 MHz band. Each individual chip must be auto-ranged. If both frequency register sets FREQA and FREQB are used, then both frequencies must be auto-ranged by first starting auto-ranging in PLLRANGINGA, waiting for its completion, followed by starting auto-ranging in PLLRANGINGB and waiting for its completion.

Figure 8 shows the flow chart of the auto-ranging process.

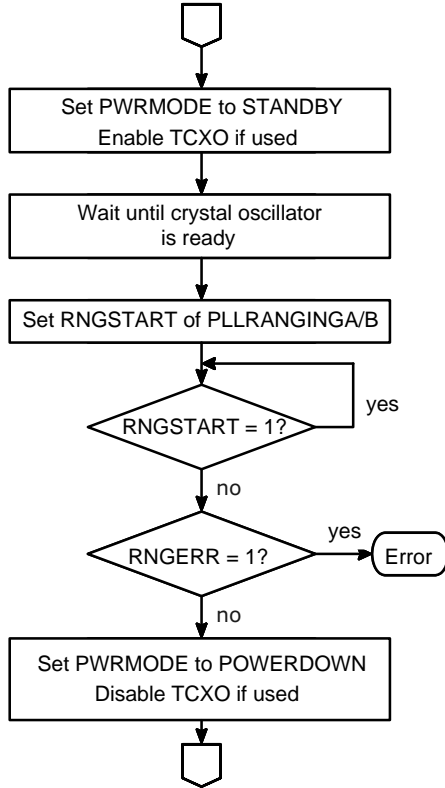

Figure 8. Autoranging Flow Chart

Before starting the auto-ranging, the appropriate frequency registers (FREQA3, FREQA2, FREQA1 and FREQA0 or FREQB3, FREQB2, FREQB1 and FREQB0) need to be programmed. Auto-ranging starts at the VCOR (register PLLRANGINGA or PLLRANGINGB) setting; if you already know the approximately correct synthesizer VCO range, you should set VCORA/VCORB to this value prior to starting auto-ranging; this can speed up the ranging process considerably. If you have no prior knowledge about the correct range, set VCORA/VCORB to 8. Starting with VCORA/VCORB < 6 should be avoided, as the initial synthesizer frequency can exceed the maximum frequency specification.

Hardware clears the RNG START bit automatically as soon as the ranging is finished; the device may be programmed to deliver an interrupt on resetting of the RNG START bit.

Waiting until auto-ranging terminates can be performed by either polling the register PLLRANGINGA or PLLRANGINGB for RNG START to go low, or by enabling the IRQMPLLNRNGDONE interrupt in register IRQMASK1.

Choosing the Fundamental Communication Characteristics

The following table lists the fundamental communication characteristics that need to be chosen before the device can be programmed.

Table 20. FUNDAMENTAL COMMUNICATION CHARACTERISTIC

Parameter	Description
f _{XTAL}	Frequency of the connected crystal in Hz
modulation	FSK, MSK, OQPSK, 4-FSK or AFSK (for recommendations see below)
f _{CARRIER}	Carrier frequency (i.e. center frequency of the signal) in Hz
BITRATE	Desired bit rate in bit/s
h	Modulation index, determines the frequency deviation for FSK 32 > h ≥ 0.5 for FSK, 4-FSK or AFSK, f _{deviation} = 0.5 * h * BITRATE h = 0.5 for MSK and OQPSK (For AFSK, f _{deviation} is usually set according to the FM channel specification. For 25 kHz channels, it is often approximately 3 kHz)
encoding	Inversion, differential, manchester, scrambled, for recommendations see the description of the register ENCODING.

The following table gives an overview of the trade-offs between the different modulations that AX5043 offers, they should be considered when making a choice.

Table 21. TRADE-OFFS BETWEEN THE DIFFERENT MODULATION

Modulation	Trade-offs
f _{XTAL}	Frequency of the connected crystal in Hz
FSK	For bit rates up to 125 kbit/s Frequency deviation is a free parameter

Table 21. TRADE-OFFS BETWEEN THE DIFFERENT MODULATION (continued)

Modulation	Trade-offs
MSK	For bit rates up to 125 kbit/s Robust and spectrally efficient form of FSK (Modulation is the same as FSK with $h = 0.5$) Frequency deviation given by bit rate The advantage of MSK over FSK is that it can be demodulated with higher sensitivity. Slightly longer preambles required than for FSK
OQPSK	For bit rates up to 125 kbit/s Very similar to MSK, with added precoding / postdecoding For new designs, use MSK instead
PSK	For bit rates up to 125 kBit/s Spectrally efficient and high sensitivity Very accurate frequency reference (maximum carrier frequency deviation $\pm 1/4 \cdot BITRATE$) and long preambles required
4-FSK	For bit rates up to 100 kSymbols/s, or 200 kbit/s Similar to FSK, but four frequencies are used to transmit 2 bits simultaneously Very slightly more spectrally efficient compared to FSK $((1 + 3 h/2) \cdot BITRATE$ versus $(1 + h) \cdot BITRATE$) for small h . Longer preambles required as frequency offset estimation needs to be more precise to successfully demodulate For new designs, use FSK instead
AFSK	For bit rates up to 25 kbit/s Bits are FSK modulated in the audio band, then frequency modulated on the carrier frequency. For legacy compatibility applications only.

Given these fundamental physical layer parameters, AX_RadioLab should be used to compute the register settings of the AX5043.

Framing

Figure 1 shows the block diagram of the AX5043. After the user writes a transmit packet into the FIFO, the Radio Controller sequences the transmitter start-up, and signals the Packet Controller to read the packet from the FIFO and add framing bits, allowing the receiver to lock to the transmit waveform, and to detect packet and byte boundaries. If MSB first is selected (register PKTADDRCFG), then the bits within each byte are swapped when the data is read out from the FIFO.

The Packet Controller also (optionally) adds cyclic redundancy check bits at the end of the packet, to enable the receiver to detect transmission errors. Both 16 and 32 Bit CRC can be selected, as well as different generator polynomials. The CRC polynomial can be selected in register FRAMING. The following polynomials are supported:

- CRC-CCITT (16bit):
 $x^{16} + x^{12} + x^5 + 1$ (hexadecimal: 0x1021)
- CRC-16 (16bit):
 $x^{16} + x^{15} + x^2 + 1$ (hexadecimal: 0x8005)
- CRC-DNP (16bit):
 $x^{16} + x^{13} + x^{12} + x^{11} + x^{10} + x^8 + x^6 + x^5 + x^2 + 1$
(hexadecimal: 0x3D65)
This polynomial is used for Wireless M-Bus.

- CRC-32 (32bit):
 $x^{32} + x^{26} + x^{23} + x^{22} + x^{16} + x^{12} + x^{11} + x^{10} + x^8 + x^7 + x^5 + x^4 + x^2 + x + 1$ (hexadecimal: 0x04C11DB7)

The CRC is always transmitted MSB first regardless of the MSB first setting of register PKTADDRCFG, to enable the receiver to process CRC bits as they arrive (otherwise, they would have to be stored and reordered). For an in-depth guide on how CRC's are computed, see [3].

Finally, the encoder is able to perform certain bit-wise operations on the bit-stream:

- Manchester:
Manchester transmits a one bit as 10 and a zero bit as 01, i.e. it doubles the data rate on the radio channel. Its advantage is that the resulting bit-stream has many transitions and thus simplifies synchronizing to the transmission on the receiver side. The downside is that it now requires twice the amount of energy for the transmission. Manchester is not recommended, except for compatibility with legacy systems.
- Scrambler:
The scrambler ensures that even highly regular transmit data results in a seemingly random transmitted bit-stream. This avoids discrete tones in the spectrum. Do not confuse the scrambler with encryption – it does not provide any secrecy, its actions are easily reversed. Its use is recommended.
- Differential:
Differential transmits zero bits as constant level, and one bits as level change. This allows to accomodate

modulations that can invert the bit-stream, such as PSK. It is available for compatibility with other Axsem transceivers, but usually not used on the AX5043.

- Inversion:

If on, the bit-stream is inverted. Useful for example for compatibility with legacy systems, such as POCSAG, which differ from the usual convention that the higher FSK frequency signifies a one.

The encoder is controlled using the register ENCODING. It may be temporarily bypassed *except for the inversion* by setting the UNENC bit of the FIFO chunks DATA or REPEATDATA. This is useful for synthesizing preambles.

The receiver performs these tasks in reverse order.

Transmitter

Figure 9 shows the transmitter flow chart. The microprocessor first places the chip into FULLTX mode. This prepares the chip for a future transmission, enables the FIFO in transmit direction, but does not yet power-up the synthesizer or any other transmit circuitry.

The microprocessor can now write the preamble and the actual packet to the FIFO. The preamble is programmable to allow standards to be implemented that specify a specific preamble to be used. Otherwise, the recommendations for preambles can be found below.

Waiting for the crystal oscillator to start up may be performed by polling the register XTALSTATUS, or by enabling the IRQMXTALREADY interrupt in register IRQMASK1.

After the FIFO contents are committed (writing the Commit command to the FIFOSTAT register), the transmitter notices that the FIFO is no longer empty. It then powers up the synthesizer and settles it (registers TMGTXBOST and TMGTXSETTLE determine the timing). The Preamble and the Packet(s) are then transmitted, followed by the transmitter and synthesizer shut-down.

The transmitter is automatically ramped up and down smoothly, to prevent unwanted spurious emissions. The ramp time is normally one bit time, but may be longer by changing the SLOWRAMP field of register MODCFG4.

The PWRMODE register should stay at FULLTX until the transmission is fully completed. The end of the transmission may be determined by polling the register RADIOSTATE until it indicates idle, or by enabling the radio controller interrupt (bit IRQMRADIOCTRL) in register IRQMASK0 and setting the radio controller to signal an interrupt at the end of transmission (bit REVMDONE of register RADIOEVENTMASK0).

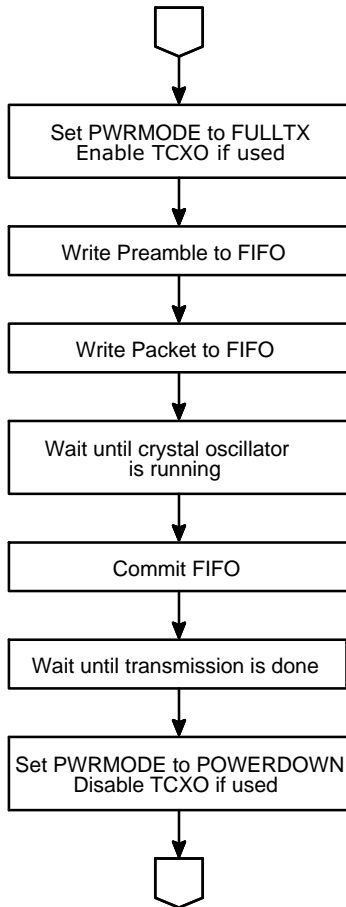

Figure 9. Transmitter Flow Chart

Recommended Preamble

The main purpose of the preamble is to allow for the receiver to acquire vital transmission parameters before the actual packet data starts. The minimum duration of the preamble is dependent on how much time the receiver needs to acquire these parameters to sufficient precision. More specifically, it depends on:

- The time needed for the receiver adaptive gain control (AGC) to acquire the signal strength.
- The time needed for the receiver to acquire the maximum possible frequency offset (registers MAXRFOFFSET0, MAXRFOFFSET1 and MAXRFOFFSET2).
- The time needed for the receiver to acquire the maximum possible data rate offset (registers MAXDROFFSET0, MAXDROFFSET1 and MAXDROFFSET2).
- The time needed for the receiver to acquire the exact bit sampling time (registers TIMEGAIN0, TIMEGAIN1, TIMEGAIN2 and TIMEGAIN3).
- The time needed to acquire the actual frequency deviation in 4-FSK mode (registers FSKDMAX0, FSKDMAX1, FSKDMIN0 and FSKDMAX0).

On the AX5043, these loops run in parallel. An AGC that is significantly off however causes the received signal to fall outside the IF strip dynamic range, and thus prevents the other loops from working. And a frequency offset that is compensated insufficiently causes the received signal to fall (partially) outside the IF filter, thus also preventing the timing and 4-FSK loops from working.

The minimum possible preamble duration can be achieved under the following conditions:

- Use a transmitter with a sufficiently precise bit timing. If the maximum deviation of the transmitter data rate from the receiver data rate is less than approximately 0.1%, then the data rate acquisition loop should be switched off completely (setting registers

MAXDROFFSET0, MAXDROFFSET1 and MAXDROFFSET2 to zero). The AX5043 is able to track the remaining small offset without the data rate offset loop. All Axsem transmitters derive the bit rate timing from the crystal reference and can therefore easily meet this requirement.

- Use an FSK frequency deviation that is larger than the maximum frequency offset between transmitter and receiver. In this case, receiver frequency offset acquisition is not needed. Do not use 4-FSK.
- Use the AX5043 receiver parameter set feature, below.

Finally, the frame synchronization word achieves byte synchronization.

The recommended preamble bit pattern is now discussed.

If the standard to be implemented requires a specific preamble, use it.

In *FEC* mode, HDLC [1] flags (pattern 01111110) must be transmitted. The convolutional encoder ensures enough bit transitions, and the AX5043 receiver needs flags to synchronize its interleaver.

If the *scrambler* or *manchester* is enabled, send RAW bytes 00010001. The scrambler or manchester encoder ensure enough transitions to acquire the bit timing.

In *4-FSK* mode, send UNENCODED bytes 00010001. This ensures that the preamble toggles between the highest and the lowest frequency. The frequent transitions ensure the bit timing is acquired as quickly as possible, and the maximum and minimum frequencies allow the deviation to be acquired.

Otherwise, use UNENCODED 01010101. This preamble ensures the maximum number of transitions for bit timing synchronization. This preamble could also be used with the scrambler enabled; the main purpose of the scrambler is however to ensure no spectral lines (tones), this would be defeated by this preamble.

If MSBFIRST in register PKTADDRCFG is set, then the preamble sequences should be reversed.

Receiver

Figure 10 shows the receiver flow chart. When the microprocessor places the chip into FULLRX mode, the AX5043 immediately powers up the synthesizer, settles it

(registers TMGRXBOOST and TMGRXSETTLE determine the timing) and starts receiving. The reception continues until the microprocessor changes the PWRMODE register.

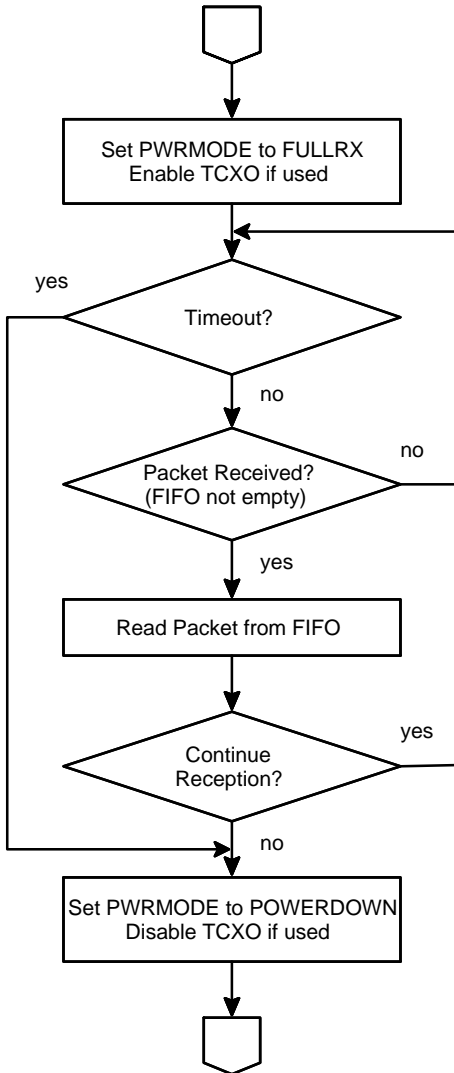

Figure 10. Receiver Flow Chart

If antenna diversity is enabled, the AX5043 continuously switches between the antennas (controlled by the ANTSEL pin) to find the antenna with the better signal strength, until a valid preamble is detected. Antenna scanning is resumed after a packet is completed.

Actual packet data in the FIFO may be preceded and followed by meta-data. Meta-data may be a time stamp at the beginning of the packet, and signal strength, frequency offset and data rate offset at the end of the packet. Which meta-data is written to the FIFO is controlled by the register PKTSTOREFLAGS.

Wake-on-Radio mode allows the AX5043 to periodically poll the radio channel for a transmission while using only very little power. Figure 11 shows the wake-on-radio flow

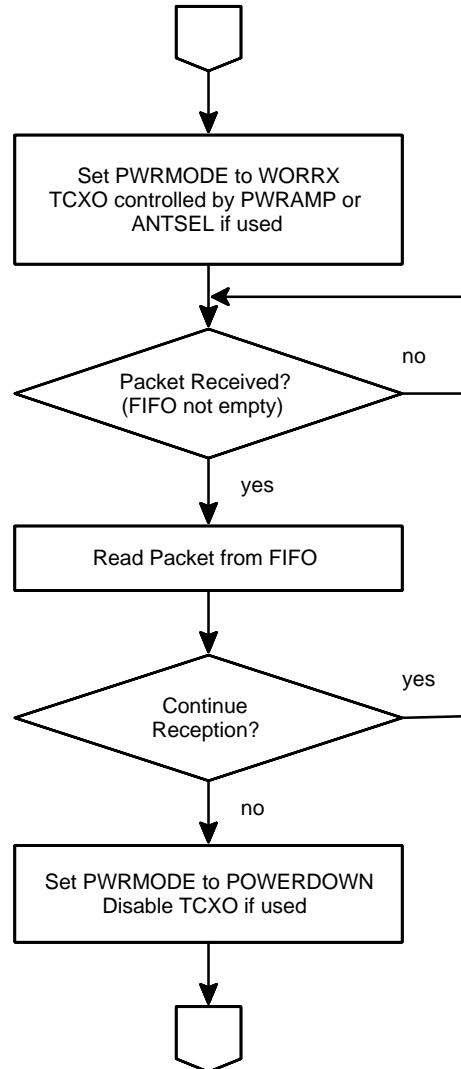

Figure 11. Wake-on-Radio Receiver Flow Chart

chart. The AX5043 periodically wakes up. The wake-up is controlled by the on-chip low-power 640 Hz/10 kHz RC oscillator and the period is programmed using the WAKEUPFREQ1 and WAKEUPFREQ0 registers.

After waking up, the AX5043 quickly settles the AGC and computes the channel RSSI. If it is below an absolute threshold (register RSSIABSTHR) and a dynamic threshold (register BGNDRSSITHR), it is switched off immediately. Otherwise, it looks for a valid preamble. If none is found within a preprogrammed time (registers TMGRXPREAMBLE1 and TMGRXPREAMBLE2), the receiver is powered down. Otherwise, it continues to receive the packet.

If a packet is successfully received, the receiver may either be shut down again, or continue to run if WORMULTIPKT is set in register PKTMISCFLAGS.

In Wake-on-Radio mode, the AX5043 is completely autonomous until a packet is received. The microprocessor may be shut down and only wake up once the FIFO is no longer empty (IRQMFIFONOTEMPTY interrupt in register IRQMASK0).

Receiver State Machine

Figure 12 shows the receiver timing diagram. The actions in the first two lines are time controlled. The arrows below indicate which register controls the timing. The actions colored in a darker shade of blue are only performed when diversity mode is enabled (DIVENA is set in register DIVERSITY). The actions in the last line are detailed in the state diagram Figure 13.

SYNTHBOOST and SYNTHSETTLE form the two stage procedure to settle the synthesizer on the first LO frequency. During SYNTHBOOST, the synthesizer is operated at a higher loop bandwidth (register PLLLOOPBOOST), while during SYNTHSETTLE, the final settling is done at the nominal, lower noise, loop bandwidth (register PLLLOOP).

IFINIT settles the IF strip. COARSEAGC uses a fast AGC time constant to quickly settle the AGC to a value close to the correct one. This is especially important during wake-on-radio, as it is desirable to keep the receiver powered the shortest possible time to save power. AGC settles the AGC using a slower time constant. RSSI measures the received signal strength. This value is then used to determine whether the receiver should be kept running in wake-on-radio, or to select the antenna with the stronger signal in diversity mode.

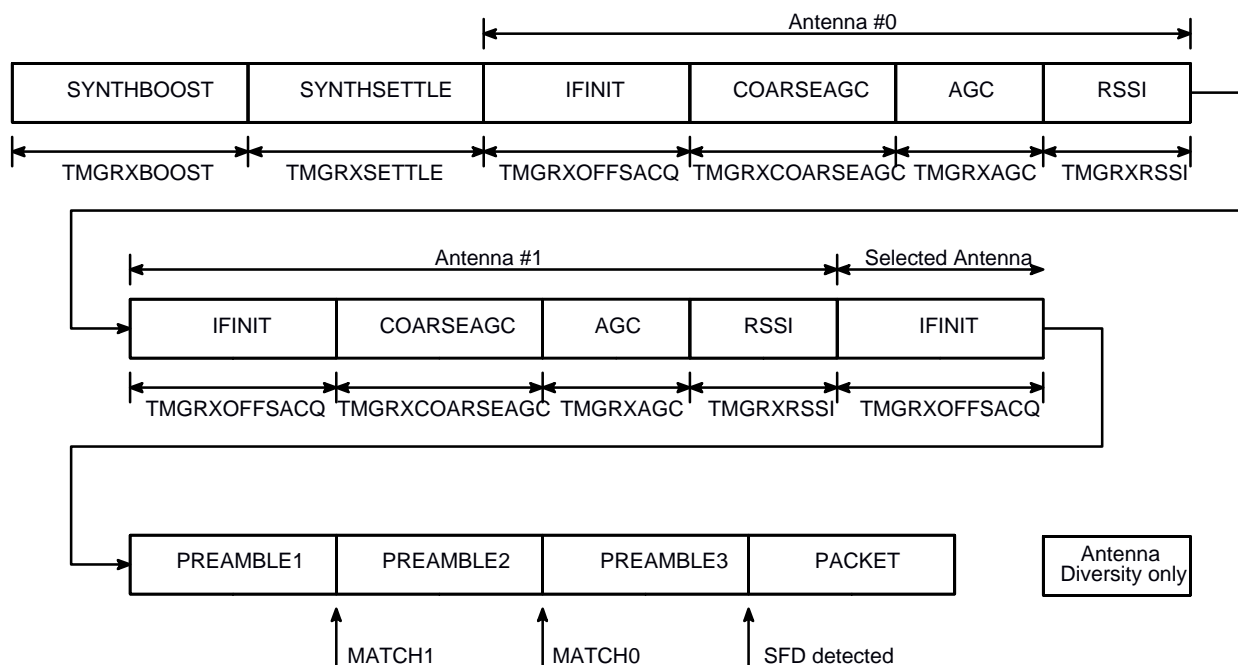

Figure 12. Transmitter Flow Chart

Once the receiver is initialized, PREAMBLE1, PREAMBLE2, PREAMBLE3, and PACKET coordinate the reception of packets. The receiver contains several loops that acquire and track transmission parameters the receiver needs to know in order to correctly receive a packet.

- The AGC acquires and tracks the signal strength
- The frequency tracking loop acquires and tracks the frequency offset
- The timing and data rate tracking loop acquires and tracks the sampling time and the data rate offset

The bandwidth of these loops is programmable. The bandwidth controls the acquisition time as well as the

noisiness of the parameter estimates. In order to allow both fast acquisition to enable short preambles and low steady state noise performance to enable high receiver sensitivity, the receiver supports multiple acquisition and tracking loop parameter sets. When the receiver searches for a transmission signal, it uses wide loop bandwidths. Once it detects a preamble with sufficient probability, it switches to a lower loop bandwidth. Once a frame start is detected, it switches to an even lower loop bandwidth. Figure 13 shows the state diagram that controls which receiver parameter set is used.

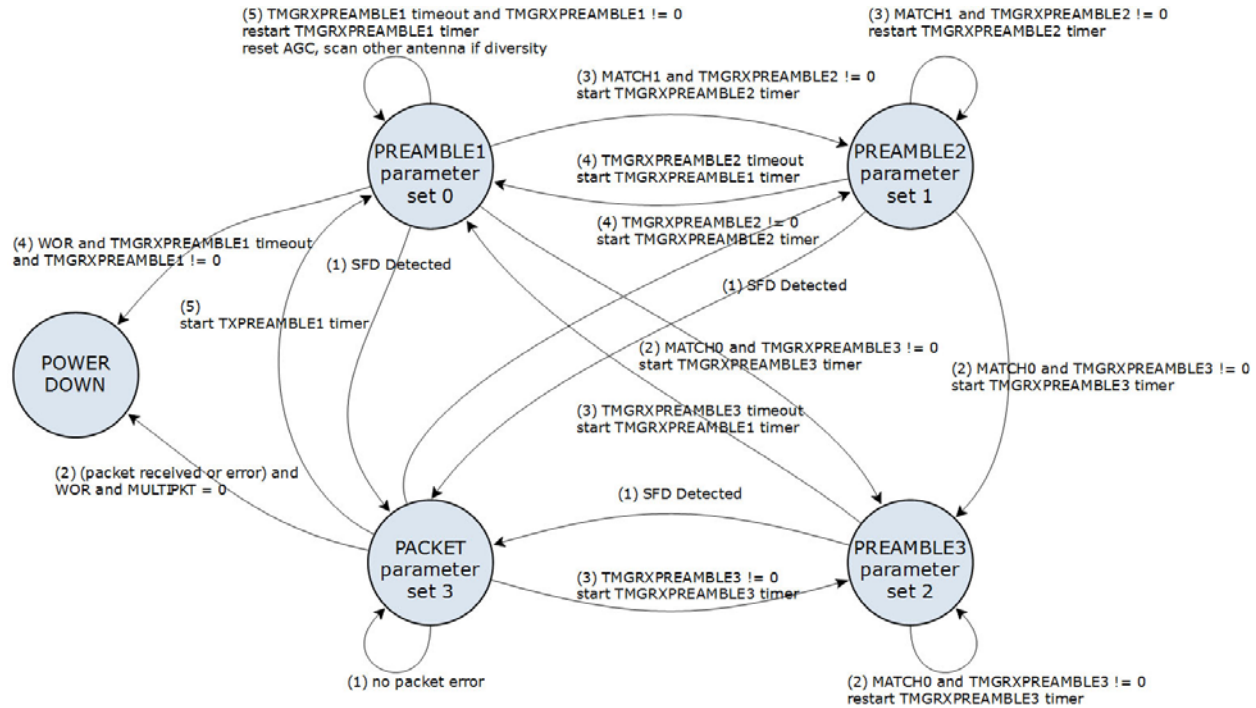

Figure 13. Receiver State Diagram

Conditions are evaluated in priority order. The priority number is given in parentheses at the beginning of arrow labels.

In order to reduce the number of registers that need to be programmed if not all parameter sets are different, the parameter set number of Figure 13 is not directly used to address the parameter set. Instead, it indexes into register RXPARAMSETS, where the actual parameter set number is read out.

Low Power Oscillator Calibration

The low power oscillator is used to control the wake-up frequency, or polling period, during wake-on-radio mode. In

order to increase the precision of the wake-up frequency, calibration logic allows the low power oscillator to be calibrated against the crystal oscillator or TCXO.

Figure 14 shows a block diagram of the calibration logic. It works similarly to a PLL. The reference frequency from the crystal or TCXO is divided by the value of the LPOSCREF register. This signal is then compared to the actual frequency of the Low Power Oscillator. The frequency difference is then low pass filtered (LPOSCFILT register) and used to adjust the Low Power Oscillator frequency (LPOSCFREQ register).

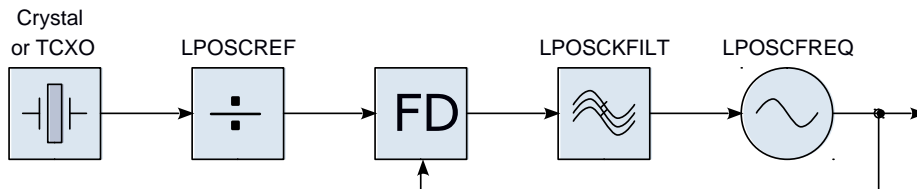

Figure 14. Low Power Oscillator Calibration Logic

When enabled (LPOSCCALIBR or LPOSCCALIBF enabled in register LPOSCCONFIG), the calibration logic is only activated when the crystal oscillator or TCXO is

enabled as well. This allows “opportunistic” calibration – the Low Power Oscillator is calibrated whenever the reference frequency is enabled.

Auxiliary DAC

The AX5043 contains an auxiliary DAC. It can be used to output various receiver signals, such as RSSI or Frequency Offset, or just a value under program control. The DAC signal can be output either on the PWRAMP or ANTSEL pad.

The DAC may be operated in two modes. $\Sigma\Delta$ mode employs a digital modulator to output a high resolution signal. Its output voltage range is $\frac{1}{4}$ VDDIO to $\frac{3}{4}$ VDDIO for a DACVALUE range from -2048 to 2047 .

PWM mode outputs a pulse width modulated signal. It is only suitable for low frequency signals. Its output voltage range is 0 to $VDDIO$ for a DACVALUE range from -2048 to 2047 .

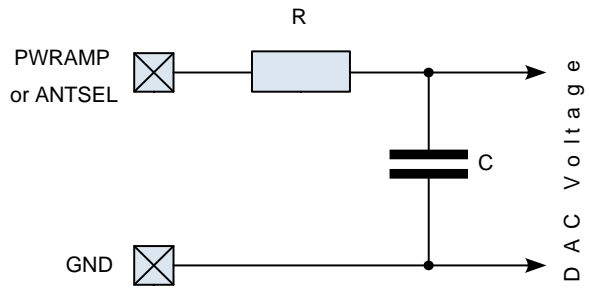

Figure 15. DAC RC Filter

A low pass filter, such as a simple R-C filter as shown in Figure 15, must be used to obtain the analog voltage.

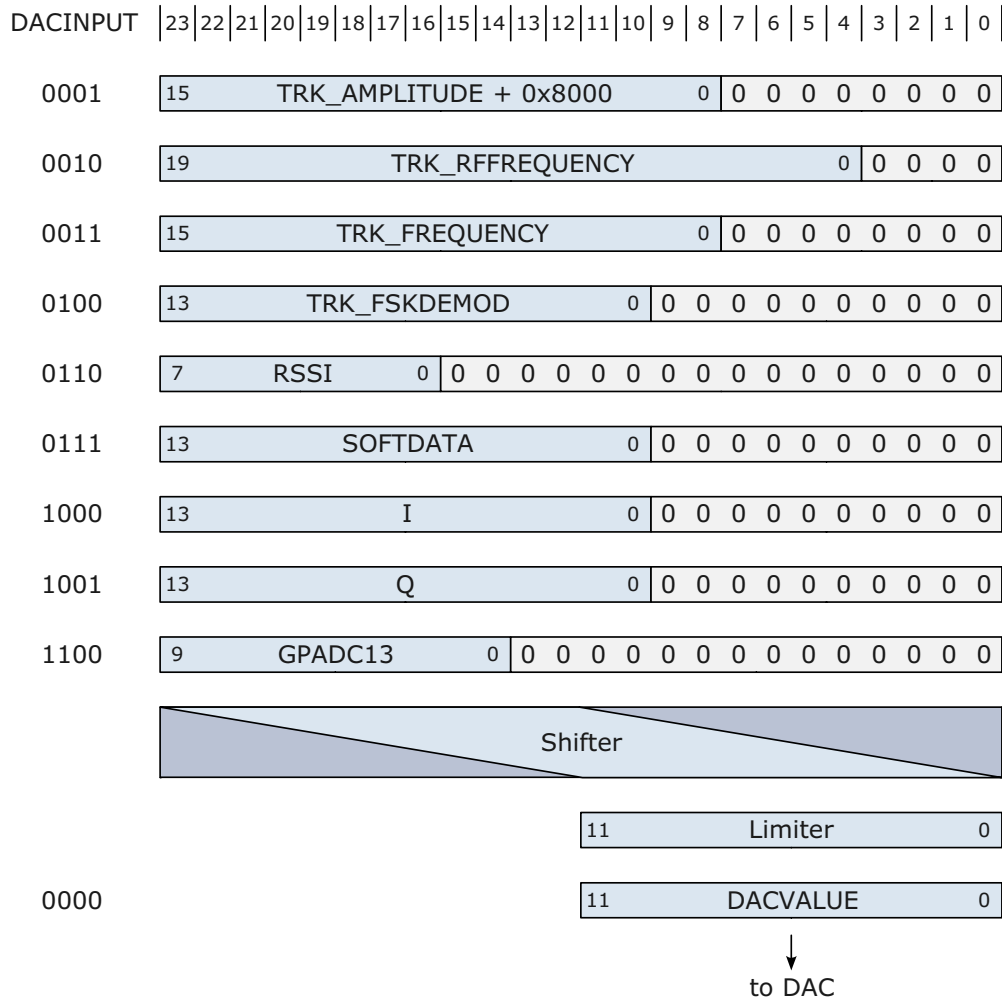

Figure 16. DAC Signal Scaling

Figure 16 shows the DAC Signal scaling. DACINPUT in register DACCONFIG selects the source signal. The input signals are left aligned to 24 bits and padded with zeros. A signed shifter then shifts the selected value to the right by 0 to 15 digits as selected by the lower four bits of the DACVALUE register. The signal is then limited to the DAC

value range of $-2^{11} \dots 2^{11} - 1$. This signal is then sent to the DAC core. Note that if DACVALUE is selected as input, the register value is directly sent to the DAC, the shifter is not used. In fact, DACVALUE and DACSHIFT share the same register bits.

REGISTER OVERVIEW

Table 22. CONTROL REGISTER MAP

Addr	Name	Dir	R	Reset	Bit								Description
					7	6	5	4	3	2	1	0	
Revision & Interface Probing													
000	REVISION	R	R	01010001	SILICONREV(7:0)								Silicon Revision
001	SCRATCH	RW	R	11000101	SCRATCH(7:0)								Scratch Register
Operating Mode													
002	PWRMODE	RW	R	011-0000	RST	REFEN	XOEN	WDS	PWRMODE(3:0)				Power Mode
Voltage Regulator													
003	POWSTAT	R	R	-----	SSUM	SREF	SVREF	SVANA	SV MODEM	SBE VANA	SBEV MODEM	SVIO	Power Management Status
004	POWSTICKYSTAT	R	R	-----	SSSUM	SSREF	SSVREF	SSVANA	SSV MODEM	SS BEVANA	SSBEV MODEM	SSVIO	Power Management Sticky Status
005	POWIRQMASK	RW	R	00000000	MPWR GOOD	MSREF	MSVREF	MS VANA	MSV MODEM	MS BE VANA	MSBEV MODEM	MSVIO	Power Management Interrupt Mask
Interrupt Control													
006	IRQMASK1	RW	R	---00000	-	-	-	IRQMASK(12:8)				IRQ Mask	
007	IRQMASK0	RW	R	00000000	IRQMASK(7:0)								IRQ Mask
008	RADIOEVENTMASK1	RW	R	-----0	-	-	-	-	-	-	-	RADIO EVENT MASK (8)	Radio Event Mask
009	RADIOEVENTMASK0	RW	R	00000000	RADIO EVENT MASK (7:0)								Radio Event Mask
00A	IRQINVERSION1	RW	R	---00000	-	-	-	IRQINVERSION (12:8)				IRQ Inversion	
00B	IRQINVERSION0	RW	R	00000000	IRQINVERSION (7:0)								IRQ Inversion
00C	IRQREQUEST1	R	R	-----	-	-	-	IRQREQUEST (12:8)				IRQ Request	
00D	IRQREQUEST0	R	R	-----	IRQREQUEST (7:0)								IRQ Request
00E	RADIOEVENTREQ1	R		-----	-	-	-	-	-	-	-	RADIO EVENT REQ(8)	Radio Event Request
00F	RADIOEVENTREQ0	R		-----	RADIO EVENT REQ (7:0)								Radio Event Request
Modulation & Framing													
010	MODULATION	RW	R	---01000	-	-	-	RX HALF SPEED	MODULATION(3:0)				Modulation
011	ENCODING	RW	R	---00010	-	-	-	ENC NOSYNC	ENC MANCH	ENC SCRAM	ENC DIFF	ENC INV	Encoder/Decoder Settings
012	FRAMING	RW	R	-0000000	FRMRX	CRCMODE (2:0)			FRMMODE (2:0)			FABORT	Framing settings
014	CRCINIT3	RW	R	11111111	CRCINIT (31:24)								CRC Initialisation Data
015	CRCINIT2	RW	R	11111111	CRCINIT (23:16)								CRC Initialisation Data
016	CRCINIT1	RW	R	11111111	CRCINIT (15:8)								CRC Initialisation Data
017	CRCINIT0	RW	R	11111111	CRCINIT (7:0)								CRC Initialisation Data

AND9347/D

Table 22. CONTROL REGISTER MAP(continued)

Addr Hex	Name	Dir	R	Reset	Bit								Description
					7	6	5	4	3	2	1	0	
Forward Error Correction													
018	FEC	RW	R	00000000	SHORT MEM	RSTVI TERBI	FEC NEG	FEC POS	FECINPSHIFT (2:0)			FEC ENA	FEC (Viterbi) Configuration
019	FECSYNC	RW	R	01100010	FECSYNC (7:0)							Interleaver Synchronisation Threshold	
01A	FECSTATUS	R	R	-----	FEC INV	MAXMETRIC (6:0)						FEC Status	
Status													
01C	RADIOSTATE	R	-	----0000	-	-	-	-	RADIOSTATE (3:0)			Radio Controller State	
01D	XTALSTATUS	R	R	-----	-	-	-	-	-	-	-	XTAL RUN	Crystal Oscillator Status
Pin Configuration													
020	PINSTATE	R	R	-----	-	-	PS PWR AMP	PS ANT SEL	PS IRQ	PS DATA	PS DCLK	PS SYS CLK	Pinstate
021	PINFUNCSYSCLK	RW	R	0--01000	PU SYSCLK	-	-	PFSYSCLK (4:0)				SYSCLK Pin Function	
022	PINFUNCDCLK	RW	R	00---100	PU DCLK	PI DCLK	-	-	-	PFDCLK (2:0)			DCLK Pin Function
023	PINFUNCDATA	RW	R	10---111	PU DATA	PI DATA	-	-	-	PFDATA (2:0)			DATA Pin Function
024	PINFUNCIRQ	RW	R	00---011	PU IRQ	PI IRQ	-	-	-	PFIRQ (2:0)			IRQ Pin Function
025	PINFUNCANTSEL	RW	R	00---110	PU ANTSEL	PI ANTSEL	-	-	-	PFANTSEL (2:0)			ANTSEL Pin Function
026	PINFUNCPWRAMP	RW	R	00--0110	PU PWRAMP	PI PWRAMP	-	-	PFWRAMP(3:0)			PWRAMP Pin Function	
027	PWRAMP	RW	R	-----0	-	-	-	-	-	-	-	PWRAMP	PWRAMP Control
FIFO													
028	FIFOSTAT	R	R	0-----	FIFO AUTO COMMIT	-	FIFO FREE THR	FIFO CNT THR	FIFO OVER	FIFO UNDER	FIFO FULL	FIFO EMPTY	FIFO Control
		W				-	FIFOCMD (5:0)						
029	FIFODATA	RW		-----	FIFODATA (7:0)			FIFO Data					
02A	FIFOCOUNT1	R	R	-----0	-	-	-	-	-	-	-	FIFO COUNT (8)	Number of Words currently in FIFO
02B	FIFOCOUNT0	R	R	00000000	FIFOCOUNT (7:0)							Number of Words currently in FIFO	
02C	FIFOFREE1	R	R	-----1	-	-	-	-	-	-	-	FIFO FREE(8)	Number of Words that can be written to FIFO
02D	FIFOFREE0	R	R	00000000	FIFOFREE (7:0)							Number of Words that can be written to FIFO	
02E	FIFOTHRESH1	RW	R	-----0	-	-	-	-	-	-	-	FIFO THRESH (8)	FIFO Threshold
02F	FIFOTHRESH0	RW	R	00000000	FIFOTHRESH (7:0)							FIFO Threshold	

Table 22. CONTROL REGISTER MAP(continued)

Addr	Name	Dir	R	Reset	Bit								Description
					7	6	5	4	3	2	1	0	
Synthesizer													
030	PLLOOP	RW	R	0---1001	FREQB	-	-	-	DIRECT	FILT EN	FLT (1:0)	PLL Loop Filter Settings	
031	PLLCPI	RW	R	00001000	PLLCPI							PLL Charge Pump Current (Boosted)	
032	PLLVCO DIV	RW	R	-000-000	-	VCOI MAN	VCO2INT	VCOSEL	-	RFDIV	REFDIV (1:0)	PLL Divider Settings	
033	PLLRANGINGA	RW	R	00001000	STICKY LOCK	PLL LOCK	RNGERR	RNG START	VCORA (3:0)			PLL Autoranging	
034	FREQA3	RW	R	00111001	FREQA (31:24)							Synthesizer Frequency	
035	FREQA2	RW	R	00110100	FREQA (23:16)							Synthesizer Frequency	
036	FREQA1	RW	R	11001100	FREQA (15:8)							Synthesizer Frequency	
037	FREQA0	RW	R	11001101	FREQA (7:0)							Synthesizer Frequency	
038	PLLOOPBOOST	RW	R	0---1011	FREQB	-	-	-	DIRECT	FILT EN	FLT (1:0)	PLL Loop Filter Settings (Boosted)	
039	PLLCPIBOOST	RW	R	11001000	PLLCPI							PLL Charge Pump Current	
03B	PLLRANGINGB	RW	R	00001000	STICKY LOCK	PLL LOCK	RNGERR	RNG START	VCORB (3:0)			PLL Autoranging	
03C	FREQB3	RW	R	00111001	FREQB (31:24)							Synthesizer Frequency	
03D	FREQB2	RW	R	00110100	FREQB (23:16)							Synthesizer Frequency	
03E	FREQB1	RW	R	11001100	FREQB (15:8)							Synthesizer Frequency	
03F	FREQB0	RW	R	11001101	FREQB (7:0)							Synthesizer Frequency	
Signal Strength													
040	RSSI	R	R	-----	RSSI (7:0)							Received Signal Strength Indicator	
041	BGNDRSSI	RW	R	00000000	BGNDRSSI (7:0)							Background RSSI	
042	DIVERSITY	RW	R	-----00	-	-	-	-	-	ANT SEL	DIV ENA	Antenna Diversity Configuration	
043	AGCCOUNTER	RW	R	-----	AGCCOUNTER (7:0)							AGC Current Value	
Receiver Tracking													
045	TRKDATARATE2	R	R	-----	TRKDATARATE (23:16)							Datarate Tracking	
046	TRKDATARATE1	R	R	-----	TRKDATARATE (15:8)							Datarate Tracking	
047	TRKDATARATE0	R	R	-----	TRKDATARATE (7:0)							Datarate Tracking	
048	TRKAMPL1	R	R	-----	TRKAMPL (15:8)							Amplitude Tracking	
049	TRKAMPL0	R	R	-----	TRKAMPL (7:0)							Amplitude Tracking	
04A	TRKPHASE1	R	R	-----	-	-	-	-	TRKPHASE (11:8)			Phase Tracking	
04B	TRKPHASE0	R	R	-----	TRKPHASE (7:0)							Phase Tracking	

AND9347/D

Table 22. CONTROL REGISTER MAP(continued)

Addr Hex	Name	Dir	R	Reset	Bit								Description	
					7	6	5	4	3	2	1	0		
Receiver Tracking														
04D	TRKRFFREQ2	RW	R	-----	-	-	-	-	-	-	-	-	TRRFKFREQ (19:16)	RF Frequency Tracking
04E	TRKRFFREQ1	RW	R	-----	TRRFKFREQ (15:8)								RF Frequency Tracking	
04F	TRKRFFREQ0	RW	R	-----	TRRFKFREQ (7:0)								RF Frequency Tracking	
050	TRKFREQ1	RW	R	-----	TRKFREQ (15:8)								Frequency Tracking	
051	TRKFREQ0	RW	R	-----	TRKFREQ (7:0)								Frequency Tracking	
052	TRKFSKDEM0D1	R	R	-----	-	-	TRKFSKDEM0D (13:8)						FSK Demodulator Tracking	
053	TRKFSKDEM0D0	R	R	-----	TRKFSKDEM0D (7:0)								FSK Demodulator Tracking	
Timer														
059	TIMER2	R	-	-----	TIMER (23:16)								1 MHz Timer	
05A	TIMER1	R	-	-----	TIMER (15:8)								1 MHz Timer	
05B	TIMER0	R	-	-----	TIMER (7:0)								1 MHz Timer	
Wakeup Timer														
068	WAKEUPTIMER1	R	R	-----	WAKEUPTIMER (15:8)								Wakeup Timer	
069	WAKEUPTIMER0	R	R	-----	WAKEUPTIMER (7:0)								Wakeup Timer	
06A	WAKEUP1	RW	R	00000000	WAKEUP (15:8)								Wakeup Time	
06B	WAKEUP0	RW	R	00000000	WAKEUP (7:0)								Wakeup Time	
06C	WAKEUPFREQ1	RW	R	00000000	WAKEUPFREQ (15:8)								Wakeup Frequency	
06D	WAKEUPFREQ0	RW	R	00000000	WAKEUPFREQ (7:0)								Wakeup Frequency	
06E	WAKEUPXOEARLY	RW	R	00000000	WAKEUPXOEARLY (7:0)								Wakeup Crystal Oscillator Early	
Physical Layer Parameters														
Receiver Parameters														
100	IFFREQ1	RW	R	00010011	IFFREQ (15:8)								2nd LO / IF Frequency	
101	IFFREQ0	RW	R	00100111	IFFREQ (7:0)								2nd LO / IF Frequency	
102	DECIMATION	RW	R	-0001101	-	DECIMATION (6:0)							Decimation Factor	
103	RXDATARATE2	RW	R	00000000	RXDATARATE (23:16)								Receiver Datarate	
104	RXDATARATE1	RW	R	00111101	RXDATARATE (15:8)								Receiver Datarate	
105	RXDATARATE0	RW	R	10001010	RXDATARATE (7:0)								Receiver Datarate	
106	MAXDROFFSET2	RW	R	00000000	MAXDROFFSET (23:16)								Maximum Receiver Datarate Offset	
107	MAXDROFFSET1	RW	R	00000000	MAXDROFFSET (15:8)								Maximum Receiver Datarate Offset	
108	MAXDROFFSET0	RW	R	10011110	MAXDROFFSET (7:0)								Maximum Receiver Datarate Offset	

AND9347/D

Table 22. CONTROL REGISTER MAP(continued)

Addr	Name	Dir	R	Reset	Bit								Description
					7	6	5	4	3	2	1	0	
Receiver Parameters													
109	MAXRFOFFSET2	RW	R	0---0000	FREQ OFFS CORR	-	-	-	-	MAXRFOFFSET (19:16)			Maximum Receiver RF Offset
10A	MAXRFOFFSET1	RW	R	00010110	MAXRFOFFSET (15:8)							Maximum Receiver RF Offset	
10B	MAXRFOFFSET0	RW	R	10000111	MAXRFOFFSET (7:0)							Maximum Receiver RF Offset	
10C	FSKDMAX1	RW	R	00000000	FSKDEVMAX (15:8)							Four FSK Rx Deviation	
10D	FSKDMAX0	RW	R	10000000	FSKDEVMAX (7:0)							Four FSK Rx Deviation	
10E	FSKDMIN1	RW	R	11111111	FSKDEVMIN (15:8)							Four FSK Rx Deviation	
10F	FSKDMIN0	RW	R	10000000	FSKDEVMIN (7:0)							Four FSK Rx Deviation	
110	AFSKSPACE1	RW	R	----0000	-	-	-	-	AFSKSPACE(11:8)			AFSK Space (0) Frequency	
111	AFSKSPACE0	RW	R	01000000	AFSKSPACE (7:0)							AFSK Space (0) Frequency	
112	AFSKMARK1	RW	R	----0000	-	-	-	-	AFSKMARK (11:8)			AFSK Mark (1) Frequency	
113	AFSKMARK0	RW	R	01110101	AFSKMARK (7:0)							AFSK Mark (1) Frequency	
114	AFSKCTRL	RW	R	---00100	-	-	-	AFSKSHIFT0 (4:0)			AFSK Control		
115	AMPLFILTER	RW	R	----0000	-	-	-	-	AMPLFILTER (3:0)			Amplitude Filter	
116	FREQUENCYLEAK	RW	R	----0000	-	-	-	-	FREQUENCYLEAK (3:0)			Baseband Frequency Recovery Loop Leakiness	
117	RXPARAMSETS	RW	R	00000000	RXPS3 (1:0)		RXPS2 (1:0)		RXPS1 (1:0)		RXPS0 (1:0)	Receiver Parameter Set Indirection	
118	RXPARAMCURSET	R	R	-----	-	-	-	RXSI (2)	RXSN (1:0)		RXSI (1:0)	Receiver Parameter Current Set	
Receiver Parameter Set 0													
120	AGCGAIN0	RW	R	10110100	AGCDECAY0 (3:0)				AGCATTACK0 (3:0)				AGC Speed
121	AGCTARGET0	RW	R	01110110	AGCTARGET0 (7:0)							AGC Target	
122	AGCAHYST0	RW	R	-----000	-	-	-	-	AGCAHYST0 (2:0)			AGC Digital Threshold Range	
123	AGCMINMAX0	RW	R	-000-000	-	AGCMAXDA0 (2:0)			-	AGCMINDA0 (2:0)			AGC Digital Minimum/Maximum Set Points
124	TIMEGAIN0	RW	R	11111000	TIMEGAIN0M (3:0)				TIMEGAIN0E (3:0)				Timing Gain
125	DRGAIN0	RW	R	11110010	DRGAIN0M (3:0)				DRGAIN0E (3:0)				Data Rate Gain
126	PHASEGAIN0	RW	R	11--0011	FILTERIDX0 (1:0)		-	-	PHASEGAIN0 (3:0)				Filter Index, Phase Gain
127	FREQGAINA0	RW	R	00001111	FREQ LIM0	FREQ MODULO 0	FREQ HALFMOD 0	FREQ AMPL GATE0	FREQGAINA0 (3:0)				Frequency Gain A

AND9347/D

Table 22. CONTROL REGISTER MAP(continued)

Addr Hex	Name	Dir	R	Reset	Bit								Description
					7	6	5	4	3	2	1	0	
Receiver Parameter Set 0													
128	FREQGAINB0	RW	R	00-11111	FREQ FREEZE0	FREQ AVG0	-	FREQGAINB0 (4:0)				Frequency Gain B	
129	FREQGAINC0	RW	R	---01010	-	-	-	FREQGAINC0 (4:0)				Frequency Gain C	
12A	FREQGAIND0	RW	R	0--01010	RFFREQ FREEZE0	-	-	FREQGAIND0 (4:0)				Frequency Gain D	
12B	AMPLGAIN0	RW	R	01--0110	AMPL AVG0	AMPL AGC0	-	-	AMPLGAIN0 (3:0)			Amplitude Gain	
12C	FREQDEV10	RW	R	----0000	-	-	-	-	FREQDEV0 (11:8)			Receiver Frequency Deviation	
12D	FREQDEV00	RW	R	00100000	FREQDEV0 (7:0)						Receiver Frequency Deviation		
12E	FOURFSK0	RW	R	---10110	-	-	-	DEV UPDATE0	DEVDECAY0 (3:0)			Four FSK Control	
12F	BBOFFSRES0	RW	R	10001000	RESINTB0 (3:0)				RESINTA0 (3:0)				Baseband Offset Compensation Resistors
Receiver Parameter Set 1													
130	AGCGAIN1	RW	R	10110100	AGCDECAY1 (3:0)				AGCATTACK1 (3:0)				AGC Speed
131	AGCTARGET1	RW	R	01110110	AGCTARGET1 (7:0)							AGC Target	
132	AGCAHYST1	RW	R	----000	-	-	-	-	-	AGCAHYST1 (2:0)		AGC Digital Threshold Range	
133	AGCMINMAX1	RW	R	-000-000	-	AGCMAXDA1 (2:0)			-	AGCMINDA1 (2:0)		AGC Digital Minimum/ Maximum Set Points	
134	TIMEGAIN1	RW	R	11110110	TIMEGAIN1M (3:0)				TIMEGAIN1E (3:0)				Timing Gain
135	DRGAIN1	RW	R	11110001	DRGAIN1M (3:0)				DRGAIN1E (3:0)				Data Rate Gain
136	PHASEGAIN1	RW	R	11--0011	FILTERIDX1 (1:0)		-	-	PHASEGAIN1 (3:0)				Filter Index, Phase Gain
137	FREQGAINA1	RW	R	00001111	FREQ LIM1	FREQ MODULO 1	FREQ HALFMOD 1	FREQ AMPL GATE1	FREQGAINA1 (3:0)				Frequency Gain A
138	FREQGAINB1	RW	R	00-11111	FREQ FREEZE1	FREQ AVG1	-	FREQGAINB1 (4:0)				Frequency Gain B	
139	FREQGAINC1	RW	R	---01011	-	-	-	FREQGAINC1 (4:0)				Frequency Gain C	
13A	FREQGAIND1	RW	R	0--01011	RFFREQ FREEZE1	-	-	FREQGAIND1 (4:0)				Frequency Gain D	
13B	AMPLGAIN1	RW	R	01--0110	AMPL AVG1	AMPL1 AGC1	-	-	AMPLGAIN1 (3:0)			Amplitude Gain	
13C	FREQDEV11	RW	R	----0000	-	-	-	-	FREQDEV1 (11:8)			Receiver Frequency Deviation	
13D	FREQDEV01	RW	R	00100000	FREQDEV1 (7:0)						Receiver Frequency Deviation		

AND9347/D

Table 22. CONTROL REGISTER MAP(continued)

Addr	Name	Dir	R	Reset	Bit								Description
					7	6	5	4	3	2	1	0	
Receiver Parameter Set 1													
13E	FOURFSK1	RW	R	----11000	-	-	-	DEV UPDATE1	DEVDECAY1 (3:0)			Four FSK Control	
13F	BBOFFSRES1	RW	R	10001000	RESINTB1 (3:0)			RESINTA1 (3:0)			Baseband Offset Compensation Resistors		
Receiver Parameter Set 2													
140	AGCGAIN2	RW	R	11111111	AGCDECAY2 (3:0)			AGCATTACK2 (3:0)			AGC Speed		
141	AGCTARGET2	RW	R	01110110	AGCTARGET2 (7:0)						AGC Target		
142	AGCAHYST2	RW	R	-----000	-	-	-	-	-	AGCAHYST2 (2:0)	AGC Digital Threshold Range		
143	AGCMINMAX2	RW	R	-000-000	-	AGCMAXDA2(2:0)		-	AGCMINDA2 (2:0)		AGC Digital Minimum/ Maximum Set Points		
144	TIMEGAIN2	RW	R	11110101	TIMEGAIN2M (3:0)			TIMEGAIN2E (3:0)			Timing Gain		
145	DRGAIN2	RW	R	11110000	DRGAIN2M (3:0)			DRGAIN2E (3:0)			Data Rate Gain		
146	PHASEGAIN2	RW	R	11--0011	FILTERIDX2 (1:0)		-	-	PHASEGAIN2 (3:0)		Filter Index, Phase Gain		
147	FREQGAINA2	RW	R	00001111	FREQ LIM2	FREQ MODULO 2	FREQ HALFMOD 2	FREQ AMPL GATE2	FREQGAINA2 (3:0)		Frequency Gain A		
148	FREQGAINB2	RW	R	00-11111	FREQ FREEZE2	FREQ AVG2	-	FREQGAINB2 (4:0)			Frequency Gain B		
149	FREQGAINC2	RW	R	---01101	-	-	-	FREQGAINC2 (4:0)			Frequency Gain C		
14A	FREQGAIND2	RW	R	0--01101	RFFREQ FREEZE2	-	-	FREQGAIND2 (4:0)			Frequency Gain D		
14B	AMPLGAIN2	RW	R	01--0110	AMPL AVG2	AMPL AGC2	-	-	AMPLGAIN2 (3:0)		Amplitude Gain		
14C	FREQDEV12	RW	R	----0000	-	-	-	-	FREQDEV2 (11:8)		Receiver Frequency Deviation		
14D	FREQDEV02	RW	R	00100000	FREQDEV2 (7:0)						Receiver Frequency Deviation		
14E	FOURFSK2	RW	R	----11010	-	-	-	DEV UPDATE2	DEVDECAY2 (3:0)		Four FSK Control		
14F	BBOFFSRES2	RW	R	10001000	RESINTB2 (3:0)			RESINTA2 (3:0)			Baseband Offset Compensation Resistors		
Receiver Parameter Set 3													
150	AGCGAIN3	RW	R	11111111	AGCDECAY3 (3:0)			AGCATTACK3 (3:0)			AGC Speed		
151	AGCTARGET3	RW	R	01110110	AGCTARGET3 (7:0)						AGC Target		
152	AGCAHYST3	RW	R	-----000	-	-	-	-	-	AGCAHYST3 (2:0)	AGC Digital Threshold Range		
153	AGCMINMAX3	RW	R	-000-000	-	AGCMAXDA3 (2:0)		-	AGCMINDA3 (2:0)		AGC Digital Minimum/ Maximum Set Points		
154	TIMEGAIN3	RW	R	11110101	TIMEGAIN3M (3:0)			TIMEGAIN3E (3:0)			Timing Gain		
155	DRGAIN3	RW	R	11110000	DRGAIN3M (3:0)			DRGAIN3E (3:0)			Data Rate Gain		

AND9347/D

Table 22. CONTROL REGISTER MAP(continued)

Addr	Name	Dir	R	Reset	Bit								Description
					7	6	5	4	3	2	1	0	
Receiver Parameter Set 3													
156	PHASEGAIN3	RW	R	11---0011	FILTERIDX3 (1:0)		-	-	PHASEGAIN3 (3:0)			Filter Index, Phase Gain	
157	FREQGAINA3	RW	R	00001111	FREQ LIM3	FREQ MODULO 3	FREQ HALFMOD 3	FREQ AMPL GATE3	FREQGAINA3 (3:0)			Frequency Gain A	
158	FREQGAINB3	RW	R	00-11111	FREQ FREEZE3	FREQ AVG3	-	FREQGAINB3 (4:0)			Frequency Gain B		
159	FREQGAINC3	RW	R	---01101	-	-	-	FREQGAINC3 (4:0)			Frequency Gain C		
15A	FREQGAIND3	RW	R	0--01101	RFFREQ FREEZE3	-	-	FREQGAIND3 (4:0)			Frequency Gain D		
15B	AMPLGAIN3	RW	R	01---0110	AMPL AVG3	AMPL AGC3	-	-	AMPLGAIN3 (3:0)			Amplitude Gain	
15C	FREQDEV13	RW	R	----0000	-	-	-	-	FREQDEV3 (11:8)			Receiver Frequency Deviation	
15D	FREQDEV03	RW	R	00100000	FREQDEV3 (7:0)						Receiver Frequency Deviation		
15E	FOURFSK3	RW	R	---11010	-	-	-	DEV UPDATE3	DEVDECAY3 (3:0)			Four FSK Control	
15F	BBOFFSRES3	RW	R	10001000	RESINTB3 (3:0)				RESINTA3 (3:0)				Baseband Offset Compensation Resistors
Transmitter Parameters													
160	MODCFGF	RW	R	-----00	-	-	-	-	-	-	FREQ SHAPE (1:0)	Modulator Configuration F	
161	FSKDEV2	RW	R	00000000	FSKDEV (23:16)						FSK Frequency Deviation		
162	FSKDEV1	RW	R	00001010	FSKDEV (15:8)						FSK Frequency Deviation		
163	FSKDEV0	RW	R	00111101	FSKDEV (7:0)						FSK Frequency Deviation		
164	MODCFG A	RW	R	0000-101	BROWN GATE	PTTLCK GATE	SLOW RAMP (1:0)		-	AMPL SHAPE	TX SE	TX DIFF	Modulator Configuration A
165	TXRATE2	RW	R	00000000	TXRATE (23:16)						Transmitter Bitrate		
166	TXRATE1	RW	R	00101000	TXRATE (15:8)						Transmitter Bitrate		
167	TXRATE0	RW	R	11110110	TXRATE (7:0)						Transmitter Bitrate		
168	TXPWRCOEFFA1	RW	R	00000000	TXPWRCOEFFA (15:8)						Transmitter Predistortion Coefficient A		
169	TXPWRCOEFFA0	RW	R	00000000	TXPWRCOEFFA (7:0)						Transmitter Predistortion Coefficient A		
16A	TXPWRCOEFFB1	RW	R	00001111	TXPWRCOEFFB (15:8)						Transmitter Predistortion Coefficient B		
16B	TXPWRCOEFFB0	RW	R	11111111	TXPWRCOEFFB (7:0)						Transmitter Predistortion Coefficient B		

Table 22. CONTROL REGISTER MAP(continued)

Addr Hex	Name	Dir	R	Reset	Bit								Description
					7	6	5	4	3	2	1	0	
Transmitter Parameters													
16C	TXPWRCOEFFC1	RW	R	00000000	TXPWRCOEFFC (15:8)								Transmitter Predistortion Coefficient C
16D	TXPWRCOEFFC0	RW	R	00000000	TXPWRCOEFFC (7:0)								Transmitter Predistortion Coefficient C
16E	TXPWRCOEFFD1	RW	R	00000000	TXPWRCOEFFD (15:8)								Transmitter Predistortion Coefficient D
16F	TXPWRCOEFFD0	RW	R	00000000	TXPWRCOEFFD (7:0)								Transmitter Predistortion Coefficient D
170	TXPWRCOEFFE1	RW	R	00000000	TXPWRCOEFFE (15:8)								Transmitter Predistortion Coefficient E
171	TXPWRCOEFFE0	RW	R	00000000	TXPWRCOEFFE (7:0)								Transmitter Predistortion Coefficient E
PLL Parameters													
180	PLLVCOI	RW	R	0-010010	VCOIE	-	VCOI (5:0)					VCO Current	
181	PLLVCOIR	RW	R	-----	-	-	VCOIR (5:0)					VCO Current Readback	
182	PLLLOCKDET	RW	R	----011	LOCKDETDLYR (1:0)		-	-	-	LOCK DET DLYM	LOCKDETDLY (1:0)	PLL Lock Detect Delay	
183	PLLRNGCLK	RW	R	----011	-	-	-	-	-	PLLRNGCLK (2:0)		PLL Ranging Clock	
Crystal Oscillator													
184	XTALCAP	RW	R	00000000	XTALCAP (7:0)								Crystal Oscillator Load Capacitance Configuration
Baseband													
188	BBTUNE	RW	R	---01001	-	-	-	BB TUNE RUN	BBTUNE (3:0)			Baseband Tuning	
189	BBOFFSCAP	RW	R	-111-111	-	CAP INT B (2:0)			-	CAP INT A (2:0)			Baseband Offset Compensation Capacitors
MAC Layer Parameters													
Packet Format													
200	PKTADDRCFG	RW	R	001-0000	MSB FIRST	CRC SKIP FIRST	FEC SYNC DIS	-	ADDR POS (3:0)			Packet Address Config	
201	PKTLENCFG	RW	R	00000000	LEN BITS (3:0)				LEN POS (3:0)			Packet Length Config	
202	PKTLENOFFSET	RW	R	00000000	LEN OFFSET (7:0)								Packet Length Offset
203	PKTMAXLEN	RW	R	00000000	MAX LEN (7:0)								Packet Maximum Length
204	PKTADDR3	RW	R	00000000	ADDR (31:24)								Packet Address 3
205	PKTADDR2	RW	R	00000000	ADDR (23:16)								Packet Address 2
206	PKTADDR1	RW	R	00000000	ADDR (15:8)								Packet Address 1
207	PKTADDR0	RW	R	00000000	ADDR (7:0)								Packet Address 0

AND9347/D

Table 22. CONTROL REGISTER MAP(continued)

Addr	Name	Dir	R	Reset	Bit								Description
					7	6	5	4	3	2	1	0	
Packet Format													
208	PKTADDRMASK3	RW	R	00000000	ADDRMASK (31:24)								Packet Address Mask 3
209	PKTADDRMASK2	RW	R	00000000	ADDRMASK (23:16)								Packet Address Mask 2
20A	PKTADDRMASK1	RW	R	00000000	ADDRMASK (15:8)								Packet Address Mask 1
20B	PKTADDRMASK0	RW	R	00000000	ADDRMASK (7:0)								Packet Address Mask 0
Pattern Match													
210	MATCH0PAT3	RW	R	00000000	MATCH0PAT (31:24)								Pattern Match Unit 0, Pattern
211	MATCH0PAT2	RW	R	00000000	MATCH0PAT (23:16)								Pattern Match Unit 0, Pattern
212	MATCH0PAT1	RW	R	00000000	MATCH0PAT (15:8)								Pattern Match Unit 0, Pattern
213	MATCH0PAT0	RW	R	00000000	MATCH0PAT (7:0)								Pattern Match Unit 0, Pattern
214	MATCH0LEN	RW	R	0---00000	MATCH0 RAW	-	-	-	MATCH0LEN (4:0)			Pattern Match Unit 0, Pattern Length	
215	MATCH0MIN	RW	R	---00000	-	-	-	MATCH0MIN (4:0)			Pattern Match Unit 0, Minimum Match		
216	MATCH0MAX	RW	R	----11111	-	-	-	MATCH0MAX (4:0)			Pattern Match Unit 0, Maximum Match		
218	MATCH1PAT1	RW	R	00000000	MATCH1PAT (15:8)								Pattern Match Unit 1, Pattern
219	MATCH1PAT0	RW	R	00000000	MATCH1PAT (7:0)								Pattern Match Unit 1, Pattern
21C	MATCH1LEN	RW	R	0---0000	MATCH1 RAW	-	-	-	MATCH1LEN (3:0)			Pattern Match Unit 1, Pattern Length	
21D	MATCH1MIN	RW	R	----0000	-	-	-	MATCH1MIN (3:0)			Pattern Match Unit 1, Minimum Match		
21E	MATCH1MAX	RW	R	----1111	-	-	-	MATCH1MAX (3:0)			Pattern Match Unit 1, Maximum Match		
Packet Controller													
220	TMGTXBBOOST	RW	R	00110010	TMGTXBBOOSTE (2:0)				TMGTXBBOOSTM (4:0)				Transmit PLL Boost Time
221	TMGTXSETTLE	RW	R	00001010	TMGTXSETTLEE (2:0)				TMGTXSETTLEM (4:0)				Transmit PLL (post Boost) Settling Time
223	TMGRXBBOOST	RW	R	00110010	TMGRXBBOOSTE (2:0)				TMGRXBBOOSTM (4:0)				Receive PLL Boost Time
224	TMGRXSETTLE	RW	R	00010100	TMGRXSETTLEE (2:0)				TMGRXSETTLEM (4:0)				Receive PLL (post Boost) Settling Time
225	TMGRXOFFSACQ	RW	R	01110011	TMGRXOFFSACQE (2:0)				TMGRXOFFSACQM (4:0)				Receive Baseband DC Offset Acquisition Time

AND9347/D

Table 22. CONTROL REGISTER MAP(continued)

Addr	Name	Dir	R	Reset	Bit								Description
					7	6	5	4	3	2	1	0	

Packet Controller

226	TMGRXCOARSEAGC	RW	R	00111001	TMGRXCOARSEAGCE (2:0)				TMGRXCOARSEAGCM (4:0)				Receive Coarse AGC Time
227	TMGRXAGC	RW	R	00000000	TMGRXAGCE (2:0)				TMGRXAGCM (4:0)				Receiver AGC Settling Time
228	TMGRXRSSI	RW	R	00000000	TMGRXRSSIE (2:0)				TMGRXRSSIM (4:0)				Receiver RSSI Settling Time
229	TMGRXPREAMBLE1	RW	R	00000000	TMGRXPREAMBLE1E (2:0)				TMGRXPREAMBLE1M (4:0)				Receiver Preamble 1 Timeout
22A	TMGRXPREAMBLE2	RW	R	00000000	TMGRXPREAMBLE2E (2:0)				TMGRXPREAMBLE2M (4:0)				Receiver Preamble 2 Timeout
22B	TMGRXPREAMBLE3	RW	R	00000000	TMGRXPREAMBLE3E (2:0)				TMGRXPREAMBLE3M (4:0)				Receiver Preamble 3 Timeout
22C	RSSIREFERENCE	RW	R	00000000	RSSIREFERENCE (7:0)								RSSI Offset
22D	RSSIABSTHR	RW	R	00000000	RSSIABSTHR (7:0)								RSSI Absolute Threshold
22E	BGNDRSSIGAIN	RW	R	----0000	-	-	-	-	BGNDRSSIGAIN (3:0)				Background RSSI Averaging Time Constant
22F	BGNDRSSITHR	RW	R	--000000	-	-	BGNDRSSITHR (5:0)					Background RSSI Relative Threshold	
230	PKTCHUNKSIZE	RW	R	----0000	-	-	-	-	PKTCHUNKSIZE (3:0)				Packet Chunk Size
231	PKTMISCFLAGS	RW	R	---00000	-	-	-	WOR MULTI PKT	AGC SETTLE DET	BGND RSSI	RXAGC CLK	RXRSSI CLK	Packet Controller Miscellaneous Flags
232	PKTSTOREFLAGS	RW	R	-0000000	-	ST ANT RSSI	ST CRCB	ST RSSI	ST DR	ST RFOFFS	ST FOFFS	ST TIMER	Packet Controller Store Flags
233	PKTACCEPTFLAGS	RW	R	--000000	-	-	ACCPY LRGP	ACCPY SZF	ACCPY ADDR	ACCPY CRCF	ACCPY ABRT	ACCPY RESIDUE	Packet Controller Accept Flags

Special Functions

General Purpose ADC

300	GPADCCTRL	RW	R	--000000	BUSY	-	0	0	0	GPADC13	CONT	CH ISOL	General Purpose ADC Control
301	GPADCPERIOD	RW	R	00111111	GPADCPERIOD (7:0)								GPADC Sampling Period
308	GPADC13VALUE1	R		-----	-	-	-	-	-	GPADC13VALUE (9:8)			GPADC13 Value
309	GPADC13VALUE0	R		-----	GPADC13VALUE (7:0)								GPADC13 Value

Low Power Oscillator Calibration

310	LPOSCCONFIG	RW	R	00000000	LPOSC OSC INVERT	LPOSC OSC DOUBLE	LPOSC CALIBR	LPOSC CALIBF	LPOSC IRQR	LPOSC IRQF	LPOSC FAST	LPOSC ENA	Low Power Oscillator Configuration
311	LPOSCSTATUS	R	R	-----	-	-	-	-	-	-	LPOSC IRQ	LPOSC EDGE	Low Power Oscillator Status
312	LPOSCFILT1	RW	R	00100000	LPOSCFILT1 (15:8)								Low Power Oscillator Calibration Filter Constant

Table 22. CONTROL REGISTER MAP(continued)

Addr	Name	Dir	R	Reset	Bit								Description
					7	6	5	4	3	2	1	0	
Low Power Oscillator Calibration													
313	LPOSCKFLT0	RW	R	11000100	LPOSCKFLT (7:0)								Low Power Oscillator Calibration Filter Constant
314	LPOSCREF1	RW	R	01100001	LPOSCREF (15:8)								Low Power Oscillator Calibration Reference
315	LPOSCREF0	RW	R	10101000	LPOSCREF (7:0)								Low Power Oscillator Calibration Reference
316	LPOSCFREQ1	RW	R	00000000	LPOSCFREQ (9:2)								Low Power Oscillator Calibration Frequency
317	LPOSCFREQ0	RW	R	0000----	LPOSCFREQ (1:-2)			-	-	-	-	Low Power Oscillator Calibration Frequency	
318	LPOSCPER1	RW		-----	LPOSCPER (15:8)								Low Power Oscillator Calibration Period
319	LPOSCPER0	RW		-----	LPOSCPER (7:0)								Low Power Oscillator Calibration Period
DAC													
330	DACVALUE1	RW	R	----0000	-	-	-	-	DACVALUE (11:8)			DAC Value	
331	DACVALUE0	RW	R	00000000	DACVALUE (7:0)								DAC Value
332	DACCONFIG	RW	R	00--0000	DAC PWM	DAC CLK X2	-	-	DACINPUT (3:0)			DAC Configuration	
Performance Tuning Registers													
F00-FFF	PERFTUNE	RW		-----									Performance Tuning Registers

REGISTER DETAILS

Revision and Interface Probing

REVISION

Table 23. REVISION

Name	Bits	R/W	Reset	Description
REVISION	7:0	R	01010001	Silicon Revision

SCRATCH

Table 24. SCRATCH

Name	Bits	R/W	Reset	Description
SCRATCH	7:0	R	11000101	Scratch Register

The SCRATCH register does not affect the function of the chip in any way. It is intended for the Microcontroller to test communication to the AX5043.

Operating Mode

PWRMODE

Table 25. PWRMODE

Name	Bits	R/W	Reset	Description
PWRMODE	3:0	RW	0000	See Table 26: PWRMODE Bit Value
WDS	4	R	–	Wakeup from Deep Sleep
REFEN	5	RW	1	Reference Enable; set to 1 to power the internal reference circuitry
XOEN	6	RW	1	Crystal Oscillator Enable
RST	7	RW	0	Reset; setting this bit to 1 resets the whole chip. This bit does not auto-reset – the chip remains in reset state until this bit is cleared.

Table 26. PWRMODE BIT VALUES

Bits	Meaning
0000	Powerdown; all circuits powered down
0001	Deep Sleep Mode; Chip is fully powered down until SEL is lowered again; loses all register contents
0101	Crystal Oscillator enabled
0111	FIFO enabled
1000	Synthesizer running, Receive Mode
1001	Receiver Running
1011	Receiver Wake-on-Radio Mode
1100	Synthesizer running, Transmit Mode
1101	Transmitter Running

Power Management

POWSTAT

Table 27. POWSTAT

Name	Bits	R/W	Reset	Description
SVIO	0	R	–	IO Voltage Large Enough (not Brownout)
SBEVMODEM	1	R	–	Modem Domain Voltage Brownout Error (Inverted; 0 = Brownout, 1 = Power OK)
SBEVANA	2	R	–	Analog Domain Voltage Brownout Error (Inverted; 0 = Brownout, 1 = Power OK)
SVMODEM	3	R	–	Modem Domain Voltage Regulator Ready
SVANA	4	R	–	Analog Domain Voltage Regulator Ready
SVREF	5	R	–	Reference Voltage Regulator Ready
SREF	6	R	–	Reference Ready
SSUM	7	R	–	Summary Ready Status (one when all unmasked POWIRQMASK power sources are ready)

POWSTICKYSTAT

Table 28. POWSTICKYSTAT

Name	Bits	R/W	Reset	Description
SSUM	7	R	–	Summary Ready Status (one when all unmasked POWIRQMASK power sources are ready)
SSVIO	0	R	–	Sticky IO Voltage Large Enough (not Brownout)
SSBEVMODEM	1	R	–	Sticky Modem Domain Voltage Brownout Error (Inverted; 0 = Brownout detected, 1 = Power OK)
SSBEVANA	2	R	–	Sticky Analog Domain Voltage Brownout Error (Inverted; 0 = Brownout detected, 1 = Power OK)
SSVMODEM	3	R	–	Sticky Modem Domain Voltage Regulator Ready
SSVANA	4	R	–	Sticky Analog Domain Voltage Regulator Ready
SSVREF	5	R	–	Sticky Reference Voltage Regulator Ready
SSREF	6	R	–	Sticky Reference Ready
SSSUM	7	R	–	Sticky Summary Ready Status (zero when any unmasked POWIRQMASK power sources is not ready)

POWIRQMASK

Table 29. POWIRQMASK

Name	Bits	R/W	Reset	Description
MSVIO	0	RW	0	IO Voltage Large Enough (not Brownout) Interrupt Mask
MSBEVMODEM	1	RW	0	Modem Domain Voltage Brownout Error Interrupt Mask
MSBEVANA	2	RW	0	Analog Domain Voltage Brownout Error Interrupt Mask
MSVMODEM	3	RW	0	Modem Domain Voltage Regulator Ready Interrupt Mask
MSVANA	4	RW	0	Analog Domain Voltage Regulator Ready Interrupt Mask
MSVREF	5	RW	0	Reference Voltage Regulator Ready Interrupt Mask
MSREF	6	RW	0	Reference Ready Interrupt Mask
MPWRGOOD	7	RW	0	If 0, interrupt whenever one of the unmasked power sources fail (clear interrupt by reading POWSTICKYSTAT); if 1, interrupt when all unmasked power sources are good

Interrupt Control

IRQMASK1, IRQMASK0

Table 30. IRQMASK1, IRQMASK0

Name	Bits	R/W	Reset	Description
IRQMFIFONOTEMPTY	0	RW	0	FIFO not empty interrupt enable
IRQMFIFONOTFULL	1	RW	0	FIFO not full interrupt enable
IRQMFIFOTHRCNT	2	RW	0	FIFO count > threshold interrupt enable
IRQMFIFOTHRFREE	3	RW	0	FIFO free > threshold interrupt enable
IRQMFIFOERROR	4	RW	0	FIFO error interrupt enable
IRQMPLLUNLOCK	5	RW	0	PLL lock lost interrupt enable
IRQMRADIOCTRL	6	RW	0	Radio Controller interrupt enable
IRQMPOWER	7	RW	0	Power interrupt enable
IRQMXTALREADY	8	RW	0	Crystal Oscillator Ready interrupt enable
IRQMWAKEUPTIMER	9	RW	0	Wakeup Timer interrupt enable
IRQMLPOSC	10	RW	0	Low Power Oscillator interrupt enable
IRQMGPADC	11	RW	0	GPADC interrupt enable
IRQMPLLRNGDONE	12	RW	0	PLL autoranging done interrupt enable

Zero disables the corresponding interrupt, while one enables it.

RADIOEVENTMASK1, RADIOEVENTMASK0

Table 31. RADIOEVENTMASK1, RADIOEVENTMASK0

Name	Bits	R/W	Reset	Description
REVMDONE	0	RW	0	Transmit or Receive Done Radio Event Enable
REVMSETTLED	1	RW	0	PLL Settled Radio Event Enable
REVMRADIOSTATECHG	2	RW	0	Radio State Changed Event Enable
REVMRXPARAMSETCHG	3	RW	0	Receiver Parameter Set Changed Event Enable
REVMFRAMECLK	4	RW	0	Frame Clock Event Enable

IRQINVERSION1, IRQINVERSION0

Table 32. IRQINVERSION1, IRQINVERSION0

Name	Bits	R/W	Reset	Description
IRQINVFIFONOTEMPTY	0	RW	0	FIFO not empty interrupt inversion
IRQINVFIFONOTFULL	1	RW	0	FIFO not full interrupt inversion
IRQINVFIFOTHRCNT	2	RW	0	FIFO count > threshold interrupt inversion
IRQINVFIFOTHRFREE	3	RW	0	FIFO free > threshold interrupt inversion
IRQINVFIFOERROR	4	RW	0	FIFO error interrupt inversion
IRQINVPLLUNLOCK	5	RW	0	PLL lock lost interrupt inversion
IRQINVRADIOCTRL	6	RW	0	Radio Controller interrupt inversion
IRQINVPOWER	7	RW	0	Power interrupt inversion
IRQINVXTALREADY	8	RW	0	Crystal Oscillator Ready interrupt inversion
IRQINWAKEUPTIMER	9	RW	0	Wakeup Timer interrupt inversion
IRQINVLPOSC	10	RW	0	Low Power Oscillator interrupt inversion
IRQINVGADC	11	RW	0	GPADC interrupt inversion
IRQINVPLLRNGDONE	12	RW	0	PLL autoranging done interrupt inversion

IRQREQUEST1, IRQREQUEST0

Table 33. IRQREQUEST1, IRQREQUEST0

Name	Bits	R/W	Reset	Description
IRQRQFIFONOTEMPTY	0	R	–	FIFO not empty interrupt pending
IRQRQFIFONOTFULL	1	R	–	FIFO not full interrupt pending
IRQRQFIFOTHRCNT	2	R	–	FIFO count > threshold interrupt pending
IRQRQFIFOTHRFREE	3	R	–	FIFO free > threshold interrupt pending
IRQRQFIFOERROR	4	R	–	FIFO error interrupt pending
IRQRQPLLUNLOCK	5	R	–	PLL lock lost interrupt pending
IRQRADIOCTRL	6	R	–	Radio Controller interrupt pending
IRQRPOWER	7	R	–	Power interrupt pending
IRQRXTALREADY	8	R	–	Crystal Oscillator Ready interrupt pending
IRQRWAKEUPTIMER	9	R	–	Wakeup Timer interrupt pending
IRQRLPOSC	10	R	–	Low Power Oscillator interrupt pending
IRQRGPADC	11	R	–	GPADC interrupt pending
IRQRQPLLNRNGDONE	12	R	–	PLL autoranging done interrupt pending

RADIOEVENTREQ1, RADIOEVENTREQ0

Table 34. RADIOEVENTREQ1, RADIOEVENTREQ0

Name	Bits	R/W	Reset	Description
REVRDONE	0	RC	–	Transmit or Receive Done Radio Event Pending
REVRSETTLED	1	RC	–	PLL Settled Radio Event Pending
REVRRADIOSTATECHG	2	RC	–	Radio State Changed Event Pending
REVRRXPARAMSETCHG	3	RC	–	Receiver Parameter Set Changed Event Pending
REVRFRAMECLK	4	RC	–	Frame Clock Event Pending

The bits in this register are cleared upon reading this register.

Modulation and Framing

MODULATION

Table 35. MODULATION

Name	Bits	R/W	Reset	Description
REVRDONE	0	RC	–	Transmit or Receive Done Radio Event Pending
MODULATION	3:0	RW	1000	See table 36: Modulation Bit Values
RX HALFSPEED	4	RW	0	If set, halves the receive bitrate

Table 36. MODULATION BIT VALUES

Bits	Inputs
0000	ASK
0001	ASK Coherent
0100	PSK
0110	OQSK
0111	MSK
1000	FSK
1001	4-FSK
1010	AFSK
1011	FM

Transmitter amplitude shaping is set using the MODCFG register, and frequency shaping is set using the MODCFGF register.

ENCODING

Table 37. ENCODING

Name	Bits	R/W	Reset	Description
ENC INV	0	RW	0	Invert data if set to 1
ENC DIFF	1	RW	1	Differential Encode/Decode data if set to 1
ENC SCRAM	2	RW	0	Enable Scrambler/Descrambler if set to 1
ENC MANCH	3	RW	0	Enable manchester encoding/decoding. FM0/FM1 may be achieved by also appropriately setting ENC DIFF and ENC INV
ENC NOSYNC	4	RW	0	Disable Dibit synchronisation in 4-FSK mode

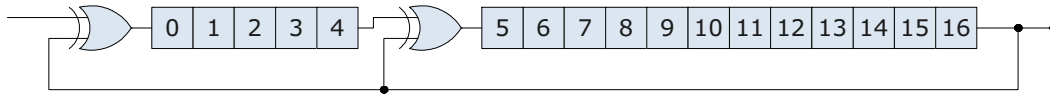

Figure 17. Scrambler Schematic Diagram

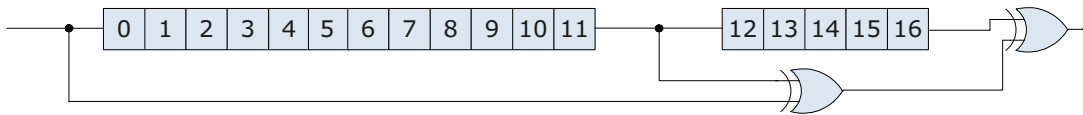

Figure 18. Descrambler Schematic Diagram

The intention of the scrambler is the removal of tones contained in the transmit data, i.e. to randomize the transmit spectrum. The scrambler polynomial is $1 + X^{12} + X^{17}$, it is therefore compatible to the K9NG/G3RUH Satellite Modems.

Figure 17 and Figure 18 show schematic diagrams of the scrambler and the descrambler operation. The numbered boxes represent delays by one bit.

ENC NOSYNC should normally be set to zero, unless the chip is either in the RXFRAMING or TXFRAMING mode and PWRUP is not used as a synchronisation signal.

Figure 19 shows a few well known encoding formats used in telecom.

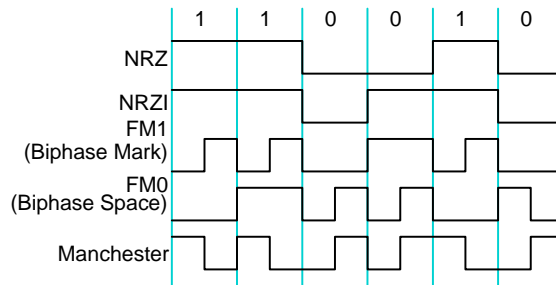

Figure 19. Customary Encodings

Table 38. CUSTOMARY ENCODING MODES DESCRIPTION

Name	Bits	Description
NRZ	INV = 0, DIFF = 0, SCRAM = 0, MANCH = 0	NRZ represents 1 as a high signal level, 0 as a low signal level. NRZ performs no change.
NRZI	INV = 1, DIFF = 1, SCRAM = 0, MANCH = 0	NRZI represents 1 as no change in the signal level, and 0 as a change in the signal level. NRZI is recommended for HDLC [1]. The HDLC bit stuffing ensures that there are periodic zeros and thus transitions, and the encoding is inversion invariant.

Table 38. CUSTOMARY ENCODING MODES DESCRIPTION(continued)

Name	Bits	Description
FM1	INV = 1, DIFF = 1, SCRAM = 0, MANCH = 1	FM1 (Biphase Mark) always ensures transitions at bit edges. It encodes 1 as a transition at the bit center, and 0 as no transition at the bit center.
FM0	INV = 0, DIFF = 1, SCRAM = 0, MANCH = 1	FM0 (Biphase Space) always ensures transitions at bit edges. It encodes 1 as no transition at the bit center, and 0 as a transition at the bit center.
Manchester	INV = 0, DIFF = 0, SCRAM = 0, MANCH = 1	Manchester encodes 1 as a 10 pattern, and 0 as a 01 pattern. Manchester is not inversion invariant.

Guidelines:

- Manchester, FM0, and FM1 are not recommended for new systems, as they double the bitrate.
- In HDLC [1] mode, use NRZI, NRZI + Scrambler, or NRZ + Scrambler.
- In Raw modes, the choice depends on the legacy system to be implemented.

FRAMING

Table 39. FRAMING

Name	Bits	R/W	Reset	Description
FABORT	0	S	0	Write 1 to abort current HDLC [1] packet / pattern match
FRMMODE	3:1	RW	000	See Table 40: FRMMODE Bit Values
CRCMODE	6:4	RW	000	See Table 41: CRCMODE Bit Values
FRMRX	7	R	–	Packet start detected, receiver running; this bit is set when a flag is detected in HDLC [1] mode or when the preamble matches in Raw Pattern Match mode. Cleared by writing 1 to FABORT.

Table 40. FRMMODE BIT VALUES

Bits	Meaning
000	Raw
001	Raw, Soft Bits
010	HDLC [1]
011	Raw, Pattern Match
100	Wireless M-Bus
101	Wireless M-Bus, 4-to-6 Encoding

NOTE: The wireless M-Bus definition of “Manchester” is inverse to the definition used by the AX5043. AX5043 defines “Manchester” as the transmission of the data bit followed by the transmission of the inverted data bit. Wireless M-Bus defines it the other way around. In order to avoid having to enable inversion in the ENCODING register, the AX5043 inverts normal data bits when FRMMODE is set to Wireless M-Bus.

Table 41. CRCMODE BIT VALUES

Bits	Meaning
000	Off
001	CCITT (16 bit)
010	CRC–16
011	DNP (16 bit)
110	CRC–32

NOTE: If FRMMODE is set to Raw, Soft Bits, register F72 must be set to 0x06. Otherwise, it should be left or set to 0x00.

CRCINIT3, CRCINIT2, CRCINIT1, CRCINIT0

Table 42. CRCINIT3, CRCINIT2, CRCINIT1, CRCINIT0

Name	Bits	R/W	Reset	Description
CRCINIT	31:0	RW	0xFFFFFFFF	CRC Reset Value; normally all ones

Forward Error Correction

FEC

Table 43. FEC

Name	Bits	R/W	Reset	Description
FECENA	0	RW	0	Enable FEC (Convolutional Encoder)
FECINPSHIFT	3:1	RW	000	Attenuate soft Rx Data by $2^{-\text{FECINPSHIFT}}$
FECPOS	4	RW	0	Enable noninverted Interleaver Synchronisation
FECNEG	5	RW	0	Enable inverted Interleaver Synchronisation
RSTVITERBI	6	RW	0	Reset Viterbi Decoder
SHORTMEM	7	RW	0	Shorten Backtrack Memory

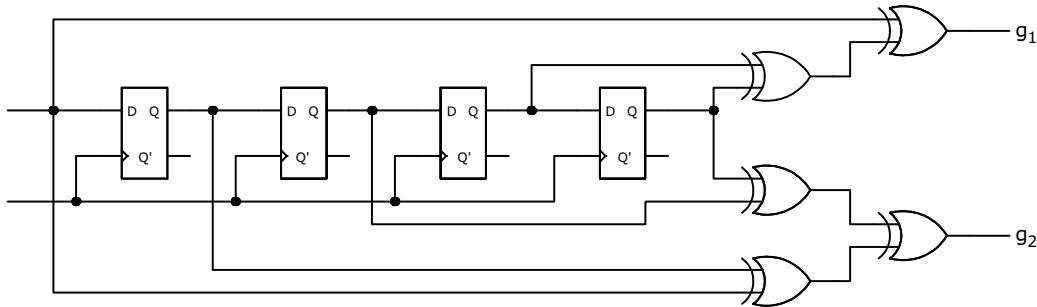

Figure 20. Schematic Diagram of the Convolutional Encoder

FECENA enables the Forward Error Correction and the Interleaver.

The Interleaver is a 4 x 4 matrix interleaver, i.e. transmit bits are filled in row-wise and read out column-wise.

The Convolutional Code is a nonsystematic Rate 1/2 code with the generators $g_1 = 1 + D^3 + D^4$ and $g_2 = 1 + D + D^2 + D^4$. It has a minimum free distance of $d_{\text{free}} = 7$. Figure 20 shows a schematic diagram of the convolutional encoder.

In the Transmitter, HDLC [1] flags are aligned (by inserting zero bits) to the interleaver. In the Receiver, a convolver to the encoded/interleaved flag sequence establishes deinterleaver synchronisation and inversion detection. That means, that FEC only works with HDLC framing.

The Viterbi decoder uses soft metric.

FECSYNC

Table 44. FECSYNC

Name	Bits	R/W	Reset	Description
FECSYNC	7:0	RW	01100010	Interleaver Synchronisation Threshold

FECSTATUS

Table 45. FECSTATUS

Name	Bits	R/W	Reset	Description
MAXMETRIC	6:0	R	-	Metric increment of the survivor path
FEC INV	7	R	-	Inverted Synchronisation Sequence received

Status

RADIOSTATE

Table 46. RADIOSTATE

Name	Bits	R/W	Reset	Description
RADIO STATE	3:0	R	0000	See Table 47: Radio Controller State Bit Values

Table 47. RADIOSTATE BIT VALUES

Bits	Meaning
0000	Idle
0001	Powerdown
0100	Tx PLL Settings
0110	Tx
0111	Tx Tail
1000	Rx PLL Settings
1001	Rx Antenna Selection
1100	Rx Preamble 1
1101	Rx Preamble 2
1110	Rx Preamble 3
1111	Rx

XTALSTATUS

Table 48. XTALSTATUS

Name	Bits	R/W	Reset	Description
XTAL RUN	0	R	–	1 indicates crystal oscillator running and stable

Pin Configuration

PINSTATE

Table 49. PINSTATE

Name	Bits	R/W	Reset	Description
PSSYSCLK	0	R	–	Signal Level on Pin SYSCLK
PSDCLK	1	R	–	Signal Level on Pin DCLK
PSDATA	2	R	–	Signal Level on Pin DATA
PSIRQ	3	R	–	Signal Level on Pin IRQ
PSANTSEL	4	R	–	Signal Level on Pin ANTSEL
PSPWRAMP	5	R	–	Signal Level on Pin PWRAMP

PINFUNCSYSCLK

Table 50. PINFUNCSYSCLK

Name	Bits	R/W	Reset	Description
PFSYSCLK	4:0	RW	01000	See Table 51: PFSYSCLK Bit Values
PUSYSCLK	7	RW	0	SYSCLK weak Pullup enable

Table 51. PFSYSCLK BIT VALUES

Bits	Meaning
0000	Idle
00000	SYSCLK Output '0'
00001	SYSCLK Output '1'

Table 51. PFSYSCLK BIT VALUES (continued)

00010	SYSClk Output 'Z'
00011	SYSClk Output inverted f_{XTAL}
00100	SYSClk Output f_{XTAL}
00101	SYSClk Output $\frac{f_{XTAL}}{2}$
00110	SYSClk Output $\frac{f_{XTAL}}{4}$
00111	SYSClk Output $\frac{f_{XTAL}}{8}$
01000	SYSClk Output $\frac{f_{XTAL}}{16}$
01001	SYSClk Output $\frac{f_{XTAL}}{32}$
01010	SYSClk Output $\frac{f_{XTAL}}{64}$
01011	SYSClk Output $\frac{f_{XTAL}}{128}$
01100	SYSClk Output $\frac{f_{XTAL}}{256}$
01101	SYSClk Output $\frac{f_{XTAL}}{512}$
01110	SYSClk Output $\frac{f_{XTAL}}{1024}$
01111	SYSClk Output Low Power (LP) Oscillator
11111	SYSClk Output Test Observation

*PINFUNCCLK***Table 52. PINFUNCCLK**

Name	Bits	R/W	Reset	Description
PFCLK	2:0	RW	100	See Table 53: PFCLK Bit Values
PIDCLK	6	RW	0	DCLK inversion
PUDCLK	7	RW	0	DCLK weak Pullup enable

Table 53. PFCLK BIT VALUES

Bits	Meaning
000	DCLK Output '0'
001	DCLK Output '1'
010	DCLK Output 'Z'
011	DCLK Output Modem Data Clock Input; use when inputting/outputting framing data on DATA
100	DCLK Output Modem Data Clock Output; use when observing modem data on DATA
101	DCLK Output Modem Data Clock Output; use when inputting/outputting framing data on DATA, and you do not want to generate a clock yourself
110	invalid
111	DCLK Output Test Observation

*PINFUNC*DATA

Table 54. PINFUNCDATA

Name	Bits	R/W	Reset	Description
PFDATA	3:0	RW	0111	See Table 55: PFDCLK Bit Values
PIDATA	6	RW	0	DATA inversion
PUDATA	7	RW	1	DATA weak Pullup enable

Table 55. PFDATA BIT VALUES

Bits	Meaning
0000	DATA Output '0'
0001	DATA Output '1'
0010	DATA Output 'Z'
0011	DATA Input/Output Framing Data
0100	DATA Input/Output Modem Data
0101	DATA Input/Output Async Modem Data
0110	Invalid
0111	DATA Output Modem Data
1111	DATA Output Test Observation

In Asynchronous Wire Mode, the maximum bitrate is limited to .

*PINFUNC*IRQ

Table 56. PINFUNCIRQ

Name	Bits	R/W	Reset	Description
PFIRQ	2:0	RW	011	See Table 57: PFIRQ Bit Values
PIIRQ	6	RW	0	IRQ inversion
PUIRQ	7	RW	0	IRQ weak Pullup enable

Table 57. PFIRQ BIT VALUES

Bits	Meaning
000	IRQ Output '0'
001	IRQ Output '1'
010	IRQ Output 'Z'
011	IRQ Output Interrupt Request
111	IRQ Output Test Observation

*PINFUNC*ANTSEL

Table 58. PINFUNCANTSEL

Name	Bits	R/W	Reset	Description
PFANTSEL	2:0	RW	110	See Table 59: PFANTSEL Bit Values
PIANTSEL	6	RW	0	ANTSEL inversion
PUANTSEL	7	RW	0	ANTSEL weak Pullup enable

Table 59. PFANTSEL BIT VALUES

Bits	Meaning
000	ANTSEL Output '0'

Table 59. PFANTSEL BIT VALUES (continued)

001	ANTSEL Output '1'
010	ANTSEL Output 'Z'
011	ANTSEL Output Baseband Tune Clock
100	ANTSEL Output External TCXO Enable
101	ANTSEL Output DAC
110	ANTSEL Output Diversity Antenna Select
111	ANTSEL Output Test Observation

PINFUNCPWRAMP

Table 60. PINFUNCPWRAMP

Name	Bits	R/W	Reset	Description
PFWRAMP	3:0	RW	0110	See Table 61: PFWAMP Bit Values
PIPWRAMP	6	RW	0	PWRAMP inversion
PUPWRAMP	7	RW	0	PWRAMP weak Pullup enable

Table 61. PFWAMP BIT VALUES

Bits	Meaning
0000	PWRAMP Output '0'
0001	PWRAMP Output '1'
0010	PWRAMP Output 'Z'
0011	PWRAMP Input DiBit Synchronisation (4-FSK); use when inputting/outputting 4-FSK framing data on DATA
0100	PWRAMP Output DiBit Synchronisation (4-FSK); use when observing 4-FSK modem data on DATA
0101	PWRAMP Output DAC
0110	PWRAMP Output Power Amplifier Control
0111	PWRAMP Output External TCXO Enable
1111	PWRAMP Output Test Observation

PWRAMP

Table 62. PWRAMP

Name	Bits	R/W	Reset	Description
PWRAMP	0	RW	0	Power Amplifier Control

The PWRAMP bit may be output on the PWRAMP pin. This signal may be used to control an external power amplifier.

FIFO Registers

FIFOSTAT

Table 63. FIFOSTAT

Name	Bits	R/W	Reset	Description
FIFO EMPTY	0	R	1	FIFO is empty if 1. This bit is dangerous to use when PWRMODE is set to Receiver Wake-on-Radio mode. In this mode, the FIFO and thus the FIFOSTAT register is only powered up while the FIFO is not empty, and powered down immediately when the FIFO becomes empty. When powered down, reading FIFOSTAT returns zero, indicating a non-empty FIFO while in reality the FIFO is empty. In Wake-on-Radio mode, it is recommended to use the IRQRQFIFONOTEMPTY bit of Register IRQREQUEST0. This bit will work in all cases, even when the interrupt is masked.
FIFO FULL	1	R	0	FIFO is full if 1
FIFO UNDER	2	R	0	FIFO underrun occurred since last read of FIFOSTAT when 1
FIFO OVER	3	R	0	FIFO overrun occurred since last read of FIFOSTAT when 1
FIFO CNT THR	4	R	0	1 if the FIFO count is > FIFOTHRESH
FIFO FREE THR	5	R	0	1 if the FIFO free space is > FIFOTHRESH
FIFOCMD	5:0	W	–	See Table 64: FIFOCMD Bit Values
FIFO AUTO COMMIT	7	RW	0	If one, FIFO write bytes are automatically committed on every write

Table 64. FIFOCMD BIT VALUES

Bits	Meaning
000000	No Operation
000001	ASK Coherent
000010	Clear FIFO Error (OVER and UNDER) Flags
000011	Clear FIFO Data and Flags
000100	Commit
000101	Rollback
000110	Invalid
000111	Invalid
001XXX	Invalid
01XXXX	Invalid
1XXXXX	Invalid

FIFODATA

Table 65. FIFODATA

Name	Bits	R/W	Reset	Description
FIFODATA	7:0	RW	–	FIFO access register

Note that when accessing this register, the SPI address pointer is not incremented, allowing for efficient burst accesses.

FIFOCOUNT1, FIFOCOUNT0

Table 66. FIFOCOUNT1, FIFOCOUNT0

Name	Bits	R/W	Reset	Description
FIFOCOUNT	8:0	R	–	Current number of committed FIFO Words

FIFOFREE1, FIFOFREE0

Table 67. FIFOFREE1, FIFOFREE0

Name	Bits	R/W	Reset	Description
FIFOFREE	8:0	R	–	Current number of empty FIFO Words

FIFOTHRESH1, FIFOTHRESH0

Table 68. FIFOTHRESH1, FIFOTHRESH0

Name	Bits	R/W	Reset	Description
FIFOFRESH	8:0	R	00000000	FIFO Threshold

Synthesizer

PLLLOOP, PLLLOOPBOOST

The PLLLOOP and PLLLOOPBOOST select PLL Loop Filter configuration for both normal mode and boosted

mode. All fields in this register are separate, except for FREQSEL, which is common to both registers.

Table 69. PLLLOOP, PLLLOOPBOOST

Name	Bits	R/W	Reset	Description
FLT	1:0	RW	01	See Table 70: FLT and FLTBOOST Bit Values
FLTBOOST			11	
FILTEN	2	RW	0	Enable External Filter Pin
FILTENBOOST			0	
DIRECT	3	RW	1	Bypass External Filter Pin
DIRECTBOOST			1	
FREQSEL	7	RW	0	Frequency Register Selection; 0 = use FREQA, 1 = use FREQB

Table 70. FLT AND FLTBOOST BIT VALUES

Bits	Meaning
00	External Loop Filter
01	Internal Loop Filter, BW = 100 kHz for $I_{CP} = 68 \mu A$
10	Internal Loop Filter x2, BW = 200 kHz for $I_{CP} = 272 \text{ mA}$
11	Internal Loop Filter x5, BW = 500 kHz for $I_{CP} = 1.7 \text{ mA}$

PLLCPI, PLLCPIBOOST

Table 71. PLLCPI, PLLCPIBOOST

Name	Bits	R/W	Reset	Description
PLLCPI	7:0	RW	00001000	Charge pump current in multiples of 8.5µA
PLLCPIBOOST			11001000	

PLLVCODIV

Table 72. PLLVCODIV

Name	Bits	R/W	Reset	Description
REFDIV	1:0	RW	00	See Table 73: REFDIV Bit Value
RFDIV	2	RW	0	RF divider: 0 = no RF divider, 1 = divide RF by 2
VCOSEL	4	RW	0	0 = fully internal VCO1, 1 = internal VCO2 with external inductor or external VCO, depending on VCO2INT
VCO2INT	5	RW	0	1 = internal VCO2 with external Inductor, 0 = external VCO

Table 73. REFDIV BIT VALUES

Bits	Meaning
00	$f_{PD} = f_{XTAL}$
01	$f_{PD} = \frac{f_{XTAL}}{2}$
10	$f_{PD} = \frac{f_{XTAL}}{4}$
11	$f_{PD} = \frac{f_{XTAL}}{8}$

PLLRANGINGA, PLLRANGINGB

Table 74. PLLRANGINGA, PLLRANGINGB

Name	Bits	R/W	Reset	Description
VCORA VCORB	3:0	RW	1000 1000	VCO Range; depending on bit FREQSEL of PLLLOOP, VCORA or VCORB is used
RNG START	4	RS	0	PLL Autoranging; Write 1 to start autoranging, bit clears when autoranging done. Autoranging always applies to the VCOR selected by FREQSEL of PLLLOOP.
RNGERR	5	R	–	Ranging Error; Set when RNG START transitions from 1 to 0 and the programmed frequency cannot be achieved
PLL LOCK	6	R	–	PLL is locked if 1
STICKY LOCK	7	R	–	if 0, PLL lost lock after last read of PLLRANGINGA or PLLRANGINGB register

FREQA3, FREQA2, FREQA1, FREQA0

Table 75. FREQA3, FREQA2, FREQA1, FREQA0

Name	Bits	R/W	Reset	Description
FREQA	31:0	RW	0x3934CCCD	Frequency; $FREQA = \left[\frac{f_{CARRIER}}{f_{XTAL}} \times 2^{24} + \frac{1}{2} \right]$

It is not recommended to use an RF frequency that is an integer multiple of the reference frequency, due to stray RF desensitizing the receiver.

It is strongly recommended to always set bit 0 to avoid spectral tones.

FREQB3, FREQB2, FREQB1, FREQB0

Table 76. FREQB3, FREQB2, FREQB1, FREQB0

Name	Bits	R/W	Reset	Description
FREQB	31:0	RW	0x3934CCCD	Frequency; $FREQB = \left[\frac{f_{CARRIER}}{f_{XTAL}} \times 2^{24} + \frac{1}{2} \right]$

See notes of FREQA register.

Signal Strength

RSSI

Table 77. RSSI

Name	Bits	R/W	Reset	Description
RSSI	7:0	R	–	Received Signal Strength, in dB

BGNDRSSI

Table 78. BGNDRSSI

Name	Bits	R/W	Reset	Description
BGNDRSSI	7:0	RW	00000000	Background Noise (RSSI)

DIVERSITY

Table 79. DIVERSITY

Name	Bits	R/W	Reset	Description
DIVENA	0	RW	0	Antenna Diversity Enable
ANTSEL	1	RW	0	Antenna Select

DIVENA enables the internal antenna diversity logic.

The ANTSEL bit may be output on pin ANTSEL, and this signal may be used to control an external antenna switch.

AGCCOUNTER

Table 80. AGCCOUNTER

Name	Bits	R/W	Reset	Description
AGCCOUNTER	7:0	R	–	Current AGC Gain, in 0.75 dB steps

Receiver Tracking

TRKDATARATE2, TRKDATARATE1, TRKDATARATE0

Table 81. TRKDATARATE2, TRKDATARATE1, TRKDATARATE0

Name	Bits	R/W	Reset	Description
TRKDATARATE	23:0	R	–	Current datarate tracking value

TRKAMPL1, TRKAMPL0

Table 82. TRKAMPL1, TRKAMPL0

Name	Bits	R/W	Reset	Description
TRKAMPL	15:0	R	–	Current amplitude tracking value

TRKPHASE1, TRKPHASE0

Table 83. TRKPHASE1, TRKPHASE0

Name	Bits	R/W	Reset	Description
TRKPHASE	11:0	R	–	Current phase tracking value

TRKRFFREQ2, TRKRFFREQ1, TRKRFFREQ0

Table 84. TRKRFFREQ2, TRKRFFREQ1, TRKRFFREQ0

Name	Bits	R/W	Reset	Description
TRKRFFREQ	19:0	RW	–	Current RF frequency tracking value

This Register is reset to zero when the demodulator is not running. In order to avoid write collisions between the

demodulator and the microcontroller with undefined results, TRKFREQ should be frozen before attempting to write to.

AND9347/D

To freeze, set the RFFREQFREEZE bit in the appropriate FREQGAIN0, FREQGAIN1, FREQGAIN2, or

FREQGAIN3 register, then wait for $\frac{1}{4 \times \text{BAUDRATE}}$ for the freeze to take effect.

TRKFREQ1, TRKFREQ0

Table 85. TRKFREQ1, TRKFREQ0

Name	Bits	R/W	Reset	Description
TRKFREQ	15:0	RW	–	Current frequency tracking value

The current frequency offset estimate is

$$\Delta f = \frac{\text{TRKFREQ}}{2^{16}} \times \text{BITRATE}$$

This Register is reset to zero when the demodulator is not running. In order to avoid write collisions between the demodulator and the microcontroller with undefined results,

TRKFREQ should be frozen before attempting to write to. To freeze, set the FREQFREEZE bit in the appropriate FREQGAINB0, FREQGAINB1, FREQGAINB2, or FREQGAINB3 register, then wait for $\frac{1}{4 \times \text{BAUDRATE}}$ for the freeze to take effect.

TRKFSKDEM01, TRKFSKDEM00

Table 86. TRKFSKDEM01, TRKFSKDEM00

Name	Bits	R/W	Reset	Description
TRKFSKDEM0	13:0	R	–	Current FSK demodulator value

TRKAFSKDEM01, TRKAFSKDEM00

Table 87. TRKAFSKDEM01, TRKAFSKDEM00

Name	Bits	R/W	Reset	Description
TRKAFSKDEM0	15:0	R	–	Current AFSK demodulator value

Tracking Register Resets

Writes to TRKAMPL1, TRKAMPL0, TRKPHASE1, TRKPHASE0, TRKDATARATE2, TRKDATARATE1, TRKDATARATE0 cause the following action:

Table 88. TRACKING REGISTER RESET

Name	Bits	R/W	Reset	Description
DTRKRESET	3	W	–	Writing 1 clears the Datarate Tracking Register
ATRKRESET	4	W	–	Writing 1 clears the Amplitude Tracking Register
PTRKRESET	5	W	–	Writing 1 clears the Phase Tracking Register
RTRKRESET	6	W	–	Writing 1 clears the RF Frequency Tracking Register
FTRKRESET	7	W	–	Writing 1 clears the Frequency Tracking Register

Timer

TIMER2, TIMER1, TIMER0

The main purpose of the fast μs Timer is to enable the microcontroller to exactly determine the packet start time. A

snapshot of this timer at packet start can be written to the FIFO.

Table 89. TIMER2, TIMER1, TIMER0

Name	Bits	R/W	Reset	Description
TIMER	23:0	R	–	1 MHz ($f_{\text{XTAL}} / 16$) Counter; starts counting as soon as modem voltage regulator and Crystal Oscillator running

Wakeup Timer

The wakeup timer is a low power timer that can generate periodic events. It can generate a microcontroller interrupt (register IRQMASK1) or start the receiver in wake-on-radio mode (register PWRMODE). The interrupt can be cleared by reading or writing any wakeup timer register.

The wakeup timer is driven by the low power oscillator. At every low power oscillator clock edge, the WAKEUPTIMER register is incremented by 1. The

counting frequency can be set to 640 Hz or 10.24 kHz (register LPOSCCONFIG).

Whenever the WAKEUPTIMER register matches the WAKEUP register, an event is signalled, and the WAKEUPFREQ register is added to the WAKEUP register, to prepare for the next wakeup event.

Since crystals often take a significant amount of time to start up, the crystal oscillator may be started early using the WAKEUPXOEARLY register.

WAKEUPTIMER1, WAKEUPTIMER0

Table 90. WAKEUPTIMER1, WAKEUPTIMER0

Name	Bits	R/W	Reset	Description
WAKEUPTIMER	15:0	R	–	Wakeup Timer

WAKEUP1, WAKEUP0

Table 91. WAKEUP1, WAKEUP0

Name	Bits	R/W	Reset	Description
WAKEUP	15:0	RW	0x0000	Wakeup Time

WAKEUPFREQ1, WAKEUPFREQ0

Table 92. WAKEUPFREQ1, WAKEUPFREQ0

Name	Bits	R/W	Reset	Description
WAKEUPFREQ	15:0	RW	0x0000	Wakeup Frequency; Zero disables Wakeup

WAKEUPXOEARLY

Table 93. WAKEUPXOEARLY

Name	Bits	R/W	Reset	Description
WAKEUPXOEARLY	7:0	RW	0x00	Number of LPOSC clock cycles by which the Crystal Oscillator is woken up before the main receiver

Receiver Parameters

IFFREQ1, IFFREQ0

Table 94. IFFREQ1, IFFREQ0

Name	Bits	R/W	Reset	Description
IFFREQ	15:0	RW	0x1327	IF Frequency; $IFFREQ = \left[\frac{f_{IF} \times f_{XTALDIV}}{f_{XTAL}} \times 2^{20} + \frac{1}{2} \right]$

Please use the AX_RadioLab software to calculate the optimum IF frequency for given physical layer parameters.

DECIMATION

Table 95. DECIMATION

Name	Bits	R/W	Reset	Description
DECIMATION	6:0	RW	0001101	Filter Decimation factor; Filter Output runs at $f_{BASEBAND} = \frac{f_{XTAL}}{2^4 \times f_{XTALDIV} \times DECIMATION}$ The value 0 is illegal.

RXDATARATE2, RXDATARATE1, RXDATARATE0

Table 96. RXDATARATE2, RXDATARATE1, RXDATARATE0

Name	Bits	R/W	Reset	Description
RXDATARATE	23:0	RW	0x003D8A	$RXDATARATE = \left[\frac{2^7 \times f_{XTAL}}{f_{XTALDIV} \times BITRATE \times DECIMATION} + \frac{1}{2} \right]$

RXDATARATE - TIMEGAINx ≥ 2¹² should be ensured when programming. Otherwise, the hardware does it, but

this may cause instability due to asymmetric timing correction.

MAXDROFFSET2, MAXDROFFSET1, MAXDROFFSET0

Table 97. MAXDROFFSET2, MAXDROFFSET1, MAXDROFFSET0

Name	Bits	R/W	Reset	Description
MAXDROFFSET	23:0	RW	0x00009E	$MAXDROFFSET = \left[\frac{2^7 \times f_{XTAL} \times \Delta BITRATE}{f_{XTALDIV} \times BITRATE^2 \times DECIMATION} + \frac{1}{2} \right]$

The maximum bitrate offset the receiver is able to tolerate can be specified by the parameter ΔBITRATE. The receiver will be able to tolerate a data rate within the range BITRATE ± ΔBITRATE. The downside of increasing ΔBITRATE is that the required preamble length increases. Therefore,

ΔBITRATE should only be chosen as large as the transmitters require. If the bitrate offset is less than approximately ±1%, receiver bitrate tracking should be switched off completely by setting MAXDROFFSET to zero, to ensure minimum preamble length.

MAXRFOFFSET2, MAXRFOFFSET1, MAXRFOFFSET0

Table 98. MAXRFOFFSET2, MAXRFOFFSET1, MAXRFOFFSET0

Name	Bits	R/W	Reset	Description
MAXRFOFFSET	19:0	RW	0x01687	$MAXRFOFFSET = \left[\frac{f_{CARRIER}}{f_{XTAL}} \times 2^{24} + \frac{1}{2} \right]$
FREQOFFSCORR	23	RW	0	Correct frequency offset at the first LO if this bit is one; at the second LO if this bit is zero

This register sets the maximum frequency offset the built-in Automatic Frequency Correction (AFC) should handle. Set it to the maximum frequency offset between Transmitter and Receiver. Enlarging this register increases the time needed for the AFC to achieve lock. The AFC can only achieve lock if the transmit signal partially passes

through the receiver channel filter. This limits the practically usable range for the AFC circuit to approximately ±¹/₄ of the Filter Bandwidth. The acquisition and tracking range can be increased by increasing the Receiver Channel Filter Bandwidth, at the expense of slightly reducing the Sensitivity.

FSKDMAX1, FSKDMAX0

Table 99. FSKDMAX1, FSKDMAX0

Name	Bits	R/W	Reset	Description
FSKDEVMAX	15:0	RW	0x0080	Current FSK Demodulator Max Deviation

In manual mode, it should be set to $3 \times 512 \times \frac{f_{DEVIATION}}{BAUDRATE}$.

FSKDMIN1, FSKDMIN0

Table 100. FSKDMIN1, FSKDMIN0

Name	Bits	R/W	Reset	Description
FSKDEVMIN	15:0	RW	0xFF80	Current FSK Demodulator Min Deviation

In manual mode, it should be set to

$$- 3 \times 512 \times \frac{f_{DEVIATION}}{BAUDRATE}$$

AFSKSPACE1, AFSKSPACE0

Table 101. AFSKSPACE1, AFSKSPACE0

Name	Bits	R/W	Reset	Description
AFSKSPACE	15:0	RW	0x0040	AFSK Space (0-Bit encoding) Frequency

For receive, the register should be computed as follows:

$$AFSKSPACE = \left[\frac{f_{AFSKSPACE} \times DECIMATION \times f_{XTALDIV} \times 2^{16}}{f_{XTAL}} + \frac{1}{2} \right]$$

For transmit, the register has a slightly different

definition: $AFSKSPACE = \left[\frac{f_{AFSKSPACE} \times 2^{18}}{f_{XTAL}} + \frac{1}{2} \right]$

AFSKMARK1, AFSKMARK0

Table 102. AFSKMARK1, AFSKMARK0

Name	Bits	R/W	Reset	Description
AFSKMARK	15:0	RW	0x0075	AFSK Mark (1-Bit encoding) Frequency

For receive, the register should be computed as follows:

$$AFSKMARK = \left[\frac{f_{AFSKMARK} \times DECIMATION \times f_{XTALDIV} \times 2^{16}}{f_{XTAL}} + \frac{1}{2} \right]$$

For transmit, the register has a slightly different

definition: $AFSKMARK = \left[\frac{f_{AFSKMARK} \times 2^{18}}{f_{XTAL}} + \frac{1}{2} \right]$

AFSKCTRL

Table 103. AFSKCTRL

Name	Bits	R/W	Reset	Description
AFSKSHIFT	4:0	RW	00100	AFSK Detector Bandwidth; $2 \times \left[\log_2 \left(\frac{f_{XTAL}}{2^5 \times BITRATE \times f_{XTALDIV} \times DECIMATION} \right) \right]$ 3dB corner frequency of the AFSK detector filter is: $f_c = \frac{f_{XTAL}}{2^5 \times \pi \times f_{XTALDIV} \times DECIMATION} \times \arccos \left(\frac{k^2 + 2k - 2}{2 \times (k - 1)} \right)$ $k = 2^{-\left[\frac{AFSKSHIFT}{2} \right]}$ with

AMPLFILTER

Table 104. AMPLFILTER

Name	Bits	R/W	Reset	Description
AMPLFILTER	3:0	RW	0000	<p>3dB corner frequency of the Amplitude (Magnitude) Lowpass Filter;</p> $f_c = \frac{f_{XTAL}}{2^5 \times \pi \times f_{XTALDIV} \times DECIMATION} \times \arccos\left(\frac{k^2 + 2k - 2}{2 \times (k - 1)}\right)$ <p>with $k = 2^{-AMPLFILTER}$</p> <p>0000: Filter bypassed</p>

FREQUENCYLEAK

Table 105. FREQUENCYLEAK

Name	Bits	R/W	Reset	Description
FREQUENCYLEAK	3:0	RW	0000	Leakiness of the Baseband Frequency Recovery Loop (0000 = off)

RXPARAMSETS

Table 106. RXPARAMSETS

Name	Bits	R/W	Reset	Description
RXPS0	1:0	RW	00	RX Parameter Set Number to be used for initial settling
RXPS1	3:2	RW	00	RX Parameter Set Number to be used after Pattern 1 matched and before Pattern 0 match
RXPS2	5:4	RW	00	RX Parameter Set Number to be used after Pattern 0 matched
RXPS3	7:6	RW	00	RX Parameter Set Number to be used after a packet start has been detected

RXPARAMCURSET

Table 107. RXPARAMCURSET

Name	Bits	R/W	Reset	Description
RXSI	1:0	R	–	RX Parameter Set Index (determines which RXPS is used)
RXSN	3:2	R	–	RX Parameter Set Number (=RXPS[RXSI (1:0)])
RXSI	4	R	–	Rx Parameter Set Index (special function bit), See Table 108

Table 108. RX PARAMETERS SET INDEX BIT VALUES

RXSI Bits	Meaning
0XX	Normal Function (indirection via RXPS)
1X0	Coarse AGC
1X1	Baseband Offset Acquisition

AGCGAIN0, AGCGAIN1, AGCGAIN2, AGCGAIN3

Table 109. AGCGAIN0, AGCGAIN1, AGCGAIN2, AGCGAIN3

Name	Bits	R/W	Reset	Description
AGCATTACK0	3:0	RW	0100	AGC gain reduction speed
AGCATTACK1			0100	
AGCATTACK2			1111	AGC gain reduction speed
AGCATTACK3			1111	
AGCDECAY0	7:4	RW	1011	AGC gain increase speed
AGCDECAY1			1011	
AGCDECAY2			1111	
AGCDECAY3			1111	

The 3dB corner frequency of the AGC loop is:

$$f_{3dB} = \frac{f_{XTAL}}{2^5 \times \pi \times f_{XTALDIV}} \times \arccos\left(\frac{2 + 2^{1-AGC[ATTACK|DECAY]x} - 2^{-2AGC[ATTACK|DECAY]x}}{2 + 2^{1-ACG[ATTACK|DECAY]x}}\right)$$

$$\cong \frac{f_{XTAL}}{2^5 \times \pi \times f_{XTALDIV}} \times (2^{-AGC[ATTACK|DECAY]x} - 2^{-1-2 \times AGC[ATTACK|DECAY]x})$$

The AGC{ATTACK|DECAY}x values can be computed from the 3dB corner frequency f_{3dB} as follows:

$$c = \cos\left(\frac{2^5 \times \pi \times f_{XTALDIV} \times f_{3dB}}{f_{XTALDIV}}\right)$$

$$AGC\{ATTACK\}DECAY\}x = -\log_2(1 - c + \sqrt{c^2 - 4 \times c + 3})$$

$$\cong -\log_2\left(1 - \sqrt{1 - \frac{2^6 \times \pi \times f_{XTALDIV} \times f_{3dB}}{f_{XTAL}}}\right)$$

The recommended AGCATTACK setting is $f_{3dB} \cong \text{BITRATE}/10$ for ASK, and $f_{3dB} \cong \text{BITRATE}$ for (G)FSK.

The recommended AGCDECAY setting is $f_{3dB} \cong \text{BITRATE}/100$ for ASK, and $f_{3dB} \cong \text{BITRATE}/10$ for (G)FSK.

A value of 0xF in the AGC{ATTACK|DECAY}x disables AGC update. Thus, setting the AGCGAIN0/AGCGAIN1/AGCGAIN2/AGCGAIN3 register to 0xFF completely freezes the AGC.

AGCTARGET0, AGCTARGET1, AGCTARGET2, AGCTARGET3

Table 110. AGCTARGET0, AGCTARGET1, AGCTARGET2, AGCTARGET3

Name	Bits	R/W	Reset	Description
AGCTARGET0 AGCTARGET1 AGCTARGET2 AGCTARGET3	7:0	RW	01110110	The target ADC output average magnitude is $2^{\frac{AGCTARGETx}{16}}$. Note that the ADC can produce magnitudes from 0...2 ⁹ -1.

AGCAHYST0, AGCAHYST1, AGCAHYST2, AGCAHYST3

Table 111. AGCAHYST0, AGCAHYST1, AGCAHYST2, AGCAHYST3

Name	Bits	R/W	Reset	Description
AGCAHYST0 AGCAHYST1 AGCAHYST2 AGCAHYST3	2:0	RW	000	This field specifies Digital Threshold Range. It is (AGCAHYSTx+1) 3 dB; If set to zero, the analog AGC always follows immediately. Increasing this value gives the AGC controller more leeway delay analog AGC following.

AGCMINMAX0, AGCMINMAX1, AGCMINMAX2, AGCMINMAX3

Table 112. AGCMINMAX0, AGCMINMAX1, AGCMINMAX2, AGCMINMAX3

Name	Bits	R/W	Reset	Description
AGCMAXDA0 AGCMAXDA1 AGCMAXDA2 AGCMAXDA3	6:4	RW	000	When the digital AGC attenuation exceeds its maximum value, it is reset to the value given in AGCMAXDAX, and the analog AGC gain is recomputed accordingly. This value is given in 3 dB steps. Setting it to AGCAHYSTx causes “drag” AGC behaviour with minimum analog AGC steps (probably desirable); decreasing it causes less frequent but larger analog AGC steps
AGCMINDA0 AGCMINDA1 AGCMINDA2 AGCMINDA3	2:0	RW	000	When the digital AGC attenuation exceeds its minimum value, it is reset to the value given in AGCMINDAX, and the analog AGC gain is recomputed accordingly. This value is given in 3 dB steps. Setting it to 000 causes “drag” AGC behaviour with minimum analog AGC steps (probably desirable); increasing it causes less frequent but larger analog AGC steps

TIMEGAIN0, TIMEGAIN1, TIMEGAIN2, TIMEGAIN3

Table 113. TIMEGAIN0, TIMEGAIN1, TIMEGAIN2, TIMEGAIN3

Name	Bits	R/W	Reset	Description
TIMEGAIN0E TIMEGAIN1E TIMEGAIN2E TIMEGAIN3E	3:0	RW	1000 0110 0101 0101	Gain of the timing recovery loop; this is the exponent

AND9347/D

Table 113. TIMEGAIN0, TIMEGAIN1, TIMEGAIN2, TIMEGAIN3 (continued)

Name	Bits	R/W	Reset	Description
TIMEGAIN0M TIMEGAIN1M TIMEGAIN2M TIMEGAIN3M	7:4	RW	1111	Gain of the timing recovery loop; this is the mantissa

$$TIMEGAIN_{xM}, TIMEGAIN_{xE} = \arg \min_{TIMEGAIN_{xM}, E} \left| \frac{RXDATARATE}{TMGCORRRFRAC_x} - TIMEGAIN_{xM} \times 2^{TIMEGAIN_{xE}} \right|$$

TMGCORRRFRAC should be chosen at least 4. Larger values result in less sampling time jitter, but slower timing lock-in.

DRGAIN0, DRGAIN1, DRGAIN2, DRGAIN3

Table 114. DRGAIN0, DRGAIN1, DRGAIN2, DRGAIN3

Name	Bits	R/W	Reset	Description
DRGAIN0E DRGAIN1E DRGAIN2E DRGAIN3E	3:0	RW	0010 0001 0000 0000	Gain of the datarate recovery loop; this is the exponent
DRGAIN0M DRGAIN1M DRGAIN2M DRGAIN3M	7:4	RW	1111 1111 1111 1111	Gain of the datarate recovery loop; this is the mantissa

$$DRGAIN_{xM}, DRGAIN_{xE} = \arg \min_{DRGAIN_{xM}, E} \left| \frac{RXDATARATE}{DRGCORRRFRAC_x} - DRGAIN_{xM} \times 2^{DRGAIN_{xE}} \right|$$

DRGCORRRFRAC should be chosen at least 64. Larger values result in less estimated datarate jitter, but slower datarate acquisition.

PHASEGAIN0, PHASEGAIN1, PHASEGAIN2, PHASEGAIN3

Table 115. PHASEGAIN0, PHASEGAIN1, PHASEGAIN2, PHASEGAIN3

Name	Bits	R/W	Reset	Description
PHASEGAIN0 PHASEGAIN1 PHASEGAIN2 PHASEGAIN3	3:0	RW	0011	Gain of the phase recovery loop
FILTERIDX0 FILTERIDX1 FILTERIDX2 FILTERIDX3	7:6	RW	11	Decimation Filter Fractional Bandwidth, see the table below

This register does not normally need to be changed.

Table 116. RELATIVE BANDWIDTH

FILTERIDXx	Relative Bandwidth $\frac{f_{XTAL}}{2^{16} \times f_{XTALDIV} \times DECIMATION} Hz$			
	-3dB BW	nominal BW	-10dB BW	-40dB BW
00	0.121399	0.150000	0.174805	0.256653
01	0.149475	0.177845	0.202759	0.284729
10	0.182373	0.210858	0.235718	0.317566
11	0.221497	0.250000	0.274780	0.356812

NOTE: 1. Fractional Filter Bandwidth

The relative bandwidths in the table above need to be multiplied with $\frac{f_{XTAL}}{2^{16} \times f_{XTALDIV} \times DECIMATION}$ to get the bandwidth in Hz.

FREQGAINA0, FREQGAINA1, FREQGAINA2, FREQGAINA3

Table 117. FREQGAINA0, FREQGAINA1, FREQGAINA2, FREQGAINA3

Name	Bits	R/W	Reset	Description
FREQGAINA0 FREQGAINA1 FREQGAINA2 FREQGAINA3	3:0	RW	1111 1111 1111 1111	Gain of the baseband frequency recovery loop; the frequency error is measured with the phase detector
FREQAMPLGATE0 FREQAMPLGATE1 FREQAMPLGATE2 FREQAMPLGATE3	4	RW	0 0 0 0	If set to 1, only update the frequency offset recovery loops if the amplitude of the signal is larger than half the maximum (or larger than the average amplitude)
FREQHALFMODE0 FREQHALFMODE1 FREQHALFMODE2 FREQHALFMODE3	5	RW	0 0 0 0	If 1, the Frequency offset wraps around from 0x1fff to – 0x2000, and vice versa.
FREQMODULO0 FREQMODULO1 FREQMODULO2 FREQMODULO3	6	RW	0 0 0 0	If 1, the Frequency offset wraps around from 0x3fff to – 0x4000, and vice versa.
FREQLIM0 FREQLIM1 FREQLIM2 FREQLIM3	7	RW	0 0 0 0	If 1, limit Frequency Offset to – 0x4000...0x3fff

Set FREQGAINA0 = 15 and FREQGAINB0 = 31 to completely disable the baseband frequency recovery loop, setting its output to zero.

AND9347/D

FREQGAINB0, FREQGAINB1, FREQGAINB2, FREQGAINB3

Table 118. FREQGAINB0, FREQGAINB1, FREQGAINB2, FREQGAINB3

Name	Bits	R/W	Reset	Description
FREQGAINB0 FREQGAINB1 FREQGAINB2 FREQGAINB3	4:0	RW	11111	Gain of the baseband frequency recovery loop; the frequency error is measured with the frequency detector
FREQAVG0 FREQAVG1 FREQAVG2 FREQAVG3	6	RW	0	Average the frequency offset of two consecutive bits; this is useful for 0101 preambles in FSK mode
FREQFREEZE0 FREQFREEZE1 FREQFREEZE2 FREQFREEZE3	7	RW	0	Freeze the baseband frequency recovery loop if set

Set FREQGAINA0 = 15 and FREQGAINB0 = 31 to completely disable the baseband frequency recovery loop,

FREQGAINC0, FREQGAINC1, FREQGAINC2, FREQGAINC3

Table 119. FREQGAINC0, FREQGAINC1, FREQGAINC2, FREQGAINC3

Name	Bits	R/W	Reset	Description
FREQGAINC0 FREQGAINC1 FREQGAINC2 FREQGAINC3	4:0	RW	01010 01011 01101 01101	Gain of the RF frequency recovery loop; the frequency error is measured with the phase detector

Set FREQGAINC0 = 31 and FREQGAIND0 = 31 to completely disable the RF frequency recovery loop, setting its output to zero.

FREQGAIND0, FREQGAIND1, FREQGAIND2, FREQGAIND3

Table 120. FREQGAIND0, FREQGAIND1, FREQGAIND2, FREQGAIND3

Name	Bits	R/W	Reset	Description
FREQGAIND0 FREQGAIND1 FREQGAIND2 FREQGAIND3	4:0	RW	01010 01011 01101 01101	Gain of the RF frequency recovery loop; the frequency error is measured with the frequency detector
RFFREQFREEZE0 RFFREQFREEZE1 RFFREQFREEZE2 RFFREQFREEZE3	7	RW	0	Freeze the RF frequency recovery loop if set

Set FREQGAINC0 = 31 and FREQGAIND0 = 31 to completely disable the RF frequency recovery loop, setting its output to zero.

AND9347/D

AMPLGAIN0, AMPLGAIN1, AMPLGAIN2, AMPLGAIN3

Table 121. AMPLGAIN0, AMPLGAIN1, AMPLGAIN2, AMPLGAIN3

Name	Bits	R/W	Reset	Description
AMPLGAIN0 AMPLGAIN1 AMPLGAIN2 AMPLGAIN3	3:0	RW	0110	Gain of the amplitude recovery loop
AMPLAGC0 AMPLAGC1 AMPLAGC2 AMPLAGC3	6	RW	1	if 1, try to correct the amplitude register when AGC jumps. This is not perfect, though
AMPLAVG0 AMPLAVG1 AMPLAVG2 AMPLAVG3	7	RW	0	if 0, the amplitude is recovered by a peak detector with decay; if 1, the amplitude is recovered by averaging

This register does not normally need to be changed.

FREQDEV10, FREQDEV00, FREQDEV11, FREQDEV01, FREQDEV12, FREQDEV02, FREQDEV13, FREQDEV03

Table 122. FREQDEVx VALUES

Name	Bits	R/W	Reset	Description
FREQDEV0 FREQDEV1 FREQDEV2 FREQDEV3	11:0	RW	0x020 0x020 0x020 0x020	Receiver Frequency Deviation; $FREQDEV_x = \left[\frac{f_{DEVIATION} \times 2^8 \times k_{SF}}{BITRATE} + \frac{1}{2} \right]$ is k_{SF} transmitter shaping and receiver filtering dependent constant. It is usually around $k_{sf} \approx 0.8$

Enabling this feature ($FREQDEV_x \neq 0$) can lead the frequency offset estimator to lock at the wrong offset. It is therefore recommended to enable it only after the frequency

offset estimator is close to the correct offset (i.e. $FREQDEV_0 = 0$).

FOURFSK0, FOURFSK1, FOURFSK2, FOURFSK3

Table 123. FOURFSK0, FOURFSK1, FOURFSK2, FOURFSK3

Name	Bits	R/W	Reset	Description
DEVDECAY0 DEVDECAY1 DEVDECAY2 DEVDECAY3	3:0	RW	0110 1000 1010 1010	Deviation Decay
DEVUPDATE0 DEVUPDATE1 DEVUPDATE2 DEVUPDATE3	4	RW	1	Enable Deviation Update

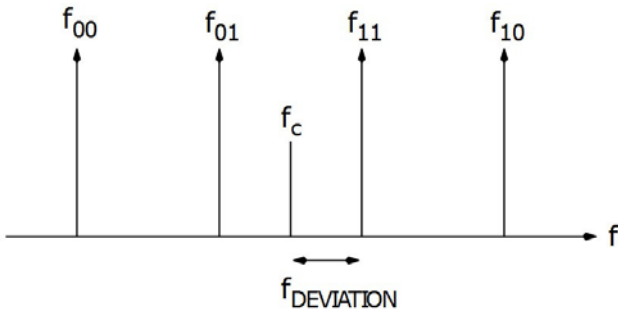

Figure 21. 4-FSK Frequency Diagram

In 4-FSK mode, two bits are transmitted together during each symbol, by using four frequencies instead of two. Figure 21 depicts the frequencies used.

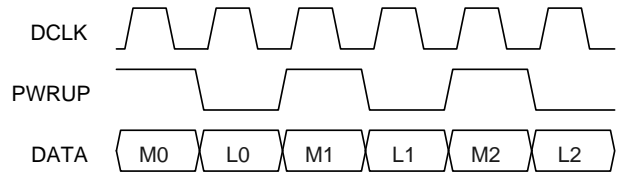

Figure 22. Wiremode Timing Diagram

Wiremode is also available in 4-FSK mode, see Figure 22. The two bits that encode one symbol are serialized on the DATA pin. The PWRUP pin can be used as a synchronization pin to allow symbol (dibit) boundaries to be reconstructed. DCLK is approximately but not exactly square. Gray encoding is used to reduce the number of bit errors in case of a wrong decision. The two bits encode the following frequencies:

Table 124. 4-FSK BIT TO FREQUENCY MAPPING

M_x	L_x	Frequency
0	0	$f_{\text{CARRIER}} * 3 \vee f_{\text{DEVIATION}}$
0	1	$f_{\text{CARRIER}} * f_{\text{DEVIATION}}$
1	1	$f_{\text{CARRIER}} + f_{\text{DEVIATION}}$
1	0	$f_{\text{CARRIER}} + 3 \vee f_{\text{DEVIATION}}$

In framing mode, unless ENC NOSYNC in the ENCODING register is set, the shift register is synchronized to the dibit boundaries, and the pattern matches only at dibit

boundaries. The shift register shifts right, so the bits end up in the FIFO word as follows:

Table 125.

7	6	5	4	3	2	1	0
L_{n+3}	M_{n+3}	L_{n+2}	M_{n+2}	L_{n+1}	M_{n+1}	L_n	M_n

In 4-FSK mode, it is no longer sufficient to compare the actual frequency with the center frequency and just record the sign. The frequency deviation of the transmitter must be known in order to choose the correct decision thresholds. This is the purpose of the FSKD MAX1, FSKD MAX0, FSKD MIN1 and FSKD MIN0 registers. These registers can either be set manually or recover the frequency deviation automatically. DEVUPDATE selects automatic mode if set to one, and manual mode if set to zero. Normally, automatic

mode can be selected, but if the frequency deviation of the transmitter is exactly known at the receiver, manual mode can result in slightly better performance.

In automatic mode, FSKD MAX1, FSKD MAX0, FSKD MIN1 and FSKD MIN0 record the maximal and the minimal frequency seen at the receiver. “Leakage” or “gravity to zero” is added such that if these registers are disturbed by noise spikes, the effect decays. The amount of leakage is controlled by DEVDECAY.

Table 126. AMOUNT OF LEAKAGE

Bits	Meaning
0000	0
0001	1
0010	2
0011	5
0100	11
0101	22
0110	44

Table 126. AMOUNT OF LEAKAGE (continued)

0111	88
1000	177
1001	355
1010	709
1011	1419
1100	2839
1101	5678
1110	11356
1111	22713

BBOFFSRES0, BBOFFSRES1, BBOFFSRES2, BBOFFSRES3

Table 127. BBOFFSRES0, BBOFFSRES1, BBOFFSRES2, BBOFFSRES3

Name	Bits	R/W	Reset	Description
RESINTA0 RESINTA1 RESINTA2 RESINTA3	3:0	RW	1000	Baseband Gain Block A Offset Compensation Resistors
RESINTB0 RESINTB1 RESINTB2 RESINTB3	7:4	RW	1000	Baseband Gain Block B Offset Compensation Resistors

Transmitter Parameters

MODCFGF

This register selects the frequency shaping mode of the transmitter.

Table 128. MODCFGF

Name	Bits	R/W	Reset	Description
FREQSHAPE	1:0	RW	00	See Table129: FREQSHAPE Bit Value

Table 129. FREQSHAPE BIT VALUES

Bits	Meaning
01	Invalid
00	External Loop Filter
10	Gaussian BT = 0.3
11	Gaussian BT = 0.5

FSKDEV2, FSKDEV1, FSKDEV0

Table 130. FSKDEV2, FSKDEV1, FSKDEV0

Name	Bits	R/W	Reset	Description
FSKDEV	23:0	RW	0x000A3D	(G)FSK Frequency Deviation; $FSKDEV = \left[\frac{f_{DEVIATION}}{f_{XTAL}} \times 2^{24} + \frac{1}{2} \right]$

AND9347/D

Note that $f_{\text{DEVIATION}}$ is actually half the deviation. The mark frequency is $f_{\text{CARRIER}} + f_{\text{DEVIATION}}$, the space frequency is $f_{\text{CARRIER}} - f_{\text{DEVIATION}}$.

$$f_{\text{DEVIATION}} = \frac{h}{2} \times \text{BITRATE}$$

In AFSK mode, the register has a slightly different definition: $FSKDEV = \left[\frac{0.858785 \times f_{\text{DEVIATION}}}{f_{\text{XTAL}}} \times 2^{24} + \frac{1}{2} \right]$

In FM mode, the register has a different definition. It defines the conditioning of the ADC values prior to applying them to the transmit amplitude or the frequency deviation.

Table 131. FMSHIFT, FMINPUT, FMSEXT, FMOFFS

Name	Bits	R/W	Reset	Description
FMSHIFT	2:0	RW	101	These Bits Scale the ADC Value, See Table 132
FMINPUT	9:8	RW	10	Input Selection, See Table 133
FMSEXT	14	RW	0	ADC Sign Extension
FMOFFS	15	RW	0	ADC Offset Subtract

Table 132. FMSHIFT BIT VALUES

Bits	Meaning
000	FM: $f_{\text{DEVIATION}} = \frac{+ \text{ADCFS} \times f_{\text{XTAL}}}{2^{15}}$
001	FM: $f_{\text{DEVIATION}} = \frac{+ \text{ADCFS} \times f_{\text{XTAL}}}{2^{14}}$
010	FM: $f_{\text{DEVIATION}} = \frac{+ \text{ADCFS} \times f_{\text{XTAL}}}{2^{13}}$
011	FM: $f_{\text{DEVIATION}} = \frac{+ \text{ADCFS} \times f_{\text{XTAL}}}{2^{12}}$
100	FM: $f_{\text{DEVIATION}} = \frac{+ \text{ADCFS} \times f_{\text{XTAL}}}{2^{11}}$
101	FM: $f_{\text{DEVIATION}} = \frac{+ \text{ADCFS} \times f_{\text{XTAL}}}{2^{10}}$
110	FM: $f_{\text{DEVIATION}} = \frac{+ \text{ADCFS} \times f_{\text{XTAL}}}{2^9}$
111	FM: $f_{\text{DEVIATION}} = \frac{+ \text{ADCFS} \times f_{\text{XTAL}}}{2^8}$

Table 133. FMINPUT BIT VALUES

Bits	Meaning
00	GPADC13
01	GPADC1
10	GPADC2
11	GPADC3

MODCFG

This register selects the amplitude shaping mode of the transmitter. Amplitude shaping is used even for constant modulus modulation such as FSK, to ramp up and down the transmitter at the beginning and the end of the transmission.

Table 134. MODCFG

Name	Bits	R/W	Reset	Description
TXDIFF	0	RW	1	Enable Differential Transmitter
TXSE	1	RW	0	Enable Single Ended Transmitter
AMPLSHAPE	2	RW	1	See Table 135
SLOWRAMP	5:4	RW	00	See Table136
PTTLCK GATE	6	RW	0	If 1, disable transmitter if PLL loses lock
BROWN GATE	7	RW	0	If 1, disable transmitter if Brown Out is detected

Table 135. AMPLSHAPE BIT VALUES

Bits	Meaning
0	Unshaped
1	Raised Cosine

Table 136. SLOWRAMP BIT VALUES

Bits	Meaning
00	Normal Startup (1 Bit Time)
01	2 Bit Time Startup
10	4 Bit Time Startup
11	8 Bit Time Startup

AND9347/D

If BROWN_GATE is set, the transmitter is disabled whenever one (or more) of the SSVIO, SSBEVMODEM or SSBEVANA bits of the POWSTICKYSTAT register is zero.

In order for this to work, the user must read the POWSTICKYSTAT after setting the PWRMODE register for transmission.

TXRATE2, TXRATE1, TXRATE0

Table 137. TXRATE2, TXRATE1, TXRATE0

Name	Bits	R/W	Reset	Description
TXRATE	23:0	RW	0x0028F6	Transmit Bitrate, $TXRATE = \left[\frac{BITRATE}{f_{XTAL}} \times 2^{24} + \frac{1}{2} \right]$

In asynchronous wire mode, $BITRATE < \frac{f_{XTAL}}{32}$

TXPWRCOEFFA1, TXPWRCOEFFA0

Table 138. TXPWRCOEFFA1, TXPWRCOEFFA0

Name	Bits	R/W	Reset	Description
TXPWRCOEFFA	15:0	RW	0x0000	Transmit Predistortion, $TXPWRCOEFFA = \left[\alpha_0 \times 2^{12} + \frac{1}{2} \right]$

See TXPWRCOEFFB0 for an explanation.

TXPWRCOEFFB1, TXPWRCOEFFB0

Table 139. TXPWRCOEFFB1, TXPWRCOEFFB0

Name	Bits	R/W	Reset	Description
TXPWRCOEFFB	15:0	RW	0x0FFF	Transmit Predistortion, $TXPWRCOEFFB = \left[\alpha_1 \times 2^{12} + \frac{1}{2} \right]$

The transmit predistortion circuit applies the following function to the output of the raised cosine amplitude shaping:

$$f(x) = \alpha_4 \cdot x^4 + \alpha_3 \cdot x^3 + \alpha_2 \cdot x^2 + \alpha_1 \cdot x + \alpha_0$$

x is the input from the raised cosine shaping circuit ($0 \leq x \leq 1$), and the output f(x) drives the power amplifier

(0 means no output power, 1 means maximum output power).

For conventional (non-predistorted output), $\alpha_0 = \alpha_2 = \alpha_3 = \alpha_4 = 0$ and $0 \leq \alpha_1 \leq 1$ controls the output power. If hard amplitude shaping is selected, both the raised cosine amplitude shaper and the predistortion is bypassed, and α_1 used.

TXPWRCOEFFC1, TXPWRCOEFFC0

Table 140. TXPWRCOEFFC1, TXPWRCOEFFC0

Name	Bits	R/W	Reset	Description
TXPWRCOEFFC	15:0	RW	0x0000	Transmit Predistortion, $TXPWRCOEFFC = \left[\alpha_2 \times 2^{12} + \frac{1}{2} \right]$

See TXPWRCOEFFB0 for an explanation.

TXPWRCOEFFD1, TXPWRCOEFFD0

Table 141. TXPWRCOEFFD1, TXPWRCOEFFD0

Name	Bits	R/W	Reset	Description
TXPWRCOEFFD	15:0	RW	0x0000	Transmit Predistortion, $TXPWRCOEFFD = \left[\alpha_3 \times 2^{12} + \frac{1}{2} \right]$

See TXPWRCOEFFB0 for an explanation.

TXPWRCOEFFE1, TXPWRCOEFFE0

Table 142. TXPWRCOEFFE1, TXPWRCOEFFE0

Name	Bits	R/W	Reset	Description
TXPWRCOEFFE	15:0	RW	0x0000	Transmit Predistortion, $TXPWRCOEFFB = \left[\alpha_4 \times 2^{12} + \frac{1}{2} \right]$

See TXPWRCOEFFB0 for an explanation.

PLL Parameters

PLLVCOI

Table 143. PLLVCOI

Name	Bits	R/W	Reset	Description
VCOI	5:0	RW	010010	This field sets the bias current for both VCOs. The increment is 50 μ A for VCO1 and 10 μ A for VCO2.
VCOIE	7	RW	0	Enable manual VCOI

PLLVCOIR

Table 144. PLLVCOIR

Name	Bits	R/W	Reset	Description
VCOIR	5:0	R	–	This field reflects the actual VCO current selected. If VCOIE (Register PLLVCOI) is selected, this field reads the same as VCOI (also Register PLLVCOI). Otherwise, the value reflects the automatic setting.

PLLLOCKDET

Table 145. PLLLOCKDET

Name	Bits	R/W	Reset	Description
LOCKDETDLY	1:0	RW	11	See Table 146: LOCKDETDLY Bit Values
LOCKDETDLYM	2	RW	0	0 = Automatic Lock Delay (determined by the currently active frequency register); 1 = Manual Lock Delay (Bits LOCKDETDLY)
LOCKDETDLYR	7:6	R	–	Lock Detect Read Back (not valid in power down mode)

Table 146. LOCKDETDLY BIT VALUES

Bits	Meaning
00	Lock Detector Delay 6ns
01	Lock Detector Delay 9ns
10	Lock Detector Delay 12ns
11	Lock Detector Delay 14ns

PLLNGCLK

Table 147. PLLNGCLK

Name	Bits	R/W	Reset	Description
PLLNGCLK	2:0	RW	011	See Table 148: PLLNGCLK Bit Values

Table 148. PLLRNGCLK BIT VALUES

Bits	Meaning
000	PLL Ranging Clock: $f_{PLL\text{RNG}} = \frac{f_{XTAL}}{2^8}$
000	PLL Ranging Clock: $f_{PLL\text{RNG}} = \frac{f_{XTAL}}{2^9}$
000	PLL Ranging Clock: $f_{PLL\text{RNG}} = \frac{f_{XTAL}}{2^8}$
000	PLL Ranging Clock: $f_{PLL\text{RNG}} = \frac{f_{XTAL}}{2^{11}}$
000	PLL Ranging Clock: $f_{PLL\text{RNG}} = \frac{f_{XTAL}}{2^{12}}$
000	PLL Ranging Clock: $f_{PLL\text{RNG}} = \frac{f_{XTAL}}{2^{13}}$
000	PLL Ranging Clock: $f_{PLL\text{RNG}} = \frac{f_{XTAL}}{2^{14}}$
000	PLL Ranging Clock: $f_{PLL\text{RNG}} = \frac{f_{XTAL}}{2^{15}}$

$f_{PLL\text{RNG}}$ should be less than one tenth of the loop filter bandwidth, to allow enough settling time.

Crystal Oscillator

XTALCAP

Table 149. XTALCAP

Name	Bits	R/W	Reset	Description
XTALCAP	7:0	RW	00000000	Load Capacitance Configuration, See Table 150

Table 150. LOCKDETDLY BIT VALUES

Bits	Meaning
000000	3 pF
000001	8.5 pF
000010	9 pF
...	...
110111	36 pF
...	...
111111	40 pF

For values $XTALCAP(5:0) \neq 0$, $C_L = 8 \text{ pF} + 0.5 \text{ pF} \cdot XTALCAP(5:0)$.

Baseband

BBTUNE

Table 151. BBTUNE

Name	Bits	R/W	Reset	Description
BBTUNE	3:0	RW	1001	Baseband Tuning Value
BBTUNERUN	4	RW	0	Baseband Tuning Start

BBOFFSCAP

Table 152. BBOFFSCAP

Name	Bits	R/W	Reset	Description
CAPINTA	2:0	RW	111	Baseband Gain Block A Offset Compensation Capacitors
CAPINTB	6:4	RW	111	Baseband Gain Block B Offset Compensation Capacitors

Packet Format

PKTADDRCFG

Table 153. PKTADDRCFG

Name	Bits	R/W	Reset	Description
ADDR POS	3:0	RW	0000	Position of the address bytes
FEC SYNC DIS	5	RW	1	When set, disable FEC sync search during packet reception
CRC SKIP FIRST	6	RW	0	When set, the first byte of the packet is not included in the CRC calculation
MSB FIRST	7	RW	0	When set, each byte is sent MSB first; when cleared, each byte is sent LSB first

PKTLENCFG

Table 154. PKTLENCFG

Name	Bits	R/W	Reset	Description
LEN POS	3:0	RW	0000	Position of the length byte
LEN BITS	7:4	RW	0000	Number of significant bits in the length byte

The built-in packet length logic can support up to 255 byte packets. It is still possible to receive larger packets if packet length and, unless using HDLC, CRC is handled in the microprocessor firmware. In order to enable reception of arbitrary length packets, the following settings must be made:

- Register PKTLENCFG LEN BITS (bits 7:4) = 1111
- Register PKTMAXLEN = 0xFF
- Register PKTACCEPTFLAGS ACCPT LRGP (bit 5) = 1

PKTLENOFFSET

Table 155. PKTLENOFFSET

Name	Bits	R/W	Reset	Description
LEN OFFSET	7:0	RW	0x00	Packet Length Offset

The receiver adds LEN OFFSET to the length byte. The value of (length byte + LEN OFFSET) counts every byte in the packet after the synchronization pattern, up to and excluding the CRC bytes, but including the length byte.

For example with PKTLENCFG = 0x80 and PKTLENOFFSET = 0x00 the receiver will correctly receive the following packet (b1, b2 and b3 being data bytes).

Mode specific Framing	0x04	B1	B2	B3	CRC
-----------------------	------	----	----	----	-----

With PKTLENCFG = 0x80 and PKTLENOFFSET = 0x01 the receiver will correctly receive the following packet

PKTMAXLEN

Table 156. PKTMAXLEN

Name	Bits	R/W	Reset	Description
MAX LEN	7:0	RW	0x00	Packet Maximum Length

PKTADDR3, PKTADDR2, PKTADDR1, PKTADDR0

Table 157. PKTADDR3, PKTADDR2, PKTADDR1, PKTADDR0

Name	Bits	R/W	Reset	Description
ADDR	31:0	RW	0x00000000	Packet Address

Mode specific Framing	0x03	B1	B2	B3	CRC
-----------------------	------	----	----	----	-----

With PKTLENCFG = 0x00 and PKTLENOFFSET = 0x03 the receiver will correctly receive the following packet without length byte

Mode specific Framing	B1	B2	B3	CRC
-----------------------	----	----	----	-----

The length offset is treated as a signed value; LEN OFFSET 0xff means the length offset is -1.

AND9347/D

PKTADDRMASK3, PKTADDRMASK2, PKTADDRMASK1, PKTADDRMASK0

Table 158. PKTADDRMASK3, PKTADDRMASK2, PKTADDRMASK1, PKTADDRMASK0

Name	Bits	R/W	Reset	Description
ADDRMASK	31:0	RW	0x00000000	Packet Address Mask

Pattern Match

MATCH0PAT3, MATCH0PAT2, MATCH0PAT1, MATCH0PAT0

Table 159. MATCH0PAT3, MATCH0PAT2, MATCH0PAT1, MATCH0PAT0

Name	Bits	R/W	Reset	Description
MATCH0PAT	31:0	RW	0x00000000	Pattern for Match Unit 0; LSB is received first; patterns of length less than 32 must be MSB aligned

MATCH0LEN

Table 160. MATCH0LEN

Name	Bits	R/W	Reset	Description
MATCH0LEN	4:0	RW	00000	Pattern Length for Match Unit 0; The length in bits of the pattern is MATCH0LEN + 1
MATCH0RAW	7	RW	0	Select whether Match Unit 0 operates on decoded (after Manchester, Descrambler etc.) (if 0), or on raw received bits (if 1)

MATCH0MIN

Table 161. MATCH0MIN

Name	Bits	R/W	Reset	Description
MATCH0MIN	4:0	RW	00000	A match is signalled if the received bitstream matches the pattern in less than MATCH0MIN positions. This can be used to detect inverted sequences.

MATCH0MAX

Table 162. MATCH0MAX

Name	Bits	R/W	Reset	Description
MATCH0MAX	4:0	RW	11111	A match is signalled if the received bitstream matches the pattern in more than MATCH0MAX positions.

MATCH1PAT1, MATCH1PAT0

Table 163. MATCH1PAT1, MATCH1PAT0

Name	Bits	R/W	Reset	Description
MATCH1PAT	15:0	RW	0x0000	Pattern for Match Unit 1; LSB is received first; patterns of length less than 16 must be MSB aligned

MATCH1LEN

Table 164. MATCH1LEN

Name	Bits	R/W	Reset	Description
MATCH1LEN	3:0	RW	0000	Pattern Length for Match Unit 1; The length in bits of the pattern is MATCH1LEN + 1
MATCH1RAW	7	RW	0	Select whether Match Unit 1 operates on decoded (after Manchester, Descrambler etc.) (if 0), or on raw received bits (if 1)

*MATCH1MIN***Table 165. MATCH1MIN**

Name	Bits	R/W	Reset	Description
MATCH1MIN	3:0	RW	0000	A match is signalled if the received bitstream matches the pattern in less than MATCH1MIN positions. This can be used to detect inverted sequences.

*MATCH1MAX***Table 166. MATCH1MAX**

Name	Bits	R/W	Reset	Description
MATCH1MAX	3:0	RW	1111	A match is signalled if the received bitstream matches the pattern in more than MATCH1MAX positions.

Packet Controller*TMGTXBOOST***Table 167. TMGTXBOOST**

Name	Bits	R/W	Reset	Description
TMGTXBOOSTM	4:0	RW	10010	Transmit PLL Boost Time Mantissa
TMGTXBOOSTE	7:5	RW	001	Transmit PLL Boost Time Exponent

The Transmit PLL Boost Time is $TMGTXBOOSTM \cdot 2^{TMGTXBOOSTE} \mu s$.

*TMGTXSETTLE***Table 168. TMGTXSETTLE**

Name	Bits	R/W	Reset	Description
TMGTXSETTLEM	4:0	RW	01010	Transmit PLL (post Boost) Settling Time Mantissa
TMGTXSETTLEE	7:5	RW	000	Transmit PLL (post Boost) Settling Time Exponent

The Transmit PLL (post Boost) Settling Time is $TMGTXSETTLEM \cdot 2^{TMGTXSETTLEE} \mu s$.

*TMGRXBOOST***Table 169. TMGRXBOOST**

Name	Bits	R/W	Reset	Description
TMGRXBOOSTM	4:0	RW	10010	Receive PLL Boost Time Mantissa
TMGRXBOOSTE	7:5	RW	001	Receive PLL Boost Time Exponent

The Receive PLL Boost Time is $TMGRXBOOSTM \cdot 2^{TMGRXBOOSTE} \mu s$.

*TMGRXSETTLE***Table 170. TMGRXSETTLE**

Name	Bits	R/W	Reset	Description
TMGRXSETTLEM	4:0	RW	10100	Receive PLL (post Boost) Settling Time Mantissa
TMGRXSETTLEE	7:5	RW	000	Receive PLL (post Boost) Settling Time Exponent

The Receive PLL (post Boost) Settling Time is $TMGRXSETTLEM \cdot 2^{TMGRXSETTLEE} \mu s$.

TMGRXOFFSACQ

Table 171. TMGRXOFFSACQ

Name	Bits	R/W	Reset	Description
TMGRXOFFSACQM	4:0	RW	10011	Baseband DC Offset Acquisition Time Mantissa
TMGRXOFFSACQE	7:5	RW	011	Baseband DC Offset Acquisition Time Exponent

The Baseband DC Offset Acquisition Time is $TMGRXOFFSACQM \cdot 2^{TMGRXOFFSACQE} \mu s$.

TMGRXCOARSEAGC

Table 172. TMGRXCOARSEAGC

Name	Bits	R/W	Reset	Description
TMGRXCOARSEAGCM	4:0	RW	11001	Receive Coarse AGC Time Mantissa
TMGRXCOARSEAGCE	7:5	RW	001	Receive Coarse AGC Time Exponent

The Receive Coarse AGC Time is $TMGRXCOARSEAGCM \cdot 2^{TMGRXCOARSEAGCE} \mu s$.

TMGRXAGC

Table 173. TMGRXAGC

Name	Bits	R/W	Reset	Description
TMGRXAGCM	4:0	RW	00000	Receiver AGC Settling Time Mantissa
TMGRXAGCE	7:5	RW	000	Receiver AGC Settling Time Exponent

The Receiver AGC Settling Time is $TMGRXAGCM \cdot 2^{TMGRXAGCE}$. Whether this time is measured in Bits or μs is determined by bit RXAGC CLK in register PKTMISCFLAGS.

TMGRXRSSI

Table 174. TMGRXRSSI

Name	Bits	R/W	Reset	Description
TMGRXRSSIM	4:0	RW	00000	Receiver RSSI Settling Time Mantissa
TMGRXRSSIE	7:5	RW	000	Receiver RSSI Settling Time Exponent

The Receiver RSSI Settling Time is $TMGRXRSSIM \cdot 2^{TMGRXRSSIE}$. Whether this time is measured in Bits or μs is determined by bit RXRSSI CLK in register PKTMISCFLAGS.

TMGRXPREAMBLE1

Table 175. TMGRXPREAMBLE1

Name	Bits	R/W	Reset	Description
TMGRXPREAMBLE1M	4:0	RW	00000	Receiver Preamble 1 Timeout Mantissa
TMGRXPREAMBLE1E	7:5	RW	000	Receiver Preamble 1 Timeout Exponent

The Receiver Preamble 1 Timeout is $TMGRXPREAMBLE1M \cdot 2^{TMGRXPREAMBLE1E}$ Bits.

TMGRXPREAMBLE2

Table 176. TMGRXPREAMBLE2

Name	Bits	R/W	Reset	Description
TMGRXPREAMBLE2M	4:0	RW	00000	Receiver Preamble 2 Timeout Mantissa
TMGRXPREAMBLE2E	7:5	RW	000	Receiver Preamble 2 Timeout Exponent

The Receiver Preamble 2 Timeout is $TMGRXPREAMBLE2M \cdot 2^{TMGRXPREAMBLE2E}$ Bits.

TMGRXPREAMBLE3

Table 177. TMGRXPREAMBLE3

Name	Bits	R/W	Reset	Description
TMGRXPREAMBLE3M	4:0	RW	00000	Receiver Preamble 3 Timeout Mantissa
TMGRXPREAMBLE3E	7:5	RW	000	Receiver Preamble 3 Timeout Exponent

The Receiver Preamble 3 Timeout is $TMGRXPREAMBLE3M \cdot 2^{TMGRXPREAMBLE3E}$ Bits.

RSSIREFERENCE

Table 178. RSSIREFERENCE

Name	Bits	R/W	Reset	Description
RSSIREFERENCE	7:0	RW	0x00	RSSI Offset

This register adds a constant offset to the computed RSSI value. It is used to compensate for board effects.

RSSIABSTHR

Table 179. RSSIABSTHR

Name	Bits	R/W	Reset	Description
RSSIABSTHR	7:0	RW	0x00	RSSI Absolute Threshold

RSSI levels above this threshold indicate a busy channel.

BGNDRSSIGAIN

Table 180. BGNDRSSIGAIN

Name	Bits	R/W	Reset	Description
BGNDRSSIGAIN	3:0	RW	0000	Background RSSI Averaging Time Constant

The background RSSI estimate BGNDRSSI is updated after antenna RSSI measurement. Antenna RSSI measurement is performed in state RSSI in the Receiver Timing Diagram Figure 12. The background RSSI estimate is updated only once if antenna selection is performed.

The update is performed as follows:
 $BGNDRSSI = BGNDRSSI + (RSSI - BGNDRSSI) \cdot 2^{-BGNDRSSIGAIN}$

BGNDRSSITHR

Table 181. BGNDRSSITHR

Name	Bits	R/W	Reset	Description
BGNDRSSITHR	5:0	RW	000000	Background RSSI Relative Threshold

AND9347/D

RSSI levels more than BGNDRSSITHR above the background RSSI level indicate a busy channel.

PKTCHUNKSIZE

Table 182. PKTCHUNKSIZE

Name	Bits	R/W	Reset	Description
PKTCHUNKSIZE	3:0	RW	0000	Maximum Packet Chunk Size, See Table 183

Table 183. PKTCHUNKSIZE BIT VALUES

Bits	Meaning
0000	invalid
0001	1
0010	2
0011	4
0100	8
0101	16
0110	32
0111	64
1000	96
1001	128
1010	160
1011	192
1100	224
1101	240
1110	invalid
1111	invalid

The PKTCHUNKSIZE limits the maximum chunk size in the FIFO. This number includes the flags byte and all data bytes, but not the chunk header and the chunk length byte. Packets larger than PKTCHUNKSIZE - 1 are split into multiple chunks.

PKTMISCFLAGS

Table 184. PKTMISCFLAGS

Name	Bits	R/W	Reset	Description
RXRSSI CLK	0	RW	0	Clock source for RSSI settling timeout: 0 = 1 μ s, 1 = Bit clock
RXAGC CLK	1	RW	0	Clock source for AGC settling timeout: 0 = 1 μ s, 1 = Bit clock
BGND RSSI	2	RW	0	If 1, enable the calculation of the background noise/RSSI level
AGC SETTLE DET	3	RW	0	If 1, if AGC settling is detected, terminate settling before timeout
WOR MULTI PKT	4	RW	0	If 1, the receiver continues to be on after a packet is received in wake-on-radio mode; otherwise, it is shut down

PKTSTOREFLAGS

Table 185. PKTSTOREFLAGS

Name	Bits	R/W	Reset	Description
ST TIMER	0	RW	0	Store Timer value when a delimiter is detected
ST FOFFS	1	RW	0	Store Frequency offset at end of packet
ST RFOFFS	2	RW	0	Store RF Frequency offset at end of packet
ST DR	3	RW	0	Store Datarate offset at end of packet
ST RSSI	4	RW	0	Store RSSI at end of packet

Table 185. PKTSTOREFLAGS (continued)

Name	Bits	R/W	Reset	Description
ST CRCB	5	RW	0	Store CRC Bytes. Normally, CRC bytes are discarded after checking. In HDLC [1] mode, CRC bytes are always stored, regardless of this bit.
ST ANT RSSI	6	RW	0	Store RSSI and Background Noise Estimate at antenna selection time

PKTACCEPTFLAGS

Table 186. PKTACCEPTFLAGS

Name	Bits	R/W	Reset	Description
ACCPT RESIDUE	0	RW	0	Accept Packets with a nonintegral number of Bytes (HDLC [1] only)
ACCPT ABRT	1	RW	0	Accept aborted Packets
ACCPT CRCF	2	RW	0	Accept Packets that fail CRC check
ACCPT ADDRf	3	RW	0	Accept Packets that fail Address check
ACCPT SZF	4	RW	0	Accept Packets that are too long
ACCPT LRGP	5	RW	0	Accept Packets that span multiple FIFO chunks

General Purpose ADC

GPADCCTRL

Table 187. GPADCCTRL

Name	Bits	R/W	Reset	Description
CH ISOL	0	RW	0	Isolate Channels by sampling common mode between channels
CONT	1	RW	0	Enable Continuous Sampling (period according to GPADCPERIOD)
GPADC13	2	RW	0	Enable Sampling GPADC1–GPADC3
BUSY	7	RS	0	Conversion ongoing when 1; when writing 1, a single conversion is started

GPADCPERIOD

Table 188. GPADCPERIOD

Name	Bits	R/W	Reset	Description
GPADCPERIOD	7:0	RW	00111111	GPADC Sampling Period, $f_{SR} = \frac{f_{XTAL}}{32 \times GPADCPERIOD}$

GPADC13VALUE1, GPADC13VALUE0

Table 189. GPADC13VALUE1, GPADC13VALUE0

Name	Bits	R/W	Reset	Description
GPADC13VALUE	9:0	R	– –	GPADC13 Value

Reading this register clears the GPADC Interrupt.

Low Power Oscillator Calibration

LPOSCCONFIG

Table 190. LPOSCCONFIG

Name	Bits	R/W	Reset	Description
LPOSC ENA	0	RW	0	Enable the Low Power Oscillator. If 0, it is disabled.
LPOSC FAST	1	RW	0	Select the Frequency of the Low Power Oscillator. 0 = 640 Hz, 1 = 10.24 kHz
LPOSC IRQR	2	RW	0	Enable LP Oscillator Interrupt on the Rising Edge
LPOSC IRQF	3	RW	0	Enable LP Oscillator Interrupt on the Falling Edge
LPOSC CALIBF	4	RW	0	Enable LP Oscillator Calibration on the Falling Edge
LPOSC CALIBR	5	RW	0	Enable LP Oscillator Calibration on the Rising Edge
LPOSC OSC DOUBLE	6	RW	0	Enable LP Oscillator Calibration Reference Oscillator Doubling
LPOSC OSC INVERT	7	RW	0	Invert LP Oscillator Clock

LPOSCSTATUS

Table 191. LPOSCSTATUS

Name	Bits	R/W	Reset	Description
LPOSC EDGE	0	R	–	Enabled Low Power Oscillator Edge detected
LPOSC IRQ	1	R	–	Low Power Oscillator Interrupt Active

The EDGE and IRQ flags can be cleared by reading either the LPOSCCONFIG, LPOSCSTATUS, LPOSCPER1 or LPOSCPER0 register.

LPOSCKFILT1, LPOSCKFILT0

Table 192. LPOSCKFILT1, LPOSCKFILT0

Name	Bits	R/W	Reset	Description
LPOSCKFILT	15:0	RW	0x20C4	k _{FILT} (Low Power Oscillator Calibration Filter Constant)

The maximum value of k_{FILT}, that results in quickest calibration (single cycle), but no jitter suppression, is:

$$k_{FILT} = \left\lceil \frac{21333\text{Hz} \times 2^{20}}{f_{XTAL}} \right\rceil$$

Smaller values of k_{FILT} result in longer calibration, but increased jitter suppression.

LPOSCREF1, LPOSCREF0

Table 193. LPOSCREF1, LPOSCREF0

Name	Bits	R/W	Reset	Description
LPOSCREF	15:0	RW	0x61A8	LP Oscillator Reference Frequency Divider; set to $\frac{f_{XTAL}}{640\text{ Hz}}$

LPOSCFREQ1, LPOSCFREQ0

Table 194. LPOSCFREQ1, LPOSCFREQ0

Name	Bits	R/W	Reset	Description
LPOSCFREQ	9:-2	RW	0x000	LP Oscillator Frequency Tune Value; in 1/32 %.

LPOSCPER1, LPOSCPER0

Table 195. LPOSCPER1, LPOSCPER0

Name	Bits	R/W	Reset	Description
LPOSCPER	15:0	R	–	Last measured LP Oscillator Period

DAC

DACVALUE1, DACVALUE0

Table 196. DACVALUE1, DACVALUE0

Name	Bits	R/W	Reset	Description
DACVALUE	11:0	RW	0x000	DAC Value (signed) (if DACINPUT = 0000)
DACSHIFT	3:0	RW	0x0	DAC Input Shift (if DACINPUT != 0000)

DACCONFIG

Table 197. DACCONFIG

Name	Bits	R/W	Reset	Description
DACINPUT	3:0	RW	0000	DAC Input Multiplexer, See Table 198
DACCLKX2	6	RW	0	Enable DAC Clock Doubler if set to 1
DACPWM	7	RW	0	Select PWM mode if 1, otherwise $\Sigma\Delta$ mode

Table 198. DACINPUT BIT VALUES

Bits	Meaning
0000	DACVALUER
0001	TRKAMPLITUDE
0010	TRKRFFREQUENCY
0011	TRKFREQUENCY
0100	FSKDEMOD
0101	AFSKDEMOD
0110	RXSOFTDATA
0111	RSSI
1000	SAMPLE_ROT_I
1001	SAMPLE_ROT_Q
1100	GPADC13
1101	invalid
1110	invalid
1111	invalid

Note that in $\Sigma\Delta$ mode, the output range is limited to the range $\frac{1}{4} \dots \frac{3}{4} \cdot VDDIO$, to ensure modulator stability. The input value -2^{11} results in $\frac{1}{4} \cdot VDDIO$, the input value $2^{11} - 1$ results in $\frac{3}{4} \cdot VDDIO$. In PWM mode, the output voltage range is $0 \dots VDDIO$.

Performance Tuning Registers

Registers with Addresses from 0xF00 to 0xFFF are performance tuning registers. Their optimum values are computed by AX_RadioLab; this section only gives a rough overview of how they should be set. Do not read or write addresses not listed in the table below.

Table 199. REGISTER MAP

Addr	RX/TX	Description
F00	RX/TX	Set to 0x0F
F0C	RX/TX	Keep the default 0x00
F0D	RX/TX	Set to 0x03
F10	RX/TX	Set to 0x04 if a TCXO is used. If a crystal is used, set to 0x0D if the reference frequency (crystal or TCXO) is more than 43 MHz, or to 0x03 otherwise
F11	RX/TX	Set to 0x07 if a crystal is connected to CLK16P/CLK16N, or 0x00 if a TCXO is used
F1C	RX/TX	Set to 0x07
F21	RX	Set to 0x5C
F22	RX	Set to 0x53
F23	RX	Set to 0x76
F26	RX	Set to 0x92

AND9347/D

Table 199. REGISTER MAP (continued)

Addr	RX/TX	Description
F30	RX	This register should be reset between WOR wake-ups. The reset value is the value read after successful packet reception or 0x3F if no packet has been received yet.
F31	RX	This register should be reset between WOR wake-ups. The reset value is the value read after successful packet reception or 0xF0 if no packet has been received yet.
F32	RX	This register should be reset between WOR wake-ups. The reset value is the value read after successful packet reception or 0x3F if no packet has been received yet.
F33	RX	This register should be reset between WOR wake-ups. The reset value is the value read after successful packet reception or 0xF0 if no packet has been received yet.
F34	RX/TX	Set to 0x28 if RFDIV in register PLLVCODIV is set, or to 0x08 otherwise
F35	RX/TX	Set to 0x10 for reference frequencies (crystal or TCXO) less than 24.8 MHz ($f_{XTALDIV} = 1$), or to 0x11 otherwise ($f_{XTALDIV} = 2$)
F44	RX/TX	Set to 0x24
F72	RX	Set to 0x06 if the framing mode is set to "Raw, Soft Bits" (register FRAMING), or to 0x00 otherwise

REFERENCES

- [1] Wikipedia. High-Level Data Link Control. see <http://en.wikipedia.org/wiki/HDLC>.
- [2] ON Semiconductor. AX5043 Datasheet. see <http://www.onsemi.com>
- [3] Ross N. Williams. A Painless Guide to CRC Error Detection Algorithms. http://www.ross.net/crc/download/crc_v3.txt

ON Semiconductor and  are trademarks of Semiconductor Components Industries, LLC dba ON Semiconductor or its subsidiaries in the United States and/or other countries. ON Semiconductor owns the rights to a number of patents, trademarks, copyrights, trade secrets, and other intellectual property. A listing of ON Semiconductor's product/patent coverage may be accessed at www.onsemi.com/site/pdf/Patent-Marking.pdf. ON Semiconductor reserves the right to make changes without further notice to any products herein. ON Semiconductor makes no warranty, representation or guarantee regarding the suitability of its products for any particular purpose, nor does ON Semiconductor assume any liability arising out of the application or use of any product or circuit, and specifically disclaims any and all liability, including without limitation special, consequential or incidental damages. Buyer is responsible for its products and applications using ON Semiconductor products, including compliance with all laws, regulations and safety requirements or standards, regardless of any support or applications information provided by ON Semiconductor. "Typical" parameters which may be provided in ON Semiconductor data sheets and/or specifications can and do vary in different applications and actual performance may vary over time. All operating parameters, including "Typicals" must be validated for each customer application by customer's technical experts. ON Semiconductor does not convey any license under its patent rights nor the rights of others. ON Semiconductor products are not designed, intended, or authorized for use as a critical component in life support systems or any FDA Class 3 medical devices or medical devices with a same or similar classification in a foreign jurisdiction or any devices intended for implantation in the human body. Should Buyer purchase or use ON Semiconductor products for any such unintended or unauthorized application, Buyer shall indemnify and hold ON Semiconductor and its officers, employees, subsidiaries, affiliates, and distributors harmless against all claims, costs, damages, and expenses, and reasonable attorney fees arising out of, directly or indirectly, any claim of personal injury or death associated with such unintended or unauthorized use, even if such claim alleges that ON Semiconductor was negligent regarding the design or manufacture of the part. ON Semiconductor is an Equal Opportunity/Affirmative Action Employer. This literature is subject to all applicable copyright laws and is not for resale in any manner.

PUBLICATION ORDERING INFORMATION

LITERATURE FULFILLMENT:

Literature Distribution Center for ON Semiconductor
19521 E. 32nd Pkwy, Aurora, Colorado 80011 USA
Phone: 303-675-2175 or 800-344-3860 Toll Free USA/Canada
Fax: 303-675-2176 or 800-344-3867 Toll Free USA/Canada
Email: orderlit@onsemi.com

N. American Technical Support: 800-282-9855 Toll Free
USA/Canada
Europe, Middle East and Africa Technical Support:
Phone: 421 33 790 2910
Japan Customer Focus Center
Phone: 81-3-5817-1050

ON Semiconductor Website: www.onsemi.com
Order Literature: <http://www.onsemi.com/orderlit>
For additional information, please contact your local
Sales Representative

RF Warning Statement

To comply with FCC RF exposure compliance requirements, the antennas used for this transmitter must be installed to provide a separation distance of at least 20 cm from all persons and must not be co-located or operating in conjunction with any other antenna or transmitter. This device is intended only for OEM integrators under the following conditions:

- 1) The antenna must be installed such that 20 cm is maintained between the antenna and users, and
- 2) The transmitter module may not be co-located with any other transmitter or antenna.

As long as two conditions above are met, further transmitter test will not be required as something related to RF exposure. However, the OEM integrator is still responsible for testing their end-product for any additional compliance requirements required with this module installed. To ensure compliance with all non-transmitter functions the host manufacturer is responsible for ensuring compliance with the module(s) installed and fully operational. For example, if a host was previously authorized as an unintentional radiator under the Declaration of Conformity procedure without a transmitter certified module and a module is added, the host manufacturer is responsible for ensuring that after the module is installed and operational the host continues to be compliant with the Part 15B unintentional radiator requirements.

The module is limited to OEM installation ONLY. The module is limited to installation in mobile or fixed application. We hereby acknowledge our responsibility to provide guidance to the host manufacturer in the event that they require assistance for ensuring compliance with the Part 15 Subpart B requirements.

End Product Labeling

This transmitter module is authorized only for use in device where the antenna may be installed such that 20 cm may be maintained between the antenna and users. The final end product must be labeled in a visible area with the following: "Contains FCC ID: R2ZEC5X43S". The grantee's FCC ID and IC Number can be used only when all FCC and ISED compliance requirements are met. The following FCC part 15.19 statement has to also be available on the label: This device complies with Part 15 of FCC rules. Operation is subject to the following two conditions:

- (1) this device may not cause harmful interference and
- (2) this device must accept any interference received, including interference that may cause undesired operation.

Manual Information to the End User

The OEM integrator has to be aware not to provide information to the end user regarding how to install or remove this RF module in the user's manual of the end product which integrates this module. In the user manual of the end product, the end user has to be informed that the equipment complies with FCC radio-frequency exposure guidelines set forth for an uncontrolled environment. The end user has to also be informed that any changes or modifications not expressly approved by the manufacturer could void the user's authority to operate this equipment. The end user manual shall include all required regulatory information/warning as show in this manual.

This device complies with Part 15 of the FCC Rules and with RSS-210 of Industry Canada. Operation is subject to the following two conditions:

- (1) This device may not cause harmful interference, and
- (2) this device must accept any interference received, including interference that may cause undesired operation.

Le présent appareil est conforme aux CNR d'Industrie Canada applicables aux appareils radio exempts de licence. L'exploitation est autorisée aux deux conditions suivantes :

- (1) l'appareil ne doit pas produire de brouillage, et
- (2) l'utilisateur de l'appareil doit accepter tout brouillage radioélectrique subi, même si le brouillage est susceptible d'en compromettre le fonctionnement.

Radiation Exposure Statement:

This equipment complies with IC radiation exposure limits set forth for an uncontrolled environment. This equipment should be installed and operated with minimum distance 20cm between the radiator & your body