



# SPORTON International Inc.

No. 52, Hwa Ya 1st Rd., Kwei-Shan Hsiang, TaoYuan Hsien, Taiwan, R.O.C.  
Ph: 886-3-327-3456 / FAX: 886-3-327-0973 / www.sporton.com.tw

## FCC RADIO TEST REPORT

Applicant's company	<b>Trapeze Networks</b>
Applicant Address	5753 W. Las Positas Blvd. Pleasanton, CA 94588
FCC ID	<b>QZE520</b>
Manufacturer's company	<b>Accton Technology Corporation</b>
Manufacturer Address	No. 1 Creation Rd., III, Science-based Industrial Park, Hsinchu 300, Taiwan, R.O.C.

Product Name	Enterprise Access Point
Brand Name	Trapeze Networks
Model Name	520 / MP-522 / MP-522E
Test Rule Part(s)	47 CFR FCC Part 15 Subpart E § 15.407
Test Freq. Range	5150 ~ 5250MHz
Received Date	Mar. 30, 2010
Final Test Date	Jul. 14, 2010
Submission Type	Original Equipment
Operating Mode	Master
Multiple Listing	Please refer to section 3.7



### Statement

**Test result included is for the IEEE 802.11n and IEEE 802.11a (5150 ~ 5250MHz) of the product.**

The test result in this report refers exclusively to the presented test model / sample.

Without written approval of SPORTON International Inc., the test report shall not be reproduced except in full.

The measurements and test results shown in this test report were made in accordance with the procedures and found in compliance with the limit given in **ANSI C63.4-2003** and **47 CFR FCC Part 15 Subpart E**.

The test equipment used to perform the test is calibrated and traceable to NML/ROC.



## Table of Contents

<b>1. CERTIFICATE OF COMPLIANCE</b> .....	<b>1</b>
<b>2. SUMMARY OF THE TEST RESULT</b> .....	<b>2</b>
<b>3. GENERAL INFORMATION</b> .....	<b>3</b>
3.1. Product Details .....	3
3.2. Accessories .....	5
3.3. Table for Filed Antenna .....	6
3.4. Table for Carrier Frequencies .....	7
3.5. Table for Test Modes .....	8
3.6. Table for Testing Locations.....	9
3.7. Table for Multiple Listing .....	9
3.8. Table for Supporting Units .....	9
3.9. Table for Parameters of Test Software Setting .....	10
3.10. Test Configurations.....	13
<b>4. TEST RESULT</b> .....	<b>21</b>
4.1. AC Power Line Conducted Emissions Measurement .....	21
4.2. 99% Occupied Bandwidth Measurement.....	25
4.3. Maximum Conducted Output Power Measurement.....	56
4.4. Power Spectral Density Measurement.....	85
4.5. Peak Excursion Measurement .....	105
4.6. Radiated Emissions Measurement.....	125
4.7. Band Edge Emissions Measurement.....	173
4.8. Frequency Stability Measurement.....	189
4.9. Antenna Requirements .....	195
<b>5. LIST OF MEASURING EQUIPMENTS</b> .....	<b>196</b>
<b>6. TEST LOCATION</b> .....	<b>198</b>
<b>7. TAF CERTIFICATE OF ACCREDITATION</b> .....	<b>199</b>
<b>APPENDIX A. PHOTOGRAPHS OF EUT</b> .....	<b>A1 ~ A44</b>
<b>APPENDIX B. TEST PHOTOS</b> .....	<b>B1 ~ B11</b>
<b>APPENDIX C. MAXIMUM PERMISSIBLE EXPOSURE</b> .....	<b>C1 ~ C7</b>
<b>APPENDIX D. CO-LOCATION</b> .....	<b>D1 ~ D5</b>
<b>APPENDIX E. EXTERNAL ANTENNA LIST</b>	



### History of This Test Report

Original Issue Date: Jun. 15, 2010

Report No.: FR040302AA

- No additional attachment.
- Additional attachment were issued as following record:

Attachment No.	Issue Date	Description

## 1. CERTIFICATE OF COMPLIANCE

**Product Name** : Enterprise Access Point  
**Brand Name** : Trapeze Networks  
**Model Name** : 520 / MP-522 / MP-522E  
**Applicant** : Trapeze Networks  
**Test Rule Part(s)** : 47 CFR FCC Part 15 Subpart E § 15.407

Sporton International as requested by the applicant to evaluate the EMC performance of the product sample received on Mar. 30, 2010 would like to declare that the tested sample has been evaluated and found to be in compliance with the tested rule parts. The data recorded as well as the test configuration specified is true and accurate for showing the sample's EMC nature.

*Leo Huang 2010.7.15*

**Leo Huang / Manager**

**SPORTON INTERNATIONAL INC.**

## 2. SUMMARY OF THE TEST RESULT

Applied Standard: 47 CFR FCC Part 15 Subpart E				
Part	Rule Section	Description of Test	Result	Under Limit
4.1	15.207	AC Power Line Conducted Emissions	Complies	5.12 dB
4.2	15.407(a)	26dB Spectrum Bandwidth	Complies	-
4.3	15.407(a)	Maximum Conducted Output Power	Complies	0.00 dB
4.4	15.407(a)	Power Spectral Density	Complies	0.01 dB
4.5	15.407(a)	Peak Excursion	Complies	1.08 dB
4.6	15.407(b)	Radiated Emissions below 1GHz	Complies	Mode 1: 2.02 dB
				Mode 5: 3.29 dB
4.6	15.407(b)	Radiated Emissions above 1GHz	Complies	20.69 dB
4.7	15.407(b)	Band Edge Emissions	Complies	0.03 dB
4.8	15.407(g)	Frequency Stability	Complies	-
4.9	15.203	Antenna Requirements	Complies	-

Note: Due to the EUT is powered from POE, and the POE will not sell with EUT.

Test Items	Uncertainty	Remark
AC Power Line Conducted Emissions	±2.3dB	Confidence levels of 95%
Maximum Conducted Output Power	±0.5dB	Confidence levels of 95%
Power Spectral Density	±0.5dB	Confidence levels of 95%
Peak Excursion	±0.5dB	Confidence levels of 95%
26dB Spectrum Bandwidth / Frequency Stability	±8.5×10 <sup>-8</sup>	Confidence levels of 95%
Radiated Emissions (9kHz~30MHz)	±0.8dB	Confidence levels of 95%
Radiated Emissions (30MHz~1000MHz)	±1.9dB	Confidence levels of 95%
Radiated / Band Edge Emissions (1GHz~18GHz)	±1.9dB	Confidence levels of 95%
Radiated Emissions (18GHz~40GHz)	±1.9dB	Confidence levels of 95%
Temperature	±0.7°C	Confidence levels of 95%
Humidity	±3.2%	Confidence levels of 95%
DC / AC Power Source	±1.4%	Confidence levels of 95%

### 3. GENERAL INFORMATION

#### 3.1. Product Details

##### IEEE 802.11n

Items	Description
Product Type	WLAN (2TX, 2RX)
Radio Type	Intentional Transceiver
Power Type	From POE
Modulation	see the below table for IEEE 802.11n
Data Modulation	OFDM (BPSK / QPSK / 16QAM / 64QAM)
Data Rate (Mbps)	see the below table for IEEE 802.11n
Frequency Range	5150 ~ 5250MHz
Channel Number	4 for 20MHz bandwidth ; 2 for 40MHz bandwidth
Channel Band Width (99%)	For Ant. 1: MCS8 (20MHz): 18.40 MHz ; MCS8 (40MHz): 36.64 MHz For Ant. 2: MCS8 (20MHz): 18.40 MHz ; MCS8 (40MHz): 36.64 MHz For Ant. 3: MCS8 (20MHz): 18.40 MHz ; MCS8 (40MHz): 36.48 MHz For Ant. 4: MCS8 (20MHz): 18.24 MHz ; MCS8 (40MHz): 36.64 MHz For Ant. 6: MCS8 (20MHz): 18.40 MHz ; MCS8 (40MHz): 36.48 MHz
Conducted Output Power	For Ant. 1: Band 1: MCS8 (20MHz): 16.97 dBm ; MCS8 (40MHz): 16.73 dBm For Ant. 2: Band 1: MCS8 (20MHz): 16.94 dBm ; MCS8 (40MHz): 16.55 dBm For Ant. 3: Band 1: MCS8 (20MHz): 14.03 dBm ; MCS8 (40MHz): 13.94 dBm For Ant. 4: Band 1: MCS8 (20MHz): 11.21 dBm ; MCS8 (40MHz): 11.24 dBm For Ant. 6: Band 1: MCS8 (20MHz): 16.52 dBm ; MCS8 (40MHz): 16.79 dBm

**IEEE 802.11a**

Items	Description
Product Type	WLAN (2TX, 2RX)
Radio Type	Intentional Transceiver
Power Type	From POE
Modulation	OFDM for IEEE 802.11a
Data Modulation	OFDM (BPSK / QPSK / 16QAM / 64QAM)
Data Rate (Mbps)	OFDM (6/9/12/18/24/36/48/54)
Frequency Range	5150 ~ 5250MHz
Channel Number	4
Channel Band Width (99%)	For Ant. 1: 17.44 MHz For Ant. 2: 17.44 MHz For Ant. 3: 17.44 MHz For Ant. 4: 17.28 MHz For Ant. 6: 17.44 MHz
Conducted Output Power	For Ant. 1: 16.88 dBm For Ant. 2: 16.87 dBm For Ant. 3: 13.97 dBm For Ant. 4: 11.13 dBm For Ant. 6: 16.77 dBm

**Antenna & Band width**

Antenna	Single (TX)		Two (TX)	
	20 MHz	40 MHz	20 MHz	40 MHz
IEEE 802.11a	X	X	V	X
IEEE 802.11n	X	X	V	V

## IEEE 802.11n spec

MCS Index	Nss	Modulation	R	NBPS	NCBPS		NDBPS		Datarate(Mbps)			
					20MHz	40MHz	20MHz	40MHz	800nsGI		400nsGI	
									20MHz	40MHz	20MHz	40MHz
0	1	BPSK	1/2	1	52	108	26	54	6.5	13.5	7.200	15
1	1	QPSK	1/2	2	104	216	52	108	13.0	27.0	14.400	30
2	1	QPSK	3/4	2	104	216	78	162	19.5	40.5	21.700	45
3	1	16-QAM	1/2	4	208	432	104	216	26.0	54.0	28.900	60
4	1	16-QAM	3/4	4	208	432	156	324	39.0	81.0	43.300	90
5	1	64-QAM	2/3	6	312	648	208	432	52.0	108.0	57.800	120
6	1	64-QAM	3/4	6	312	648	234	486	58.5	121.5	65.000	135
7	1	64-QAM	5/6	6	312	648	260	540	65.0	135.0	72.200	150
8	2	BPSK	1/2	1	104	216	52	108	13.0	27.0	14.444	30
9	2	QPSK	1/2	2	208	432	104	216	26.0	54.0	28.889	60
10	2	QPSK	3/4	2	208	432	156	324	39.0	81.0	43.333	90
11	2	16-QAM	1/2	4	416	864	208	432	52.0	108.0	57.778	120
12	2	16-QAM	3/4	4	416	864	312	648	78.0	162.0	86.667	180
13	2	64-QAM	2/3	6	624	1296	416	864	104.0	216.0	115.556	240
14	2	64-QAM	3/4	6	624	1296	468	972	117.0	243.0	130.000	270
15	2	64-QAM	5/6	6	624	1296	520	1080	130.0	270.0	144.444	300

Symbol	Explanation
NSS	Number of spatial streams
R	Code rate
NBPS	Number of coded bits per single carrier
NCBPS	Number of coded bits per symbol
NDBPS	Number of data bits per symbol
GI	guard interval

### 3.2. Accessories

N/A



### 3.3. Table for Filed Antenna

Ant.	Brand	Model Name	Model Name of User's guide	Antenna Type	Connector	Gain (dBi)	
						2.4GHz	5GHz
1	Speed Co. Ltd.	F-0G-EY-0001-000-WC	N/A	Loop Antenna	I-PEX	2.4GHz	3.6
						5GHz	6.0
2	Long Cheng Tech. Int'l Co., Ltd.	FDE_ACBSMA-BGP	ANT-7360P-IN	Dipole Antenna	RP-SMA Plug	2.4GHz	3.0
						5GHz	5.0
3	Laird Technologies	S24517PT	ANT-77555-OUT	Dual-Band MIMO Sector Antenna	Reverse SMA (3x)	2.4GHz	8.0
						5GHz	10.7
4	Laird Technologies	S245112PT	ANT-74520-OUT	Dual-Band MIMO Directional Antenna	Reverse SMA (3x)	2.4GHz	10.9
						5GHz	13.5
5	MARS ANTENNAS & RF SYSTEMS LTD.	MA-WA56-DP25N	ANT-5007-OUT	Dual Polarized Antenna	2 x N-Type, Female	5GHz	23.5
6	PCTEL Broadband Technology Group	MMO24580608	ANT-7360A-OUT	Mast Mount Omnidirectional antennas	N-type Jack	2.4GHz	6.0
						5GHz	8.0

Note: The EUT will collect with one internal antenna (Ant. 1) and five external antennas (Ant. 2 ~ Ant. 6).

Ant. 1 / Ant. 2 / Ant. 3 / Ant. 4 / Ant. 6 is used in 2.4GHz / 5GHz Band.

Ant. 5 is only used in Band 2, Band 3 and Band 4 of 5GHz Band.

#### For 5GHz Band:

Connector A1 and Connector A5 can both receive/transmit simultaneously.

#### For 2.4GHz Band:

Connector B2 and Connector B6 can both receive/transmit simultaneously.

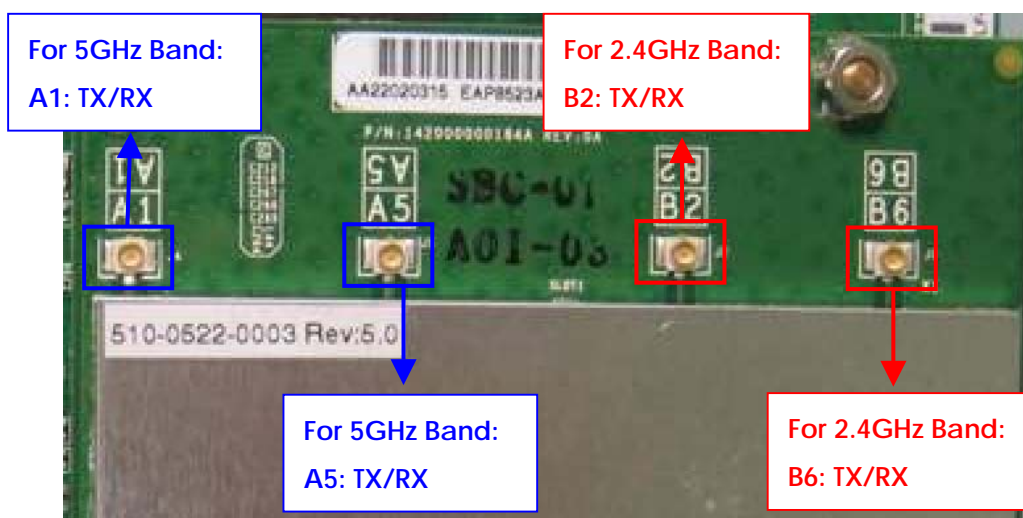

Antenna	Antenna Gain		Cable loss		Test Antenna Gain	
	2.4GHz	5GHz	2.4GHz	5GHz	2.4GHz	5GHz
1	3.6	6.0	-	-	3.6	6.0
2	3.0	5.0	0.92	1.74	2.08	3.26
3	8.0	10.7	0.92	1.74	7.08	8.96
4	10.9	13.5	0.92	1.74	9.98	11.76
5	-	23.5	1.53	3.99	-	19.51
6	6.0	8.0	1.53	3.99	4.47	4.01

### 3.4. Table for Carrier Frequencies

For IEEE 802.11a, use Channel 36, 40, 44, 48.

There are two bandwidth systems for IEEE 802.11n.

For both 20MHz bandwidth systems, use Channel 36, 40, 44, 48.

For both 40MHz bandwidth systems, use Channel 38, 46.

Frequency Band	Channel No.	Frequency	Channel No.	Frequency
5150~5250 MHz Band 1	36	5180 MHz	44	5220 MHz
	38	5190 MHz	46	5230 MHz
	40	5200 MHz	48	5240 MHz

### 3.5. Table for Test Modes

Preliminary tests were performed in different data rate to find the worst radiated emission. The data rate shown in the table below is the worst-case rate with respect to the specific test item. Investigation has been done on all the possible configurations for searching the worst cases. The following table is a list of the test modes shown in this test report.

< For Ant. 1 / Ant. 2 / Ant. 3 / Ant. 4 / Ant. 6 >

Test Items	Mode		Data Rate	Channel	Connector
AC Power Line Conducted Emissions	Normal Link		Auto	-	-
Max. Conducted Output Power	MCS8/20MHz	Band 1	13Mbps	36/40/48	A1/A5/A1+A5
	MCS8/40MHz	Band 1	27Mbps	38/46	A1/A5/A1+A5
	11a/BPSK	Band 1	6Mbps	36/40/48	A1/A5/A1+A5
26dB Spectrum Bandwidth 99% Occupied Bandwidth Measurement Power Spectral Density Peak Excursion	MCS8/20MHz	Band 1	13Mbps	36/40/48	A1+A5
	MCS8/40MHz	Band 1	27Mbps	38/46	A1+A5
	11a/BPSK	Band 1	6Mbps	36/40/48	A1+A5
Radiated Emission Below 1GHz	Normal Link		Auto	-	-
Radiated Emission Above 1GHz	MCS8/20MHz	Band 1	13Mbps	36/40/48	A1+A5
	MCS8/40MHz	Band 1	27Mbps	38/46	A1+A5
	11a/BPSK	Band 1	6Mbps	36/40/48	A1+A5
Band Edge Emission	MCS8/20MHz	Band 1	13Mbps	36/40/48	A1+A5
	MCS8/40MHz	Band 1	27Mbps	38/46	A1+A5
	11a/BPSK	Band 1	6Mbps	36/40/48	A1+A5
Frequency Stability	Un-modulation		-	40	N/A

The following test modes were performed for all tests:

Mode 1. EUT + Ant. 1 (Internal Antenna)

Mode 2. EUT + Ant. 2 (External Antenna)

Mode 3. EUT + Ant. 3 (External Antenna)

Mode 4. EUT + Ant. 4 (External Antenna)

Mode 5. EUT + Ant. 5 (External Antenna)

Mode 6. EUT + Ant. 6 (External Antenna)

**For Conducted Emission test:**

After evaluating, Mode 5 was selected as worse case and recorded the test data in the report.

**For Radiated Emission test below 1GHz:**

After evaluating, Mode 1 and Mode 5 were selected as worse case and recorded the test data in the report.

#### For Radiated Emission test above 1GHz:

All the test results were tested and recorded in the report.

#### For MPE and Co-location Test:

After evaluating, Mode 1 and Mode 2 were selected as worse case and recorded the test data in the report.

The EUT could be applied with wireless LAN function 2.4GHz Band and wireless LAN function 5GHz Band; therefore Maximum Permissible Exposure (please refer to Appendix C) and Co-location (please refer to Appendix D) tests are added for simultaneously transmit between Bluetooth and wireless LAN function.

### 3.6. Table for Testing Locations

Test Site No.	Site Category	Location	FCC Reg. No.	IC File No.	VCCI Reg. No
CO04-HY	Conduction	Hwa Ya	879474	IC 4086	-
03CH03-HY	SAC	Hwa Ya	879474	IC 4086	-
TH01-HY	OVEN Room	Hwa Ya	-	-	-

Open Area Test Site (OATS); Semi Anechoic Chamber (SAC); Fully Anechoic Chamber (FAC).

Please refer section 6 for Test Site Address.

### 3.7. Table for Multiple Listing

The model names in the following table are all refer to the identical product.

Model Name	Description
520	Family model name
MP-522	EUT with internal antenna
MP-522E	EUT with external antenna

### 3.8. Table for Supporting Units

Support Unit	Brand	Model	FCC ID
PoE	PowerDsine	9001G	N/A
Wireless LAN Switch	3COM	MXR100	N/A
Switch	BELKIN	F5D5131-24	N/A
Notebook	DELL	M1330	E2KWM3945ABG
Notebook	DELL	D400	E2K24GBRL
Notebook	DELL	1200	E2K4965AGNM
Notebook	DELL	D505	E2K24GBRL
SWITCH	CNet	CSH-1600E	DoC

### 3.9. Table for Parameters of Test Software Setting

During testing, Channel & Power Controlling Software provided by the customer was used to control the operating channel as well as the output power level. The RF output power selection is for the setting of RF output power expected by the customer and is going to be fixed on the firmware of the final end product.

< For Ant. 1 >

#### Power Parameters of IEEE 802.11n MCS8 20MHz

Test Software Version	ART		
Frequency	5180 MHz	5200 MHz	5240 MHz
MCS8 20MHz	11	10.5	10.5

#### Power Parameters of IEEE 802.11n MCS8 40MHz

Test Software Version	ART	
Frequency	5190 MHz	5230 MHz
MCS8 40MHz	10	10.5

#### Power Parameters of IEEE 802.11a

Test Software Version	ART		
Frequency	5180 MHz	5200 MHz	5240 MHz
IEEE 802.11a	11	11	11.5

< For Ant. 2 >

#### Power Parameters of IEEE 802.11n MCS8 20MHz

Test Software Version	ART		
Frequency	5180 MHz	5200 MHz	5240 MHz
MCS8 20MHz	10.5	11.5	11

#### Power Parameters of IEEE 802.11n MCS8 40MHz

Test Software Version	ART	
Frequency	5190 MHz	5230 MHz
MCS8 40MHz	10.5	10.5

#### Power Parameters of IEEE 802.11a

Test Software Version	ART		
Frequency	5180 MHz	5200 MHz	5240 MHz
IEEE 802.11a	14	14.5	14.5

## &lt; For Ant. 3 &gt;

## Power Parameters of IEEE 802.11n MCS8 20MHz

Test Software Version	ART		
Frequency	5180 MHz	5200 MHz	5240 MHz
MCS8 20MHz	9	9	9

## Power Parameters of IEEE 802.11n MCS8 40MHz

Test Software Version	ART	
Frequency	5190 MHz	5230 MHz
MCS8 40MHz	8	8.5

## Power Parameters of IEEE 802.11a

Test Software Version	ART		
Frequency	5180 MHz	5200 MHz	5240 MHz
IEEE 802.11a	9.5	9	9.5

## &lt; For Ant. 4 &gt;

## Power Parameters of IEEE 802.11n MCS8 20MHz

Test Software Version	ART		
Frequency	5180 MHz	5200 MHz	5240 MHz
MCS8 20MHz	5	5.5	5.5

## Power Parameters of IEEE 802.11n MCS8 40MHz

Test Software Version	ART	
Frequency	5190 MHz	5230 MHz
MCS8 40MHz	3	5

## Power Parameters of IEEE 802.11a

Test Software Version	ART		
Frequency	5180 MHz	5200 MHz	5240 MHz
IEEE 802.11a	5.5	5.5	5.5

< For Ant. 6 >

**Power Parameters of IEEE 802.11n MCS8 20MHz**

Test Software Version	ART		
Frequency	5180 MHz	5200 MHz	5240 MHz
MCS8 20MHz	10.5	10.5	10.5

**Power Parameters of IEEE 802.11n MCS8 40MHz**

Test Software Version	ART	
Frequency	5190 MHz	5230 MHz
MCS8 40MHz	8	11

**Power Parameters of IEEE 802.11a**

Test Software Version	ART		
Frequency	5180 MHz	5200 MHz	5240 MHz
IEEE 802.11a	10.5	10.5	10.5

During the test, "ART" under WIN XP was executed to control the EUT continuously transmit RF signal.

### 3.10. Test Configurations

#### 3.10.1. AC Power Line Conducted Emissions Test Configuration

< For Ant. 5 >

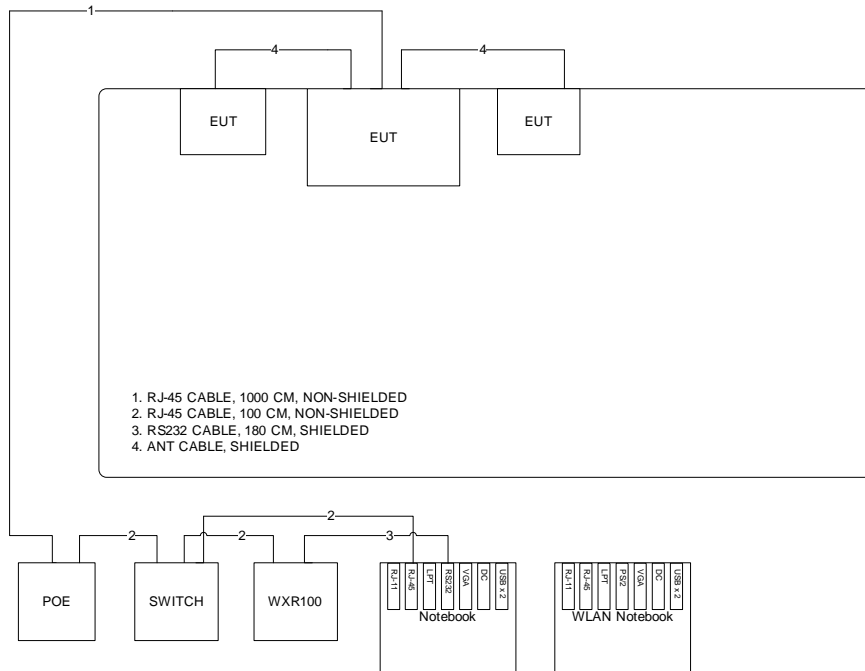



### 3.10.2. Radiation Emissions Test Configuration

< For Ant. 1 >

< For WLAN Function >

Test Configuration: 9KHz~1GHz

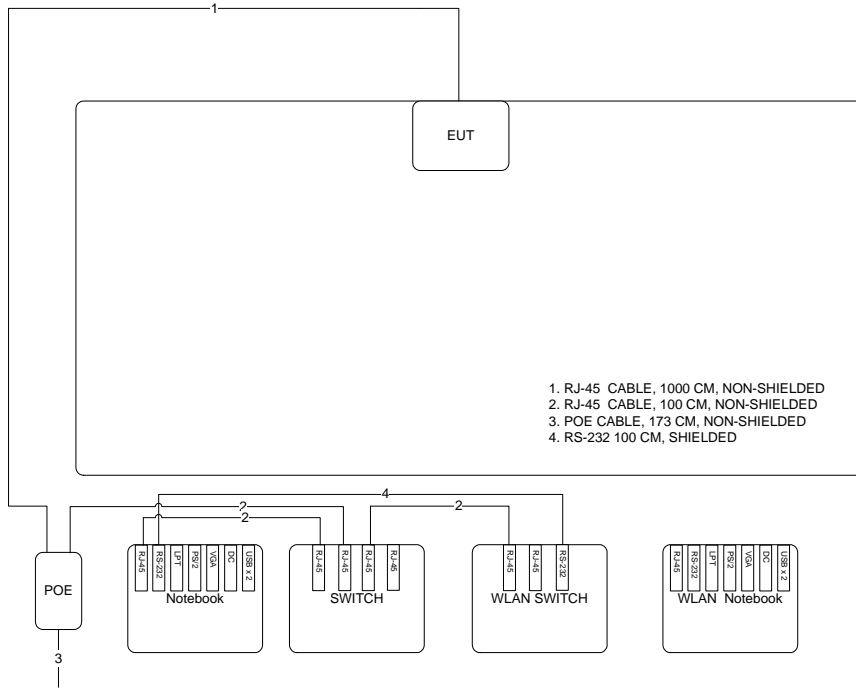

Test Configuration: above 1GHz

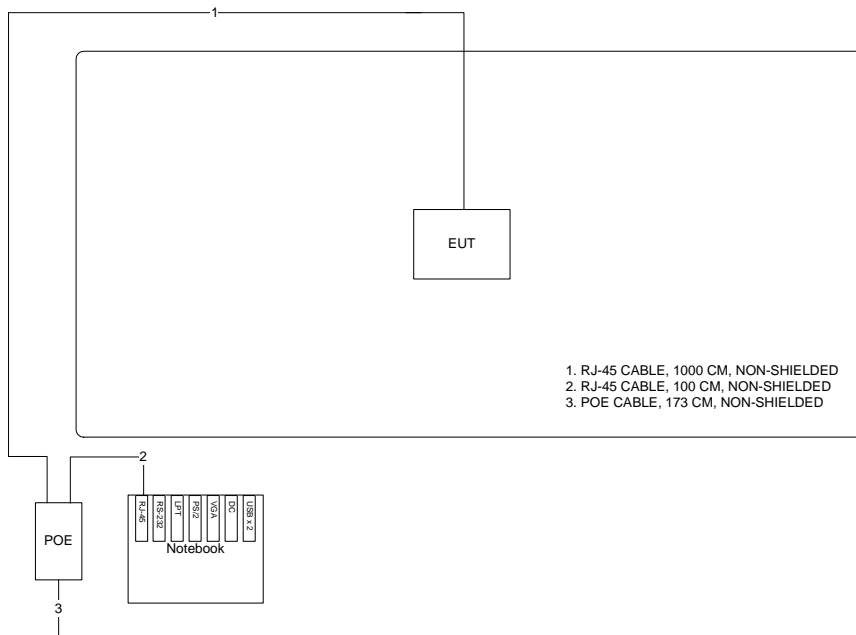

<For Co-location Function>

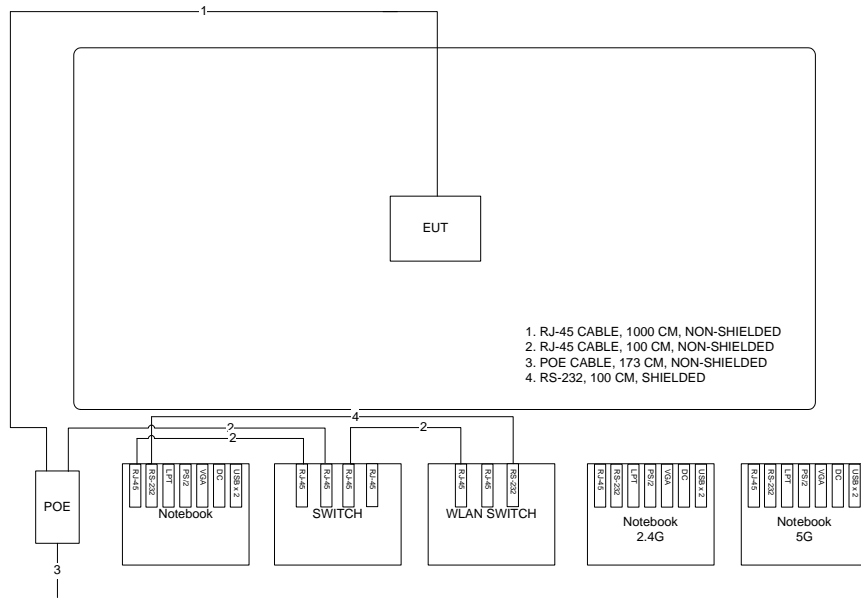

< For Ant. 2 >

< For WLAN Function >

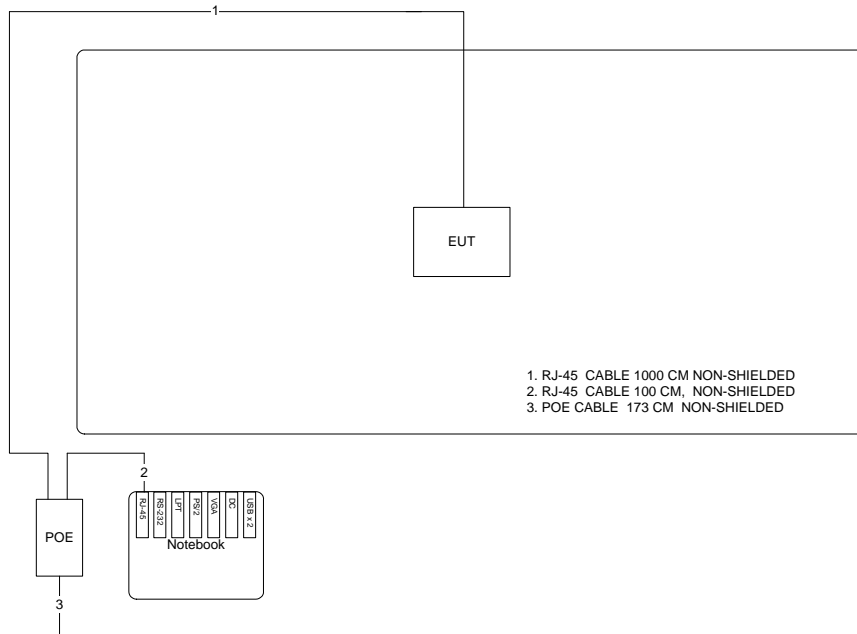

<For Co-location Function>

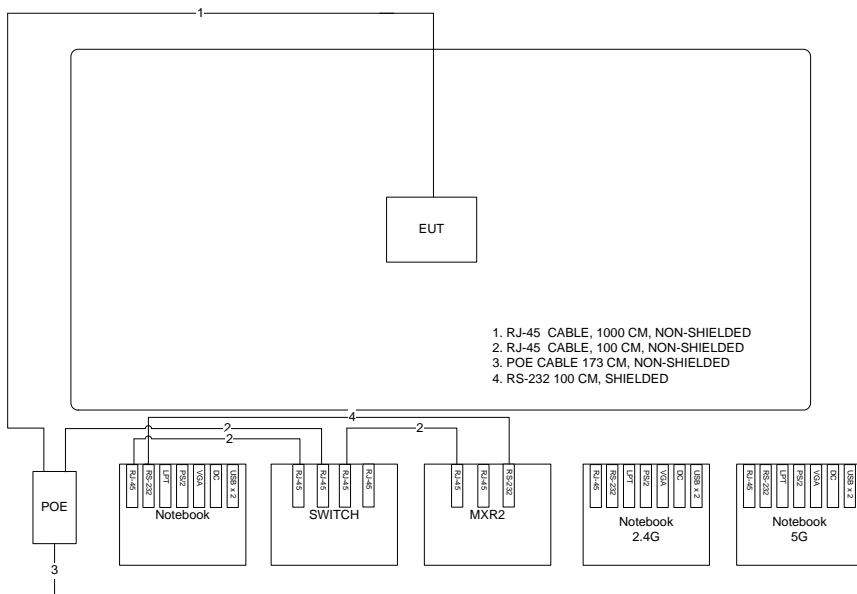

< For Ant. 3 >

< For WLAN Function >

Test Configuration: above 1GHz

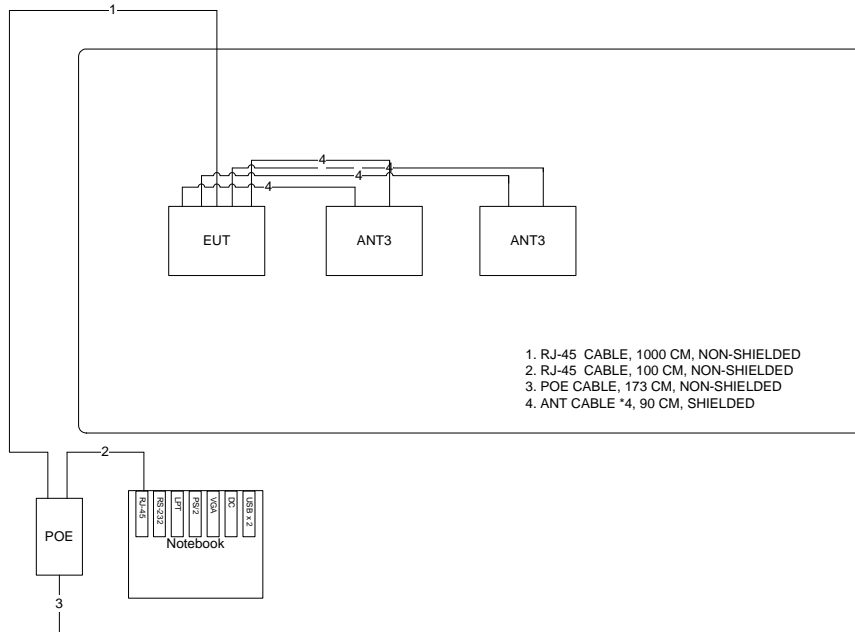

< For Ant. 4 >

< For WLAN Function >

Test Configuration: above 1GHz

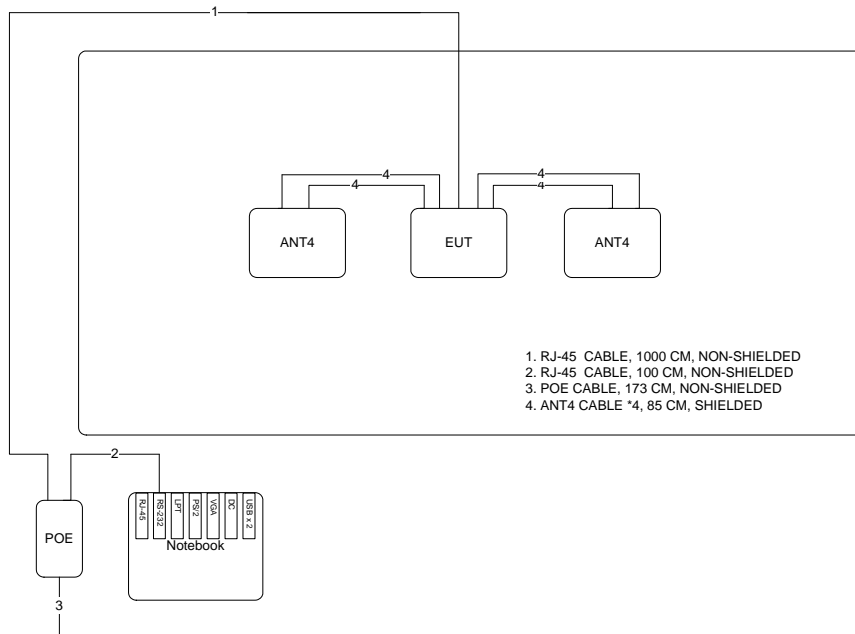

< For Ant. 5 >

< For WLAN Function >

Test Configuration: 9KHz~1GHz

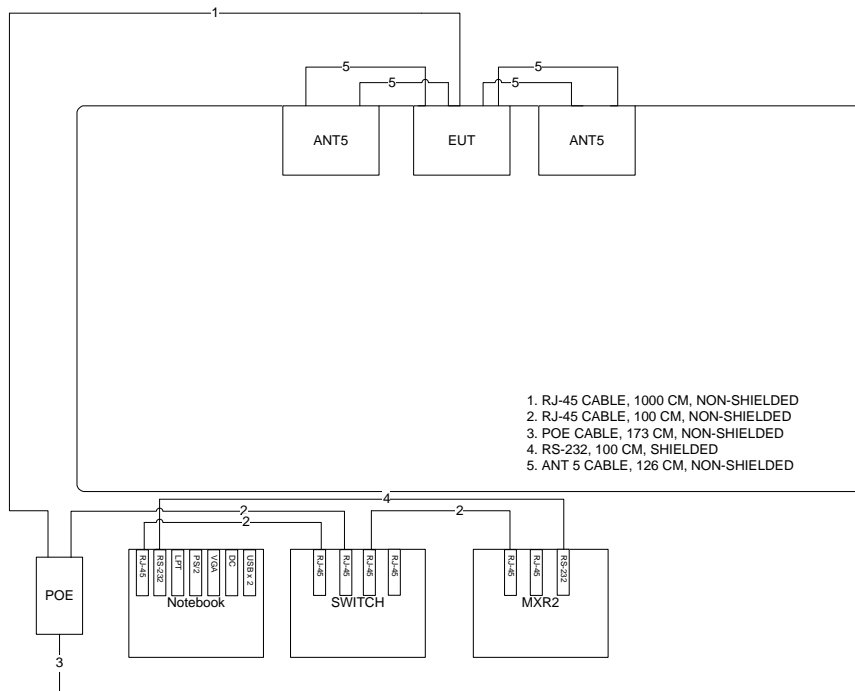

< For Ant. 6 >

< For WLAN Function >

Test Configuration: above 1GHz

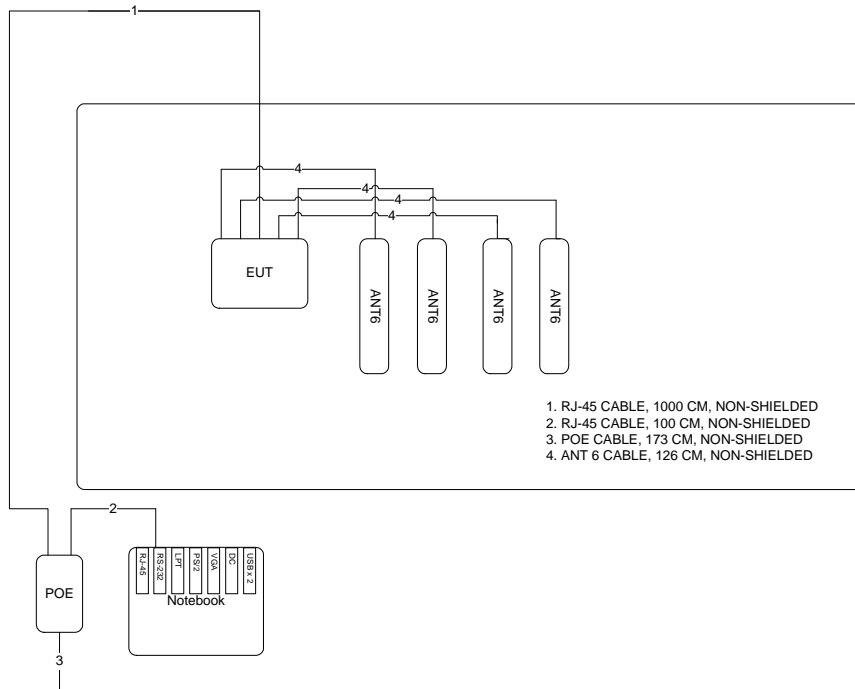

## 4. TEST RESULT

### 4.1. AC Power Line Conducted Emissions Measurement

#### 4.1.1. Limit

For this product which is designed to be connected to the AC power line, the radio frequency voltage that is conducted back onto the AC power line on any frequency or frequencies within the band 150 kHz to 30 MHz shall not exceed below limits table.

Frequency (MHz)	QP Limit (dBuV)	AV Limit (dBuV)
0.15~0.5	66~56	56~46
0.5~5	56	46
5~30	60	50

#### 4.1.2. Measuring Instruments and Setting

Please refer to section 5 of equipments list in this report. The following table is the setting of the receiver.

Receiver Parameters	Setting
Attenuation	10 dB
Start Frequency	0.15 MHz
Stop Frequency	30 MHz
IF Bandwidth	9 KHz

#### 4.1.3. Test Procedures

1. The EUT or host of EUT has to be placed 0.4 meter far from the conducting wall of the shielding room and at least 80 centimeters from any other grounded conducting surface.
2. Connect EUT or host of EUT to the power mains through a line impedance stabilization network (LISN).
3. All the support units are connected to the other LISNs. The LISN should provide 50uH/50ohms coupling impedance.
4. The frequency range from 150 KHz to 30 MHz was searched.
5. Set the test-receiver system to Peak Detect Function and Specified Bandwidth with Maximum Hold Mode.
6. The measurement has to be done between each power line and ground at the power terminal.



#### 4.1.4. Test Setup Layout

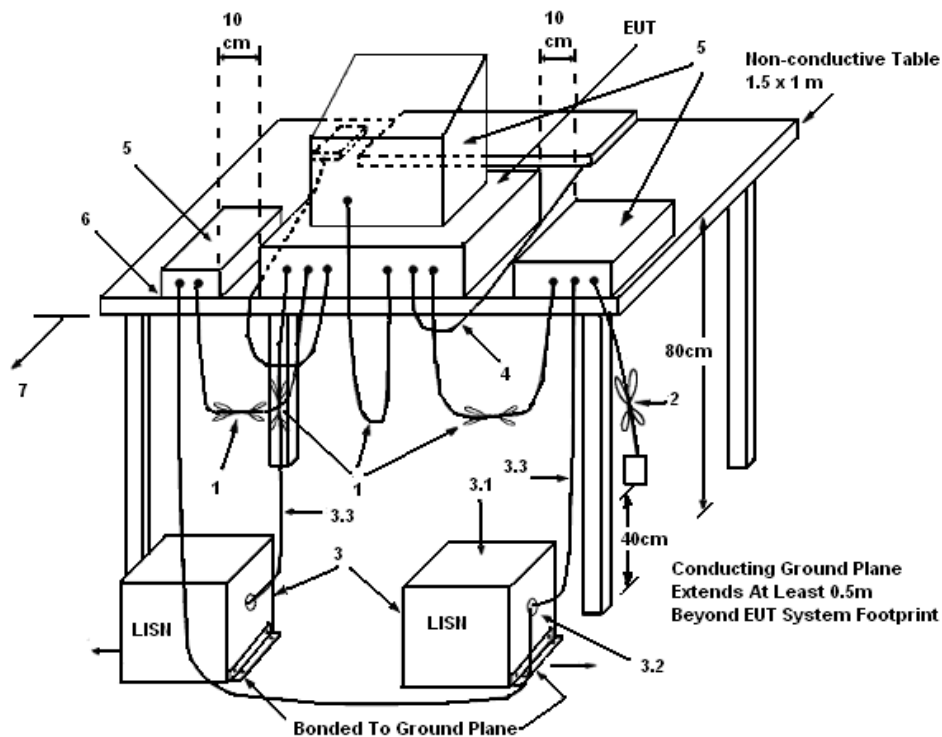

#### LEGEND:

- (1) Interconnecting cables that hang closer than 40 cm to the ground plane shall be folded back and forth in the center forming a bundle 30 to 40 cm long.
- (2) I/O cables that are not connected to a peripheral shall be bundled in the center. The end of the cable may be terminated, if required, using the correct terminating impedance. The overall length shall not exceed 1 m.
- (3) EUT connected to one LISN. Unused LISN measuring port connectors shall be terminated in 50 Ω. LISN can be placed on top of, or immediately beneath, reference ground plane.
- (3.1) All other equipment powered from additional LISN(s).
- (3.2) Multiple outlet strip can be used for multiple power cords of non-EUT equipment.
- (3.3) LISN at least 80 cm from nearest part of EUT chassis.
- (4) Cables of hand-operated devices, such as keyboards, mice, etc., shall be placed as for normal use.
- (5) Non-EUT components of EUT system being tested.
- (6) Rear of EUT, including peripherals, shall all be aligned and flush with rear of tabletop.
- (7) Rear of tabletop shall be 40 cm removed from a vertical conducting plane that is bonded to the ground plane.

#### 4.1.5. Test Deviation

There is no deviation with the original standard.

4.1.6. Results of AC Power Line Conducted Emissions Measurement

Temperature	24.1°C	Humidity	52.1%
Test Engineer	Beck Wu	Phase	Line
Configuration	Normal Link / Mode 5		

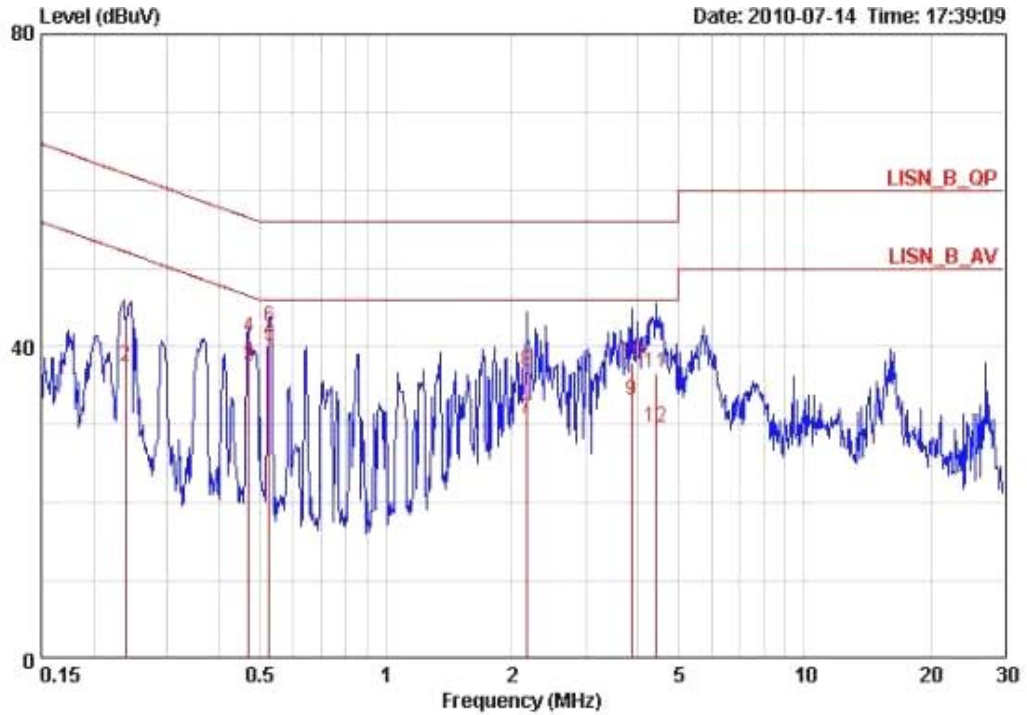

	Freq	Level	Over Limit	Limit Line	Read Level	LISN Factor	Cable Loss	Remark
	MHz	dBuV	dB	dBuV	dBuV	dB	dB	
1	0.23922	43.28	-18.84	62.12	43.01	0.07	0.20	QP
2	0.23922	37.46	-14.66	52.12	37.19	0.07	0.20	AVERAGE
3	0.47110	37.55	-8.94	46.49	37.35	0.00	0.20	AVERAGE
4	0.47110	41.15	-15.34	56.49	40.95	0.00	0.20	QP
5	0.52655	40.11	-5.89	46.00	39.91	0.00	0.20	AVERAGE
6	0.52655	42.47	-13.53	56.00	42.27	0.00	0.20	QP
7	2.167	30.69	-15.31	46.00	30.49	0.00	0.20	AVERAGE
8	2.167	36.94	-19.06	56.00	36.74	0.00	0.20	QP
9	3.860	33.11	-12.89	46.00	32.81	0.00	0.30	AVERAGE
10	3.860	38.00	-18.00	56.00	37.70	0.00	0.30	QP
11	4.407	36.65	-19.35	56.00	36.34	0.01	0.30	QP
12	4.407	29.55	-16.45	46.00	29.24	0.01	0.30	AVERAGE

Temperature	24.1°C	Humidity	52.1%
Test Engineer	Beck Wu	Phase	Neutral
Configuration	Normal Link / Mode 5		

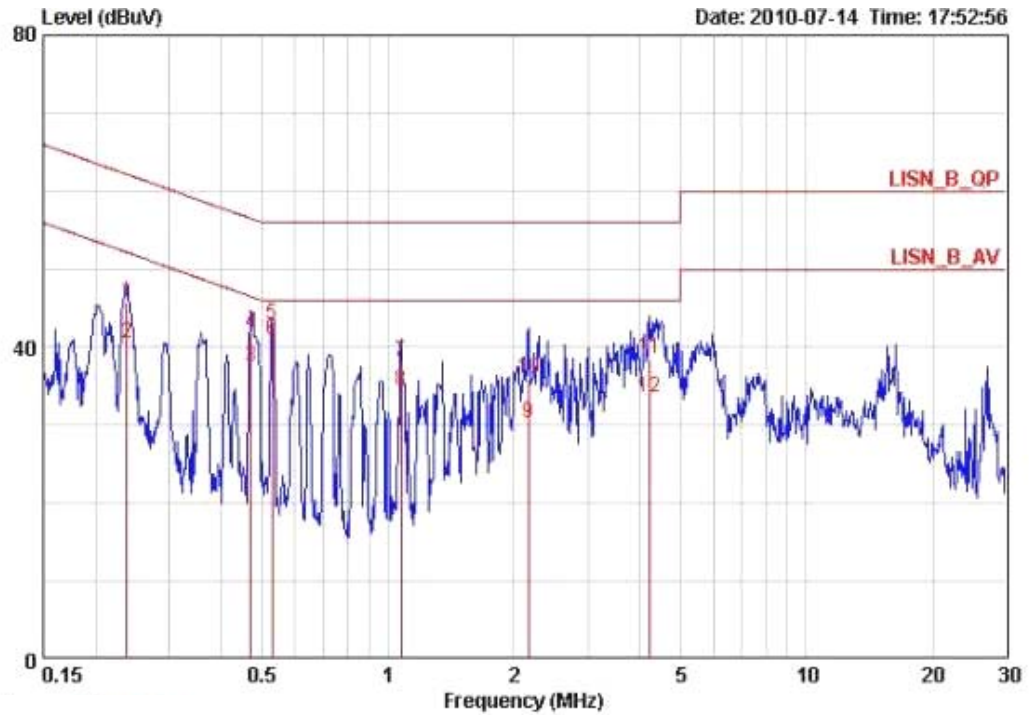

	Freq	Level	Over Limit	Limit Line	Read Level	LISM Factor	Cable Loss	Remark
	MHz	dBuV	dB	dBuV	dBuV	dB	dB	
1	0.23784	45.71	-16.47	62.17	45.43	0.08	0.20	QP
2	0.23784	40.64	-11.54	52.17	40.36	0.08	0.20	AVERAGE
3	0.47110	37.44	-9.05	46.49	37.24	0.00	0.20	AVERAGE
4	0.47110	41.93	-14.56	56.49	41.73	0.00	0.20	QP
5	0.52934	42.87	-13.13	56.00	42.67	0.00	0.20	QP
6	0.52934	40.88	-5.12	46.00	40.68	0.00	0.20	AVERAGE
7	1.077	38.06	-17.94	56.00	37.88	0.00	0.18	QP
8	1.077	34.36	-11.64	46.00	34.18	0.00	0.18	AVERAGE
9	2.167	30.26	-15.74	46.00	30.06	0.00	0.20	AVERAGE
10	2.167	36.07	-19.93	56.00	35.87	0.00	0.20	QP
11	4.224	38.59	-17.41	56.00	38.28	0.01	0.30	QP
12	4.224	33.60	-12.40	46.00	33.29	0.01	0.30	AVERAGE

Note:

Level = Read Level + LISN Factor + Cable Loss.

## 4.2. 99% Occupied Bandwidth Measurement

### 4.2.1. Limit

No restriction limits. But resolution bandwidth within band edge measurement is 1% of the 99% occupied bandwidth.

### 4.2.2. Measuring Instruments and Setting

Please refer to section 5 of equipments list in this report. The following table is the setting of the spectrum analyzer.

Spectrum Parameters	Setting
Attenuation	Auto
Span Frequency	> 26dB Bandwidth
RB	300 kHz
VB	1000 kHz
Detector	Peak
Trace	Max Hold
Sweep Time	Auto

### 4.2.3. Test Procedures

1. The transmitter output (antenna port) was connected to the spectrum analyzer in peak hold mode.
2. The resolution bandwidth of 300 kHz and the video bandwidth of 1000 kHz were used.
3. Measured the spectrum width with power higher than 26dB below carrier.
4. Measuring multiple antennas, the connector is required to link with spectrum analyzer through a combiner.

### 4.2.4. Test Setup Layout

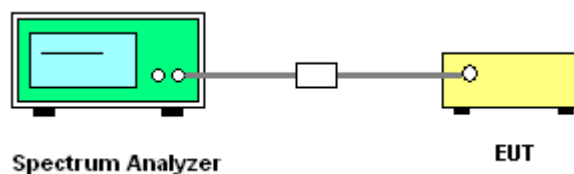

### 4.2.5. Test Deviation

There is no deviation with the original standard.

### 4.2.6. EUT Operation during Test

The EUT was programmed to be in continuously transmitting mode.

#### 4.2.7. Test Result of 99% Occupied Bandwidth

< For Ant. 1 >

Temperature	24°C	Humidity	56%
Test Engineer	Johnson Chang	Configurations	IEEE 802.11n / Ant. 1

##### Configuration IEEE 802.11n MCS8 20MHz A1+A5

Channel	Frequency	26dB Bandwidth (MHz)	99% Occupied Bandwidth (MHz)
36	5180 MHz	25.12	18.40
40	5200 MHz	25.92	18.40
48	5240 MHz	25.44	18.40

##### Configuration IEEE 802.11n MCS8 40MHz A1+A5

Channel	Frequency	26dB Bandwidth (MHz)	99% Occupied Bandwidth (MHz)
38	5190 MHz	46.72	36.64
46	5230 MHz	46.40	36.48



<b>Temperature</b>	24°C	<b>Humidity</b>	56%
<b>Test Engineer</b>	Johnson Chang	<b>Configurations</b>	IEEE 802.11a / Ant. 1

**Configuration IEEE 802.11a A1+A5**

<b>Channel</b>	<b>Frequency</b>	<b>26dB Bandwidth (MHz)</b>	<b>99% Occupied Bandwidth (MHz)</b>
36	5180 MHz	23.84	17.44
40	5200 MHz	24.16	17.28
48	5240 MHz	24.80	17.28

< For Ant. 2 >

<b>Temperature</b>	24°C	<b>Humidity</b>	56%
<b>Test Engineer</b>	Johnson Chang	<b>Configurations</b>	IEEE 802.11n / Ant. 2

**Configuration IEEE 802.11n MCS8 20MHz A1+A5**

Channel	Frequency	26dB Bandwidth (MHz)	99% Occupied Bandwidth (MHz)
36	5180 MHz	24.96	18.40
40	5200 MHz	25.12	18.24
48	5240 MHz	25.60	18.24

**Configuration IEEE 802.11n MCS8 40MHz A1+A5**

Channel	Frequency	26dB Bandwidth (MHz)	99% Occupied Bandwidth (MHz)
38	5190 MHz	46.72	36.64
46	5230 MHz	48.00	36.64

<b>Temperature</b>	24°C	<b>Humidity</b>	56%
<b>Test Engineer</b>	Johnson Chang	<b>Configurations</b>	IEEE 802.11a / Ant. 2

**Configuration IEEE 802.11a A1+A5**

<b>Channel</b>	<b>Frequency</b>	<b>26dB Bandwidth (MHz)</b>	<b>99% Occupied Bandwidth (MHz)</b>
36	5180 MHz	25.44	17.44
40	5200 MHz	24.48	17.44
48	5240 MHz	25.76	17.28



< For Ant. 3 >

<b>Temperature</b>	24°C	<b>Humidity</b>	56%
<b>Test Engineer</b>	Johnson Chang	<b>Configurations</b>	IEEE 802.11n / Ant. 3

**Configuration IEEE 802.11n MCS8 20MHz A1+A5**

Channel	Frequency	26dB Bandwidth (MHz)	99% Occupied Bandwidth (MHz)
36	5180 MHz	25.12	18.24
40	5200 MHz	24.32	18.40
48	5240 MHz	25.28	18.24

**Configuration IEEE 802.11n MCS8 40MHz A1+A5**

Channel	Frequency	26dB Bandwidth (MHz)	99% Occupied Bandwidth (MHz)
38	5190 MHz	45.12	36.48
46	5230 MHz	47.36	36.48

<b>Temperature</b>	24°C	<b>Humidity</b>	56%
<b>Test Engineer</b>	Johnson Chang	<b>Configurations</b>	IEEE 802.11a / Ant. 3

**Configuration IEEE 802.11a A1+A5**

Channel	Frequency	26dB Bandwidth (MHz)	99% Occupied Bandwidth (MHz)
36	5180 MHz	24.64	17.44
40	5200 MHz	24.32	17.28
48	5240 MHz	24.80	17.28

< For Ant. 4 >

<b>Temperature</b>	24°C	<b>Humidity</b>	56%
<b>Test Engineer</b>	Johnson Chang	<b>Configurations</b>	IEEE 802.11n / Ant. 4

**Configuration IEEE 802.11n MCS8 20MHz A1+A5**

Channel	Frequency	26dB Bandwidth (MHz)	99% Occupied Bandwidth (MHz)
36	5180 MHz	24.80	18.24
40	5200 MHz	24.80	18.24
48	5240 MHz	24.80	18.24

**Configuration IEEE 802.11n MCS8 40MHz A1+A5**

Channel	Frequency	26dB Bandwidth (MHz)	99% Occupied Bandwidth (MHz)
38	5190 MHz	45.28	36.64
46	5230 MHz	45.60	36.48



<b>Temperature</b>	24°C	<b>Humidity</b>	56%
<b>Test Engineer</b>	Johnson Chang	<b>Configurations</b>	IEEE 802.11a / Ant. 4

**Configuration IEEE 802.11a A1+A5**

<b>Channel</b>	<b>Frequency</b>	<b>26dB Bandwidth (MHz)</b>	<b>99% Occupied Bandwidth (MHz)</b>
36	5180 MHz	24.00	17.28
40	5200 MHz	23.84	17.28
48	5240 MHz	24.80	17.28

< For Ant. 6 >

<b>Temperature</b>	24°C	<b>Humidity</b>	56%
<b>Test Engineer</b>	Johnson Chang	<b>Configurations</b>	IEEE 802.11n / Ant. 6

**Configuration IEEE 802.11n MCS8 20MHz A1+A5**

Channel	Frequency	26dB Bandwidth (MHz)	99% Occupied Bandwidth (MHz)
36	5180 MHz	25.92	18.40
40	5200 MHz	25.44	18.24
48	5240 MHz	25.60	18.40

**Configuration IEEE 802.11n MCS8 40MHz A1+A5**

Channel	Frequency	26dB Bandwidth (MHz)	99% Occupied Bandwidth (MHz)
38	5190 MHz	47.36	36.48
46	5230 MHz	48.00	36.48

<b>Temperature</b>	24°C	<b>Humidity</b>	56%
<b>Test Engineer</b>	Johnson Chang	<b>Configurations</b>	IEEE 802.11a / Ant. 6

**Configuration IEEE 802.11a A1+A5**

<b>Channel</b>	<b>Frequency</b>	<b>26dB Bandwidth (MHz)</b>	<b>99% Occupied Bandwidth (MHz)</b>
36	5180 MHz	25.12	17.44
40	5200 MHz	25.60	17.44
48	5240 MHz	25.92	17.44

< For Ant. 1 >

26 dB Bandwidth Plot on Configuration IEEE 802.11n MCS8 20MHz A1+A5 / 5180 MHz

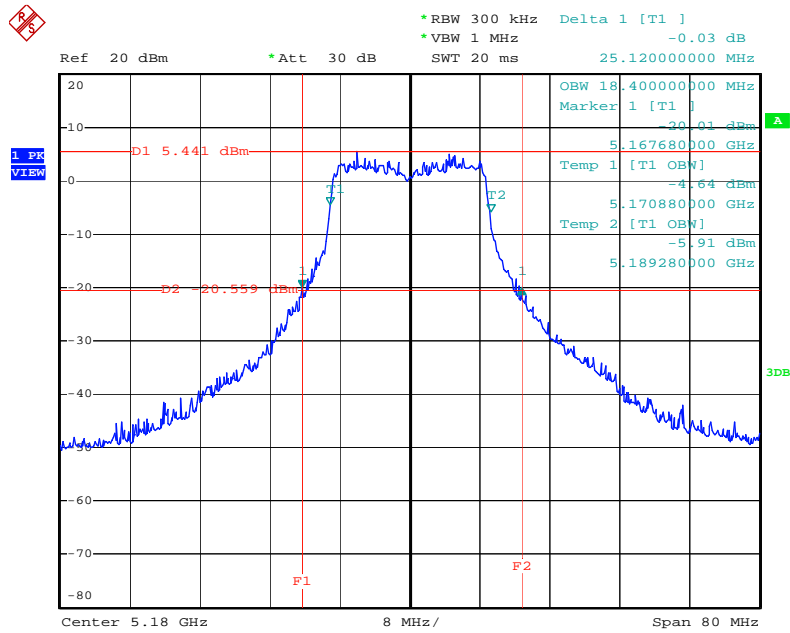

Date: 26.APR.2010 21:57:00

26 dB Bandwidth Plot on Configuration IEEE 802.11n MCS8 20MHz A1+A5 / 5200 MHz

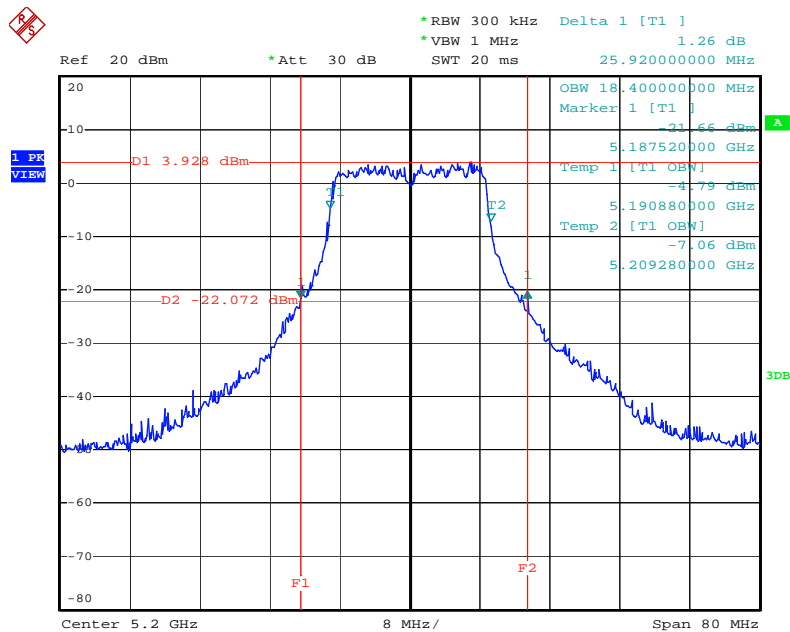

Date: 26.APR.2010 20:44:01

26 dB Bandwidth Plot on Configuration IEEE 802.11n MCS8 20MHz A1+A5 / 5240 MHz

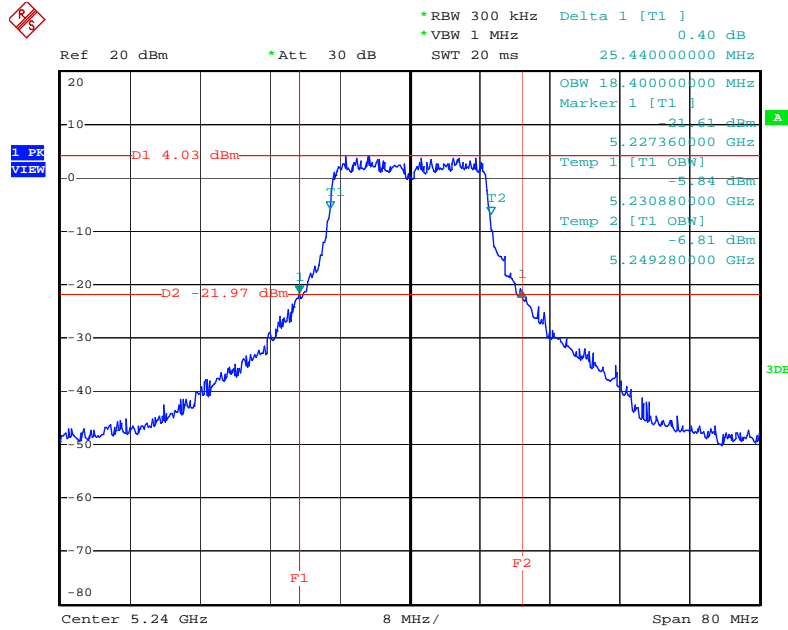

Date: 26.APR.2010 20:46:12

26 dB Bandwidth Plot on Configuration IEEE 802.11n MCS8 40MHz A1+A5 / 5190 MHz

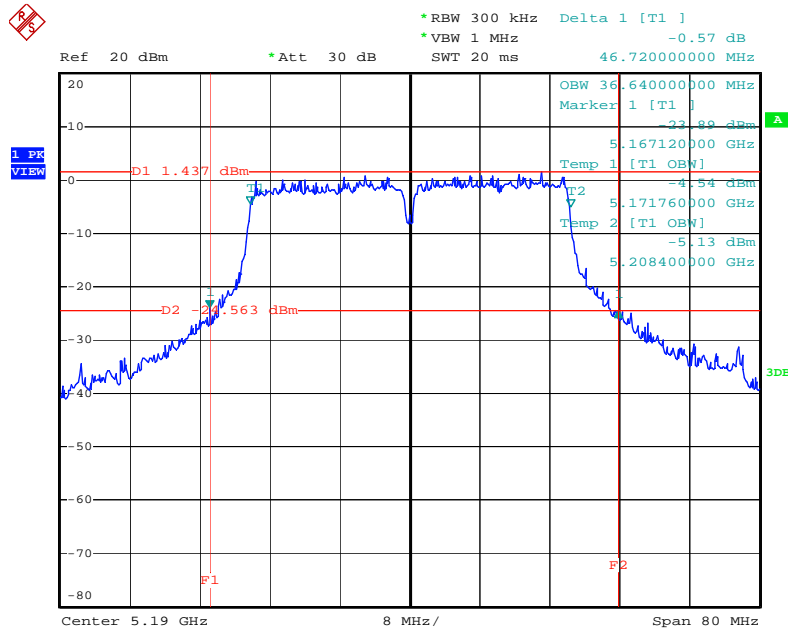

Date: 26.APR.2010 21:27:21



26 dB Bandwidth Plot on Configuration IEEE 802.11n MCS8 40MHz A1+A5 / 5230 MHz

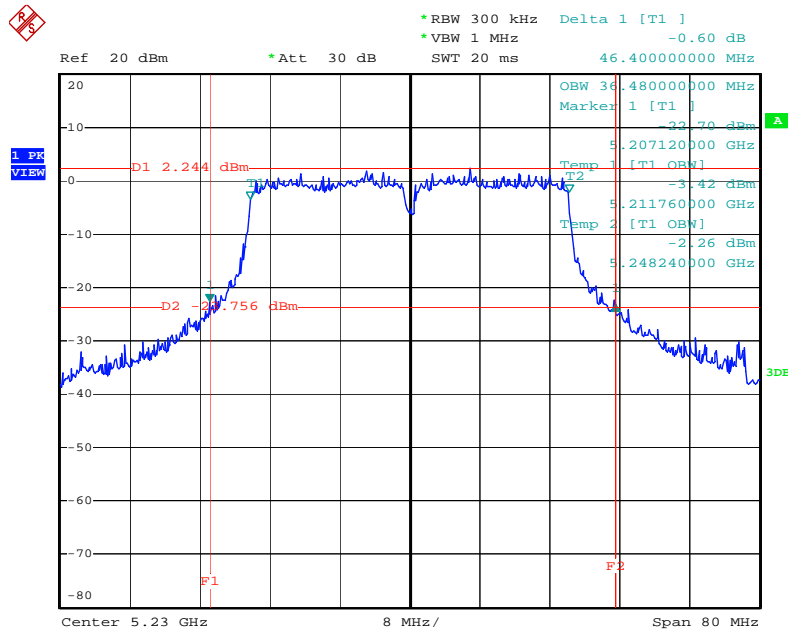

Date: 26.APR.2010 21:08:12

26 dB Bandwidth Plot on Configuration IEEE 802.11a A1+A5 / 5180 MHz

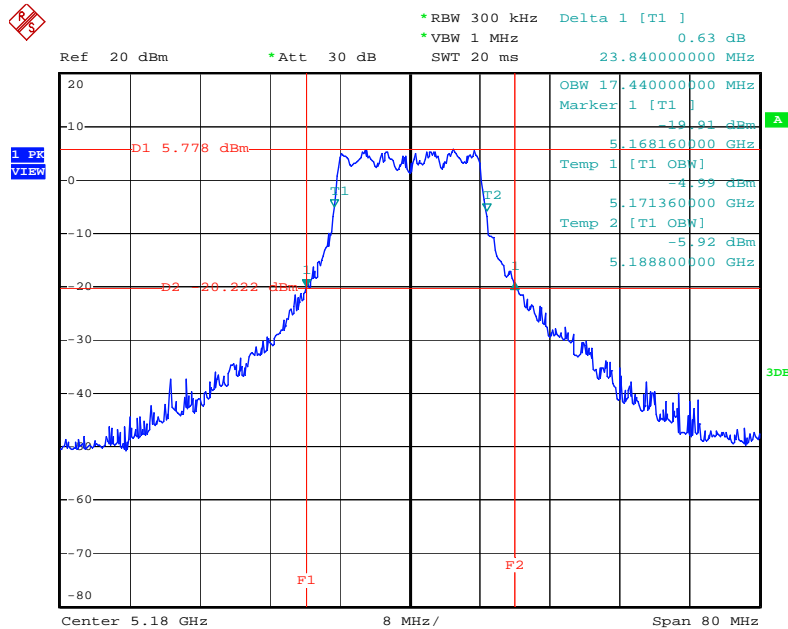

Date: 26.APR.2010 20:14:17

### 26 dB Bandwidth Plot on Configuration IEEE 802.11a A1+A5 / 5200 MHz

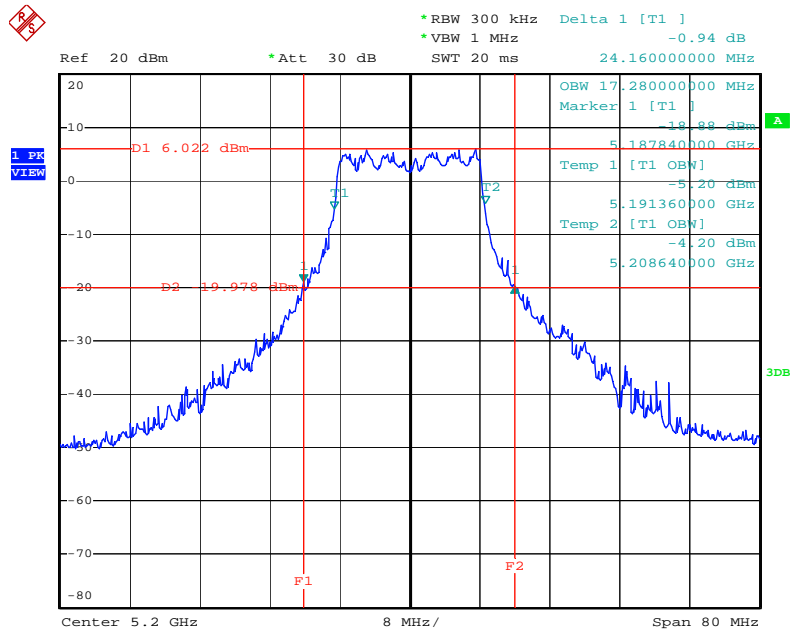

Date: 26.APR.2010 20:16:30

### 26 dB Bandwidth Plot on Configuration IEEE 802.11a A1+A5 / 5240 MHz

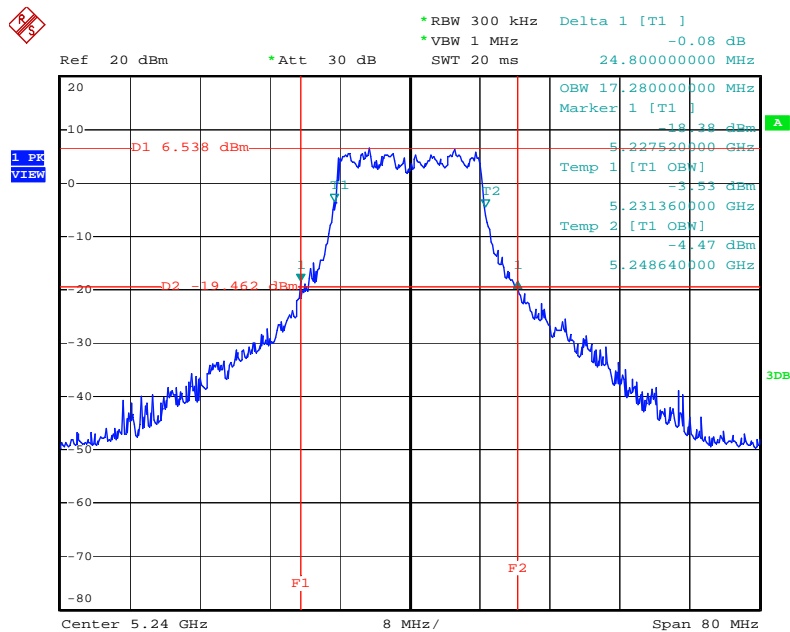

Date: 26.APR.2010 20:36:34

< For Ant. 2 >

26 dB Bandwidth Plot on Configuration IEEE 802.11n MCS8 20MHz A1+A5 / 5180 MHz

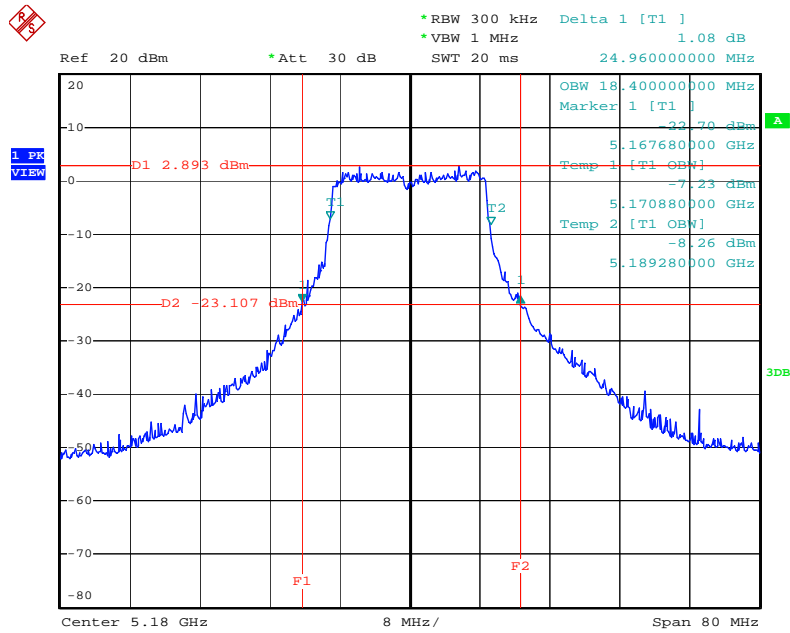

Date: 1.MAY.2010 13:29:02

26 dB Bandwidth Plot on Configuration IEEE 802.11n MCS8 20MHz A1+A5 / 5200 MHz

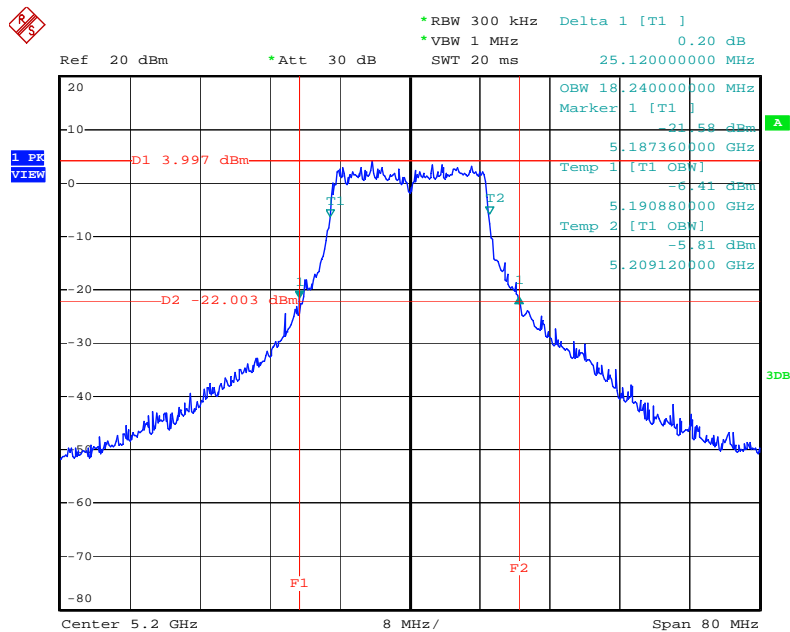

Date: 1.MAY.2010 13:31:03

26 dB Bandwidth Plot on Configuration IEEE 802.11n MCS8 20MHz A1+A5 / 5240 MHz

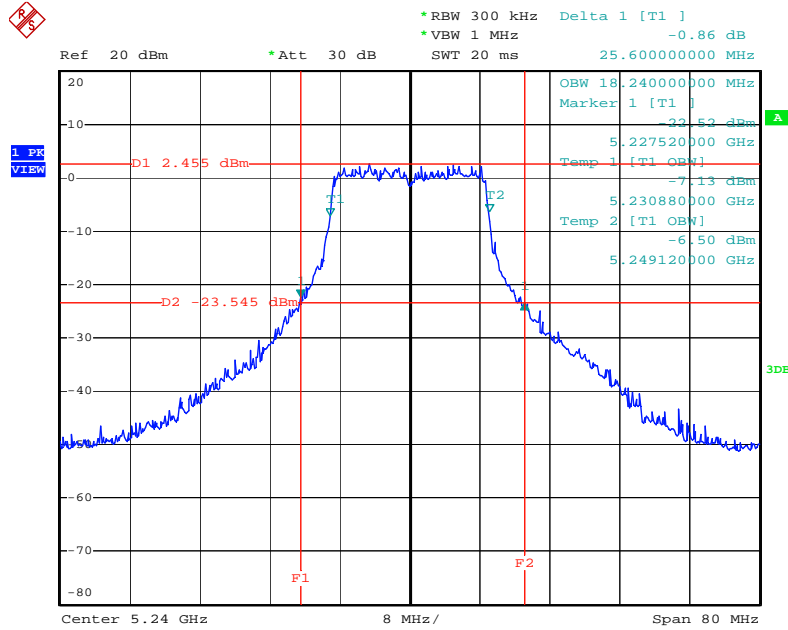

Date: 1.MAY.2010 13:25:39

26 dB Bandwidth Plot on Configuration IEEE 802.11n MCS8 40MHz A1+A5 / 5190 MHz

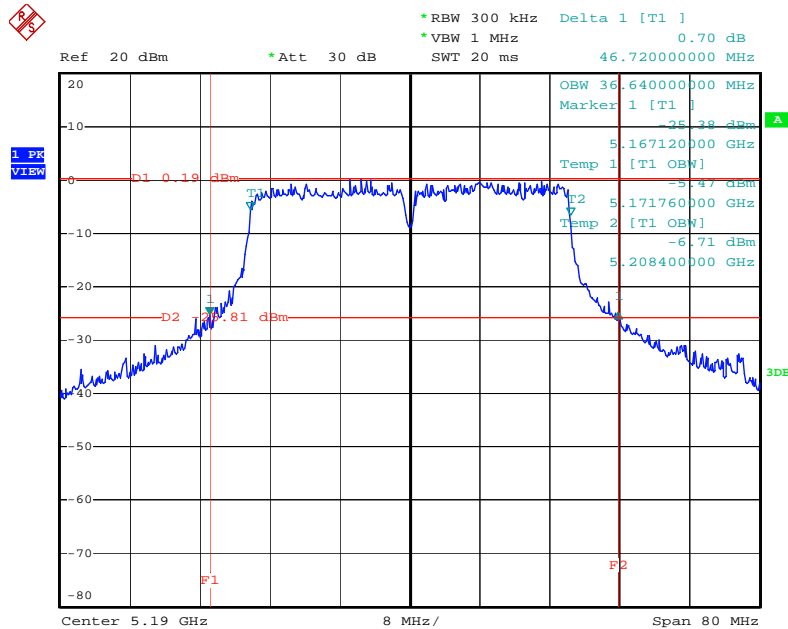

Date: 1.MAY.2010 12:53:33

26 dB Bandwidth Plot on Configuration IEEE 802.11n MCS8 40MHz A1+A5 / 5230 MHz

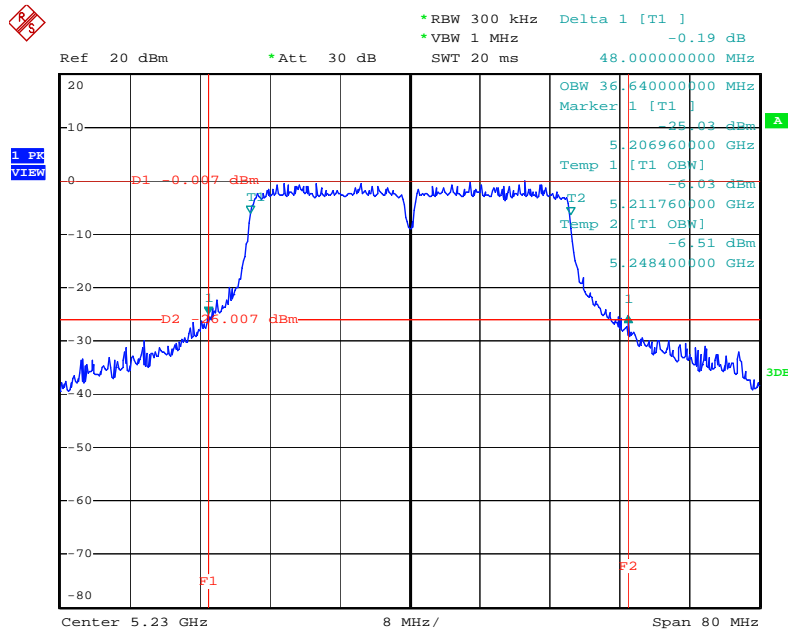

Date: 1.MAY.2010 12:51:05

26 dB Bandwidth Plot on Configuration IEEE 802.11a A1+A5 / 5180 MHz

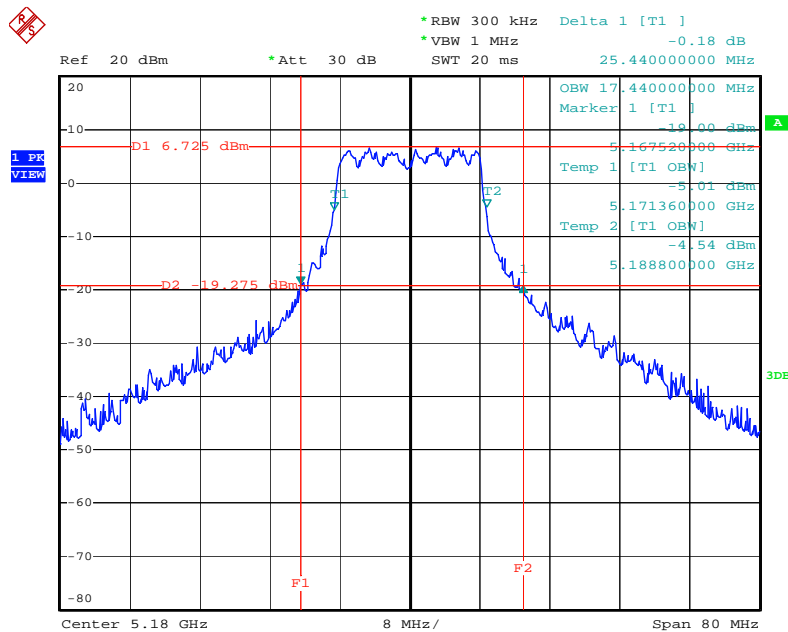

Date: 1.MAY.2010 13:33:39

### 26 dB Bandwidth Plot on Configuration IEEE 802.11a A1+A5 / 5200 MHz

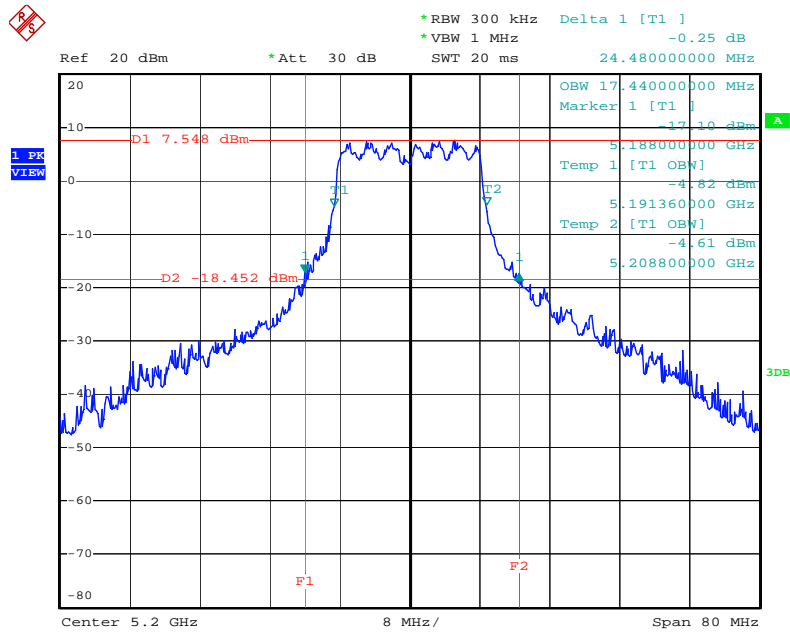

Date: 1.MAY.2010 13:35:59

### 26 dB Bandwidth Plot on Configuration IEEE 802.11a A1+A5 / 5240 MHz

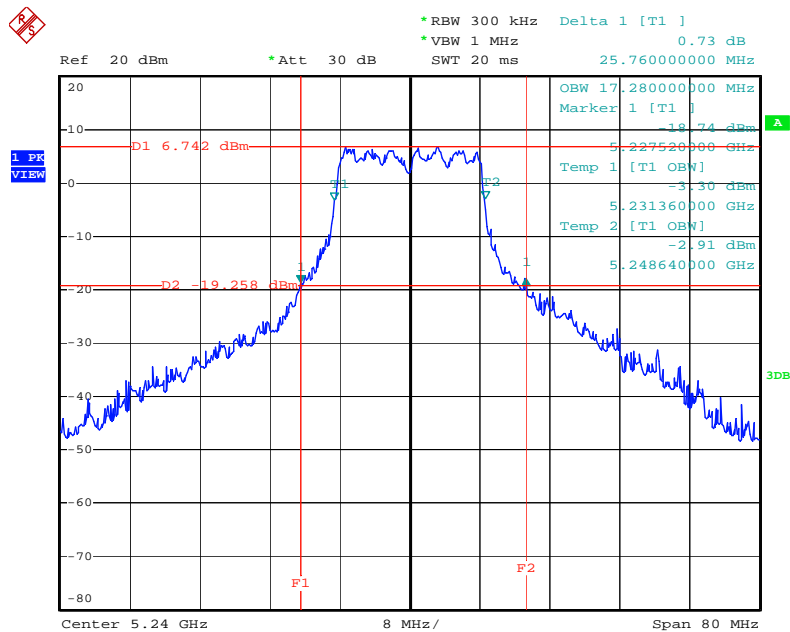

Date: 1.MAY.2010 13:38:45

< For Ant. 3 >

26 dB Bandwidth Plot on Configuration IEEE 802.11n MCS8 20MHz A1+A5 / 5180 MHz

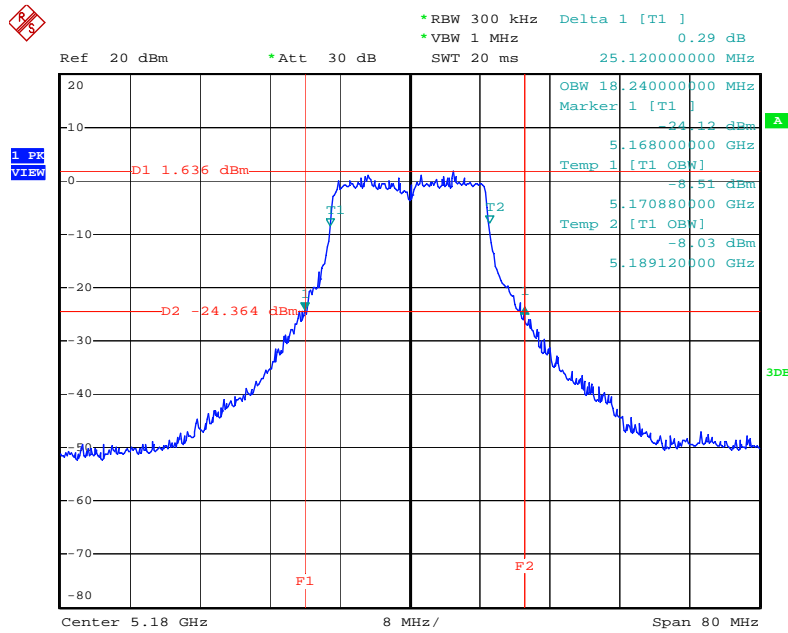

Date: 3.MAY.2010 16:57:33

26 dB Bandwidth Plot on Configuration IEEE 802.11n MCS8 20MHz A1+A5 / 5200 MHz

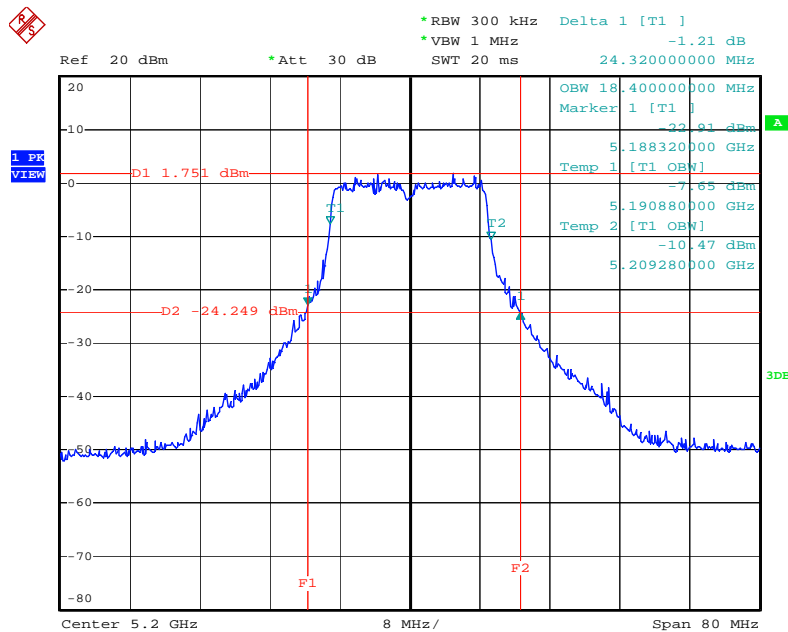

Date: 3.MAY.2010 16:55:02

26 dB Bandwidth Plot on Configuration IEEE 802.11n MCS8 20MHz A1+A5 / 5240 MHz

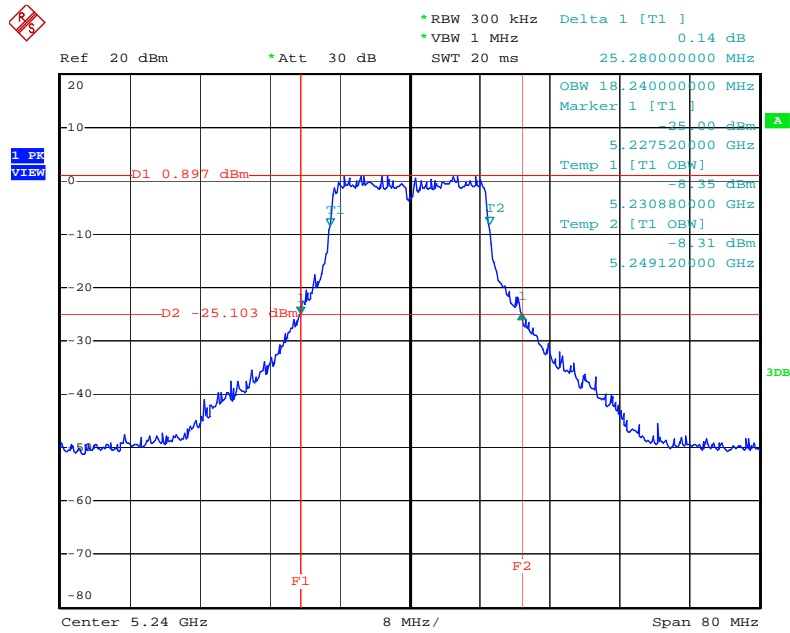

Date: 3.MAY.2010 16:52:56

26 dB Bandwidth Plot on Configuration IEEE 802.11n MCS8 40MHz A1+A5 / 5190 MHz

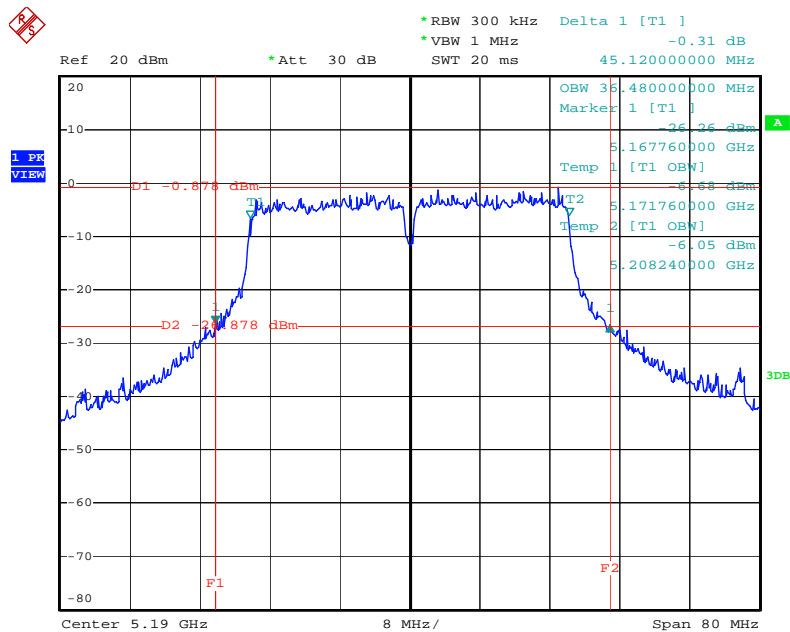

Date: 3.MAY.2010 17:02:22



26 dB Bandwidth Plot on Configuration IEEE 802.11n MCS8 40MHz A1+A5 / 5230 MHz

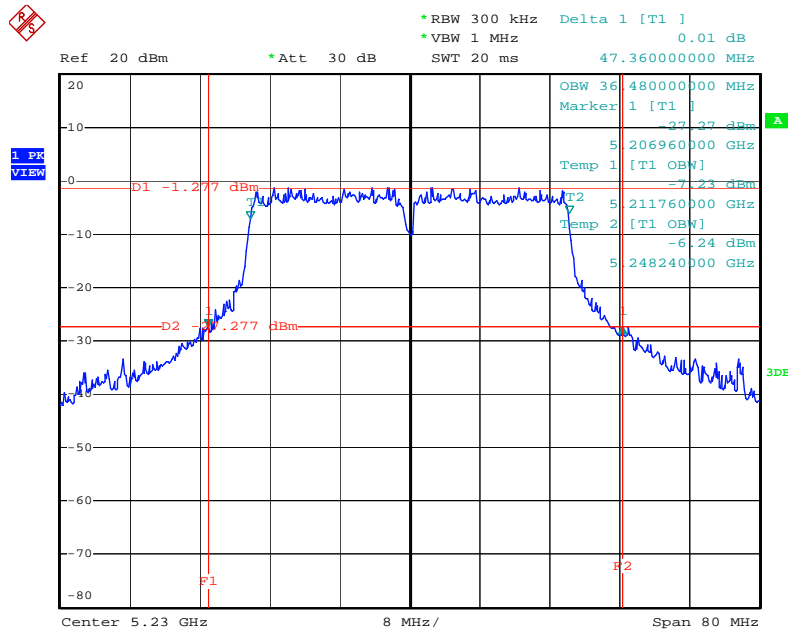

Date: 3.MAY.2010 17:04:50

26 dB Bandwidth Plot on Configuration IEEE 802.11a A1+A5 / 5180 MHz

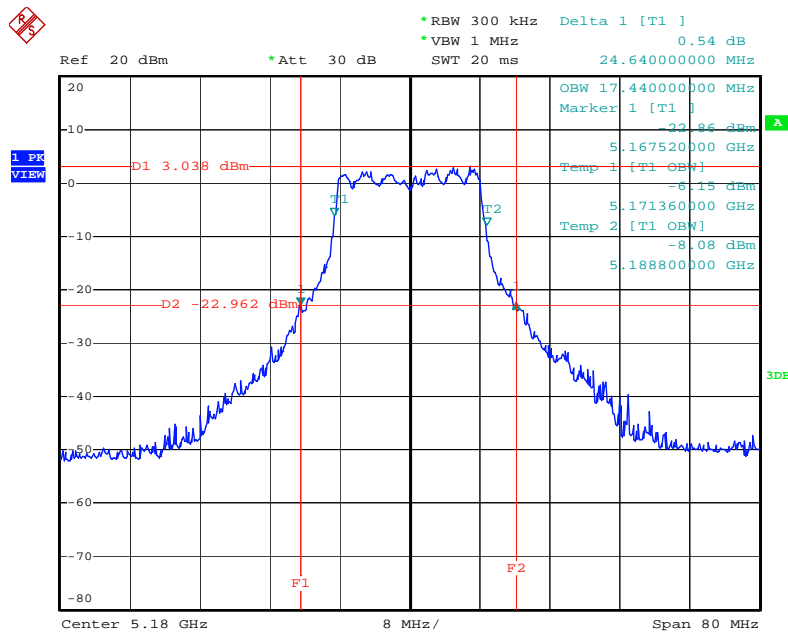

Date: 3.MAY.2010 16:02:08

### 26 dB Bandwidth Plot on Configuration IEEE 802.11a A1+A5 / 5200 MHz

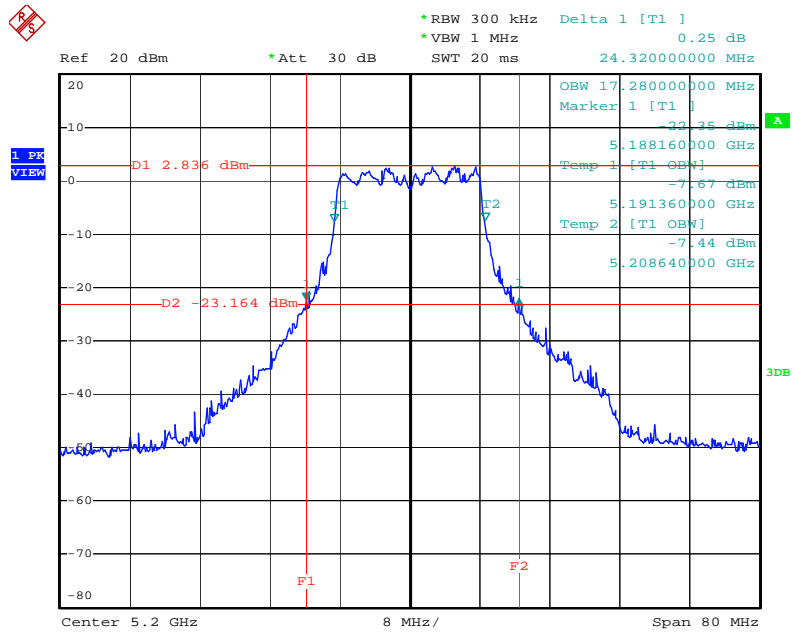

Date: 3.MAY.2010 16:08:02

### 26 dB Bandwidth Plot on Configuration IEEE 802.11a A1+A5 / 5240 MHz

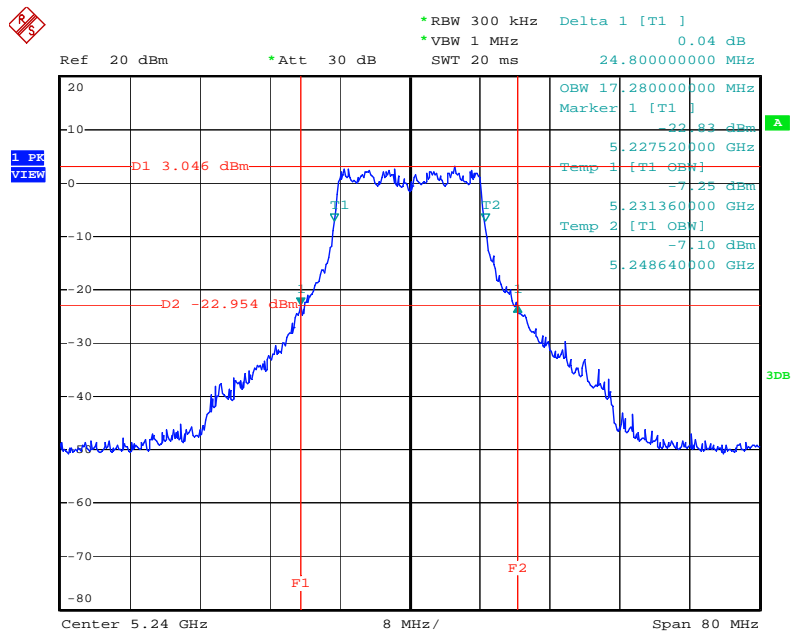

Date: 3.MAY.2010 16:14:01

< For Ant. 4 >

26 dB Bandwidth Plot on Configuration IEEE 802.11n MCS8 20MHz A1+A5 / 5180 MHz

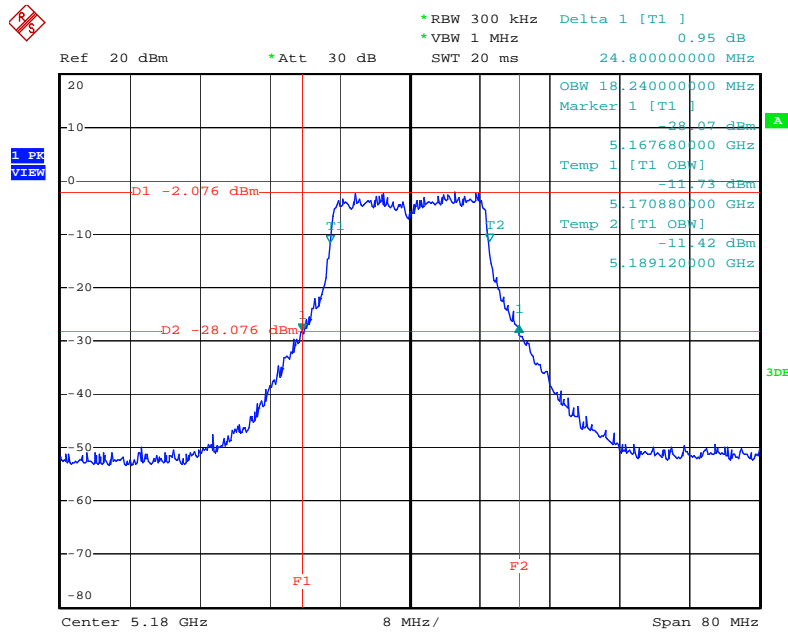

Date: 4.MAY.2010 11:30:50

26 dB Bandwidth Plot on Configuration IEEE 802.11n MCS8 20MHz A1+A5 / 5200 MHz

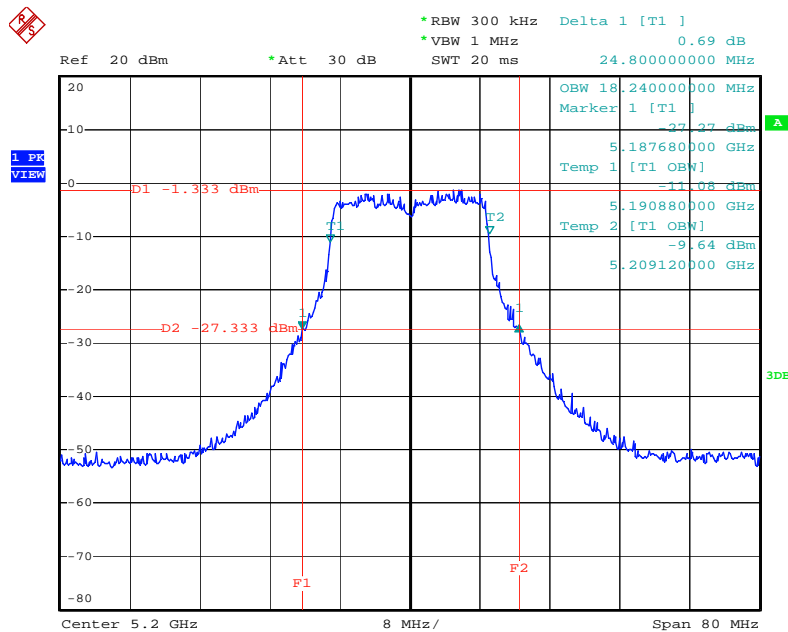

Date: 4.MAY.2010 11:34:53

26 dB Bandwidth Plot on Configuration IEEE 802.11n MCS8 20MHz A1+A5 / 5240 MHz

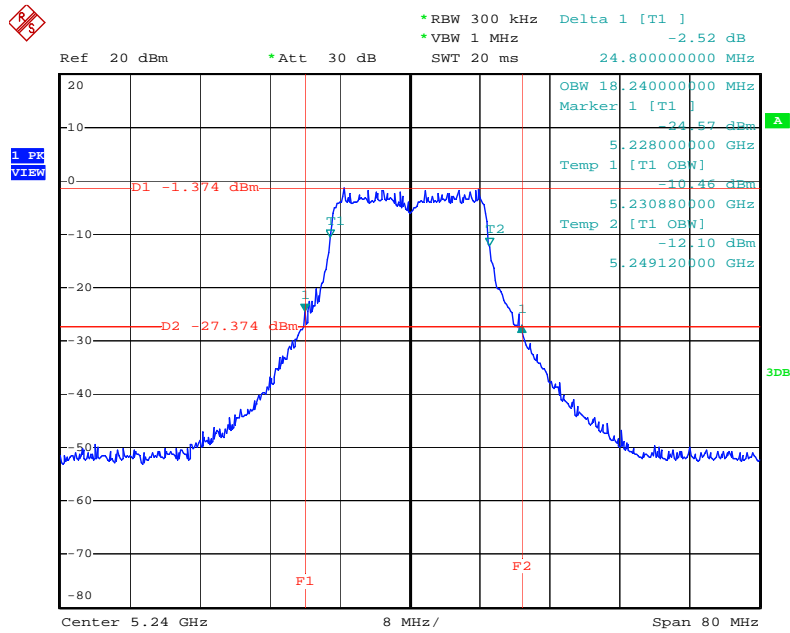

Date: 4.MAY.2010 11:36:13

26 dB Bandwidth Plot on Configuration IEEE 802.11n MCS8 40MHz A1+A5 / 5190 MHz

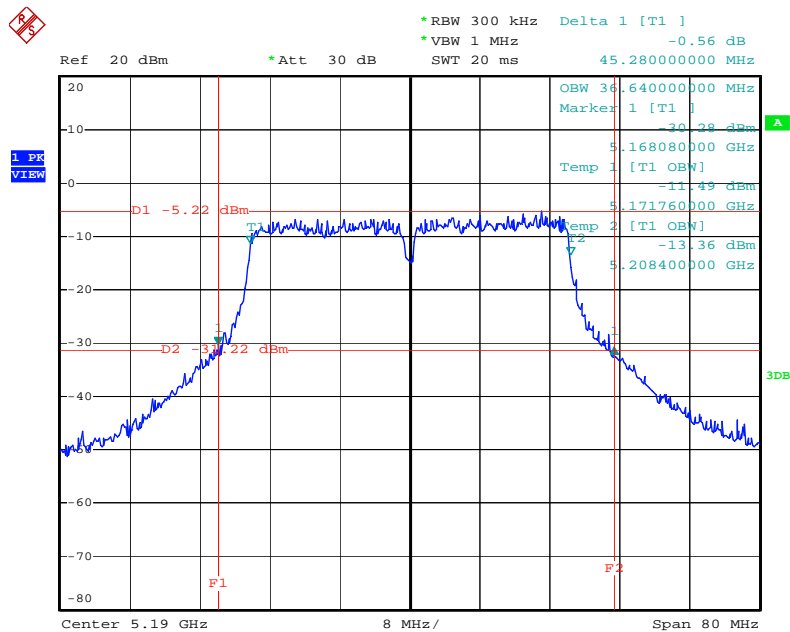

Date: 4.MAY.2010 11:27:39

26 dB Bandwidth Plot on Configuration IEEE 802.11n MCS8 40MHz A1+A5 / 5230 MHz

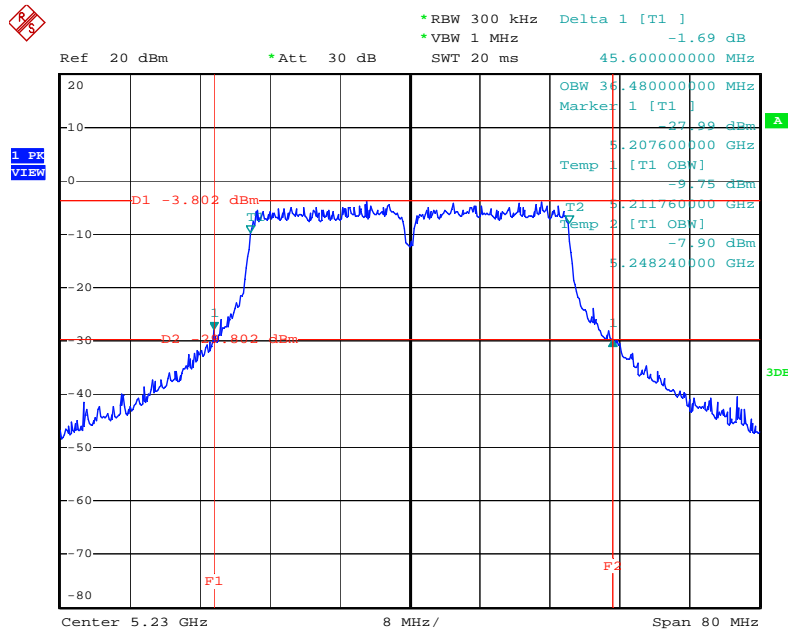

Date: 4.MAY.2010 11:25:03

26 dB Bandwidth Plot on Configuration IEEE 802.11a A1+A5 / 5180 MHz

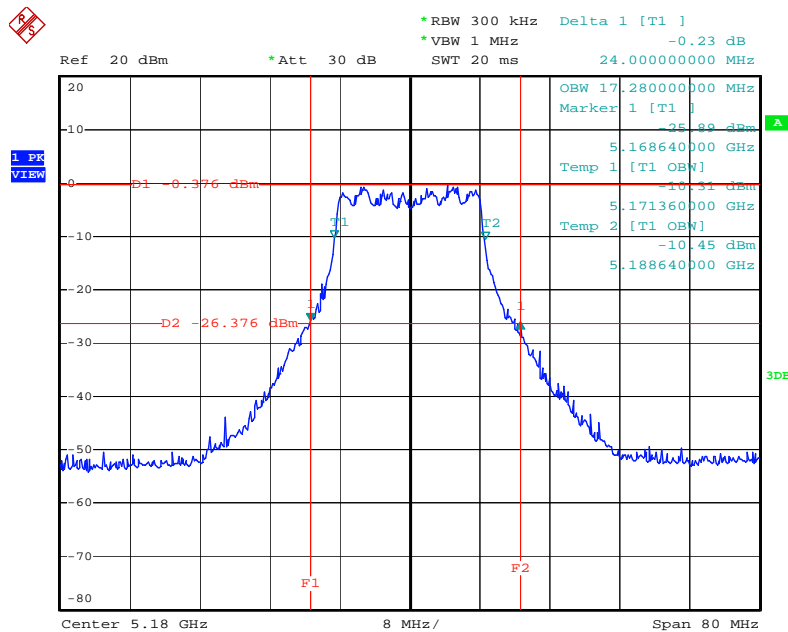

Date: 4.MAY.2010 12:19:20

### 26 dB Bandwidth Plot on Configuration IEEE 802.11a A1+A5 / 5200 MHz

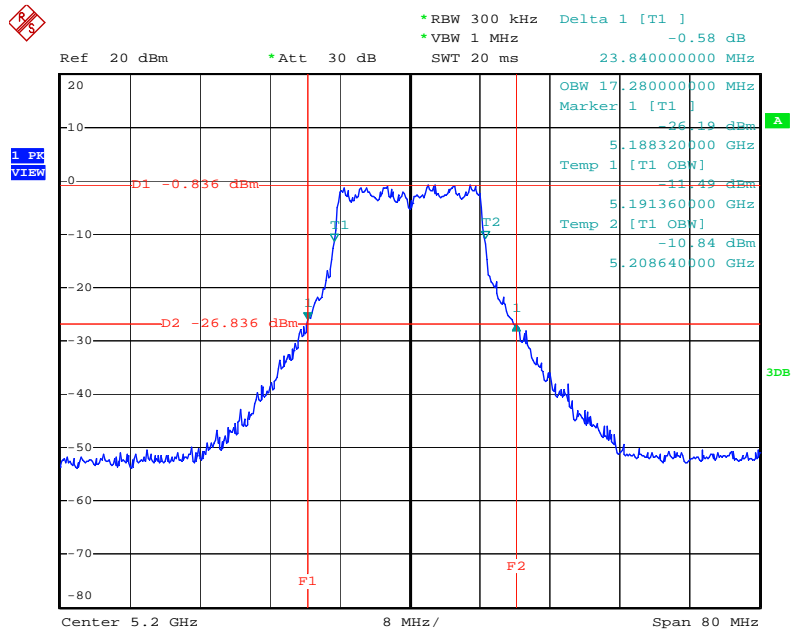

Date: 4.MAY.2010 12:17:40

### 26 dB Bandwidth Plot on Configuration IEEE 802.11a A1+A5 / 5240 MHz

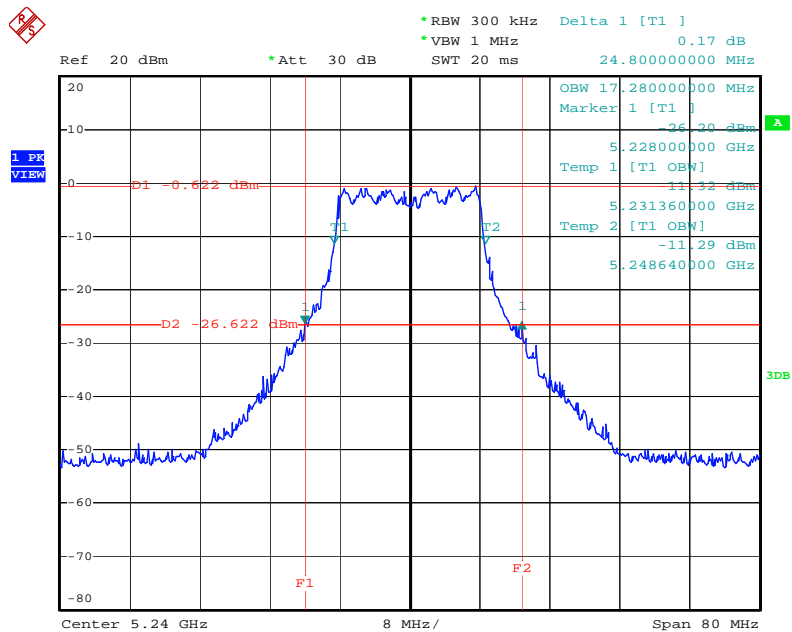

Date: 4.MAY.2010 12:16:19

< For Ant. 6 >

26 dB Bandwidth Plot on Configuration IEEE 802.11n MCS8 20MHz A1+A5 / 5180 MHz

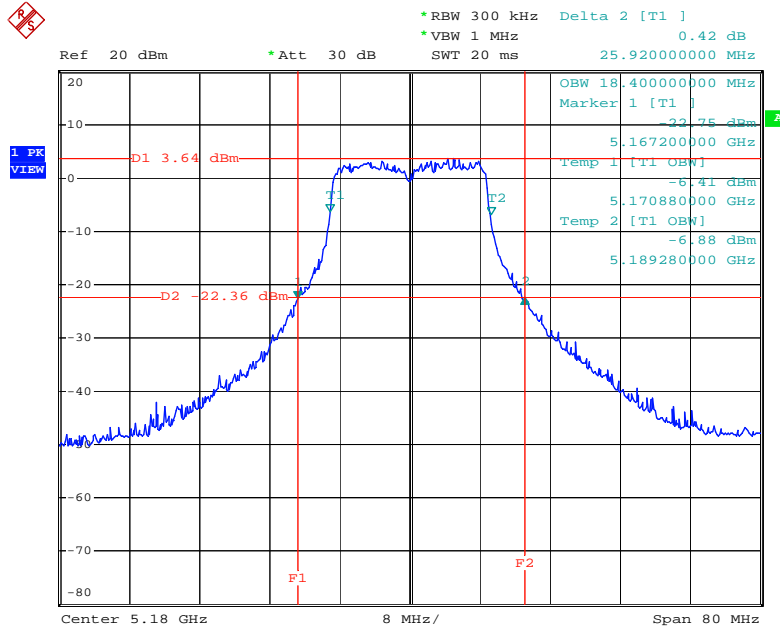

Date: 6.MAY.2010 15:41:29

26 dB Bandwidth Plot on Configuration IEEE 802.11n MCS8 20MHz A1+A5 / 5200 MHz

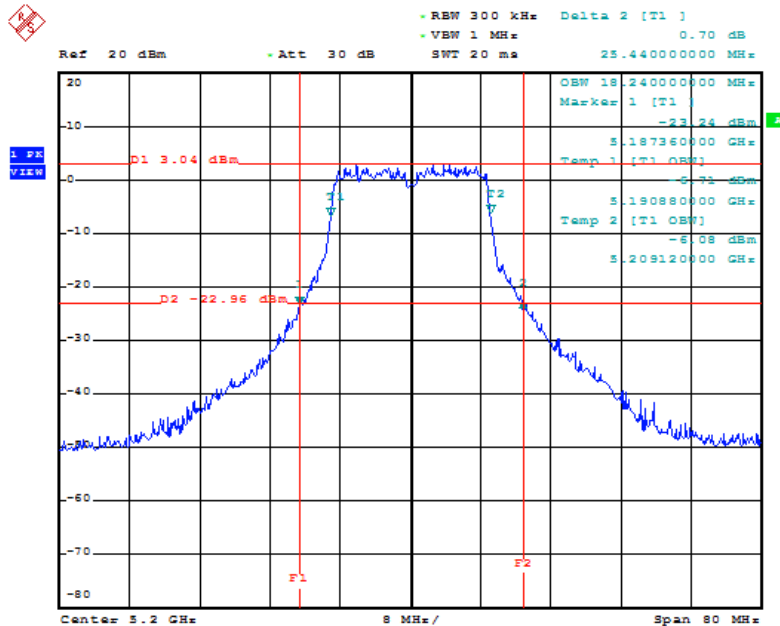

Date: 6.MAY.2010 15:49:14

26 dB Bandwidth Plot on Configuration IEEE 802.11n MCS8 20MHz A1+A5 / 5240 MHz

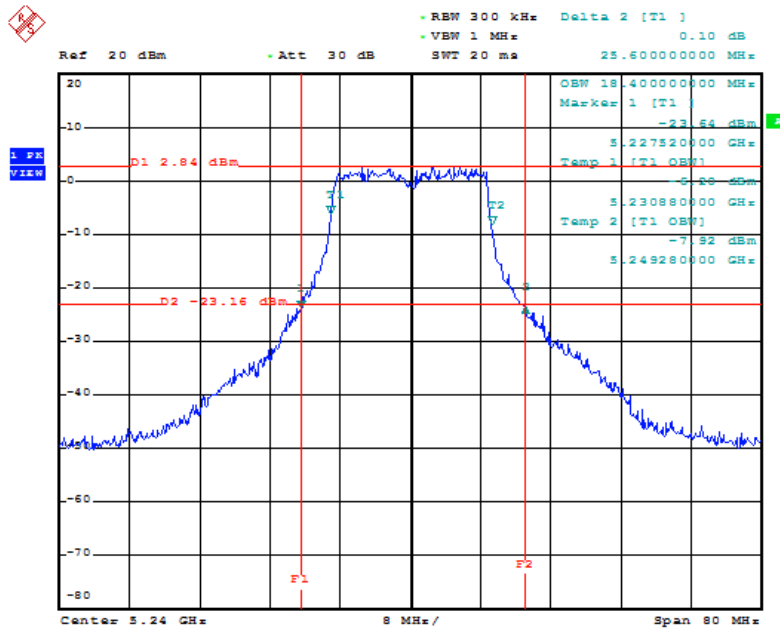

Date: 6.MAY.2010 16:05:10

26 dB Bandwidth Plot on Configuration IEEE 802.11n MCS8 40MHz A1+A5 / 5190 MHz

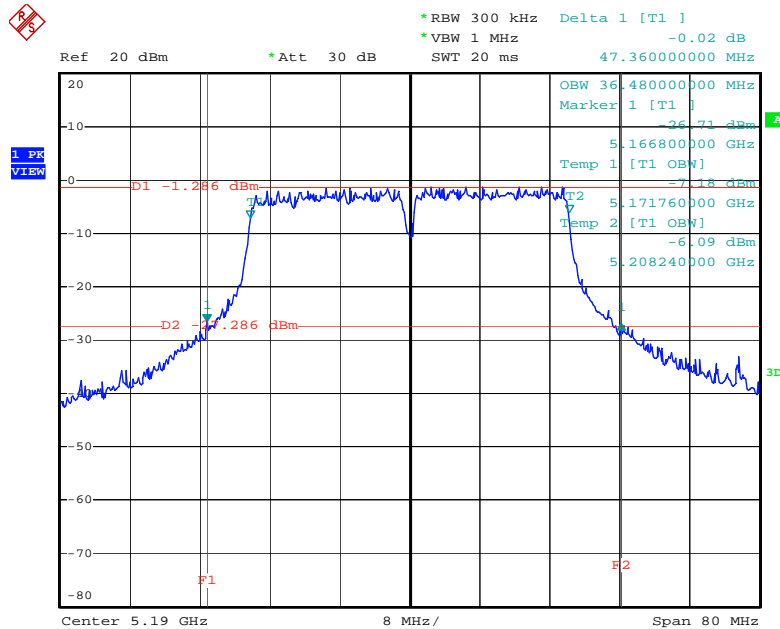

Date: 5.MAY.2010 14:31:38



26 dB Bandwidth Plot on Configuration IEEE 802.11n MCS8 40MHz A1+A5 / 5230 MHz

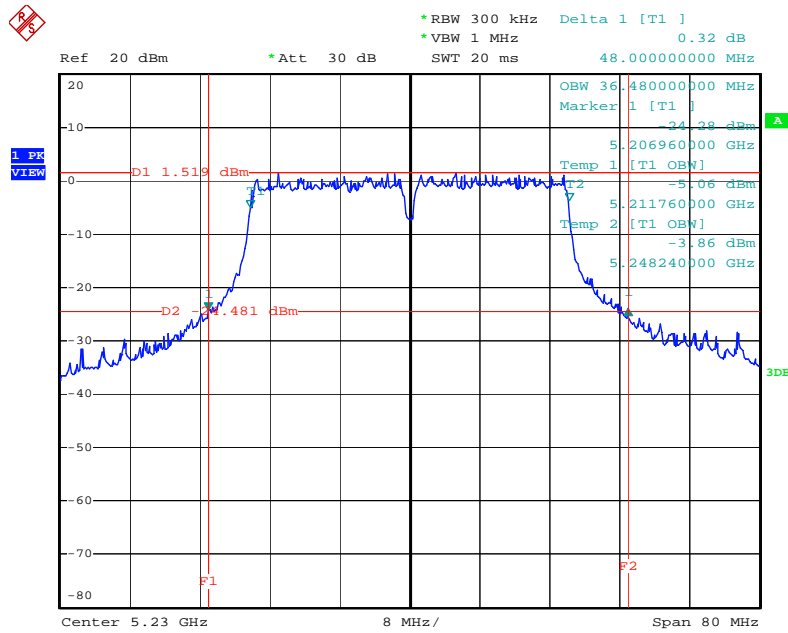

Date: 5.MAY.2010 14:29:57

26 dB Bandwidth Plot on Configuration IEEE 802.11a A1+A5 / 5180 MHz

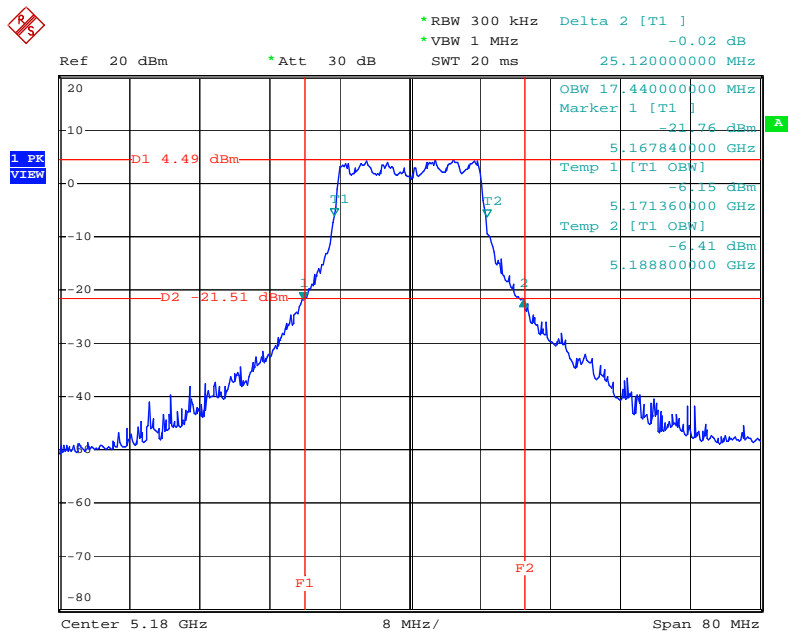

Date: 6.MAY.2010 17:16:55

### 26 dB Bandwidth Plot on Configuration IEEE 802.11a A1+A5 / 5200 MHz

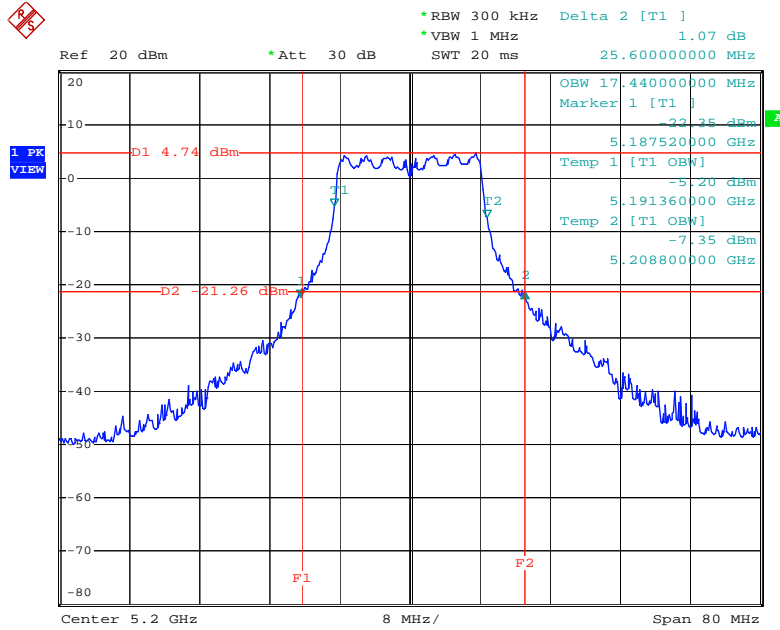

Date: 6.MAY.2010 17:13:34

### 26 dB Bandwidth Plot on Configuration IEEE 802.11a A1+A5 / 5240 MHz

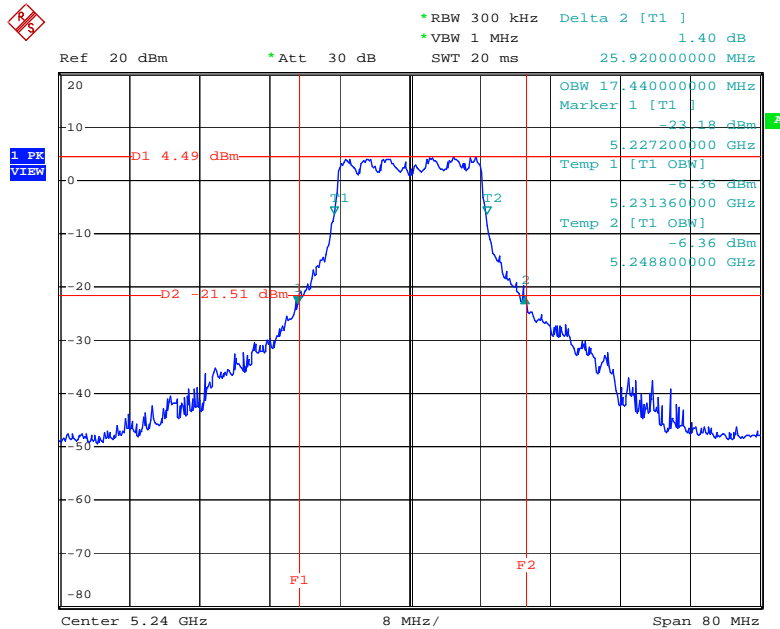

Date: 6.MAY.2010 17:10:12

### 4.3. Maximum Conducted Output Power Measurement

#### 4.3.1. Limit

For the band 5.15~5.25 GHz, the maximum conducted output power over the frequency band of operation shall not exceed the lesser of 50 mW (17dBm) or  $4 \text{ dBm} + 10\log B$ , where B is the 26 dB emissions bandwidth in MHz. If transmitting antennas of directional gain greater than 6 dBi are used, the peak output power and power density from the intentional radiator shall be reduced by the amount in dB that the directional gain of the antenna exceeds 6 dBi.

However, fixed point-to-point U-NII devices operating in this band may employ transmitting antennas with directional gain up to 23 dBi without any corresponding reduction in the transmitter peak output power and peak power spectral density. For fixed, point-to-point U-NII transmitters that employ a directional antenna gain greater than 23 dBi, a 1 dB reduction in peak transmitter power and peak power spectral density for each 1 dB of antenna gain in excess of 23 dBi would be required.

#### 4.3.2. Measuring Instruments and Setting

Please refer to section 5 of equipments list in this report. The following table is the setting of the spectrum analyzer.

Spectrum Parameter	Setting
Attenuation	Auto
Span Frequency	Encompass the entire emissions bandwidth (EBW) of the signal
RB	1000 kHz
VB	3000 kHz
Detector	RMS
Trace	MAX HOLD
Sweep Time	Auto

#### 4.3.3. Test Procedures

1. The transmitter output (antenna port) was connected to the spectrum analyzer.
2. Test was performed in accordance with FCC Public Notice DA 02-2138, August 30, 2002.
3. When measuring maximum conducted output power with multiple antenna systems, add every result of the values by mathematic formula.

#### 4.3.4. Test Setup Layout

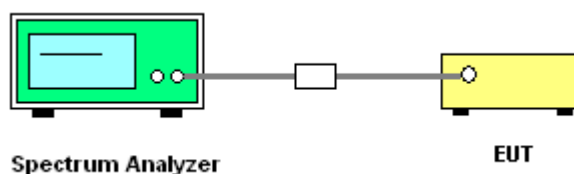

#### 4.3.5. Test Deviation

There is no deviation with the original standard.

#### 4.3.6. EUT Operation during Test

The EUT was programmed to be in continuously transmitting mode.

#### 4.3.7. Test Result of Maximum Conducted Output Power

< For Ant. 1 >

Temperature	24°C	Humidity	56%
Test Engineer	Johnson Chang	Configurations	IEEE 802.11n / Ant. 1

##### Configuration IEEE 802.11n MCS8 20MHz A1

Channel	Frequency	Conducted Power (dBm)	Max. Limit (dBm)	Result
36	5180 MHz	14.01	17.00	Complies
40	5200 MHz	13.74	17.00	Complies
48	5240 MHz	13.76	17.00	Complies

##### Configuration IEEE 802.11n MCS8 20MHz A5

Channel	Frequency	Conducted Power (dBm)	Max. Limit (dBm)	Result
36	5180 MHz	13.91	17.00	Complies
40	5200 MHz	13.55	17.00	Complies
48	5240 MHz	13.72	17.00	Complies

##### Configuration IEEE 802.11n MCS8 20MHz A1+A5

Channel	Frequency	Conducted Power (dBm)	Max. Limit (dBm)	Result
36	5180 MHz	16.97	17.00	Complies
40	5200 MHz	16.66	17.00	Complies
48	5240 MHz	16.75	17.00	Complies

**Configuration IEEE 802.11n MCS8 40MHz A1**

Channel	Frequency	Conducted Power (dBm)	Max. Limit (dBm)	Result
38	5190 MHz	12.97	17.00	Complies
46	5230 MHz	13.90	17.00	Complies

**Configuration IEEE 802.11nMCS8 40MHz A5**

Channel	Frequency	Conducted Power (dBm)	Max. Limit (dBm)	Result
38	5190 MHz	12.87	17.00	Complies
46	5230 MHz	13.54	17.00	Complies

**Configuration IEEE 802.11n MCS8 40MHz A1+A5**

Channel	Frequency	Conducted Power (dBm)	Max. Limit (dBm)	Result
38	5190 MHz	15.93	17.00	Complies
46	5230 MHz	16.73	17.00	Complies

Temperature	24°C	Humidity	56%
Test Engineer	Johnson Chang	Configurations	IEEE 802.11a / Ant. 1

**Configuration IEEE 802.11a A1**

Channel	Frequency	Conducted Power (dBm)	Max. Limit (dBm)	Result
36	5180 MHz	13.84	17.00	Complies
40	5200 MHz	13.74	17.00	Complies
48	5240 MHz	13.78	17.00	Complies

**Configuration IEEE 802.11a A5**

Channel	Frequency	Conducted Power (dBm)	Max. Limit (dBm)	Result
36	5180 MHz	13.90	17.00	Complies
40	5200 MHz	13.83	17.00	Complies
48	5240 MHz	13.80	17.00	Complies

**Configuration IEEE 802.11a A1+A5**

Channel	Frequency	Conducted Power (dBm)	Max. Limit (dBm)	Result
36	5180 MHz	16.88	17.00	Complies
40	5200 MHz	16.80	17.00	Complies
48	5240 MHz	16.80	17.00	Complies

Note: All the test values were listed in the report.

For plots, only the worse case of OFDM modulation was listed in the report.

&lt; For Ant. 2 &gt;

Temperature	24°C	Humidity	56%
Test Engineer	Johnson Chang	Configurations	IEEE 802.11n / Ant. 2

**Configuration IEEE 802.11n MCS8 20MHz A1**

Channel	Frequency	Conducted Power (dBm)	Max. Limit (dBm)	Result
36	5180 MHz	12.88	17.00	Complies
40	5200 MHz	13.47	17.00	Complies
48	5240 MHz	13.28	17.00	Complies

**Configuration IEEE 802.11n MCS8 20MHz A5**

Channel	Frequency	Conducted Power (dBm)	Max. Limit (dBm)	Result
36	5180 MHz	13.81	17.00	Complies
40	5200 MHz	14.34	17.00	Complies
48	5240 MHz	13.32	17.00	Complies

**Configuration IEEE 802.11n MCS8 20MHz A1+A5**

Channel	Frequency	Conducted Power (dBm)	Max. Limit (dBm)	Result
36	5180 MHz	16.38	17.00	Complies
40	5200 MHz	16.94	17.00	Complies
48	5240 MHz	16.31	17.00	Complies

**Configuration IEEE 802.11n MCS8 40MHz A1**

Channel	Frequency	Conducted Power (dBm)	Max. Limit (dBm)	Result
38	5190 MHz	12.97	17.00	Complies
46	5230 MHz	13.23	17.00	Complies

**Configuration IEEE 802.11nMCS8 40MHz A5**

Channel	Frequency	Conducted Power (dBm)	Max. Limit (dBm)	Result
38	5190 MHz	13.86	17.00	Complies
46	5230 MHz	13.83	17.00	Complies

**Configuration IEEE 802.11n MCS8 40MHz A1+A5**

Channel	Frequency	Conducted Power (dBm)	Max. Limit (dBm)	Result
38	5190 MHz	16.45	17.00	Complies
46	5230 MHz	16.55	17.00	Complies



Temperature	24°C	Humidity	56%
Test Engineer	Johnson Chang	Configurations	IEEE 802.11a / Ant. 2

**Configuration IEEE 802.11a A1**

Channel	Frequency	Conducted Power (dBm)	Max. Limit (dBm)	Result
36	5180 MHz	12.63	17.00	Complies
40	5200 MHz	13.22	17.00	Complies
48	5240 MHz	13.56	17.00	Complies

**Configuration IEEE 802.11a A5**

Channel	Frequency	Conducted Power (dBm)	Max. Limit (dBm)	Result
36	5180 MHz	14.54	17.00	Complies
40	5200 MHz	14.41	17.00	Complies
48	5240 MHz	13.86	17.00	Complies

**Configuration IEEE 802.11a A1+A5**

Channel	Frequency	Conducted Power (dBm)	Max. Limit (dBm)	Result
36	5180 MHz	16.70	17.00	Complies
40	5200 MHz	16.87	17.00	Complies
48	5240 MHz	16.72	17.00	Complies

Note: All the test values were listed in the report.

For plots, only the worse case of OFDM modulation was listed in the report.

< For Ant. 3 >

Temperature	24°C	Humidity	56%
Test Engineer	Johnson Chang	Configurations	IEEE 802.11n / Ant. 3

**Configuration IEEE 802.11n MCS8 20MHz A1**

Channel	Frequency	Conducted Power (dBm)	Max. Limit (dBm)	Result
36	5180 MHz	10.52	14.04	Complies
40	5200 MHz	10.64	14.04	Complies
48	5240 MHz	10.59	14.04	Complies

**Configuration IEEE 802.11n MCS8 20MHz A5**

Channel	Frequency	Conducted Power (dBm)	Max. Limit (dBm)	Result
36	5180 MHz	11.26	14.04	Complies
40	5200 MHz	11.37	14.04	Complies
48	5240 MHz	10.57	14.04	Complies

**Configuration IEEE 802.11n MCS8 20MHz A1+A5**

Channel	Frequency	Conducted Power (dBm)	Max. Limit (dBm)	Result
36	5180 MHz	13.92	14.04	Complies
40	5200 MHz	14.03	14.04	Complies
48	5240 MHz	13.72	14.04	Complies

**Configuration IEEE 802.11n MCS8 40MHz A1**

Channel	Frequency	Conducted Power (dBm)	Max. Limit (dBm)	Result
38	5190 MHz	9.81	14.04	Complies
46	5230 MHz	10.85	14.04	Complies

**Configuration IEEE 802.11nMCS8 40MHz A5**

Channel	Frequency	Conducted Power (dBm)	Max. Limit (dBm)	Result
38	5190 MHz	10.56	14.04	Complies
46	5230 MHz	11.00	14.04	Complies

**Configuration IEEE 802.11n MCS8 40MHz A1+A5**

Channel	Frequency	Conducted Power (dBm)	Max. Limit (dBm)	Result
38	5190 MHz	13.21	14.04	Complies
46	5230 MHz	13.94	14.04	Complies

Temperature	24°C	Humidity	56%
Test Engineer	Johnson Chang	Configurations	IEEE 802.11a / Ant. 3

**Configuration IEEE 802.11a A1**

Channel	Frequency	Conducted Power (dBm)	Max. Limit (dBm)	Result
36	5180 MHz	10.64	14.04	Complies
40	5200 MHz	10.44	14.04	Complies
48	5240 MHz	10.87	14.04	Complies

**Configuration IEEE 802.11a A5**

Channel	Frequency	Conducted Power (dBm)	Max. Limit (dBm)	Result
36	5180 MHz	11.25	14.04	Complies
40	5200 MHz	10.97	14.04	Complies
48	5240 MHz	10.76	14.04	Complies

**Configuration IEEE 802.11a A1+A5**

Channel	Frequency	Conducted Power (dBm)	Max. Limit (dBm)	Result
36	5180 MHz	13.97	14.04	Complies
40	5200 MHz	13.72	14.04	Complies
48	5240 MHz	13.83	14.04	Complies

Note: All the test values were listed in the report.

For plots, only the worse case of OFDM modulation was listed in the report.

< For Ant. 4 >

Temperature	24°C	Humidity	56%
Test Engineer	Johnson Chang	Configurations	IEEE 802.11n / Ant. 4

**Configuration IEEE 802.11n MCS8 20MHz A1**

Channel	Frequency	Conducted Power (dBm)	Max. Limit (dBm)	Result
36	5180 MHz	7.56	11.24	Complies
40	5200 MHz	8.12	11.24	Complies
48	5240 MHz	8.09	11.24	Complies

**Configuration IEEE 802.11n MCS8 20MHz A5**

Channel	Frequency	Conducted Power (dBm)	Max. Limit (dBm)	Result
36	5180 MHz	7.51	11.24	Complies
40	5200 MHz	8.24	11.24	Complies
48	5240 MHz	8.31	11.24	Complies

**Configuration IEEE 802.11n MCS8 20MHz A1+A5**

Channel	Frequency	Conducted Power (dBm)	Max. Limit (dBm)	Result
36	5180 MHz	10.55	11.24	Complies
40	5200 MHz	11.19	11.24	Complies
48	5240 MHz	11.21	11.24	Complies

**Configuration IEEE 802.11n MCS8 40MHz A1**

Channel	Frequency	Conducted Power (dBm)	Max. Limit (dBm)	Result
38	5190 MHz	6.60	11.24	Complies
46	5230 MHz	8.00	11.24	Complies

**Configuration IEEE 802.11nMCS8 40MHz A5**

Channel	Frequency	Conducted Power (dBm)	Max. Limit (dBm)	Result
38	5190 MHz	6.42	11.24	Complies
46	5230 MHz	8.45	11.24	Complies

**Configuration IEEE 802.11n MCS8 40MHz A1+A5**

Channel	Frequency	Conducted Power (dBm)	Max. Limit (dBm)	Result
38	5190 MHz	9.52	11.24	Complies
46	5230 MHz	11.24	11.24	Complies

Temperature	24°C	Humidity	56%
Test Engineer	Johnson Chang	Configurations	IEEE 802.11a / Ant. 4

**Configuration IEEE 802.11a A1**

Channel	Frequency	Conducted Power (dBm)	Max. Limit (dBm)	Result
36	5180 MHz	8.09	11.24	Complies
40	5200 MHz	7.56	11.24	Complies
48	5240 MHz	7.85	11.24	Complies

**Configuration IEEE 802.11a A5**

Channel	Frequency	Conducted Power (dBm)	Max. Limit (dBm)	Result
36	5180 MHz	8.15	11.24	Complies
40	5200 MHz	8.30	11.24	Complies
48	5240 MHz	7.38	11.24	Complies

**Configuration IEEE 802.11a A1+A5**

Channel	Frequency	Conducted Power (dBm)	Max. Limit (dBm)	Result
36	5180 MHz	11.13	11.24	Complies
40	5200 MHz	10.96	11.24	Complies
48	5240 MHz	10.63	11.24	Complies

Note: All the test values were listed in the report.

For plots, only the worse case of OFDM modulation was listed in the report.

< For Ant. 6 >

Temperature	24°C	Humidity	56%
Test Engineer	Johnson Chang	Configurations	IEEE 802.11n / Ant. 6

**Configuration IEEE 802.11n MCS8 20MHz A1**

Channel	Frequency	Conducted Power (dBm)	Max. Limit (dBm)	Result
36	5180 MHz	12.88	17.00	Complies
40	5200 MHz	13.32	17.00	Complies
48	5240 MHz	13.30	17.00	Complies

**Configuration IEEE 802.11n MCS8 20MHz A5**

Channel	Frequency	Conducted Power (dBm)	Max. Limit (dBm)	Result
36	5180 MHz	13.81	17.00	Complies
40	5200 MHz	13.69	17.00	Complies
48	5240 MHz	13.59	17.00	Complies

**Configuration IEEE 802.11n MCS8 20MHz A1+A5**

Channel	Frequency	Conducted Power (dBm)	Max. Limit (dBm)	Result
36	5180 MHz	16.38	17.00	Complies
40	5200 MHz	16.52	17.00	Complies
48	5240 MHz	16.46	17.00	Complies



**Configuration IEEE 802.11n MCS8 40MHz A1**

Channel	Frequency	Conducted Power (dBm)	Max. Limit (dBm)	Result
38	5190 MHz	11.02	17.00	Complies
46	5230 MHz	13.39	17.00	Complies

**Configuration IEEE 802.11nMCS8 40MHz A5**

Channel	Frequency	Conducted Power (dBm)	Max. Limit (dBm)	Result
38	5190 MHz	11.60	17.00	Complies
46	5230 MHz	14.13	17.00	Complies

**Configuration IEEE 802.11n MCS8 40MHz A1+A5**

Channel	Frequency	Conducted Power (dBm)	Max. Limit (dBm)	Result
38	5190 MHz	14.33	17.00	Complies
46	5230 MHz	16.79	17.00	Complies

Temperature	24°C	Humidity	56%
Test Engineer	Johnson Chang	Configurations	IEEE 802.11a / Ant. 6

**Configuration IEEE 802.11a A1**

Channel	Frequency	Conducted Power (dBm)	Max. Limit (dBm)	Result
36	5180 MHz	13.24	17.00	Complies
40	5200 MHz	13.07	17.00	Complies
48	5240 MHz	13.44	17.00	Complies

**Configuration IEEE 802.11a A5**

Channel	Frequency	Conducted Power (dBm)	Max. Limit (dBm)	Result
36	5180 MHz	14.22	17.00	Complies
40	5200 MHz	13.90	17.00	Complies
48	5240 MHz	13.83	17.00	Complies

**Configuration IEEE 802.11a A1+A5**

Channel	Frequency	Conducted Power (dBm)	Max. Limit (dBm)	Result
36	5180 MHz	16.77	17.00	Complies
40	5200 MHz	16.52	17.00	Complies
48	5240 MHz	16.65	17.00	Complies

Note: All the test values were listed in the report.

For plots, only the worse case of OFDM modulation was listed in the report.

< For Ant. 1 >

Conducted Output Power Plot on Configuration IEEE 802.11n MCS8 20MHz A1 / 5180 MHz

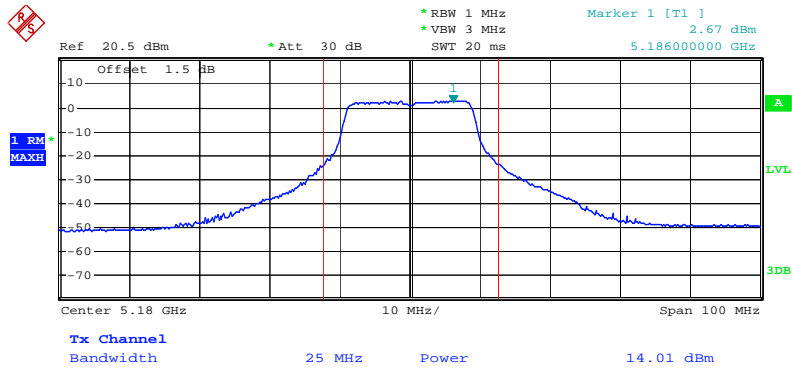

Date: 26.APR.2010 14:54:54

Conducted Output Power Plot on Configuration IEEE 802.11n MCS8 20MHz A1 / 5200 MHz

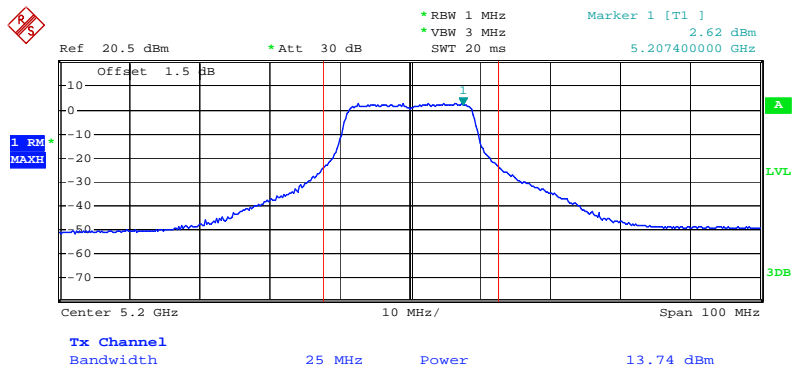

Date: 26.APR.2010 14:55:55

Conducted Output Power Plot on Configuration IEEE 802.11n MCS8 20MHz A1 / 5240 MHz

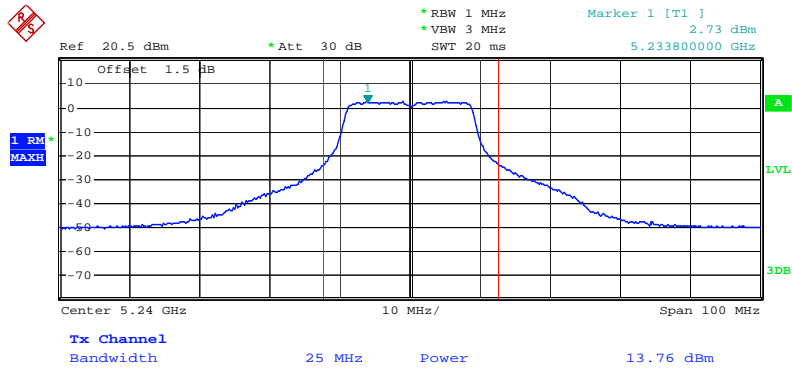

Date: 26.APR.2010 14:58:08

Conducted Output Power Plot on Configuration IEEE 802.11n MCS8 20MHz A5 / 5180 MHz

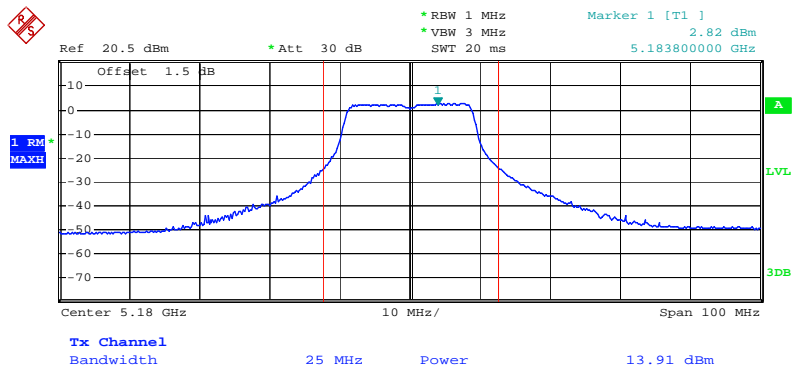

Date: 26.APR.2010 14:54:21

Conducted Output Power Plot on Configuration IEEE 802.11n MCS8 20MHz A5 / 5200 MHz

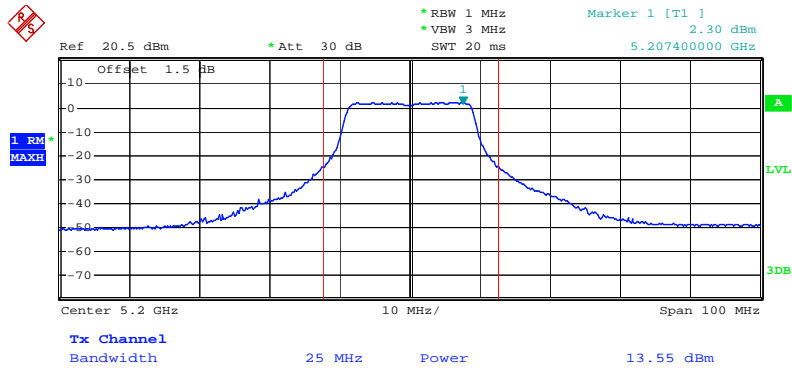

Date: 26.APR.2010 14:56:27

Conducted Output Power Plot on Configuration IEEE 802.11n MCS8 20MHz A5 / 5240 MHz

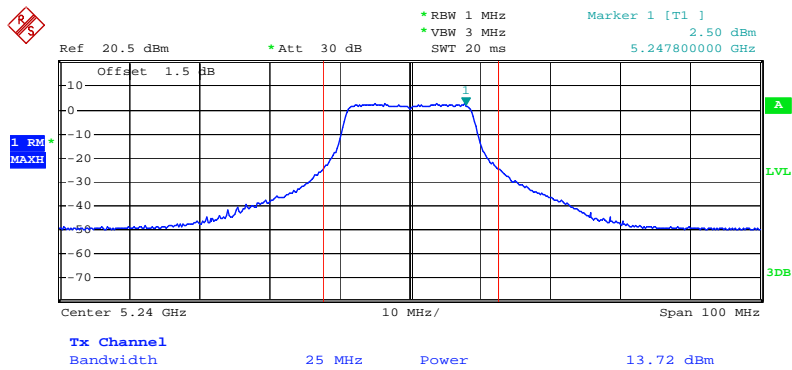

Date: 26.APR.2010 14:57:34

< For Ant. 2 >

Conducted Output Power Plot on Configuration IEEE 802.11n MCS8 20MHz A1 / 5180 MHz

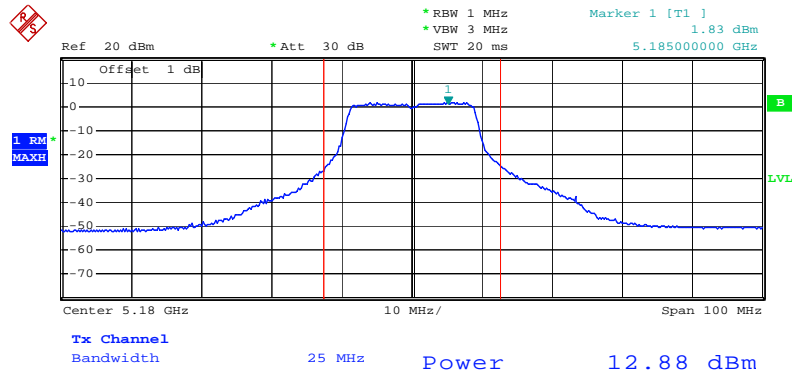

Date: 30.APR.2010 19:40:39

Conducted Output Power Plot on Configuration IEEE 802.11n MCS8 20MHz A1 / 5200 MHz

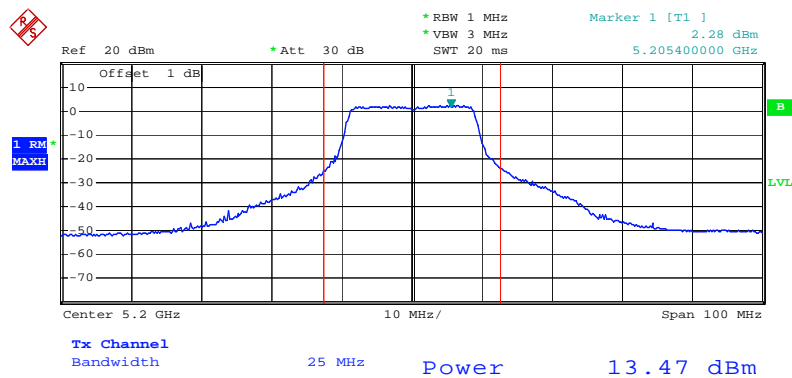

Date: 30.APR.2010 19:39:19

Conducted Output Power Plot on Configuration IEEE 802.11n MCS8 20MHz A1 / 5240 MHz

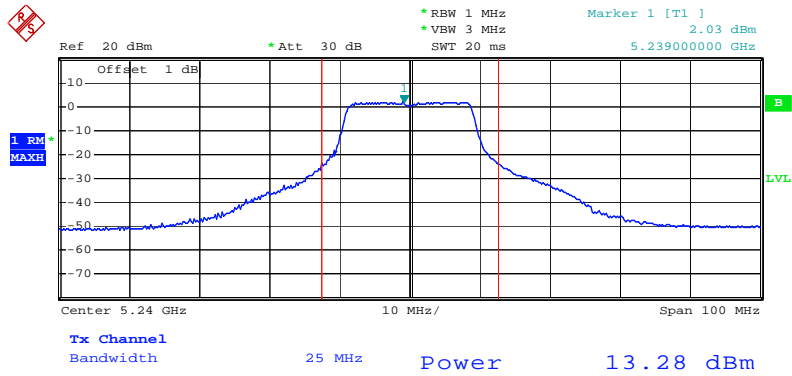

Date: 30.APR.2010 19:38:41

Conducted Output Power Plot on Configuration IEEE 802.11n MCS8 20MHz A5 / 5180 MHz

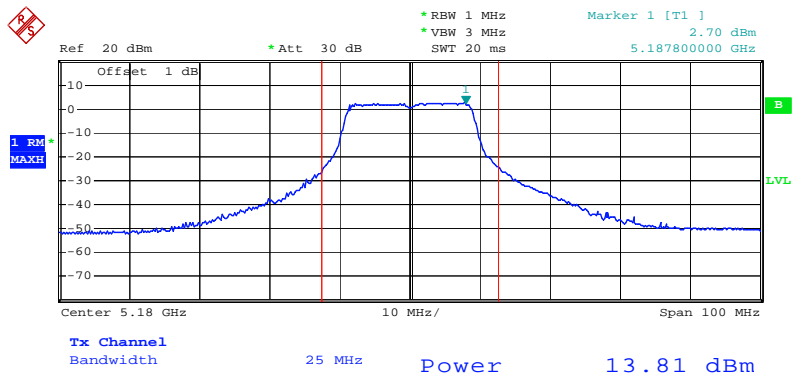

Date: 30.APR.2010 19:40:57

### Conducted Output Power Plot on Configuration IEEE 802.11n MCS8 20MHz A5 / 5200 MHz

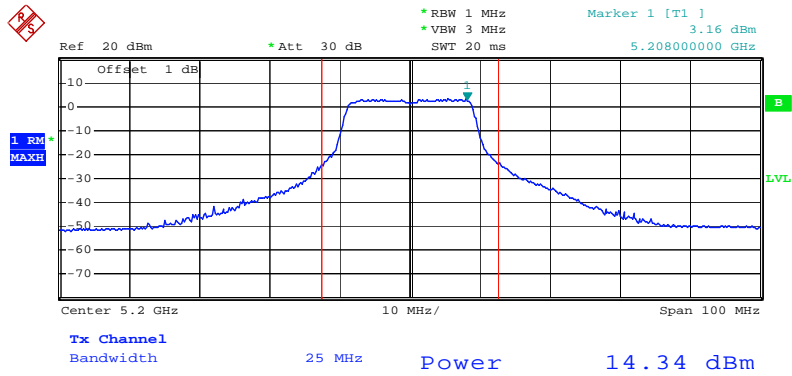

Date: 30.APR.2010 19:39:30

### Conducted Output Power Plot on Configuration IEEE 802.11n MCS8 20MHz A5 / 5240 MHz

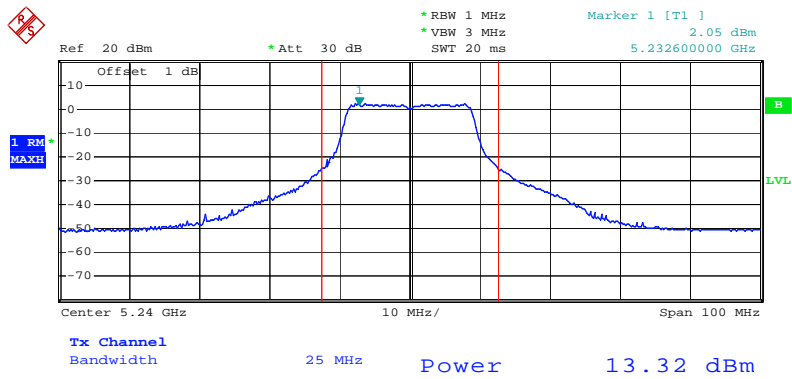

Date: 30.APR.2010 19:38:23



< For Ant. 3 >

### Conducted Output Power Plot on Configuration IEEE 802.11n MCS8 20MHz A1 / 5180 MHz

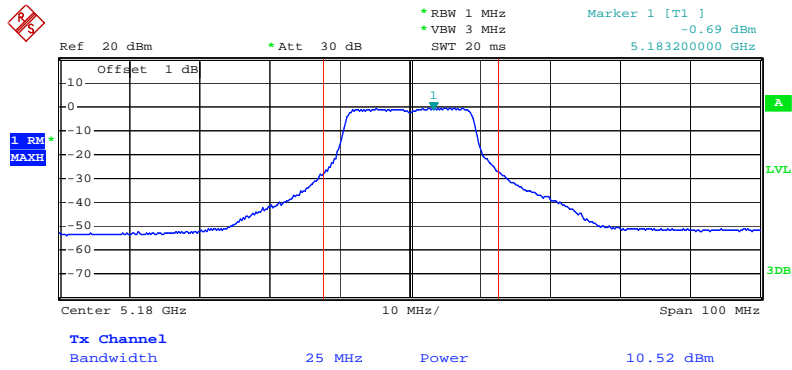

Date: 3.MAY.2010 14:44:28

### Conducted Output Power Plot on Configuration IEEE 802.11n MCS8 20MHz A1 / 5200 MHz

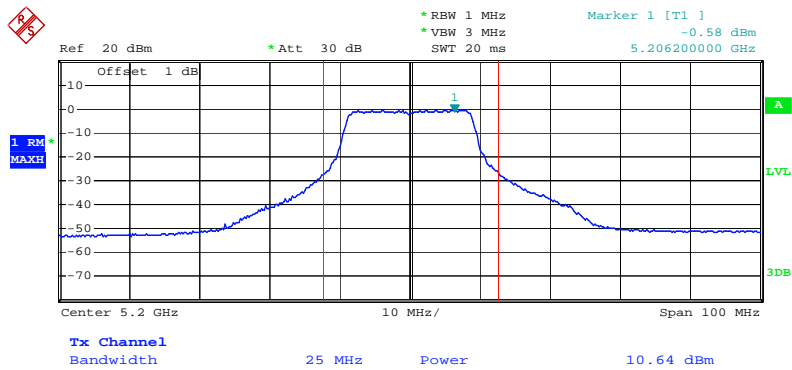

Date: 3.MAY.2010 14:57:52

Conducted Output Power Plot on Configuration IEEE 802.11n MCS8 20MHz A1 / 5240 MHz

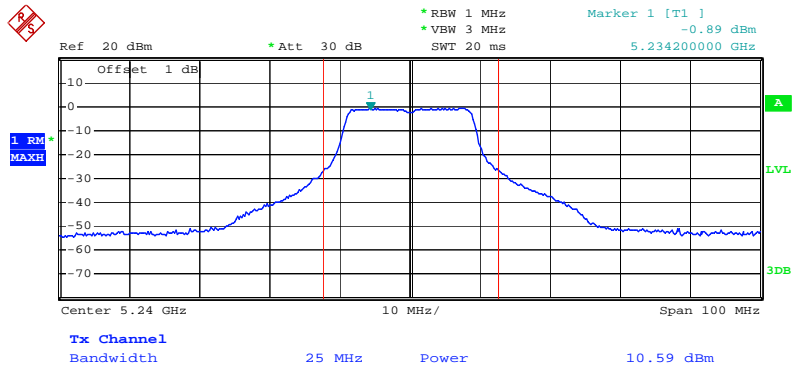

Date: 3.MAY.2010 15:08:37

Conducted Output Power Plot on Configuration IEEE 802.11n MCS8 20MHz A5 / 5180 MHz

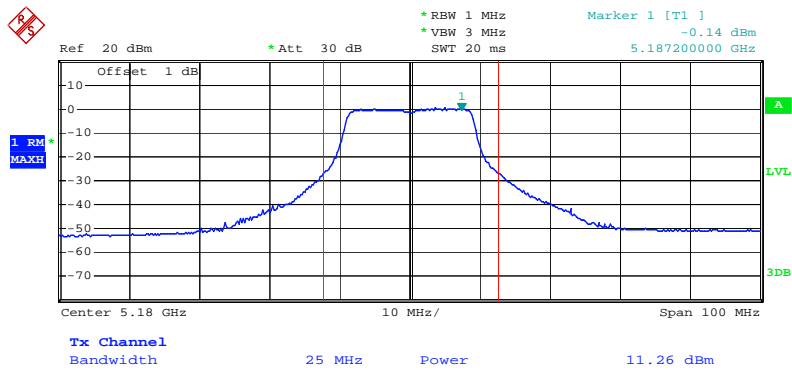

Date: 3.MAY.2010 14:43:57

Conducted Output Power Plot on Configuration IEEE 802.11n MCS8 20MHz A5 / 5200 MHz

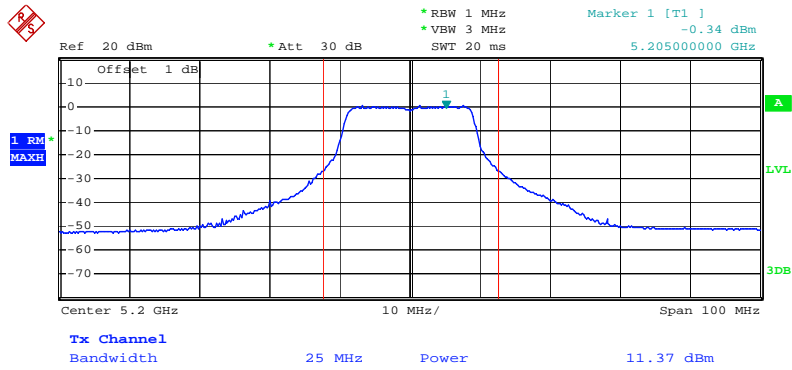

Date: 3.MAY.2010 14:59:49

Conducted Output Power Plot on Configuration IEEE 802.11n MCS8 20MHz A5 / 5240 MHz

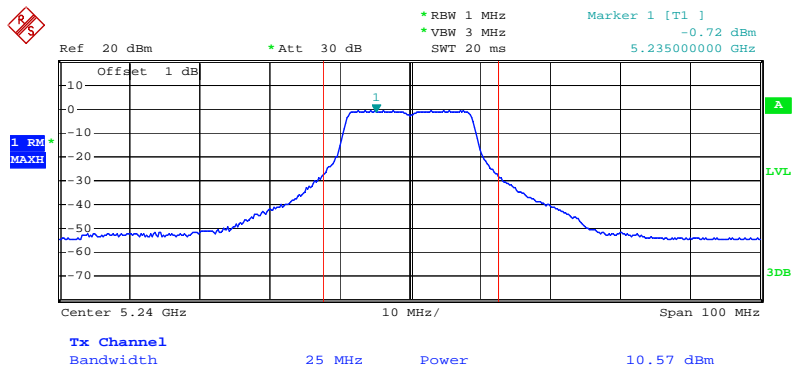

Date: 3.MAY.2010 15:07:01

< For Ant. 4 >

Conducted Output Power Plot on Configuration IEEE 802.11n MCS8 40MHz A1 / 5190 MHz

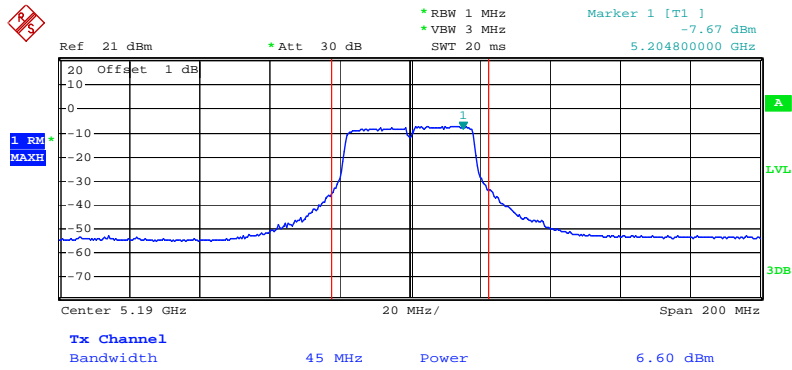

Date: 4.MAY.2010 10:51:31

Conducted Output Power Plot on Configuration IEEE 802.11n MCS8 40MHz A1 / 5230 MHz

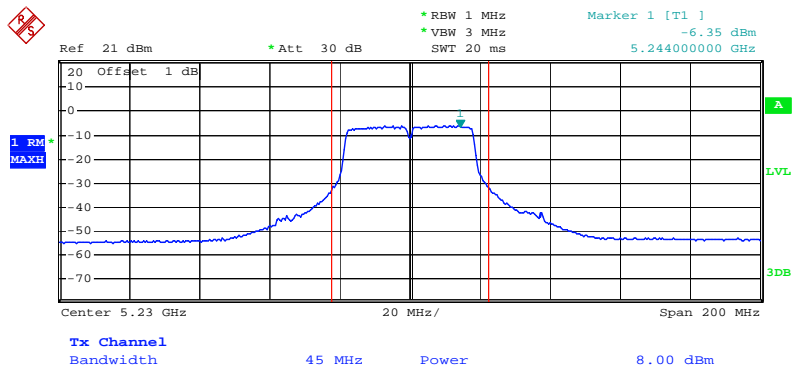

Date: 4.MAY.2010 10:53:51

## Conducted Output Power Plot on Configuration IEEE 802.11n MCS8 40MHz A5 / 5190 MHz

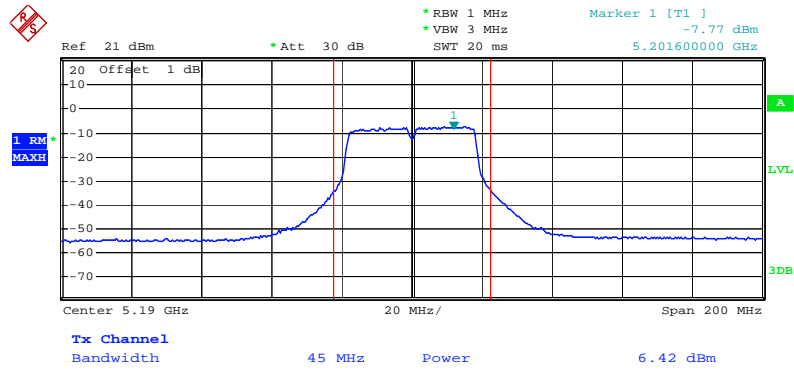

Date: 4.MAY.2010 10:51:55

## Conducted Output Power Plot on Configuration IEEE 802.11n MCS8 40MHz A5 / 5230 MHz

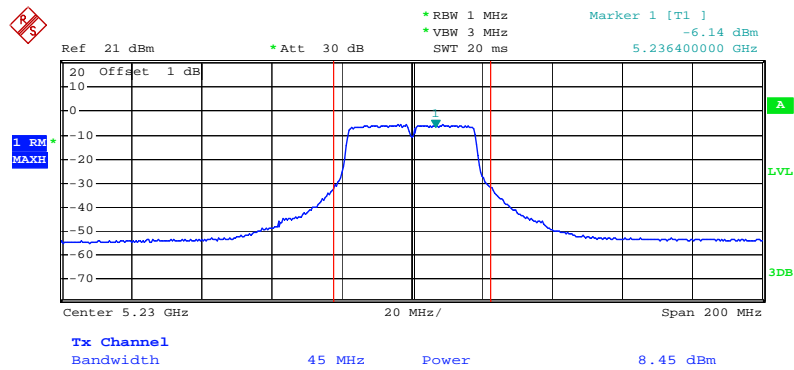

Date: 4.MAY.2010 10:53:17

< For Ant. 6 >

Conducted Output Power Plot on Configuration IEEE 802.11n MCS8 40MHz A1 / 5190 MHz

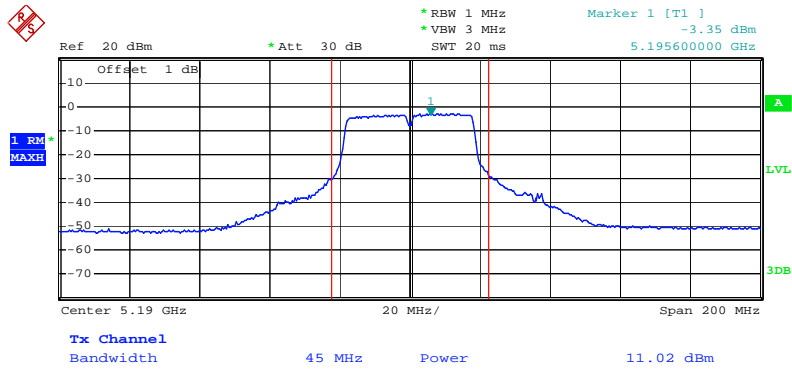

Date: 5.MAY.2010 14:00:23

Conducted Output Power Plot on Configuration IEEE 802.11n MCS8 40MHz A1 / 5230 MHz

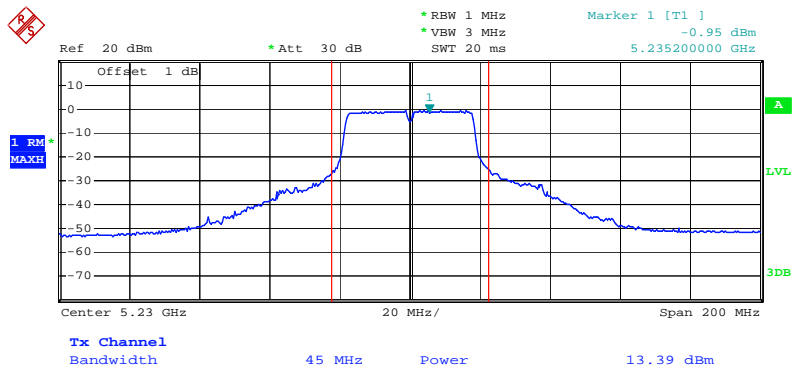

Date: 5.MAY.2010 14:02:46

Conducted Output Power Plot on Configuration IEEE 802.11n MCS8 40MHz A5 / 5190 MHz

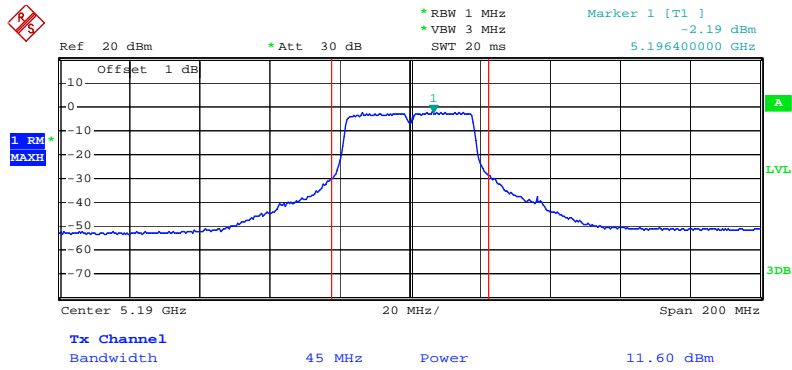

Date: 5.MAY.2010 14:00:59

Conducted Output Power Plot on Configuration IEEE 802.11n MCS8 40MHz A5 / 5230 MHz

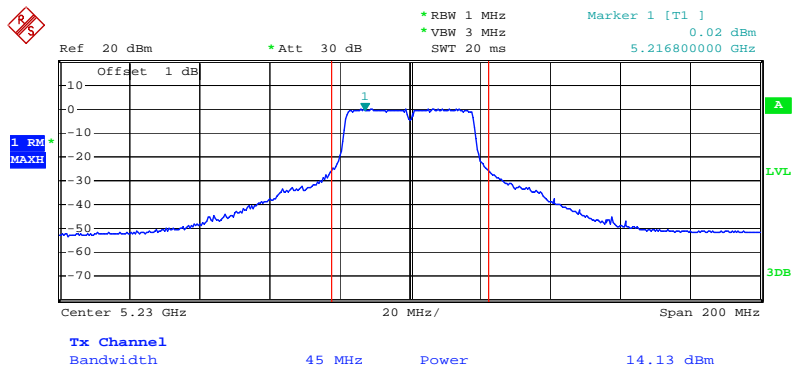

Date: 5.MAY.2010 14:03:16

## 4.4. Power Spectral Density Measurement

### 4.4.1. Limit

The power spectral density is defined as the highest level of power in dBm per MHz generated by the transmitter within the power envelope. The following table is power spectral density limits and decrease power density limit rule refer to section 4.3.1.

Frequency Range	Power Spectral Density limit (dBm/MHz)
5.15~5.25 GHz	4

### 4.4.2. Measuring Instruments and Setting

Please refer to section 5 of equipments list in this report. The following table is the setting of the spectrum analyzer.

Spectrum Parameter	Setting
Attenuation	Auto
Span Frequency	Encompass the entire emissions bandwidth (EBW) of the signal
RB	1000 kHz
VB	3000 kHz
Detector	Peak
Trace	Max Hold
Sweep Time	Auto

### 4.4.3. Test Procedures

1. The transmitter output (antenna port) was connected to the spectrum analyzer.
2. Set RBW of spectrum analyzer to 1000kHz and VBW to 3000kHz. Set Detector to Peak, Trace to Max Hold. Mark the frequency with maximum peak power as the center of the display of the spectrum.
3. Measuring multiple antennas, the connector is required to link with spectrum analyzer through a combiner.

### 4.4.4. Test Setup Layout

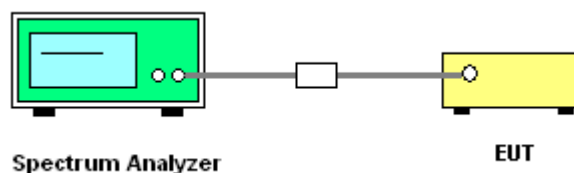

### 4.4.5. Test Deviation

There is no deviation with the original standard.



#### 4.4.6. EUT Operation during Test

The EUT was programmed to be in continuously transmitting mode.

#### 4.4.7. Test Result of Power Spectral Density

< For Ant. 1 >

Temperature	24°C	Humidity	56%
Test Engineer	Johnson Chang	Configurations	IEEE 802.11n / Ant. 1

##### Configuration IEEE 802.11n MCS8 20MHz A1+A5

Channel	Frequency	Power Density (dBm)	Max. Limit (dBm)	Result
36	5180 MHz	3.28	4.00	Complies
40	5200 MHz	3.09	4.00	Complies
48	5240 MHz	3.32	4.00	Complies

##### Configuration IEEE 802.11n MCS8 40MHz A1+A5

Channel	Frequency	Power Density (dBm)	Max. Limit (dBm)	Result
38	5190 MHz	-0.04	4.00	Complies
46	5230 MHz	0.58	4.00	Complies

<b>Temperature</b>	24°C	<b>Humidity</b>	56%
<b>Test Engineer</b>	Johnson Chang	<b>Configurations</b>	IEEE 802.11a / Ant. 1

**Configuration IEEE 802.11a A1+A5**

<b>Channel</b>	<b>Frequency</b>	<b>Power Density (dBm)</b>	<b>Max. Limit (dBm)</b>	<b>Result</b>
36	5180 MHz	1.68	4.00	<b>Complies</b>
40	5200 MHz	2.10	4.00	<b>Complies</b>
48	5240 MHz	2.74	4.00	<b>Complies</b>

Note: All the test values were listed in the report.

For plots, only the worse case of OFDM modulation was listed in the report.

< For Ant. 2 >

Temperature	24°C	Humidity	56%
Test Engineer	Johnson Chang	Configurations	IEEE 802.11n / Ant. 2

**Configuration IEEE 802.11n MCS8 20MHz A1+A5**

Channel	Frequency	Power Density (dBm)	Max. Limit (dBm)	Result
36	5180 MHz	1.82	4.00	Complies
40	5200 MHz	2.58	4.00	Complies
48	5240 MHz	1.37	4.00	Complies

**Configuration IEEE 802.11n MCS8 40MHz A1+A5**

Channel	Frequency	Power Density (dBm)	Max. Limit (dBm)	Result
38	5190 MHz	-1.32	4.00	Complies
46	5230 MHz	-2.02	4.00	Complies

<b>Temperature</b>	24°C	<b>Humidity</b>	56%
<b>Test Engineer</b>	Johnson Chang	<b>Configurations</b>	IEEE 802.11a / Ant. 2

**Configuration IEEE 802.11a A1+A5**

<b>Channel</b>	<b>Frequency</b>	<b>Power Density (dBm)</b>	<b>Max. Limit (dBm)</b>	<b>Result</b>
36	5180 MHz	3.29	4.00	<b>Complies</b>
40	5200 MHz	3.99	4.00	<b>Complies</b>
48	5240 MHz	3.48	4.00	<b>Complies</b>

Note: All the test values were listed in the report.

For plots, only the worse case of OFDM modulation was listed in the report.

< For Ant. 3 >

Temperature	24°C	Humidity	56%
Test Engineer	Johnson Chang	Configurations	IEEE 802.11n / Ant. 3

Configuration IEEE 802.11n MCS8 20MHz A1+A5

Channel	Frequency	Power Density (dBm)	Max. Limit (dBm)	Result
36	5180 MHz	-0.19	1.04	Complies
40	5200 MHz	-0.04	1.04	Complies
48	5240 MHz	0.00	1.04	Complies

Configuration IEEE 802.11n MCS8 40MHz A1+A5

Channel	Frequency	Power Density (dBm)	Max. Limit (dBm)	Result
38	5190 MHz	-3.07	1.04	Complies
46	5230 MHz	-2.86	1.04	Complies

<b>Temperature</b>	24°C	<b>Humidity</b>	56%
<b>Test Engineer</b>	Johnson Chang	<b>Configurations</b>	IEEE 802.11a / Ant. 3

**Configuration IEEE 802.11a A1+A5**

<b>Channel</b>	<b>Frequency</b>	<b>Power Density (dBm)</b>	<b>Max. Limit (dBm)</b>	<b>Result</b>
36	5180 MHz	0.57	1.04	<b>Complies</b>
40	5200 MHz	0.13	1.04	<b>Complies</b>
48	5240 MHz	0.72	1.04	<b>Complies</b>

Note: All the test values were listed in the report.

For plots, only the worse case of OFDM modulation was listed in the report.

< For Ant. 4 >

Temperature	24°C	Humidity	56%
Test Engineer	Johnson Chang	Configurations	IEEE 802.11n / Ant. 4

Configuration IEEE 802.11n MCS8 20MHz A1+A5

Channel	Frequency	Power Density (dBm)	Max. Limit (dBm)	Result
36	5180 MHz	-3.33	-1.76	Complies
40	5200 MHz	-3.25	-1.76	Complies
48	5240 MHz	-2.86	-1.76	Complies

Configuration IEEE 802.11n MCS8 40MHz A1+A5

Channel	Frequency	Power Density (dBm)	Max. Limit (dBm)	Result
38	5190 MHz	-7.21	-1.76	Complies
46	5230 MHz	-5.57	-1.76	Complies

<b>Temperature</b>	24°C	<b>Humidity</b>	56%
<b>Test Engineer</b>	Johnson Chang	<b>Configurations</b>	IEEE 802.11a / Ant. 4

**Configuration IEEE 802.11a A1+A5**

<b>Channel</b>	<b>Frequency</b>	<b>Power Density (dBm)</b>	<b>Max. Limit (dBm)</b>	<b>Result</b>
36	5180 MHz	-3.29	-1.76	<b>Complies</b>
40	5200 MHz	-3.03	-1.76	<b>Complies</b>
48	5240 MHz	-2.75	-1.76	<b>Complies</b>

Note: All the test values were listed in the report.

For plots, only the worse case of OFDM modulation was listed in the report.



< For Ant. 6 >

Temperature	24°C	Humidity	56%
Test Engineer	Johnson Chang	Configurations	IEEE 802.11n / Ant. 6

Configuration IEEE 802.11n MCS8 20MHz A1+A5

Channel	Frequency	Power Density (dBm)	Max. Limit (dBm)	Result
36	5180 MHz	1.82	4.00	Complies
40	5200 MHz	1.40	4.00	Complies
48	5240 MHz	1.71	4.00	Complies

Configuration IEEE 802.11n MCS8 40MHz A1+A5

Channel	Frequency	Power Density (dBm)	Max. Limit (dBm)	Result
38	5190 MHz	-2.87	4.00	Complies
46	5230 MHz	0.45	4.00	Complies

Temperature	24°C	Humidity	56%
Test Engineer	Johnson Chang	Configurations	IEEE 802.11a / Ant. 6

**Configuration IEEE 802.11a A1+A5**

Channel	Frequency	Power Density (dBm)	Max. Limit (dBm)	Result
36	5180 MHz	2.37	4.00	Complies
40	5200 MHz	1.90	4.00	Complies
48	5240 MHz	1.79	4.00	Complies

Note: All the test values were listed in the report.

For plots, only the worse case of OFDM modulation was listed in the report.

< For Ant. 1 >

Power Density Plot on Configuration IEEE 802.11n MCS8 20MHz A1+A5 / 5180 MHz

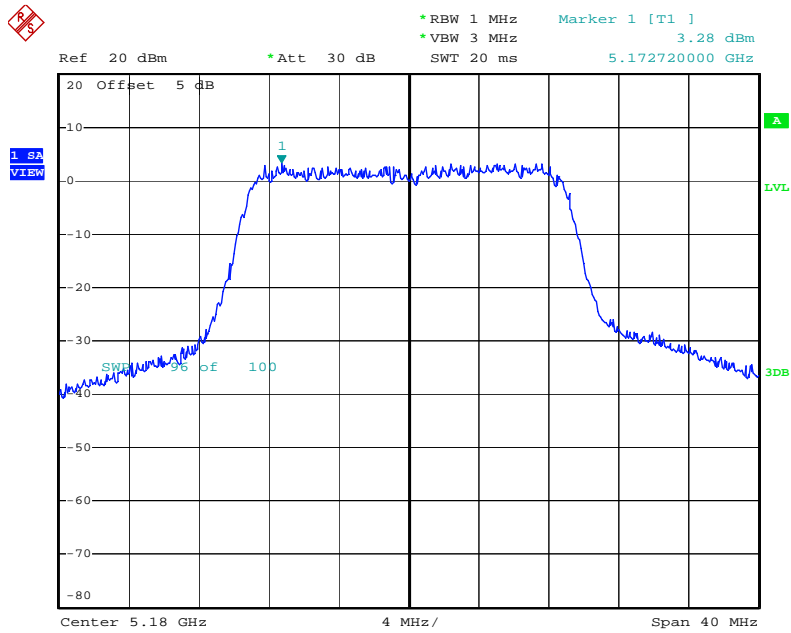

Date: 26.APR.2010 21:57:08

Power Density Plot on Configuration IEEE 802.11n MCS8 20MHz A1+A5 / 5200 MHz

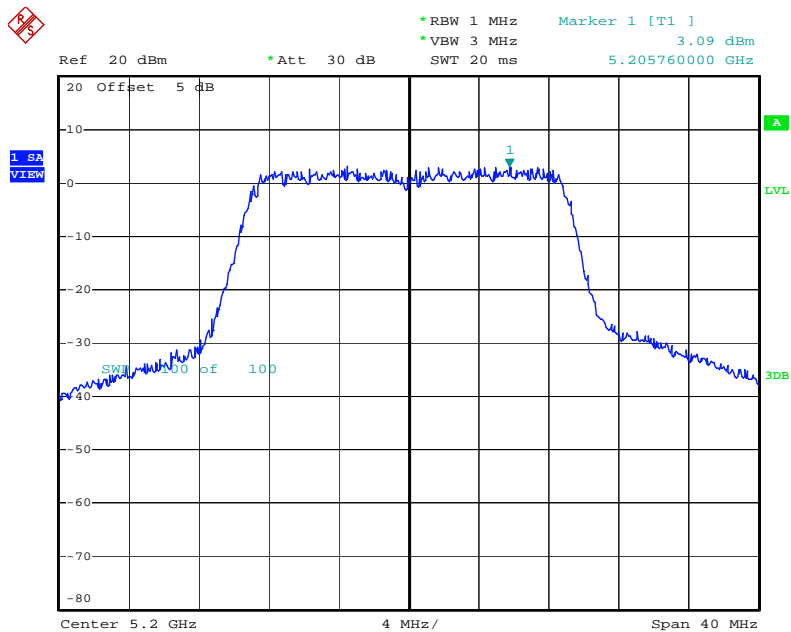

Date: 26.APR.2010 20:44:10

### Power Density Plot on Configuration IEEE 802.11n MCS8 20MHz A1+A5 / 5240 MHz

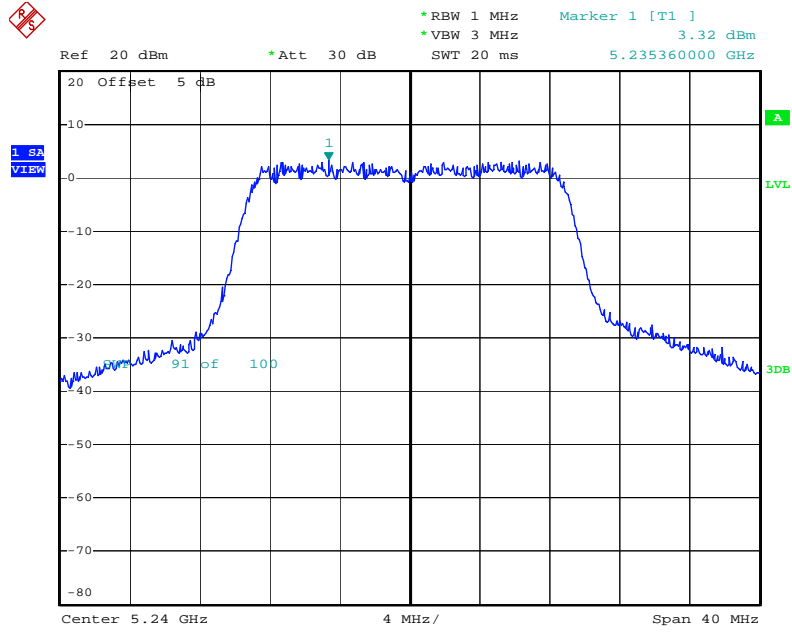

Date: 26.APR.2010 20:46:21

< For Ant. 2 >

Power Density Plot on Configuration IEEE 802.11a A1+A5 / 5180 MHz

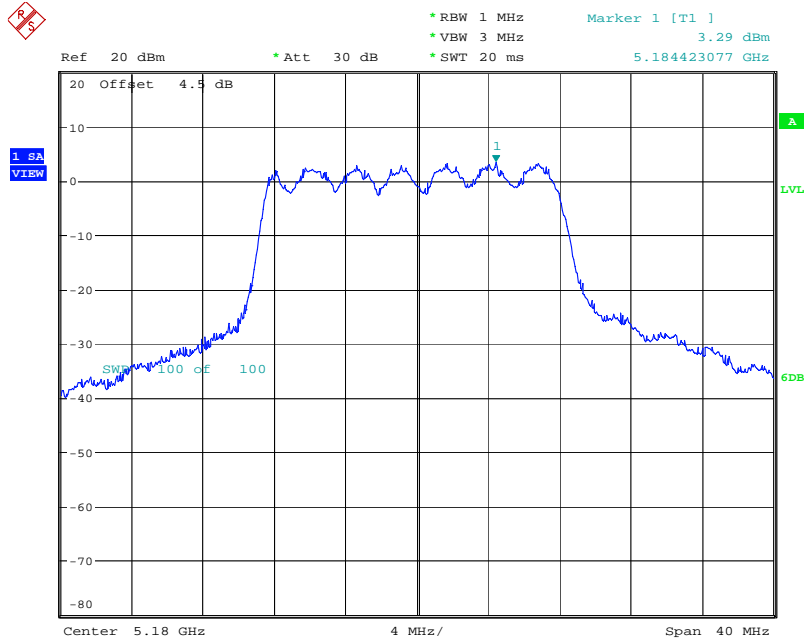

Date: 2.MAY.2010 16:14:20

Power Density Plot on Configuration IEEE 802.11a A1+A5 / 5200 MHz

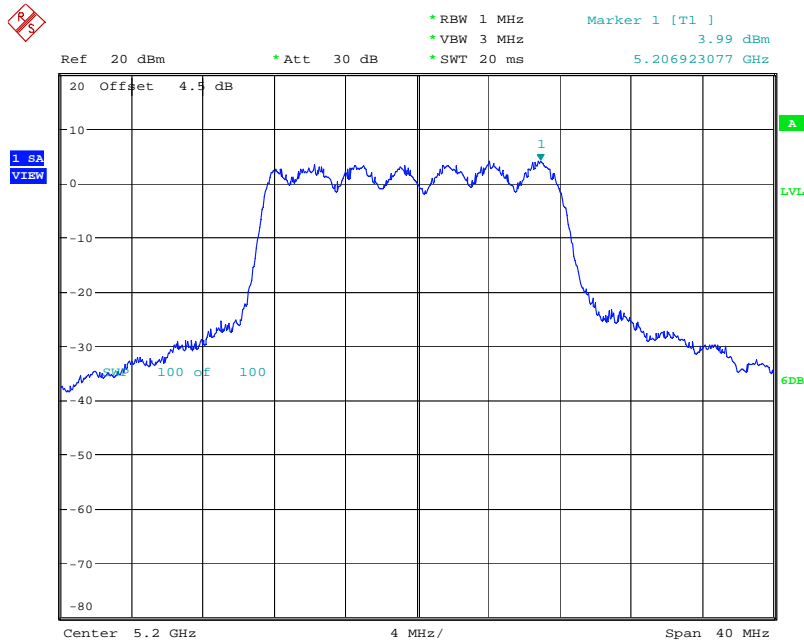

Date: 2.MAY.2010 16:17:58

### Power Density Plot on Configuration IEEE 802.11a A1+A5 / 5240 MHz

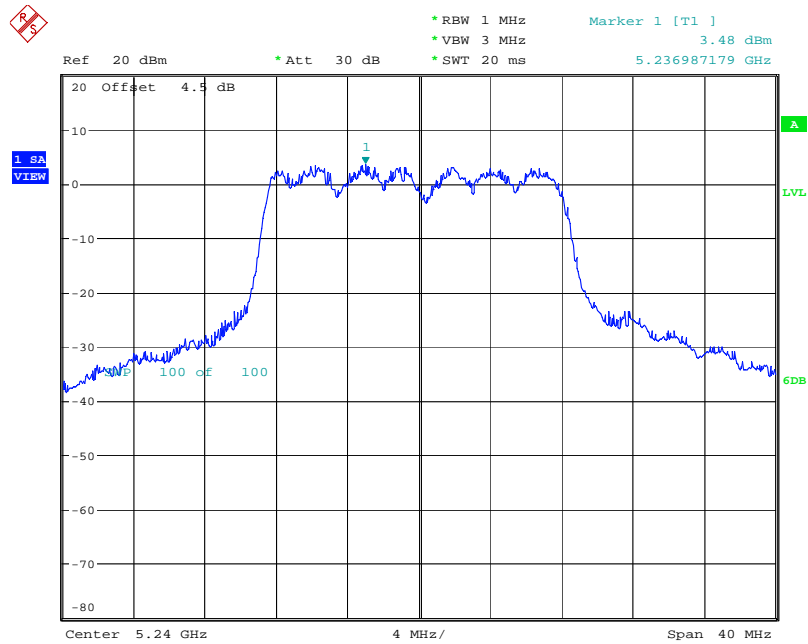

Date: 2.MAY.2010 16:19:20

< For Ant. 3 >

Power Density Plot on Configuration IEEE 802.11n MCS8 40MHz A1+A5 / 5190 MHz

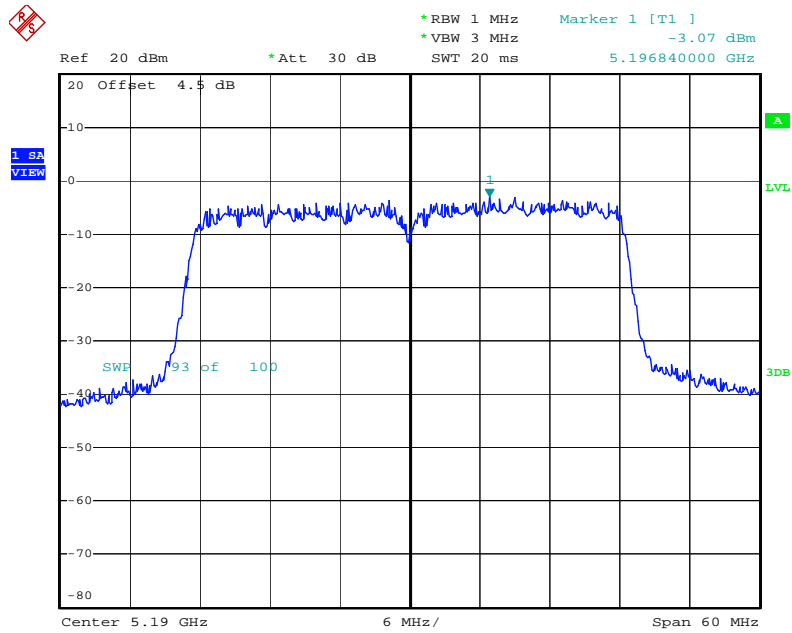

Date: 3.MAY.2010 17:02:30

Power Density Plot on Configuration IEEE 802.11n MCS8 40MHz A1+A5 / 5230 MHz

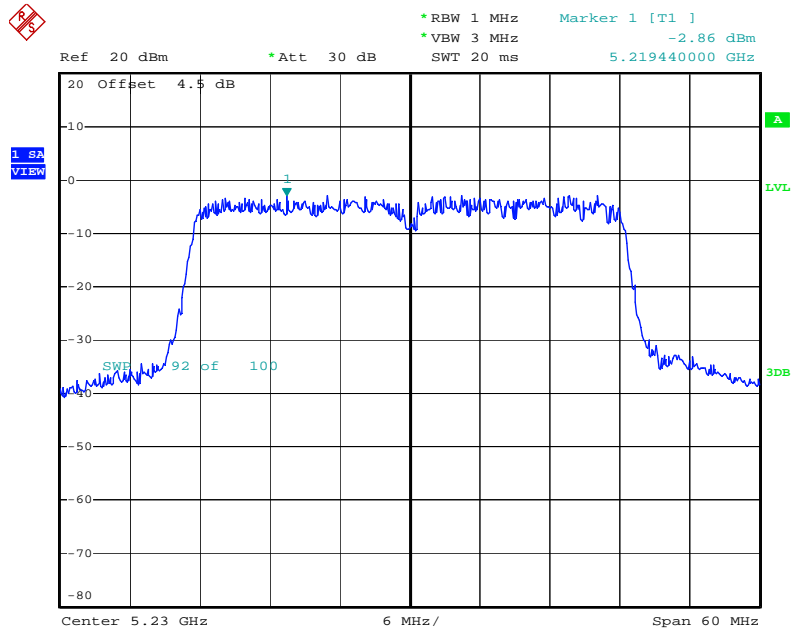

Date: 3.MAY.2010 17:04:58

< For Ant. 4 >

Power Density Plot on Configuration IEEE 802.11a A1+A5 / 5180 MHz

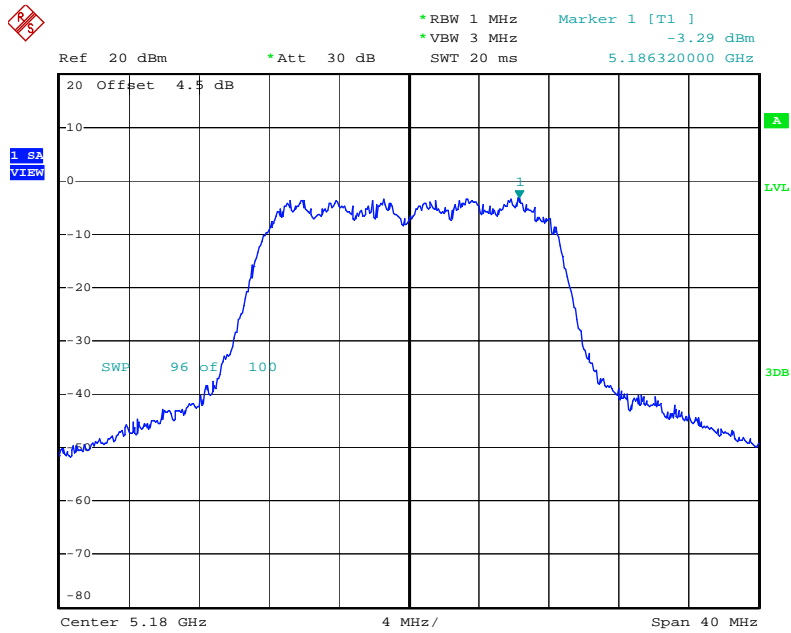

Date: 4.MAY.2010 12:19:28

Power Density Plot on Configuration IEEE 802.11a A1+A5 / 5200 MHz

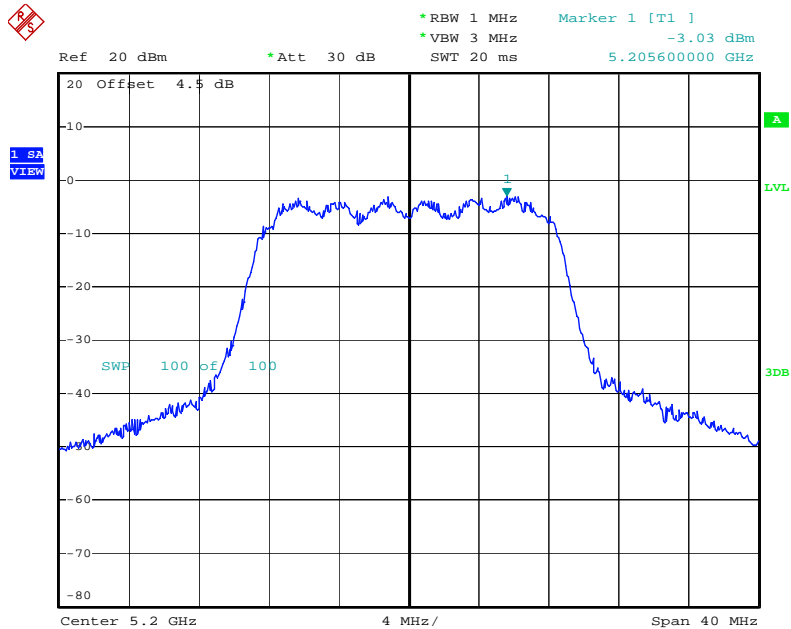

Date: 4.MAY.2010 12:17:48



### Power Density Plot on Configuration IEEE 802.11a A1+A5 / 5240 MHz

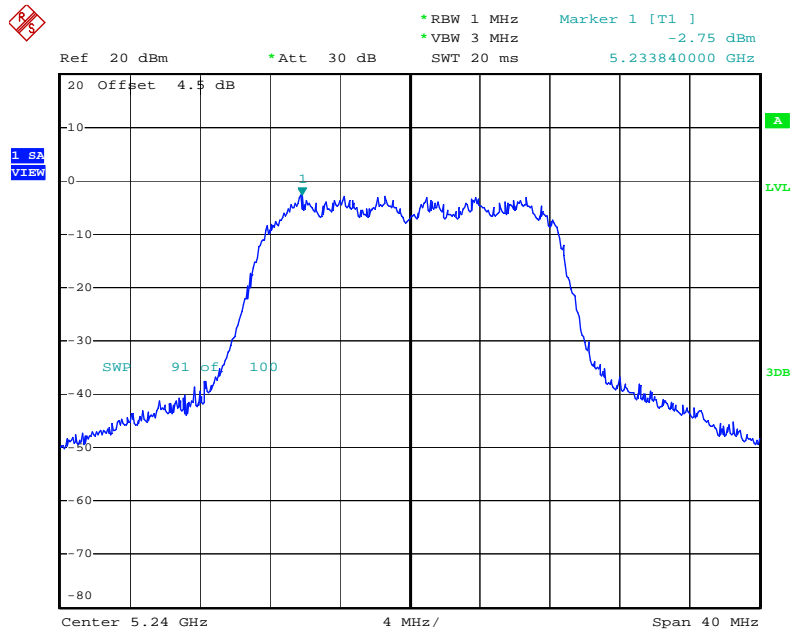

Date: 4.MAY.2010 12:16:27

< For Ant. 6 >

Power Density Plot on Configuration IEEE 802.11a A1+A5 / 5180 MHz

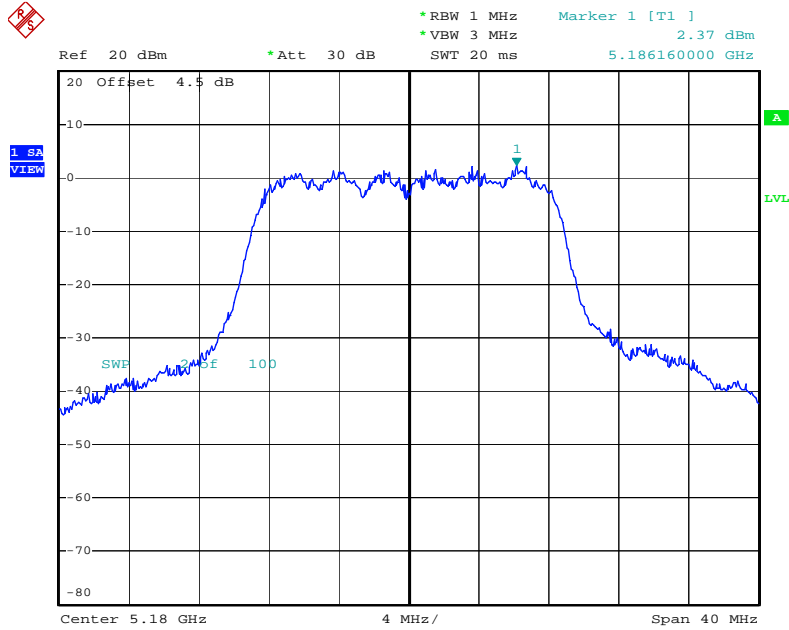

Date: 6.MAY.2010 17:14:20

Power Density Plot on Configuration IEEE 802.11a A1+A5 / 5200 MHz

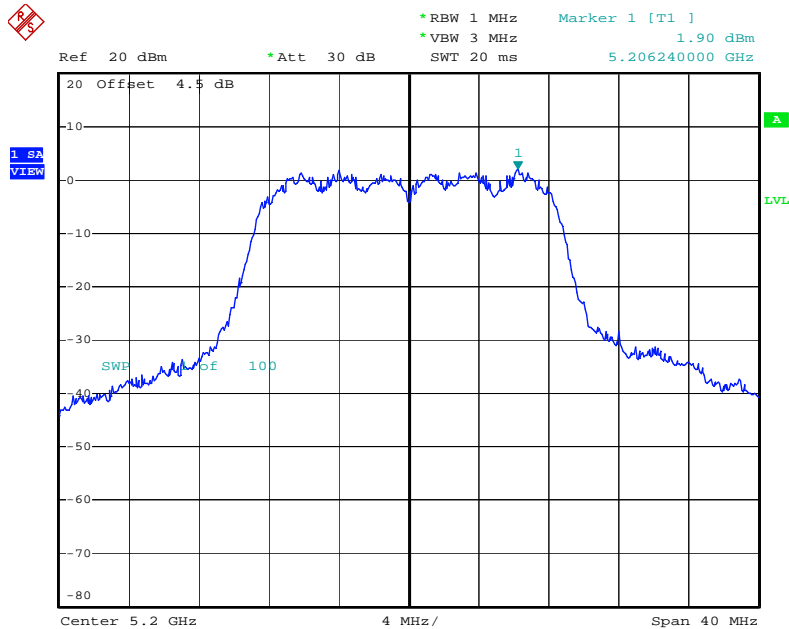

Date: 6.MAY.2010 17:10:51

## Power Density Plot on Configuration IEEE 802.11a A1+A5 / 5240 MHz

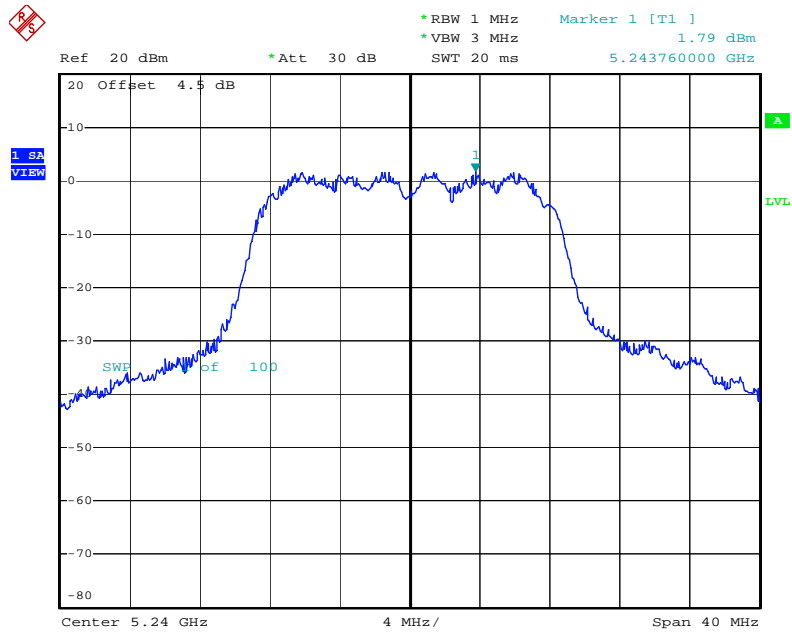

Date: 6.MAY.2010 17:07:15

## 4.5. Peak Excursion Measurement

### 4.5.1. Limit

The ratio of the peak excursion of the modulation envelope (measured using a peak hold function) to the maximum conducted output power (measured as specified above) shall not exceed 13 dB across any 1 MHz bandwidth or the emissions bandwidth whichever is less.

### 4.5.2. Measuring Instruments and Setting

Please refer to section 5 of equipments list in this report. The following table is the setting of the spectrum analyzer.

Spectrum Parameter	Setting
Attenuation	Auto
Span Frequency	Encompass the entire emissions bandwidth (EBW) of the signal
RB	1000 kHz (Peak Trace) / 1000 kHz (Average Trace)
VB	3000 kHz (Peak Trace) / 300 kHz (Average Trace)
Detector	Peak (Peak Trace) / Sample (Average Trace)
Trace	Max Hold
Sweep Time	60s

### 4.5.3. Test Procedures

1. The transmitter output (antenna port) was connected to the spectrum analyzer.
2. Set the spectrum analyzer span to view the entire emissions bandwidth. The largest difference between the following two traces (Peak Trace and Average Trace) must be  $\leq 13$  dB for all frequencies across the emissions bandwidth. Submit a plot.
3. Peak Trace: Set RBW = 1 MHz, VBW  $\geq 3$  MHz with peak detector and max-hold settings.
4. Average Trace: Method #3—video averaging with max hold--and sum power across the band. Set span to encompass the entire emissions bandwidth (EBW) of the signal. Set sweep trigger to "free run". Set RBW = 1 MHz. Set VBW  $\geq 1/T$  (IEEE 802.11nVBW = 300kHz  $\geq 1/4\mu\text{s}$ ). Use sample detector mode if bin width (i.e., span/number of points in spectrum)  $< 0.5$  RBW. Otherwise use peak detector mode. Set max hold. Allow max hold to run for 60 seconds.
5. Measuring multiple antennas, the connector is required to link with spectrum analyzer through a combiner.

### 4.5.4. Test Setup Layout

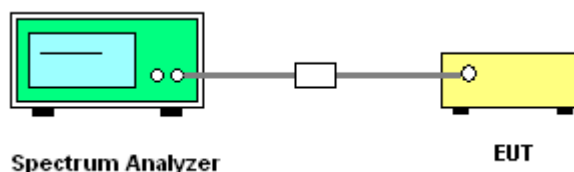

#### 4.5.5. Test Deviation

There is no deviation with the original standard.

#### 4.5.6. EUT Operation during Test

The EUT was programmed to be in continuously transmitting mode.

#### 4.5.7. Test Result of Peak Excursion

< For Ant. 1 >

Temperature	24°C	Humidity	56%
Test Engineer	Johnson Chang	Configurations	IEEE 802.11n / Ant. 1

##### Configuration IEEE 802.11n MCS8 20MHz A1+A5

Channel	Frequency	Peak Excursion (dB)	Max. Limit (dB)	Result
36	5180 MHz	10.69	13	Complies
40	5200 MHz	10.62	13	Complies
48	5240 MHz	10.31	13	Complies

##### Configuration IEEE 802.11n MCS8 40MHz A1+A5

Channel	Frequency	Peak Excursion (dB)	Max. Limit (dB)	Result
38	5190 MHz	10.76	13	Complies
46	5230 MHz	10.12	13	Complies

<b>Temperature</b>	24°C	<b>Humidity</b>	56%
<b>Test Engineer</b>	Johnson Chang	<b>Configurations</b>	IEEE 802.11a / Ant. 1

**Configuration IEEE 802.11a A1+A5**

<b>Channel</b>	<b>Frequency</b>	<b>Peak Excursion (dB)</b>	<b>Max. Limit (dB)</b>	<b>Result</b>
36	5180 MHz	9.75	13	<b>Complies</b>
40	5200 MHz	10.20	13	<b>Complies</b>
48	5240 MHz	11.76	13	<b>Complies</b>

Note: All the test values were listed in the report.

For plots, only the worse case of OFDM modulation was listed in the report.

< For Ant. 2 >

Temperature	24°C	Humidity	56%
Test Engineer	Johnson Chang	Configurations	IEEE 802.11n / Ant. 2

Configuration IEEE 802.11n MCS8 20MHz A1+A5

Channel	Frequency	Peak Excursion (dB)	Max. Limit (dB)	Result
36	5180 MHz	9.80	13	Complies
40	5200 MHz	8.79	13	Complies
48	5240 MHz	9.97	13	Complies

Configuration IEEE 802.11n MCS8 40MHz A1+A5

Channel	Frequency	Peak Excursion (dB)	Max. Limit (dB)	Result
38	5190 MHz	8.75	13	Complies
46	5230 MHz	10.47	13	Complies

Temperature	24°C	Humidity	56%
Test Engineer	Johnson Chang	Configurations	IEEE 802.11a / Ant. 2

**Configuration IEEE 802.11a A1+A5**

Channel	Frequency	Peak Excursion (dB)	Max. Limit (dB)	Result
36	5180 MHz	8.30	13	Complies
40	5200 MHz	7.59	13	Complies
48	5240 MHz	8.45	13	Complies

Note: All the test values were listed in the report.

For plots, only the worse case of OFDM modulation was listed in the report.



< For Ant. 3 >

Temperature	24°C	Humidity	56%
Test Engineer	Johnson Chang	Configurations	IEEE 802.11n / Ant. 3

Configuration IEEE 802.11n MCS8 20MHz A1+A5

Channel	Frequency	Peak Excursion (dB)	Max. Limit (dB)	Result
36	5180 MHz	9.08	13	Complies
40	5200 MHz	10.52	13	Complies
48	5240 MHz	10.26	13	Complies

Configuration IEEE 802.11n MCS8 40MHz A1+A5

Channel	Frequency	Peak Excursion (dB)	Max. Limit (dB)	Result
38	5190 MHz	9.24	13	Complies
46	5230 MHz	9.83	13	Complies

<b>Temperature</b>	24°C	<b>Humidity</b>	56%
<b>Test Engineer</b>	Johnson Chang	<b>Configurations</b>	IEEE 802.11a / Ant. 3

**Configuration IEEE 802.11a A1+A5**

<b>Channel</b>	<b>Frequency</b>	<b>Peak Excursion (dB)</b>	<b>Max. Limit (dB)</b>	<b>Result</b>
36	5180 MHz	10.91	13	<b>Complies</b>
40	5200 MHz	10.75	13	<b>Complies</b>
48	5240 MHz	9.44	13	<b>Complies</b>

Note: All the test values were listed in the report.

For plots, only the worse case of OFDM modulation was listed in the report.

< For Ant. 4 >

Temperature	24°C	Humidity	56%
Test Engineer	Johnson Chang	Configurations	IEEE 802.11n / Ant. 4

Configuration IEEE 802.11n MCS8 20MHz A1+A5

Channel	Frequency	Peak Excursion (dB)	Max. Limit (dB)	Result
36	5180 MHz	11.01	13	Complies
40	5200 MHz	10.55	13	Complies
48	5240 MHz	10.91	13	Complies

Configuration IEEE 802.11n MCS8 40MHz A1+A5

Channel	Frequency	Peak Excursion (dB)	Max. Limit (dB)	Result
38	5190 MHz	10.31	13	Complies
46	5230 MHz	10.29	13	Complies

<b>Temperature</b>	24°C	<b>Humidity</b>	56%
<b>Test Engineer</b>	Johnson Chang	<b>Configurations</b>	IEEE 802.11a / Ant. 4

**Configuration IEEE 802.11a A1+A5**

<b>Channel</b>	<b>Frequency</b>	<b>Peak Excursion (dB)</b>	<b>Max. Limit (dB)</b>	<b>Result</b>
36	5180 MHz	8.84	13	<b>Complies</b>
40	5200 MHz	11.92	13	<b>Complies</b>
48	5240 MHz	9.69	13	<b>Complies</b>

Note: All the test values were listed in the report.

For plots, only the worse case of OFDM modulation was listed in the report.

< For Ant. 6 >

Temperature	24°C	Humidity	56%
Test Engineer	Johnson Chang	Configurations	IEEE 802.11n / Ant. 6

**Configuration IEEE 802.11n MCS8 20MHz A1+A5**

Channel	Frequency	Peak Excursion (dB)	Max. Limit (dB)	Result
36	5180 MHz	11.37	13	Complies
40	5200 MHz	9.43	13	Complies
48	5240 MHz	10.28	13	Complies

**Configuration IEEE 802.11n MCS8 40MHz A1+A5**

Channel	Frequency	Peak Excursion (dB)	Max. Limit (dB)	Result
38	5190 MHz	4.28	13	Complies
46	5230 MHz	9.91	13	Complies

<b>Temperature</b>	24°C	<b>Humidity</b>	56%
<b>Test Engineer</b>	Johnson Chang	<b>Configurations</b>	IEEE 802.11a / Ant. 6

**Configuration IEEE 802.11a A1+A5**

<b>Channel</b>	<b>Frequency</b>	<b>Peak Excursion (dB)</b>	<b>Max. Limit (dB)</b>	<b>Result</b>
36	5180 MHz	10.83	13	<b>Complies</b>
40	5200 MHz	9.14	13	<b>Complies</b>
48	5240 MHz	9.50	13	<b>Complies</b>

Note: All the test values were listed in the report.

For plots, only the worse case of OFDM modulation was listed in the report.

< For Ant. 1 >

Peak Excursion Plot on Configuration IEEE 802.11a A1+A5 / 5180 MHz

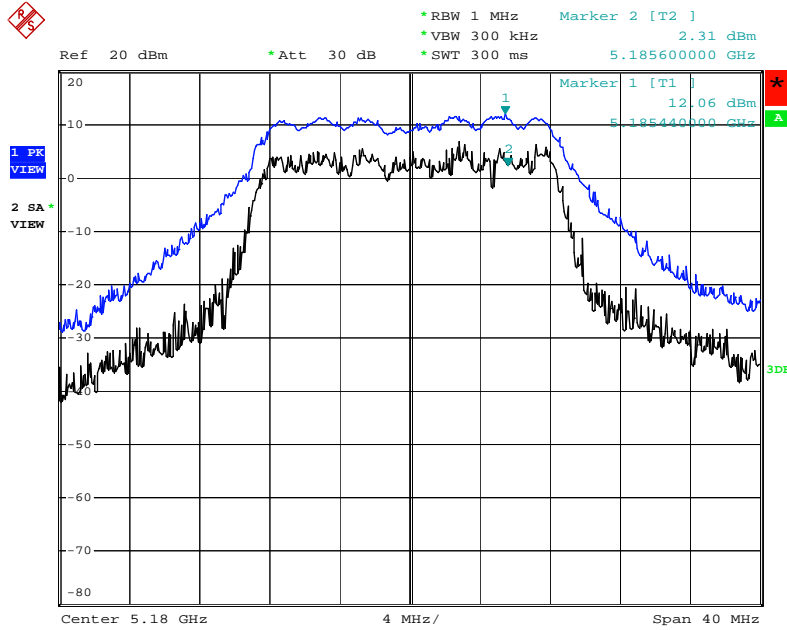

Date: 26.APR.2010 20:15:31

Peak Excursion Plot on Configuration IEEE 802.11a A1+A5 / 5200 MHz

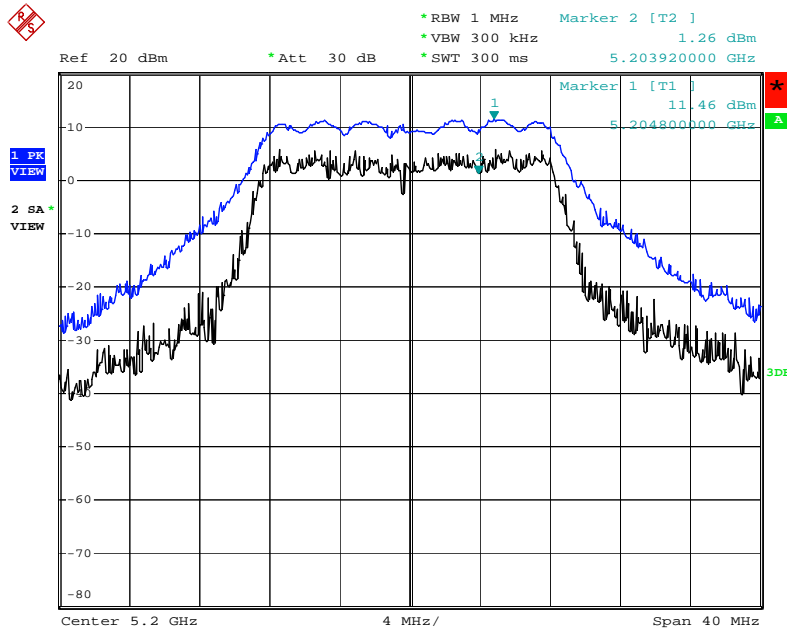

Date: 26.APR.2010 20:17:19

Peak Excursion Plot on Configuration IEEE 802.11a A1+A5 / 5240 MHz

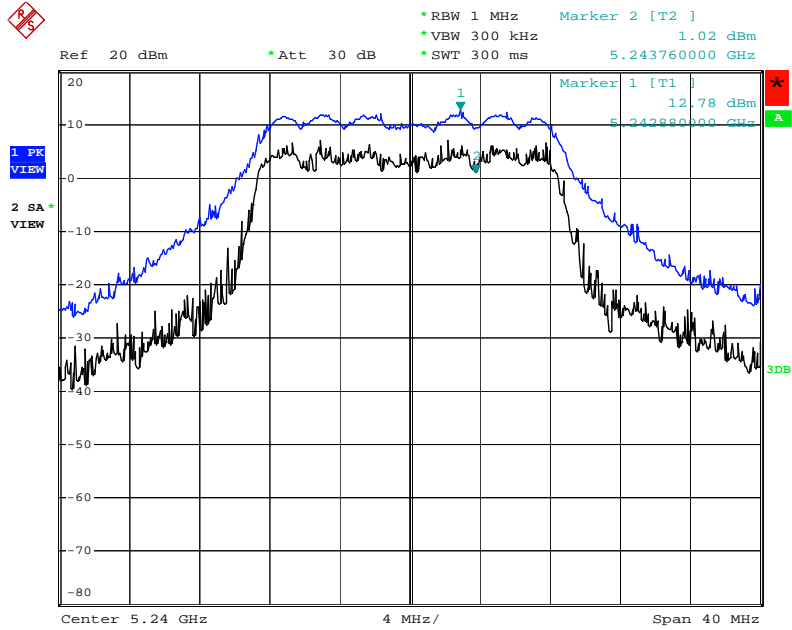

Date: 26.APR.2010 20:19:01



< For Ant. 2 >

Peak Excursion Plot on Configuration IEEE 802.11n MCS8 40MHz A1+A5 / 5190 MHz

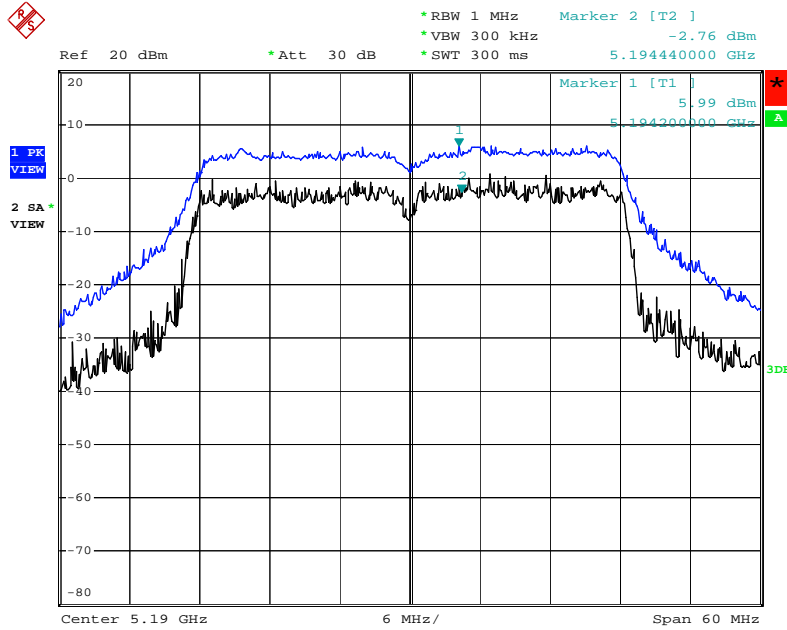

Date: 1.MAY.2010 12:54:35

Peak Excursion Plot on Configuration IEEE 802.11n MCS8 40MHz A1+A5 / 5230 MHz

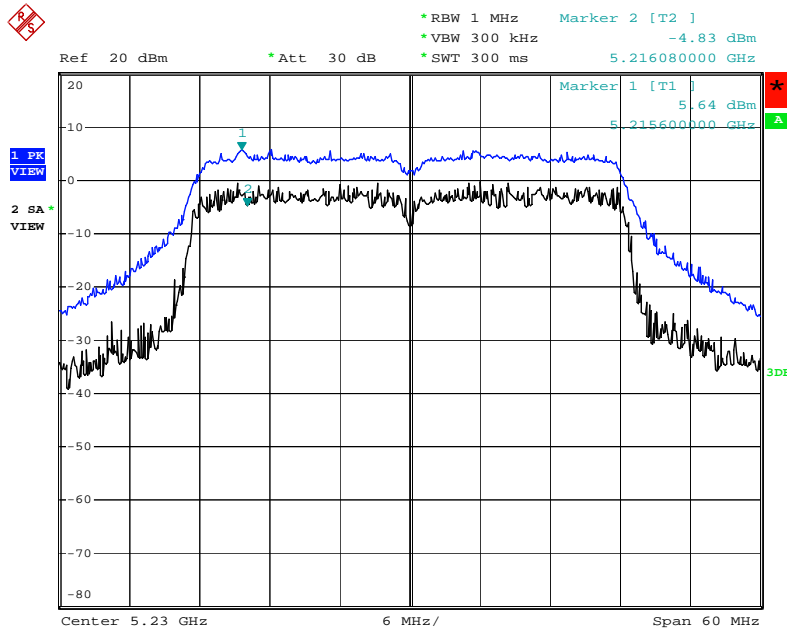

Date: 1.MAY.2010 12:52:49

< For Ant. 3 >

Peak Excursion Plot on Configuration IEEE 802.11a A1+A5 / 5180 MHz

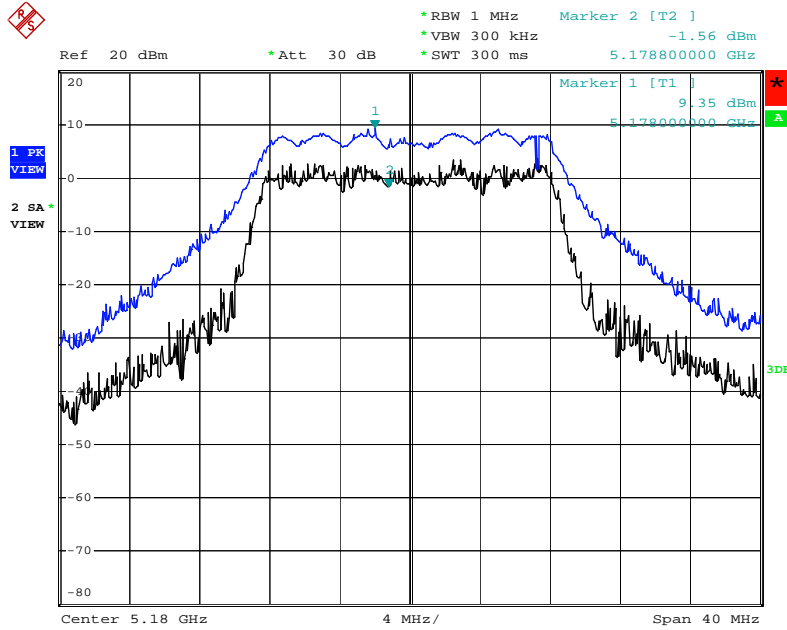

Date: 3.MAY.2010 16:05:18

Peak Excursion Plot on Configuration IEEE 802.11a A1+A5 / 5200 MHz

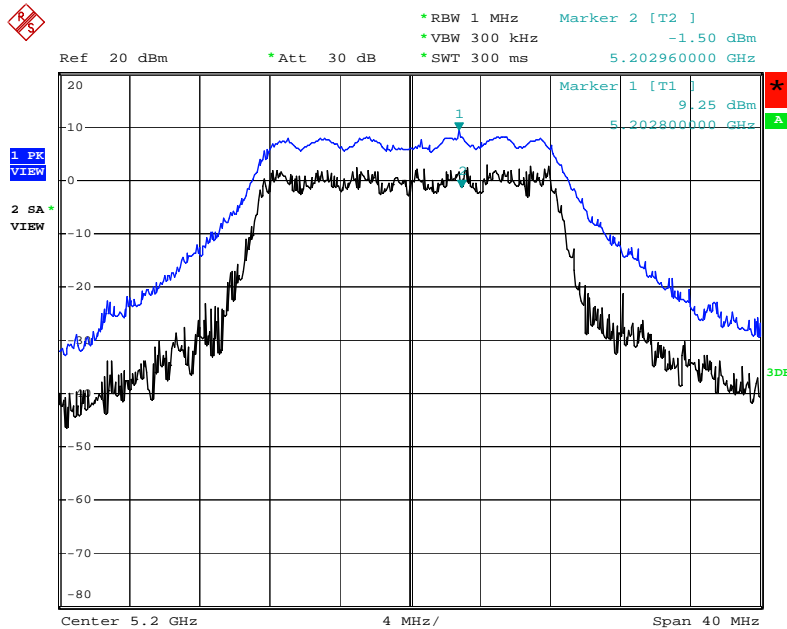

Date: 3.MAY.2010 16:11:38

Peak Excursion Plot on Configuration IEEE 802.11a A1+A5 / 5240 MHz

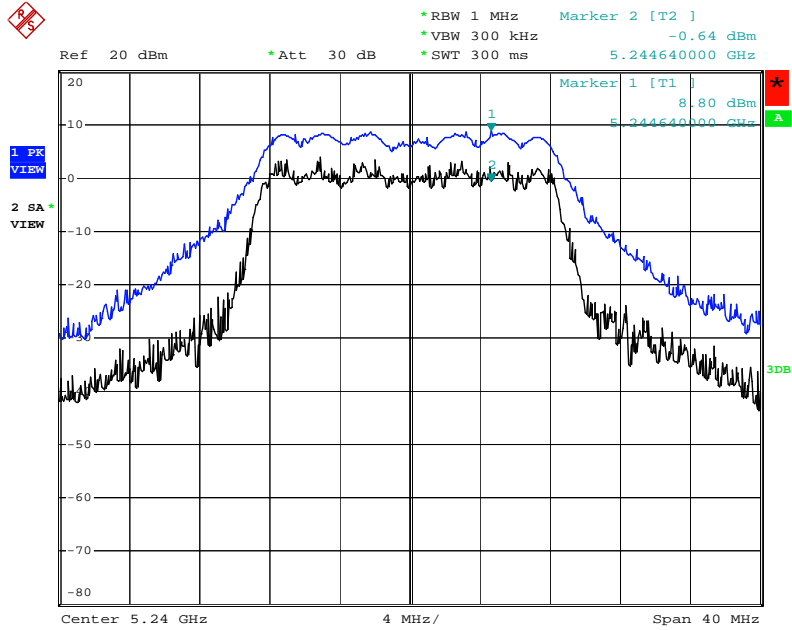

Date: 3.MAY.2010 16:14:46

< For Ant. 4 >

Peak Excursion Plot on Configuration IEEE 802.11a A1+A5 / 5180 MHz

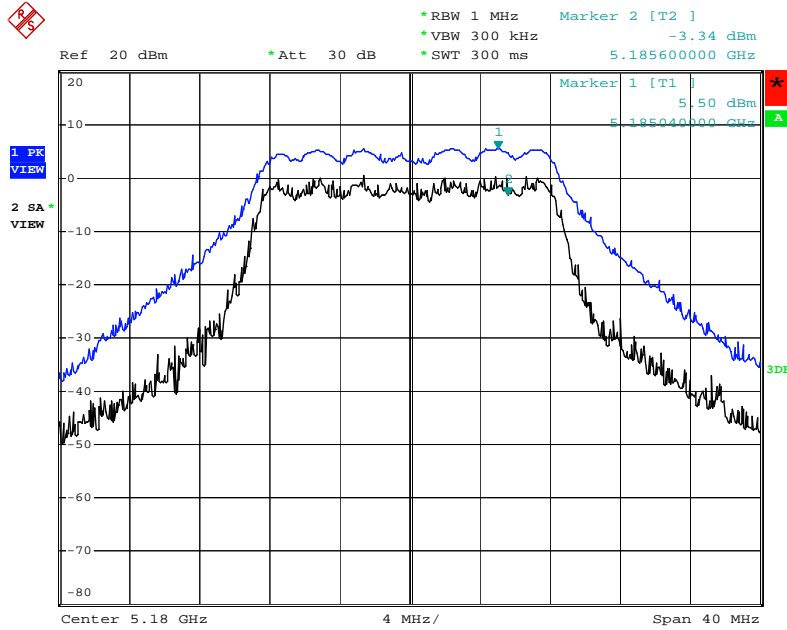

Date: 4.MAY.2010 14:10:40

Peak Excursion Plot on Configuration IEEE 802.11a A1+A5 / 5200 MHz

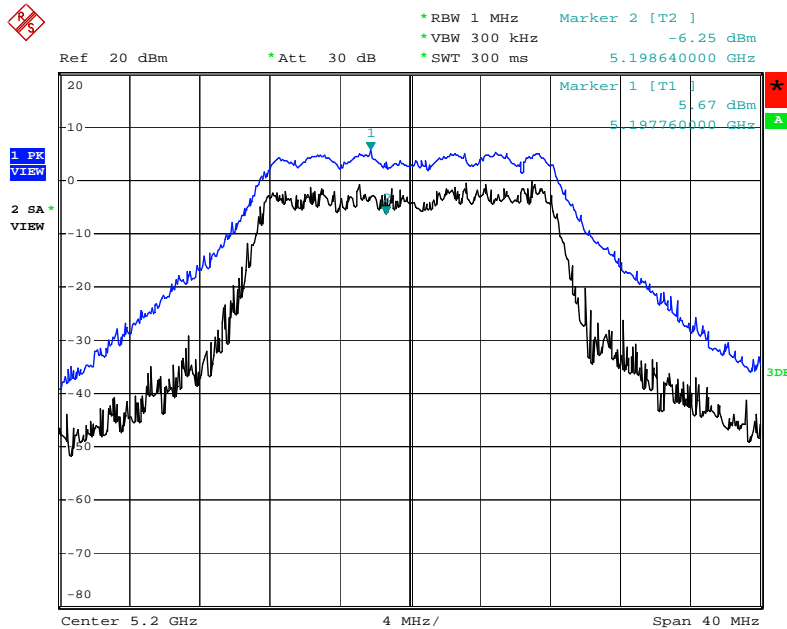

Date: 4.MAY.2010 12:18:39

### Peak Excursion Plot on Configuration IEEE 802.11a A1+A5 / 5240 MHz

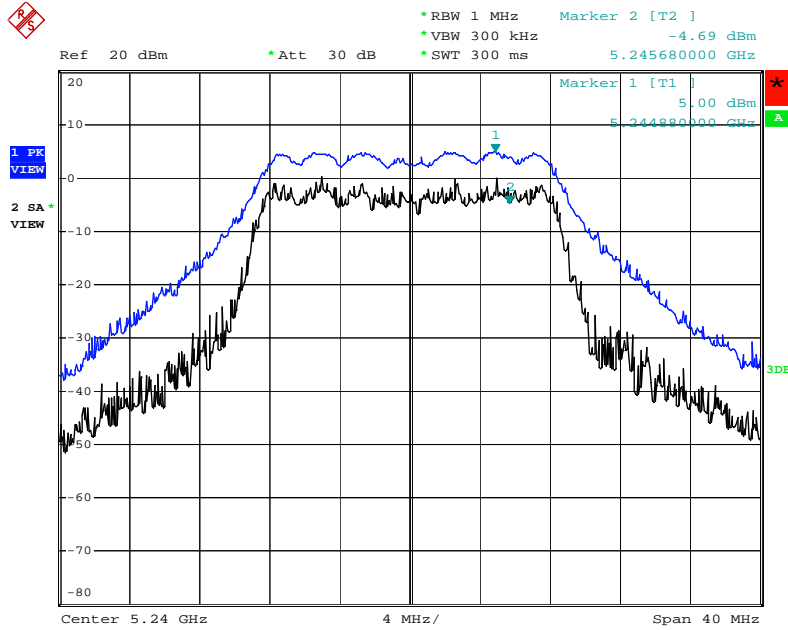

Date: 4.MAY.2010 12:16:50

< For Ant. 6 >

Peak Excursion Plot on Configuration IEEE 802.11n MCS8 20MHz A1+A5 / 5180 MHz

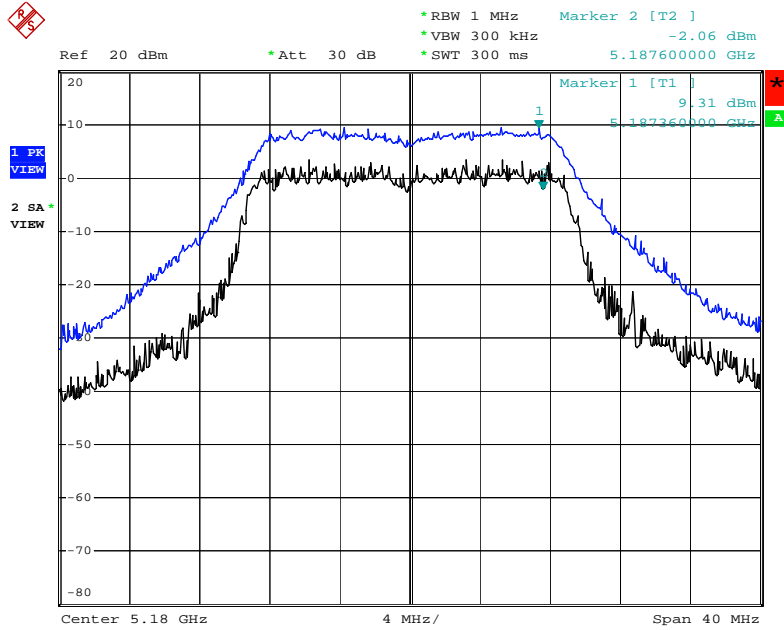

Date: 6.MAY.2010 15:44:34

Peak Excursion Plot on Configuration IEEE 802.11n MCS8 20MHz A1+A5 / 5200 MHz

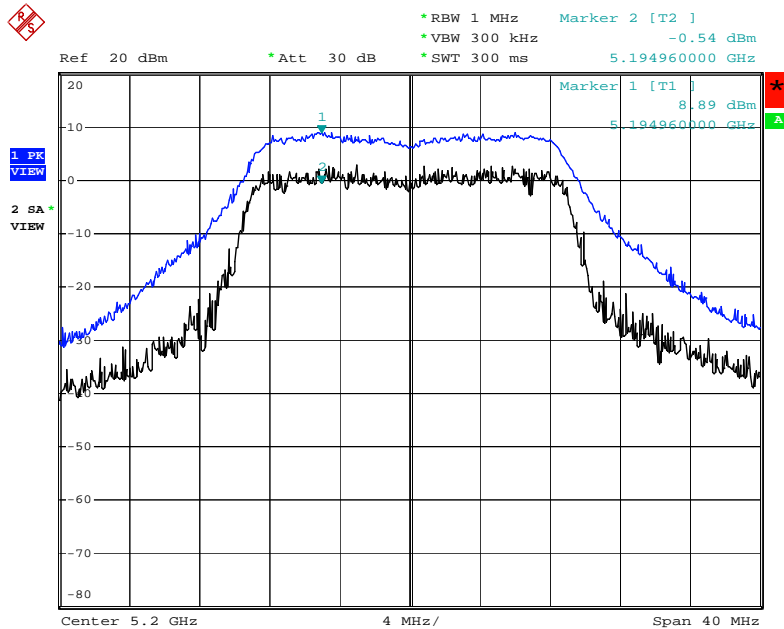

Date: 6.MAY.2010 15:50:52

Peak Excursion Plot on Configuration IEEE 802.11n MCS8 20MHz A1+A5 / 5240 MHz

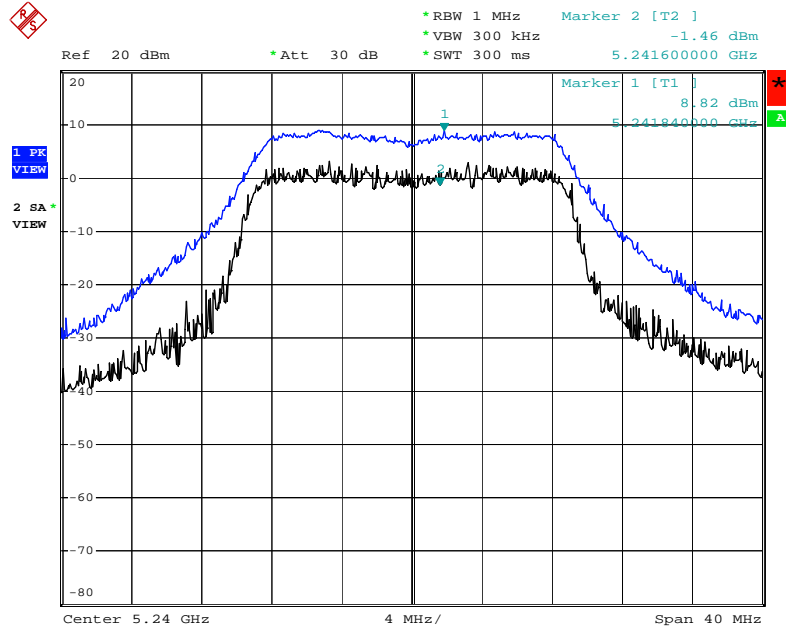

Date: 6.MAY.2010 16:03:27

## 4.6. Radiated Emissions Measurement

### 4.6.1. Limit

For transmitters operating in the 5.15-5.25 GHz band: all emissions outside of the 5.15-5.25 GHz band shall not exceed an EIRP of -27 dBm/MHz (68.3dBuV/m at 3m). For transmitters operating in the 5.470-5.725 GHz band: all emissions outside of the 5.470-5.725 GHz band shall not exceed an EIRP of -27 dBm/MHz (68.3dBuV/m at 3m). In addition, In case the emission fall within the restricted band specified on 15.205(a), then the 15.209(a) limit in the table below has to be followed.

Frequencies (MHz)	Field Strength (micorvolts/meter)	Measurement Distance (meters)
0.009~0.490	2400/F(KHz)	300
0.490~1.705	24000/F(KHz)	30
1.705~30.0	30	30
30~88	100	3
88~216	150	3
216~960	200	3
Above 960	500	3

### 4.6.2. Measuring Instruments and Setting

Please refer to section 5 of equipments list in this report. The following table is the setting of spectrum analyzer and receiver.

Spectrum Parameter	Setting
Attenuation	Auto
Start Frequency	1000 MHz
Stop Frequency	40 GHz
RB / VB (Emission in restricted band)	1MHz / 1MHz for Peak, 1 MHz / 10Hz for Average
RB / VB (Emission in non-restricted band)	1000KHz / 1000KHz for peak

Receiver Parameter	Setting
Attenuation	Auto
Start ~ Stop Frequency	9kHz~150kHz / RB 200Hz for QP
Start ~ Stop Frequency	150kHz~30MHz / RB 9kHz for QP
Start ~ Stop Frequency	30MHz~1000MHz / RB 120kHz for QP



#### 4.6.3. Test Procedures

1. Configure the EUT according to ANSI C63.4. The EUT was placed on the top of the turntable 0.8 meter above ground. The phase center of the receiving antenna mounted on the top of a height-variable antenna tower was placed 3 meters far away from the turntable.
2. Power on the EUT and all the supporting units. The turntable was rotated by 360 degrees to determine the position of the highest radiation.
3. The height of the broadband receiving antenna was varied between one meter and four meters above ground to find the maximum emissions field strength of both horizontal and vertical polarization.
4. For each suspected emissions, the antenna tower was scan (from 1 M to 4 M) and then the turntable was rotated (from 0 degree to 360 degrees) to find the maximum reading.
5. Set the test-receiver system to Peak or CISPR quasi-peak Detect Function with specified bandwidth under Maximum Hold Mode.
6. For emissions above 1GHz, use 1MHz VBW and RBW for peak reading. Then 1MHz RBW and 10Hz VBW for average reading in spectrum analyzer.
7. When the radiated emissions limits are expressed in terms of the average value of the emissions, and pulsed operation is employed, the measurement field strength shall be determined by averaging over one complete pulse train, including blanking intervals, as long as the pulse train does not exceed 0.1 seconds. As an alternative (provided the transmitter operates for longer than 0.1 seconds) or in cases where the pulse train exceeds 0.1 seconds, the measured field strength shall be determined from the average absolute voltage during a 0.1 second interval during which the field strength is at its maximum value.
8. If the emissions level of the EUT in peak mode was 3 dB lower than the average limit specified, then testing will be stopped and peak values of EUT will be reported, otherwise, the emissions which do not have 3 dB margin will be repeated one by one using the quasi-peak method for below 1GHz.
9. For testing above 1GHz, the emissions level of the EUT in peak mode was lower than average limit (that means the emissions level in peak mode also complies with the limit in average mode), then testing will be stopped and peak values of EUT will be reported, otherwise, the emissions will be measured in average mode again and reported.
10. In case the emission is lower than 30MHz, loop antenna has to be used for measurement and the recorded data should be QP measured by receiver. High – Low scan is not required in this case.

#### 4.6.4. Test Setup Layout

For radiated emissions below 30MHz

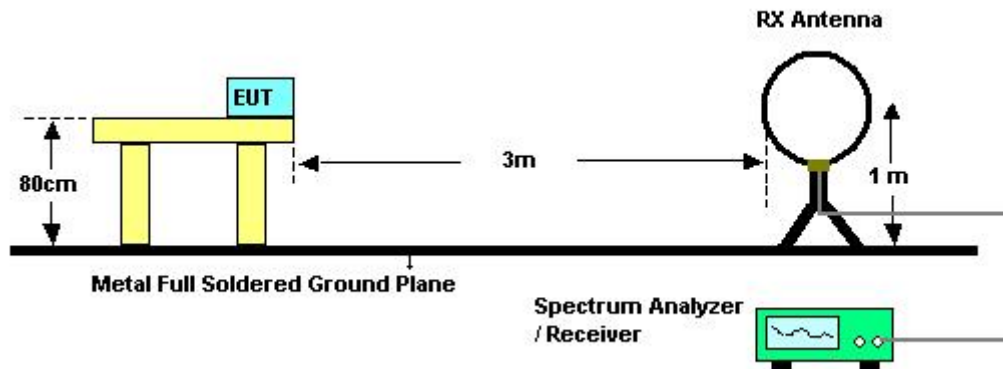

For radiated emissions above 30MHz

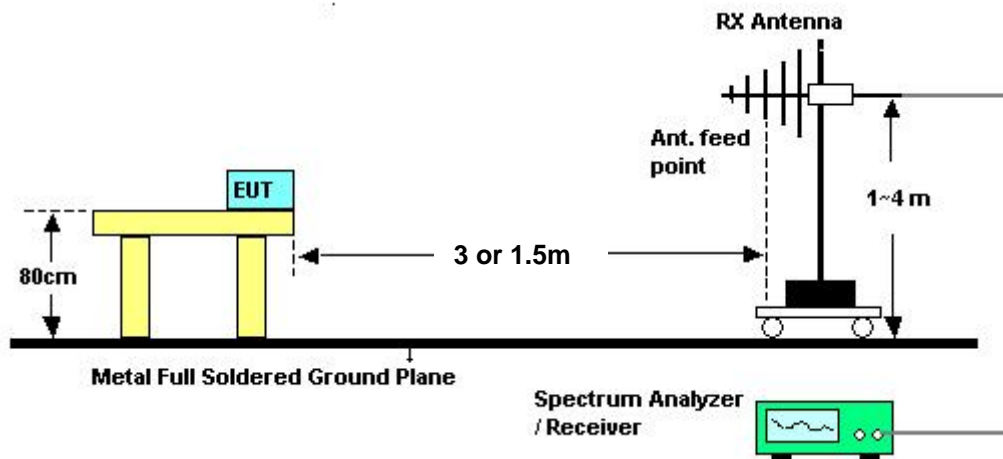

Above 5GHz shall be extrapolated to the specified distance using an extrapolation factor of 20 dB/decade from 3m to 1.5m.

Distance extrapolation factor =  $20 \log (\text{specific distance [3m]} / \text{test distance [1.5m]})$  (dB);

Limit line = specific limits (dBuV) + distance extrapolation factor [6 dB].

#### 4.6.5. Test Deviation

There is no deviation with the original standard.

#### 4.6.6. EUT Operation during Test

The EUT was programmed to be in continuously transmitting mode.

#### 4.6.7. Results of Radiated Emissions (9kHz~30MHz)

<b>Temperature</b>	24°C	<b>Humidity</b>	56%
<b>Test Engineer</b>	Allen Liu	<b>Configurations</b>	Normal Link
<b>Test Date</b>	May 05, 2010		

<b>Freq. (MHz)</b>	<b>Level (dBuV)</b>	<b>Over Limit (dB)</b>	<b>Limit Line (dBuV)</b>	<b>Remark</b>
-	-	-	-	See Note

Note:

The amplitude of spurious emissions that are attenuated by more than 20dB below the permissible value has no need to be reported.

Distance extrapolation factor =  $40 \log (\text{specific distance} / \text{test distance})$  (dB);

Limit line = specific limits (dBuV) + distance extrapolation factor.

## 4.6.8. Results of Radiated Emissions (30MHz~1GHz)

&lt; For Ant. 1 &gt;

Temperature	24°C	Humidity	56%
Test Engineer	Sean Ku	Configurations	Normal Link / Ant. 1

Horizontal

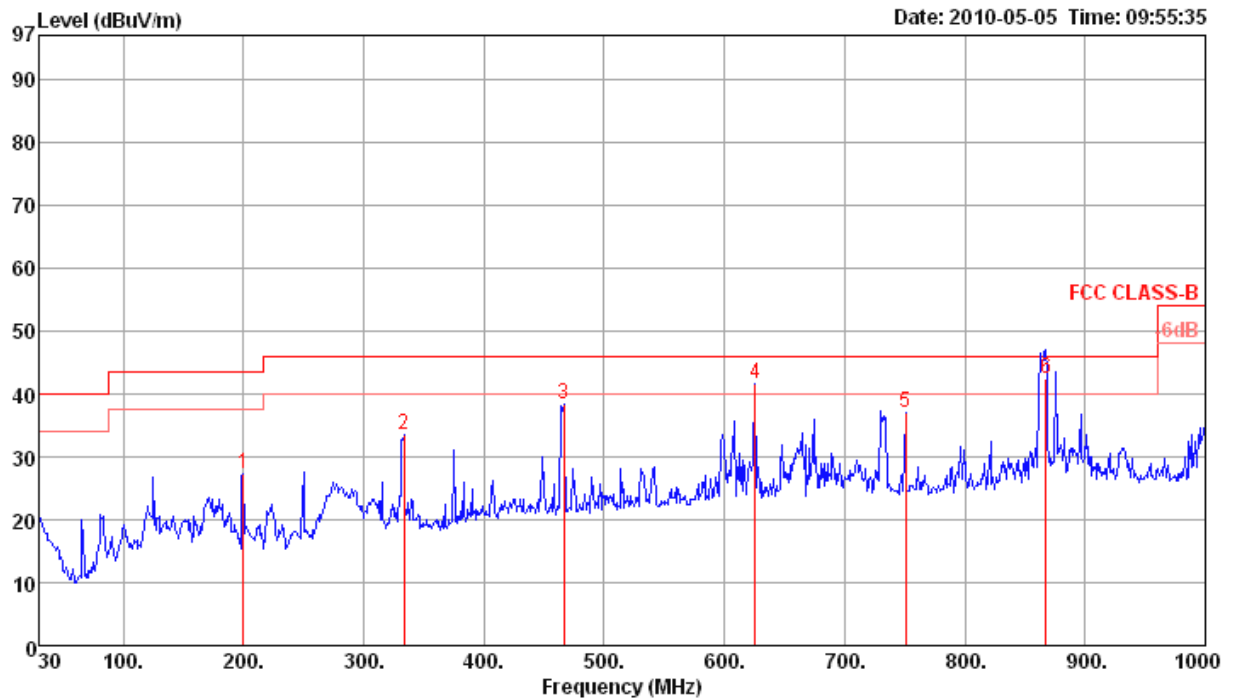

	Freq	Level	Limit	Over	Read	Cable	Preamp	Antenna	T/Pos	A/Pos	Remark	Pol/Phase
	MHz	dBuV/m	dBuV/m	dB	dBuV	dB	dB	dB/m	deg	cm		
1	199.75	27.21	43.50	-16.29	43.56	1.70	27.10	9.05	0	100	Peak	HORIZONTAL
2	333.61	33.42	46.00	-12.58	44.10	2.17	27.13	14.28	0	100	Peak	HORIZONTAL
3	466.50	38.48	46.00	-7.52	46.68	2.63	27.93	17.10	0	100	Peak	HORIZONTAL
4 p	625.58	41.70	46.00	-4.30	47.87	3.05	28.07	18.85	0	100	Peak	HORIZONTAL
5	750.71	37.14	46.00	-8.86	42.01	3.50	27.80	19.43	0	100	Peak	HORIZONTAL
6 q	867.11	42.48	46.00	-3.52	46.20	3.47	27.47	20.28	193	100	QP	HORIZONTAL

Vertical

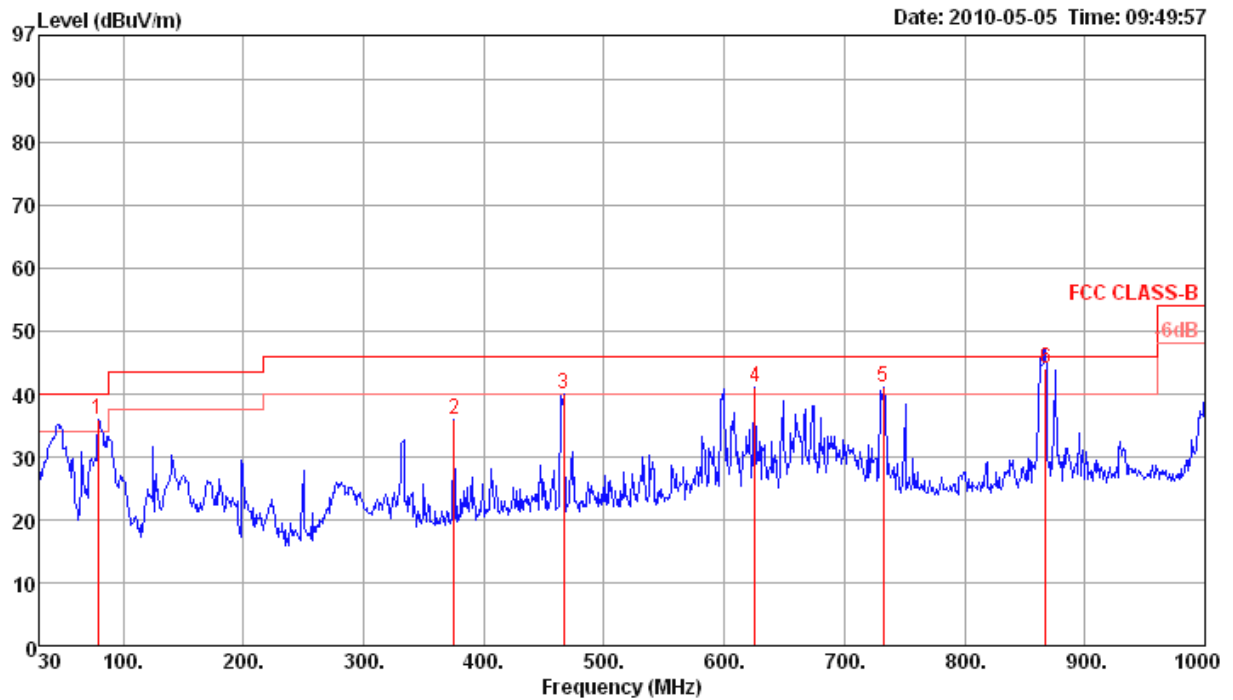

	Freq	Level	Limit	Over	Read	Cable	Preamp	Antenna	T/Pos	A/Pos	Remark	Pol/Phase
	MHz	dBuV/m	dBuV/m	dB	dBuV	dB	dB	dB/m	deg	cm		
1	p	79.47	36.01	40.00	-3.99	55.50	1.07	27.68	7.12	0	400 Peak	VERTICAL
2		375.32	35.91	46.00	-10.09	45.69	2.25	27.43	15.40	0	400 Peak	VERTICAL
3		466.50	39.97	46.00	-6.03	48.17	2.63	27.93	17.10	0	400 Peak	VERTICAL
4	!	625.58	41.19	46.00	-4.81	47.36	3.05	28.07	18.85	0	400 Peak	VERTICAL
5	!	732.28	40.99	46.00	-5.01	46.12	3.43	27.87	19.31	0	400 Peak	VERTICAL
6	q	867.11	43.98	46.00	-2.02	47.70	3.47	27.47	20.28	102	100 QP	VERTICAL

Note:

The amplitude of spurious emissions that are attenuated by more than 20dB below the permissible value has no need to be reported.

Emission level (dBuV/m) = 20 log Emission level (uV/m).

Corrected Reading: Antenna Factor + Cable Loss + Read Level - Preamp Factor = Level.

< For Ant. 5 >

Temperature	24°C	Humidity	56%
Test Engineer	Sean Ku	Configurations	Normal Link / Ant. 5

Horizontal

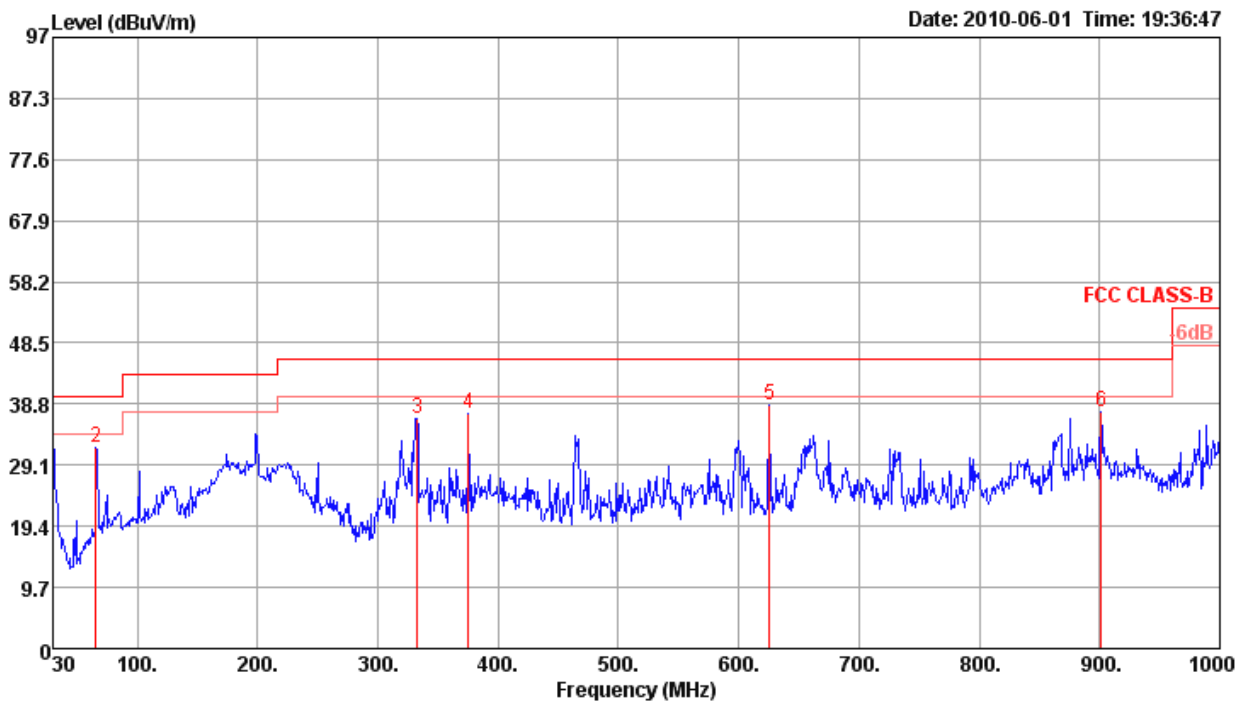

	Freq	Level	Limit Line	Over Limit	Read Level	Cable Loss	Preamp Factor	Antenna Factor	T/Pos	A/Pos	Remark	PoI/Phase
	MHz	dBuV/m	dBuV/m	dB	dBuV	dB	dB	dB/m	deg	cm		
1	30.00	33.61	40.00	-6.39	42.15	0.50	27.80	18.76	0	100	Peak	HORIZONTAL
2	65.89	31.98	40.00	-8.02	52.15	0.88	27.74	6.69	0	100	Peak	HORIZONTAL
3	332.64	36.42	46.00	-9.58	47.12	2.17	27.12	14.25	0	100	Peak	HORIZONTAL
4	375.32	37.17	46.00	-8.83	46.95	2.25	27.43	15.40	0	100	Peak	HORIZONTAL
5	625.58	38.76	46.00	-7.24	44.93	3.05	28.07	18.85	0	100	Peak	HORIZONTAL
6	901.06	37.53	46.00	-8.47	40.78	3.60	27.39	20.54	0	100	Peak	HORIZONTAL

Vertical

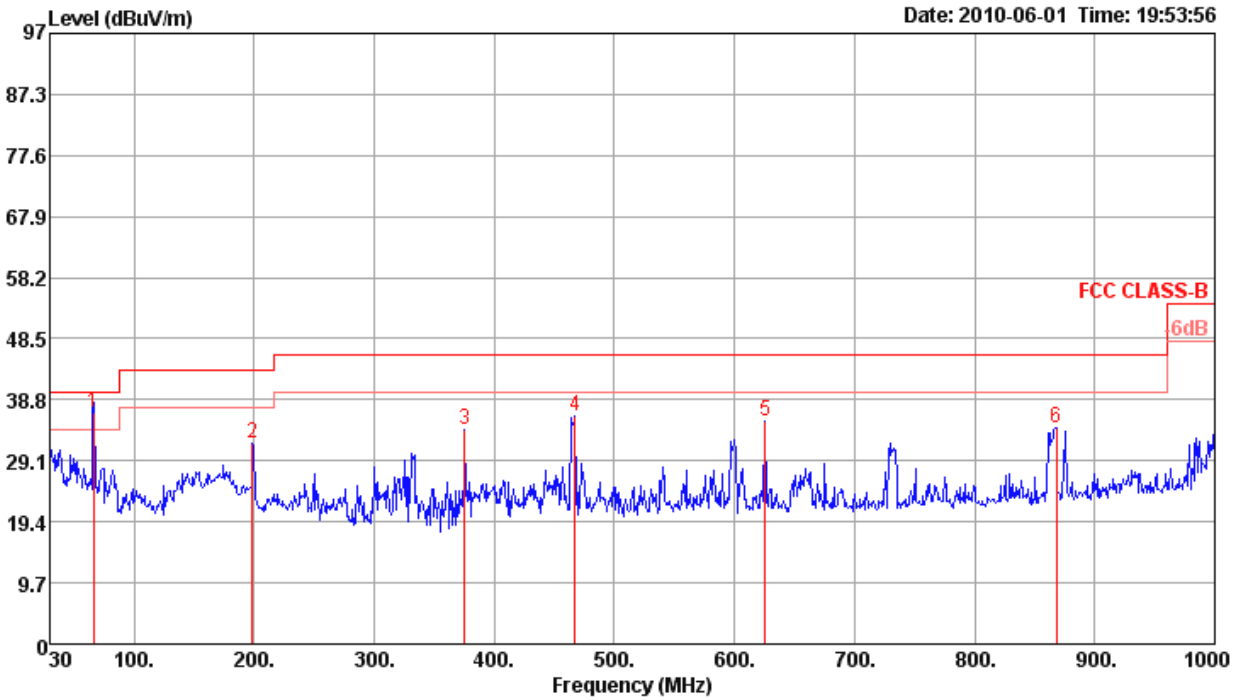

	Freq	Level	Limit	Over	Read	Cable	Preamp	Antenna	T/Pos	A/Pos	Remark	Pol/Phase
	MHz	dBuV/m	dBuV/m	dB	dBuV	dB	dB	dB/m	deg	cm		
1	66.52	36.71	40.00	-3.29	56.90	0.86	27.73	6.68	360	116	QP	VERTICAL
2	198.78	31.89	43.50	-11.61	48.06	1.69	27.11	9.25	0	400	Peak	VERTICAL
3	375.32	33.99	46.00	-12.01	43.77	2.25	27.43	15.40	0	400	Peak	VERTICAL
4	467.47	36.27	46.00	-9.73	44.46	2.63	27.94	17.12	0	400	Peak	VERTICAL
5	625.58	35.48	46.00	-10.52	41.65	3.05	28.07	18.85	0	400	Peak	VERTICAL
6	868.08	34.34	46.00	-11.66	38.04	3.47	27.46	20.29	0	400	Peak	VERTICAL

Note:

The amplitude of spurious emissions that are attenuated by more than 20dB below the permissible value has no need to be reported.

Emission level (dBuV/m) = 20 log Emission level (uV/m).

Corrected Reading: Antenna Factor + Cable Loss + Read Level - Preamp Factor = Level.

## 4.6.9. Results for Radiated Emissions (1GHz~40GHz)

&lt; For Ant. 1 &gt;

Temperature	24°C	Humidity	56%
Test Engineer	Allen Liu	Configurations	IEEE 802.11n MCS8 20MHz Ch 36 / Ant. 1 / A1+A5
Test Date	Apr. 02, 2010		

*Horizontal*

	Freq	Level	Limit Line	Over Limit	Read Level	Cable Loss	Antenna Factor	Preamp Factor	T/Pos	A/Pos	Remark	Pol/Phase
	MHz	dBuV/m	dBuV/m	dB	dBuV	dB	dB/m	dB	deg	cm		
1	10359.65	47.94	74.00	-26.06	38.70	6.49	38.37	35.62	42	100	Average	HORIZONTAL
2	10360.00	62.35	94.00	-31.65	53.11	6.49	38.37	35.62	42	100	Peak	HORIZONTAL

*Vertical*

	Freq	Level	Limit Line	Over Limit	Read Level	Cable Loss	Antenna Factor	Preamp Factor	T/Pos	A/Pos	Remark	Pol/Phase
	MHz	dBuV/m	dBuV/m	dB	dBuV	dB	dB/m	dB	deg	cm		
1	10359.33	46.87	74.00	-27.13	37.63	6.49	38.37	35.62	95	100	Average	VERTICAL
2	10360.02	62.30	94.00	-31.70	53.06	6.49	38.37	35.62	95	100	Peak	VERTICAL



Temperature	24°C	Humidity	56%
Test Engineer	Allen Liu	Configurations	IEEE 802.11n MCS8 20MHz Ch 40 / Ant. 1 / A1+A5
Test Date	Apr. 02, 2010		

*Horizontal*

	Freq	Level	Limit Line	Over Limit	Read Level	Cable Loss	Antenna Factor	Preamp Factor	T/Pos	A/Pos	Remark	Pol/Phase
	MHz	dBuV/m	dBuV/m	dB	dBuV	dB	dB/m	dB	deg	cm		
1	10398.44	50.44	74.00	-23.56	41.12	6.52	38.38	35.58	36	101	Average	HORIZONTAL
2	10399.96	67.09	94.00	-26.91	57.77	6.52	38.38	35.58	36	101	Peak	HORIZONTAL

*Vertical*

	Freq	Level	Limit Line	Over Limit	Read Level	Cable Loss	Antenna Factor	Preamp Factor	T/Pos	A/Pos	Remark	Pol/Phase
	MHz	dBuV/m	dBuV/m	dB	dBuV	dB	dB/m	dB	deg	cm		
1	10400.06	67.82	94.00	-26.18	58.50	6.52	38.38	35.58	93	100	Peak	VERTICAL
2	10400.96	51.27	74.00	-22.73	41.95	6.52	38.38	35.58	93	100	Average	VERTICAL



Temperature	24°C	Humidity	56%
Test Engineer	Allen Liu	Configurations	IEEE 802.11n MCS8 20MHz Ch 48 / Ant. 1 / A1+A5
Test Date	Apr. 02, 2010		

*Horizontal*

	Freq	Level	Limit	Over	Read	CableAntenna	Preamp	T/Pos	A/Pos	Remark	Pol/Phase	
	MHz	dBuV/m	dBuV/m	dB	dBuV	dB	dB/m	dB	deg	cm		
1	10479.96	48.52	74.00	-25.48	39.08	6.57	38.39	35.52	163	100	Average	HORIZONTAL
2	10479.96	66.78	94.00	-27.22	57.34	6.57	38.39	35.52	163	100	Peak	HORIZONTAL

*Vertical*

	Freq	Level	Limit	Over	Read	CableAntenna	Preamp	T/Pos	A/Pos	Remark	Pol/Phase	
	MHz	dBuV/m	dBuV/m	dB	dBuV	dB	dB/m	dB	deg	cm		
1	10478.96	49.28	74.00	-24.72	39.83	6.57	38.40	35.52	94	100	Average	VERTICAL
2	10479.96	67.14	94.00	-26.86	57.69	6.57	38.40	35.52	94	100	Peak	VERTICAL



Temperature	24°C	Humidity	56%
Test Engineer	Allen Liu	Configurations	IEEE 802.11n MCS8 40MHz Ch 38 / Ant. 1 / A1+A5
Test Date	Apr. 04, 2010		

*Horizontal*

	Freq	Level	Limit	Over	Read	CableAntenna	Preamp	T/Pos	A/Pos	Remark	Pol/Phase	
	MHz	dBuV/m	dBuV/m	dB	dBuV	dB	dB/m	dB	deg	cm		
1	10379.95	53.86	94.00	-40.14	44.58	6.50	38.38	35.60	293	100	Peak	HORIZONTAL
2	10380.11	40.35	74.00	-33.65	31.07	6.50	38.38	35.60	293	100	Average	HORIZONTAL

*Vertical*

	Freq	Level	Limit	Over	Read	CableAntenna	Preamp	T/Pos	A/Pos	Remark	Pol/Phase	
	MHz	dBuV/m	dBuV/m	dB	dBuV	dB	dB/m	dB	deg	cm		
1	10380.09	41.68	74.00	-32.32	32.40	6.50	38.38	35.60	129	100	Average	VERTICAL
2	10380.17	57.13	94.00	-36.87	47.85	6.50	38.38	35.60	129	100	Peak	VERTICAL

Temperature	24°C	Humidity	56%
Test Engineer	Allen Liu	Configurations	IEEE 802.11n MCS8 40MHz Ch 46 / Ant. 1 / A1+A5
Test Date	Apr. 04, 2010		

#### Horizontal

	Freq	Level	Limit Line	Over Limit	Read Level	Cable Loss	Antenna Factor	Preamp Factor	T/Pos	A/Pos	Remark	Pol/Phase
	MHz	dBuV/m	dBuV/m	dB	dBuV	dB	dB/m	dB	deg	cm		
1	10459.91	66.16	94.00	-27.84	56.76	6.55	38.39	35.54	95	100	Peak	HORIZONTAL
2	10460.50	47.37	74.00	-26.63	37.97	6.55	38.39	35.54	95	100	Average	HORIZONTAL

#### Vertical

	Freq	Level	Limit Line	Over Limit	Read Level	Cable Loss	Antenna Factor	Preamp Factor	T/Pos	A/Pos	Remark	Pol/Phase
	MHz	dBuV/m	dBuV/m	dB	dBuV	dB	dB/m	dB	deg	cm		
1	10459.70	47.41	74.00	-26.59	38.01	6.55	38.39	35.54	130	100	Average	VERTICAL
2	10459.93	65.08	94.00	-28.92	55.68	6.55	38.39	35.54	130	100	Peak	VERTICAL

#### Note:

The amplitude of spurious emissions that are attenuated by more than 20dB below the permissible value has no need to be reported.

Emission level (dBuV/m) = 20 log Emission level (uV/m).

Corrected Reading: Antenna Factor + Cable Loss + Read Level - Preamp Factor = Level.

The limits above 5GHz shall be extrapolated to the specified distance using an extrapolation factor of 20 dB/decade form 3m to 1.5m.

Distance extrapolation factor = 20 log (specific distance [3m] / test distance [1.5m]) (dB);

Limit line = specific limits (dBuV) + distance extrapolation factor [6 dB].



Temperature	24°C	Humidity	56%
Test Engineer	Allen Liu	Configurations	IEEE 802.11a Ch 36 / Ant. 1 / A1+A5
Test Date	Apr. 04, 2010		

*Horizontal*

	Freq	Level	Limit	Over	Read	CableAntenna	Preamp	T/Pos	A/Pos	Remark	Pol/Phase	
	MHz	dBuV/m	dBuV/m	dB	dBuV	Loss	Factor	Factor	deg	cm		
1	10358.40	63.14	94.00	-30.86	53.90	6.49	38.37	35.62	34	100	Peak	HORIZONTAL
2	10359.40	49.87	74.00	-24.13	40.63	6.49	38.37	35.62	34	100	Average	HORIZONTAL

*Vertical*

	Freq	Level	Limit	Over	Read	CableAntenna	Preamp	T/Pos	A/Pos	Remark	Pol/Phase	
	MHz	dBuV/m	dBuV/m	dB	dBuV	Loss	Factor	Factor	deg	cm		
1	10361.92	64.79	94.00	-29.21	55.55	6.49	38.37	35.62	127	105	Peak	VERTICAL
2	10362.16	51.33	74.00	-22.67	42.09	6.49	38.37	35.62	127	105	Average	VERTICAL



Temperature	24°C	Humidity	56%
Test Engineer	Allen Liu	Configurations	IEEE 802.11a Ch 40 / Ant. 1 / A1+A5
Test Date	Apr. 04, 2010		

*Horizontal*

	Freq	Level	Limit	Over	Read	CableAntenna	Preamp	T/Pos	A/Pos	Remark	Pol/Phase	
	MHz	dBuV/m	dBuV/m	dB	dBuV	Loss	Factor	Factor	deg	cm		
1	10397.30	64.58	94.00	-29.42	55.26	6.52	38.38	35.58	20	100	Peak	HORIZONTAL
2	10402.50	51.60	74.00	-22.40	42.28	6.52	38.38	35.58	20	100	Average	HORIZONTAL

*Vertical*

	Freq	Level	Limit	Over	Read	CableAntenna	Preamp	T/Pos	A/Pos	Remark	Pol/Phase	
	MHz	dBuV/m	dBuV/m	dB	dBuV	Loss	Factor	Factor	deg	cm		
1	10399.00	65.44	94.00	-28.56	56.12	6.52	38.38	35.58	127	100	Peak	VERTICAL
2	10402.20	53.31	74.00	-20.69	43.99	6.52	38.38	35.58	127	100	Average	VERTICAL



Temperature	24°C	Humidity	56%
Test Engineer	Allen Liu	Configurations	IEEE 802.11a Ch 48 / Ant. 1 / A1+A5
Test Date	Apr. 04, 2010		

*Horizontal*

	Freq	Level	Limit Line	Over Limit	Read Level	Cable Loss	Antenna Factor	Preamp Factor	T/Pos	A/Pos	Remark	Pol/Phase
	MHz	dBuV/m	dBuV/m	dB	dBuV	dB	dB/m	dB	deg	cm		
1	10477.27	51.76	74.00	-22.24	42.32	6.57	38.39	35.52	93	100	Average	HORIZONTAL
2	10477.67	66.07	94.00	-27.93	56.63	6.57	38.39	35.52	93	100	Peak	HORIZONTAL

*Vertical*

	Freq	Level	Limit Line	Over Limit	Read Level	Cable Loss	Antenna Factor	Preamp Factor	T/Pos	A/Pos	Remark	Pol/Phase
	MHz	dBuV/m	dBuV/m	dB	dBuV	dB	dB/m	dB	deg	cm		
1	10481.69	52.61	74.00	-21.39	43.16	6.57	38.40	35.52	128	100	Average	VERTICAL
2	10481.90	66.64	94.00	-27.36	57.19	6.57	38.40	35.52	128	100	Peak	VERTICAL

Note:

The amplitude of spurious emissions that are attenuated by more than 20dB below the permissible value has no need to be reported.

Emission level (dBuV/m) = 20 log Emission level (uV/m).

Corrected Reading: Antenna Factor + Cable Loss + Read Level - Preamp Factor = Level.

The limits above 5GHz shall be extrapolated to the specified distance using an extrapolation factor of 20 dB/decade form 3m to 1.5m.

Distance extrapolation factor = 20 log (specific distance [3m] / test distance [1.5m]) (dB);

Limit line = specific limits (dBuV) + distance extrapolation factor [6 dB].

&lt; For Ant. 2 &gt;

Temperature	24°C	Humidity	56%
Test Engineer	Allen Liu	Configurations	IEEE 802.11n MCS8 20MHz Ch 36 / Ant. 2 / A1+A5
Test Date	Apr. 26, 2010		

**Horizontal**

	Freq	Level	Limit Line	Over Limit	Read Level	CableAntenna Loss Factor	Preamp Factor	T/Pos	A/Pos	Remark	Pol/Phase	
	MHz	dBuV/m	dBuV/m	dB	dBuV	dB	dB/m	deg	cm			
1	10359.97	40.57	74.00	-33.43	32.83	4.99	38.37	35.62	100	100	Average	HORIZONTAL
2	10360.00	53.92	94.00	-40.08	46.18	4.99	38.37	35.62	100	100	Peak	HORIZONTAL

**Vertical**

	Freq	Level	Limit Line	Over Limit	Read Level	CableAntenna Loss Factor	Preamp Factor	T/Pos	A/Pos	Remark	Pol/Phase	
	MHz	dBuV/m	dBuV/m	dB	dBuV	dB	dB/m	deg	cm			
1	10359.99	64.99	94.00	-29.01	57.25	4.99	38.37	35.62	193	100	Peak	VERTICAL
2	10359.99	49.11	74.00	-24.89	41.37	4.99	38.37	35.62	193	100	Average	VERTICAL





Temperature	24°C	Humidity	56%
Test Engineer	Allen Liu	Configurations	IEEE 802.11n MCS8 20MHz Ch 40 / Ant. 2 / A1+A5
Test Date	Apr. 26, 2010		

*Horizontal*

	Freq	Level	Limit	Over	Read	Cable	Antenna	Preamp	T/Pos	A/Pos	Remark	Pol/Phase
	MHz	dBuV/m	dBuV/m	dB	dBuV	dB	dB/m	dB	deg	cm		
1	10399.98	56.69	94.00	-37.31	48.87	5.02	38.38	35.58	111	100	Peak	HORIZONTAL
2	10400.03	41.47	74.00	-32.53	33.65	5.02	38.38	35.58	111	100	Average	HORIZONTAL

*Vertical*

	Freq	Level	Limit	Over	Read	Cable	Antenna	Preamp	T/Pos	A/Pos	Remark	Pol/Phase
	MHz	dBuV/m	dBuV/m	dB	dBuV	dB	dB/m	dB	deg	cm		
1	10399.97	51.38	74.00	-22.62	43.56	5.02	38.38	35.58	236	100	Average	VERTICAL
2	10399.99	68.44	94.00	-25.56	60.62	5.02	38.38	35.58	236	100	Peak	VERTICAL



Temperature	24°C	Humidity	56%
Test Engineer	Allen Liu	Configurations	IEEE 802.11n MCS8 20MHz Ch 48 / Ant. 2 / A1+A5
Test Date	Apr. 26, 2010		

*Horizontal*

	Freq	Level	Limit Line	Over Limit	Read Level	Cable Loss	Antenna Factor	Preamp Factor	T/Pos	A/Pos	Remark	Pol/Phase
	MHz	dBuV/m	dBuV/m	dB	dBuV	dB	dB/m	dB	deg	cm		
1	10479.97	44.18	74.00	-29.82	36.24	5.07	38.39	35.52	45	100	Average	HORIZONTAL
2	10480.01	59.35	94.00	-34.65	51.41	5.07	38.39	35.52	45	100	Peak	HORIZONTAL

*Vertical*

	Freq	Level	Limit Line	Over Limit	Read Level	Cable Loss	Antenna Factor	Preamp Factor	T/Pos	A/Pos	Remark	Pol/Phase
	MHz	dBuV/m	dBuV/m	dB	dBuV	dB	dB/m	dB	deg	cm		
1	10479.97	51.25	74.00	-22.75	43.30	5.07	38.40	35.52	212	100	Average	VERTICAL
2	10480.01	67.49	94.00	-26.51	59.54	5.07	38.40	35.52	212	100	Peak	VERTICAL



Temperature	24°C	Humidity	56%
Test Engineer	Allen Liu	Configurations	IEEE 802.11n MCS8 40MHz Ch 38 / Ant. 2 / A1+A5
Test Date	Apr. 26, 2010		

*Horizontal*

	Freq	Level	Limit Line	Over Limit	Read Level	Cable Loss	Antenna Factor	Preamp Factor	T/Pos	A/Pos	Remark	Pol/Phase
	MHz	dBuV/m	dBuV/m	dB	dBuV	dB	dB/m	dB	deg	cm		
1	10379.97	39.52	74.00	-34.48	31.74	5.00	38.38	35.60	334	100	Average	HORIZONTAL
2	10380.02	52.26	94.00	-41.74	44.48	5.00	38.38	35.60	334	100	Peak	HORIZONTAL

*Vertical*

	Freq	Level	Limit Line	Over Limit	Read Level	Cable Loss	Antenna Factor	Preamp Factor	T/Pos	A/Pos	Remark	Pol/Phase
	MHz	dBuV/m	dBuV/m	dB	dBuV	dB	dB/m	dB	deg	cm		
1	10379.98	59.36	94.00	-34.64	51.58	5.00	38.38	35.60	206	100	Peak	VERTICAL
2	10380.01	43.26	74.00	-30.74	35.48	5.00	38.38	35.60	206	100	Average	VERTICAL



Temperature	24°C	Humidity	56%
Test Engineer	Allen Liu	Configurations	IEEE 802.11n MCS8 40MHz Ch 46 / Ant. 2 / A1+A5
Test Date	Apr. 26, 2010		

**Horizontal**

	Freq	Level	Limit Line	Over Limit	Read Level	Cable Loss	Antenna Factor	Preamp Factor	T/Pos	A/Pos	Remark	Pol/Phase
	MHz	dBuV/m	dBuV/m	dB	dBuV	dB	dB/m	dB	deg	cm		
1	10459.99	53.70	94.00	-40.30	45.80	5.05	38.39	35.54	129	100	Peak	HORIZONTAL
2	10460.03	40.40	74.00	-33.60	32.50	5.05	38.39	35.54	129	100	Average	HORIZONTAL

**Vertical**

	Freq	Level	Limit Line	Over Limit	Read Level	Cable Loss	Antenna Factor	Preamp Factor	T/Pos	A/Pos	Remark	Pol/Phase
	MHz	dBuV/m	dBuV/m	dB	dBuV	dB	dB/m	dB	deg	cm		
1	10459.97	48.02	74.00	-25.98	40.12	5.05	38.39	35.54	209	100	Average	VERTICAL
2	10459.98	64.50	94.00	-29.50	56.60	5.05	38.39	35.54	209	100	Peak	VERTICAL

Note:

The amplitude of spurious emissions that are attenuated by more than 20dB below the permissible value has no need to be reported.

Emission level (dBuV/m) = 20 log Emission level (uV/m).

Corrected Reading: Antenna Factor + Cable Loss + Read Level - Preamp Factor = Level.

The limits above 5GHz shall be extrapolated to the specified distance using an extrapolation factor of 20 dB/decade form 3m to 1.5m.

Distance extrapolation factor = 20 log (specific distance [3m] / test distance [1.5m]) (dB);

Limit line = specific limits (dBuV) + distance extrapolation factor [6 dB].



Temperature	24°C	Humidity	56%
Test Engineer	Allen Liu	Configurations	IEEE 802.11a Ch 36 / Ant. 2 / A1+A5
Test Date	Apr. 26, 2010		

*Horizontal*

	Freq	Level	Limit	Over	Read	Cable	Antenna	Preamp	T/Pos	A/Pos	Remark	Pol/Phase
	MHz	dBuV/m	dBuV/m	dB	dBuV	dB	dB/m	dB	deg	cm		
1	10359.97	44.17	74.00	-29.83	36.43	4.99	38.37	35.62	36	100	Average	HORIZONTAL
2	10360.01	59.92	94.00	-34.08	52.18	4.99	38.37	35.62	36	100	Peak	HORIZONTAL

*Vertical*

	Freq	Level	Limit	Over	Read	Cable	Antenna	Preamp	T/Pos	A/Pos	Remark	Pol/Phase
	MHz	dBuV/m	dBuV/m	dB	dBuV	dB	dB/m	dB	deg	cm		
1	10359.97	50.11	74.00	-23.89	42.37	4.99	38.37	35.62	205	100	Average	VERTICAL
2	10360.00	63.65	94.00	-30.35	55.91	4.99	38.37	35.62	205	100	Peak	VERTICAL



Temperature	24°C	Humidity	56%
Test Engineer	Allen Liu	Configurations	IEEE 802.11a Ch 40 / Ant. 2 / A1+A5
Test Date	Apr. 26, 2010		

*Horizontal*

	Freq	Level	Limit	Over	Read	Cable	Antenna	Preamp	T/Pos	A/Pos	Remark	Pol/Phase
	MHz	dBuV/m	dBuV/m	dB	dBuV	dB	dB/m	dB	deg	cm		
1	10399.97	41.38	74.00	-32.62	33.56	5.02	38.38	35.58	172	100	Average	HORIZONTAL
2	10399.98	53.32	94.00	-40.68	45.50	5.02	38.38	35.58	172	100	Peak	HORIZONTAL

*Vertical*

	Freq	Level	Limit	Over	Read	Cable	Antenna	Preamp	T/Pos	A/Pos	Remark	Pol/Phase
	MHz	dBuV/m	dBuV/m	dB	dBuV	dB	dB/m	dB	deg	cm		
1	10399.97	52.04	74.00	-21.96	44.22	5.02	38.38	35.58	262	100	Average	VERTICAL
2	10400.01	68.33	94.00	-25.67	60.51	5.02	38.38	35.58	262	100	Peak	VERTICAL



<b>Temperature</b>	24°C	<b>Humidity</b>	56%
<b>Test Engineer</b>	Allen Liu	<b>Configurations</b>	IEEE 802.11a Ch 48 / Ant. 2 / A1+A5
<b>Test Date</b>	Apr. 26, 2010		

*Horizontal*

	Freq	Level	Limit Line	Over Limit	Read Level	Cable Loss	Antenna Factor	Preamp Factor	T/Pos	A/Pos	Remark	Pol/Phase
	MHz	dBuV/m	dBuV/m	dB	dBuV	dB	dB/m	dB	deg	cm		
1	10479.97	42.16	74.00	-31.84	34.22	5.07	38.39	35.52	62	100	Average	HORIZONTAL
2	10480.00	59.03	94.00	-34.97	51.09	5.07	38.39	35.52	62	100	Peak	HORIZONTAL

*Vertical*

	Freq	Level	Limit Line	Over Limit	Read Level	Cable Loss	Antenna Factor	Preamp Factor	T/Pos	A/Pos	Remark	Pol/Phase
	MHz	dBuV/m	dBuV/m	dB	dBuV	dB	dB/m	dB	deg	cm		
1	10479.97	51.07	74.00	-22.93	43.12	5.07	38.40	35.52	284	100	Average	VERTICAL
2	10479.99	65.68	94.00	-28.32	57.73	5.07	38.40	35.52	284	100	Peak	VERTICAL

Note:

The amplitude of spurious emissions that are attenuated by more than 20dB below the permissible value has no need to be reported.

Emission level (dBuV/m) = 20 log Emission level (uV/m).

Corrected Reading: Antenna Factor + Cable Loss + Read Level - Preamp Factor = Level.

The limits above 5GHz shall be extrapolated to the specified distance using an extrapolation factor of 20 dB/decade form 3m to 1.5m.

Distance extrapolation factor = 20 log (specific distance [3m] / test distance [1.5m]) (dB);

Limit line = specific limits (dBuV) + distance extrapolation factor [6 dB].

&lt; For Ant. 3 &gt;

Temperature	24°C	Humidity	56%
Test Engineer	Allen Liu	Configurations	IEEE 802.11n MCS8 20MHz Ch 36 / Ant. 3 / A1+A5
Test Date	Apr. 28, 2010		

**Horizontal**

	Freq	Level	Limit	Over	Read	Cable	Antenna	Preamp	T/Pos	A/Pos	Remark	Pol/Phase
	MHz	dBuV/m	dBuV/m	dB	dBuV	dB	dB/m	dB	deg	cm		
1	10359.99	42.85	74.00	-31.15	35.11	4.99	38.37	35.62	181	100	Average	HORIZONTAL
2	10360.00	59.64	94.00	-34.36	51.90	4.99	38.37	35.62	181	100	Peak	HORIZONTAL

**Vertical**

	Freq	Level	Limit	Over	Read	Cable	Antenna	Preamp	T/Pos	A/Pos	Remark	Pol/Phase
	MHz	dBuV/m	dBuV/m	dB	dBuV	dB	dB/m	dB	deg	cm		
1	10359.97	44.27	74.00	-29.73	36.53	4.99	38.37	35.62	109	100	Average	VERTICAL
2	10359.99	59.39	94.00	-34.61	51.65	4.99	38.37	35.62	109	100	Peak	VERTICAL





Temperature	24°C	Humidity	56%
Test Engineer	Allen Liu	Configurations	IEEE 802.11n MCS8 20MHz Ch 40 / Ant. 3 / A1+A5
Test Date	Apr. 28, 2010		

*Horizontal*

	Freq	Level	Limit Line	Over Limit	Read Level	Cable Loss	Antenna Factor	Preamp Factor	T/Pos	A/Pos	Remark	Pol/Phase
	MHz	dBuV/m	dBuV/m	dB	dBuV	dB	dB/m	dB	deg	cm		
1	10399.97	45.15	74.00	-28.85	37.33	5.02	38.38	35.58	141	100	Average	HORIZONTAL
2	10400.02	62.30	94.00	-31.70	54.48	5.02	38.38	35.58	141	100	Peak	HORIZONTAL

*Vertical*

	Freq	Level	Limit Line	Over Limit	Read Level	Cable Loss	Antenna Factor	Preamp Factor	T/Pos	A/Pos	Remark	Pol/Phase
	MHz	dBuV/m	dBuV/m	dB	dBuV	dB	dB/m	dB	deg	cm		
1	10399.99	45.44	74.00	-28.56	37.62	5.02	38.38	35.58	227	100	Average	VERTICAL
2	10400.01	62.60	94.00	-31.40	54.78	5.02	38.38	35.58	227	100	Peak	VERTICAL



Temperature	24°C	Humidity	56%
Test Engineer	Allen Liu	Configurations	IEEE 802.11n MCS8 20MHz Ch 48 / Ant. 3 / A1+A5
Test Date	Apr. 28, 2010		

*Horizontal*

	Freq	Level	Limit Line	Over Limit	Read Level	Cable Loss	Antenna Factor	Preamp Factor	T/Pos	A/Pos	Remark	Pol/Phase
	MHz	dBuV/m	dBuV/m	dB	dBuV	dB	dB/m	dB	deg	cm		
1	10479.97	44.82	74.00	-29.18	36.88	5.07	38.39	35.52	223	100	Average	HORIZONTAL
2	10480.00	60.20	94.00	-33.80	52.26	5.07	38.39	35.52	223	100	Peak	HORIZONTAL

*Vertical*

	Freq	Level	Limit Line	Over Limit	Read Level	Cable Loss	Antenna Factor	Preamp Factor	T/Pos	A/Pos	Remark	Pol/Phase
	MHz	dBuV/m	dBuV/m	dB	dBuV	dB	dB/m	dB	deg	cm		
1	10480.01	67.34	94.00	-26.66	59.39	5.07	38.40	35.52	321	100	Peak	VERTICAL
2	10480.03	48.49	74.00	-25.51	40.54	5.07	38.40	35.52	321	100	Average	VERTICAL



Temperature	24°C	Humidity	56%
Test Engineer	Allen Liu	Configurations	IEEE 802.11n MCS8 40MHz Ch 38 / Ant. 3 / A1+A5
Test Date	Apr. 28, 2010		

*Horizontal*

	Freq	Level	Limit Line	Over Limit	Read Level	Cable Loss	Antenna Factor	Preamp Factor	T/Pos	A/Pos	Remark	Pol/Phase
	MHz	dBuV/m	dBuV/m	dB	dBuV	dB	dB/m	dB	deg	cm		
1	10379.98	39.49	74.00	-34.51	31.71	5.00	38.38	35.60	241	100	Average	HORIZONTAL
2	10380.01	51.83	94.00	-42.17	44.05	5.00	38.38	35.60	241	100	Peak	HORIZONTAL

*Vertical*

	Freq	Level	Limit Line	Over Limit	Read Level	Cable Loss	Antenna Factor	Preamp Factor	T/Pos	A/Pos	Remark	Pol/Phase
	MHz	dBuV/m	dBuV/m	dB	dBuV	dB	dB/m	dB	deg	cm		
1	10379.98	40.90	74.00	-33.10	33.12	5.00	38.38	35.60	176	100	Average	VERTICAL
2	10379.98	51.34	94.00	-42.66	43.56	5.00	38.38	35.60	176	100	Peak	VERTICAL

Temperature	24°C	Humidity	56%
Test Engineer	Allen Liu	Configurations	IEEE 802.11n MCS8 40MHz Ch 46 / Ant. 3 / A1+A5
Test Date	Apr. 28, 2010		

#### Horizontal

	Freq	Level	Limit Line	Over Limit	Read Level	Cable Loss	Antenna Factor	Preamp Factor	T/Pos	A/Pos	Remark	Pol/Phase
	MHz	dBuV/m	dBuV/m	dB	dBuV	dB	dB/m	dB	deg	cm		
1	10459.98	43.90	74.00	-30.10	36.00	5.05	38.39	35.54	169	100	Average	HORIZONTAL
2	10460.00	61.80	94.00	-32.20	53.90	5.05	38.39	35.54	169	100	Peak	HORIZONTAL

#### Vertical

	Freq	Level	Limit Line	Over Limit	Read Level	Cable Loss	Antenna Factor	Preamp Factor	T/Pos	A/Pos	Remark	Pol/Phase
	MHz	dBuV/m	dBuV/m	dB	dBuV	dB	dB/m	dB	deg	cm		
1	10460.01	61.98	94.00	-32.02	54.08	5.05	38.39	35.54	117	100	Peak	VERTICAL
2	10460.02	45.30	74.00	-28.70	37.40	5.05	38.39	35.54	117	100	Average	VERTICAL

#### Note:

The amplitude of spurious emissions that are attenuated by more than 20dB below the permissible value has no need to be reported.

Emission level (dBuV/m) = 20 log Emission level (uV/m).

Corrected Reading: Antenna Factor + Cable Loss + Read Level - Preamp Factor = Level.

The limits above 5GHz shall be extrapolated to the specified distance using an extrapolation factor of 20 dB/decade from 3m to 1.5m.

Distance extrapolation factor = 20 log (specific distance [3m] / test distance [1.5m]) (dB);

Limit line = specific limits (dBuV) + distance extrapolation factor [6 dB].



Temperature	24°C	Humidity	56%
Test Engineer	Allen Liu	Configurations	IEEE 802.11a Ch 36 / Ant. 3 / A1+A5
Test Date	Apr. 28, 2010		

*Horizontal*

	Freq	Level	Limit Line	Over Limit	Read Level	Cable Loss	Antenna Factor	Preamp Factor	T/Pos	A/Pos	Remark	Pol/Phase
	MHz	dBuV/m	dBuV/m	dB	dBuV	dB	dB/m	dB	deg	cm		
1	10359.97	40.01	74.00	-33.99	32.27	4.99	38.37	35.62	174	100	Average	HORIZONTAL
2	10360.01	53.14	94.00	-40.86	45.40	4.99	38.37	35.62	174	100	Peak	HORIZONTAL

*Vertical*

	Freq	Level	Limit Line	Over Limit	Read Level	Cable Loss	Antenna Factor	Preamp Factor	T/Pos	A/Pos	Remark	Pol/Phase
	MHz	dBuV/m	dBuV/m	dB	dBuV	dB	dB/m	dB	deg	cm		
1	10359.97	43.81	74.00	-30.19	36.07	4.99	38.37	35.62	86	100	Average	VERTICAL
2	10360.01	60.71	94.00	-33.29	52.97	4.99	38.37	35.62	86	100	Peak	VERTICAL

Temperature	24°C	Humidity	56%
Test Engineer	Allen Liu	Configurations	IEEE 802.11a Ch 40 / Ant. 3 / A1+A5
Test Date	Apr. 28, 2010		

*Horizontal*

	Freq	Level	Limit Line	Over Limit	Read Level	Cable Loss	Antenna Factor	Preamp Factor	T/Pos	A/Pos	Remark	Pol/Phase
	MHz	dBuV/m	dBuV/m	dB	dBuV	dB	dB/m	dB	deg	cm		
1	10399.97	41.24	74.00	-32.76	33.42	5.02	38.38	35.58	261	100	Average	HORIZONTAL
2	10399.98	58.82	94.00	-35.18	51.00	5.02	38.38	35.58	261	100	Peak	HORIZONTAL

*Vertical*

	Freq	Level	Limit Line	Over Limit	Read Level	Cable Loss	Antenna Factor	Preamp Factor	T/Pos	A/Pos	Remark	Pol/Phase
	MHz	dBuV/m	dBuV/m	dB	dBuV	dB	dB/m	dB	deg	cm		
1	10399.97	45.53	74.00	-28.47	37.71	5.02	38.38	35.58	184	100	Average	VERTICAL
2	10399.99	62.13	94.00	-31.87	54.31	5.02	38.38	35.58	184	100	Peak	VERTICAL

Temperature	24°C	Humidity	56%
Test Engineer	Allen Liu	Configurations	IEEE 802.11a Ch 48 / Ant. 3 / A1+A5
Test Date	Apr. 28, 2010		

### Horizontal

	Freq	Level	Limit Line	Over Limit	Read Level	Cable Loss	Antenna Factor	Preamp Factor	T/Pos	A/Pos	Remark	Pol/Phase
	MHz	dBuV/m	dBuV/m	dB	dBuV	dB	dB/m	dB	deg	cm		
1	10479.97	41.74	74.00	-32.26	33.80	5.07	38.39	35.52	209	100	Average	HORIZONTAL
2	10480.01	53.48	94.00	-40.52	45.54	5.07	38.39	35.52	209	100	Peak	HORIZONTAL

### Vertical

	Freq	Level	Limit Line	Over Limit	Read Level	Cable Loss	Antenna Factor	Preamp Factor	T/Pos	A/Pos	Remark	Pol/Phase
	MHz	dBuV/m	dBuV/m	dB	dBuV	dB	dB/m	dB	deg	cm		
1	10479.97	43.60	74.00	-30.40	35.65	5.07	38.40	35.52	80	100	Average	VERTICAL
2	10479.98	55.96	94.00	-38.04	48.01	5.07	38.40	35.52	80	100	Peak	VERTICAL

### Note:

The amplitude of spurious emissions that are attenuated by more than 20dB below the permissible value has no need to be reported.

Emission level (dBuV/m) = 20 log Emission level (uV/m).

Corrected Reading: Antenna Factor + Cable Loss + Read Level - Preamp Factor = Level.

The limits above 5GHz shall be extrapolated to the specified distance using an extrapolation factor of 20 dB/decade form 3m to 1.5m.

Distance extrapolation factor = 20 log (specific distance [3m] / test distance [1.5m]) (dB);

Limit line = specific limits (dBuV) + distance extrapolation factor [6 dB].

&lt; For Ant. 4 &gt;

Temperature	24°C	Humidity	56%
Test Engineer	Allen Liu	Configurations	IEEE 802.11n MCS8 20MHz Ch 36 / Ant. 4 / A1+A5
Test Date	Apr. 29, 2010		

**Horizontal**

	Freq	Level	Limit	Over	Read	CableAntenna	Preamp	T/Pos	A/Pos	Remark	Pol/Phase	
	MHz	dBuV/m	dBuV/m	dB	dBuV	dB	dB/m	dB	deg	cm		
1	10359.99	52.58	94.00	-41.42	44.84	4.99	38.37	35.62	163	100	Peak	HORIZONTAL
2	10360.01	38.47	74.00	-35.53	30.73	4.99	38.37	35.62	163	100	Average	HORIZONTAL

**Vertical**

	Freq	Level	Limit	Over	Read	CableAntenna	Preamp	T/Pos	A/Pos	Remark	Pol/Phase	
	MHz	dBuV/m	dBuV/m	dB	dBuV	dB	dB/m	dB	deg	cm		
1	10360.00	55.23	94.00	-38.77	47.49	4.99	38.37	35.62	241	100	Peak	VERTICAL
2	10360.03	40.36	74.00	-33.64	32.62	4.99	38.37	35.62	241	100	Average	VERTICAL



Temperature	24°C	Humidity	56%
Test Engineer	Allen Liu	Configurations	IEEE 802.11n MCS8 20MHz Ch 40 / Ant. 4 / A1+A5
Test Date	Apr. 29, 2010		

### Horizontal

	Freq	Level	Limit Line	Over Limit	Read Level	Cable Loss	Antenna Factor	Preamp Factor	T/Pos	A/Pos	Remark	Pol/Phase
	MHz	dBuV/m	dBuV/m	dB	dBuV	dB	dB/m	dB	deg	cm		
1	10400.01	39.42	74.00	-34.58	31.60	5.02	38.38	35.58	105	100	Average	HORIZONTAL
2	10400.01	54.22	94.00	-39.78	46.40	5.02	38.38	35.58	105	100	Peak	HORIZONTAL

### Vertical

	Freq	Level	Limit Line	Over Limit	Read Level	Cable Loss	Antenna Factor	Preamp Factor	T/Pos	A/Pos	Remark	Pol/Phase
	MHz	dBuV/m	dBuV/m	dB	dBuV	dB	dB/m	dB	deg	cm		
1	10399.99	56.03	94.00	-37.97	48.21	5.02	38.38	35.58	183	100	Peak	VERTICAL
2	10400.01	39.55	74.00	-34.45	31.73	5.02	38.38	35.58	183	100	Average	VERTICAL



Temperature	24°C	Humidity	56%
Test Engineer	Allen Liu	Configurations	IEEE 802.11n MCS8 20MHz Ch 48 / Ant. 4 / A1+A5
Test Date	Apr. 29, 2010		

*Horizontal*

	Freq	Level	Limit Line	Over Limit	Read Level	CableAntenna Loss	Antenna Factor	Preamp Factor	T/Pos	A/Pos	Remark	Pol/Phase
	MHz	dBuV/m	dBuV/m	dB	dBuV	dB	dB/m	dB	deg	cm		
1	10479.97	44.49	74.00	-29.51	36.55	5.07	38.39	35.52	98	100	Average	HORIZONTAL
2	10479.98	58.66	94.00	-35.34	50.72	5.07	38.39	35.52	98	100	Peak	HORIZONTAL

*Vertical*

	Freq	Level	Limit Line	Over Limit	Read Level	CableAntenna Loss	Antenna Factor	Preamp Factor	T/Pos	A/Pos	Remark	Pol/Phase
	MHz	dBuV/m	dBuV/m	dB	dBuV	dB	dB/m	dB	deg	cm		
1	10480.02	60.26	94.00	-33.74	52.31	5.07	38.40	35.52	215	100	Peak	VERTICAL
2	10480.03	46.33	74.00	-27.67	38.38	5.07	38.40	35.52	215	100	Average	VERTICAL



Temperature	24°C	Humidity	56%
Test Engineer	Allen Liu	Configurations	IEEE 802.11n MCS8 40MHz Ch 38 / Ant. 4 / A1+A5
Test Date	Apr. 29, 2010		

*Horizontal*

	Freq	Level	Limit	Over	Read	Cable	Antenna	Preamp	T/Pos	A/Pos	Remark	Pol/Phase
	MHz	dBuV/m	dBuV/m	dB	dBuV	Loss	Factor	Factor	deg	cm		
1	10380.00	51.83	94.00	-42.17	44.05	5.00	38.38	35.60	218	100	Peak	HORIZONTAL
2	10380.03	38.10	74.00	-35.90	30.32	5.00	38.38	35.60	218	100	Average	HORIZONTAL

*Vertical*

	Freq	Level	Limit	Over	Read	Cable	Antenna	Preamp	T/Pos	A/Pos	Remark	Pol/Phase
	MHz	dBuV/m	dBuV/m	dB	dBuV	Loss	Factor	Factor	deg	cm		
1	10380.01	51.59	94.00	-42.41	43.81	5.00	38.38	35.60	337	100	Peak	VERTICAL
2	10380.03	38.22	74.00	-35.78	30.44	5.00	38.38	35.60	337	100	Average	VERTICAL

Temperature	24°C	Humidity	56%
Test Engineer	Allen Liu	Configurations	IEEE 802.11n MCS8 40MHz Ch 46 / Ant. 4 / A1+A5
Test Date	Apr. 29, 2010		

#### Horizontal

	Freq	Level	Limit Line	Over Limit	Read Level	Cable Loss	Antenna Factor	Preamp Factor	T/Pos	A/Pos	Remark	Pol/Phase
	MHz	dBuV/m	dBuV/m	dB	dBuV	dB	dB/m	dB	deg	cm		
1	10459.97	38.59	74.00	-35.41	30.69	5.05	38.39	35.54	292	100	Average	HORIZONTAL
2	10459.98	52.01	94.00	-41.99	44.11	5.05	38.39	35.54	292	100	Peak	HORIZONTAL

#### Vertical

	Freq	Level	Limit Line	Over Limit	Read Level	Cable Loss	Antenna Factor	Preamp Factor	T/Pos	A/Pos	Remark	Pol/Phase
	MHz	dBuV/m	dBuV/m	dB	dBuV	dB	dB/m	dB	deg	cm		
1	10459.97	39.67	74.00	-34.33	31.77	5.05	38.39	35.54	190	100	Average	VERTICAL
2	10460.01	53.64	94.00	-40.36	45.74	5.05	38.39	35.54	190	100	Peak	VERTICAL

#### Note:

The amplitude of spurious emissions that are attenuated by more than 20dB below the permissible value has no need to be reported.

Emission level (dBuV/m) = 20 log Emission level (uV/m).

Corrected Reading: Antenna Factor + Cable Loss + Read Level - Preamp Factor = Level.

The limits above 5GHz shall be extrapolated to the specified distance using an extrapolation factor of 20 dB/decade from 3m to 1.5m.

Distance extrapolation factor = 20 log (specific distance [3m] / test distance [1.5m]) (dB);

Limit line = specific limits (dBuV) + distance extrapolation factor [6 dB].



Temperature	24°C	Humidity	56%
Test Engineer	Allen Liu	Configurations	IEEE 802.11a Ch 36 / Ant. 4 / A1+A5
Test Date	Apr. 29, 2010		

*Horizontal*

	Freq	Level	Limit Line	Over Limit	Read Level	Cable Loss	Antenna Factor	Preamp Factor	T/Pos	A/Pos	Remark	Pol/Phase
	MHz	dBuV/m	dBuV/m	dB	dBuV	dB	dB/m	dB	deg	cm		
1	10360.00	54.18	94.00	-39.82	46.44	4.99	38.37	35.62	188	100	Peak	HORIZONTAL
2	10360.01	38.94	74.00	-35.06	31.20	4.99	38.37	35.62	188	100	Average	HORIZONTAL

*Vertical*

	Freq	Level	Limit Line	Over Limit	Read Level	Cable Loss	Antenna Factor	Preamp Factor	T/Pos	A/Pos	Remark	Pol/Phase
	MHz	dBuV/m	dBuV/m	dB	dBuV	dB	dB/m	dB	deg	cm		
1	10360.00	58.52	94.00	-35.48	50.78	4.99	38.37	35.62	62	100	Peak	VERTICAL
2	10360.00	42.28	74.00	-31.72	34.54	4.99	38.37	35.62	62	100	Average	VERTICAL



Temperature	24°C	Humidity	56%
Test Engineer	Allen Liu	Configurations	IEEE 802.11a Ch 40 / Ant. 4 / A1+A5
Test Date	Apr. 29, 2010		

*Horizontal*

	Freq	Level	Limit	Over	Read	Cable	Antenna	Preamp	T/Pos	A/Pos	Remark	Pol/Phase
	MHz	dBuV/m	dBuV/m	dB	dBuV	dB	dB/m	dB	deg	cm		
1	10399.99	40.83	74.00	-33.17	33.01	5.02	38.38	35.58	281	100	Average	HORIZONTAL
2	10400.00	55.52	94.00	-38.48	47.70	5.02	38.38	35.58	281	100	Peak	HORIZONTAL

*Vertical*

	Freq	Level	Limit	Over	Read	Cable	Antenna	Preamp	T/Pos	A/Pos	Remark	Pol/Phase
	MHz	dBuV/m	dBuV/m	dB	dBuV	dB	dB/m	dB	deg	cm		
1	10400.00	41.86	74.00	-32.14	34.04	5.02	38.38	35.58	194	100	Average	VERTICAL
2	10400.00	57.65	94.00	-36.35	49.83	5.02	38.38	35.58	194	100	Peak	VERTICAL

Temperature	24°C	Humidity	56%
Test Engineer	Allen Liu	Configurations	IEEE 802.11a Ch 48 / Ant. 4 / A1+A5
Test Date	Apr. 29, 2010		

#### Horizontal

	Freq	Level	Limit Line	Over Limit	Read Level	Cable Loss	Antenna Factor	Preamp Factor	T/Pos	A/Pos	Remark	Pol/Phase
	MHz	dBuV/m	dBuV/m	dB	dBuV	dB	dB/m	dB	deg	cm		
1	10479.99	56.72	94.00	-37.28	48.78	5.07	38.39	35.52	148	100	Peak	HORIZONTAL
2	10480.00	41.22	74.00	-32.78	33.28	5.07	38.39	35.52	148	100	Average	HORIZONTAL

#### Vertical

	Freq	Level	Limit Line	Over Limit	Read Level	Cable Loss	Antenna Factor	Preamp Factor	T/Pos	A/Pos	Remark	Pol/Phase
	MHz	dBuV/m	dBuV/m	dB	dBuV	dB	dB/m	dB	deg	cm		
1	10480.00	61.13	94.00	-32.87	53.18	5.07	38.40	35.52	241	100	Peak	VERTICAL
2	10480.01	44.74	74.00	-29.26	36.79	5.07	38.40	35.52	241	100	Average	VERTICAL

#### Note:

The amplitude of spurious emissions that are attenuated by more than 20dB below the permissible value has no need to be reported.

Emission level (dBuV/m) = 20 log Emission level (uV/m).

Corrected Reading: Antenna Factor + Cable Loss + Read Level - Preamp Factor = Level.

The limits above 5GHz shall be extrapolated to the specified distance using an extrapolation factor of 20 dB/decade form 3m to 1.5m.

Distance extrapolation factor = 20 log (specific distance [3m] / test distance [1.5m]) (dB);

Limit line = specific limits (dBuV) + distance extrapolation factor [6 dB].

&lt; For Ant. 6 &gt;

Temperature	24°C	Humidity	56%
Test Engineer	Allen Liu	Configurations	IEEE 802.11n MCS8 20MHz Ch 36 / Ant. 6 / A1+A5
Test Date	Apr. 29, 2010		

**Horizontal**

	Freq	Level	Limit	Over	Read	Cable	Antenna	Preamp	T/Pos	A/Pos	Remark	Pol/Phase
	MHz	dBuV/m	dBuV/m	dB	dBuV	dB	dB/m	dB	deg	cm		
1	10360.00	61.17	94.00	-32.83	53.43	4.99	38.37	35.62	215	100	Peak	HORIZONTAL
2	10360.03	43.04	74.00	-30.96	35.30	4.99	38.37	35.62	215	100	Average	HORIZONTAL

**Vertical**

	Freq	Level	Limit	Over	Read	Cable	Antenna	Preamp	T/Pos	A/Pos	Remark	Pol/Phase
	MHz	dBuV/m	dBuV/m	dB	dBuV	dB	dB/m	dB	deg	cm		
1	10360.00	58.79	94.00	-35.21	51.05	4.99	38.37	35.62	121	100	Peak	VERTICAL
2	10360.01	42.90	74.00	-31.10	35.16	4.99	38.37	35.62	121	100	Average	VERTICAL





Temperature	24°C	Humidity	56%
Test Engineer	Allen Liu	Configurations	IEEE 802.11n MCS8 20MHz Ch 40 / Ant. 6 / A1+A5
Test Date	Apr. 29, 2010		

*Horizontal*

	Freq	Level	Limit Line	Over Limit	Read Level	Cable Loss	Antenna Factor	Preamp Factor	T/Pos	A/Pos	Remark	Pol/Phase
	MHz	dBuV/m	dBuV/m	dB	dBuV	dB	dB/m	dB	deg	cm		
1	10399.99	61.56	94.00	-32.44	53.74	5.02	38.38	35.58	71	100	Peak	HORIZONTAL
2	10400.03	44.45	74.00	-29.55	36.63	5.02	38.38	35.58	71	100	Average	HORIZONTAL

*Vertical*

	Freq	Level	Limit Line	Over Limit	Read Level	Cable Loss	Antenna Factor	Preamp Factor	T/Pos	A/Pos	Remark	Pol/Phase
	MHz	dBuV/m	dBuV/m	dB	dBuV	dB	dB/m	dB	deg	cm		
1	10399.97	45.60	74.00	-28.40	37.78	5.02	38.38	35.58	221	100	Average	VERTICAL
2	10400.00	63.44	94.00	-30.56	55.62	5.02	38.38	35.58	221	100	Peak	VERTICAL



Temperature	24°C	Humidity	56%
Test Engineer	Allen Liu	Configurations	IEEE 802.11n MCS8 20MHz Ch 48 / Ant. 6 / A1+A5
Test Date	Apr. 29, 2010		

*Horizontal*

	Freq	Level	Limit	Over	Read	CableAntenna	Preamp	T/Pos	A/Pos	Remark	Pol/Phase	
	MHz	dBuV/m	dBuV/m	dB	dBuV	dB	dB/m	dB	deg	cm		
1	10479.99	59.53	94.00	-34.47	51.59	5.07	38.39	35.52	203	100	Peak	HORIZONTAL
2	10480.01	43.24	74.00	-30.76	35.30	5.07	38.39	35.52	203	100	Average	HORIZONTAL

*Vertical*

	Freq	Level	Limit	Over	Read	CableAntenna	Preamp	T/Pos	A/Pos	Remark	Pol/Phase	
	MHz	dBuV/m	dBuV/m	dB	dBuV	dB	dB/m	dB	deg	cm		
1	10480.01	45.54	74.00	-28.46	37.59	5.07	38.40	35.52	125	100	Average	VERTICAL
2	10480.01	61.28	94.00	-32.72	53.33	5.07	38.40	35.52	125	100	Peak	VERTICAL

Temperature	24°C	Humidity	56%
Test Engineer	Allen Liu	Configurations	IEEE 802.11n MCS8 40MHz Ch 38 / Ant. 6 / A1+A5
Test Date	Apr. 29, 2010		

#### Horizontal

	Freq	Level	Limit	Over	Read	Cable	Antenna	Preamp	T/Pos	A/Pos	Remark	Pol/Phase
	MHz	dBuV/m	dBuV/m	dB	dBuV	dB	dB/m	dB	deg	cm		
1	10379.98	53.18	94.00	-40.82	45.40	5.00	38.38	35.60	176	100	Peak	HORIZONTAL
2	10380.03	38.32	74.00	-35.68	30.54	5.00	38.38	35.60	176	100	Average	HORIZONTAL

#### Vertical

	Freq	Level	Limit	Over	Read	Cable	Antenna	Preamp	T/Pos	A/Pos	Remark	Pol/Phase
	MHz	dBuV/m	dBuV/m	dB	dBuV	dB	dB/m	dB	deg	cm		
1	10380.02	51.54	94.00	-42.46	43.76	5.00	38.38	35.60	274	100	Peak	VERTICAL
2	10380.03	39.43	74.00	-34.57	31.65	5.00	38.38	35.60	274	100	Average	VERTICAL

Temperature	24°C	Humidity	56%
Test Engineer	Allen Liu	Configurations	IEEE 802.11n MCS8 40MHz Ch 46 / Ant. 6 / A1+A5
Test Date	Apr. 29, 2010		

#### Horizontal

	Freq	Level	Limit Line	Over Limit	Read Level	Cable Loss	Antenna Factor	Preamp Factor	T/Pos	A/Pos	Remark	Pol/Phase
	MHz	dBuV/m	dBuV/m	dB	dBuV	dB	dB/m	dB	deg	cm		
1	10459.97	41.86	74.00	-32.14	33.96	5.05	38.39	35.54	228	100	Average	HORIZONTAL
2	10460.01	57.53	94.00	-36.47	49.63	5.05	38.39	35.54	228	100	Peak	HORIZONTAL

#### Vertical

	Freq	Level	Limit Line	Over Limit	Read Level	Cable Loss	Antenna Factor	Preamp Factor	T/Pos	A/Pos	Remark	Pol/Phase
	MHz	dBuV/m	dBuV/m	dB	dBuV	dB	dB/m	dB	deg	cm		
1	10459.97	43.34	74.00	-30.66	35.44	5.05	38.39	35.54	132	100	Average	VERTICAL
2	10460.00	59.62	94.00	-34.38	51.72	5.05	38.39	35.54	132	100	Peak	VERTICAL

#### Note:

The amplitude of spurious emissions that are attenuated by more than 20dB below the permissible value has no need to be reported.

Emission level (dBuV/m) = 20 log Emission level (uV/m).

Corrected Reading: Antenna Factor + Cable Loss + Read Level - Preamp Factor = Level.

The limits above 5GHz shall be extrapolated to the specified distance using an extrapolation factor of 20 dB/decade from 3m to 1.5m.

Distance extrapolation factor = 20 log (specific distance [3m] / test distance [1.5m]) (dB);

Limit line = specific limits (dBuV) + distance extrapolation factor [6 dB].



Temperature	24°C	Humidity	56%
Test Engineer	Allen Liu	Configurations	IEEE 802.11a Ch 36 / Ant. 6 / A1+A5
Test Date	Apr. 29, 2010		

*Horizontal*

	Freq	Level	Limit	Over	Read	Cable	Antenna	Preamp	T/Pos	A/Pos	Remark	Pol/Phase
	MHz	dBuV/m	dBuV/m	dB	dBuV	dB	dB/m	dB	deg	cm		
1	10359.99	51.54	94.00	-42.46	43.80	4.99	38.37	35.62	252	100	Peak	HORIZONTAL
2	10360.01	38.24	74.00	-35.76	30.50	4.99	38.37	35.62	252	100	Average	HORIZONTAL

*Vertical*

	Freq	Level	Limit	Over	Read	Cable	Antenna	Preamp	T/Pos	A/Pos	Remark	Pol/Phase
	MHz	dBuV/m	dBuV/m	dB	dBuV	dB	dB/m	dB	deg	cm		
1	10359.97	41.98	74.00	-32.02	34.24	4.99	38.37	35.62	145	100	Average	VERTICAL
2	10360.01	55.22	94.00	-38.78	47.48	4.99	38.37	35.62	145	100	Peak	VERTICAL



Temperature	24°C	Humidity	56%
Test Engineer	Allen Liu	Configurations	IEEE 802.11a Ch 40 / Ant. 6 / A1+A5
Test Date	Apr. 29, 2010		

*Horizontal*

	Freq	Level	Limit Line	Over Limit	Read Level	Cable Loss	Antenna Factor	Preamp Factor	T/Pos	A/Pos	Remark	Pol/Phase
	MHz	dBuV/m	dBuV/m	dB	dBuV	dB	dB/m	dB	deg	cm		
1	10399.97	39.33	74.00	-34.67	31.51	5.02	38.38	35.58	187	100	Average	HORIZONTAL
2	10399.99	51.82	94.00	-42.18	44.00	5.02	38.38	35.58	187	100	Peak	HORIZONTAL

*Vertical*

	Freq	Level	Limit Line	Over Limit	Read Level	Cable Loss	Antenna Factor	Preamp Factor	T/Pos	A/Pos	Remark	Pol/Phase
	MHz	dBuV/m	dBuV/m	dB	dBuV	dB	dB/m	dB	deg	cm		
1	10400.00	58.38	94.00	-35.62	50.56	5.02	38.38	35.58	256	100	Peak	VERTICAL
2	10400.03	43.90	74.00	-30.10	36.08	5.02	38.38	35.58	256	100	Average	VERTICAL

Temperature	24°C	Humidity	56%
Test Engineer	Allen Liu	Configurations	IEEE 802.11a Ch 48 / Ant. 6 / A1+A5
Test Date	Apr. 29, 2010		

### Horizontal

	Freq	Level	Limit Line	Over Limit	Read Level	Cable Loss	Antenna Factor	Preamp Factor	T/Pos	A/Pos	Remark	Pol/Phase
	MHz	dBuV/m	dBuV/m	dB	dBuV	dB	dB/m	dB	deg	cm		
1	10479.97	39.97	74.00	-34.03	32.03	5.07	38.39	35.52	241	100	Average	HORIZONTAL
2	10480.00	53.96	94.00	-40.04	46.02	5.07	38.39	35.52	241	100	Peak	HORIZONTAL

### Vertical

	Freq	Level	Limit Line	Over Limit	Read Level	Cable Loss	Antenna Factor	Preamp Factor	T/Pos	A/Pos	Remark	Pol/Phase
	MHz	dBuV/m	dBuV/m	dB	dBuV	dB	dB/m	dB	deg	cm		
1	10479.97	42.60	74.00	-31.40	34.65	5.07	38.40	35.52	136	100	Average	VERTICAL
2	10480.01	56.84	94.00	-37.16	48.89	5.07	38.40	35.52	136	100	Peak	VERTICAL

### Note:

The amplitude of spurious emissions that are attenuated by more than 20dB below the permissible value has no need to be reported.

Emission level (dBuV/m) = 20 log Emission level (uV/m).

Corrected Reading: Antenna Factor + Cable Loss + Read Level - Preamp Factor = Level.

The limits above 5GHz shall be extrapolated to the specified distance using an extrapolation factor of 20 dB/decade form 3m to 1.5m.

Distance extrapolation factor = 20 log (specific distance [3m] / test distance [1.5m]) (dB);

Limit line = specific limits (dBuV) + distance extrapolation factor [6 dB].

## 4.7. Band Edge Emissions Measurement

### 4.7.1. Limit

For transmitters operating in the 5.15-5.25 GHz band: all emissions outside of the 5.15-5.25 GHz band shall not exceed an EIRP of -27 dBm/MHz (68.3dBuV/m at 3m). For transmitters operating in the 5.470-5.725 GHz band: all emissions outside of the 5.470-5.725 GHz band shall not exceed an EIRP of -27 dBm/MHz (68.3dBuV/m at 3m). In addition, In case the emission fall within the restricted band specified on 15.205(a), then the 15.209(a) limit in the table below has to be followed.

Frequencies (MHz)	Field Strength (micorvolts/meter)	Measurement Distance (meters)
0.009~0.490	2400/F(KHz)	300
0.490~1.705	24000/F(KHz)	30
1.705~30.0	30	30
30~88	100	3
88~216	150	3
216~960	200	3
Above 960	500	3

### 4.7.2. Measuring Instruments and Setting

Please refer to section 5 of equipments list in this report. The following table is the setting of the spectrum analyzer.

Spectrum Parameter	Setting
Attenuation	Auto
Span Frequency	100 MHz
RB / VB (Emission in restricted band)	1MHz / 1MHz for Peak, 1 MHz / 10Hz for Average
RB / VB (Emission in non-restricted band)	1 MHz /1 MHz for Peak

### 4.7.3. Test Procedures

1. The test procedure is the same as section 4.6.3, only the frequency range investigated is limited to 100MHz around bandedges.
2. In case the emission is fail due to the used RB/VB is too wide, marker-delta method of FCC Public Notice DA00-705 will be followed.

### 4.7.4. Test Setup Layout

This test setup layout is the same as that shown in section 4.6.4.



#### 4.7.5. Test Deviation

There is no deviation with the original standard.

#### 4.7.6. EUT Operation during Test

The EUT was programmed to be in continuously transmitting mode.

#### 4.7.7. Test Result of Band Edge and Fundamental Emissions

< For Ant. 1 >

Temperature	24°C	Humidity	56%
Test Engineer	Allen Liu	Configurations	IEEE 802.11n MCS8 20MHz Ch 36, 40 / Ant. 1 / A1+A5
Test Date	Apr. 04, 2010		

##### Channel 36

	Freq	Level	Limit	Over	Read	Cable	Antenna	Preamp	T/Pos	A/Pos	Remark	PoI/Phase
	MHz	dBuV/m	dBuV/m	dB	dBuV	dB	dB/m	dB	deg	cm		
1	5146.20	75.49	80.00	-4.51	37.76	4.06	33.67	0.00	94	100	Peak	HORIZONTAL
2	5150.00	59.50	60.00	-0.50	21.77	4.06	33.67	0.00	94	100	Average	HORIZONTAL
3	5186.80	119.65	94.00			4.08	33.73	0.00	94	100	Peak	HORIZONTAL
4	5187.40	108.63	74.00			4.09	33.73	0.00	94	100	Average	HORIZONTAL

Item 3, 4 are the fundamental frequency at 5180 MHz.

##### Channel 40

	Freq	Level	Limit	Over	Read	Cable	Antenna	Preamp	T/Pos	A/Pos	Remark	PoI/Phase
	MHz	dBuV/m	dBuV/m	dB	dBuV	dB	dB/m	dB	deg	cm		
1	5150.00	59.04	60.00	-0.96	21.31	4.06	33.67	0.00	83	100	Average	HORIZONTAL
2	5150.00	73.07	80.00	-6.93	35.34	4.06	33.67	0.00	83	100	Peak	HORIZONTAL
3	5201.60	111.78	74.00			4.09	33.76	0.00	83	100	Average	HORIZONTAL
4	5206.00	123.66	94.00			4.09	33.76	0.00	83	100	Peak	HORIZONTAL

Item 3, 4 are the fundamental frequency at 5200 MHz.

Temperature	24°C	Humidity	56%
Test Engineer	Allen Liu	Configurations	IEEE 802.11n MCS8 40MHz Ch 38, 46 / Ant. 1 / A1+A5
Test Date	Apr. 02, 2010		

**Channel 38**

	Freq	Level	Limit Line	Over Limit	Read Level	Cable Loss	Antenna Factor	Preamp Factor	T/Pos	A/Pos	Remark	Pol/Phase
	MHz	dBuV/m	dBuV/m	dB	dBuV	dB	dB/m	dB	deg	cm		
1	5145.60	72.27	80.00	-7.73	34.54	4.06	33.67	0.00	90	100	Peak	HORIZONTAL
2	5150.00	59.65	60.00	-0.35	21.92	4.06	33.67	0.00	90	100	Average	HORIZONTAL
3	5198.80	101.23	74.00			4.09	33.76	0.00	90	100	Average	HORIZONTAL
4	5199.20	112.97	94.00			4.09	33.76	0.00	90	100	Peak	HORIZONTAL

Item 3, 4 are the fundamental frequency at 5190 MHz.

**Channel 46**

	Freq	Level	Limit Line	Over Limit	Read Level	Cable Loss	Antenna Factor	Preamp Factor	T/Pos	A/Pos	Remark	Pol/Phase
	MHz	dBuV/m	dBuV/m	dB	dBuV	dB	dB/m	dB	deg	cm		
1	5143.60	73.19	80.00	-6.81	35.46	4.06	33.67	0.00	82	100	Peak	HORIZONTAL
2	5150.00	59.48	60.00	-0.52	21.75	4.06	33.67	0.00	82	100	Average	HORIZONTAL
3	5236.80	119.80	94.00			4.10	33.82	0.00	82	100	Peak	HORIZONTAL
4	5245.20	108.38	74.00			4.12	33.82	0.00	82	100	Average	HORIZONTAL

Item 3, 4 are the fundamental frequency at 5230 MHz.

Note: Emission level (dBuV/m) = 20 log Emission level (uV/m)

Corrected Reading: Antenna Factor + Cable Loss + Read Level - Preamp Factor = Level

The limits above 5GHz shall be extrapolated to the specified distance using an extrapolation factor of 20 dB/decade from 3m to 1.5m.

Distance extrapolation factor = 20 log (specific distance [3m] / test distance [1.5m]) (dB);

Limit line = specific limits (dBuV) + distance extrapolation factor [6 dB].

Temperature	24°C	Humidity	56%
Test Engineer	Allen Liu	Configurations	IEEE 802.11a Ch 36, 40 / Ant. 1 / A1+A5
Test Date	Apr. 02, 2010		

### Channel 36

	Freq	Level	Limit Line	Over Limit	Read Level	Cable Loss	Antenna Factor	Preamp Factor	T/Pos	A/Pos	Remark	Pol/Phase
	MHz	dBuV/m	dBuV/m	dB	dBuV	dB	dB/m	dB	deg	cm		
1	5145.80	79.74	80.00	-0.26	42.01	4.06	33.67	0.00	78	100	Peak	HORIZONTAL
2	5150.00	59.97	60.00	-0.03	22.24	4.06	33.67	0.00	78	100	Average	HORIZONTAL
3	5186.00	121.40	94.00			4.08	33.73	0.00	78	100	Peak	HORIZONTAL
4	5186.40	111.83	74.00			4.08	33.73	0.00	78	100	Average	HORIZONTAL

Item 3, 4 are the fundamental frequency at 5180 MHz.

### Channel 40

	Freq	Level	Limit Line	Over Limit	Read Level	Cable Loss	Antenna Factor	Preamp Factor	T/Pos	A/Pos	Remark	Pol/Phase
	MHz	dBuV/m	dBuV/m	dB	dBuV	dB	dB/m	dB	deg	cm		
1	5148.00	59.94	60.00	-0.06	22.21	4.06	33.67	0.00	89	100	Average	HORIZONTAL
2	5148.00	74.36	80.00	-5.64	36.63	4.06	33.67	0.00	89	100	Peak	HORIZONTAL
3	5206.40	114.53	74.00			4.09	33.76	0.00	89	100	Average	HORIZONTAL
4	5206.80	124.40	94.00			4.09	33.76	0.00	89	100	Peak	HORIZONTAL

Item 3, 4 are the fundamental frequency at 5200 MHz.

Note:

Emission level (dBuV/m) = 20 log Emission level (uV/m)

Corrected Reading: Antenna Factor + Cable Loss + Read Level - Preamp Factor = Level

The limits above 5GHz shall be extrapolated to the specified distance using an extrapolation factor of 20 dB/decade form 3m to 1.5m.

Distance extrapolation factor = 20 log (specific distance [3m] / test distance [1.5m]) (dB);

Limit line = specific limits (dBuV) + distance extrapolation factor [6 dB].

< For Ant. 2 >

Temperature	24°C	Humidity	56%
Test Engineer	Allen Liu	Configurations	IEEE 802.11n MCS8 20MHz Ch 36, 40 / Ant. 2 / A1+A5
Test Date	Apr. 26, 2010		

#### Channel 36

	Freq	Level	Limit Line	Over Limit	Read Level	Cable Loss	Antenna Factor	Preamp Factor	T/Pos	A/Pos	Remark	Pol/Phase
	MHz	dBuV/m	dBuV/m	dB	dBuV	dB	dB/m	dB	deg	cm		
1	5146.20	75.32	80.00	-4.68	39.09	2.56	33.67	0.00	354	100	Peak	VERTICAL
2	5150.00	58.51	60.00	-1.49	22.28	2.56	33.67	0.00	354	100	Average	VERTICAL
3	5186.40	118.84	94.00			2.58	33.73	0.00	354	100	Peak	VERTICAL
4	5187.40	106.10	74.00			2.59	33.73	0.00	354	100	Average	VERTICAL

Item 3, 4 are the fundamental frequency at 5180 MHz.

#### Channel 40

	Freq	Level	Limit Line	Over Limit	Read Level	Cable Loss	Antenna Factor	Preamp Factor	T/Pos	A/Pos	Remark	Pol/Phase
	MHz	dBuV/m	dBuV/m	dB	dBuV	dB	dB/m	dB	deg	cm		
1	5148.80	73.10	80.00	-6.90	36.87	2.56	33.67	0.00	11	100	Peak	VERTICAL
2	5150.00	58.45	60.00	-1.55	22.22	2.56	33.67	0.00	11	100	Average	VERTICAL
3	5194.80	121.88	94.00			2.59	33.76	0.00	11	100	Peak	VERTICAL
4	5196.40	109.75	74.00			2.59	33.76	0.00	11	100	Average	VERTICAL

Item 3, 4 are the fundamental frequency at 5200 MHz.

Temperature	24°C	Humidity	56%
Test Engineer	Allen Liu	Configurations	IEEE 802.11n MCS8 40MHz Ch 38, 46 / Ant. 2 / A1+A5
Test Date	Apr. 26, 2010 ~ Apr. 28, 2010		

**Channel 38**

	Freq	Level	Limit Line	Over Limit	Read Level	Cable Loss	Antenna Factor	Preamp Factor	T/Pos	A/Pos	Remark	Pol/Phase
	MHz	dBuV/m	dBuV/m	dB	dBuV	dB	dB/m	dB	deg	cm		
1	5148.80	72.71	80.00	-7.29	36.48	2.56	33.67	0.00	351	100	Peak	VERTICAL
2	5150.00	59.38	60.00	-0.62	23.15	2.56	33.67	0.00	351	100	Average	VERTICAL
3	5195.60	112.15	94.00			2.59	33.76	0.00	351	100	Peak	VERTICAL
4	5196.40	99.42	74.00			2.59	33.76	0.00	351	100	Average	VERTICAL

Item 3, 4 are the fundamental frequency at 5190 MHz.

**Channel 46**

	Freq	Level	Limit Line	Over Limit	Read Level	Cable Loss	Antenna Factor	Preamp Factor	T/Pos	A/Pos	Remark	Pol/Phase
	MHz	dBuV/m	dBuV/m	dB	dBuV	dB	dB/m	dB	deg	cm		
1	5147.20	72.24	80.00	-7.76	36.01	2.56	33.67	0.00	342	100	Peak	VERTICAL
2	5150.00	59.09	60.00	-0.91	22.86	2.56	33.67	0.00	342	100	Average	VERTICAL
3	5218.40	105.97	74.00			2.60	33.79	0.00	342	100	Average	VERTICAL
4	5219.20	118.02	94.00			2.60	33.79	0.00	342	100	Peak	VERTICAL

Item 3, 4 are the fundamental frequency at 5230 MHz.

Note: Emission level (dBuV/m) = 20 log Emission level (uV/m)

Corrected Reading: Antenna Factor + Cable Loss + Read Level - Preamp Factor = Level

The limits above 5GHz shall be extrapolated to the specified distance using an extrapolation factor of 20 dB/decade from 3m to 1.5m.

Distance extrapolation factor = 20 log (specific distance [3m] / test distance [1.5m]) (dB);

Limit line = specific limits (dBuV) + distance extrapolation factor [6 dB].

<b>Temperature</b>	24°C	<b>Humidity</b>	56%
<b>Test Engineer</b>	Allen Liu	<b>Configurations</b>	IEEE 802.11a Ch 36, 40 / Ant. 2 / A1+A5
<b>Test Date</b>	Apr. 26, 2010		

### Channel 36

	Freq	Level	Limit Line	Over Limit	Read Level	Cable Loss	Antenna Factor	Preamp Factor	T/Pos	A/Pos	Remark	Pol/Phase
	MHz	dBuV/m	dBuV/m	dB	dBuV	dB	dB/m	dB	deg	cm		
1	5147.60	79.62	80.00	-0.38	43.39	2.56	33.67	0.00	346	100	Peak	VERTICAL
2	5150.00	59.17	60.00	-0.83	22.94	2.56	33.67	0.00	346	100	Average	VERTICAL
3	5184.60	119.61	94.00			2.58	33.73	0.00	346	100	Peak	VERTICAL
4	5187.40	109.60	74.00			2.59	33.73	0.00	346	100	Average	VERTICAL

Item 3, 4 are the fundamental frequency at 5180 MHz.

### Channel 40

	Freq	Level	Limit Line	Over Limit	Read Level	Cable Loss	Antenna Factor	Preamp Factor	T/Pos	A/Pos	Remark	Pol/Phase
	MHz	dBuV/m	dBuV/m	dB	dBuV	dB	dB/m	dB	deg	cm		
1	5148.00	70.78	80.00	-9.22	34.55	2.56	33.67	0.00	82	106	Peak	VERTICAL
2	5150.00	57.33	60.00	-2.67	21.10	2.56	33.67	0.00	82	106	Average	VERTICAL
3	5194.00	112.26	74.00			2.59	33.73	0.00	82	106	Average	VERTICAL
4	5196.80	122.28	94.00			2.59	33.76	0.00	82	106	Peak	VERTICAL

Item 3, 4 are the fundamental frequency at 5200 MHz.

Note:

Emission level (dBuV/m) = 20 log Emission level (uV/m)

Corrected Reading: Antenna Factor + Cable Loss + Read Level - Preamp Factor = Level

The limits above 5GHz shall be extrapolated to the specified distance using an extrapolation factor of 20 dB/decade form 3m to 1.5m.

Distance extrapolation factor = 20 log (specific distance [3m] / test distance [1.5m]) (dB);

Limit line = specific limits (dBuV) + distance extrapolation factor [6 dB].

< For Ant. 3 >

Temperature	24°C	Humidity	56%
Test Engineer	Allen Liu	Configurations	IEEE 802.11n MCS8 20MHz Ch 36, 40 / Ant. 3 / A1+A5
Test Date	Apr. 28, 2010		

#### Channel 36

	Freq	Level	Limit Line	Over Limit	Read Level	Cable Loss	Antenna Factor	Preamp Factor	T/Pos	A/Pos	Remark	Pol/Phase
	MHz	dBuV/m	dBuV/m	dB	dBuV	dB	dB/m	dB	deg	cm		
1	5148.40	78.22	80.00	-1.78	41.99	2.56	33.67	0.00	18	125	Peak	VERTICAL
2	5150.00	59.58	60.00	-0.42	23.35	2.56	33.67	0.00	18	125	Average	VERTICAL
3	5186.40	120.47	94.00			2.58	33.73	0.00	18	125	Peak	VERTICAL
4	5187.00	109.33	74.00			2.59	33.73	0.00	18	125	Average	VERTICAL

Item 3, 4 are the fundamental frequency at 5180 MHz.

#### Channel 40

	Freq	Level	Limit Line	Over Limit	Read Level	Cable Loss	Antenna Factor	Preamp Factor	T/Pos	A/Pos	Remark	Pol/Phase
	MHz	dBuV/m	dBuV/m	dB	dBuV	dB	dB/m	dB	deg	cm		
1	5135.60	69.72	80.00	-10.28	33.53	2.55	33.64	0.00	358	100	Peak	VERTICAL
2	5150.00	56.53	60.00	-3.47	20.30	2.56	33.67	0.00	358	100	Average	VERTICAL
3	5194.40	123.03	94.00			2.59	33.73	0.00	358	100	Peak	VERTICAL
4	5206.80	111.46	74.00			2.59	33.76	0.00	358	100	Average	VERTICAL

Item 3, 4 are the fundamental frequency at 5200 MHz.

Temperature	24°C	Humidity	56%
Test Engineer	Allen Liu	Configurations	IEEE 802.11n MCS8 40MHz Ch 38, 46 / Ant. 3 / A1+A5
Test Date	Apr. 28, 2010		

#### Channel 38

	Freq	Level	Limit Line	Over Limit	Read Level	Cable Loss	Antenna Factor	Preamp Factor	T/Pos	A/Pos	Remark	Pol/Phase
	MHz	dBuV/m	dBuV/m	dB	dBuV	dB	dB/m	dB	deg	cm		
1	5148.00	71.63	80.00	-8.37	35.40	2.56	33.67	0.00	10	100	Peak	VERTICAL
2	5150.00	59.55	60.00	-0.45	23.32	2.56	33.67	0.00	10	100	Average	VERTICAL
3	5194.80	114.63	94.00			2.59	33.76	0.00	10	100	Peak	VERTICAL
4	5197.60	102.30	74.00			2.59	33.76	0.00	10	100	Average	VERTICAL

Item 3, 4 are the fundamental frequency at 5190 MHz.

#### Channel 46

	Freq	Level	Limit Line	Over Limit	Read Level	Cable Loss	Antenna Factor	Preamp Factor	T/Pos	A/Pos	Remark	Pol/Phase
	MHz	dBuV/m	dBuV/m	dB	dBuV	dB	dB/m	dB	deg	cm		
1	5147.60	74.16	80.00	-5.84	37.93	2.56	33.67	0.00	21	135	Peak	VERTICAL
2	5150.00	59.80	60.00	-0.20	23.57	2.56	33.67	0.00	21	135	Average	VERTICAL
3	5217.60	106.98	74.00			2.60	33.79	0.00	21	135	Average	VERTICAL
4	5218.40	118.81	94.00			2.60	33.79	0.00	21	135	Peak	VERTICAL

Item 3, 4 are the fundamental frequency at 5230 MHz.

Note: Emission level (dBuV/m) = 20 log Emission level (uV/m)

Corrected Reading: Antenna Factor + Cable Loss + Read Level - Preamp Factor = Level

The limits above 5GHz shall be extrapolated to the specified distance using an extrapolation factor of 20 dB/decade from 3m to 1.5m.

Distance extrapolation factor = 20 log (specific distance [3m] / test distance [1.5m]) (dB);

Limit line = specific limits (dBuV) + distance extrapolation factor [6 dB].



Temperature	24°C	Humidity	56%
Test Engineer	Allen Liu	Configurations	IEEE 802.11a Ch 36, 40 / Ant. 3 / A1+A5
Test Date	Apr. 28, 2010		

#### Channel 36

	Freq	Level	Limit Line	Over Limit	Read Level	Cable Loss	Antenna Factor	Preamp Factor	T/Pos	A/Pos	Remark	PoI/Phase
	MHz	dBuV/m	dBuV/m	dB	dBuV	dB	dB/m	dB	deg	cm		
1	5148.20	79.34	80.00	-0.66	43.11	2.56	33.67	0.00	22	123	Peak	VERTICAL
2	5150.00	59.65	60.00	-0.35	23.42	2.56	33.67	0.00	22	123	Average	VERTICAL
3	5184.00	122.08	94.00			2.58	33.73	0.00	22	123	Peak	VERTICAL
4	5186.60	111.65	74.00			2.58	33.73	0.00	22	123	Average	VERTICAL

Item 3, 4 are the fundamental frequency at 5180 MHz.

#### Channel 40

	Freq	Level	Limit Line	Over Limit	Read Level	Cable Loss	Antenna Factor	Preamp Factor	T/Pos	A/Pos	Remark	PoI/Phase
	MHz	dBuV/m	dBuV/m	dB	dBuV	dB	dB/m	dB	deg	cm		
1	5148.00	75.94	80.00	-4.06	39.71	2.56	33.67	0.00	356	100	Peak	VERTICAL
2	5150.00	59.90	60.00	-0.10	23.67	2.56	33.67	0.00	356	100	Average	VERTICAL
3	5194.80	126.15	94.00			2.59	33.76	0.00	356	100	Peak	VERTICAL
4	5206.80	116.03	74.00			2.59	33.76	0.00	356	100	Average	VERTICAL

Item 3, 4 are the fundamental frequency at 5200 MHz.

Note:

Emission level (dBuV/m) = 20 log Emission level (uV/m)

Corrected Reading: Antenna Factor + Cable Loss + Read Level - Preamp Factor = Level

The limits above 5GHz shall be extrapolated to the specified distance using an extrapolation factor of 20 dB/decade form 3m to 1.5m.

Distance extrapolation factor = 20 log (specific distance [3m] / test distance [1.5m]) (dB);

Limit line = specific limits (dBuV) + distance extrapolation factor [6 dB].

< For Ant. 4 >

Temperature	24°C	Humidity	56%
Test Engineer	Allen Liu	Configurations	IEEE 802.11n MCS8 20MHz Ch 36, 40 / Ant. 4 / A1+A5
Test Date	Apr. 29, 2010		

#### Channel 36

	Freq	Level	Limit Line	Over Limit	Read Level	Cable Loss	Antenna Factor	Preamp Factor	T/Pos	A/Pos	Remark	Pol/Phase
	MHz	dBuV/m	dBuV/m	dB	dBuV	dB	dB/m	dB	deg	cm		
1	5146.60	73.00	80.00	-7.00	36.77	2.56	33.67	0.00	308	100	Peak	VERTICAL
2	5150.00	59.66	60.00	-0.34	23.43	2.56	33.67	0.00	308	100	Average	VERTICAL
3	5184.20	123.61	94.00			2.58	33.73	0.00	308	100	Peak	VERTICAL
4	5187.40	111.60	74.00			2.59	33.73	0.00	308	100	Average	VERTICAL

Item 3, 4 are the fundamental frequency at 5180 MHz.

#### Channel 40

	Freq	Level	Limit Line	Over Limit	Read Level	Cable Loss	Antenna Factor	Preamp Factor	T/Pos	A/Pos	Remark	Pol/Phase
	MHz	dBuV/m	dBuV/m	dB	dBuV	dB	dB/m	dB	deg	cm		
1	5144.00	58.99	60.00	-1.01	22.76	2.56	33.67	0.00	307	100	Average	VERTICAL
2	5147.60	71.21	80.00	-8.79	34.98	2.56	33.67	0.00	307	100	Peak	VERTICAL
3	5207.60	111.47	74.00			2.59	33.76	0.00	307	100	Average	VERTICAL
4	5207.60	123.28	94.00			2.59	33.76	0.00	307	100	Peak	VERTICAL

Item 3, 4 are the fundamental frequency at 5200 MHz.

Temperature	24°C	Humidity	56%
Test Engineer	Allen Liu	Configurations	IEEE 802.11n MCS8 40MHz Ch 38, 46 / Ant. 4 / A1+A5
Test Date	Apr. 29, 2010		

**Channel 38**

	Freq	Level	Limit Line	Over Limit	Read Level	Cable Loss	Antenna Factor	Preamp Factor	T/Pos	A/Pos	Remark	Pol/Phase
	MHz	dBuV/m	dBuV/m	dB	dBuV	dB	dB/m	dB	deg	cm		
1	5144.40	71.96	80.00	-8.04	35.73	2.56	33.67	0.00	307	100	Peak	VERTICAL
2	5150.00	59.41	60.00	-0.59	23.18	2.56	33.67	0.00	307	100	Average	VERTICAL
3	5199.20	103.87	74.00			2.59	33.76	0.00	307	100	Average	VERTICAL
4	5200.40	115.85	94.00			2.59	33.76	0.00	307	100	Peak	VERTICAL

Item 3, 4 are the fundamental frequency at 5190 MHz.

**Channel 46**

	Freq	Level	Limit Line	Over Limit	Read Level	Cable Loss	Antenna Factor	Preamp Factor	T/Pos	A/Pos	Remark	Pol/Phase
	MHz	dBuV/m	dBuV/m	dB	dBuV	dB	dB/m	dB	deg	cm		
1	5146.00	59.85	60.00	-0.15	23.62	2.56	33.67	0.00	302	100	Average	VERTICAL
2	5147.20	72.11	80.00	-7.89	35.88	2.56	33.67	0.00	302	100	Peak	VERTICAL
3	5220.00	110.55	74.00			2.60	33.79	0.00	302	100	Average	VERTICAL
4	5222.00	122.58	94.00			2.60	33.79	0.00	302	100	Peak	VERTICAL

Item 3, 4 are the fundamental frequency at 5230 MHz.

Note: Emission level (dBuV/m) = 20 log Emission level (uV/m)

Corrected Reading: Antenna Factor + Cable Loss + Read Level - Preamp Factor = Level

The limits above 5GHz shall be extrapolated to the specified distance using an extrapolation factor of 20 dB/decade from 3m to 1.5m.

Distance extrapolation factor = 20 log (specific distance [3m] / test distance [1.5m]) (dB);

Limit line = specific limits (dBuV) + distance extrapolation factor [6 dB].

Temperature	24°C	Humidity	56%
Test Engineer	Allen Liu	Configurations	IEEE 802.11a Ch 36, 40 / Ant. 4 / A1+A5
Test Date	Apr. 29, 2010		

### Channel 36

	Freq	Level	Limit Line	Over Limit	Read Level	Cable Loss	Antenna Factor	Preamp Factor	T/Pos	A/Pos	Remark	Pol/Phase
	MHz	dBuV/m	dBuV/m	dB	dBuV	dB	dB/m	dB	deg	cm		
1	5149.60	72.42	80.00	-7.58	36.19	2.56	33.67	0.00	17	101	Peak	VERTICAL
2	5150.00	59.48	60.00	-0.52	23.25	2.56	33.67	0.00	17	101	Average	VERTICAL
3	5185.60	114.05	74.00			2.58	33.73	0.00	17	101	Average	VERTICAL
4	5186.00	124.35	94.00			2.58	33.73	0.00	17	101	Peak	VERTICAL

Item 3, 4 are the fundamental frequency at 5180 MHz.

### Channel 40

	Freq	Level	Limit Line	Over Limit	Read Level	Cable Loss	Antenna Factor	Preamp Factor	T/Pos	A/Pos	Remark	Pol/Phase
	MHz	dBuV/m	dBuV/m	dB	dBuV	dB	dB/m	dB	deg	cm		
1	5145.60	72.46	80.00	-7.54	36.23	2.56	33.67	0.00	18	100	Peak	VERTICAL
2	5150.00	59.79	60.00	-0.21	23.56	2.56	33.67	0.00	18	100	Average	VERTICAL
3	5198.40	118.86	74.00			2.59	33.76	0.00	18	100	Average	VERTICAL
4	5201.20	128.91	94.00			2.59	33.76	0.00	18	100	Peak	VERTICAL

Item 3, 4 are the fundamental frequency at 5200 MHz.

Note:

Emission level (dBuV/m) = 20 log Emission level (uV/m)

Corrected Reading: Antenna Factor + Cable Loss + Read Level - Preamp Factor = Level

The limits above 5GHz shall be extrapolated to the specified distance using an extrapolation factor of 20 dB/decade form 3m to 1.5m.

Distance extrapolation factor = 20 log (specific distance [3m] / test distance [1.5m]) (dB);

Limit line = specific limits (dBuV) + distance extrapolation factor [6 dB].

< For Ant. 6 >

Temperature	24°C	Humidity	56%
Test Engineer	Allen Liu	Configurations	IEEE 802.11n MCS8 20MHz Ch 36, 40 / Ant. 6 / A1+A5
Test Date	Apr. 29, 2010		

#### Channel 36

	Freq	Level	Limit Line	Over Limit	Read Level	Cable Loss	Antenna Factor	Preamp Factor	T/Pos	A/Pos	Remark	Pol/Phase
	MHz	dBuV/m	dBuV/m	dB	dBuV	dB	dB/m	dB	deg	cm		
1	5148.40	75.25	80.00	-4.75	39.02	2.56	33.67	0.00	52	160	Peak	VERTICAL
2	5150.00	59.53	60.00	-0.47	23.30	2.56	33.67	0.00	52	160	Average	VERTICAL
3	5185.80	119.64	94.00			2.58	33.73	0.00	52	160	Peak	VERTICAL
4	5187.40	107.52	74.00			2.59	33.73	0.00	52	160	Average	VERTICAL

Item 3, 4 are the fundamental frequency at 5180 MHz.

#### Channel 40

	Freq	Level	Limit Line	Over Limit	Read Level	Cable Loss	Antenna Factor	Preamp Factor	T/Pos	A/Pos	Remark	Pol/Phase
	MHz	dBuV/m	dBuV/m	dB	dBuV	dB	dB/m	dB	deg	cm		
1	5148.80	74.47	80.00	-5.53	38.24	2.56	33.67	0.00	322	155	Peak	VERTICAL
2	5150.00	59.90	60.00	-0.10	23.67	2.56	33.67	0.00	322	155	Average	VERTICAL
3	5198.40	111.74	74.00			2.59	33.76	0.00	322	155	Average	VERTICAL
4	5204.00	123.27	94.00			2.59	33.76	0.00	322	155	Peak	VERTICAL

Item 3, 4 are the fundamental frequency at 5200 MHz.

Temperature	24°C	Humidity	56%
Test Engineer	Allen Liu	Configurations	IEEE 802.11n MCS8 40MHz Ch 38, 46 / Ant. 6 / A1+A5
Test Date	Apr. 29, 2010		

**Channel 38**

	Freq	Level	Limit Line	Over Limit	Read Level	Cable Loss	Antenna Factor	Preamp Factor	T/Pos	A/Pos	Remark	Pol/Phase
	MHz	dBuV/m	dBuV/m	dB	dBuV	dB	dB/m	dB	deg	cm		
1	5148.40	73.64	80.00	-6.36	37.41	2.56	33.67	0.00	318	157	Peak	VERTICAL
2	5150.00	59.95	60.00	-0.05	23.72	2.56	33.67	0.00	318	157	Average	VERTICAL
3	5192.40	112.48	94.00			2.59	33.73	0.00	318	157	Peak	VERTICAL
4	5198.80	101.05	74.00			2.59	33.76	0.00	318	157	Average	VERTICAL

Item 3, 4 are the fundamental frequency at 5190 MHz.

**Channel 46**

	Freq	Level	Limit Line	Over Limit	Read Level	Cable Loss	Antenna Factor	Preamp Factor	T/Pos	A/Pos	Remark	Pol/Phase
	MHz	dBuV/m	dBuV/m	dB	dBuV	dB	dB/m	dB	deg	cm		
1	5137.60	72.63	80.00	-7.37	36.43	2.56	33.64	0.00	187	158	Peak	VERTICAL
2	5150.00	59.36	60.00	-0.64	23.13	2.56	33.67	0.00	187	158	Average	VERTICAL
3	5235.60	118.08	94.00			2.60	33.82	0.00	187	158	Peak	VERTICAL
4	5236.40	106.23	74.00			2.60	33.82	0.00	187	158	Average	VERTICAL

Item 3, 4 are the fundamental frequency at 5230 MHz.

Note: Emission level (dBuV/m) = 20 log Emission level (uV/m)

Corrected Reading: Antenna Factor + Cable Loss + Read Level - Preamp Factor = Level

The limits above 5GHz shall be extrapolated to the specified distance using an extrapolation factor of 20 dB/decade form 3m to 1.5m.

Distance extrapolation factor = 20 log (specific distance [3m] / test distance [1.5m]) (dB);

Limit line = specific limits (dBuV) + distance extrapolation factor [6 dB].

Temperature	24°C	Humidity	56%
Test Engineer	Allen Liu	Configurations	IEEE 802.11a Ch 36, 40 / Ant. 6 / A1+A5
Test Date	Apr. 29, 2010		

#### Channel 36

	Freq	Level	Limit Line	Over Limit	Read Level	Cable Loss	Antenna Factor	Preamp Factor	T/Pos	A/Pos	Remark	Pol/Phase
	MHz	dBuV/m	dBuV/m	dB	dBuV	dB	dB/m	dB	deg	cm		
1	5147.40	79.57	80.00	-0.43	43.34	2.56	33.67	0.00	346	166	Peak	VERTICAL
2	5150.00	59.54	60.00	-0.46	23.31	2.56	33.67	0.00	346	166	Average	VERTICAL
3	5182.20	121.37	94.00			2.58	33.73	0.00	346	166	Peak	VERTICAL
4	5184.60	110.52	74.00			2.58	33.73	0.00	346	166	Average	VERTICAL

Item 3, 4 are the fundamental frequency at 5180 MHz.

#### Channel 40

	Freq	Level	Limit Line	Over Limit	Read Level	Cable Loss	Antenna Factor	Preamp Factor	T/Pos	A/Pos	Remark	Pol/Phase
	MHz	dBuV/m	dBuV/m	dB	dBuV	dB	dB/m	dB	deg	cm		
1	5148.00	77.81	80.00	-2.19	41.58	2.56	33.67	0.00	26	153	Peak	VERTICAL
2	5150.00	59.30	60.00	-0.70	23.07	2.56	33.67	0.00	26	153	Average	VERTICAL
3	5194.40	125.38	94.00			2.59	33.73	0.00	26	153	Peak	VERTICAL
4	5195.60	113.03	74.00			2.59	33.76	0.00	26	153	Average	VERTICAL

Item 3, 4 are the fundamental frequency at 5200 MHz.

Note:

Emission level (dBuV/m) = 20 log Emission level (uV/m)

Corrected Reading: Antenna Factor + Cable Loss + Read Level - Preamp Factor = Level

The limits above 5GHz shall be extrapolated to the specified distance using an extrapolation factor of 20 dB/decade form 3m to 1.5m.

Distance extrapolation factor = 20 log (specific distance [3m] / test distance [1.5m]) (dB);

Limit line = specific limits (dBuV) + distance extrapolation factor [6 dB].

## 4.8. Frequency Stability Measurement

### 4.8.1. Limit

Manufacturers of U-NII devices are responsible for ensuring frequency stability such that an emissions is maintained within the band of operation under all conditions of normal operation as specified in the user’s manual or  $\pm 20\text{ppm}$  (IEEE 802.11nspecification).

### 4.8.2. Measuring Instruments and Setting

Please refer to section 5 of equipments list in this report. The following table is the setting of the spectrum analyzer.

Spectrum Parameter	Setting
Attenuation	Auto
Span Frequency	Entire absence of modulation emissions bandwidth
RB	10 kHz
VB	10 kHz
Sweep Time	Auto

### 4.8.3. Test Procedures

1. The transmitter output (antenna port) was connected to the spectrum analyzer.
2. EUT have transmitted absence of modulation signal and fixed channelize.
3. Set the spectrum analyzer span to view the entire absence of modulation emissions bandwidth.
4. Set RBW = 10 kHz, VBW = 10 kHz with peak detector and maxhold settings.
5.  $f_c$  is declaring of channel frequency. Then the frequency error formula is  $(f_c - f) / f_c \times 10^6$  ppm and the limit is less than  $\pm 20\text{ppm}$  (IEEE 802.11nspecification).
6. The test extreme voltage is to change the primary supply voltage from 85 to 115 percent of the nominal value
7. Extreme temperature rule is  $-30^\circ\text{C} \sim 50^\circ\text{C}$ .
8. Measuring multiple antennas, the connector is required to link with spectrum analyzer through a combiner.

### 4.8.4. Test Setup Layout

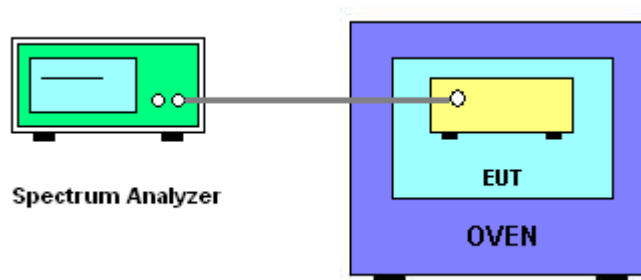



#### 4.8.5. Test Deviation

There is no deviation with the original standard.

#### 4.8.6. EUT Operation during Test

The EUT was programmed to be in continuously un-modulation transmitting mode.

#### 4.8.7. Test Result of Frequency Stability

< For Ant. 1 >

##### Voltage vs. Frequency Stability

Voltage	Measurement Frequency (MHz)
(V)	5200
126.50	5200.0343
110.00	5200.021
93.50	5200.0135
Max. Deviation (MHz)	0.034300
Max. Deviation (ppm)	6.60

##### Temperature vs. Frequency Stability

Temperature	Measurement Frequency (MHz)
(°C)	5200
-30	5200.0492
-20	5200.041
-10	5200.033
0	5200.0212
10	5200.01
20	5200.0035
30	5199.9985
40	5199.987
50	5199.986
Max. Deviation (MHz)	0.049200
Max. Deviation (ppm)	9.46

< For Ant. 2 >

**Voltage vs. Frequency Stability**

Voltage	Measurement Frequency (MHz)
(V)	5200
126.50	5199.976
110.00	5199.975
93.50	5199.975
Max. Deviation (MHz)	0.025000
Max. Deviation (ppm)	4.81

**Temperature vs. Frequency Stability**

Temperature	Measurement Frequency (MHz)
(°C)	5200
-30	5200.001
-20	5200.001
-10	5200.003
0	5200.001
10	5200.001
20	5199.975
30	5199.978
40	5199.976
50	5199.976
Max. Deviation (MHz)	0.025000
Max. Deviation (ppm)	4.81

< For Ant. 3 >

**Voltage vs. Frequency Stability**

Voltage	Measurement Frequency (MHz)
(V)	<b>5200</b>
126.50	5199.976
110.00	5199.975
93.50	5199.975
Max. Deviation (MHz)	<b>0.025000</b>
Max. Deviation (ppm)	<b>4.81</b>

**Temperature vs. Frequency Stability**

Temperature	Measurement Frequency (MHz)
(°C)	<b>5200</b>
-30	5200.001
-20	5200.001
-10	5200.003
0	5200.001
10	5200.001
20	5199.975
30	5199.978
40	5199.976
50	5199.976
Max. Deviation (MHz)	<b>0.025000</b>
Max. Deviation (ppm)	<b>4.81</b>

< For Ant. 4 >

**Voltage vs. Frequency Stability**

Voltage	Measurement Frequency (MHz)
(V)	5200
126.50	5199.976
110.00	5199.975
93.50	5199.975
Max. Deviation (MHz)	0.025000
Max. Deviation (ppm)	4.81

**Temperature vs. Frequency Stability**

Temperature	Measurement Frequency (MHz)
(°C)	5200
-30	5200.001
-20	5200.001
-10	5200.003
0	5200.001
10	5200.001
20	5199.975
30	5199.978
40	5199.976
50	5199.976
Max. Deviation (MHz)	0.025000
Max. Deviation (ppm)	4.81

< For Ant. 6 >

**Voltage vs. Frequency Stability**

Voltage	Measurement Frequency (MHz)
(V)	5200
126.50	5199.976
110.00	5199.975
93.50	5199.975
Max. Deviation (MHz)	0.025000
Max. Deviation (ppm)	4.81

**Temperature vs. Frequency Stability**

Temperature	Measurement Frequency (MHz)
(°C)	5200
-30	5200.001
-20	5200.001
-10	5200.003
0	5200.001
10	5200.001
20	5199.975
30	5199.978
40	5199.976
50	5199.976
Max. Deviation (MHz)	0.025000
Max. Deviation (ppm)	4.81

## 4.9. Antenna Requirements

### 4.9.1. Limit

Except for special regulations, the Low-power Radio-frequency Devices must not be equipped with any jacket for installing an antenna with extension cable. An intentional radiator shall be designed to ensure that no antenna other than that furnished by the responsible party shall be used with the device. The use of a permanently attached antenna or of an antenna that uses a unique coupling to the intentional radiator shall be considered sufficient to comply with the provisions of this Section. The manufacturer may design the unit so that the user can replace a broken antenna, but the use of a standard antenna jack or electrical connector is prohibited. Further, this requirement does not apply to intentional radiators that must be professionally installed.

### 4.9.2. Antenna Connector Construction

Please refer to section 3.3 in this test report; antenna connector complied with the requirements.

## 5. LIST OF MEASURING EQUIPMENTS

Instrument	Manufacturer	Model No.	Serial No.	Characteristics	Calibration Date	Remark
EMC Receiver	R&S	ESCS 30	100174	9kHz – 2.75GHz	Apr. 06, 2010	Conduction (CO04-HY)
LISN	MessTec	NNB-2/16Z	99041	9kHz – 30MHz	Mar. 23, 2010	Conduction (CO04-HY)
LISN (Support Unit)	EMCO	3810/2NM	9703-1839	9kHz – 30MHz	Apr. 29, 2010	Conduction (CO04-HY)
RF Cable-CON	UTIFLEX	3102-26886-4	CB049	9kHz – 30MHz	Apr. 20, 2010	Conduction (CO04-HY)
ISN	SCHAFFNER	ISN T400	21653	9kHz – 30MHz	Jun. 10, 2010	Conduction (CO04-HY)
EMI Filter	LINDGREN	LRE-2030	2651	< 450 Hz	N/A	Conduction (CO04-HY)
3m Semi Anechoic Chamber	SIDT FRANKONIA	SAC-3M	03CH03-HY	30 MHz - 1 GHz 3m	Jun. 07, 2009	Radiation (03CH03-HY)
Amplifier	SCHAFFNER	COA9231A	18667	9 kHz - 2 GHz	Jan. 24, 2010	Radiation (03CH03-HY)
Amplifier	Agilent	8449B	3008A02120	1 GHz - 26.5 GHz	Jul. 21, 2009	Radiation (03CH03-HY)
Amplifier	MITEQ	AMF-6F-260400	9121372	26.5 GHz - 40 GHz	Apr. 06, 2009*	Radiation (03CH03-HY)
Spectrum Analyzer	R&S	FSP40	100004	9 kHz - 40 GHz	Oct. 03, 2009	Radiation (03CH03-HY)
Loop Antenna	R&S	HFH2-Z2	860004/001	9 kHz - 30 MHz	Jul. 28, 2008*	Radiation (03CH03-HY)
Bilog Antenna	SCHAFFNER	CBL 6112D	22237	30 MHz – 1 GHz	Sep. 26, 2009	Radiation (03CH03-HY)
Horn Antenna	EMCO	3115	6741	1GHz ~ 18GHz	Apr. 28, 2009	Radiation (03CH03-HY)
Horn Antenna	EMCO	3115	6741	1GHz ~ 18GHz	Apr. 28, 2010	Radiation (03CH03-HY)
Horn Antenna	SCHWARZBECK	BBHA9170	BBHA9170154	15 GHz - 40 GHz	Jan. 11, 2010	Radiation (03CH03-HY)
RF Cable-R03m	Jye Bao	RG142	CB021	30 MHz - 1 GHz	Jan. 05, 2010	Radiation (03CH03-HY)
RF Cable-HIGH	SUHNER	SUCOFLEX 106	03CH03-HY	1 GHz - 40 GHz	Jan. 05, 2010	Radiation (03CH03-HY)
Turn Table	HD	DS 420	420/650/00	0 – 360 degree	N/A	Radiation (03CH03-HY)
Antenna Mast	HD	MA 240	240/560/00	1 m - 4 m	N/A	Radiation (03CH03-HY)
Spectrum Analyzer	R&S	FSU26.5	100015	20Hz ~ 26.5GHz	Oct. 29, 2009	Conducted (TH01-HY)
Power Meter	R&S	NRVS	100444	DC ~ 40GHz	Jul. 31, 2009	Conducted (TH01-HY)
Power Sensor	R&S	NRV-Z51	100666	DC ~ 30GHz	Aug. 05, 2009	Conducted (TH01-HY)
Power Sensor	R&S	NRV-Z32	100057	30MHz ~ 6GHz	Jul. 31, 2009	Conducted (TH01-HY)
AC Power Source	HPC	HPA-500W	HPA-9100024	AC 0 ~ 300V	Jul. 12, 2009*	Conducted (TH01-HY)
DC Power Source	G.W.	GPC-6030D	C671845	DC 1V ~ 60V	Mar. 13, 2010	Conducted (TH01-HY)

Instrument	Manufacturer	Model No.	Serial No.	Characteristics	Calibration Date	Remark
Temp. and Humidity Chamber	Giant Force	GTH-225-20-S	MAB0103-001	N/A	Aug. 06, 2009	Conducted (TH01-HY)
RF CABLE-1m	Jye Bao	RG142	CB034-1m	20MHz ~ 7GHz	Dec. 02, 2009	Conducted (TH01-HY)
RF CABLE-2m	Jye Bao	RG142	CB035-2m	20MHz ~ 1GHz	Dec. 02, 2009	Conducted (TH01-HY)
Vector Signal Generator	R&S	SMU200A	102098	100kHz ~ 6GHz	Feb. 13, 2010	Conducted (TH01-HY)
Signal Generator	R&S	SMR40	100116	10MHz ~ 40GHz	Mar. 25, 2010	Conducted (TH01-HY)
Power Sensor	Anritsu	MA2411B	0917017	300MHz~40GHz	Dec. 03, 2009	Conducted (TH01-HY)
Power Meter	Anritsu	ML2495A	0949003	300MHz~40GHz	Dec. 03, 2009	Conducted (TH01-HY)

Note: Calibration Interval of instruments listed above is one year.

For "\*" Calibration Interval of instruments listed above is two years.



## 6. TEST LOCATION

SHIJR	ADD : 6Fl., No. 106, Sec. 1, Shintai 5th Rd., Shijr City, Taipei, Taiwan 221, R.O.C. TEL : 886-2-2696-2468 FAX : 886-2-2696-2255
HWA YA	ADD : No. 52, Hwa Ya 1st Rd., Kwei-Shan Hsiang, Tao Yuan Hsien, Taiwan, R.O.C. TEL : 886-3-327-3456 FAX : 886-3-318-0055
LINKOU	ADD : No. 30-2, Dingfu Tsuen, Linkou Shiang, Taipei, Taiwan 244, R.O.C TEL : 886-2-2601-1640 FAX : 886-2-2601-1695
DUNGHU	ADD : No. 3, Lane 238, Kangle St., Neihu Chiu, Taipei, Taiwan 114, R.O.C. TEL : 886-2-2631-4739 FAX : 886-2-2631-9740
JUNGHE	ADD : 7Fl., No. 758, Jungjeng Rd., Junghe City, Taipei, Taiwan 235, R.O.C. TEL : 886-2-8227-2020 FAX : 886-2-8227-2626
NEIHU	ADD : 4Fl., No. 339, Hsin Hu 2 <sup>nd</sup> Rd., Taipei 114, Taiwan, R.O.C. TEL : 886-2-2794-8886 FAX : 886-2-2794-9777
JHUBEI	ADD : No.8, Lane 724, Bo-ai St., Jhubei City, HsinChu County 302, Taiwan, R.O.C. TEL : 886-3-656-9065 FAX : 886-3-656-9085

## 7. TAF CERTIFICATE OF ACCREDITATION



Certificate No. : L1190-091230

財團法人全國認證基金會  
Taiwan Accreditation Foundation

### Certificate of Accreditation

This is to certify that

**Sporton International Inc.**  
**EMC & Wireless Communications Laboratory**  
No.52, Hwa Ya 1st Rd., Hwa Ya Technology Park, Kwei-Shan Hsiang, Tao Yuan Hsien,  
Taiwan, R.O.C.

**is accredited in respect of laboratory**

<b>Accreditation Criteria</b>	: ISO/IEC 17025:2005
<b>Accreditation Number</b>	: 1190
<b>Originally Accredited</b>	: December 15, 2003
<b>Effective Period</b>	: January 10, 2010 to January 09, 2013
<b>Accredited Scope</b>	: Testing Field, see described in the Appendix
<b>Specific Accreditation Program</b>	: Accreditation Program for Designated Testing Laboratory for Commodities Inspection Accreditation Program for Telecommunication Equipment Testing Laboratory Accreditation Program for BSMI Mutual Recognition Arrangement with Foreign Authorities

*Jay-san Chen*

Jay-San Chen  
President, Taiwan Accreditation Foundation  
Date : December 30, 2009

Pl, total 22 pages

The Appendix forms an integral part of this Certificate, which shall be invalid when use without the Appendix