



Excellence in Compliance Testing

Certification Test Report

**FCC ID: QZC-REXUANZ
IC: 4557A-REXUANZ**

**FCC Rule Part: 15.247
IC Radio Standards Specification: RSS-247**

ACS Report Number: 15-0286.W06.1B

**Manufacturer: Elster Solutions, LLC
Model: REXUA-NZ**

**Test Begin Date: July 24, 2015
Test End Date: July 29, 2015**

Report Issue Date: September 2, 2015



FOR THE SCOPE OF ACCREDITATION UNDER LAB Code 200612-0

This report is not be used to claim certification, approval, or endorsement by NVLAP, NIST or any government agency.

Reviewed by:

**Kirby Munroe
Director, Wireless Certifications
ACS, Inc.**

This test report shall not be reproduced except in full. This report may be reproduced in part with prior written consent of ACS, Inc. The results contained in this report are representative of the sample(s) submitted for evaluation.

This report contains 36 pages

TABLE OF CONTENTS

1	GENERAL	3
1.1	PURPOSE.....	3
1.2	PRODUCT DESCRIPTION	3
1.3	TEST METHODOLOGY AND CONSIDERATIONS	4
2	TEST FACILITIES.....	5
2.1	LOCATION	5
2.2	LABORATORY ACCREDITATIONS/RECOGNITIONS/CERTIFICATIONS	5
2.3	RADIATED EMISSIONS TEST SITE DESCRIPTION	6
2.3.1	<i>Semi-Anechoic Chamber Test Site</i>	6
2.3.2	<i>Open Area Tests Site (OATS)</i>	7
2.4	CONDUCTED EMISSIONS TEST SITE DESCRIPTION	8
3	APPLICABLE STANDARD REFERENCES.....	8
4	LIST OF TEST EQUIPMENT.....	9
5	SUPPORT EQUIPMENT.....	10
6	EQUIPMENT UNDER TEST SETUP BLOCK DIAGRAM.....	10
7	SUMMARY OF TESTS.....	11
7.1	ANTENNA REQUIREMENT – FCC: SECTION 15.203	11
7.2	POWER LINE CONDUCTED EMISSIONS – FCC 15.207, IC: RSS-GEN 8.8	11
7.2.1	<i>Measurement Procedure</i>	11
7.2.2	<i>Measurement Results</i>	11
7.3	PEAK OUTPUT POWER - FCC 15.247(B)(2) IC: RSS-247 5.4(1)	12
7.3.1	<i>Measurement Procedure (Conducted Method)</i>	12
7.3.2	<i>Measurement Results</i>	12
7.4	CHANNEL USAGE REQUIREMENTS	16
7.4.1	<i>Carrier Frequency Separation – FCC 15.247(a)(1) IC: RSS-247 5.1(2)</i>	16
7.4.1.1	Measurement Procedure.....	16
7.4.1.2	Measurement Results	16
7.4.2	<i>Number of Hopping Channels – FCC 15.247(a)(1)(i) IC: RSS-247 5.1(3)</i>	18
7.4.2.1	Measurement Procedure.....	18
7.4.2.2	Measurement Results	18
7.4.3	<i>Channel Dwell Time – FCC 15.247(a)(1)(i) IC: RSS-247 5.1(3)</i>	20
7.4.3.1	Measurement Procedure.....	20
7.4.3.2	Measurement Results	20
7.4.4	<i>20dB / 99% Bandwidth - FCC 15.247(a)(1)(i) IC: RSS-247 5.1(3)</i>	21
7.4.4.1	Measurement Procedure.....	21
7.4.4.2	Measurement Results	21
7.5	BAND-EDGE COMPLIANCE AND SPURIOUS EMISSIONS.....	27
7.5.1	<i>Band-Edge Compliance of RF Conducted Emissions - FCC 15.247(d); IC RSS-247 5.5</i>	27
7.5.1.1	Measurement Procedure.....	27
7.5.1.2	Measurement Results	27
7.5.2	<i>RF Conducted Spurious Emissions - FCC 15.247(d); IC RSS-247 5.5</i>	31
7.5.2.1	Measurement Procedure.....	31
7.5.2.2	Measurement Results	31
7.5.3	<i>Radiated Spurious Emissions - FCC 15.205, 15.209; RSS-Gen 8.9/8.10</i>	34
7.5.3.1	Measurement Procedure.....	34
7.5.3.2	Measurement Results	34
7.5.3.3	Sample Calculation:	35
8	CONCLUSION.....	36

1 GENERAL

1.1 Purpose

The purpose of this report is to demonstrate compliance with Part 15 Subpart C of the FCC's Code of Federal Regulations and Industry Canada's Radio Standards Specification RSS-247 Certification for modular approval.

1.2 Product description

The REXUA-NZ module contains (1) 900MHz frequency hopping spread spectrum radio. The REXUA-NZ forms a complete electricity meter when installed in a housing and meter base. The REXUA-NZ module utilizes two distinct modes of operation; Energy Axis (EA) networking architecture devised by Elster Electricity LLC at low power, and Smart Metering Utility Network (SUN) networking architecture at high power.

Technical Details:

Mode of Operation	Frequency Range (MHz)	Number of Channels	Data Rates Supported (kbps)
1	902.4 - 927.6	25	35.5, 142.2
2	902.4 - 927.6	64	50, 150, 200

Modulation Format: FSK/GFSK
 Antenna Type / Gain: Inverted F / 4.1 dBi
 Operating Voltage: 18Vdc

Manufacturer Information:
 Elster Solutions, LLC
 208 South Rogers Lane
 Raleigh, NC 27610

EUT Serial Numbers: 5D26119G2201 0 1152400188(Radiated), 5D26119G1403 1 1152400182 (RF Conducted)

Test Sample Condition: The test samples were provided in good working order with no visible defects.

1.3 Test Methodology and Considerations

All modes of operation, including all available data rates, were evaluated for each mode. The data presented in this report represents the worst case where applicable.

For radiated emissions the EUT was evaluated in three orthogonal orientations. The worst case orientation was the Y-orientation.

For AC power line conducted emissions the EUT was evaluated with a typical host in the high power mode.

The EUT utilizes 25 hopping channels in operating mode 1 in the range from 902.4 MHz to 927.6 MHz using multiple hopping tables. Data was collected using multiple hopping tables to show compliance for all possible operating conditions (i.e. hopping band-edge at extreme operating band-edges).

Software power settings during test for mode 1: 44 (Low Channel), 38 (Mid Channel), 34 (High Channel)

Software power setting during test for mode 2: 62 (Low Channel), 59 (Mid Channel), 56 (High Channel)

2 TEST FACILITIES

2.1 Location

The radiated and conducted emissions test sites are located at the following address:

Advanced Compliance Solutions
5015 B.U. Bowman Drive
Buford, GA 30518
Phone: (770) 831-8048
Fax: (770) 831-8598

2.2 Laboratory Accreditations/Recognitions/Certifications

ACS is accredited to ISO/IEC 17025 by the National Institute of Standards and Technology under their National Voluntary Laboratory Accreditation Program (NVLAP), Lab Code 200612-0. Unless otherwise specified, all tests methods described within this report are covered under the ISO/IEC 17025 scope of accreditation.

The Semi-Anechoic Chamber Test Site, Open Area Test Site (OATS) and Conducted Emissions Site have been fully described, submitted to, and accepted by the FCC, Industry Canada and the Japanese Voluntary Control Council for Interference by information technology equipment.

FCC Registration Number: 511277

Industry Canada Lab Code: IC 4175A

VCCI Member Number: 1831

- VCCI OATS Registration Number R-1526
- VCCI Conducted Emissions Site Registration Number: C-1608

2.3 Radiated Emissions Test Site Description

2.3.1 Semi-Anechoic Chamber Test Site

The Semi-Anechoic Chamber Test Site consists of a 20' x 30' x 18' shielded enclosure. The chamber is lined with Toyo Ferrite Grid Absorber, model number FFG-1000. The ferrite tile grid is 101 x 101 x 19mm thick and weighs approximately 550 grams. These tiles are mounted on steel panels and installed directly on the inner walls of the chamber.

The turntable is 150cm in diameter and is located 160cm from the back wall of the chamber. The chamber is grounded via 1 – 8' copper ground rod, installed at the center of the back wall, it is bound to the ground plane using 3/4" stainless steel braided cable.

The turntable is all steel, flush mounted table installed in an all steel frame. The table is remotely operated from inside the control room located 25' from the range. The turntable is electrically bonded to the surrounding ground plane via steel fingers installed on the edge of the turn table. The steel fingers make constant contact with the ground plane during operation.

Behind the turntable is a 3' x 6' x 4' deep shielded pit used for support equipment if necessary. The pit is equipped with 1 – 4" PVC chases from the turntable to the pit that allow for cabling to the EUT if necessary. The underside of the turntable can be accessed from the pit so cables can be supplied to the EUT from the pit.

A diagram of the Semi-Anechoic Chamber Test Site is shown in Figure 2.3-1 below:

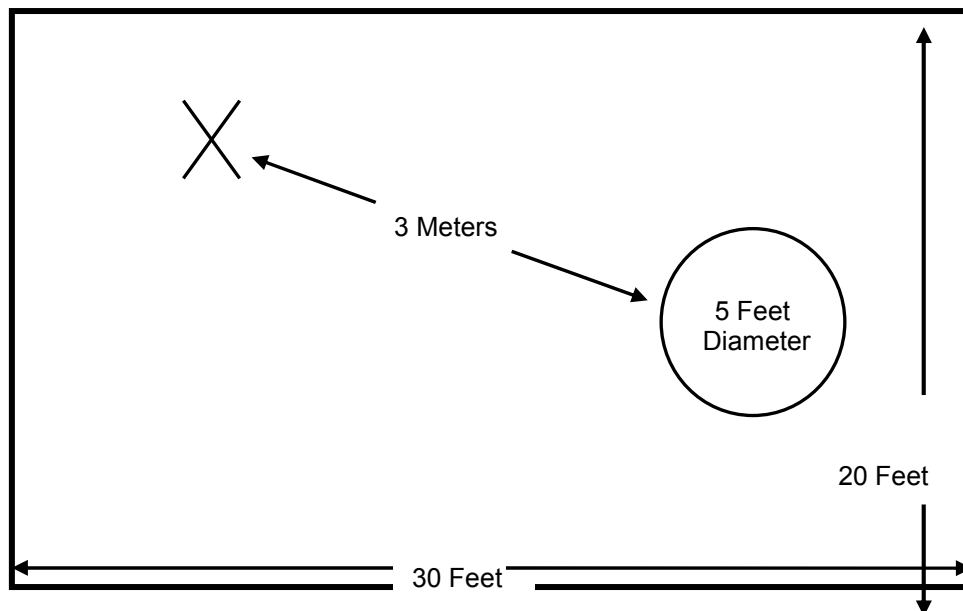

Figure 2.3-1: Semi-Anechoic Chamber Test Site

2.3.2 Open Area Tests Site (OATS)

The open area test site consists of a 40' x 66' concrete pad covered with a perforated electro-plated galvanized sheet metal. The perforations in the sheet metal are 1/8" holes that are staggered every 3/16". The individual sheets are placed to overlap each other by 1/4" and are riveted together to provide a continuous seam. Rivets are spaced every 3" in a 3 x 20 meter perimeter around the antenna mast and EUT area. Rivets in the remaining area are spaced as necessary to properly secure the ground plane and maintain the electrical continuity.

The entire ground plane extends 12' beyond the turntable edge and 16' beyond the antenna mast when set to a 10 meter measurement distance. The ground plane is grounded via 4 – 8' copper ground rods, each installed at a corner of the ground plane and bound to the ground plane using 3/4" stainless steel braided cable.

The turntable is an all aluminum 10' flush mounted table installed in an all aluminum frame. The table is remotely operated from inside the control room located 40' from the range. The turntable is electrically bonded to the surrounding ground plane via steel fingers installed on the edge of the turn table. The steel fingers make constant contact with the ground plane during operation.

Adjacent to the turntable is a 7' x 7' square and 4' deep concrete pit used for support equipment if necessary. The pit is equipped with 5 – 4" PVC chases from the pit to the control room that allow for cabling to the EUT if necessary. The underside of the turntable can be accessed from the pit so cables can be supplied to the EUT from the pit. The pit is covered with 2 sheets of 1/4" diamond style re-enforced steel sheets. The sheets are painted to match the perforated steel ground plane; however the underside edges have been masked off to maintain the electrical continuity of the ground plane. All reflecting objects are located outside of the ellipse defined in ANSI C63.4.

A diagram of the Open Area Test Site is shown in Figure 2.3-2 below:

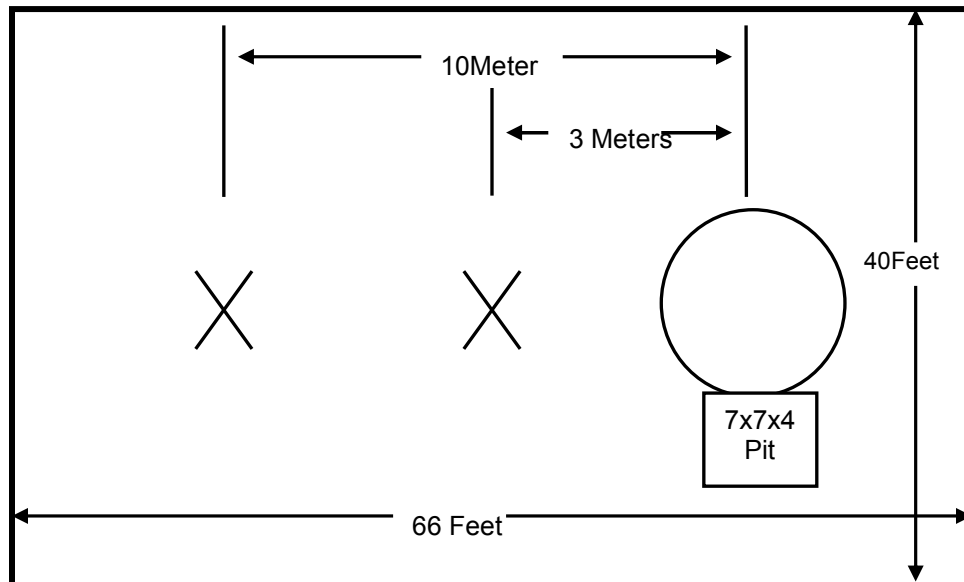

Figure 2.3-2: Open Area Test Site

2.4 Conducted Emissions Test Site Description

The AC mains conducted EMI site is located in the main EMC lab. It consists of an 8' x 8' solid aluminum horizontal ground reference plane (GRP) bonded every 3" to an 8' X 8' vertical ground plane.

The site is of sufficient size to test table top and floor standing equipment in accordance with section 6.1.4 of ANSI C63.4.

A diagram of the room is shown below in figure 2.4-1:

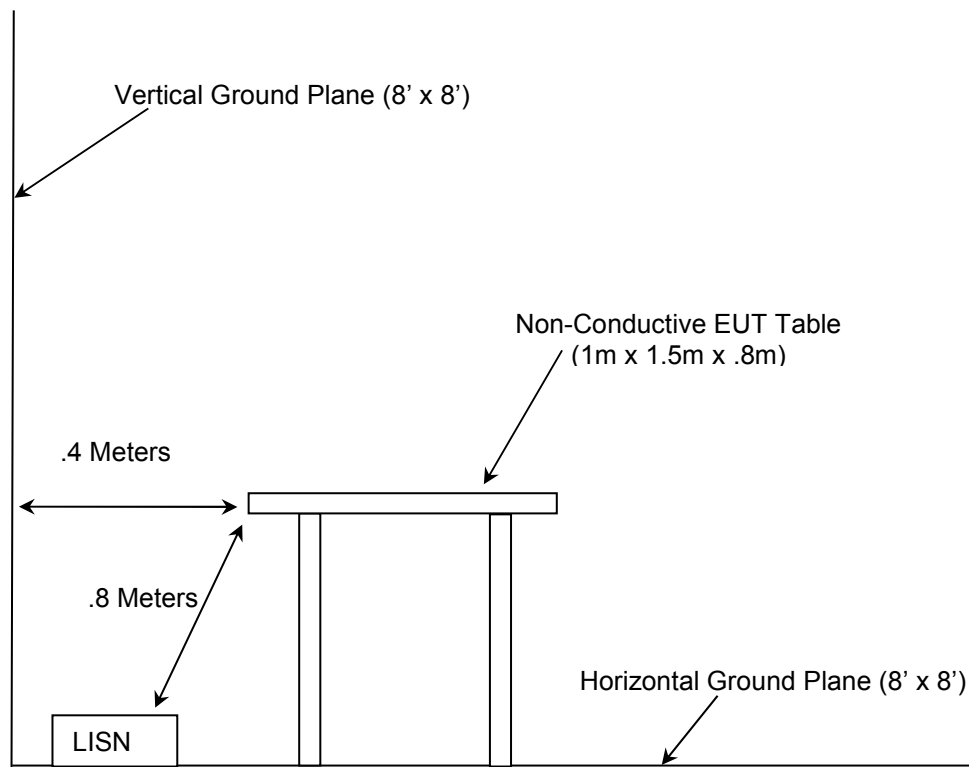

Figure 2.4-1: AC Mains Conducted EMI Site

3 APPLICABLE STANDARD REFERENCES

The following standards were used:

- ❖ ANSI C63.10-2013: American National Standard of Procedures for Compliance Testing of Unlicensed Wireless Devices
- ❖ US Code of Federal Regulations (CFR): Title 47, Part 2, Subpart J: Equipment Authorization Procedures, 2015
- ❖ US Code of Federal Regulations (CFR): Title 47, Part 15, Subpart C: Radio Frequency Devices, Intentional Radiators, 2015
- ❖ Industry Canada Radio Standards Specification: RSS-247 – Digital Transmission Systems (DTSS), Frequency Hopping Systems (FHSs) and Licence-Exempt Local Area Network (LE-LAN) Devices, Issue 1, May 2015.
- ❖ Industry Canada Radio Standards Specification: RSS-GEN – General Requirements and Information for the Certification of Radiocommunication Equipment, Issue 4, Nov 2014.

4 LIST OF TEST EQUIPMENT

The calibration interval of test equipment is annually or the manufacturer's recommendations. Where the calibration interval deviates from the annual cycle based on the instrument manufacturer's recommendations, it shall be stated below.

Table 4-1: Test Equipment

AssetID	Manufacturer	Model #	Equipment Type	Serial #	Last Calibration Date	Calibration Due Date
1	Rohde & Schwarz	ESMI - Display	Spectrum Analyzers	833771/007	7/14/2015	7/14/2016
2	Rohde & Schwarz	ESMI-Receiver	Spectrum Analyzers	839587/003	7/14/2015	7/14/2016
30	Spectrum Technologies	DRH-0118	Antennas	970102	4/30/2015	4/30/2017
40	EMCO	3104	Antennas	3211	2/10/2015	2/10/2017
73	Agilent	8447D	Amplifiers	2727A05624	7/15/2015	7/15/2016
167	ACS	Chamber EMI Cable Set	Cable Set	167	10/28/2014	10/28/2015
168	Hewlett Packard	11947A	Attenuators	44829	1/19/2015	1/19/2016
292	Florida RF Cables	SMR-290AW- 480.0-SMR	Cables	None	3/3/2015	3/3/2016
316	Rohde Schwarz	ESH3-Z5	LISN	861189-010	7/14/2015	7/14/2016
324	ACS	Belden	Cables	8214	5/5/2015	5/5/2016
337	Microwave Circuits	H1G513G1	Filters	282706	5/20/2015	5/20/2016
338	Hewlett Packard	8449B	Amplifiers	3008A01111	7/30/2013	8/30/2015
340	Aeroflex/Weinschel	AS-20	Attenuators	7136	7/13/2015	7/13/2016
412	Electro Metrics	LPA-25	Antennas	1241	7/24/2014	7/24/2016
422	Florida RF	SMS-200AW-72.0- SMR	Cables	805	11/5/2014	11/5/2015
616	Florida RF Cables	SMRE-200W-12.0- SMRE	Cables	N/A	9/10/2014	9/10/2015
622	Rohde & Schwarz	FSV40	Analyzers	101338	7/15/2015	7/15/2016
RE112	Rohde & Schwarz	ESIB26	Receiver	836119/012	7/16/2015	7/16/2016

5 SUPPORT EQUIPMENT

Table 5-1: Support Equipment

Item	Equipment Type	Manufacturer	Model Number	Serial Number
1	Signal/Power Adaptor PCB	Elster Solutions, LLC	N/A	N/A
2	AC Adaptor	CUI Inc.	EMSA180100	N/A
3	DC Power Supply	Hewlett Packard	E3630A	KR64308603
4	Electric Utility Meter	Elster Electricity, LLC.	FM2S	18 935 643

6 EQUIPMENT UNDER TEST SETUP BLOCK DIAGRAM

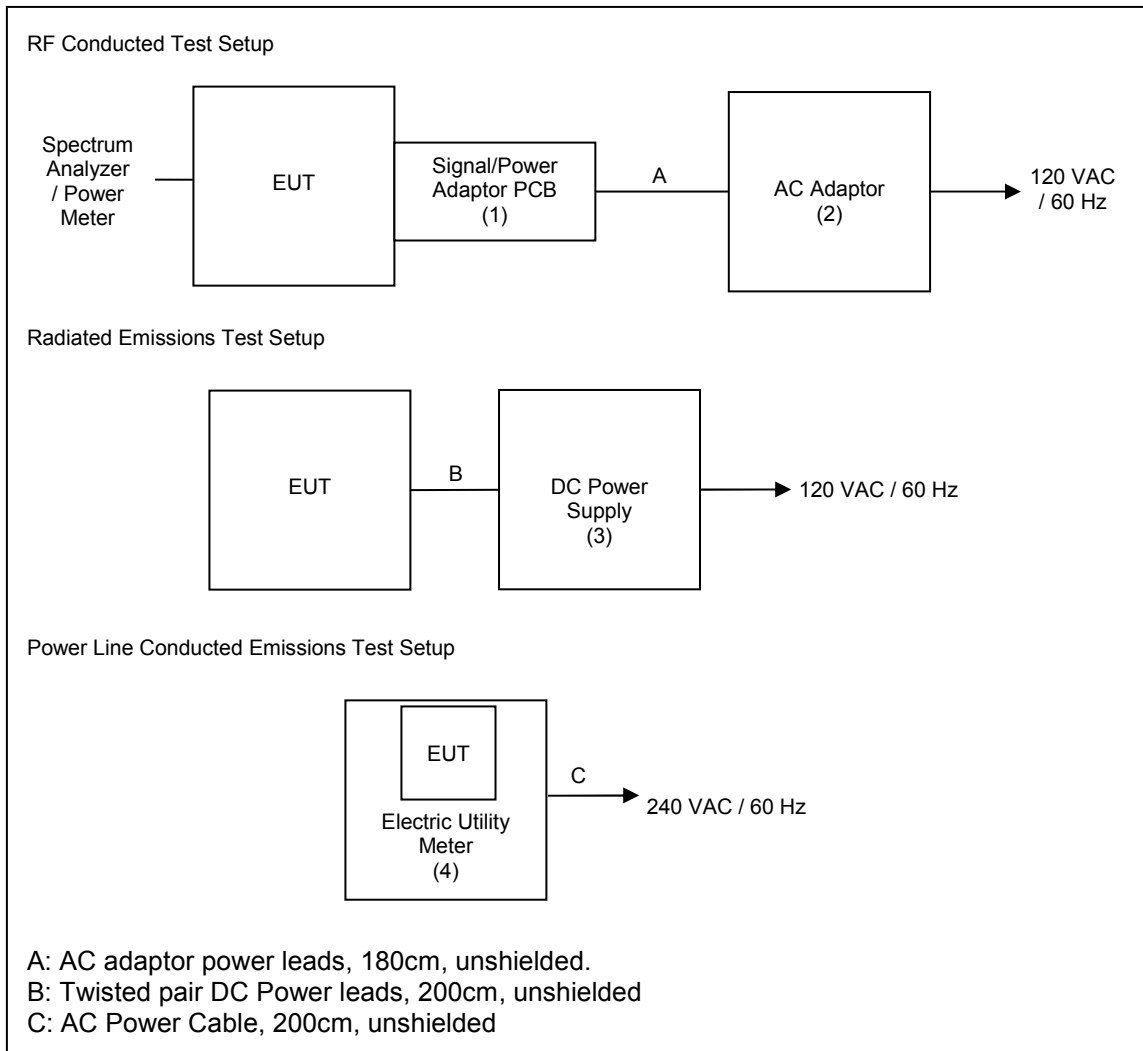

Figure 6-1: Test Setup Block Diagram

7 SUMMARY OF TESTS

Along with the tabular data shown below, plots were taken of all signals deemed important enough to document.

7.1 Antenna Requirement – FCC: Section 15.203

The EUT utilizes a printed Inverted F antenna therefore satisfying the requirements of Section 15.203.

7.2 Power Line Conducted Emissions – FCC 15.207, IC: RSS-Gen 8.8

7.2.1 Measurement Procedure

ANSI C63.4 sections 6 and 7 were the guiding documents for this evaluation. Conducted emissions were performed from 150kHz to 30MHz with the spectrum analyzer's resolution bandwidth set to 9kHz and the video bandwidth set to 30kHz. The calculation for the conducted emissions is as follows:

Corrected Reading = Analyzer Reading + LISN Loss + Cable Loss

Margin = Applicable Limit - Corrected Reading

7.2.2 Measurement Results

Table 7.2.2-1: Conducted EMI Results Line 1

Frequency (MHz)	QuasiPeak (dBµV)	Average (dBµV)	Limit (dBµV)	Margin (dB)	Line	Corr. (dB)
0.160421	---	33.28	55.39	22.11	L1	10.1
0.160421	48.13	---	65.40	17.27	L1	10.1
0.166762	---	32.19	55.04	22.85	L1	10.1
0.166762	47.06	---	65.05	17.99	L1	10.1
0.257215	---	26.90	51.28	24.38	L1	10.1
0.257215	42.66	---	61.32	18.66	L1	10.1
0.272144	---	25.58	50.81	25.23	L1	10.1
0.272144	40.84	---	60.85	20.01	L1	10.1
0.689980	---	22.26	46.00	23.74	L1	10.1
0.689980	33.07	---	56.00	22.93	L1	10.1
0.717735	---	23.18	46.00	22.82	L1	10.1
0.717735	32.45	---	56.00	23.55	L1	10.1

Table 7.2.2-2: Conducted EMI Results Line 2

Frequency (MHz)	QuasiPeak (dBµV)	Average (dBµV)	Limit (dBµV)	Margin (dB)	Line	Corr. (dB)
0.269238	---	26.01	50.90	24.89	N	10.1
0.269238	41.51	---	60.94	19.43	N	10.1
0.277455	---	24.75	50.65	25.90	N	10.1
0.277455	39.74	---	60.69	20.95	N	10.1
0.278958	---	24.71	50.60	25.89	N	10.1
0.278958	39.74	---	60.64	20.90	N	10.1
0.322646	---	24.19	49.41	25.22	N	10.1
0.322646	38.05	---	59.45	21.40	N	10.1
0.699198	---	23.26	46.00	22.74	N	10.1
0.699198	33.16	---	56.00	22.84	N	10.1
0.710521	---	23.51	46.00	22.49	N	10.1
0.710521	32.86	---	56.00	23.14	N	10.1

7.3 Peak Output Power - FCC 15.247(b)(2) IC: RSS-247 5.4(1)

7.3.1 Measurement Procedure (Conducted Method)

The RF output port of the EUT was directly connected to the input of a spectrum analyzer using suitable attenuation. The device employs < 50 channels at any given time in Mode 1 therefore the power is limited to 0.25 Watt. The device employs > 50 channels at any given time in Mode 2 therefore the power is limited to 1 Watt.

7.3.2 Measurement Results

Table 7.3.2-1: Maximum Conducted Peak Output Power

Frequency [MHz]	Level [dBm]	Data Rate [kbps]
902.4	23.69	35.5
902.4	23.71	142.2
902.4	29.30	50
902.4	29.30	150
902.4	29.29	200
916.0	23.67	35.5
916.0	23.70	142.2
916.0	29.29	50
916.0	29.30	150
916.0	29.29	200
927.6	23.67	35.5
927.6	23.72	142.2
927.6	29.29	50
927.6	29.29	150
927.6	29.29	200

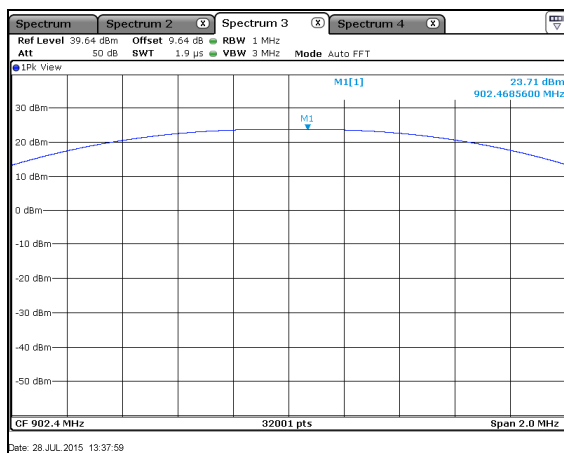
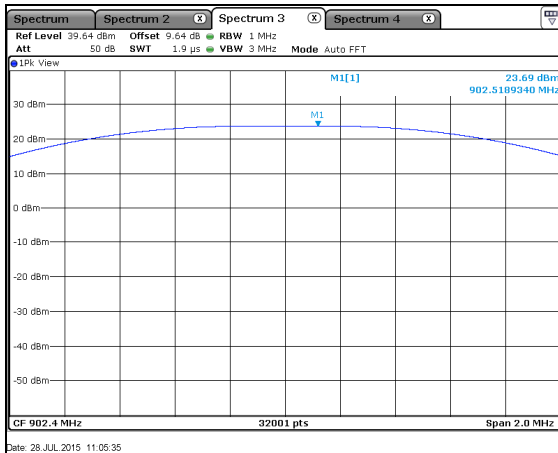

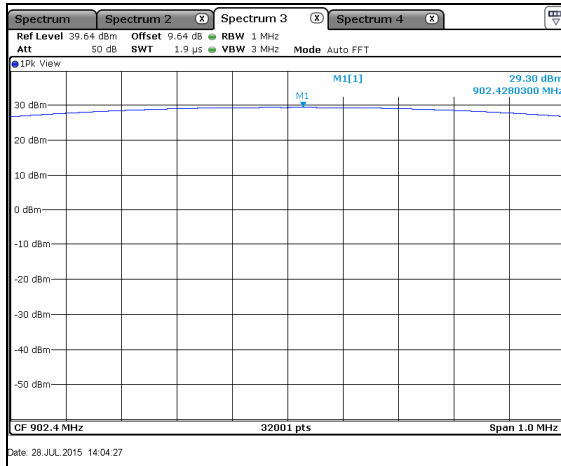

Figure 7.3.2-3: Peak Output Power – LCH – 50kbps

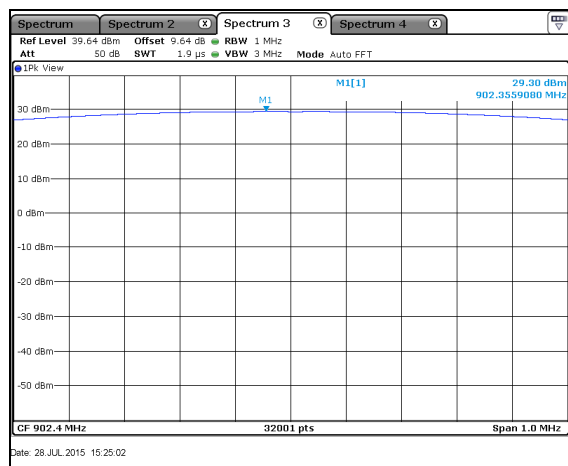

Figure 7.3.2-4: Peak Output Power – LCH – 150kbps

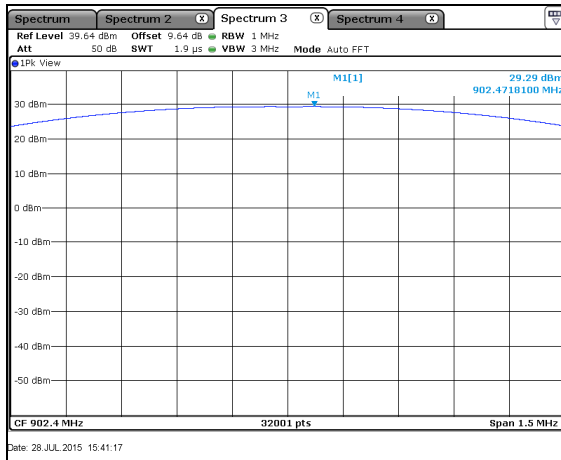

Figure 7.3.2-5: Peak Output Power – LCH – 200kbps

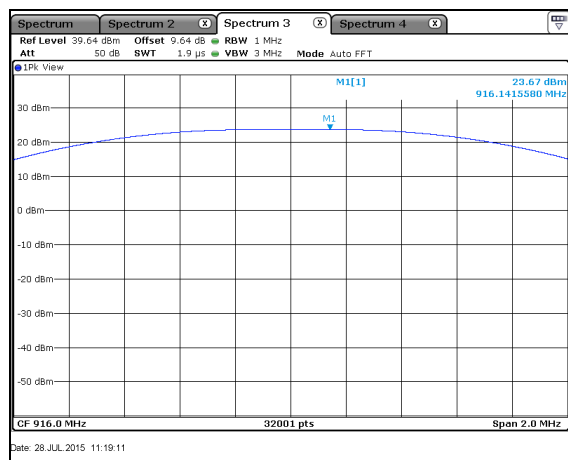

Figure 7.3.2-6: Peak Output Power – MCH – 35.5kbps

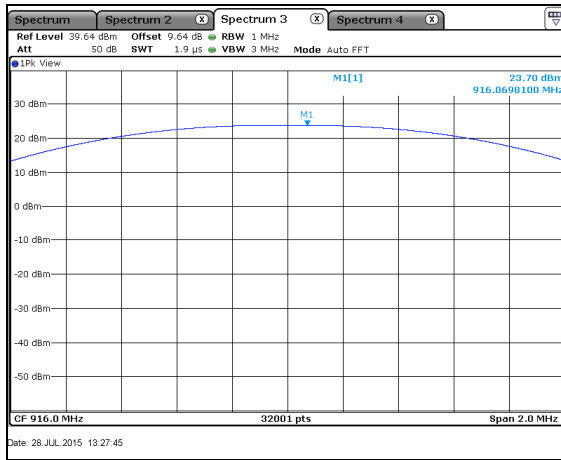

Figure 7.3.2-7: Peak Output Power – MCH – 142.2kbps

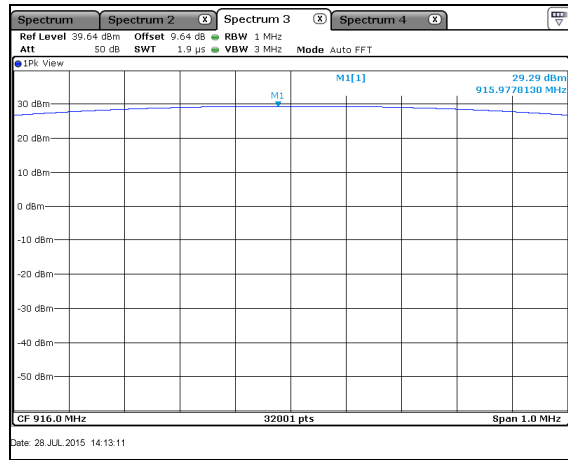

Figure 7.3.2-8: Peak Output Power – MCH – 50kbps

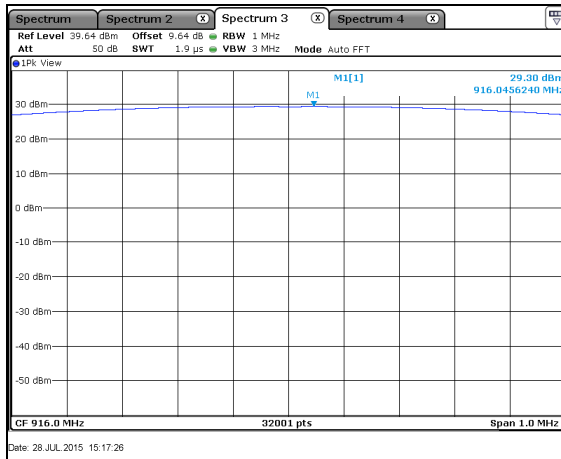

Figure 7.3.2-9: Peak Output Power – MCH – 150kbps

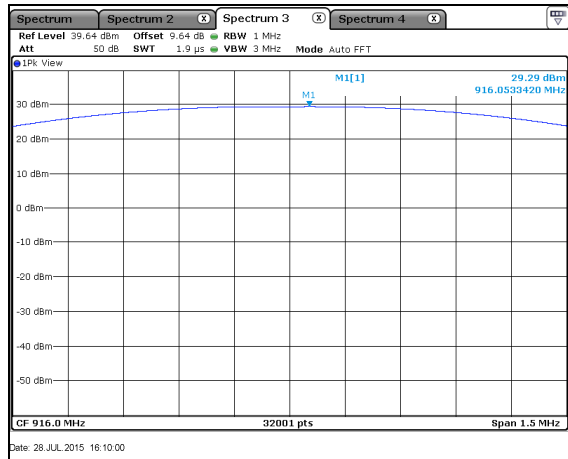

Figure 7.3.2-10: Peak Output Power – MCH – 200kbps

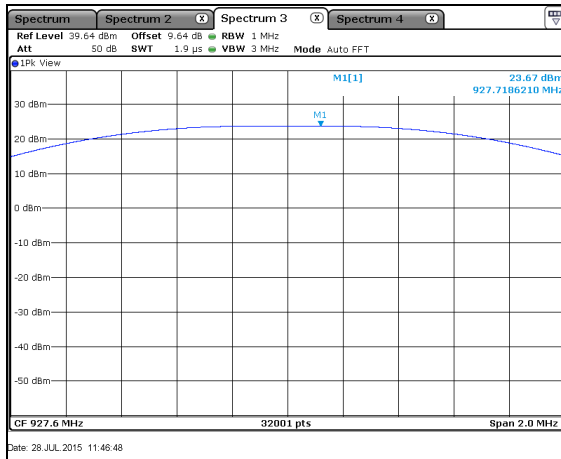

Figure 7.3.2-11: Peak Output Power – HCH – 35.5kbps

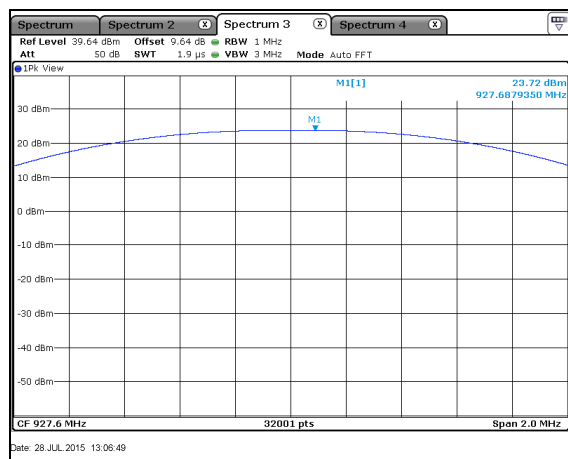

Figure 7.3.2-12: Peak Output Power – HCH – 142.2kbps

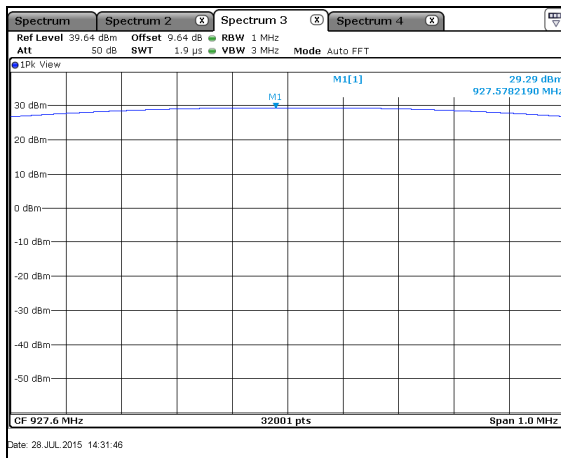

Figure 7.3.2-13: Peak Output Power – HCH – 50kbps

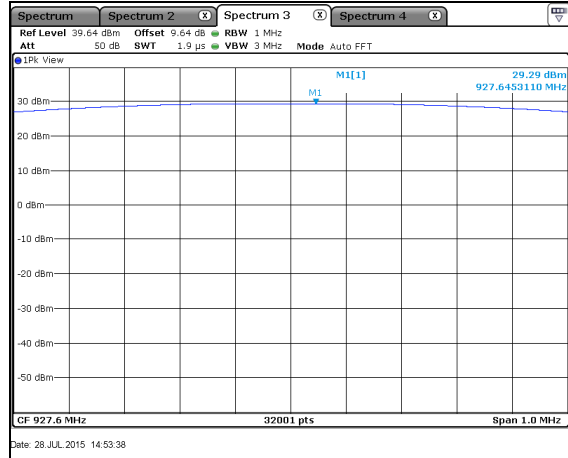

Figure 7.3.2-14: Peak Output Power – HCH – 150kbps

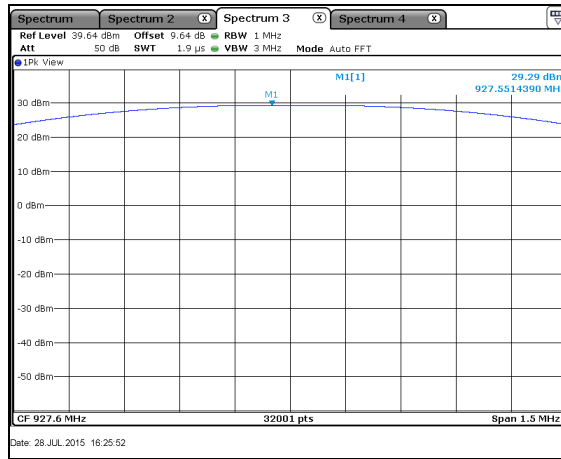

Figure 7.3.2-15: Peak Output Power – HCH – 200kbps

7.4 Channel Usage Requirements

7.4.1 Carrier Frequency Separation – FCC 15.247(a)(1) IC: RSS-247 5.1(2)

7.4.1.1 Measurement Procedure

The RF output port of the EUT was directly connected to the input of the spectrum analyzer using suitable attenuation. The span of the spectrum analyzer was set wide enough to capture two adjacent peaks. The RBW was set to approximately 30% of the channel spacing and adjusted as necessary to best identify the center of each channel. The VBW was set > RBW.

7.4.1.2 Measurement Results

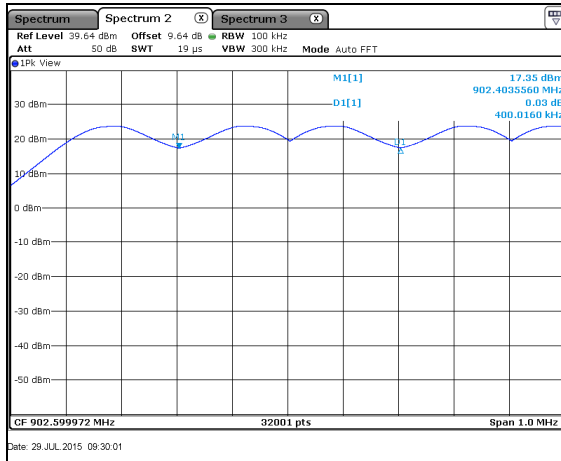

Figure 7.4.1.2-1: Frequency Separation – 35.5kbps

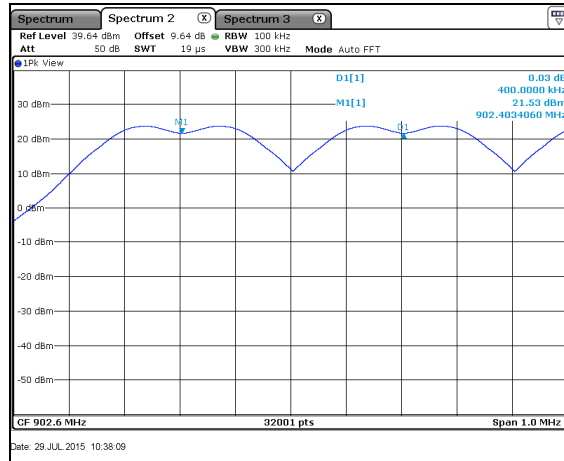

Figure 7.4.1.2-2: Frequency Separation – 142.2kbps

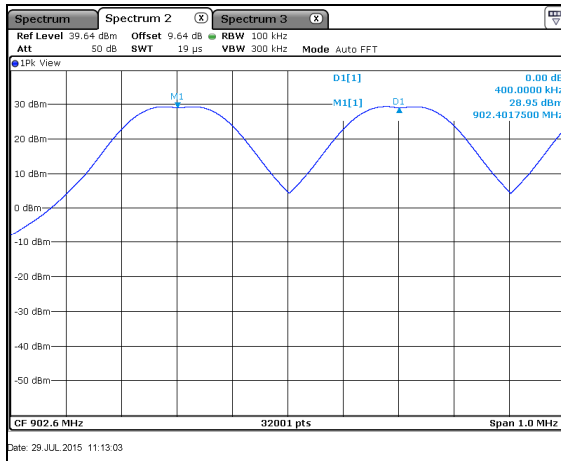

Figure 7.4.1.2-3: Frequency Separation – 50kbps

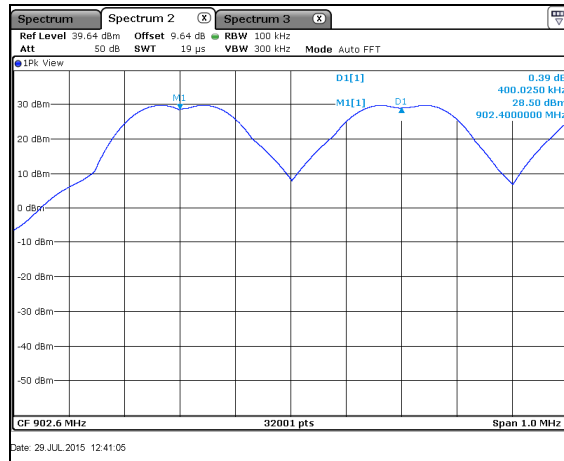

Figure 7.4.1.2-4: Frequency Separation – 150kbps

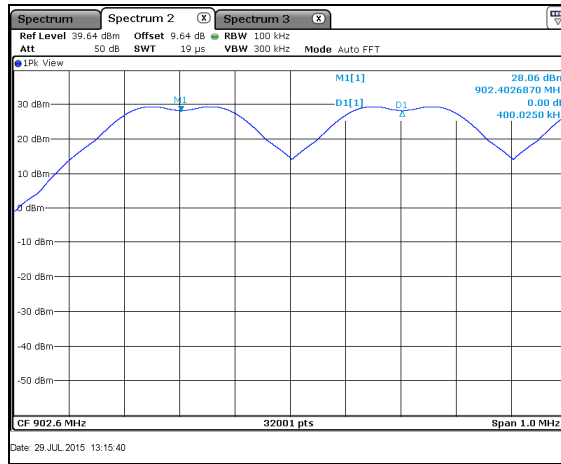

Figure 7.4.1.2-5: Frequency Separation – 200kbps

7.4.2 Number of Hopping Channels – FCC 15.247(a)(1)(i) IC: RSS-247 5.1(3)

7.4.2.1 Measurement Procedure

The RF output port of the EUT was directly connected to the input of the spectrum analyzer using suitable attenuation. The span of the spectrum analyzer was set wide enough to capture the frequency band of operation. The RBW was set to < 30% of the channel spacing and VBW set to ≥ RBW.

7.4.2.2 Measurement Results

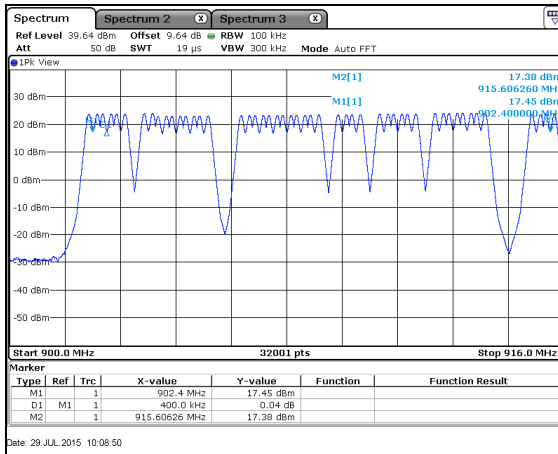

Figure 7.4.2.2-1: No. of Hopping Channels – 35.5kbps

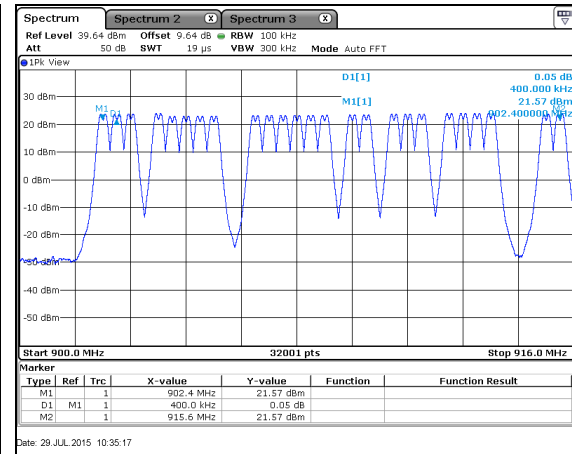

Figure 7.4.2.2-2: No. of Hopping Channels – 142.2kbps

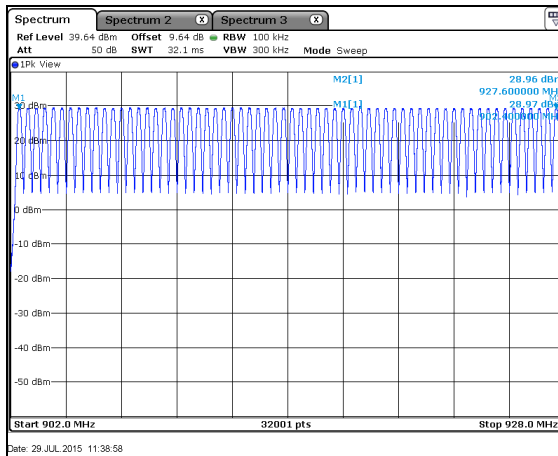

Figure 7.4.2.2-3: No. of Hopping Channels – 50kbps

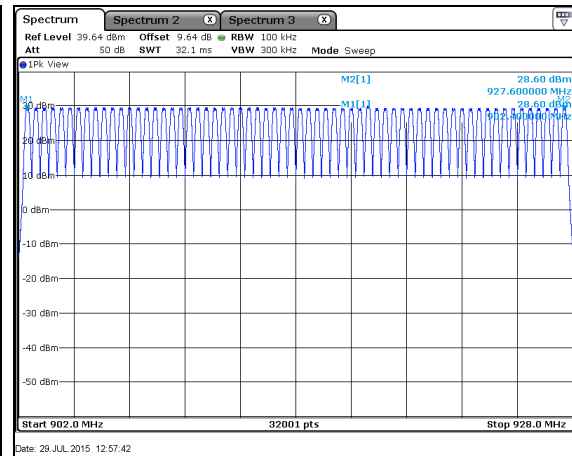

Figure 7.4.2.2-4: No. of Hopping Channels – 150kbps

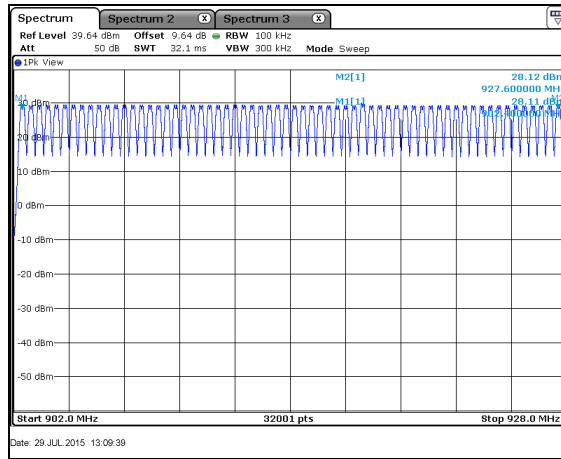

Figure 7.4.2.2-5: No. of Hopping Channels – 200kbps

7.4.3 Channel Dwell Time – FCC 15.247(a)(1)(i) IC: RSS-247 5.1(3)

7.4.3.1 Measurement Procedure

The RF output port of the EUT was directly connected to the input of the spectrum analyzer using suitable attenuation. The span of the spectrum analyzer display was set 0 Hz centered on a hopping channel. The RBW of the spectrum analyzer was set to \leq the EUT channel spacing and VBW set to \geq RBW. The Marker Delta function of the analyzer was utilized to determine the dwell time.

7.4.3.2 Measurement Results

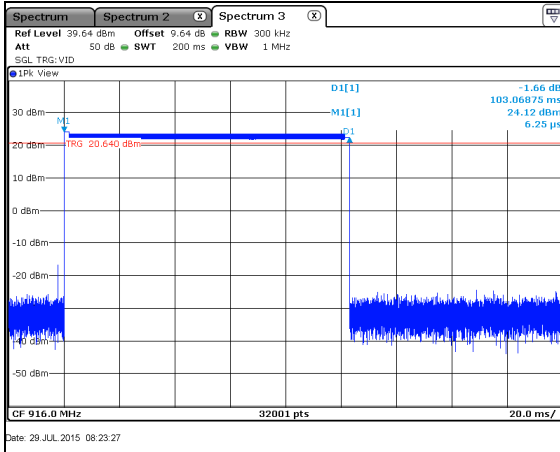

Figure 7.4.3.2-1: Dwell Time – Mode 1

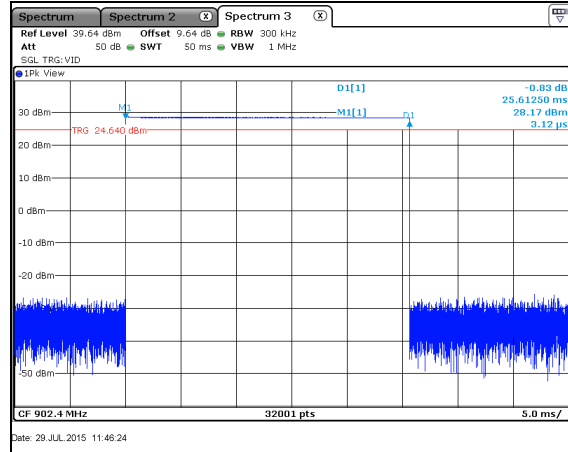

Figure 7.4.3.2-2: Dwell Time – Mode 2

*The EUT test mode does not generate a worst case channel dwell time therefore a detailed engineering analysis is provided in the theory of operation.

7.4.4 20dB / 99% Bandwidth - FCC 15.247(a)(1)(i) IC: RSS-247 5.1(3)

7.4.4.1 Measurement Procedure

The RF output port of the EUT was directly connected to the input of the spectrum analyzer using suitable attenuation. The span of the spectrum analyzer display was set between two times and five times the occupied bandwidth (OBW) of the emission. The RBW of the spectrum analyzer was set to approximately 1 % to 5 % of the OBW. The trace was set to max hold with a peak detector active. The marker delta measurement function of the analyzer was utilized to determine the 20 dB bandwidth of the emission.

The occupied bandwidth measurement function of the spectrum analyzer was used to measure the 99% bandwidth. The span of the analyzer was set to capture all products of the modulation process, including the emission sidebands. The resolution bandwidth was set to 1% to 5% of the occupied bandwidth. The video bandwidth was set to 3 times the resolution bandwidth. A peak detector was used.

7.4.4.2 Measurement Results

Table 7.4.4.2-1: 20dB / 99% Bandwidth

Frequency [MHz]	20dB Bandwidth [kHz]	99% Bandwidth [kHz]	Data Rate [kbps]
902.4	355.77	371.61	35.5
902.4	333.12	318.24	142.2
902.4	116.35	117.22	50
902.4	189.90	194.62	150
902.4	260.49	253.90	200
916.0	319.68	371.30	35.5
916.0	332.93	318.30	142.2
916.0	116.14	117.07	50
916.0	189.92	194.06	150
916.0	260.52	253.65	200
927.6	319.37	370.77	35.5
927.6	332.87	317.90	142.2
927.6	116.00	116.93	50
927.6	189.84	193.57	150
927.6	260.34	253.59	200

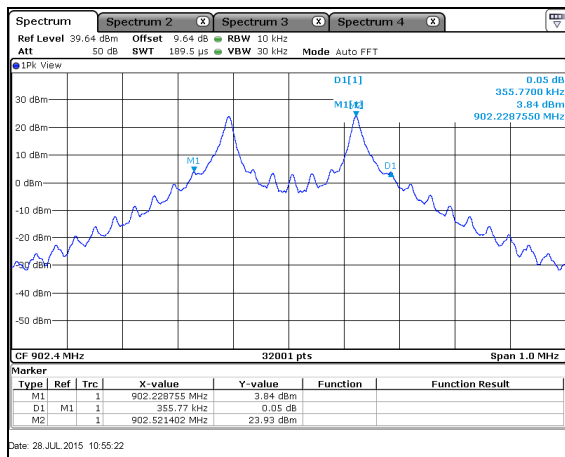

Figure 7.4.4.2-1: 20dB BW Low Channel – 35.5kbps

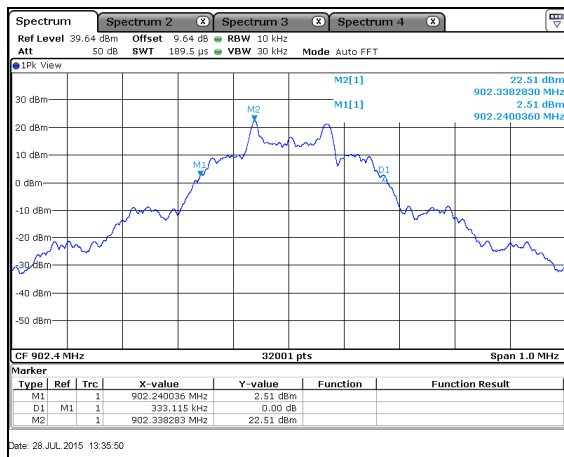

Figure 7.4.4.2-2: 20dB BW Low Channel – 142.2kbps

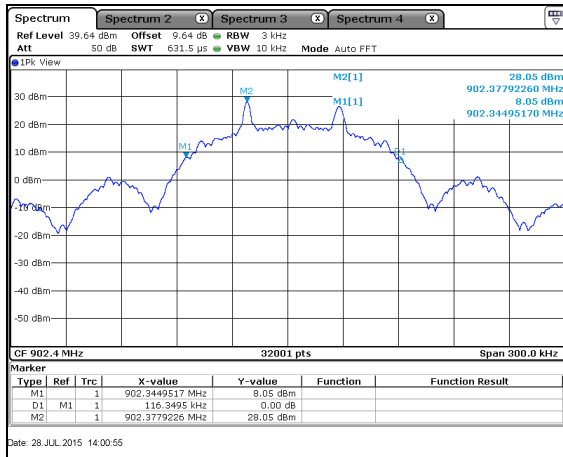

Figure 7.4.4.2-3: 20dB BW Low Channel – 50kbps

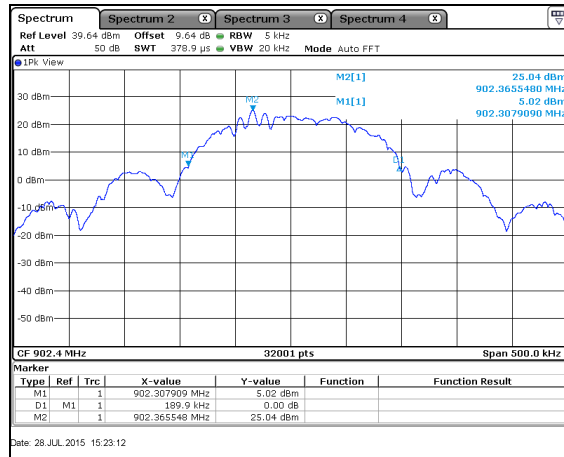

Figure 7.4.4.2-4: 20dB BW Low Channel – 150kbps

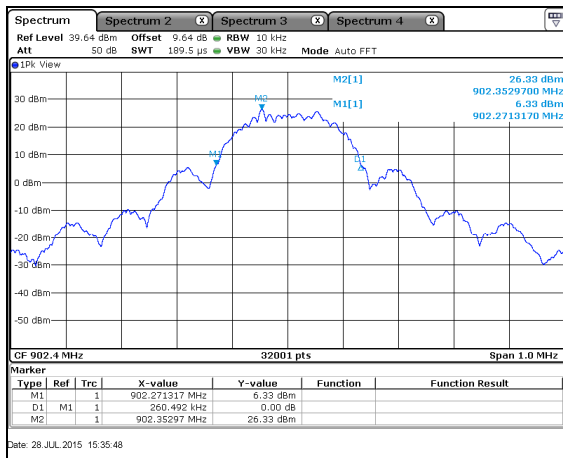

Figure 7.4.4.2-5: 20dB BW Low Channel – 200kbps

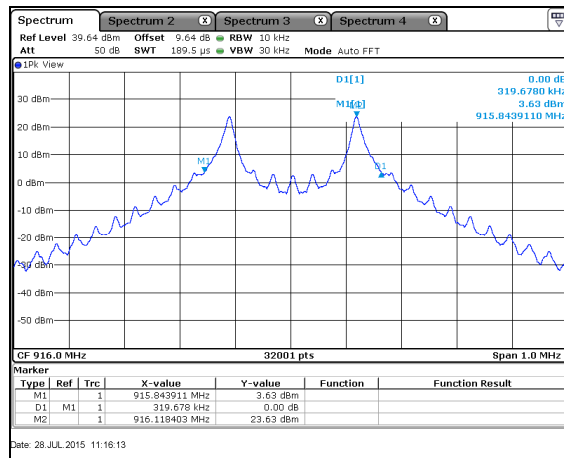

Figure 7.4.4.2-6: 20dB BW Mid Channel – 35.5kbps

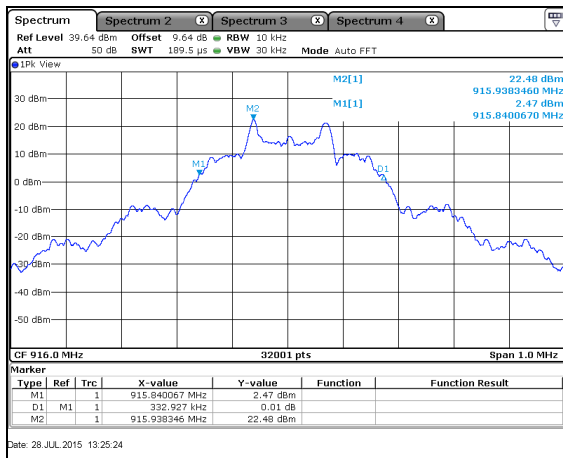

Figure 7.4.4.2-7: 20dB BW Mid Channel – 142.2kbps

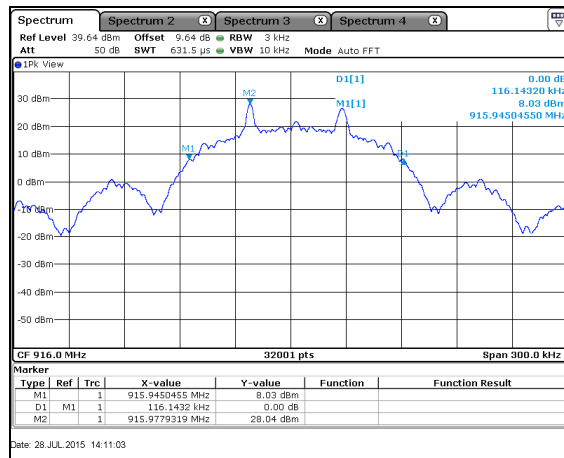

Figure 7.4.4.2-8: 20dB BW Mid Channel – 50kbps

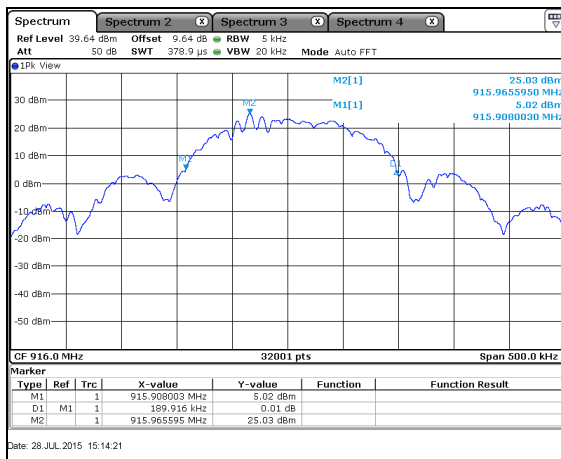

Figure 7.4.4.2-9: 20dB BW Mid Channel – 150kpbs

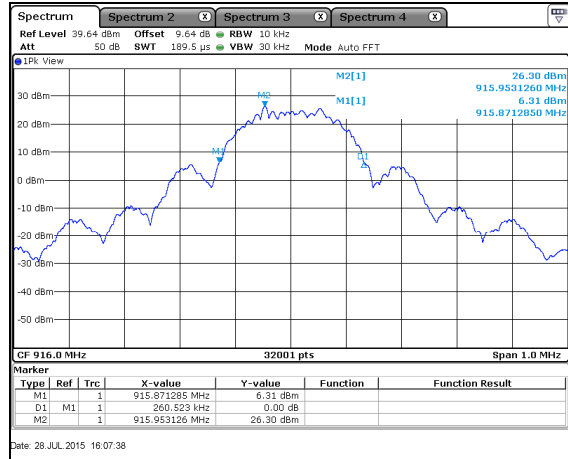

Figure 7.4.4.2-10: 20dB BW Mid Channel – 200kpbs

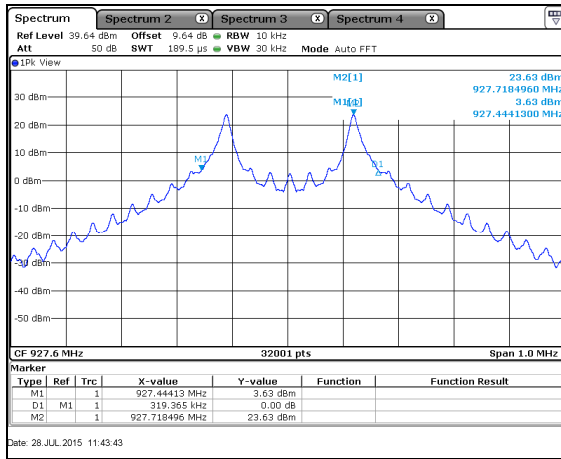

Figure 7.4.4.2-11: 20dB BW High Channel – 35.5kpbs

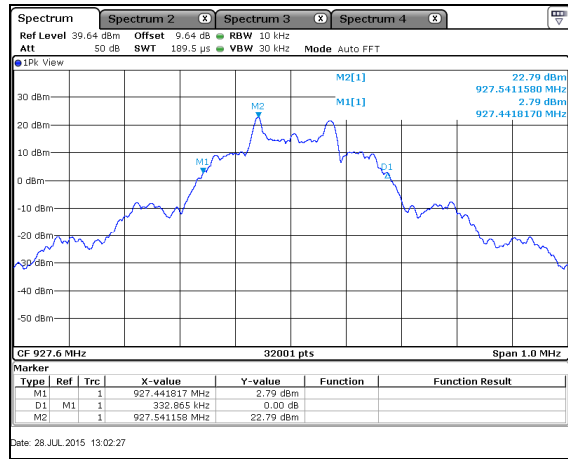

Figure 7.4.4.2-12: 20dB BW High Channel – 142.2kpbs

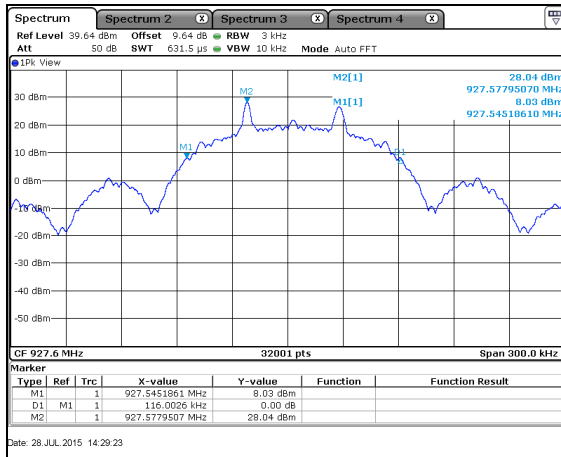

Figure 7.4.4.2-13: 20dB BW High Channel – 50kpbs

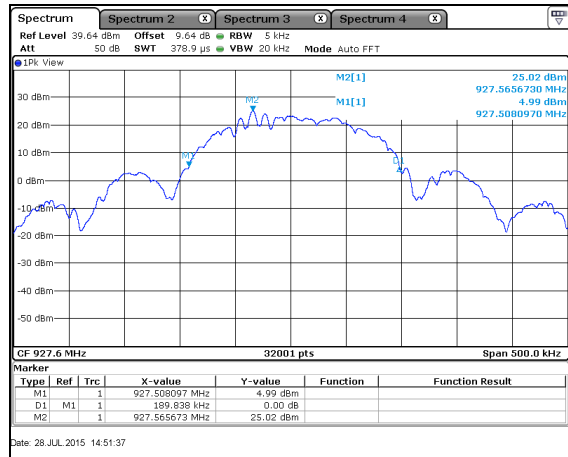

Figure 7.4.4.2-14: 20dB BW High Channel – 150kpbs

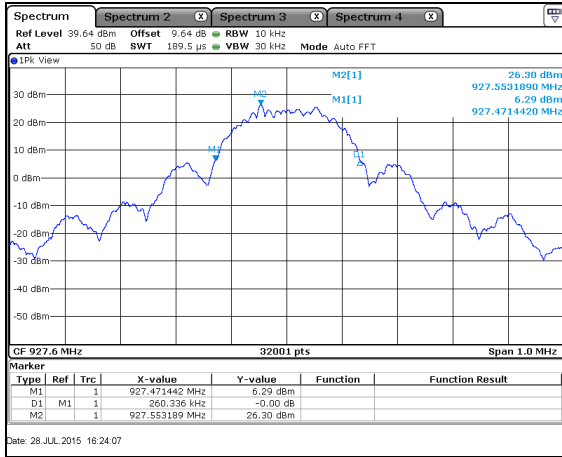

Figure 7.4.4.2-15: 20dB BW High Channel – 200kbps

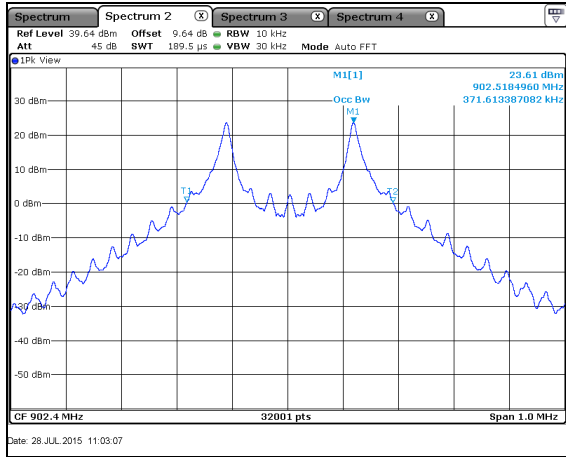

Figure 7.4.4.2-16: 99% BW Low Channel – 35.5kbps

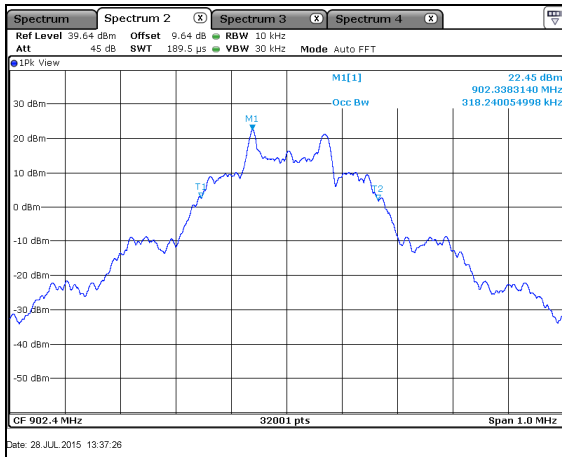

Figure 7.4.4.2-17: 99% BW Low Channel – 142.2kbps

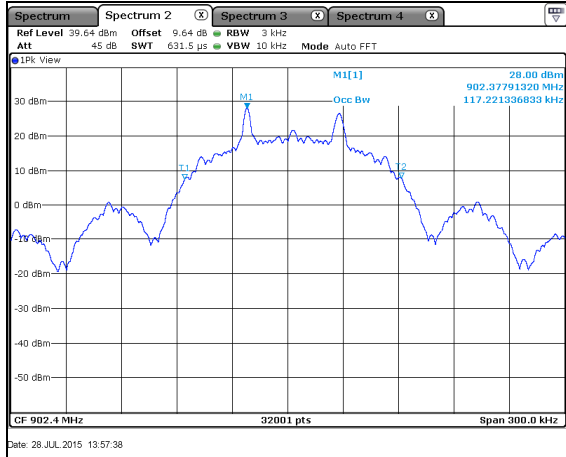

Figure 7.4.4.2-18: 99% BW Low Channel – 50kbps

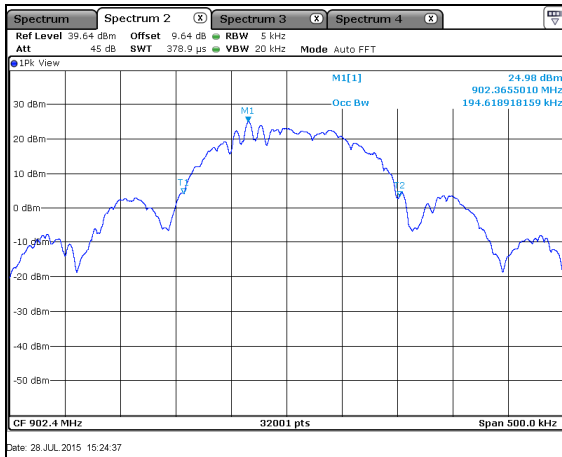

Figure 7.4.4.2-19: 99% BW Low Channel – 150kbps

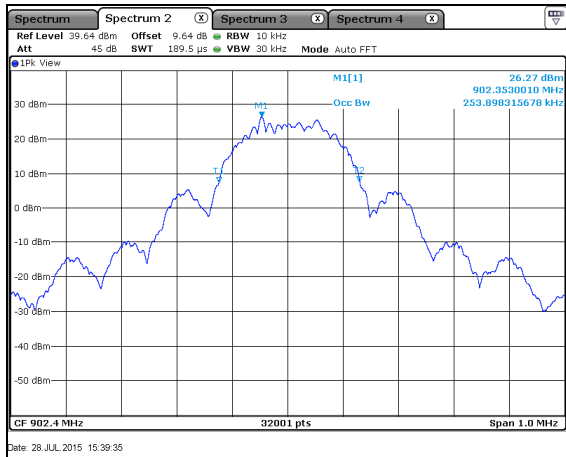
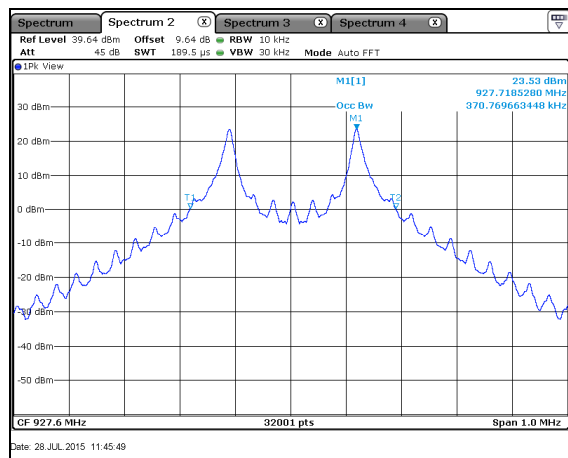
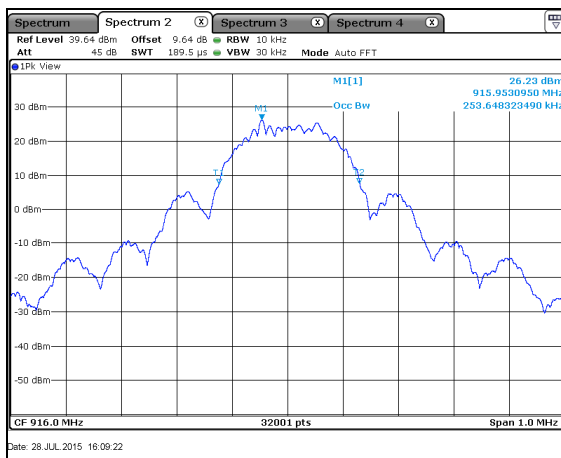
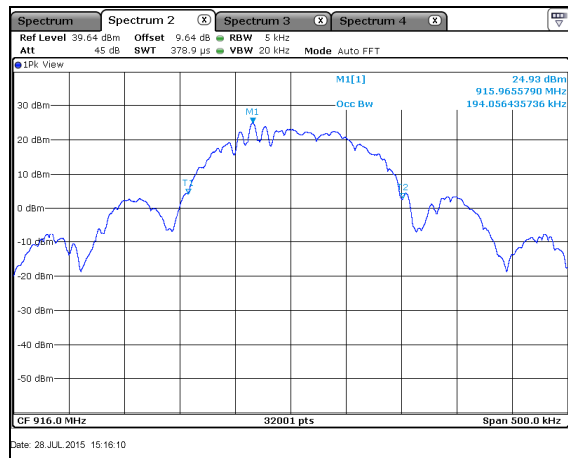
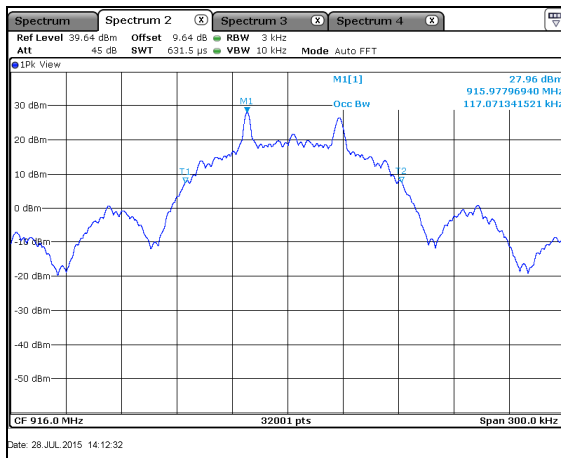
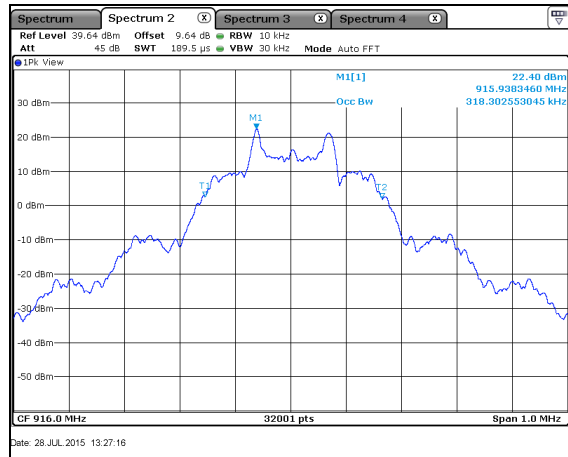
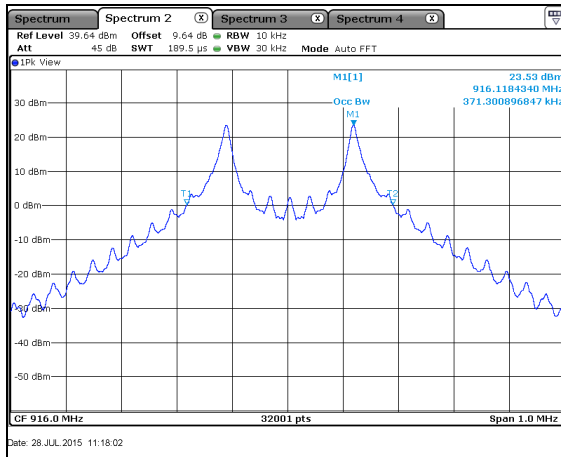

Figure 7.4.4.2-20: 99% BW Low Channel – 200kbps



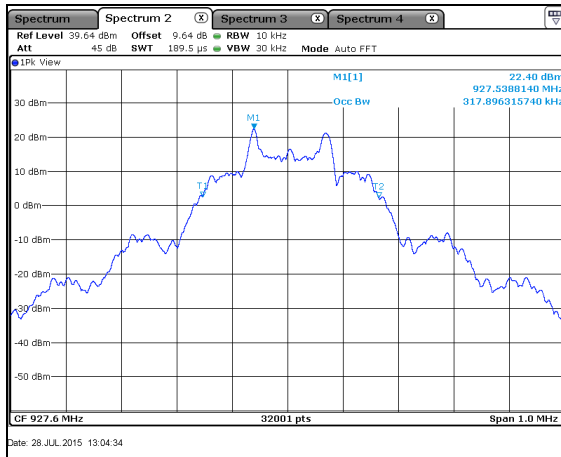

Figure 7.4.4.2-27: 99% BW High Channel – 142.2kbps

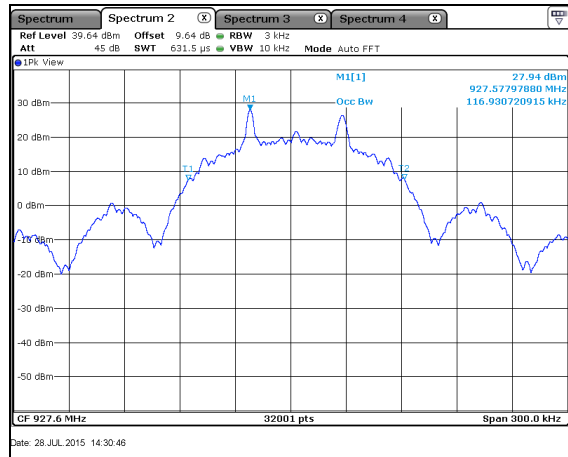

Figure 7.4.4.2-28: 99% BW High Channel – 50kbps

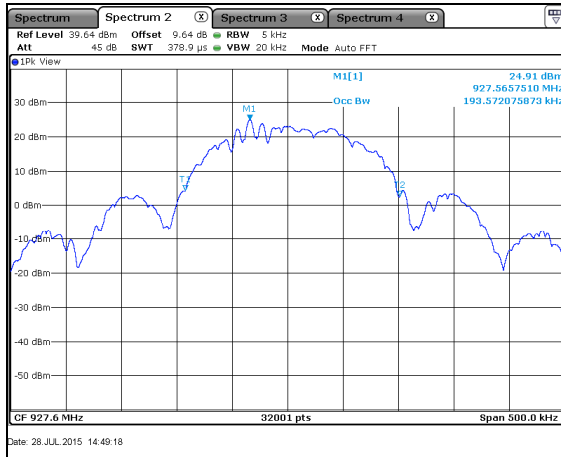

Figure 7.4.4.2-29: 99% BW High Channel – 150kbps

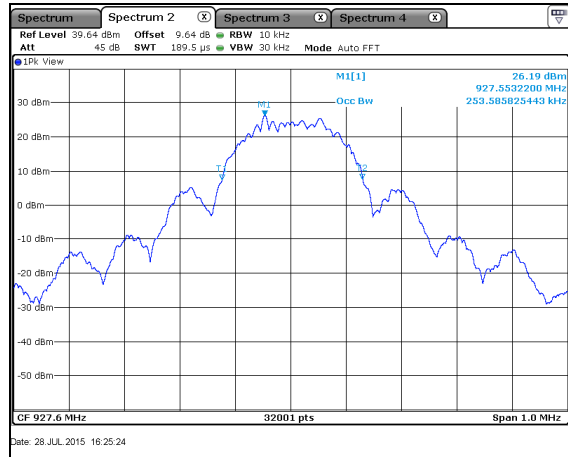

Figure 7.4.4.2-30: 99% BW High Channel – 200kbps

7.5 Band-Edge Compliance and Spurious Emissions

7.5.1 Band-Edge Compliance of RF Conducted Emissions - FCC 15.247(d); IC RSS-247 5.5

7.5.1.1 Measurement Procedure

The RF output port of the EUT was directly connected to the input of the spectrum analyzer using suitable attenuation. The EUT was investigated at the lowest and highest channel available to determine band-edge compliance. For each measurement the spectrum analyzer's RBW was set to 100 kHz, and the VBW was set to 300 kHz.

7.5.1.2 Measurement Results

NON-HOPPING MODE:

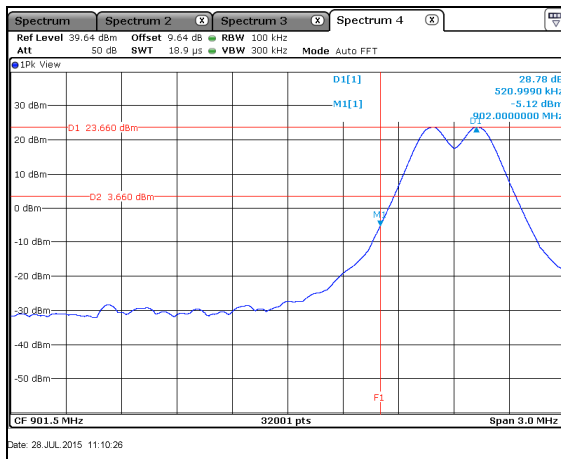

Figure 7.5.1.2-1: Lower BE – 35.5kbps

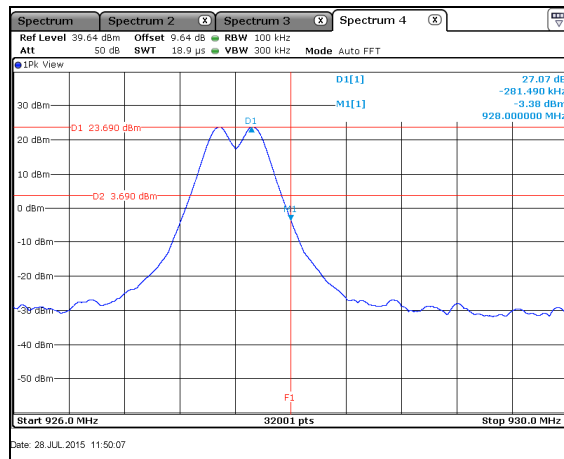

Figure 7.5.1.2-2: Upper BE – 35.5kbps

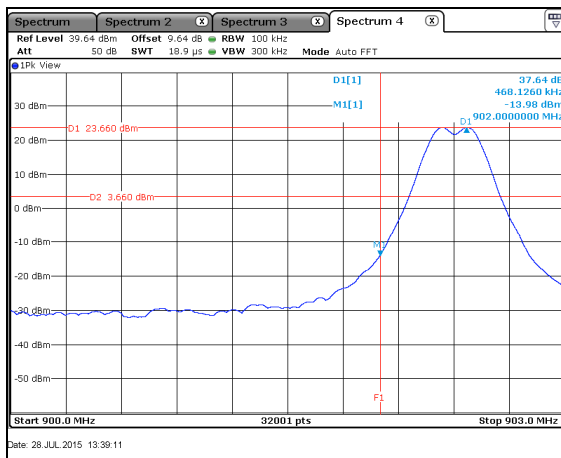

Figure 7.5.1.2-3: Lower BE – 142.2kbps

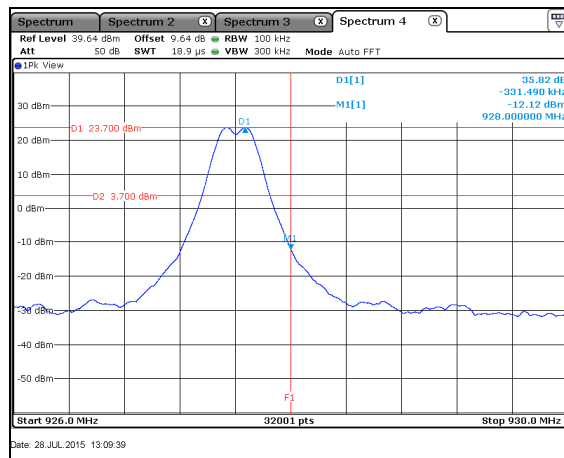

Figure 7.5.1.2-4: Upper BE – 142.2kbps

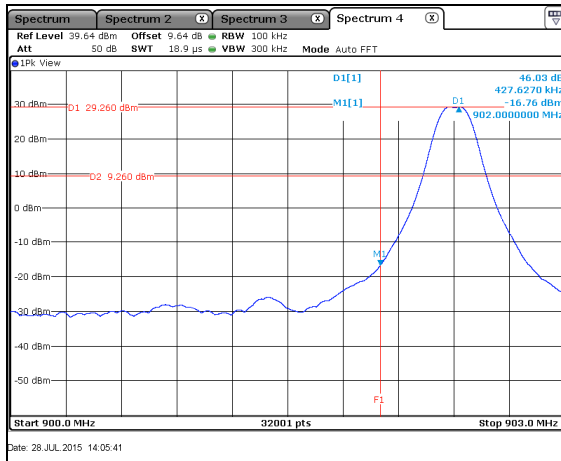

Figure 7.5.1.2-5: Lower BE – 50kbps

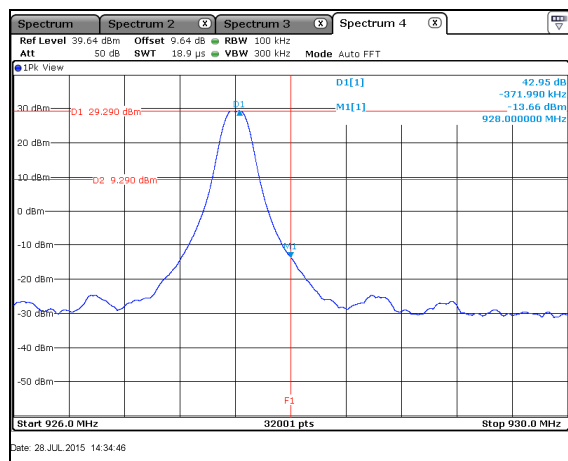

Figure 7.5.1.2-6: Upper BE – 50kbps

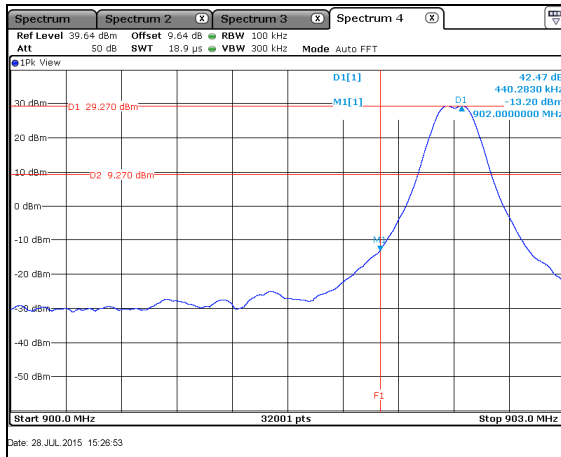

Figure 7.5.1.2-7: Lower BE – 150kbps

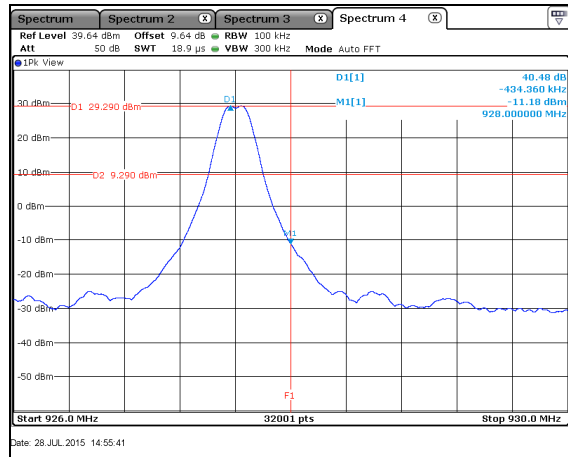

Figure 7.5.1.2-8: Upper BE – 150kbps

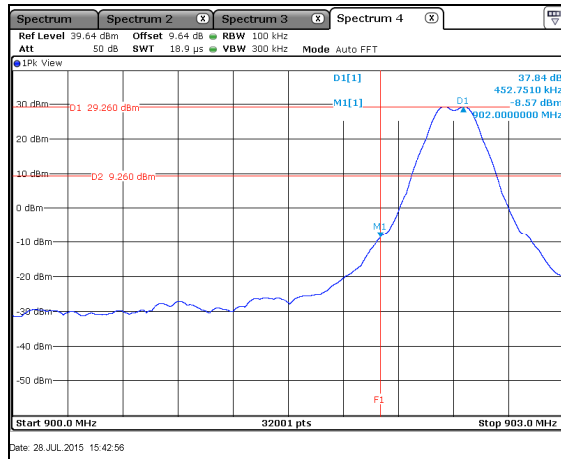

Figure 7.5.1.2-9: Lower BE – 200kbps

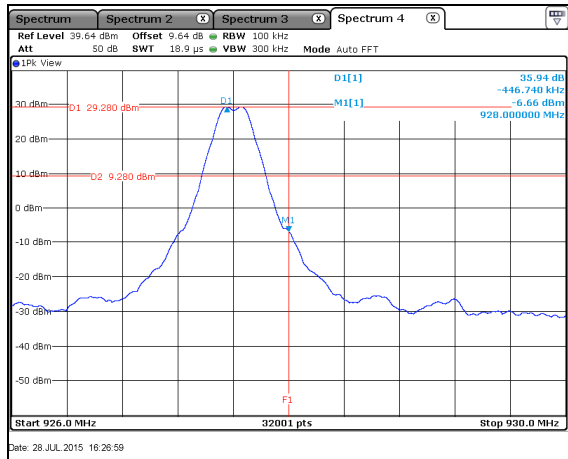
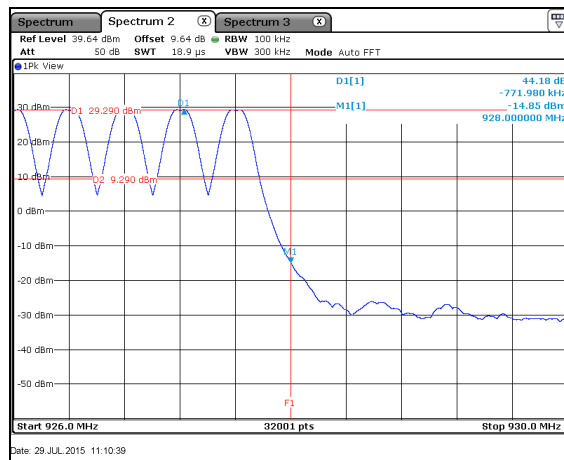
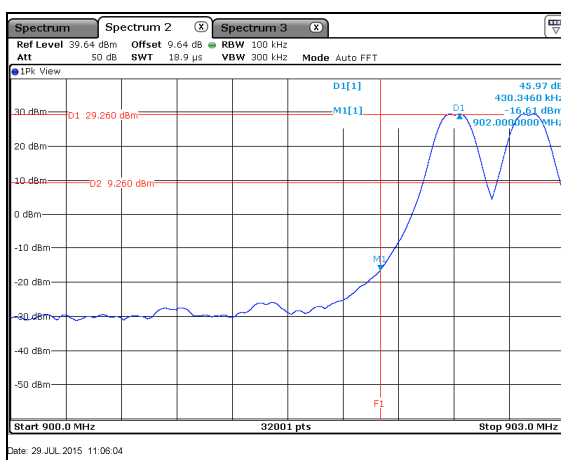
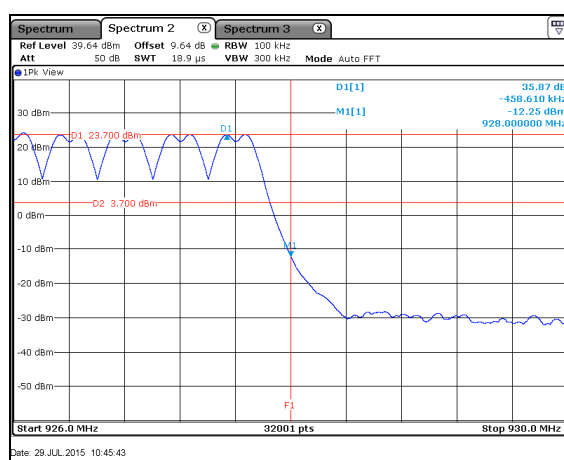
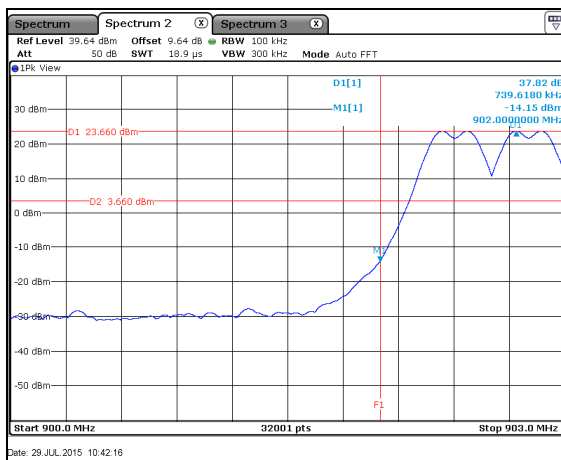
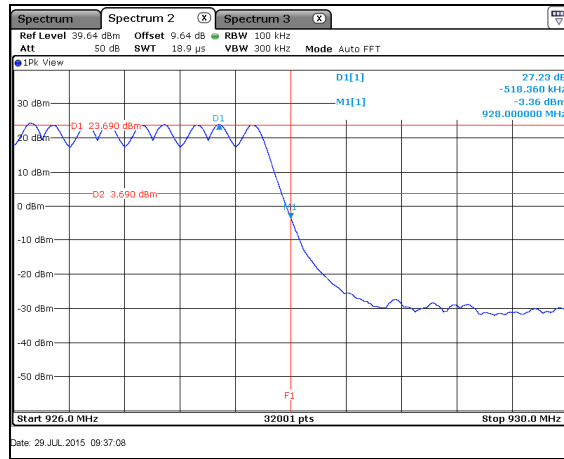
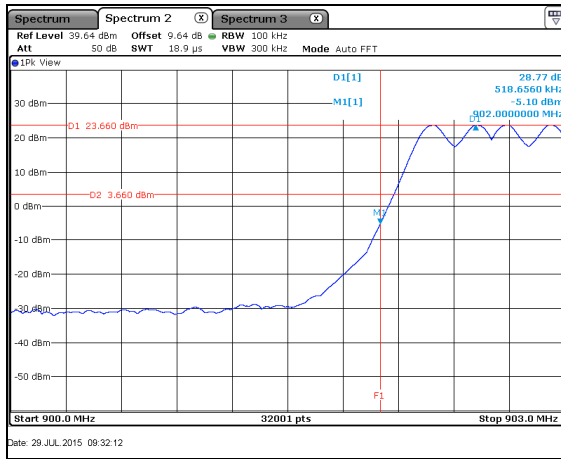

Figure 7.5.1.2-10: Upper BE – 200kbps

HOPPING MODE:



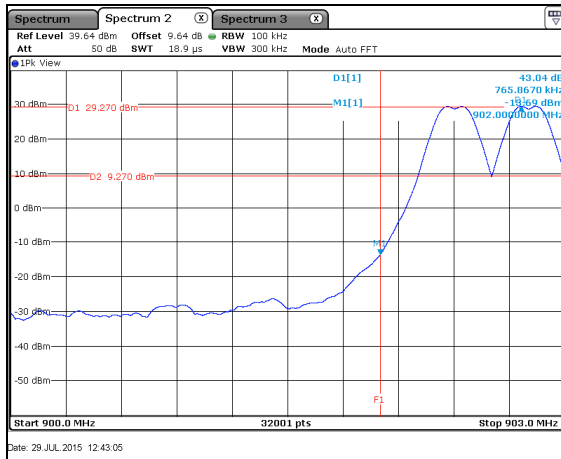

Figure 7.5.1.2-17: Lower BE – Hopping – 150kbps

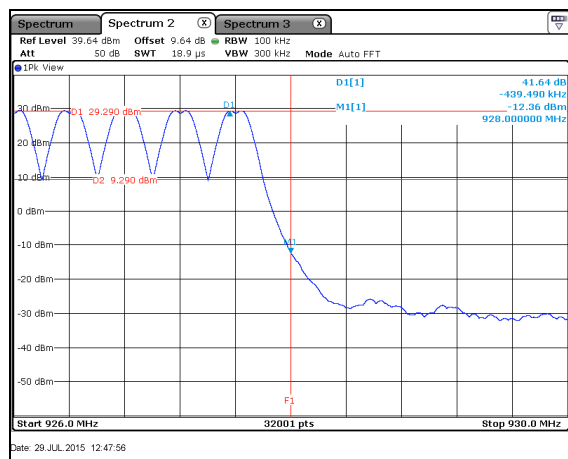

Figure 7.5.1.2-18: Upper BE – Hopping – 150kbps

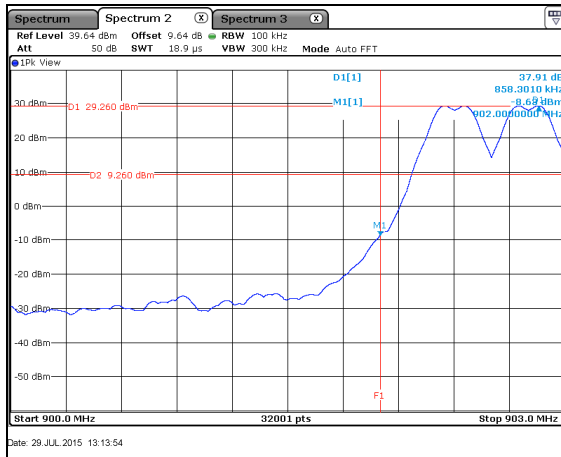

Figure 7.5.1.2-19: Lower BE – Hopping – 200kbps

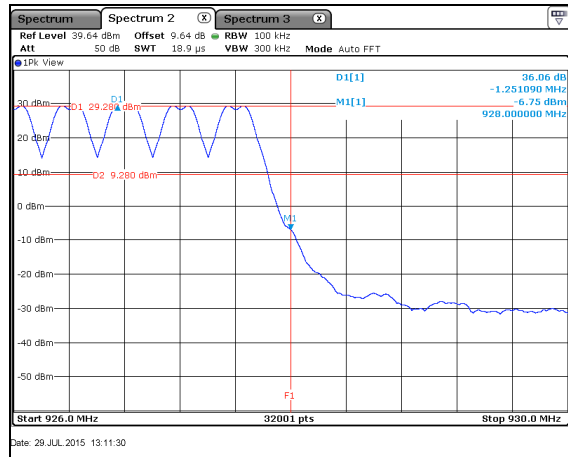

Figure 7.5.1.2-20: Upper BE – Hopping – 200kbps

7.5.2 RF Conducted Spurious Emissions - FCC 15.247(d); IC RSS-247 5.5

7.5.2.1 Measurement Procedure

The RF output port of the EUT was directly connected to the input of the spectrum analyzer using suitable attenuation. The EUT was investigated for conducted spurious emissions from 30MHz to 10GHz, 10 times the highest fundamental frequency. Measurements were made at the low, center and high channels of the EUT. For each measurement, the spectrum analyzer's RBW was set to 100kHz. A peak detector function was used with the trace set to max hold.

7.5.2.2 Measurement Results

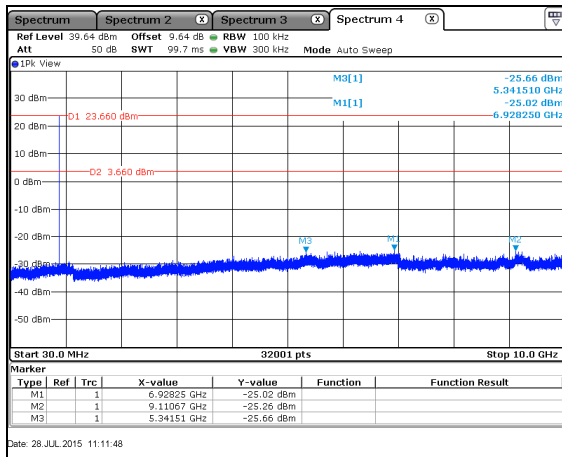

Figure 7.5.2.2-1: 30 MHz – 10 GHz – LCH – 35.5kbps

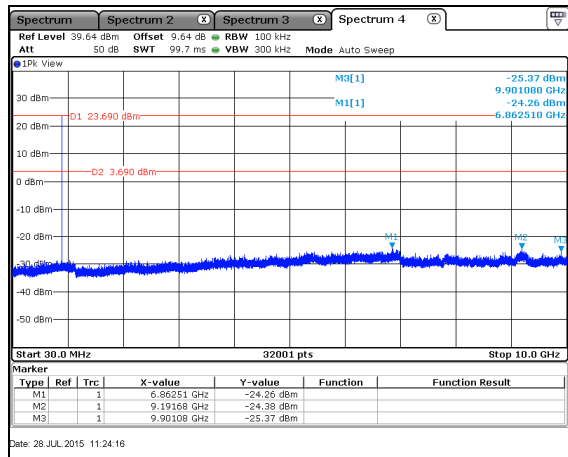

Figure 7.5.2.2-2: 30 MHz – 10 GHz – MCH – 35.5kbps

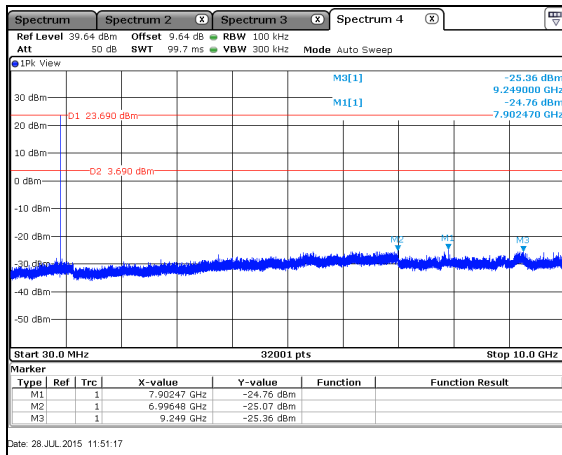

Figure 7.5.2.2-3: 30 MHz – 10 GHz – HCH – 35.5kbps

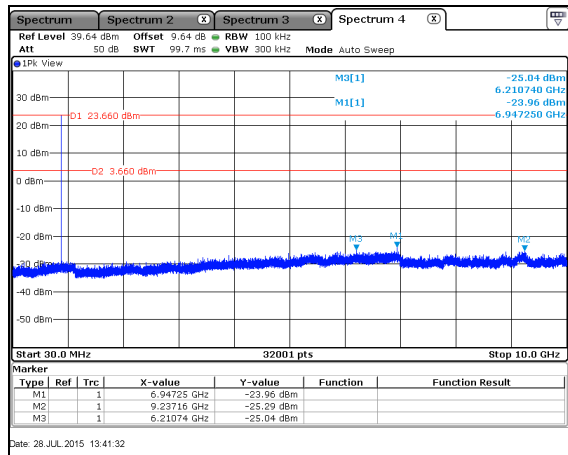

Figure 7.5.2.2-4: 30 MHz – 10 GHz – LCH – 142.2kbps

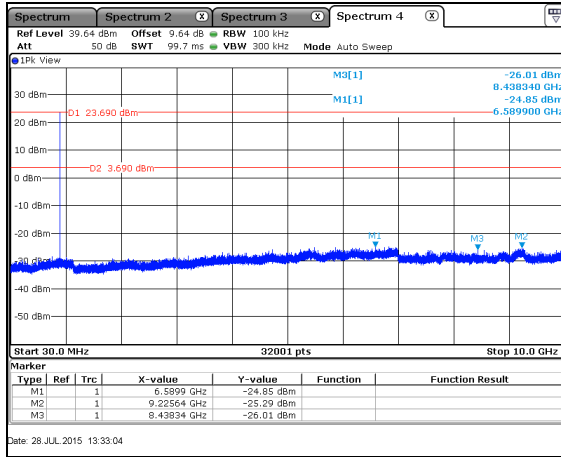

Figure 7.5.2.2-5: 30 MHz – 10 GHz – MCH – 142.2kbps

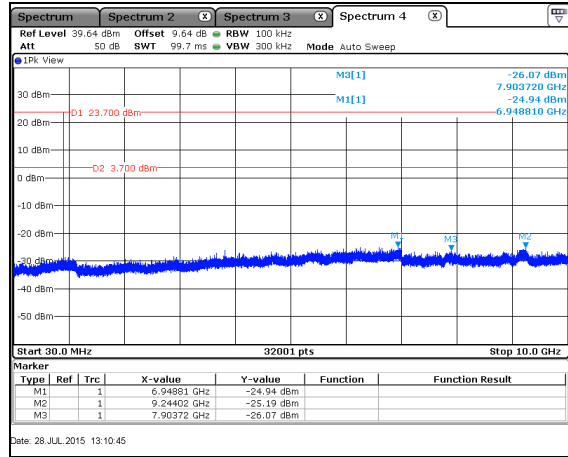

Figure 7.5.2.2-6: 30 MHz – 10 GHz – HCH – 142.2kbps

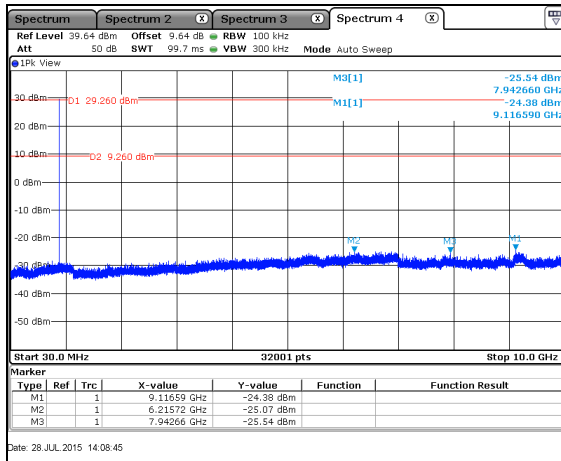

Figure 7.5.2.2-7: 30 MHz – 10 GHz – LCH – 50kbps

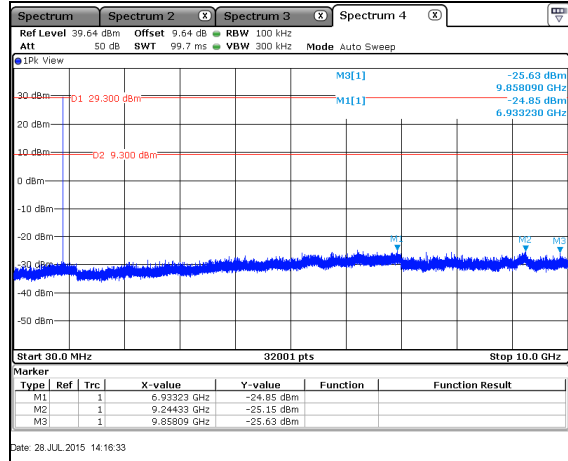

Figure 7.5.2.2-8: 30 MHz – 10 GHz – MCH – 50kbps

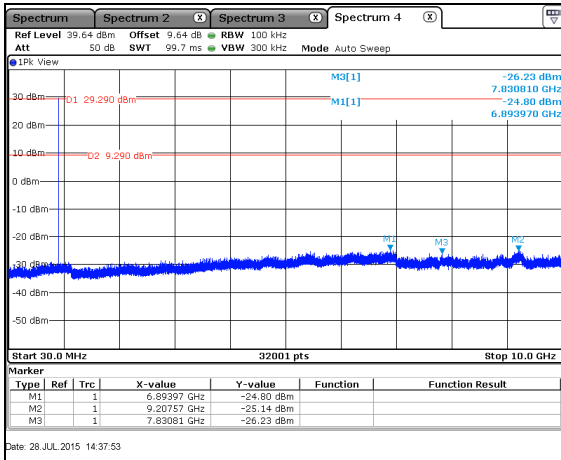

Figure 7.5.2.2-9: 30 MHz – 10 GHz – HCH – 50kbps

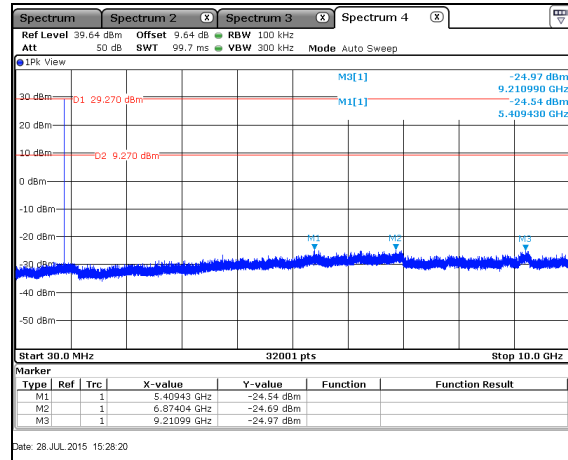

Figure 7.5.2.2-10: 30 MHz – 10 GHz – LCH – 150kbps

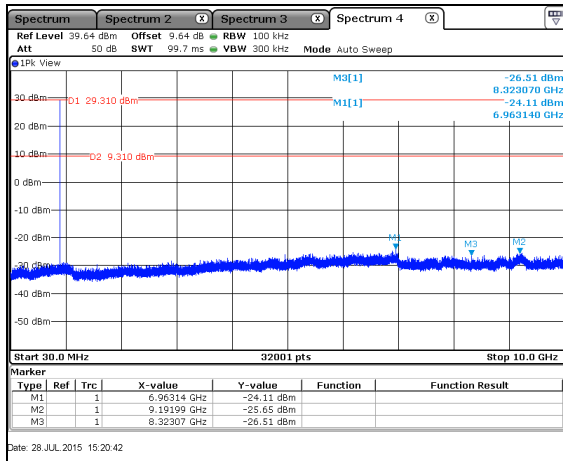

Figure 7.5.2.2-11: 30 MHz – 10 GHz – MCH – 150kbps

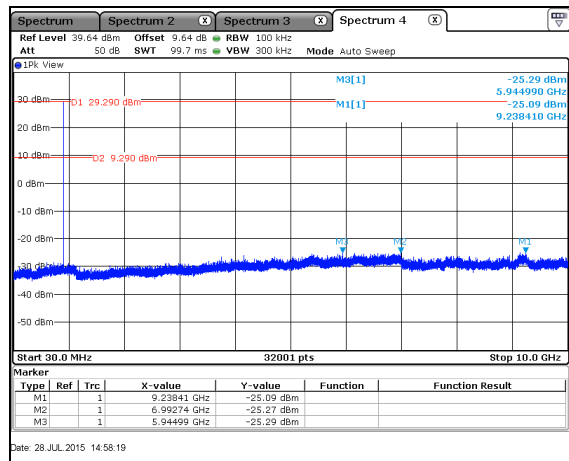

Figure 7.5.2.2-12: 30 MHz – 10 GHz – HCH – 150kbps

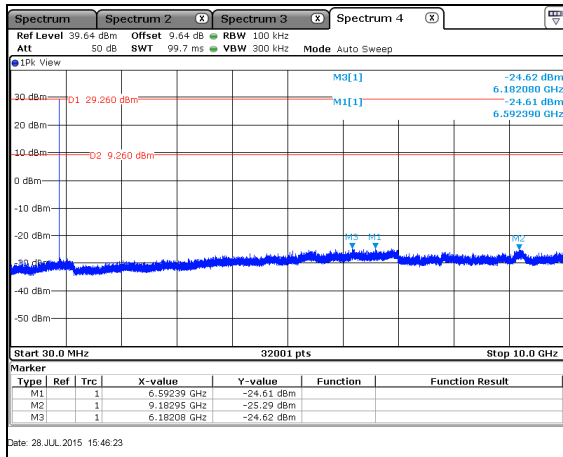

Figure 7.5.2.2-13: 30 MHz – 10 GHz – LCH – 200kbps

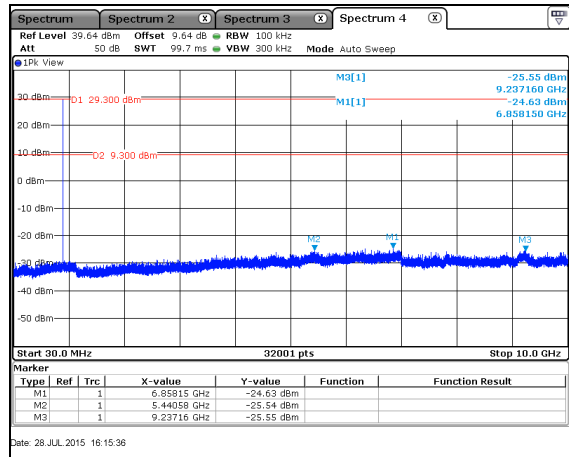

Figure 7.5.2.2-14: 30 MHz – 10 GHz – MCH – 200kbps

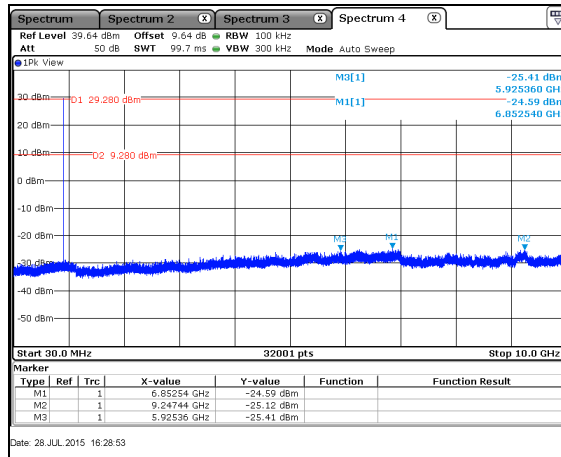

Figure 7.5.2.2-15: 30 MHz – 10 GHz – HCH – 200kbps

7.5.3 Radiated Spurious Emissions - FCC 15.205, 15.209; RSS-Gen 8.9/8.10

7.5.3.1 Measurement Procedure

Radiated emissions tests were made over the frequency range of 30MHz to 10GHz, 10 times the highest fundamental frequency.

The EUT was rotated through 360° and the receive antenna height was varied from 1m to 4m so that the maximum radiated emissions level would be detected. For frequencies below 1000MHz, quasi-peak measurements were made using a resolution bandwidth RBW of 120 kHz and a video bandwidth VBW of 300 kHz. For frequencies above 1000MHz, peak and average measurements were made with RBW and VBW of 1 MHz and 3MHz respectively.

The EUT was caused to generate a continuous modulated carrier on the hopping channel.

Each emission found to be in a restricted band was compared to the applicable radiated emission limits.

7.5.3.2 Measurement Results

Table 7.5.3.2-1: Radiated Spurious Emissions Tabulated Data – Mode 1

Frequency (MHz)	Level (dBuV)		Antenna Polarity (H/V)	Correction Factors (dB)	Corrected Level (dBuV/m)		Limit (dBuV/m)		Margin (dB)	
	pk	Qpk/Avg			pk	Qpk/Avg	pk	Qpk/Avg	pk	Qpk/Avg
Low Channel										
3609.6	48.74	38.23	H	-1.30	47.44	36.93	74.0	54.0	26.6	17.1
3609.6	47.22	36.66	V	-1.30	45.92	35.36	74.0	54.0	28.1	18.6
4512	47.17	36.66	H	0.78	47.95	37.44	74.0	54.0	26.0	16.6
4512	48.29	37.57	V	0.78	49.07	38.35	74.0	54.0	24.9	15.6
5414.4	47.70	37.77	H	3.17	50.87	40.94	74.0	54.0	23.1	13.1
5414.4	47.22	37.32	V	3.17	50.39	40.49	74.0	54.0	23.6	13.5
Middle Channel										
3664	48.54	37.95	H	-1.11	47.43	36.84	74.0	54.0	26.6	17.2
3664	47.37	36.07	V	-1.11	46.26	34.96	74.0	54.0	27.7	19.0
4580	48.39	37.85	H	0.85	49.24	38.70	74.0	54.0	24.8	15.3
4580	47.14	36.48	V	0.85	47.99	37.33	74.0	54.0	26	16.7
High Channel										
3710.4	48.36	37.82	H	-0.94	47.42	36.88	74.0	54.0	26.6	17.1
4638	47.98	37.60	H	0.90	48.88	38.50	74.0	54.0	25.1	15.5
4638	48.41	38.26	V	0.90	49.31	39.16	74.0	54.0	24.7	14.8

Table 7.5.3.2-2: Radiated Spurious Emissions Tabulated Data – Mode 2

Frequency (MHz)	Level (dBuV)		Antenna Polarity (H/V)	Correction Factors (dB)	Corrected Level (dBuV/m)		Limit (dBuV/m)		Margin (dB)	
	pk	Qpk/Avg			pk	Qpk/Avg	pk	Qpk/Avg	pk	Qpk/Avg
Low Channel										
2707.2	47.35	38.10	H	-4.56	42.79	33.54	74.0	54.0	31.2	20.5
2707.2	47.80	39.22	V	-4.56	43.24	34.66	74.0	54.0	30.8	19.3
3609.6	51.03	45.09	H	-1.30	49.73	43.79	74.0	54.0	24.3	10.2
3609.6	49.10	41.81	V	-1.30	47.80	40.51	74.0	54.0	26.2	13.5
4512	49.30	42.29	H	0.78	50.08	43.07	74.0	54.0	23.9	10.9
4512	50.22	44.27	V	0.78	51.00	45.05	74.0	54.0	23.0	8.9
5414.4	50.57	46.13	H	3.17	53.74	49.30	74.0	54.0	20.3	4.7
5414.4	50.14	45.16	V	3.17	53.31	48.33	74.0	54.0	20.7	5.7
Middle Channel										
2748	45.08	36.35	H	-4.41	40.67	31.94	74.0	54.0	33.3	22.1
2748	45.51	37.04	V	-4.41	41.10	32.63	74.0	54.0	32.9	21.4
3664	49.02	41.91	H	-1.11	47.91	40.80	74.0	54.0	26.1	13.2
3664	48.90	41.13	V	-1.11	47.79	40.02	74.0	54.0	26.2	14.0
4580	49.25	42.80	H	0.85	50.10	43.65	74.0	54.0	23.9	10.4
4580	50.62	44.76	V	0.85	51.47	45.61	74.0	54.0	22.5	8.4
High Channel										
2782.8	47.25	38.10	H	-4.29	42.96	33.81	74.0	54.0	31.0	20.2
2782.8	47.04	37.60	V	-4.29	42.75	33.31	74.0	54.0	31.2	20.7
3710.4	49.86	41.71	H	-0.94	48.92	40.77	74.0	54.0	25.1	13.2
3710.4	50.22	42.32	V	-0.94	49.28	41.38	74.0	54.0	24.7	12.6
4638	50.61	44.55	H	0.90	51.51	45.45	74.0	54.0	22.5	8.5
4638	50.67	44.78	V	0.90	51.57	45.68	74.0	54.0	22.4	8.3

Table 7.5.3.2-3: Radiated Spurious Emissions Tabulated Data – 30MHz – 1GHz

Frequency (MHz)	Level (dBuV)		Antenna Polarity (H/V)	Correction Factors (dB)	Corrected Level (dBuV/m)		Limit (dBuV/m)		Margin (dB)	
	pk	Qpk/Avg			pk	Qpk/Avg	pk	Qpk/Avg	pk	Qpk/Avg
57.54	52.33	51.32	V	-14.25	-----	37.07	-----	40.0	-----	2.9
78.54	53.42	52.43	V	-17.85	-----	34.58	-----	40.0	-----	5.4
132.05	56.60	55.20	V	-13.26	-----	41.94	-----	43.5	-----	1.6
164.43	53.14	51.42	V	-9.16	-----	42.26	-----	43.5	-----	1.2
242.48	51.75	49.36	H	-12.75	-----	36.61	-----	46.0	-----	9.4
345.25	45.35	42.10	H	-9.09	-----	33.02	-----	46.0	-----	13.0

7.5.3.3 Sample Calculation:

$$R_C = R_U + CF_T$$

Where:

- CF_T = Total Correction Factor (AF+CA+AG)-DC (Average Measurements Only)
 R_U = Uncorrected Reading
 R_C = Corrected Level
AF = Antenna Factor
CA = Cable Attenuation
AG = Amplifier Gain
DC = Duty Cycle Correction Factor

Example Calculation: Peak

Corrected Level: 48.74 - 1.30 = 47.44dBuV/m

Margin: 74dBuV/m – 47.44dBuV/m = 26.6dB

Example Calculation: Average

Corrected Level: 38.23 - 1.30 - 0 = 36.93dBuV

Margin: 54dBuV – 36.93dBuV = 17.1dB

8 CONCLUSION

In the opinion of ACS, Inc. the REXUA-NZ, manufactured by Elster Solutions, LLC meets the requirements of FCC Part 15 subpart C and Industry Canada's Radio Standards Specification RSS-247.

END REPORT