

Certification Test Report

**FCC ID: QZC-REXUAI
IC: 4557A-REXUAI**

**FCC Rule Part: 15.247
IC Radio Standards Specification: RSS-247**

ACS Report Number: 15-0285.W06.4A

**Manufacturer: Elster Solutions, LLC
Model: REXUAI**

**Test Begin Date: July 25, 2015
Test End Date: July 28, 2015**

Report Issue Date: August 24, 2015



FOR THE SCOPE OF ACCREDITATION UNDER LAB Code 200612-0

This report must not be used by the client to claim product certification, approval, or endorsement by NVLAP, NIST, or any agency of the Federal Government.

Reviewed by:

A handwritten signature in black ink, appearing to read 'Kirby Munroe', is written over a horizontal line.

**Kirby Munroe
Director, Wireless Certifications
ACS, Inc.**

This test report shall not be reproduced except in full. This report may be reproduced in part with prior written consent of ACS, Inc. The results contained in this report are representative of the sample(s) submitted for evaluation.

This report contains 21 pages

TABLE OF CONTENTS

1	GENERAL	3
1.1	PURPOSE.....	3
1.2	PRODUCT DESCRIPTION.....	3
1.3	TEST METHODOLOGY AND CONSIDERATIONS	4
2	TEST FACILITIES	5
2.1	LOCATION	5
2.2	LABORATORY ACCREDITATIONS/RECOGNITIONS/CERTIFICATIONS	5
2.3	RADIATED EMISSIONS TEST SITE DESCRIPTION	6
2.3.1	<i>Semi-Anechoic Chamber Test Site</i>	6
2.3.2	<i>Open Area Tests Site (OATS)</i>	7
2.4	CONDUCTED EMISSIONS TEST SITE DESCRIPTION	8
3	APPLICABLE STANDARD REFERENCES	8
4	LIST OF TEST EQUIPMENT	9
5	SUPPORT EQUIPMENT	10
6	EQUIPMENT UNDER TEST SETUP BLOCK DIAGRAM	10
7	SUMMARY OF TESTS	11
7.1	ANTENNA REQUIREMENT – FCC 15.203	11
7.2	POWER LINE CONDUCTED EMISSIONS – FCC 15.207, IC: RSS-GEN 8.8	11
7.2.1	<i>Measurement Procedure</i>	11
7.2.2	<i>Measurement Results</i>	11
7.3	6dB / 99% BANDWIDTH – FCC 15.247(A)(2), IC: RSS-247 5.2(1)	12
7.3.1	<i>Measurement Procedure</i>	12
7.3.2	<i>Measurement Results</i>	12
7.4	FUNDAMENTAL EMISSION OUTPUT POWER – FCC 15.247(B)(3), IC: RSS-247 5.4(4)	14
7.4.1	<i>Measurement Procedure</i>	14
7.4.2	<i>Measurement Results</i>	14
7.5	EMISSION LEVELS – FCC 15.247(D), 15.205, 15.209; IC RSS-247 5.5, RSS-GEN 8.9	15
7.5.1	<i>Emissions into Non-restricted Frequency Bands</i>	15
7.5.1.1	<i>Measurement Procedure</i>	15
7.5.1.2	<i>Measurement Results</i>	15
7.5.2	<i>Emissions into Restricted Frequency Bands - FCC 15.205, 15.209; RSS-Gen 8.9/8.10</i>	17
7.5.2.1	<i>Measurement Procedure</i>	17
7.5.2.2	<i>Duty Cycle Correction</i>	17
7.5.2.3	<i>Measurement Results</i>	17
7.5.2.4	<i>Sample Calculation:</i>	19
7.6	MAXIMUM POWER SPECTRAL DENSITY IN THE FUNDAMENTAL EMISSION – FCC 15.247(E) IC: RSS-247 5.2(2)	20
7.6.1	<i>Measurement Procedure</i>	20
7.6.2	<i>Measurement Results</i>	20
8	CONCLUSION	21

1 GENERAL**1.1 Purpose**

The purpose of this report is to demonstrate compliance with Part 15 Subpart C of the FCC's Code of Federal Regulations and Industry Canada's Radio Standards Specification Certification. RSS-247.

1.2 Product Description

The REXUAI module contains (1) 900MHz frequency hopping spread spectrum radio and (1) 2.4GHz direct sequence spread spectrum Zigbee radio. This report addresses the 2.4GHz direct sequence spread spectrum Zigbee radio only. The REXUAI forms a complete electricity meter when installed in a housing and meter base.

Technical Information:

Detail	Description
Frequency Range	2.405 GHz – 2.470 GHz
Number of Channels	14
Modulation Format	O-QPSK
Operating Voltage	18Vdc
Antenna Type / Gain	Printed Inverted F / 3.8dBi

Manufacturer Information:

Elster Solutions, LLC
208 South Rogers Lane
Raleigh, NC 27610

EUT Serial Numbers: 5D26119G1403 1 1152400182

Test Sample Condition: The test samples were provided in good working order with no visible defects.

1.3 Test Methodology and Considerations

All modes of operation, including all available data rates, were evaluated for each mode. The data presented in this report represents the worst case where applicable.

For radiated emissions the EUT was evaluated in three orthogonal orientations.

For AC power line conducted emissions the EUT was evaluated with a typical host.

Radiated inter-modulation testing was performed for all combinations of simultaneous transmission and found to be in compliance.

Software power settings during test: -7

2 TEST FACILITIES

2.1 Location

The radiated and conducted emissions test sites are located at the following address:

Advanced Compliance Solutions
5015 B.U. Bowman Drive
Buford, GA 30518
Phone: (770) 831-8048
Fax: (770) 831-8598

2.2 Laboratory Accreditations/Recognitions/Certifications

ACS is accredited to ISO/IEC 17025 by the National Institute of Standards and Technology under their National Voluntary Laboratory Accreditation Program (NVLAP), Lab Code 200612-0. Unless otherwise specified, all tests methods described within this report are covered under the ISO/IEC 17025 scope of accreditation.

The Semi-Anechoic Chamber Test Site, Open Area Test Site (OATS) and Conducted Emissions Site have been fully described, submitted to, and accepted by the FCC, Industry Canada and the Japanese Voluntary Control Council for Interference by information technology equipment.

FCC Registration Number: 511277

Industry Canada Lab Code: IC 4175A

VCCI Member Number: 1831

- VCCI OATS Registration Number R-1526
- VCCI Conducted Emissions Site Registration Number: C-1608

2.3 Radiated Emissions Test Site Description

2.3.1 Semi-Anechoic Chamber Test Site

The Semi-Anechoic Chamber Test Site consists of a 20' x 30' x 18' shielded enclosure. The chamber is lined with Toyo Ferrite Grid Absorber, model number FFG-1000. The ferrite tile grid is 101 x 101 x 19mm thick and weighs approximately 550 grams. These tiles are mounted on steel panels and installed directly on the inner walls of the chamber.

The turntable is 150cm in diameter and is located 160cm from the back wall of the chamber. The chamber is grounded via 1 - 8' copper ground rod, installed at the center of the back wall, it is bound to the ground plane using 3/4" stainless steel braided cable.

The turntable is all steel, flush mounted table installed in an all steel frame. The table is remotely operated from inside the control room located 25' from the range. The turntable is electrically bonded to the surrounding ground plane via steel fingers installed on the edge of the turn table. The steel fingers make constant contact with the ground plane during operation.

Behind the turntable is a 3' x 6' x 4' deep shielded pit used for support equipment if necessary. The pit is equipped with 1 - 4" PVC chases from the turntable to the pit that allow for cabling to the EUT if necessary. The underside of the turntable can be accessed from the pit so cables can be supplied to the EUT from the pit.

A diagram of the Semi-Anechoic Chamber Test Site is shown in Figure 2.3-1 below:

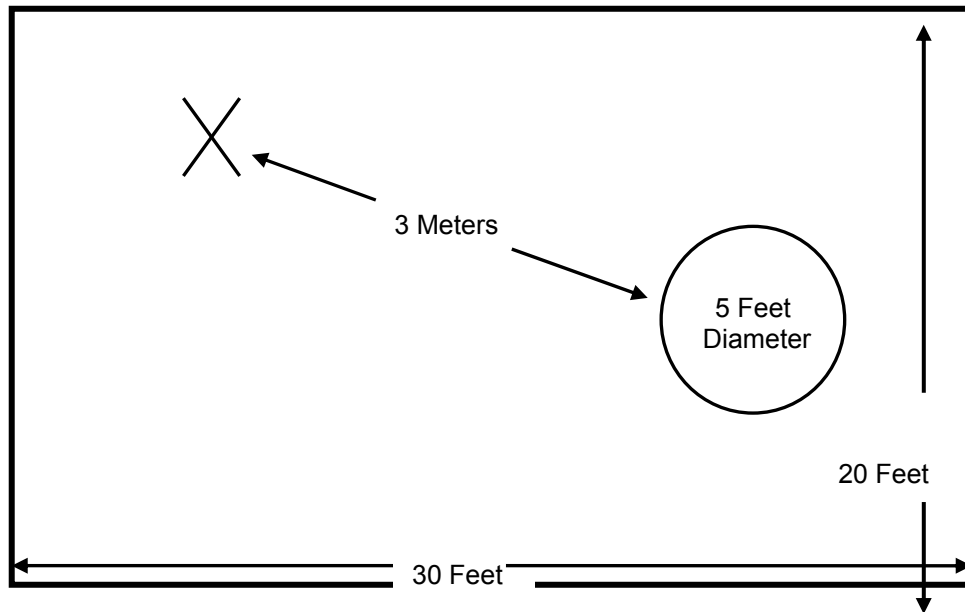

Figure 2.3-1: Semi-Anechoic Chamber Test Site

2.3.2 Open Area Tests Site (OATS)

The open area test site consists of a 40' x 66' concrete pad covered with a perforated electro-plated galvanized sheet metal. The perforations in the sheet metal are 1/8" holes that are staggered every 3/16". The individual sheets are placed to overlap each other by 1/4" and are riveted together to provide a continuous seam. Rivets are spaced every 3" in a 3 x 20 meter perimeter around the antenna mast and EUT area. Rivets in the remaining area are spaced as necessary to properly secure the ground plane and maintain the electrical continuity.

The entire ground plane extends 12' beyond the turntable edge and 16' beyond the antenna mast when set to a 10 meter measurement distance. The ground plane is grounded via 4 - 8' copper ground rods, each installed at a corner of the ground plane and bound to the ground plane using 3/4" stainless steel braided cable.

The turntable is an all aluminum 10' flush mounted table installed in an all aluminum frame. The table is remotely operated from inside the control room located 40' from the range. The turntable is electrically bonded to the surrounding ground plane via steel fingers installed on the edge of the turn table. The steel fingers make constant contact with the ground plane during operation.

Adjacent to the turntable is a 7' x 7' square and 4' deep concrete pit used for support equipment if necessary. The pit is equipped with 5 - 4" PVC chases from the pit to the control room that allow for cabling to the EUT if necessary. The underside of the turntable can be accessed from the pit so cables can be supplied to the EUT from the underside of the pit. The pit is covered with 2 sheets of 1/4" diamond style re-enforced steel sheets. The sheets are painted to match the perforated steel ground plane; however the underside edges have been masked off to maintain the electrical continuity of the ground plane. All reflecting objects are located outside of the ellipse defined in ANSI C63.4.

A diagram of the Open Area Test Site is shown in Figure 2.3-2 below:

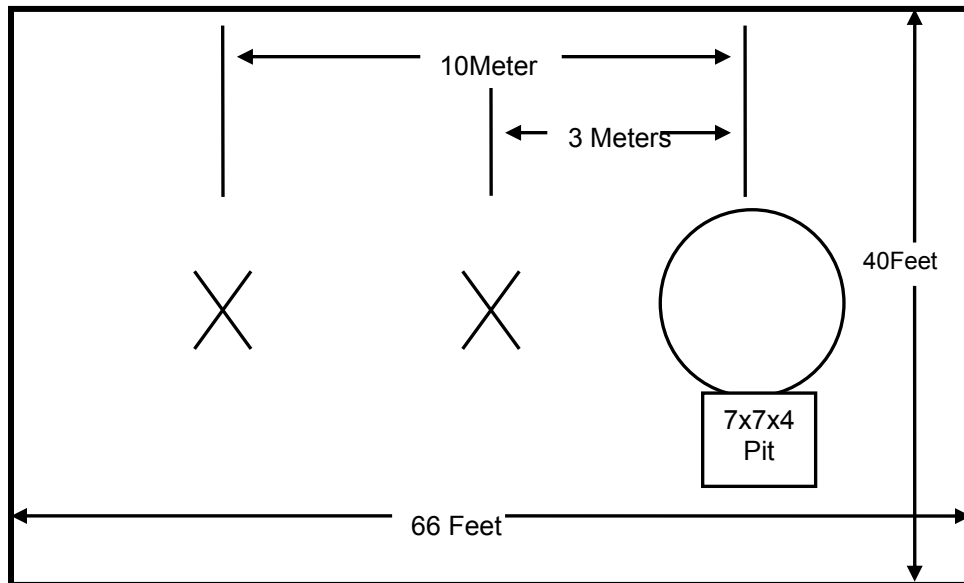

Figure 2.3-2: Open Area Test Site

2.4 Conducted Emissions Test Site Description

The AC mains conducted EMI site is located in the main EMC lab. It consists of an 8' x 8' solid aluminum horizontal ground reference plane (GRP) bonded every 3" to an 8' X 8' vertical ground plane.

The site is of sufficient size to test table top and floor standing equipment in accordance with section 6.1.4 of ANSI C63.4.

A diagram of the room is shown below in figure 4.1.3-1:

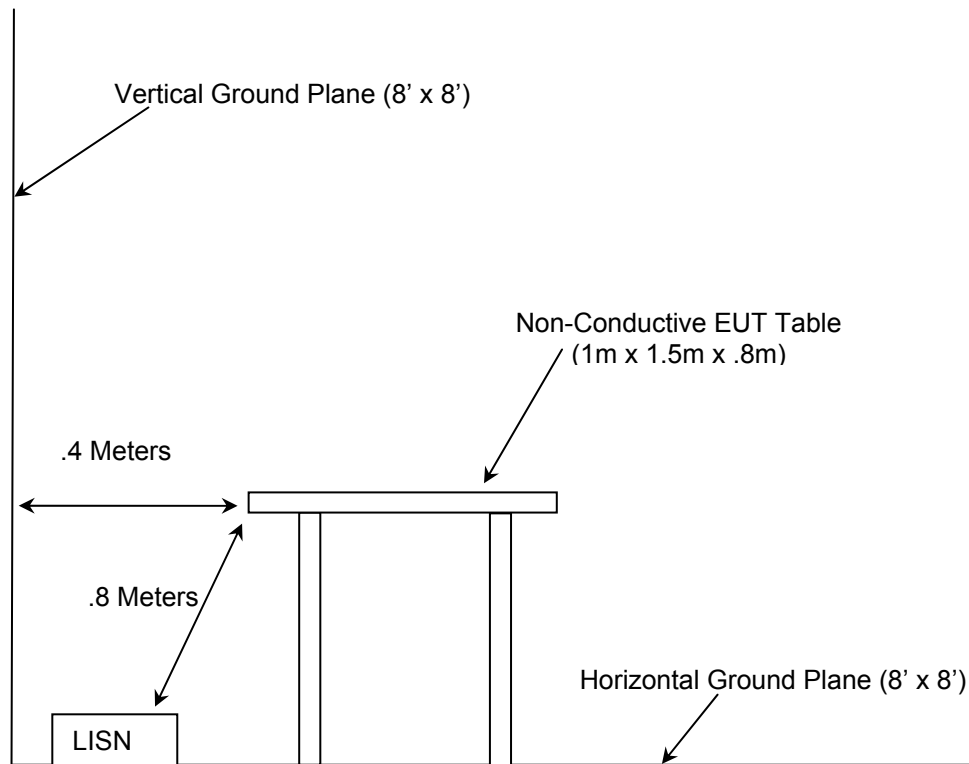

Figure 2.4-1: AC Mains Conducted EMI Site

3 APPLICABLE STANDARD REFERENCES

The following standards were used:

- ❖ ANSI C63.10-2013: American National Standard of Procedures for Compliance Testing of Unlicensed Wireless Devices
- ❖ US Code of Federal Regulations (CFR): Title 47, Part 2, Subpart J: Equipment Authorization Procedures, 2015
- ❖ US Code of Federal Regulations (CFR): Title 47, Part 15, Subpart C: Radio Frequency Devices, Intentional Radiators, 2015
- ❖ FCC KDB 558074 D01 DTS Meas Guidance v03r03 - Guidance for Performing Compliance Measurements on Digital Transmission Systems (DTS) Operating Under §15.247, June 9, 2015
- ❖ Industry Canada Radio Standards Specification: RSS-247 – Digital Transmission Systems (DTSs), Frequency Hopping Systems (FHSs) and Licence-Exempt Local Area Network (LE-LAN) Devices, Issue 1, May 2015.
- ❖ Industry Canada Radio Standards Specification: RSS-GEN – General Requirements for Compliance of Radio Apparatus, Issue 4, Nov 2014.

4 LIST OF TEST EQUIPMENT

The calibration interval of test equipment is annually or the manufacturer's recommendations. Where the calibration interval deviates from the annual cycle based on the instrument manufacturer's recommendations, it shall be stated below.

Table 4-1: Test Equipment

AssetID	Manufacturer	Model #	Equipment Type	Serial #	Last Calibration Date	Calibration Due Date
1	Rohde & Schwarz	ESMI - Display	Spectrum Analyzers	833771/007	7/14/2015	7/14/2016
2	Rohde & Schwarz	ESMI-Receiver	Spectrum Analyzers	839587/003	7/14/2015	7/14/2016
30	Spectrum Technologies	DRH-0118	Antennas	970102	4/30/2015	4/30/2017
40	EMCO	3104	Antennas	3211	2/10/2015	2/10/2017
73	Agilent	8447D	Amplifiers	2727A05624	7/15/2015	7/15/2016
167	ACS	Chamber EMI Cable Set	Cable Set	167	10/28/2014	10/28/2015
168	Hewlett Packard	11947A	Attenuators	44829	1/19/2015	1/19/2016
292	Florida RF Cables	SMR-290AW- 480.0-SMR	Cables	None	3/3/2015	3/3/2016
316	Rohde Schwarz	ESH3-Z5	LISN	861189-010	7/14/2015	7/14/2016
324	ACS	Belden	Cables	8214	5/5/2015	5/5/2016
337	Microwave Circuits	H1G513G1	Filters	282706	5/20/2015	5/20/2016
338	Hewlett Packard	8449B	Amplifiers	3008A01111	7/30/2013	8/30/2015
340	Aeroflex/Weinschel	AS-20	Attenuators	7136	7/13/2015	7/13/2016
412	Electro Metrics	LPA-25	Antennas	1241	7/24/2014	7/24/2016
422	Florida RF	SMS-200AW-72.0- SMR	Cables	805	11/5/2014	11/5/2015
616	Florida RF Cables	SMRE-200W-12.0- SMRE	Cables	N/A	9/10/2014	9/10/2015
622	Rohde & Schwarz	FSV40	Analyzers	101338	7/15/2015	7/15/2016
RE112	Rohde & Schwarz	ESIB26	Receiver	836119/012	7/16/2015	7/16/2016

5 SUPPORT EQUIPMENT

Table 5-1: Support Equipment

Item	Equipment Type	Manufacturer	Model Number	Serial Number
1	Signal/Power Adaptor PCB	Elster Solutions, LLC	N/A	N/A
2	AC Adaptor	V-Infinity	EMSA150120K-P5P-SZ	N/A
3	DC Power Supply	Hewlett Packard	E3630A	KR64308603
4	Electric Utility Meter	Elster Electricity, LLC.	FM2S	18 935 643

6 EQUIPMENT UNDER TEST SETUP BLOCK DIAGRAM

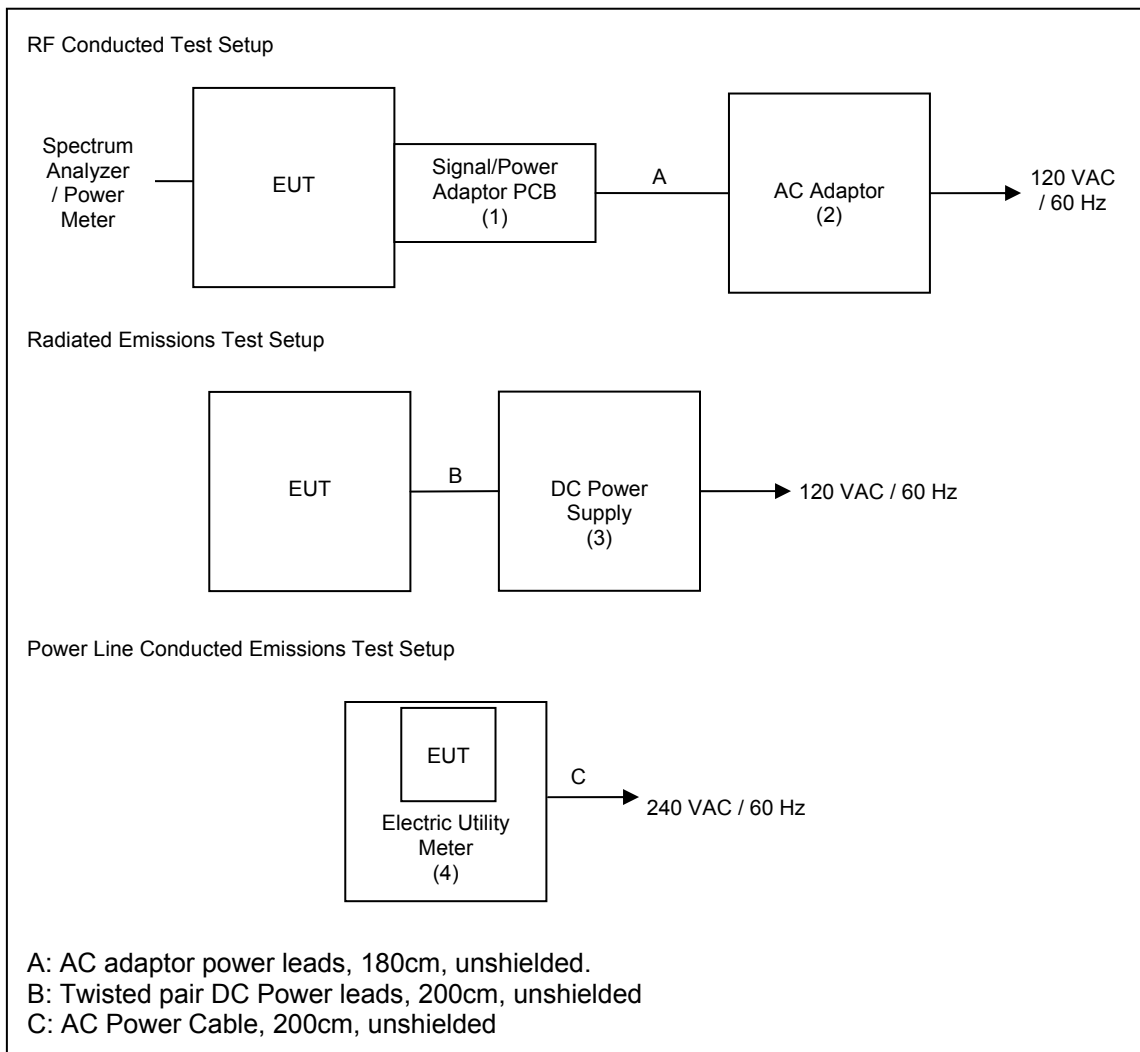

Figure 6-1: Test Setup Block Diagram

7 SUMMARY OF TESTS

Along with the tabular data shown below, plots were taken of all signals deemed important enough to document.

7.1 Antenna Requirement – FCC 15.203

The antenna is a non-detachable Printed Inverted F Antenna with 3.8dBi gain. The antenna is permanently attached to the radio, therefore satisfying the requirements of 15.203.

7.2 Power Line Conducted Emissions – FCC 15.207, IC: RSS-Gen 8.8

7.2.1 Measurement Procedure

ANSI C63.4 sections 6 and 7 were the guiding documents for this evaluation. Conducted emissions were performed from 150kHz to 30MHz with the spectrum analyzer's resolution bandwidth set to 9kHz and the video bandwidth set to 30kHz. The calculation for the conducted emissions is as follows:

Corrected Reading = Analyzer Reading + LISN Loss + Cable Loss

Margin = Applicable Limit - Corrected Reading

7.2.2 Measurement Results

Table 7.2.2-1: Conducted EMI Results Line 1

Frequency (MHz)	QuasiPeak (dBμV)	Average (dBμV)	Limit (dBμV)	Margin (dB)	Line	Corr. (dB)
0.223547	---	32.96	52.47	19.51	L1	10.1
0.223547	44.02	---	62.50	18.48	L1	10.1
0.261122	---	29.48	51.15	21.67	L1	10.1
0.261122	43.73	---	61.19	17.46	L1	10.1
0.266332	---	28.98	50.99	22.01	L1	10.1
0.266332	43.11	---	61.03	17.92	L1	10.1
0.299899	---	27.46	50.01	22.55	L1	10.1
0.299899	38.80	---	60.05	21.25	L1	10.1
0.309920	---	27.61	49.74	22.13	L1	10.1
0.309920	39.09	---	59.78	20.69	L1	10.1
0.339980	---	26.41	48.99	22.58	L1	10.1
0.339980	38.41	---	59.03	20.62	L1	10.1

Table 7.2.2-2: Conducted EMI Results Line 2

Frequency (MHz)	QuasiPeak (dBμV)	Average (dBμV)	Limit (dBμV)	Margin (dB)	Line	Corr. (dB)
0.174949	---	31.26	54.61	23.35	N	10.1
0.174949	45.20	---	64.63	19.43	N	10.1
0.247395	---	29.89	51.60	21.71	N	10.1
0.247395	44.30	---	61.64	17.34	N	10.1
0.261824	---	28.79	51.13	22.34	N	10.1
0.261824	43.75	---	61.17	17.42	N	10.1
0.271844	---	27.97	50.82	22.85	N	10.1
0.271844	42.19	---	60.86	18.67	N	10.1
0.677655	---	22.88	46.00	23.12	N	10.1
0.677655	32.77	---	56.00	23.23	N	10.1
0.697695	---	24.73	46.00	21.27	N	10.1
0.697695	33.50	---	56.00	22.50	N	10.1

7.3 6dB / 99% Bandwidth – FCC 15.247(a)(2), IC: RSS-247 5.2(1)

7.3.1 Measurement Procedure

The 6dB bandwidth was measured in accordance with the FCC KDB 558074 D01 DTS Meas Guidance v03r03. The Resolution Bandwidth (RBW) of the spectrum analyzer was set to 100 kHz. The Video Bandwidth (VBW) was set to ≥ 3 times the RBW. The trace was set to max hold with a peak detector active. The ndB down function of the spectrum analyzer was utilized to determine the 6 dB bandwidth of the emission.

The occupied bandwidth measurement function of the spectrum analyzer was used to measure the 99% bandwidth. The span of the analyzer was set to capture all products of the modulation process, including the emission sidebands. The resolution bandwidth was set to 1% to 5% of the occupied bandwidth. The video bandwidth was set to 3 times the resolution bandwidth. A peak detector was used.

7.3.2 Measurement Results

Table 7.3.2-1: 6dB / 99% Bandwidth

Frequency [MHz]	6dB Bandwidth [MHz]	99% Bandwidth [MHz]
2405	1.613	2.440
2440	1.598	2.428
2470	1.586	2.401

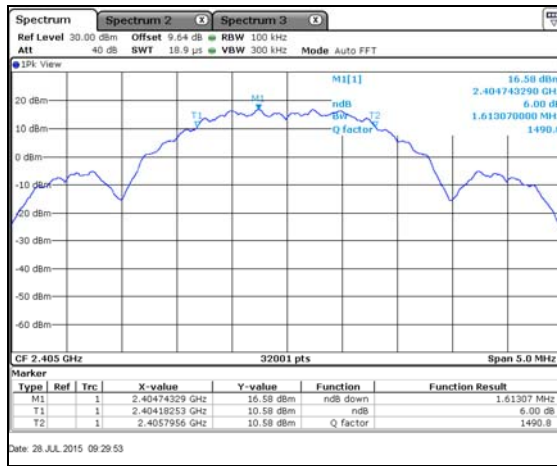

Figure 7.3.2-1: 6dB Bandwidth Plot – LCH

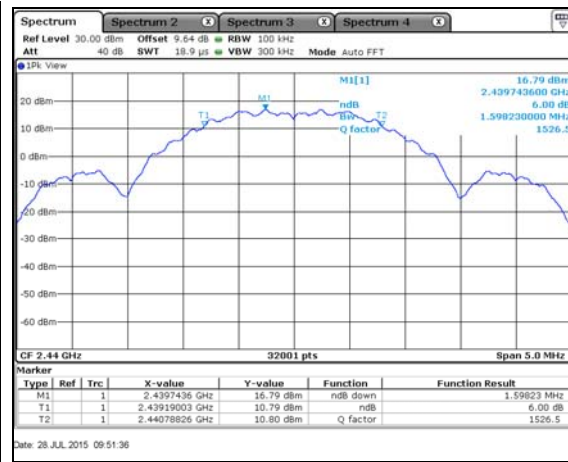

Figure 7.3.2-2: 6dB Bandwidth Plot – MCH

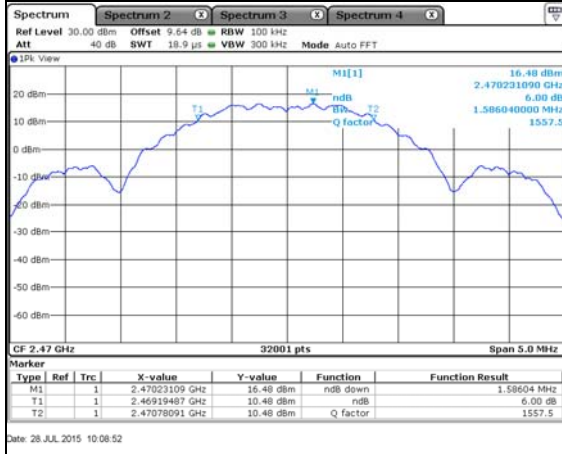

Figure 7.3.2-3: 6dB Bandwidth Plot – HCH

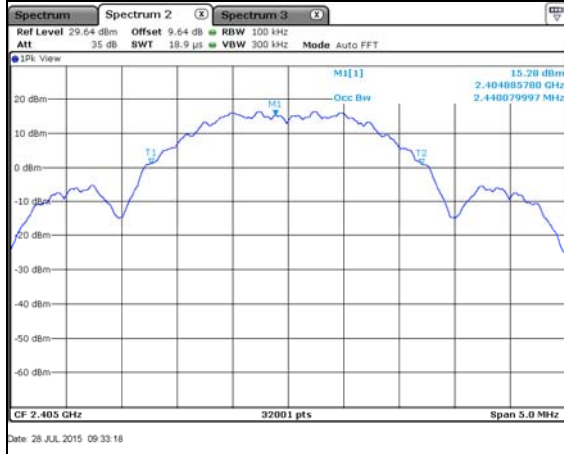

Figure 7.3.2-4: 99% Bandwidth Plot – LCH

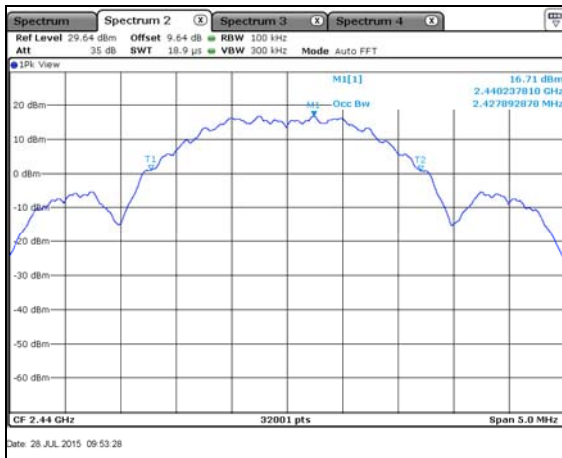

Figure 7.3.2-5: 99% Bandwidth Plot – MCH

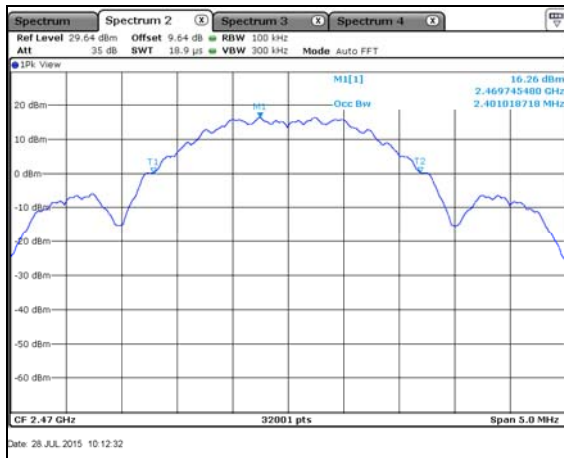

Figure 7.3.2-6: 99% Bandwidth Plot – HCH

7.4 Fundamental Emission Output Power – FCC 15.247(b)(3), IC: RSS-247 5.4(4)

7.4.1 Measurement Procedure

The maximum conducted output power was measured in accordance with FCC KDB 558074 D01 DTS Meas Guidance v03r03 utilizing the RBW ≥ DTS bandwidth method. The RF output of the equipment under test was directly connected to the input of the spectrum analyzer applying suitable attenuation the RBW was set ≥ DTS bandwidth, the VBW was set ≥ 3 x RBW, and the span was set ≥ 3x RBW. The trace was set to max hold with a peak detector active.

7.4.2 Measurement Results

Table 7.4.2-1: Maximum Conducted Output Power

Frequency [MHz]	Level [dBm]
2405	20.02
2440	20.20
2470	19.78

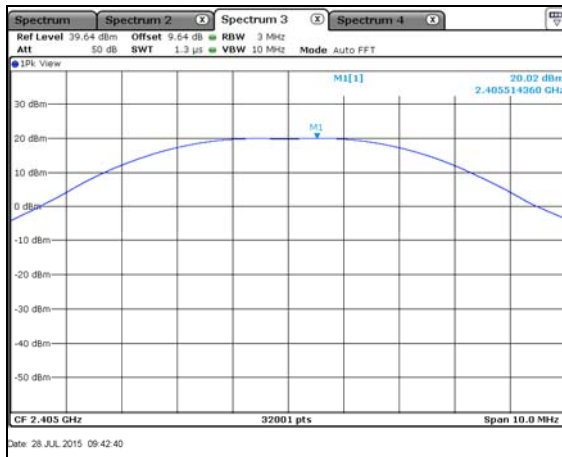

Figure 7.4.2-1: Output Power – LCH

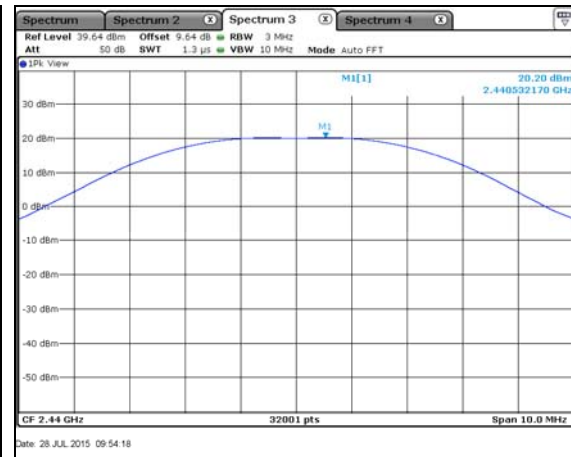

Figure 7.4.2-2: Output Power – MCH

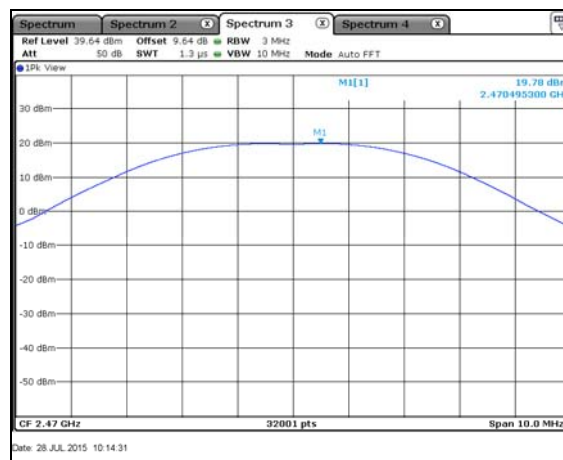

Figure 7.4.2-3: Output Power – HCH

7.5 Emission Levels – FCC 15.247(d), 15.205, 15.209; IC RSS-247 5.5, RSS-Gen 8.9

7.5.1 Emissions into Non-restricted Frequency Bands

7.5.1.1 Measurement Procedure

The unwanted emissions into non-restricted bands were measured conducted in accordance with FCC KDB 558074 D01 DTS Meas Guidance v03r03. The RF output of the equipment under test was directly connected to the input of the spectrum analyzer applying suitable attenuation. The Resolution Bandwidth (RBW) of the spectrum analyzer was set to 100 kHz. The Video Bandwidth (VBW) was set to 300 kHz. Span was set to 1.5 times the DTS bandwidth. The trace was set to max hold with a peak detector active. The resulting spectrum analyzer peak level was used to determine the reference level with respect to the 20 dBc limit. The spectrum span was then adjusted for the measurement of spurious emissions from 30MHz to 25GHz, 10 times the highest fundamental frequency.

Band-edge compliance was determined using the conducted marker-delta method in which the radio frequency power that is produced by the EUT is at least 20 dB below that in the 100 kHz bandwidth within the band that contains the highest level of desired power.

7.5.1.2 Measurement Results

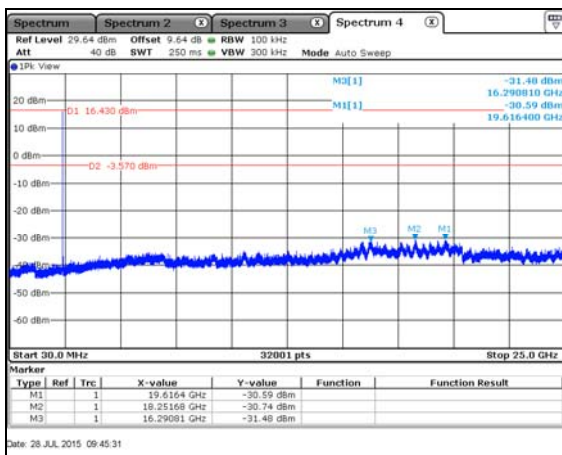

Figure 7.5.1.2-1: 30 MHz – 25 GHz – LCH

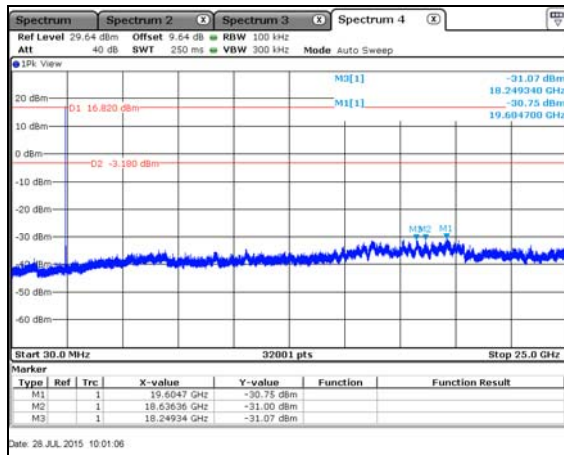

Figure 7.5.1.2-2: 30 MHz – 25 GHz – MCH

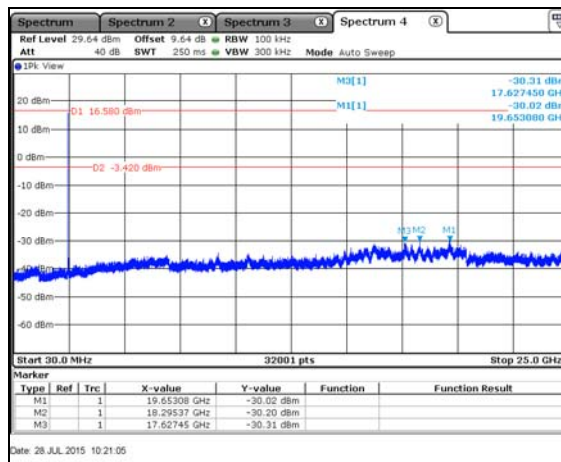

Figure 7.5.1.2-3: 30 MHz – 25 GHz – HCH

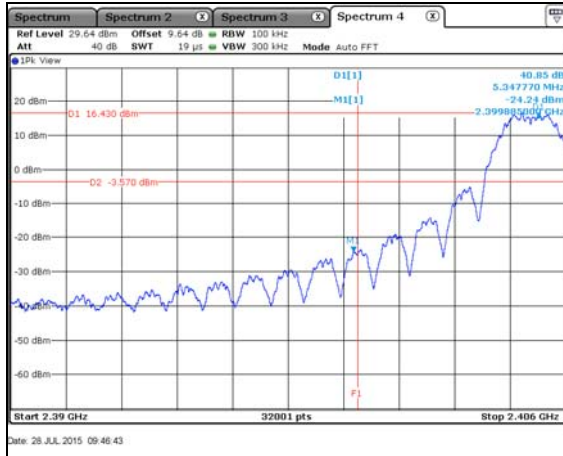

Figure 7.5.1.2-4: Lower Band-edge – LCH

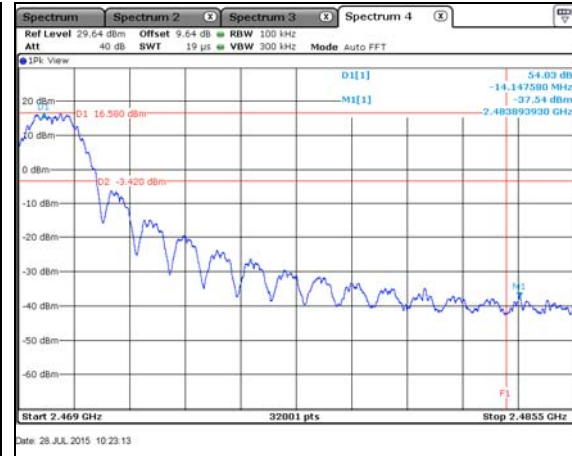

Figure 7.5.1.2-5: Upper Band-edge – HCH

7.5.2 Emissions into Restricted Frequency Bands - FCC 15.205, 15.209; RSS-Gen 8.9/8.10

7.5.2.1 Measurement Procedure

The unwanted emissions into restricted bands were measured radiated over the frequency range of 30MHz to 25GHz, 10 times the highest fundamental frequency.

The EUT was rotated through 360° and the receive antenna height was varied from 1m to 4m so that the maximum radiated emissions level would be detected. For frequencies below 1000MHz, quasi-peak measurements were made using a resolution bandwidth RBW of 120 kHz and a video bandwidth VBW of 300 kHz. For frequencies above 1000MHz, peak and average measurements were made with RBW and VBW of 1 MHz and 3 MHz respectively.

Each emission found to be in a restricted band as defined by section 15.205, including any emission at the operational band-edge, was compared to the radiated emission limits as defined in section 15.209.

7.5.2.2 Duty Cycle Correction

For average radiated measurements, using a 66% duty cycle, the measured level was reduced by a factor 3.61dB. The duty cycle correction factor is determined using the formula: $20\log(66/100) = -3.61\text{dB}$. A detailed analysis of the duty cycle timing is provided in the Theory of Operation accompanying the application for certification.

7.5.2.3 Measurement Results

Table 7.5.2.3-1: Radiated Spurious Emissions Tabulated Data – X-orientation

Frequency (MHz)	Level (dBuV)		Antenna Polarity (H/V)	Correction Factors (dB)	Corrected Level (dBuV/m)		Limit (dBuV/m)		Margin (dB)	
	pk	Qpk/Avg			pk	Qpk/Avg	pk	Qpk/Avg	pk	Qpk/Avg
Low Channel										
2390	60.43	52.33	H	-6.59	53.84	42.13	74.0	54.0	20.2	11.9
2390	53.75	44.07	V	-6.59	47.16	33.87	74.0	54.0	26.8	20.1
Middle Channel										
No emissions detected above the noise floor of the measurement system.										
High Channel										
2483.5	63.71	55.25	H	-6.08	57.63	45.56	74.0	54.0	16.4	8.4
2483.5	56.09	46.84	V	-6.08	50.01	37.15	74.0	54.0	24.0	16.8

Table 7.5.2.3-2: Radiated Spurious Emissions Tabulated Data – Y-orientation

Frequency (MHz)	Level (dBuV)		Antenna Polarity (H/V)	Correction Factors (dB)	Corrected Level (dBuV/m)		Limit (dBuV/m)		Margin (dB)	
	pk	Qpk/Avg			pk	Qpk/Avg	pk	Qpk/Avg	pk	Qpk/Avg
Low Channel										
2390	58.16	48.64	H	-6.59	51.57	38.44	74.0	54.0	22.4	15.6
2390	58.04	47.83	V	-6.59	51.45	37.63	74.0	54.0	22.6	16.4
Middle Channel										
No emissions detected above the noise floor of the measurement system.										
High Channel										
2483.5	59.16	50.62	H	-6.08	53.08	40.93	74.0	54.0	20.9	13.1
2483.5	59.47	50.32	V	-6.08	53.39	40.63	74.0	54.0	20.6	13.4

Table 7.5.2.3-3: Radiated Spurious Emissions Tabulated Data – Z-orientation

Frequency (MHz)	Level (dBuV)		Antenna Polarity (H/V)	Correction Factors (dB)	Corrected Level (dBuV/m)		Limit (dBuV/m)		Margin (dB)	
	pk	Qpk/Avg			pk	Qpk/Avg	pk	Qpk/Avg	pk	Qpk/Avg
Low Channel										
2390	58.47	49.96	H	-6.59	51.88	39.76	74.0	54.0	22.1	14.2
2390	59.43	50.70	V	-6.59	52.84	40.50	74.0	54.0	21.2	13.5
Middle Channel										
No emissions detected above the noise floor of the measurement system.										
High Channel										
2483.5	62.05	52.30	H	-6.08	55.97	42.61	74.0	54.0	18.0	11.4
2483.5	62.86	52.25	V	-6.08	56.78	42.56	74.0	54.0	17.2	11.4
12350	51.83	41.58	H	16.32	68.15	54.29	83.5	63.5	15.3	9.2
12350	50.92	40.64	V	16.32	67.24	53.35	83.5	63.5	16.3	10.2

7.5.2.4 Sample Calculation:

$$R_C = R_U + CF_T$$

Where:

CF_T	=	Total Correction Factor (AF+CA+AG)-DC (Average Measurements Only)
R_U	=	Uncorrected Reading
R_C	=	Corrected Level
AF	=	Antenna Factor
CA	=	Cable Attenuation
AG	=	Amplifier Gain
DC	=	Duty Cycle Correction Factor

Example Calculation: PeakCorrected Level: $58.47 - 6.59 = 51.88\text{dBuV/m}$ Margin: $74.0\text{dBuV/m} - 51.88\text{dBuV/m} = 22.1\text{dB}$ **Example Calculation: Average**Corrected Level: $49.96 - 6.59 - 3.61 = 39.76\text{dBuV}$ Margin: $54.0\text{dBuV} - 39.76\text{dBuV} = 14.2\text{dB}$

7.6 Maximum Power Spectral Density in the Fundamental Emission – FCC 15.247(e) IC: RSS-247 5.2(2)

7.6.1 Measurement Procedure

The power spectral density was measured in accordance with the FCC KDB 558074 D01 DTS Meas Guidance v03r03 utilizing the PKPSD method. The RF output of the equipment under test was directly connected to the input of the spectrum analyzer applying suitable attenuation. The Resolution Bandwidth (RBW) of the spectrum analyzer was set to 3 kHz. The Video Bandwidth (VBW) was set to 10 kHz. Span was set to 1.5 times the occupied bandwidth. A peak detector was used.

7.6.2 Measurement Results

Table 7.6.2-1: Peak Power Spectral Density

Frequency (MHz)	PSD Level (dBm)
2405	5.74
2440	5.99
2470	5.36

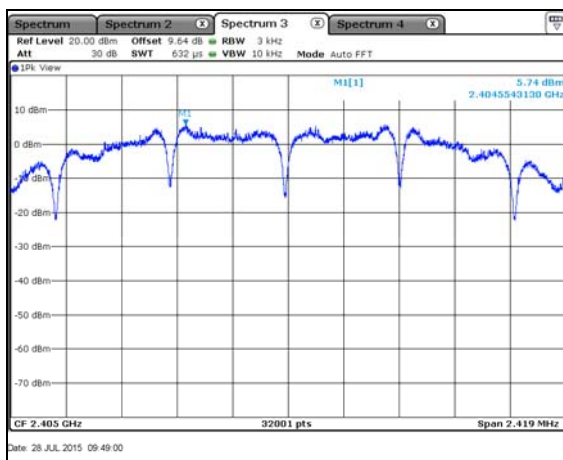

Figure 7.6.2-1: PSD Plot – LCH

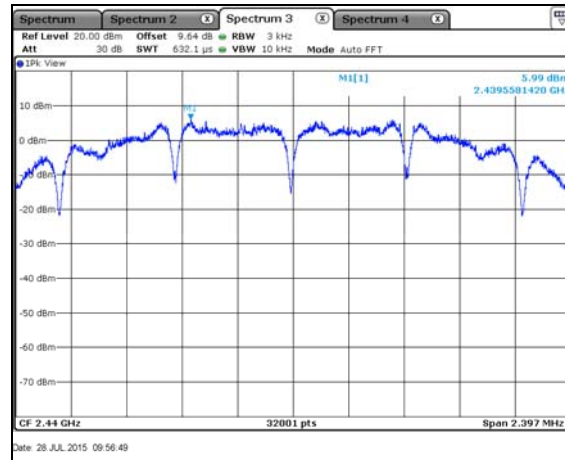

Figure 7.6.2-2: PSD Plot – MCH

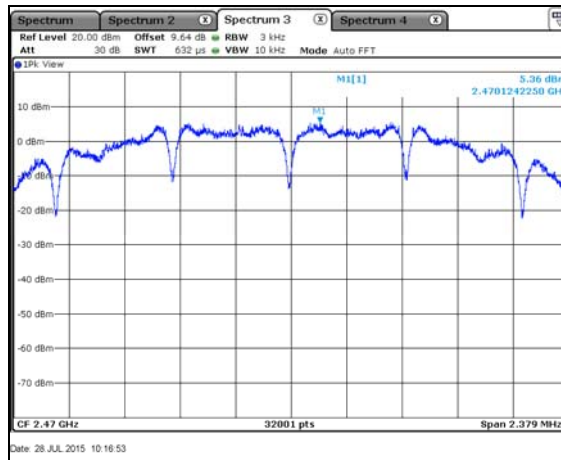

Figure 7.6.2-3: PSD Plot – HCH

8 CONCLUSION

In the opinion of ACS, Inc. the REXUAI, provided by Elster Solutions, LLC, meets the requirements of FCC Part 15 subpart C and Industry Canada's Radio Standards Specification RSS-247.

END REPORT