

Electromagnetic Compatibility Test Report

Prepared in accordance with

FCC Part 15C, RSS-210 Issue 8

On

Water Meter

EA2W

**Elster Solutions, LLC
208 South Rogers Lane
Raleigh, NC 27610**





Prepared by:

TUV Rheinland of North America, Inc.

The test results contained in this report refer exclusively to the product(s) presented for testing. No liability may be assumed for models or products not referred to herein. This test report may not be published or duplicated in part without permission of the testing body. This test report by itself does not constitute authorization for the use of any TUV Rheinland test mark. The report must not be used by the client to claim product certification, approval, or endorsement by NVLAP, NIST, or any agency of the Federal Government.

Report No.:
31161542.001 C2PC

Page 2 of 37

Client:		Elster Solutions, LLC 208 South Rogers Lane Raleigh, NC 27610	John Holt 919-250-5557 / 919-250-5486 john.holt@us.elster.com
Identification:	Water Meter	Serial No.:	Production Sample
Test item:	EA2W	Date tested:	14 June 2011
Testing location:	TUV Rheinland of North America 762 Park Avenue Youngsville, NC 27596-9470 U.S.A.	Tel: (919) 554-3668 Fax: (919) 554-3542	
Test specification:	Emissions: FCC Part 15, Subpart C, RSS-210 Issue 8: FCC Part 15.207(a) and RSS-210 FCC Parts 15.205, 15.209, 15.215(c), RSS-210 FCC Part 15.247(a)(1)(i) and RSS-210 A1.1.3, FCC Part 15.247 and RSS-210 Annex 8, FCC Part 15.247(a)(1)(i), RSS-210, Section A8.1 and Section A1.1.3, FCC Part 15.247(a)(1) and RSS-210 A8.1(c), FCC Part 15.247(b)(2) and RSS-210 A8.4(1), FCC Part 15.247(g) and RSS-210 A8.1, FCC Part 15.247(h) and RSS-210 A8.1, FCC Parts 15.109(a) and ICES-003 and FCC Part 15.107(a) and ICES-003		
Test Result	The above product was found to be Compliant to the above test standard(s)		
tested by: Mark Ryan		reviewed by: Michael Moranha	
 17 June 2011 _____ <i>Signature</i>		 21 June 2011 _____ <i>Signature</i>	
Other Aspects:	None		
Abbreviations: OK, Pass, Compliant, Complies = passed Fail, Not Compliant, Does Not Comply = failed N/A = not applicable			
 90552 and 100881		 NVLAP Lab Code (200094-0)	
		Industry Canada IC-2932H	

The test results contained in this report refer exclusively to the product(s) presented for testing. No liability may be assumed for models or products not referred to herein. This test report may not be published or duplicated in part without permission of the testing body. This test report by itself does not constitute authorization for the use of any TUV Rheinland test mark. The report must not be used by the client to claim product certification, approval, or endorsement by NVLAP, NIST, or any agency of the Federal Government.

TABLE OF CONTENTS

1	GENERAL INFORMATION	4
1.1	SCOPE	4
1.2	PURPOSE	4
1.3	SUMMARY OF TEST RESULTS	5
2	LABORATORY INFORMATION	6
2.1	ACCREDITATIONS AND ENDORSEMENTS	6
2.2	MEASUREMENT UNCERTAINTY EMISSIONS	7
2.3	CALIBRATION TRACEABILITY	7
2.4	MEASUREMENT EQUIPMENT USED	8
3	PRODUCT INFORMATION	9
3.1	CLASS 2 PERMISSIVE CHANGE DESCRIPTION	9
3.2	EQUIPMENT MODIFICATIONS	12
4	SPURIOUS EMISSIONS	13
4.1	SPURIOUS EMISSIONS OUTSIDE THE BAND	13
4.1	CONDUCTED EMISSIONS IN TRANSMIT MODE	19
4.2	FREQUENCY HOPPING SPREAD SPECTRUM (FHSS) SYSTEMS FCC PART 15.247(G)	20
4.3	INCORPORATION OF INTELLIGENCE WITHIN A FHSS SYSTEM FCC PART 15.247(H)	20
5	ANTENNA PORT CONDUCTED EMISSIONS	21
5.1	CHANNEL SEPARATION	21
5.2	PSEUDORANDOM HOPPING ALGORITHM	21
5.3	OCCUPIED BANDWIDTH	22
5.4	99% POWER BANDWIDTH	25
5.5	BAND EDGE	27
5.6	PEAK OUTPUT POWER	30
6	EMISSIONS IN RECEIVE MODE	32
6.1	RADIATED EMISSIONS	32
6.2	CONDUCTED EMISSIONS	37

The test results contained in this report refer exclusively to the product(s) presented for testing. No liability may be assumed for models or products not referred to herein. This test report may not be published or duplicated in part without permission of the testing body. This test report by itself does not constitute authorization for the use of any TÜV Rheinland test mark. The report must not be used by the client to claim product certification, approval, or endorsement by NVLAP, NIST, or any agency of the Federal Government.

1 General Information

1.1 Scope

This report is intended to document the status of conformance with the requirements of the FCC Part 15C, RSS-210 Issue 8 based on the results of testing performed on 14 June 2011 on the Water Meter, Model No. EA2W, manufactured by Elster Solutions, LLC. This report only applies to the specific samples tested under the stated test conditions. It is the responsibility of the manufacturer to assure that additional production units of this model are manufactured with identical or EMI equivalent electrical and mechanical components. This report is further intended to document changes and modifications to the EUT throughout its life cycle. All documentation will be included as a supplement.

1.2 Purpose

Testing was performed to evaluate the EMC performance of the EUT (Equipment Under Test) in accordance with the applicable requirements, procedures, and criteria defined in the application of regulations and application of standards listed in this report.

The test results contained in this report refer exclusively to the product(s) presented for testing. No liability may be assumed for models or products not referred to herein. This test report may not be published or duplicated in part without permission of the testing body. This test report by itself does not constitute authorization for the use of any TUV Rheinland test mark. The report must not be used by the client to claim product certification, approval, or endorsement by NVLAP, NIST, or any agency of the Federal Government.

1.3 Summary of Test Results

Applicant	Elster Solutions, LLC 208 South Rogers Lane Raleigh, NC 27610	Tel	919-250-5557	Contact	John Holt
		Fax	919-250-5486	e-mail	john.holt@us.elster.com
Description	Water Meter	Model Number	EA2W		
Serial Number	Production Sample	Test Voltage/Freq.	3.6V DC Battery		
Test Date Completed:	14 June 2011	Test Engineer	Mark Ryan		
Standards	Description	Severity Level or Limit		Criteria	Test Result
FCC Part 15, Subpart C Standard	Radio Frequency Devices-Subpart C: Intentional Radiators	See called out basic standards below		See Below	Complies
RSS-210 Issue 8 Standard	Low-Power Licence-exempt Radiocommunication Devices Category I Equipment	See called out basic standards below		See Below	Complies
FCC Parts 15.205, 15.209, 15.215(c), RSS-210	Radiated Emissions EUT in Transmit Mode	Below limit of sections 15.205, 15.209(a) and 15.215(c)		41.1 dB μ V	Complies
FCC Part 15.207(a) and RSS-210	Conducted Emissions on Mains EUT in Transmit Mode	EUT is Battery operated only.		NA	Not Applicable
FCC Part 15.247 and RSS-210 Annex 8	Operation within the band 902-928 MHz	See called out basic standards below		--	Complies
FCC Part 15.247(a)(1)(i), RSS-210, Section A8.1	Channel Separation	minimum 25kHz or 20dB Channel Band Width (which ever is greater)		400 kHz	Complies
FCC Part 15.247(a)(1) and RSS-210 A8.1(c)	Pseudorandom Hopping Algorithm	25 hopping channels when the BW \geq 250kHz		See operation description	Complies
FCC Part 15.247(a)(1)(i) and RSS-210 A1.1.3	Occupied Bandwidth	20dB \leq 500 kHz 99% BW \leq 500 kHz		459 kHz 463 kHz	Complies
FCC Part 15.247(d) and RSS-210 A8.5	Band Edge	Ensure 20dB bandwidth is Contained within the Frequency Band		>20dB BW is contained	Complies
FCC Part 15.247(b)(2) and RSS-210 A8.4(1)	Transmitter Output Power	Shall not exceed 0.25 Watts		0.227 W	Complies
FCC Part 15.247(g) and RSS-210 A8.1	Frequency Hopping Spread Spectrum (FHSS) Systems	Description of Hopping System		See operation description	Complies
FCC Part 15.247(h) and RSS-210 A8.1	Incorporation of Intelligence within a FHSS System	Not Applicable: EUT does not incorporate hopping intelligence		NA	Not Applicable
FCC Parts 15.109(a) and ICES-003	Radiated Emissions while EUT in Receive Mode	Below limit of section 15.109(a) Class B		32.9 dB μ V	Complies
FCC Part 15.107(a) and ICES-003	Conducted Emissions EUT in Receive Mode	EUT is Battery operated only.		NA	Not Applicable

The test results contained in this report refer exclusively to the product(s) presented for testing. No liability may be assumed for models or products not referred to herein. This test report may not be published or duplicated in part without permission of the testing body. This test report by itself does not constitute authorization for the use of any TUV Rheinland test mark. The report must not be used by the client to claim product certification, approval, or endorsement by NVLAP, NIST, or any agency of the Federal Government.

2 Laboratory Information

2.1 Accreditations and Endorsements

2.1.1 US Federal Communications Commission

TUV Rheinland of North America located at 762 Park Avenue, Youngsville, NC 27596-9470 is accredited by the commission for performing testing services for the general public on a fee basis. This laboratory test facilities have been fully described in reports submitted to and accepted by the FCC (Registration No 90552 and 100881). The laboratory scope of accreditation includes: Title 47 CFR Part 15, and 18. The accreditation is updated every 3 years.

2.1.2 NIST / NVLAP

Program, which is administered under the auspices of the National Institute of Standards and Technology. The laboratory has been assessed and accredited in accordance with ISO Standard 17025:2005 (Lab code: 200094-0). The scope of laboratory accreditation includes emission and immunity testing. The accreditation is updated annually.

2.1.3 Industry Canada

Registration No.: IC-2932H The OATS has been accepted by Industry Canada to perform testing to 3 and to 10m, based on the test procedures described in ANSI C63.10:2009.

2.1.4 Japan – VCCI

The Voluntary Control Council for Interference by Information Technology Equipment (VCCI) is a group that consists of Information Technology Equipment (ITE) manufacturers and EMC test laboratories. The purpose of the Council is to take voluntary control measures against electromagnetic interference from Information Technology Equipment, and thereby contribute to the development of a socially beneficial and responsible state of affairs in the realm of Information Technology Equipment in Japan. TUV Rheinland at the 762 Park Ave. Youngsville, N.C 27596 address has been assessed and approved in accordance with the Regulations for Voluntary Control Measures. (Registration No. R-1174, R-1679, C-1790 and C-1791).

The test results contained in this report refer exclusively to the product(s) presented for testing. No liability may be assumed for models or products not referred to herein. This test report may not be published or duplicated in part without permission of the testing body. This test report by itself does not constitute authorization for the use of any TUV Rheinland test mark. The report must not be used by the client to claim product certification, approval, or endorsement by NVLAP, NIST, or any agency of the Federal Government.

2.1.5 Sample Calculation – radiated & conducted emissions

The field strength is calculated by subtracting the Amplifier Gain and adding the Cable Loss and Antenna Correction Factor to the measured reading. The basic equation is as follows:

$$\text{Field Strength (dB}\mu\text{V/m)} = \text{RAW} - \text{AMP} + \text{CBL} + \text{ACF}$$

Where: RAW = Measured level before correction (dB μ V)

AMP = Amplifier Gain (dB)

CBL = Cable Loss (dB)

ACF = Antenna Correction Factor (dB/m)

$$\mu\text{V/m} = 10^{\frac{\text{dB}\mu\text{V/m}}{20}}$$

Sample radiated emissions calculation @ 30 MHz

Measurement +Antenna Factor–Amplifier Gain+Cable loss=Radiated Emissions (dBuV/m)

$$25 \text{ dBuV/m} + 17.5 \text{ dB} - 20 \text{ dB} + 1.0 \text{ dB} = 23.5 \text{ dBuV/m}$$

2.2 Measurement Uncertainty Emissions

	U_{lab}	U_{cispr}
Radiated Disturbance @ 10m		
30 MHz – 1,000 MHz	3.3 dB	5.2 dB
Conducted Disturbance @ Mains Terminals		
150 kHz – 30 MHz	1.18 dB	3.6 dB
Disturbance Power		
30 MHz – 300 MHz	3.88 dB	4.5 dB

2.3 Calibration Traceability

All measurement instrumentation is traceable to the National Institute of Standards and Technology (NIST). Measurement method complies with ANSI/NCSL Z540-1-1994 and ISO Standard 17025:2005. Equipment calibration records are kept on file at the test facility.

The test results contained in this report refer exclusively to the product(s) presented for testing. No liability may be assumed for models or products not referred to herein. This test report may not be published or duplicated in part without permission of the testing body. This test report by itself does not constitute authorization for the use of any TUV Rheinland test mark. The report must not be used by the client to claim product certification, approval, or endorsement by NVLAP, NIST, or any agency of the Federal Government.

Report No.:
31161542.001 C2PC

Page 8 of 37

2.4 Measurement Equipment Used

Equipment	Manufacturer	Model #	Serial/Inst #	Last Cal dd/mm/yy	Next Cal dd/mm/yy
Radiated and Conducted RF Emissions (5 Meter Chamber)					
Amplifier, preamp	Agilent Technologies	8449B	3008A01480	24-Feb-10	24-Feb-11
Antenna Horn 1-18GHz	EMCO	3115	2236	13-Dec10	13-Dec-12
Receiver, EMI	Rohde & Schwarz	ESIB40	100043	11-Jul-10	11-Jul-11
Cable, Coax	MicroCaox	MKR300C-0-0-1200-500500	002	16-Dec-10	16-Dec-11
Cable, Coax	Andrew	FSJ1-50A	003	16-Dec-10	16-Dec-11
Cable, Coax	Andrew	FSJ1-50A	030	16-Dec-10	16-Dec-11
Cable, Coax	Andrew	FSJ1-50A	045	16-Dec-10	16-Dec-11
Cable, Coax	Andrew	FSJ1-50A	049	16-Dec-10	16-Dec-11
1.5 GHz High Pass Filter	Bonn Elektronik	BHF 1500	025155	16-Feb-10	16-Feb-11
General Laboratory Equipment					
Meter, Multi	Fluke	179	90580752	06-Dec-10	06-Dec-11
Meter, Temp/Humid/Barom	Davis Instruments	7400	PB00205A05	1-Jan-11	1-Jan-12
Meter, Temp/Humid/Barom	Davis Instruments	7400	PB00205A13	1-Jan-11	1-Jan-12

The test results contained in this report refer exclusively to the product(s) presented for testing. No liability may be assumed for models or products not referred to herein. This test report may not be published or duplicated in part without permission of the testing body. This test report by itself does not constitute authorization for the use of any TÜV Rheinland test mark. The report must not be used by the client to claim product certification, approval, or endorsement by NVLAP, NIST, or any agency of the Federal Government.

3 Product Information

3.1 Class 2 Permissive Change Description

3.1.1 Product Description

The equipment under test is the Energy Axis Water Meter Transponder 2.0 (model EA2W) printed circuit board assembly for which Limited Modular Approval has been certified. The EA2W is typically installed in one of two plastic housings; the Remote and the Pit. The EA2W may be connected to one or two water meters through the Metering Interface Connector. Initially, the EUT will be tested as installed in a Remote housing. Moving the EA2W to the Pit housing is expected to be a Class I permissive change since the housings are plastic and no changes to the EUT circuit board will be needed. It is possible that moving to the Pit housing may detune the antenna slightly, requiring two matching component (capacitor or inductor) values to change in order to re-tune the antenna. These component values are changed at the factory and are not accessible to the end user.

A second consideration is that the devices are potted and cannot be reprogrammed afterward. This issue is mitigated by running wires for the programming signals out of the housing prior to potting. These wires are not normally present on the final product, so ferrites are installed on the wires to minimize their impact on emissions tests. The programming wires allow the test unit to be configured for constant transmit at each of four test frequencies required for Subpart C emissions tests, as well as for constant receive as required for Subpart B emissions testing. Remaining tests such as signal bandwidth, band edge power, output power and channel time of occupancy are measured via coax cable attached to an RF test connector and can be done on an un-potted unit that can be reconfigured as needed.

A third consideration is that the devices are battery powered with a very low duty cycle. It is unfeasible to use the device's internal battery for the continuous operation required in FCC testing because it would prematurely drain the device's 3.6 volt Lithium Thionyl Chloride battery. To circumvent this problem, a 6 volt lantern battery with a 3.6 volt linear regulator is supplied to power the EUTs. This battery/regulator is capable of powering the EUT in a continuous transmit test mode for over 72 hours. The test units will automatically enter into their pre-configured test modes when the 3.6 volt supply is connected.

EUT	Model Name	Elster Style Number
#24 – Remote housing, configurable for constant transmit and constant receive radiated testing.	EA2W (EA2W-I)	EW101100000
#20 – Remote housing, unpotted, configurable for conducted Subpart C testing.	EA2W (EA2W-I)	EW101100000

Table 1: EUT Designation

The test results contained in this report refer exclusively to the product(s) presented for testing. No liability may be assumed for models or products not referred to herein. This test report may not be published or duplicated in part without permission of the testing body. This test report by itself does not constitute authorization for the use of any TUV Rheinland test mark. The report must not be used by the client to claim product certification, approval, or endorsement by NVLAP, NIST, or any agency of the Federal Government.

3.1.2 Changes Resulting in Class 2 Permissive Change

A second receiver path has been added to the EA2W module. This second receiver operates at a single frequency, 451.35 MHz. This receiver is used for a Walk-by/Drive-by (WBDB) mode of operation. When WBDB operation is enabled, the module wakes up and turns on its receiver every 6 seconds to check for a wake-up tone at 451.35 MHz. If no wake-up tone is detected, the module goes back to sleep. If the wake-up tone is detected and demodulated, the module switches to 902-928 MHz ISM band operation to communicate with the handheld or vehicle-mounted device that issued the wake-up tone. The 902-928 MHz communication is the same as described in section **Error! Reference source not found.**

In order to add the second receiver path at 451.35 MHz, a new Front-End Module (FEM) is used in the EA2W module. The new FEM, the RFMD RF6549, has equivalent functionality and specifications to the original FEM, the RFMD RF6519, except that a switched bypass path has been added. For comparison, the block diagrams for the RF6519 (Figure 1) and RF6549 (Figure 2) are included.

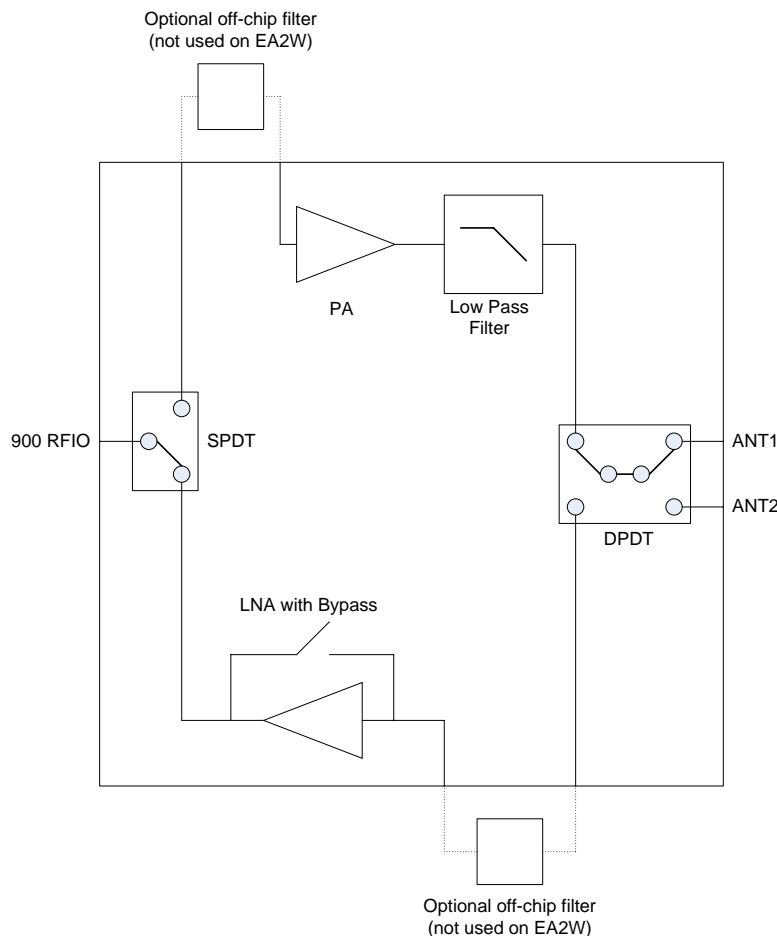

Figure 1: RF6519 (Original FEM) Block Diagram

The test results contained in this report refer exclusively to the product(s) presented for testing. No liability may be assumed for models or products not referred to herein. This test report may not be published or duplicated in part without permission of the testing body. This test report by itself does not constitute authorization for the use of any TUV Rheinland test mark. The report must not be used by the client to claim product certification, approval, or endorsement by NVLAP, NIST, or any agency of the Federal Government.

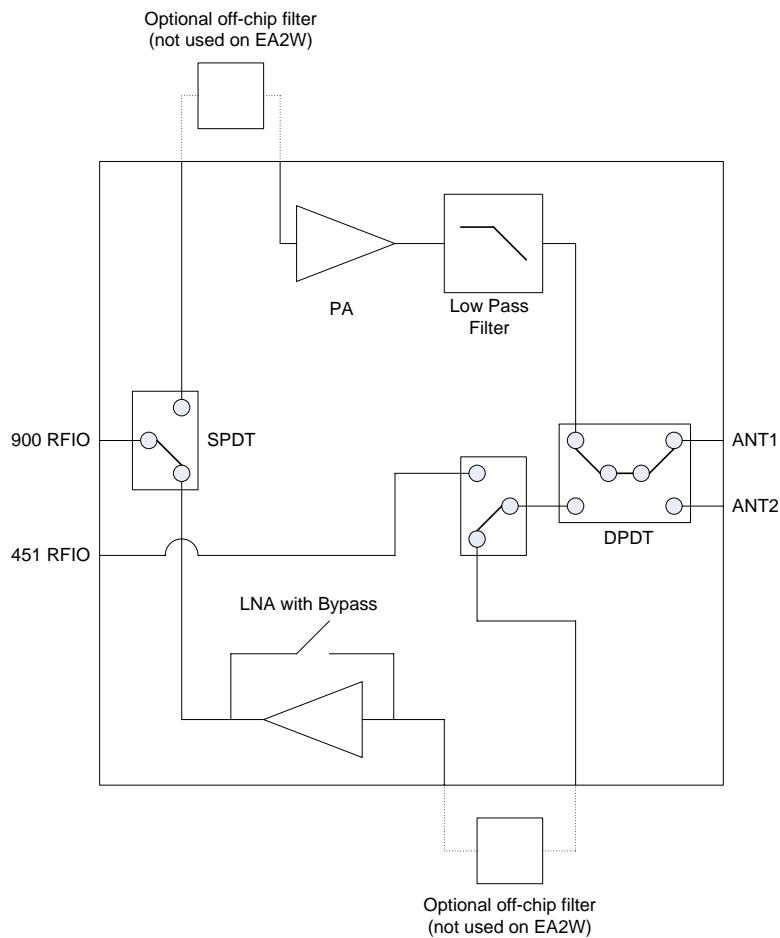

Figure 2: RF6549 (New FEM) Block Diagram

Since the CC1101 Transceiver has a single TX/RX port, it is necessary to combine the 451.35 MHz and 902-928 MHz IO ports of the RF6549 FEM. This has been done on the EA2W using a discrete diplexer circuit, which is also covered under this Class 2 permissive change.

The test results contained in this report refer exclusively to the product(s) presented for testing. No liability may be assumed for models or products not referred to herein. This test report may not be published or duplicated in part without permission of the testing body. This test report by itself does not constitute authorization for the use of any TUV Rheinland test mark. The report must not be used by the client to claim product certification, approval, or endorsement by NVLAP, NIST, or any agency of the Federal Government.

3.1.3 Device Type

The Internal EA2W is an intentional radiator and is classified as a Part 15.247 device. The critical specifications of the EA2W are listed in the following table:

Frequency Band – EA2W	902.8 – 927.6 MHz
Frequency Band – EA2W-I	916.0 – 927.6 MHz
Frequency – Receive Only	451.35 MHz
Classification	Frequency Hopping Spread Spectrum
Maximum Output Power (902 – 928 MHz only)	0.25W (+24 dBm)
Channel Spacing	400 kHz
Channel 20 dB Bandwidth	325 kHz
Number of Channels	25
Max channel dwell time within a 10 second period	< 0.4 seconds

Table 2: Specifications

3.2 Equipment Modifications

No modifications were needed to bring product into compliance.

The test results contained in this report refer exclusively to the product(s) presented for testing. No liability may be assumed for models or products not referred to herein. This test report may not be published or duplicated in part without permission of the testing body. This test report by itself does not constitute authorization for the use of any TÜV Rheinland test mark. The report must not be used by the client to claim product certification, approval, or endorsement by NVLAP, NIST, or any agency of the Federal Government.

4 Spurious Emissions

4.1 Spurious Emissions Outside the band

In any 100kHz bandwidth outside the frequency band in which the spread spectrum or digitally modulated intentional radiator is operating, the radio frequency power that is produced by the intentional radiator shall be at least 20 dB below that in the 100 kHz bandwidth within the band that contains the highest level of desired power, based on either RF conducted or radiated measurements. Conducted antenna port measurements are provided below to show that the EUT meets these requirements at the band edges.

4.1.1 Over View of Test

Results	Complies (as tested per this report)					Date	9-10 June 2011	
Standard	FCC Parts 15.205, 15.209, 15.215 and RSS-210							
Product Model	EA2W				Serial#	Production Sample		
Test Set-up	Tested in a 5m Semi Anechoic chamber, placed on a 1.0m x 1.5m non-conductive table 80cm above the ground plane on a turn-table. See test plans for details							
EUT Powered By	3.6V DC Battery	Temp	75° F	Humidity	35%	Pressure	1005 mbar	
Perf. Criteria	(Below Limit)			Perf. Verification	Readings Under Limit			
Mod. to EUT	None			Test Performed By	Mark Ryan			

4.1.2 Test Procedure

Testing was performed in accordance with 47 CFR Part 15, ANSI C63.10:2009, RSS-GEN Issue 2. These test methods are listed under the laboratory's NVLAP Scope of Accreditation. This test measures the levels emanating from the EUT, thus evaluating the potential for the EUT to cause radio frequency interference to other electronic devices.

4.1.3 Deviations

There were no deviations from the test methodology listed in the test plan for the radiated emission test.

4.1.4 Final Test

All final radiated spurious emissions measurements were below (in compliance) the limits.

The worst –case emissions are shown below. All other emissions are on file at TUV Rheinland.

The test results contained in this report refer exclusively to the product(s) presented for testing. No liability may be assumed for models or products not referred to herein. This test report may not be published or duplicated in part without permission of the testing body. This test report by itself does not constitute authorization for the use of any TUV Rheinland test mark. The report must not be used by the client to claim product certification, approval, or endorsement by NVLAP, NIST, or any agency of the Federal Government.

4.1.4.1 Emissions Outside the Frequency Band

In any 100kHz bandwidth outside the frequency band in which the spread spectrum or digitally modulated intentional radiator is operating, the radio frequency power that is produced by the intentional radiator shall be at least 20 dB below that in the 100 kHz bandwidth within the band that contains the highest level of desired power, based on either RF conducted or radiated measurements. Conducted antenna port measurements are provided below to show that the EUT meets these requirements at the band edges.

Three orientations of the EUT investigated for highest emissions:

Emission Freq (MHz)	ANT Polar (H/V)	ANT Pos (m)	Table Pos (deg)	QP FIM Value (dBuV)	Amp Gain (dB)	Cable Loss (dB)	ANT Factor (dB/m)	E-Field Value (dBuV/m)	Orientation
CH 48:									
921.60	H	1.3	313	92.75	0.00	3.45	22.40	118.61	1
921.60	V	2.2	13	88.57	0.00	3.45	22.40	114.43	1
621.60	H	1.2	193	92.35	0.00	2.78	19.57	114.70	2
921.60	V	1.3	22	90.33	0.00	3.45	22.40	116.19	2
921.60	H	1.2	121	91.28	0.00	3.45	22.40	117.14	3
921.60	V	1.0	166	95.29	0.00	3.45	22.40	121.15	3

NOTE: Orientation 3 of CH 48 produced the highest emissions.

Red Emissions are Orientation 1, Green Emissions are Orientation 2, and Blue Emissions are Orientation 3

The test results contained in this report refer exclusively to the product(s) presented for testing. No liability may be assumed for models or products not referred to herein. This test report may not be published or duplicated in part without permission of the testing body. This test report by itself does not constitute authorization for the use of any TÜV Rheinland test mark. The report must not be used by the client to claim product certification, approval, or endorsement by NVLAP, NIST, or any agency of the Federal Government.

Radiated Emissions – 30 MHz to 1000 MHz

Horizontal Ch 48

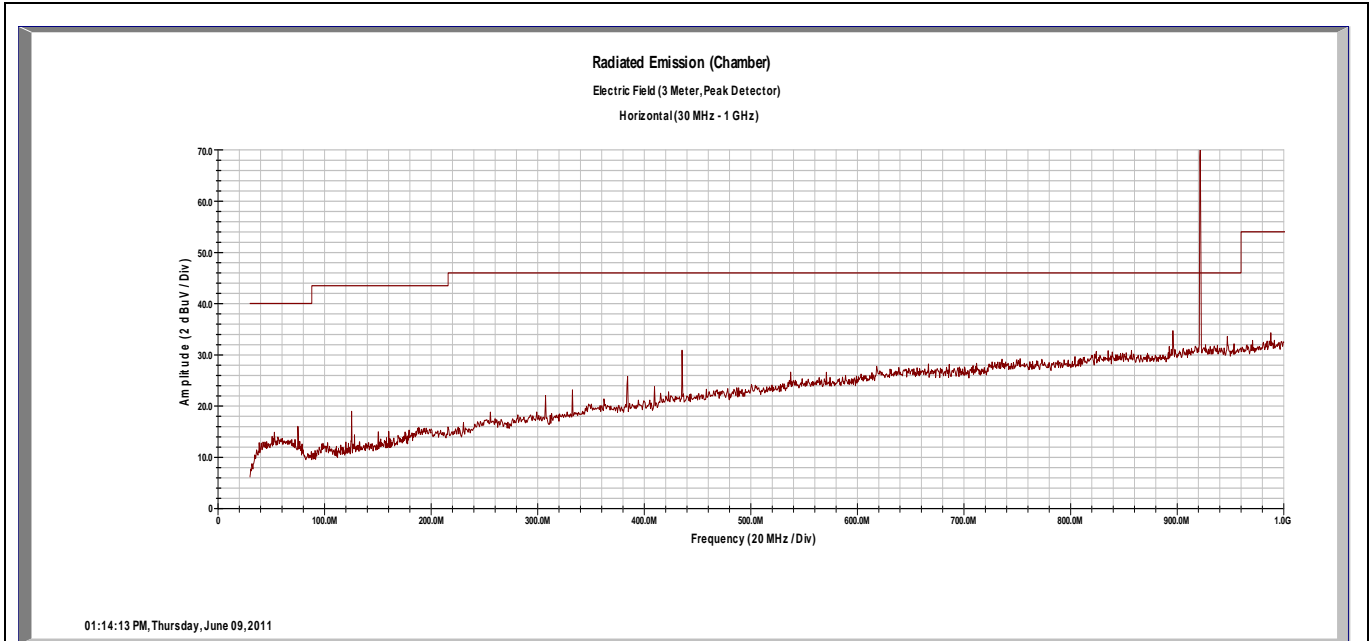

Emission Freq (MHz)	ANT Polar (H/V)	ANT Pos (m)	Table Pos (deg)	FIM Value (dBuV)	Amp Gain (dB)	Cable Loss (dB)	ANT Factor (dB/m)	E-Field Value (dBuV/m)	Spec Limit (dBuV/m)	Spec Margin (dB)
435.20	H	1	160	11.87	0.00	2.30	16.79	30.95	47.00	-16.05
921.60	H	1.2	121	91.28	0.00	3.45	22.40	117.14	NA	NA
921.60	H	1.2	121	90.18	0.00	3.45	22.40	116.04	NA	NA
921.60	H	1.5	121	84.29	0.00	3.45	22.40	110.15	NA	NA

Notes: The Plot was taken with a notch filter tuned at the fundamental frequency
 Except for the fundamental frequency, a notch filter was used for all measurements Using the QP detector.
 The Fundamental frequency was measured without the notch filter and used the **Pk**, **QP** and **Av** detectors.
 These values are used as the reference level (-20dBc) for the harmonic measurements, not in a restricted band.

The test results contained in this report refer exclusively to the product(s) presented for testing. No liability may be assumed for models or products not referred to herein. This test report may not be published or duplicated in part without permission of the testing body. This test report by itself does not constitute authorization for the use of any TUV Rheinland test mark. The report must not be used by the client to claim product certification, approval, or endorsement by NVLAP, NIST, or any agency of the Federal Government.

Radiated Emissions – 30 MHz to 1000 MHz

Vertical Ch 48

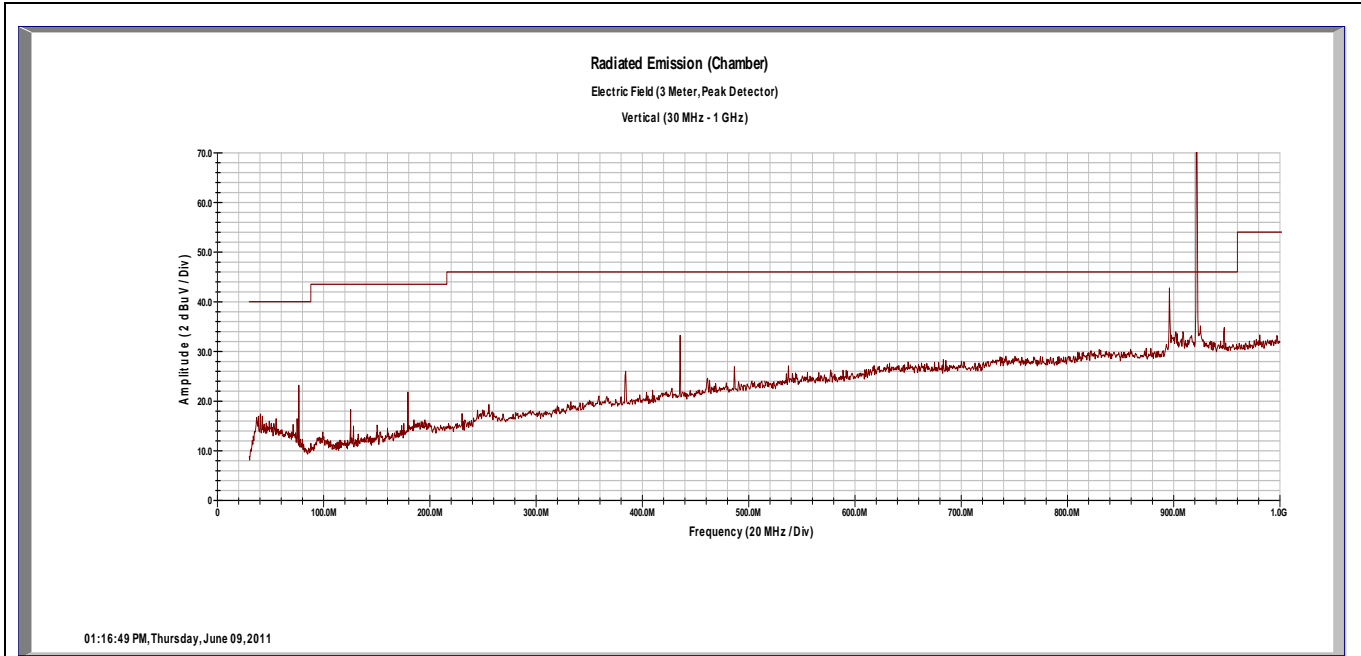

Emission Freq (MHz)	ANT Polar (H/V)	ANT Pos (m)	Table Pos (deg)	FIM Value (dBuV)	Amp Gain (dB)	Cable Loss (dB)	ANT Factor (dB/m)	E-Field Value (dBuV/m)	Spec Limit (dBuV/m)	Spec Margin (dB)
435.20	V	1.2	27	14.32	0.00	2.30	16.79	33.40	47.00	-13.60
921.60	V	1.0	166	95.29	0.00	3.45	22.40	121.15	NA	NA
921.60	V	1.0	166	94.84	0.00	3.45	22.40	120.70	NA	NA
921.60	V	1.0	166	88.97	0.00	3.45	22.40	114.83	NA	NA

Notes: The Plot was taken with a notch filter tuned at the fundamental frequency
Except for the fundamental frequency, a notch filter was used for all measurements Using the QP detector.

The Fundamental frequency was measured without the notch filter and used the **Pk**, **QP** and **Av** detectors.
These values are used as the reference level (-20dBc) for the harmonic measurements, not in a restricted band.

The test results contained in this report refer exclusively to the product(s) presented for testing. No liability may be assumed for models or products not referred to herein. This test report may not be published or duplicated in part without permission of the testing body. This test report by itself does not constitute authorization for the use of any TUV Rheinland test mark. The report must not be used by the client to claim product certification, approval, or endorsement by NVLAP, NIST, or any agency of the Federal Government.

Radiated Emissions – 1 GHz to 10 GHz
Horizontal CH 48

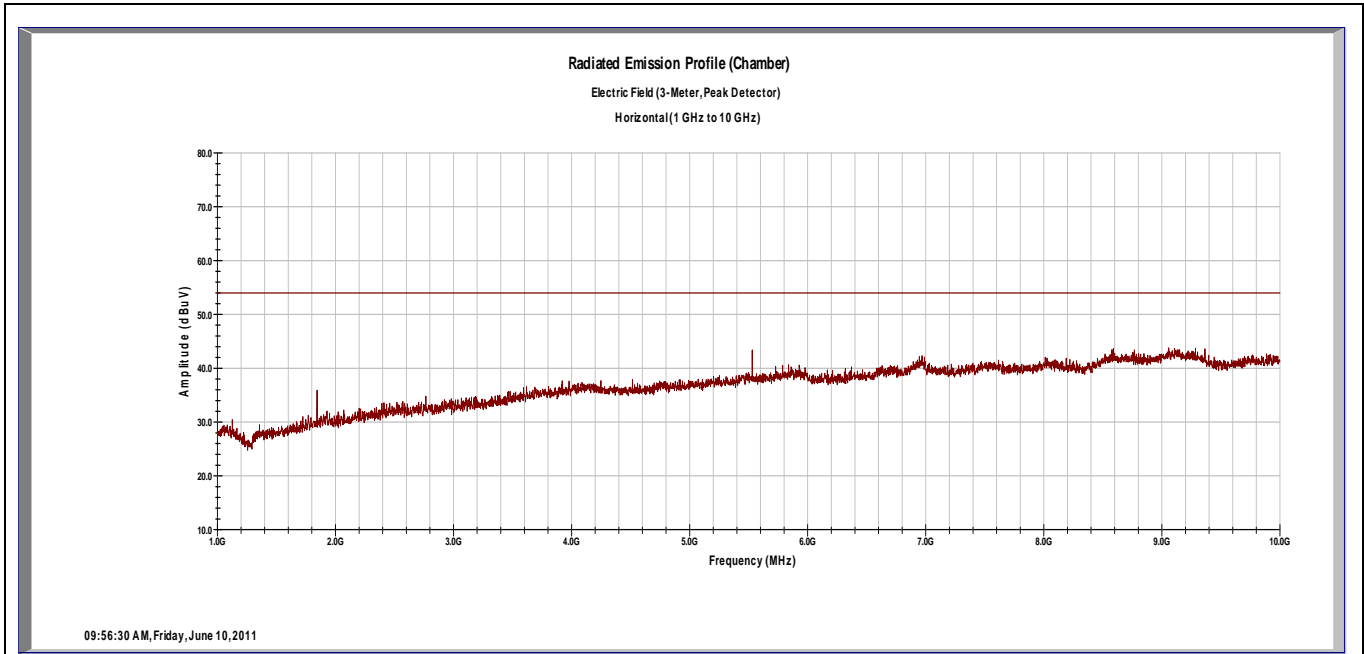

Emission Freq (MHz)	ANT Polar (H/V)	ANT Pos (m)	Table Pos (deg)	FIM Value (dBuV)	Amp Gain (dB)	Cable Loss (dB)	ANT Factor (dB/m)	E-Field Value (dBuV/m)	Spec Limit (dBuV/m)	Spec Margin (dB)
1843.20	H	1.3	333	34.72	34.75	6.81	27.25	34.03	54.00	-19.97
5529.60	H	1	243	28.44	34.11	12.34	34.44	41.11	54.00	-12.89
1843.20	H	1.3	333	44.18	34.75	6.81	27.25	43.49	74.00	-30.51
5529.60	H	1	243	39.43	34.11	12.34	34.44	52.10	74.00	-21.90

Notes: Notes: CH 48 – 921.6 MHz High Pass Filter used
Emissions shown in Green are using the Average Detector and shown in Blue are using the Peak Detector
The Highlighted emission is worst case
All emissions, including those that are inside the restricted bands, are either at or below the noise floor of the Spectrum Analyzer

The test results contained in this report refer exclusively to the product(s) presented for testing. No liability may be assumed for models or products not referred to herein. This test report may not be published or duplicated in part without permission of the testing body. This test report by itself does not constitute authorization for the use of any TUV Rheinland test mark. The report must not be used by the client to claim product certification, approval, or endorsement by NVLAP, NIST, or any agency of the Federal Government.

Radiated Emissions – Internal Antenna

Vertical CH 48

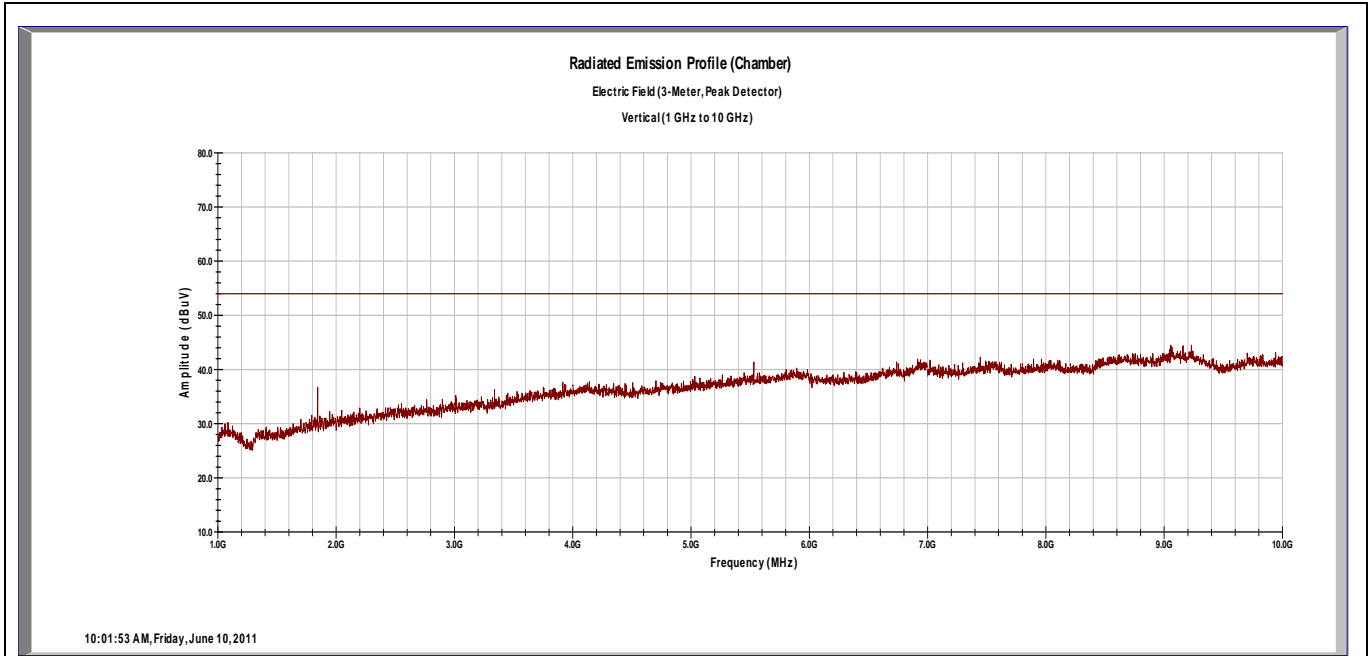

Emission Freq (MHz)	ANT Polar (H/V)	ANT Pos (m)	Table Pos (deg)	FIM Value (dBuV)	Amp Gain (dB)	Cable Loss (dB)	ANT Factor (dB/m)	E-Field Value (dBuV/m)	Spec Limit (dBuV/m)	Spec Margin (dB)
1843.20	V	1.5	345	35.03	34.75	6.81	27.25	34.34	54.00	-19.66
5529.60	V	1	115	24.81	34.11	12.34	34.44	37.48	54.00	-16.52
1843.20	V	1.5	345	44.31	34.75	6.81	27.25	43.62	74.00	-30.38
5529.60	V	1	115	37.73	34.11	12.34	34.44	50.40	74.00	-23.60

Notes: Notes: CH 48 – 921.6 MHz High Pass Filter used
Emissions shown in **Green** are using the Average Detector and shown in **Blue** are using the Peak Detector
Emissions outside the Restricted Bands are shown.
All emissions, including those that are inside the restricted bands, are either at or below the noise floor of the Spectrum Analyzer

The test results contained in this report refer exclusively to the product(s) presented for testing. No liability may be assumed for models or products not referred to herein. This test report may not be published or duplicated in part without permission of the testing body. This test report by itself does not constitute authorization for the use of any TUV Rheinland test mark. The report must not be used by the client to claim product certification, approval, or endorsement by NVLAP, NIST, or any agency of the Federal Government.

4.1 Conducted Emissions in Transmit mode

This test measures the electromagnet levels of spurious signals generated by the EUT on the AC power line that may affect the performance of other near by electronic equipment.

4.1.1 Test Procedure

Conducted and FCC emissions tests were performed using the procedures of ANSI C63.10:2009 including methods for signal maximizations and EUT configuration. The photos included with the report show the EUT in its maximized configuration.

The frequency range from 150 kHz – 30 MHz was investigated for conducted emissions.

Conducted Emissions measurements were performed in the shielded room using procedures specified in the test plan and standard.

4.1.2 Deviations

The EUT is battery operated and has no means to connect to AC Mains.

4.1.3 Final Test

The EUT is battery operated only; therefore this test is not applicable.

The test results contained in this report refer exclusively to the product(s) presented for testing. No liability may be assumed for models or products not referred to herein. This test report may not be published or duplicated in part without permission of the testing body. This test report by itself does not constitute authorization for the use of any TUV Rheinland test mark. The report must not be used by the client to claim product certification, approval, or endorsement by NVLAP, NIST, or any agency of the Federal Government.

4.2 Frequency Hopping Spread Spectrum (FHSS) Systems FCC Part 15.247(g)

Frequency hopping spread spectrum systems are not required to employ all available hopping channels during each transmission. However, the system, consisting of both the transmitter and the receiver, must be designed to comply with all of the regulations in this section should the transmitter be presented with a continuous data (or information) stream. In addition, a system employing short transmission bursts must comply with the definition of a frequency hopping system and must distribute its transmissions over the minimum number of hopping channels specified in this section.

In constant transmit mode, the EA2W Transponder sends a packet nominally every 97.3 ms with a delay of 8 to 16 ms between packets. Each packet is sent on the next channel determined by the pseudo-random hop table. When presented with a continuous data stream, the EUT adheres to the 0.4 second dwell time for each 10 second window requirement. The EUT always distributes its transmissions across all 25 channels, and does not re-use a channel again until a transmission has occurred on each of the other 24 channels.

4.3 Incorporation of Intelligence within a FHSS System FCC Part 15.247(h)

The incorporation of intelligence within a frequency hopping spread spectrum system that permits the system to recognize other users within the spectrum band so that it individually and independently chooses and adapts its hopsets to avoid hopping on occupied channels is permitted. The coordination of frequency hopping systems in any other manner for the express purpose of avoiding the simultaneous occupancy of individual hopping frequencies by multiple transmitters is not permitted.

The EUT does not incorporate intelligence relating to the hopping pattern as described above. Rather, the EUT always distributes its transmissions across the same 25 channels. A channel is not re-used until a transmission has occurred on each of the other 24 channels.

The test results contained in this report refer exclusively to the product(s) presented for testing. No liability may be assumed for models or products not referred to herein. This test report may not be published or duplicated in part without permission of the testing body. This test report by itself does not constitute authorization for the use of any TUV Rheinland test mark. The report must not be used by the client to claim product certification, approval, or endorsement by NVLAP, NIST, or any agency of the Federal Government.

5 Antenna Port Conducted Emissions

Testing was performed in accordance with 47 CFR Part 15, ANSI C63.10:2009, RSP-100 Issue 9. These test methods are listed under the laboratory's NVLAP Scope of Accreditation. This test measures the levels emanating from the EUT, thus evaluating the potential for the EUT to cause radio frequency interference to other electronic devices.

5.1 *Channel Separation*

5.1.1 Deviations

There were no deviations from the original channels.

All channels are identical to the original application.

5.2 *Pseudorandom Hopping Algorithm*

5.2.1 Deviations

There were no deviations from the original channels and hopping algorithm. All channels and hopping algorithms are identical to the original application.

The test results contained in this report refer exclusively to the product(s) presented for testing. No liability may be assumed for models or products not referred to herein. This test report may not be published or duplicated in part without permission of the testing body. This test report by itself does not constitute authorization for the use of any TUV Rheinland test mark. The report must not be used by the client to claim product certification, approval, or endorsement by NVLAP, NIST, or any agency of the Federal Government.

5.3 Occupied Bandwidth

The maximum allowed 20 dB bandwidth of the hopping channel is 500 kHz.

5.3.1 Test Over View

Results	Complies (as tested per this report)					Date	14 June 2011	
Standard	FCC Part 15.247(a)(1)(i)							
Product Model	EA2W			Serial#	Production Sample			
Test Set-up	Direct Measurement from antenna port							
EUT Powered By	3.6V DC Battery	Temp	77° F	Humidity	35%	Pressure	1004 mbar	
Perf. Criteria	(Below Limit)			Perf. Verification	Readings Under Limit			
Mod. to EUT	None			Test Performed By	Mark Ryan			

5.3.2 Test Procedure

Frequency hopping Systems shall have hopping channel carrier frequencies separated by a minimum of 25 kHz or the 20 dB bandwidth of the hopping channel, whichever is greater.

Maximum allowed 20dB Bandwidth = 500 kHz

Channel Separation = 25 kHz Min. or the 20 dB bandwidth of the hopping channel, whichever is greater

The channel separation is greater than the measured maximum 20 dB bandwidth. Therefore the EUT is compliant with this section.

5.3.3 Deviations

There were no deviations from the test methodology listed in the test plan for this test.

5.3.4 Final Test

The EUT met the performance criteria requirement as specified in the test plan of this report and in the standards.

The test results contained in this report refer exclusively to the product(s) presented for testing. No liability may be assumed for models or products not referred to herein. This test report may not be published or duplicated in part without permission of the testing body. This test report by itself does not constitute authorization for the use of any TUV Rheinland test mark. The report must not be used by the client to claim product certification, approval, or endorsement by NVLAP, NIST, or any agency of the Federal Government.

5.3.5 Final Data



	Delta 2 [T1]	RBW	10 kHz	RF Att	50 dB
Ref Lvl	0.16 dB	VBW	30 kHz		
30 dBm	278.55711423 kHz	SWT	200 ms	Unit	dBm

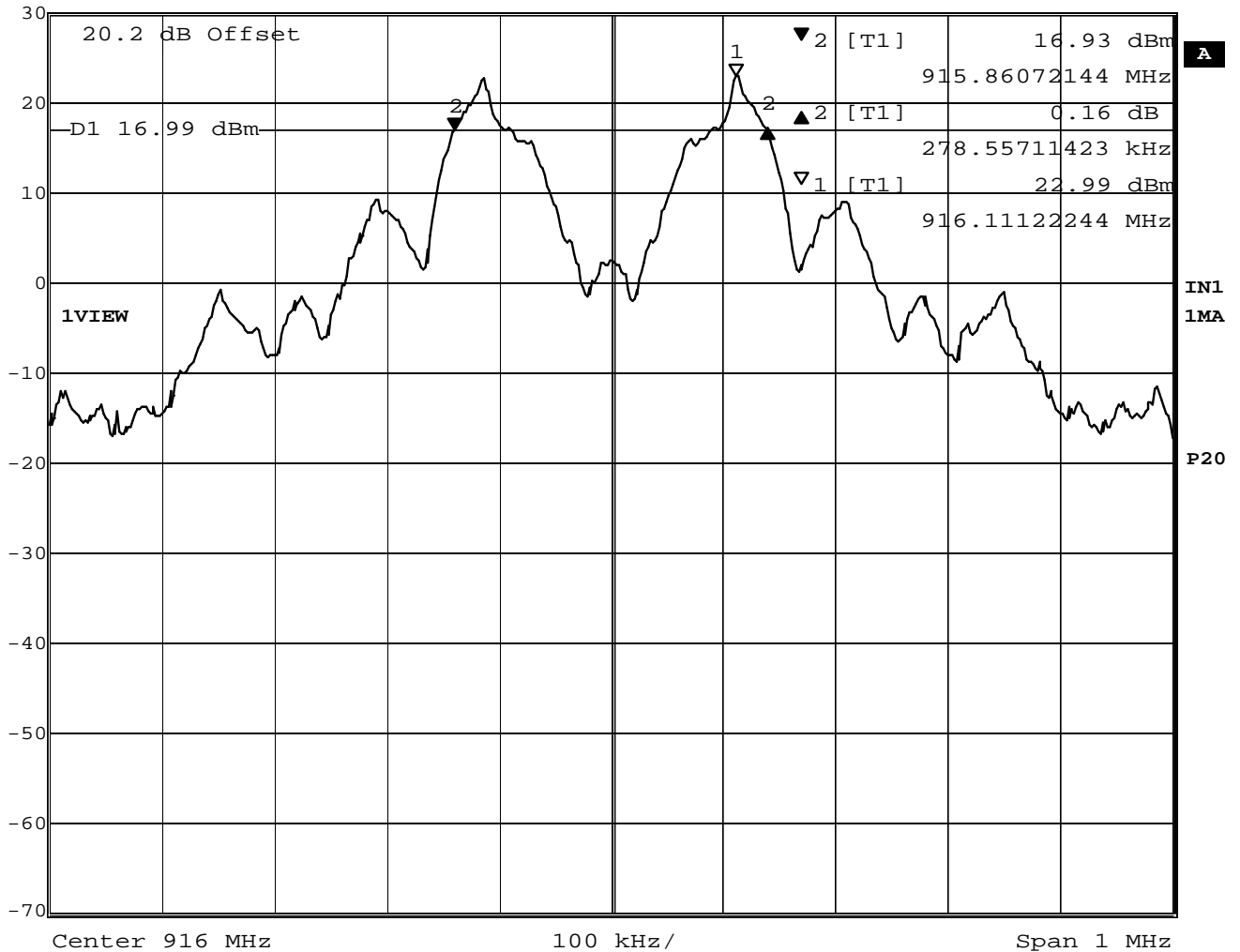

Date: 14.JUN.2011 17:16:57

Figure 3: Occupied Bandwidth

Note: The above plot is the worst case.

***BW = 279 KHZ**

The test results contained in this report refer exclusively to the product(s) presented for testing. No liability may be assumed for models or products not referred to herein. This test report may not be published or duplicated in part without permission of the testing body. This test report by itself does not constitute authorization for the use of any TUV Rheinland test mark. The report must not be used by the client to claim product certification, approval, or endorsement by NVLAP, NIST, or any agency of the Federal Government.



	Delta 2 [T1]	RBW	10 kHz	RF Att	50 dB
Ref Lvl	0.20 dB	VBW	30 kHz		
30 dBm	458.91783567 kHz	SWT	200 ms	Unit	dBm

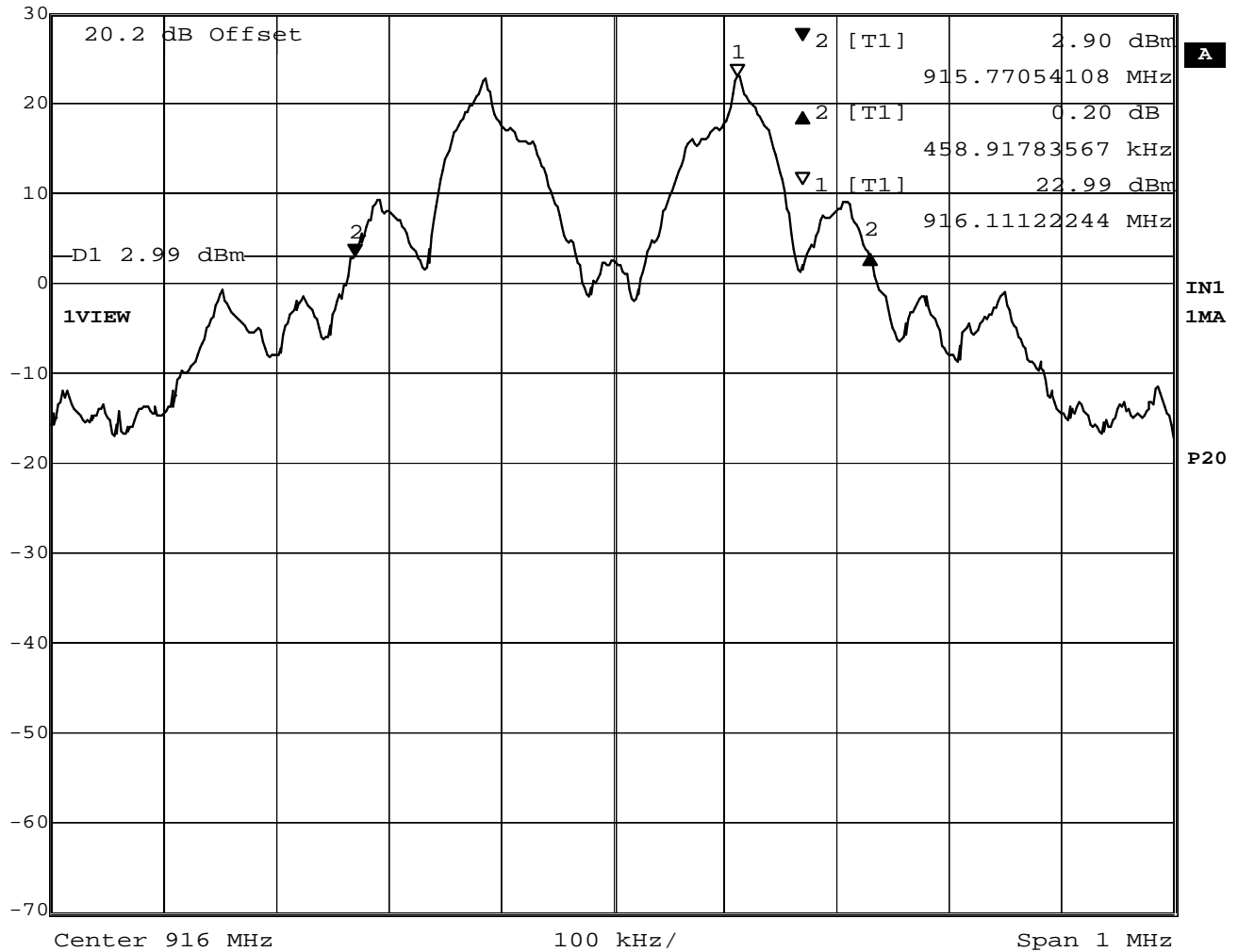

Date: 14.JUN.2011 17:19:34

Figure 4: 20 dB Occupied Bandwidth

Note: The above plot is the worst case.

***BW = 459 KHZ**

The test results contained in this report refer exclusively to the product(s) presented for testing. No liability may be assumed for models or products not referred to herein. This test report may not be published or duplicated in part without permission of the testing body. This test report by itself does not constitute authorization for the use of any TUV Rheinland test mark. The report must not be used by the client to claim product certification, approval, or endorsement by NVLAP, NIST, or any agency of the Federal Government.

5.4 99% Power Bandwidth

For the purpose of Section A1.1, the 99% bandwidth shall be no wider than .25% of the center frequency for devices operating between 70-900MHz. For devices operating above 900 MHz, the emission shall be no wider than 0.5% of the center frequency.

5.4.1 Test Over View

Results	Complies (as tested per this report)				Date	14 June 2011	
Standard	RSS-210 Section A1.1.3						
Product Model	EA2W			Serial#	Production Sample		
Test Set-up	Direct Measurement from antenna port						
EUT Powered By	3.6V DC Battery	Temp	75° F	Humidity	34%	Pressure	1001 mbar
Perf. Criteria	(Below Limit)		Perf. Verification		Readings Under Limit		
Mod. to EUT	None		Test Performed By		Mark Ryan		

5.4.2 Test Procedure

Using the procedures of RSS-GEN section 4.6.1, the 10 kHz resolution bandwidth is 1% of the 1 MHz span. The Video bandwidth is 3 times that of the resolution bandwidth.

The limit of the bandwidth would be 0.5% of 916 MHz is 4.58 MHz. The measured 99% bandwidth is 326.7 kHz.

5.4.3 Deviations

There were no deviations from the test methodology listed in the test plan for this test.

5.4.4 Final Test

The EUT met the performance criteria requirement as specified in the test plan of this report and in the standards.

The test results contained in this report refer exclusively to the product(s) presented for testing. No liability may be assumed for models or products not referred to herein. This test report may not be published or duplicated in part without permission of the testing body. This test report by itself does not constitute authorization for the use of any TUV Rheinland test mark. The report must not be used by the client to claim product certification, approval, or endorsement by NVLAP, NIST, or any agency of the Federal Government.

5.4.5 Final Data

	Marker 1 [T1]	RBW	10 kHz	RF Att	50 dB
	Ref Lvl	22.99 dBm	VBW	30 kHz	
	30 dBm	916.11122244 MHz	SWT	200 ms	Unit dBm

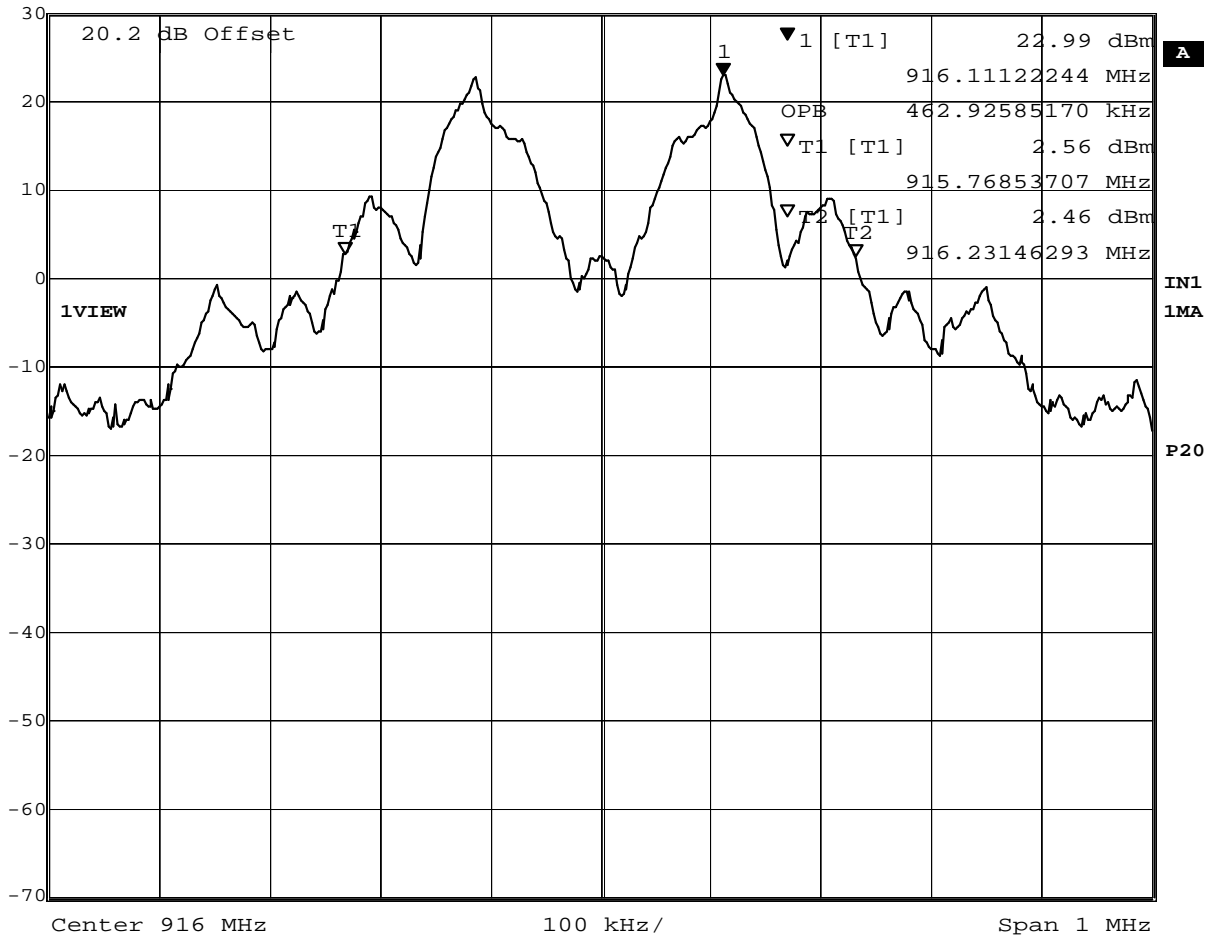

Date: 14.JUN.2011 17:20:44

Figure 5 – 99% Power Bandwidth = 463 kHz

Spectrum Analyzer Parameters:

- RBW=10kHz
- Span=1MHz
- VBW= 30kHz
- LOG dB/div.= 10dB
- Sweep = Auto
- Detector = sample detector, max hold

The EUT is compliant to the requirements of RSS-210 A1.1.3

The test results contained in this report refer exclusively to the product(s) presented for testing. No liability may be assumed for models or products not referred to herein. This test report may not be published or duplicated in part without permission of the testing body. This test report by itself does not constitute authorization for the use of any TUV Rheinland test mark. The report must not be used by the client to claim product certification, approval, or endorsement by NVLAP, NIST, or any agency of the Federal Government.

5.5 Band Edge

5.5.1 Test Over View

Results	Complies (as tested per this report)				Date	14 June 2011	
Standard	FCC Part 15.247(d), RSS 210 A8.1(c)						
Product Model	EA2W			Serial#	Production Sample		
Test Set-up	Direct Measurement from antenna port						
EUT Powered By	3.6V DC Battery	Temp	75° F	Humidity	34%	Pressure	1001 mbar
Perf. Criteria	(Below Limit)			Perf. Verification	Readings Under Limit		
Mod. to EUT	None			Test Performed By	Mark Ryan		

5.5.2 Test Procedure

Intentional radiators operating under the alternative provisions to the general emission limits must be designed to ensure that the 20 dB bandwidth of the emission, or whatever bandwidth may otherwise be specified in the specific rule section under which the equipment operates, is contained within the frequency band designated in the rule section under which the equipment is operated. The requirement to contain the designated bandwidth of the emission within the specified frequency band includes the effects from frequency sweeping, frequency hopping and other modulation techniques that may be employed as well as the frequency stability of the transmitter over expected variations in temperature and supply voltage. If frequency stability is not specified in the regulations, it is recommended that the fundamental emission be kept within at least the central 80% of the permitted band in order to minimize the possibility of out-of-band operation.

5.5.3 Deviations

There were no deviations from the test methodology listed in the test plan for this test.

5.5.4 Final Test

The EUT met the performance criteria requirement as specified in the test plan of this report and in the standards.

The test results contained in this report refer exclusively to the product(s) presented for testing. No liability may be assumed for models or products not referred to herein. This test report may not be published or duplicated in part without permission of the testing body. This test report by itself does not constitute authorization for the use of any TUV Rheinland test mark. The report must not be used by the client to claim product certification, approval, or endorsement by NVLAP, NIST, or any agency of the Federal Government.

Report No.:

31161542.001 C2PC

Page 28 of 37



Marker 3 [T1] RBW 100 kHz RF Att 50 dB
 Ref Lvl -23.41 dBm VBW 100 kHz
 30 dBm 902.00000000 MHz SWT 5 ms Unit dBm

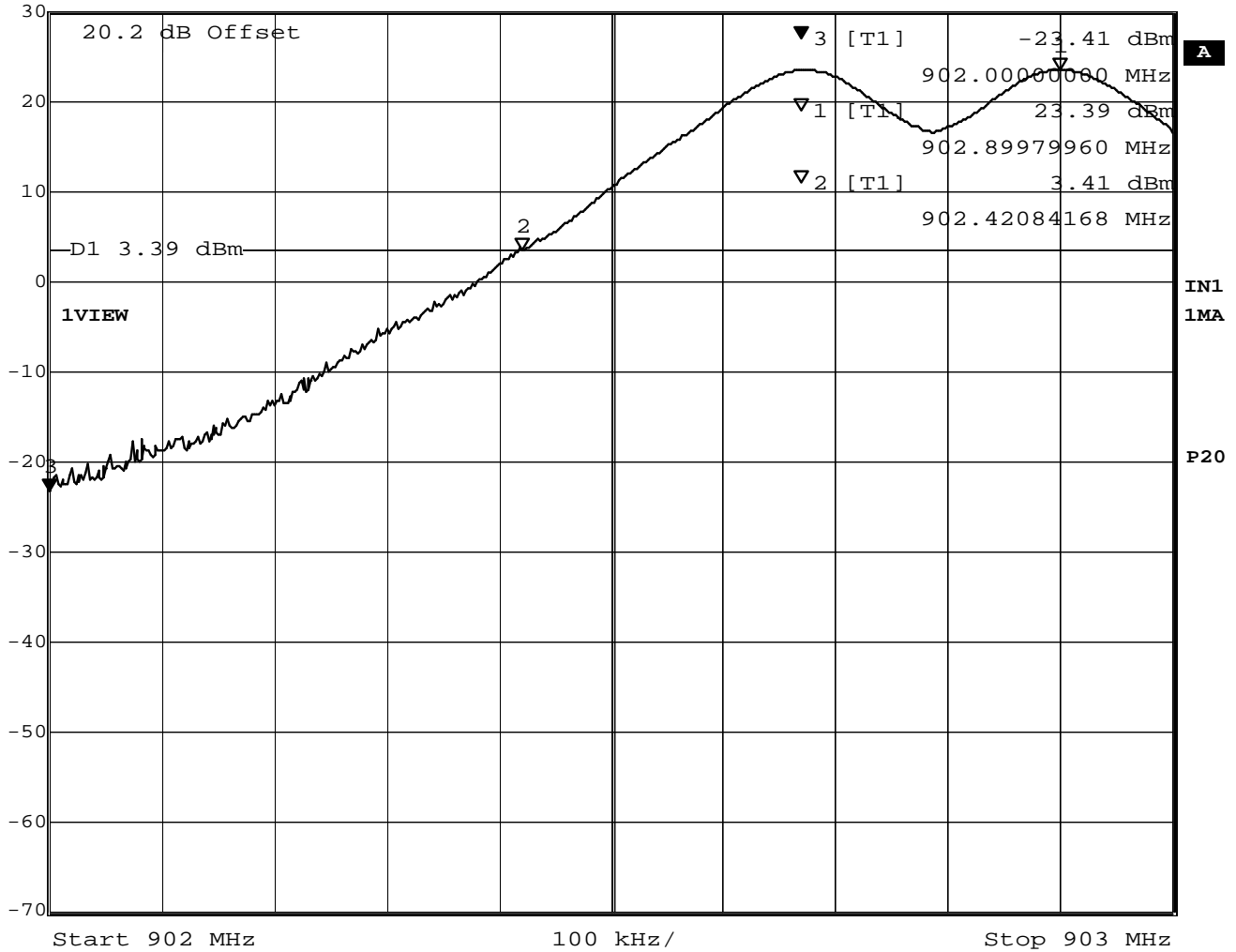

Date: 14.JUN.2011 17:07:05

Figure 6: Lower Band Edge Measurement

Note: Band Edge is at 902 MHz

Channel Frequency is 902.8 MHz. The 20dB down point is at 902.42 MHz. The EUT is compliant with the rules.

The test results contained in this report refer exclusively to the product(s) presented for testing. No liability may be assumed for models or products not referred to herein. This test report may not be published or duplicated in part without permission of the testing body. This test report by itself does not constitute authorization for the use of any TUV Rheinland test mark. The report must not be used by the client to claim product certification, approval, or endorsement by NVLAP, NIST, or any agency of the Federal Government.

Report No.:

31161542.001 C2PC

Page 29 of 37

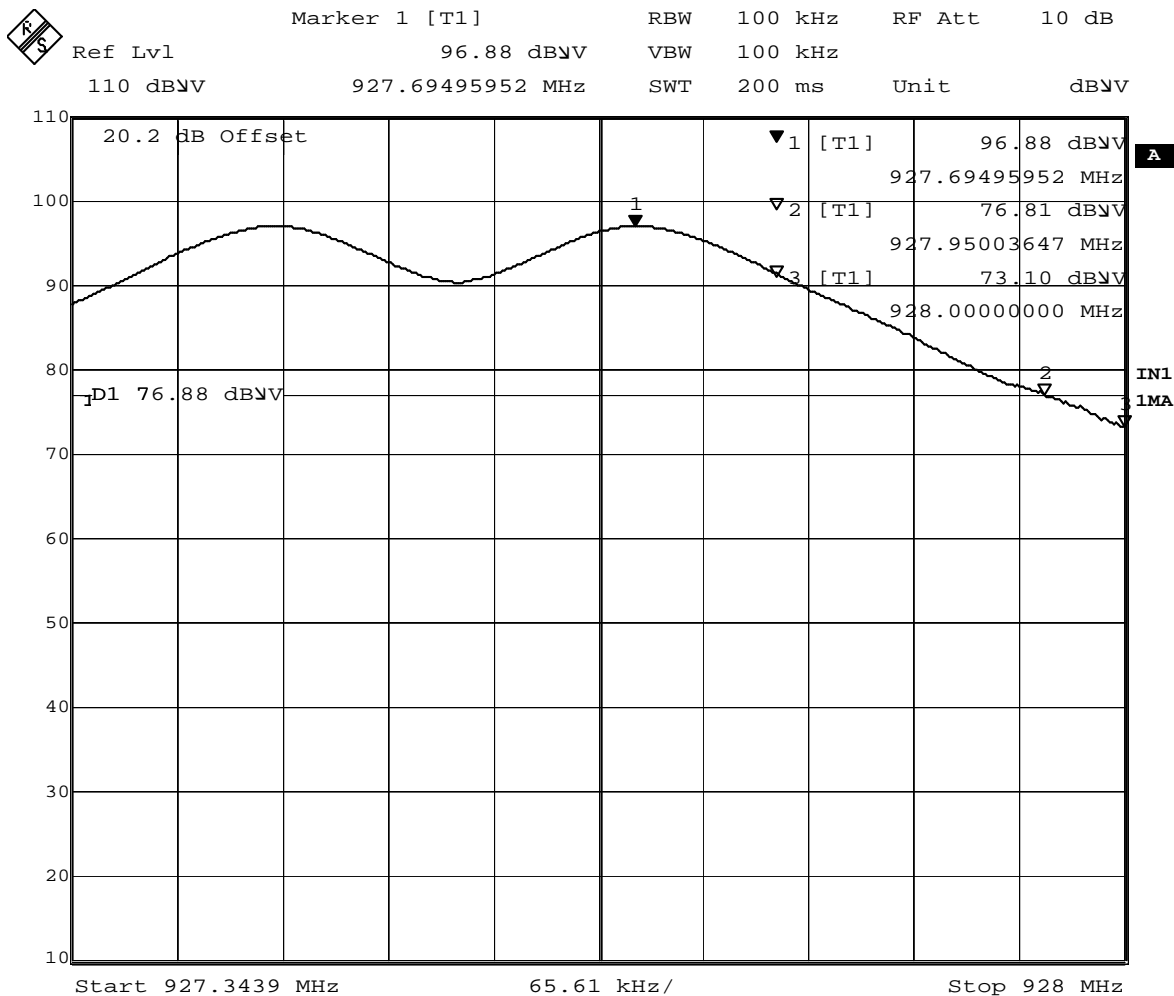

Date: 10.JUN.2011 15:17:40

Figure 7: Upper Band Edge Measurement

Note: Band edge is at 928 MHz

Channel 63 Frequency is 927.6 MHz. The 20dB down point is at 927.95 MHz

The EUT is compliant with the rules.

The test results contained in this report refer exclusively to the product(s) presented for testing. No liability may be assumed for models or products not referred to herein. This test report may not be published or duplicated in part without permission of the testing body. This test report by itself does not constitute authorization for the use of any TUV Rheinland test mark. The report must not be used by the client to claim product certification, approval, or endorsement by NVLAP, NIST, or any agency of the Federal Government.

5.6 Peak Output Power

The maximum peak output power of the intentional radiator shall not exceed 0.25 watts for systems employing less than 50 hopping channels, but at least 25 hopping channels. (Conducted Measurement)

5.6.1 Test Over View

Results	Complies (as tested per this report)				Date	14 June 2011	
Standard	FCC Part 15.247(b)(2) and RSS-210 A8.4(1)						
Product Model	EA2W			Serial#	Production Sample		
Test Set-up	Direct Measurement from antenna port						
EUT Powered By	3.6V DC Battery	Temp	77° F	Humidity	35%	Pressure	1004 mbar
Perf. Criteria	(Below Limit)			Perf. Verification	Readings Under Limit		
Mod. to EUT	None			Test Performed By	Mark Ryan		

5.6.2 Test Procedure

The peak output power was measured at CH01, CH34, CH48, and at CH63. The measurement was made using a direct connection between the RF output of the EUT and the spectrum analyzer. The cable loss and the attenuator was measured and added in the reference level offset in the spectrum analyzer. The spectrum analyzer's resolution bandwidth was greater than the 20dB bandwidth of the modulated carrier and the video bandwidth was equal to the resolution bandwidth.

Test Setup:

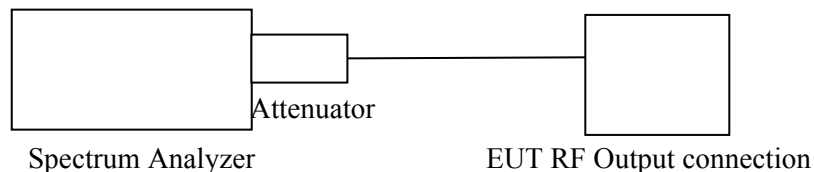

5.6.3 Deviations

There were no deviations from the test methodology listed in the test plan for this test.

5.6.4 Final Test

The EUT met the performance criteria requirement as specified in the test plan of this report and in the standards.

The test results contained in this report refer exclusively to the product(s) presented for testing. No liability may be assumed for models or products not referred to herein. This test report may not be published or duplicated in part without permission of the testing body. This test report by itself does not constitute authorization for the use of any TÜV Rheinland test mark. The report must not be used by the client to claim product certification, approval, or endorsement by NVLAP, NIST, or any agency of the Federal Government.

5.6.5 Final Data - Peak Power Output

CH01: 902.8 MHz = 0.215 Watts or 130.32 dBμV

CH34: 916.0 MHz = 0.227 Watts or 130.54 dBμV – Highest Emissions Output

CH48: 921.6 MHz = 0.222 Watts or 130.45 dBμV

CH63: 927.6 MHz = 0.203 Watts or 130.06 dBμV

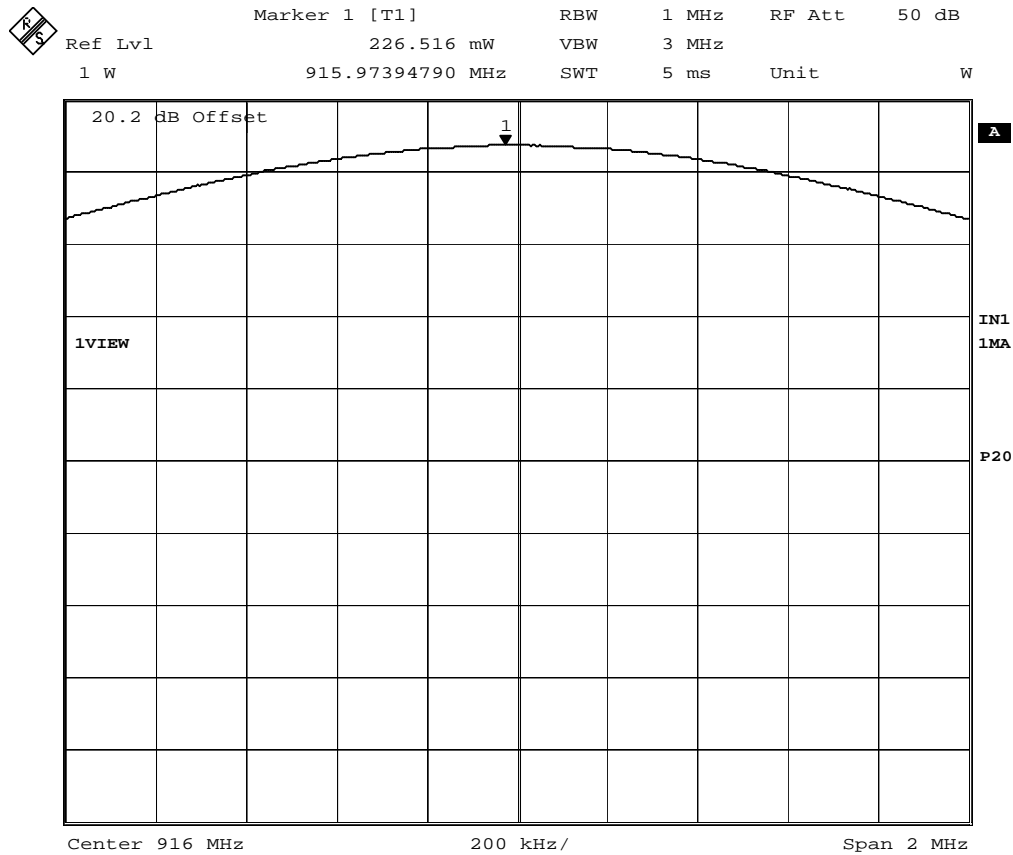

Date: 14.JUN.2011 16:53:50

Figure 8: CH 34 (916.0 MHz) Peak Output Power - Worst Case Shown.

Plots of other channels are on file at TUV Rheinland.

Antenna Gain

The antenna gain data was supplied separately with the following results provided:

Results: Internal Antenna

Freq. (MHz)	Peak (dBi)	Gain (Numeric)
902.0 – 928.0	3.73	2.36

The test results contained in this report refer exclusively to the product(s) presented for testing. No liability may be assumed for models or products not referred to herein. This test report may not be published or duplicated in part without permission of the testing body. This test report by itself does not constitute authorization for the use of any TUV Rheinland test mark. The report must not be used by the client to claim product certification, approval, or endorsement by NVLAP, NIST, or any agency of the Federal Government.

6 Emissions in Receive Mode.

6.1 Radiated Emissions

This test measures the electromagnetic levels of spurious signals generated by the EUT that radiated from the EUT and may affect the performance of other nearby electronic equipment.

6.1.1 Over View of Test

Results	Complies (as tested per this report)				Date	9 June 2011	
Standard	FCC Parts 15.109(a) and ICES-003						
Product Model	EA2W	Serial#	Production Sample				
Configuration	See test plan for details						
Test Set-up	Tested in a 5m Semi Anechoic chamber, placed on a 1.0m x 1.5m non-conductive table 80cm above the ground plane on a turn-table. See test plans for details						
EUT Powered By	3.6V DC Battery	Temp	75° F	Humidity	36%	Pressure	1005 mbar
Frequency Range	30 MHz to 5 GHz @ 3m						
Perf. Criteria	(Below Limit)		Perf. Verification	Readings Under Limit			
Mod. to EUT	None		Test Performed By	Mark Ryan			

6.1.2 Test Procedure

Radiated and FCC emissions tests were performed using the procedures of ANSI C63.4:2009 including methods for signal maximizations and EUT configuration. The photos included with the report show the EUT in its maximized configuration.

The frequency range from 30 MHz to 5 GHz was investigated for radiated emissions.

Radiated emission testing was performed at a distance of 3 meters in a 5 meter semi-anechoic chamber.

6.1.3 Deviations

There were no deviations from the test methodology listed in the test plan for the radiated emission test.

6.1.4 Final Test

All final radiated emissions measurements were below (in compliance) the limits.

The test results contained in this report refer exclusively to the product(s) presented for testing. No liability may be assumed for models or products not referred to herein. This test report may not be published or duplicated in part without permission of the testing body. This test report by itself does not constitute authorization for the use of any TUV Rheinland test mark. The report must not be used by the client to claim product certification, approval, or endorsement by NVLAP, NIST, or any agency of the Federal Government.

6.1.5 Final Graphs and Tabulated Data

Radiated Emissions – Receive Mode
Horizontal

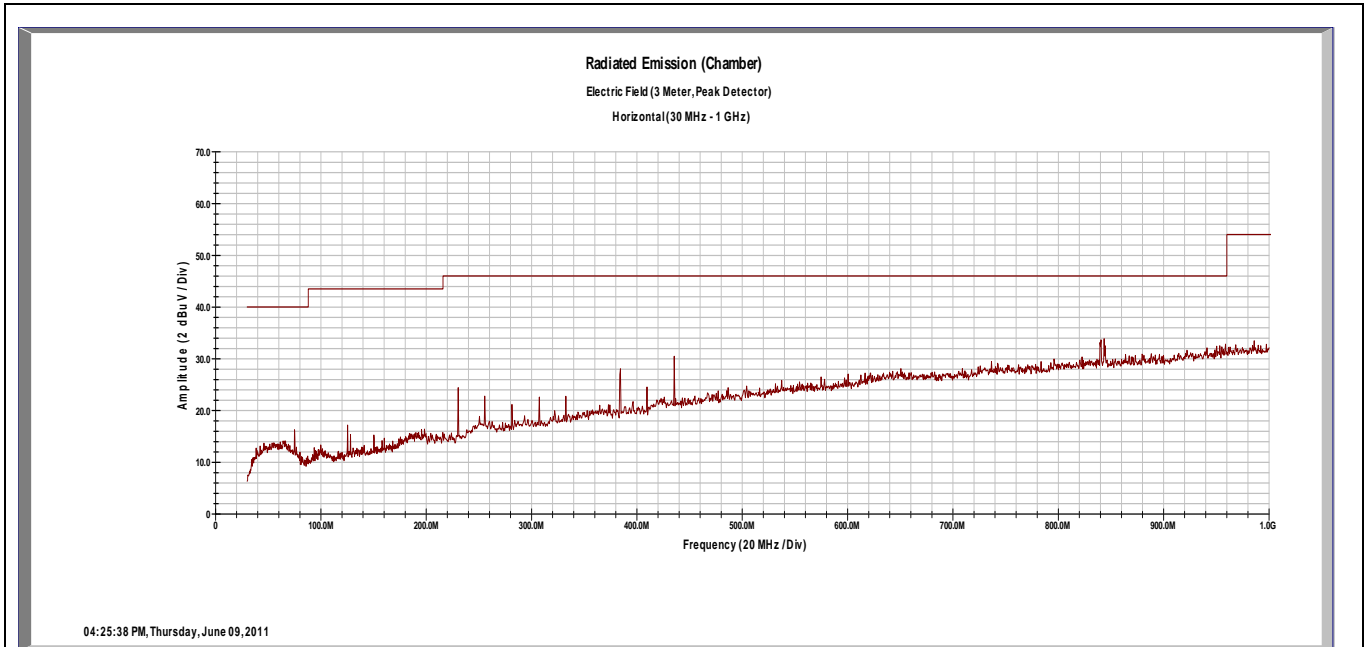

Emission Freq (MHz)	ANT Polar (H/V)	ANT Pos (m)	Table Pos (deg)	QP FIM Value (dBuV)	Amp Gain (dB)	Cable Loss (dB)	ANT Factor (dB/m)	E-Field Value (dBuV/m)	Spec Limit (dBuV/m)	Spec Margin (dB)
230.20	H	1.4	78	11.65	0.00	1.66	11.76	25.07	47.00	-21.93
435.20	H	1	125	11.63	0.00	2.30	16.79	30.71	47.00	-16.29

Notes: The low emissions below 200 MHz are anomalies of the receiver.

The test results contained in this report refer exclusively to the product(s) presented for testing. No liability may be assumed for models or products not referred to herein. This test report may not be published or duplicated in part without permission of the testing body. This test report by itself does not constitute authorization for the use of any TUV Rheinland test mark. The report must not be used by the client to claim product certification, approval, or endorsement by NVLAP, NIST, or any agency of the Federal Government.

Radiated Emissions – Receive Mode

Vertical

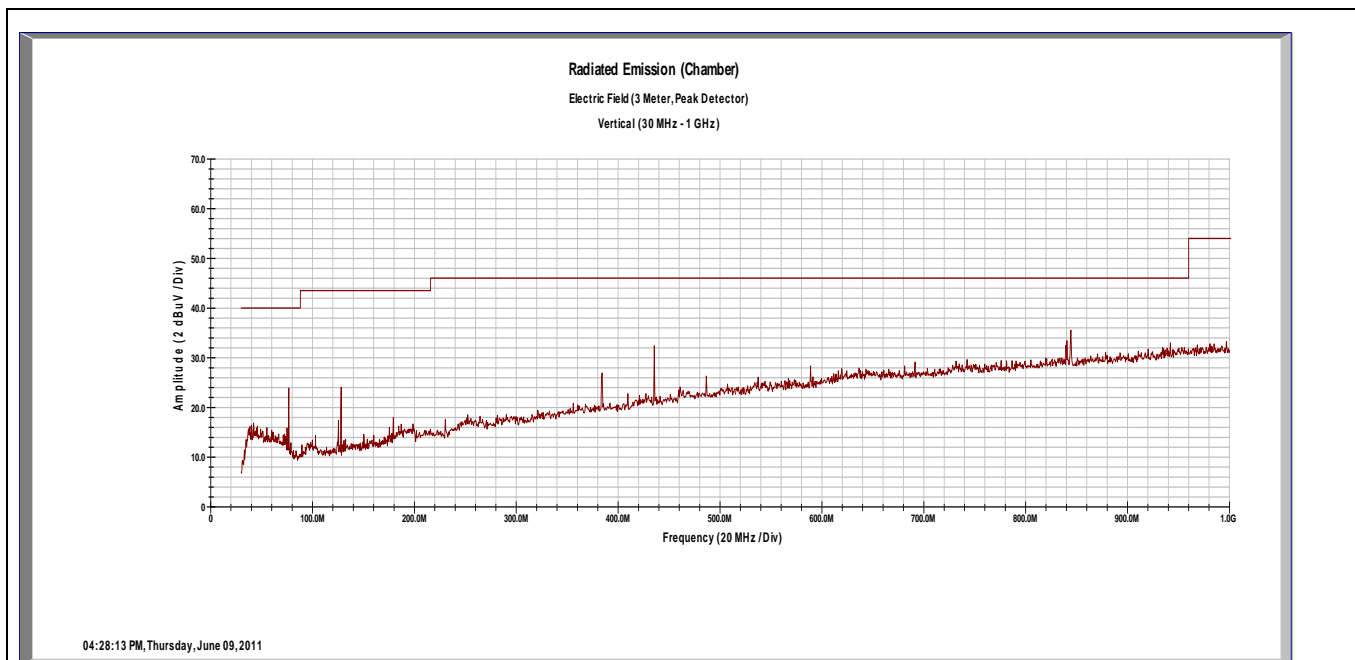

Emission Freq (MHz)	ANT Polar (H/V)	ANT Pos (m)	Table Pos (deg)	QP FIM Value (dBuV)	Amp Gain (dB)	Cable Loss (dB)	ANT Factor (dB/m)	E-Field Value (dBuV/m)	Spec Limit (dBuV/m)	Spec Margin (dB)
435.20	V	1.2	74	13.85	0.00	2.30	16.79	32.93	47.00	-14.07

Notes: The low emissions below 200 MHz are anomalies of the receiver.
Highlighted emission is worst case

The test results contained in this report refer exclusively to the product(s) presented for testing. No liability may be assumed for models or products not referred to herein. This test report may not be published or duplicated in part without permission of the testing body. This test report by itself does not constitute authorization for the use of any TÜV Rheinland test mark. The report must not be used by the client to claim product certification, approval, or endorsement by NVLAP, NIST, or any agency of the Federal Government.

Radiated Emissions – Receive Mode
Horizontal

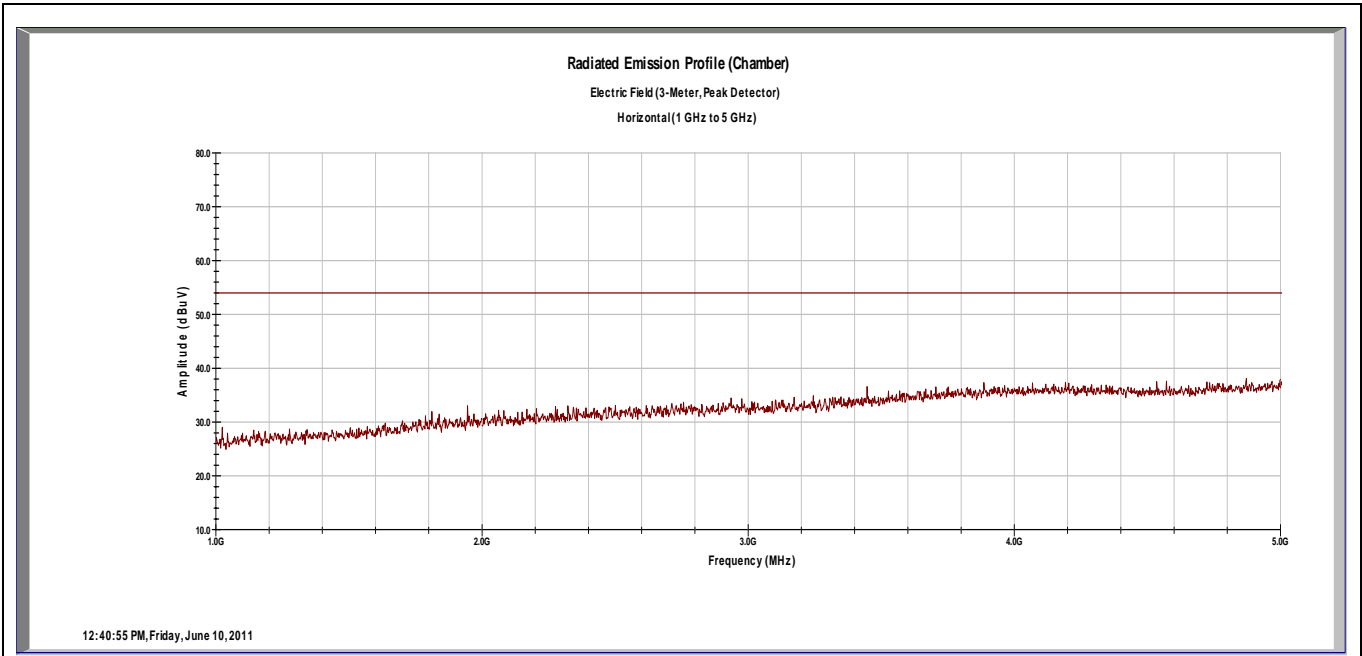

Emission Freq (MHz)	ANT Polar (H/V)	ANT Pos (m)	Table Pos (deg)	FIM Value (dBuV)	Amp Gain (dB)	Cable Loss (dB)	ANT Factor (dB/m)	E-Field Value (dBuV/m)	Spec Limit (dBuV/m)	Spec Margin (dB)

Notes: All emissions are either more than 20dB under the limit or below the noise floor of the spectrum analyzer.

The test results contained in this report refer exclusively to the product(s) presented for testing. No liability may be assumed for models or products not referred to herein. This test report may not be published or duplicated in part without permission of the testing body. This test report by itself does not constitute authorization for the use of any TUV Rheinland test mark. The report must not be used by the client to claim product certification, approval, or endorsement by NVLAP, NIST, or any agency of the Federal Government.

6.2 Conducted Emissions

This test measures the electromagnet levels of spurious signals generated by the EUT on the AC power line that may affect the performance of other near by electronic equipment.

6.2.1 Over View of Test

Results	NA (as tested per this report)		Date	NA	
Standard	FCC Part 15.107(a) and ICES-003				
Product Model	EA2W	Serial#	Production Sample		
Configuration	See test plan for details				
Test Set-up	Tested in shielded room. EUT placed on table, see test plans for details				
EUT Powered By	3.6V DC Battery	Temp		Humidity	Pressure
Frequency Range	150 kHz to 30 MHz				
Perf. Criteria	(Below Limit)	Perf. Verification	Readings Under Limit for L1 & Neutral		
Mod. to EUT	None	Test Performed By	Mark Ryan		

6.2.2 Test Procedure

Conducted and FCC emissions tests were performed using the procedures of ANSI C63.4:2009 including methods for signal maximizations and EUT configuration. The photos included with the report show the EUT in its maximized configuration.

The frequency range from 150 kHz to 30 MHz was investigated for conducted emissions.

Conducted Emissions measurements were performed in the shielded room using procedures specified in the test plan and standard.

6.2.1 Deviations

The EUT is battery operated and has no means to connect to AC Mains.

6.2.2 Final Test

The EUT is battery operated only; therefore this test is not applicable.

The test results contained in this report refer exclusively to the product(s) presented for testing. No liability may be assumed for models or products not referred to herein. This test report may not be published or duplicated in part without permission of the testing body. This test report by itself does not constitute authorization for the use of any TUV Rheinland test mark. The report must not be used by the client to claim product certification, approval, or endorsement by NVLAP, NIST, or any agency of the Federal Government.