



TEST REPORT

Test report no.: 1-6730/18-01-08-A



BNetzA-CAB-02/21-102

Testing laboratory

CTC advanced GmbH

Untertuerkheimer Strasse 6 – 10
66117 Saarbruecken / Germany

Phone: + 49 681 5 98 - 0

Fax: + 49 681 5 98 - 9075

Internet: <http://www.ctcadvanced.com>

e-mail: mail@ctcadvanced.com

Accredited Testing Laboratory:

The testing laboratory (area of testing) is accredited according to DIN EN ISO/IEC 17025 (2005) by the Deutsche Akkreditierungsstelle GmbH (DAkkS)

The accreditation is valid for the scope of testing procedures as stated in the accreditation certificate with the registration number: D-PL-12076-01-03

Applicant

Bury GmbH & Co. KG

Robert-Koch-Str. 1-7

32584 Löhne / GERMANY

Phone: +49 5732 9706-100

Contact: Johann Dshus

e-mail: Johann.Dshus@bury.com

Manufacturer

BURY Sp. z o.o.

ul. Wojska Polskiego 4

39-300 Mielec, POLAND

Test standard/s

FCC - Title 47 CFR
Part 15

FCC - Title 47 of the Code of Federal Regulations; Chapter I; Part 15 - Radio frequency devices

RSS - 247 Issue 2

Digital Transmission Systems (DTSs), Frequency Hopping Systems (FHSs) and Licence - Exempt Local Area Network (LE-LAN) Devices

RSS - Gen Issue 5

Spectrum Management and Telecommunications Radio Standards Specification - General Requirements for Compliance of Radio Apparatus

For further applied test standards please refer to section 3 of this test report.

Test Item

Kind of test item: Touchscreen remote wireless control unit

Model name: TSR2

FCC ID: QZ9-TSR2

IC: 5927A-TSR2

Frequency: DTS band 2400 MHz to 2483.5 MHz

Technology tested: WLAN

Antenna: Integrated antenna

Power supply: 8.25 V DC by Li-ion battery

Temperature range: -40°C to +80°C



This test report is electronically signed and valid without handwritten signature. For verification of the electronic signatures, the public keys can be requested at the testing laboratory.

Test report authorized:

Andreas Luckenbill
Lab Manager
Radio Communications & EMC

Test performed:

Marco Bertolino
Lab Manager
Radio Communications & EMC

1 Table of contents

1	Table of contents	2
2	General information	3
2.1	Notes and disclaimer	3
2.2	Application details.....	3
2.3	Test laboratories sub-contracted	3
3	Test standard/s and references	4
4	Test environment.....	5
5	Test item.....	5
5.1	General description.....	5
5.2	Additional information	5
6	Description of the test setup.....	6
6.1	Shielded semi anechoic chamber.....	7
6.2	Shielded fully anechoic chamber	8
6.3	Radiated measurements > 18 GHz.....	9
6.4	Conducted measurements with peak power meter & spectrum analyzer	10
7	Sequence of testing	11
7.1	Sequence of testing radiated spurious 9 kHz to 30 MHz.....	11
7.2	Sequence of testing radiated spurious 30 MHz to 1 GHz.....	12
7.3	Sequence of testing radiated spurious 1 GHz to 18 GHz.....	13
7.4	Sequence of testing radiated spurious above 18 GHz	14
8	Measurement uncertainty	15
9	Summary of measurement results	16
10	Additional comments	17
11	Additional EUT parameter.....	18
12	Measurement results.....	19
12.1	Antenna gain	19
12.2	Identify worst case data rate	22
12.3	Maximum output power.....	23
12.4	Duty cycle	24
12.5	Peak power spectral density	33
12.6	6 dB DTS bandwidth	42
12.7	Occupied bandwidth – 99% emission bandwidth.....	51
12.8	Occupied bandwidth – 20 dB bandwidth.....	60
12.9	Band edge compliance conducted - restricted bands	69
12.10	Spurious emissions conducted	75
12.11	Spurious emissions radiated below 30 MHz.....	90
12.12	Spurious emissions radiated 30 MHz to 1 GHz.....	97
12.13	Spurious emissions radiated above 1 GHz.....	108
13	Observations	120
Annex A	Glossary.....	121
Annex B	Document history	122
Annex C	Accreditation Certificate	122

2 General information

2.1 Notes and disclaimer

The test results of this test report relate exclusively to the test item specified in this test report. CTC advanced GmbH does not assume responsibility for any conclusions and generalizations drawn from the test results with regard to other specimens or samples of the type of the equipment represented by the test item.

The test report may only be reproduced or published in full. Reproduction or publication of extracts from the report requires the prior written approval of CTC advanced GmbH.

The testing service provided by CTC advanced GmbH has been rendered under the current "General Terms and Conditions for CTC advanced GmbH".

CTC advanced GmbH will not be liable for any loss or damage resulting from false, inaccurate, inappropriate or incomplete product information provided by the customer.

Under no circumstances does the CTC advanced GmbH test report include any endorsement or warranty regarding the functionality, quality or performance of any other product or service provided.

Under no circumstances does the CTC advanced GmbH test report include or imply any product or service warranties from CTC advanced GmbH, including, without limitation, any implied warranties of merchantability, fitness for purpose, or non-infringement, all of which are expressly disclaimed by CTC advanced GmbH.

All rights and remedies regarding vendor's products and services for which CTC advanced GmbH has prepared this test report shall be provided by the party offering such products or services and not by CTC advanced GmbH. In no case this test report can be considered as a Letter of Approval.

This test report is electronically signed and valid without handwritten signature. For verification of the electronic signatures, the public keys can be requested at the testing laboratory.

This test report replaces the test report with the number 1-6730/18-01-08 and dated 2018-12-12.

2.2 Application details

Date of receipt of order:	2018-10-01
Date of receipt of test item:	2018-11-05
Start of test:	2018-11-05
End of test:	2018-11-20
Person(s) present during the test:	-/-

2.3 Test laboratories sub-contracted

None

3 Test standard/s and references

Test standard	Date	Description
FCC - Title 47 CFR Part 15	-/-	FCC - Title 47 of the Code of Federal Regulations; Chapter I; Part 15 - Radio frequency devices
RSS - 247 Issue 2	February 2017	Digital Transmission Systems (DTSs), Frequency Hopping Systems (FHSs) and Licence - Exempt Local Area Network (LE-LAN) Devices
RSS - Gen Issue 5	April 2018	Spectrum Management and Telecommunications Radio Standards Specification - General Requirements for Compliance of Radio Apparatus

Guidance	Version	Description
DTS: KDB 558074 D01	v05	GUIDANCE FOR COMPLIANCE MEASUREMENTS ON DIGITAL TRANSMISSION SYSTEM, FREQUENCY HOPPING SPREAD SPECTRUM SYSTEM, AND HYBRID SYSTEM DEVICES OPERATING UNDER SECTION 15.247 OF THE FCC RULES
ANSI C63.4-2014	-/-	American national standard for methods of measurement of radio-noise emissions from low-voltage electrical and electronic equipment in the range of 9 kHz to 40 GHz
ANSI C63.10-2013	-/-	American national standard of procedures for compliance testing of unlicensed wireless devices

4 Test environment

Temperature	:	T_{nom} T_{max} T_{min}	+22 °C during room temperature tests No tests under extreme temperature conditions required. No tests under extreme temperature conditions required.
Relative humidity content	:		44 %
Barometric pressure	:		1016 hpa
Power supply	:	V_{nom} V_{max} V_{min}	8.25 V DC by Li-ion battery No tests under extreme voltage conditions required. No tests under extreme voltage conditions required.

5 Test item

5.1 General description

Kind of test item	:	Touchscreen remote wireless control unit								
Type identification	:	TSR2								
HMN	:	-/-								
PMN	:	Touch Screen Remote								
HVIN	:	TSR2								
FVIN	:	-/-								
S/N serial number	:	Radiated units: <table border="0" style="display: inline-table; vertical-align: top;"> <tr> <td>Sample R3</td> <td>(MAC: 30:45:11:1A:5C:DA)</td> </tr> <tr> <td>Sample R2</td> <td>(MAC: 40:BD:32:E5:21:4B)</td> </tr> <tr> <td>Sample 3</td> <td>(MAC: 30:45:11:18:58:A4)</td> </tr> </table>	Sample R3	(MAC: 30:45:11:1A:5C:DA)	Sample R2	(MAC: 40:BD:32:E5:21:4B)	Sample 3	(MAC: 30:45:11:18:58:A4)		
Sample R3	(MAC: 30:45:11:1A:5C:DA)									
Sample R2	(MAC: 40:BD:32:E5:21:4B)									
Sample 3	(MAC: 30:45:11:18:58:A4)									
Hardware status	:	H09								
Software status	:	X087								
Firmware status	:	-/-								
Frequency band	:	DTS band 2400 MHz to 2483.5 MHz								
Type of radio transmission	:	DSSS, OFDM)								
Use of frequency spectrum	:									
Type of modulation	:	(D)BPSK, (D)QPSK, 16 – QAM, 64 – QAM								
Number of channels	:	11 with 20 MHz channel bandwidth 9 with 40 MHz channel bandwidth								
Antenna	:	Integrated antenna								
Power supply	:	6.00 V to 8.25 V DC by Li-ion battery								
Temperature range	:	-40°C to +80°C								

5.2 Additional information

The content of the following annexes is defined in the QA. It may be that not all of the listed annexes are necessary for this report, thus some values in between may be missing.

Test setup and EUT photos are included in test report:

1-6730/18-01-01_AnnexA
1-6730/18-01-01_AnnexB
1-6730/18-01-01_AnnexD

6 Description of the test setup

Typically, the calibrations of the test apparatus are commissioned to and performed by an accredited calibration laboratory. The calibration intervals are determined in accordance with the DIN EN ISO/IEC 17025. In addition to the external calibrations, the laboratory executes comparison measurements with other calibrated test systems or effective verifications. Weekly chamber inspections and range calibrations are performed. Where possible, RF generating and signaling equipment as well as measuring receivers and analyzers are connected to an external high-precision 10 MHz reference (GPS-based or rubidium frequency standard).

In order to simplify the identification of the equipment used at some special tests, some items of test equipment and ancillaries can be provided with an identifier or number in the equipment list below (Lab/Item).

Agenda: Kind of Calibration

k	calibration / calibrated	EK	limited calibration
ne	not required (k, ev, izw, zw not required)	zw	cyclical maintenance (external cyclical maintenance)
ev	periodic self verification	izw	internal cyclical maintenance
Ve	long-term stability recognized	g	blocked for accredited testing
vlk!	Attention: extended calibration interval		
NK!	Attention: not calibrated	*)	next calibration ordered / currently in progress

6.1 Shielded semi anechoic chamber

The radiated measurements are performed in vertical and horizontal plane in the frequency range from 30 MHz to 1 GHz in semi-anechoic chambers. The EUT is positioned on a non-conductive support with a height of 0.80 m above a conductive ground plane that covers the whole chamber. The receiving antennas are conform to specifications ANSI C63. These antennas can be moved over the height range between 1.0 m and 4.0 m in order to search for maximum field strength emitted from EUT. The measurement distances between EUT and receiving antennas are indicated in the test setups for the various frequency ranges. For each measurement, the EUT is rotated in all three axes until the maximum field strength is received. The wanted and unwanted emissions are received by spectrum analyzers where the detector modes and resolution bandwidths over various frequency ranges are set according to requirement ANSI C63.

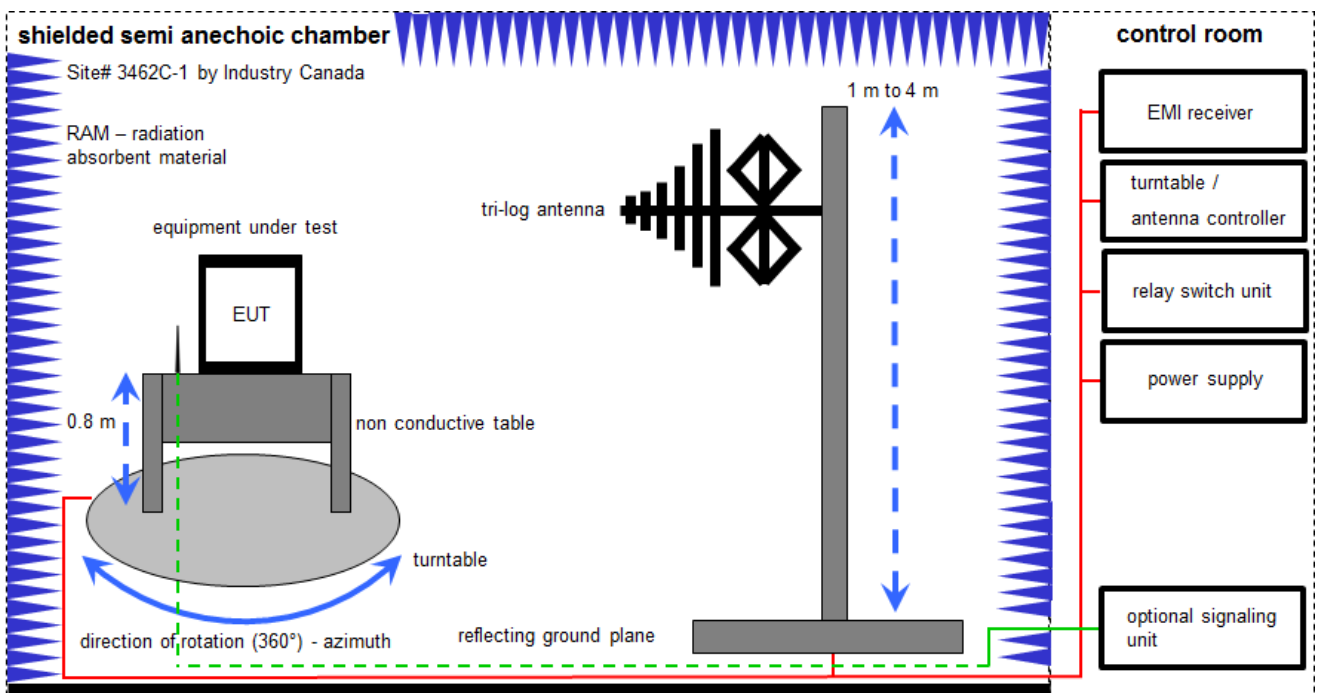

Measurement distance: tri-log antenna 10 meter
EMC32 software version: 10.30.0

FS = UR + CL + AF
(FS-field strength; UR-voltage at the receiver; CL-loss of the cable; AF-antenna factor)

Example calculation:

$$FS [dB\mu V/m] = 12.35 [dB\mu V/m] + 1.90 [dB] + 16.80 [dB/m] = 31.05 [dB\mu V/m] (35.69 \mu V/m)$$

Equipment table:

No.	Lab / Item	Equipment	Type	Manufacturer	Serial No.	INV. No.	Kind of Calibration	Last Calibration	Next Calibration
1	A	Switch-Unit	3488A	HP	2719A14505	300000368	ev	-/-	-/-
2	A	Meßkabine 1	HF-Absorberhalle	MWB AG 300023	-/-	300000551	ne	-/-	-/-
3	A	EMI Test Receiver	ESCI 3	R&S	100083	300003312	k	15.12.2017	14.12.2018
4	A	Antenna Tower	Model 2175	ETS-Lindgren	64762	300003745	izw	-/-	-/-
5	A	Positioning Controller	Model 2090	ETS-Lindgren	64672	300003746	izw	-/-	-/-
6	A	Turntable Interface-Box	Model 105637	ETS-Lindgren	44583	300003747	izw	-/-	-/-
7	A	TRILOG Broadband Test-Antenna 30 MHz - 3 GHz	VULB9163	Schwarzbeck Mess - Elektronik	371	300003854	vKI!	24.11.2017	23.11.2020

6.2 Shielded fully anechoic chamber

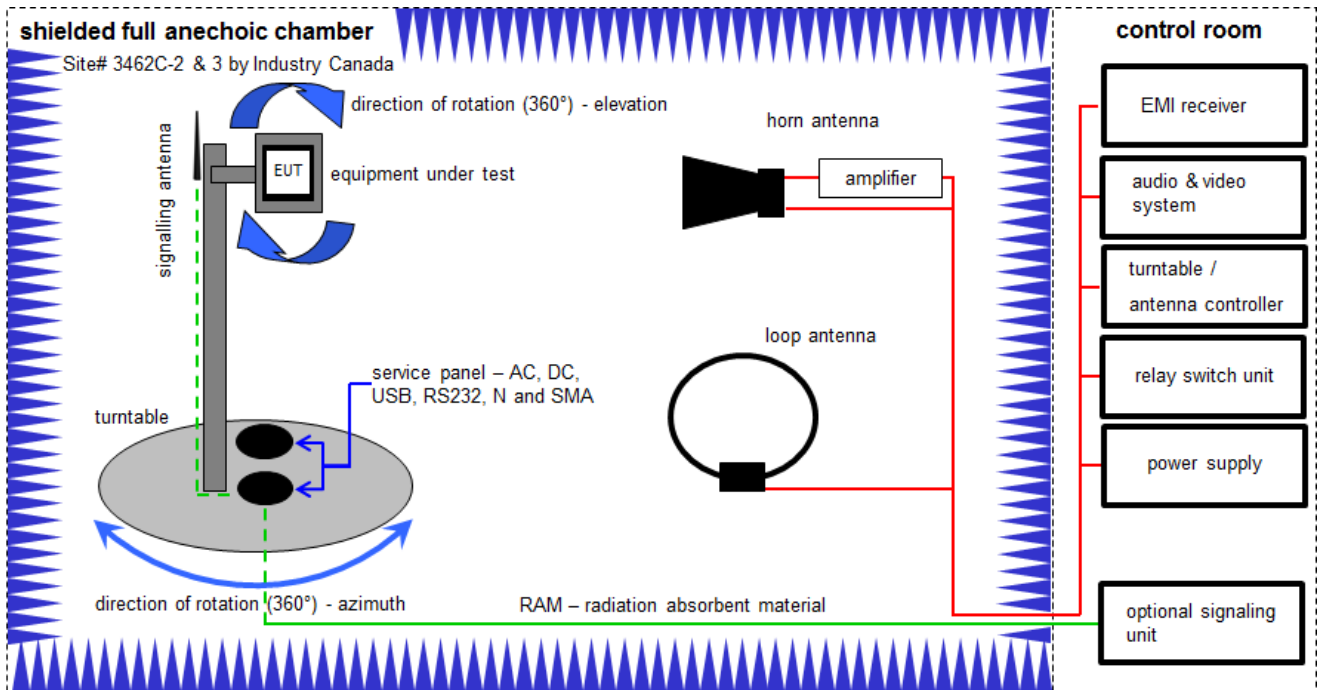

Measurement distance: horn antenna 3 meter; loop antenna 3 meter

$$FS = UR + CA + AF$$

(FS-field strength; UR-voltage at the receiver; CA-loss of the signal path; AF-antenna factor)

Example calculation:

$$FS [dB\mu V/m] = 40.0 [dB\mu V/m] + (-35.8) [dB] + 32.9 [dB/m] = 37.1 [dB\mu V/m] (71.61 \mu V/m)$$

Equipment table:

No.	Lab / Item	Equipment	Type	Manufacturer	Serial No.	INV. No.	Kind of Calibration	Last Calibration	Next Calibration
1	A, B	Double-Ridged Waveguide Horn Antenna 1-18.0GHz	3115	EMCO	8812-3088	300001032	vKI!	07.07.2017	06.07.2019
2	C	Active Loop Antenna 9 kHz to 30 MHz	6502	EMCO	2210	300001015	vKI!	07.07.2017	06.07.2019
3	B	Highpass Filter	WHK1.1/15G-10SS	Wainwright	37	400000148	ne	-/-	-/-
4	B	Highpass Filter	WHKX7.0/18G-8SS	Wainwright	18	300003789	ne	-/-	-/-
5	B	Band Reject Filter	WRCG2400/2483-2375/2505-50/10SS	Wainwright	26	300003792	ne	-/-	-/-
6	B	Broadband Amplifier 0.5-18 GHz	CBLU5184540	CERNEX	22051	300004483	ev	-/-	-/-
7	A, B, C	4U RF Switch Platform	L4491A	Agilent Technologies	MY50000032	300004510	ne	-/-	-/-
8	A, B, C	Computer	Intel Core i3 3220/3,3 GHz, Prozessor	-/-	2V2403033A54 21	300004591	ne	-/-	-/-
9	A, B, C	NEXIO EMV-Software	BAT EMC V3.16.0.49	EMCO	-/-	300004682	ne	-/-	-/-
10	A, B, C	Anechoic chamber	-/-	TDK	-/-	300003726	ne	-/-	-/-
11	A, B, C	EMI Test Receiver 9kHz-26,5GHz	ESR26	R&S	101376	300005063	k	14.12.2017	13.12.2018
12	B	RF Amplifier	AFS4-00100800-28-20P-4-R	MITEQ	2008992	300005204	ne	-/-	-/-
13	B	RF-Amplifier	AMF-6F06001800-30-10P-R	NARDA-MITEQ Inc	2011571	300005240	ev	-/-	-/-

6.3 Radiated measurements > 18 GHz

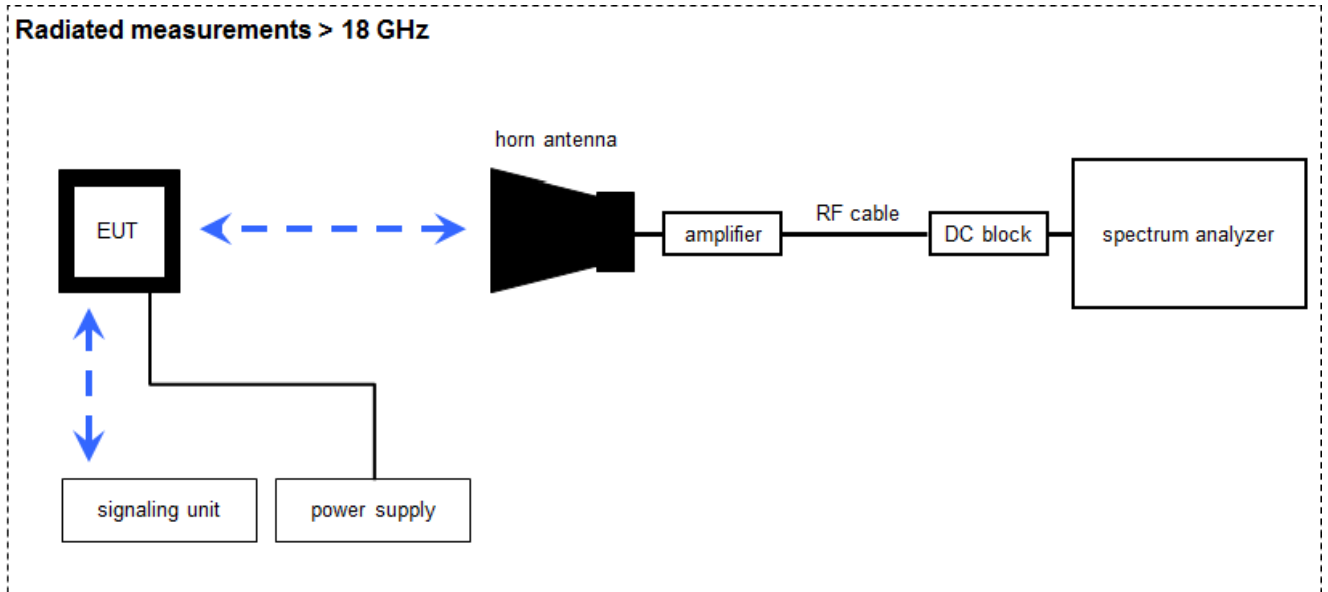

Measurement distance: horn antenna 50 cm

$$FS = UR + CA + AF$$

(FS-field strength; UR-voltage at the receiver; CA-loss signal path & distance correction; AF-antenna factor)

Example calculation:

$$FS [dB\mu V/m] = 40.0 [dB\mu V/m] + (-60.1) [dB] + 36.74 [dB/m] = 16.64 [dB\mu V/m] (6.79 \mu V/m)$$

Equipment table:

No.	Lab / Item	Equipment	Type	Manufacturer	Serial No.	INV. No.	Kind of Calibration	Last Calibration	Next Calibration
1	A	Microwave System Amplifier, 0.5-26.5 GHz	83017A	HP	00419	300002268	ev	-/-	-/-
2	A	Std. Gain Horn Antenna 18.0-26.5 GHz	638	Narda	-/-	300000486	vIKI!	13.12.2017	12.12.2019
3	A	RF-Cable	ST18/SMAM/SMAM/48	Huber & Suhner	Batch no. 127377	400001183	ev	-/-	-/-
4	A	DC-Blocker 0.1-40 GHz	8141A	Inmet	-/-	400001185	ev	-/-	-/-
5	A	Signal Analyzer 40 GHz	FSV40	R&S	101353	300004819	vIKI!	12.12.2017	11.12.2019

6.4 Conducted measurements with peak power meter & spectrum analyzer

Conducted measurements normal conditions

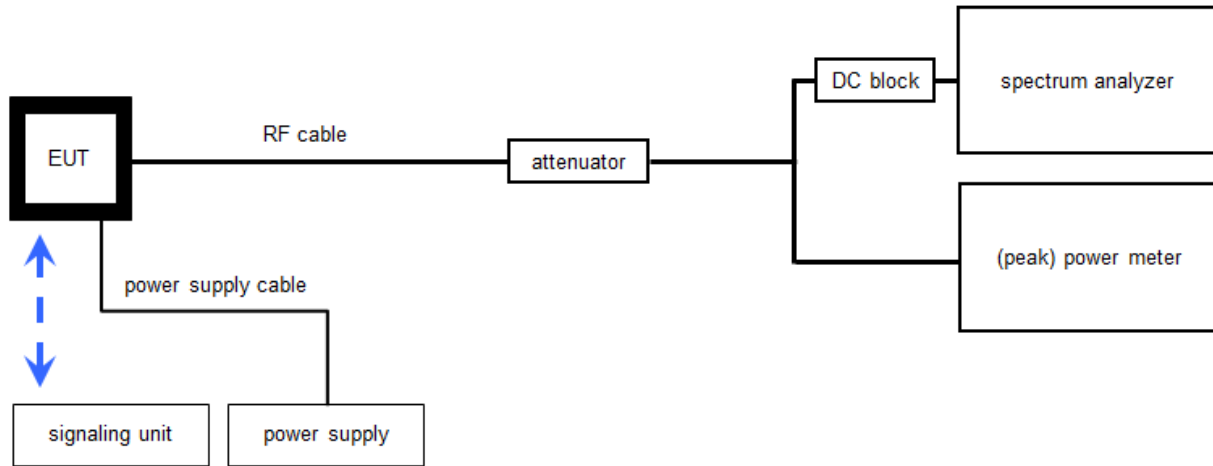

WLAN tester version: 1.1.13; LabView2015

OP = AV + CA
(OP-output power; AV-analyzer value; CA-loss signal path)

Example calculation:

OP [dBm] = 6.0 [dBm] + 11.7 [dB] = 17.7 [dBm] (58.88 mW)

Equipment table:

No.	Lab / Item	Equipment	Type	Manufacturer	Serial No.	INV. No.	Kind of Calibration	Last Calibration	Next Calibration
1	A	DC-Blocker 0.1-40 GHz	8141A	Inmet	-/-	400001185	ev	-/-	-/-
2	A, B	Hygro-Thermometer	-/-, 5-45°C, 20-100%rF	Thies Klima	-/-	400000108	ev	11.05.2018	10.05.2020
3	A	Signal Analyzer 40 GHz	FSV40	R&S	101042	300004517	k	16.01.2018	15.01.2019
4	A, B	PC Tester R005	Intel Core i3 3220/3,3 GHz, Prozessor	-/-	2V2403033A4523	300004589	ne	-/-	-/-
5	A, B	Teststand	Teststand Custom Sequence Editor	National Instruments GmbH	-/-	300004590	ne	-/-	-/-
6	B	Power Sensor	NRP-Z81	R&S	100010	300003780	vKI!	26.01.2017	25.01.2019
7	A, B	RF-Cable	ST18/SMAm/SMAm/60	Huber & Suhner	Batch no. 606844	400001181	ev	-/-	-/-
8	A, B	Coax Attenuator 10 dB 2W 0-40 GHz	MCL BW-K10-2W44+	Mini Circuits	-/-	400001186	ev	-/-	-/-
9	A, B	Synchron Power Meter	SPM-4	CTC	1	300005580	ev	-/-	-/-
10	A	DC-Blocker	WA7046	Weinschel Associates	-/-	400001310	ev	-/-	-/-
11	A, B	DC Power Supply	HMP2020	Rohde & Schwarz	102850	300005517	vKI!	14.12.2017	13.12.2019

7 Sequence of testing

7.1 Sequence of testing radiated spurious 9 kHz to 30 MHz

Setup

- The equipment is set up to simulate normal operation mode as described in the user manual or defined by the manufacturer.
- If the EUT is a tabletop system, it is placed on a table with 0.8 m height.
- If the EUT is a floor standing device, it is placed directly on the turn table.
- Auxiliary equipment and cables are positioned to simulate normal operation conditions as described in ANSI C 63.4.
- The AC power port of the EUT (if available) is connected to a power outlet below the turntable.
- Measurement distance is 3 m (see ANSI C 63.4) – see test details.
- EUT is set into operation.

Premeasurement*

- The turntable rotates from 0° to 315° using 45° steps.
- The antenna height is 1 m.
- At each turntable position the analyzer sweeps with positive-peak detector to find the maximum of all emissions.

Final measurement

- Identified emissions during the pre-measurement are maximized by the software by rotating the turntable from 0° to 360°.
- Loop antenna is rotated about its vertical axis for maximum response at each azimuth about the EUT. (For certain applications, the loop antenna plane may also need to be positioned horizontally at the specified distance from the EUT)
- The final measurement is done in the position (turntable and elevation) causing the highest emissions with quasi-peak (as described in ANSI C 63.4).
- Final levels, frequency, measuring time, bandwidth, turntable position, correction factor, margin to the limit and limit will be recorded. A plot with the graph of the premeasurement and the limit is stored.

*)Note: The sequence will be repeated three times with different EUT orientations.

7.2 Sequence of testing radiated spurious 30 MHz to 1 GHz

Setup

- The equipment is set up to simulate normal operation mode as described in the user manual or defined by the manufacturer.
- If the EUT is a tabletop system, a table with 0.8 m height is used, which is placed on the ground plane.
- If the EUT is a floor standing device, it is placed on the ground plane with insulation between both.
- Auxiliary equipment and cables are positioned to simulate normal operation conditions as described in ANSI C 63.4.
- The AC power port of the EUT (if available) is connected to a power outlet below the turntable.
- Measurement distance is 10 m or 3 m (see ANSI C 63.4) – see test details.
- EUT is set into operation.

Premeasurement

- The turntable rotates from 0° to 315° using 45° steps.
- The antenna is polarized vertical and horizontal.
- The antenna height changes from 1 m to 3 m.
- At each turntable position, antenna polarization and height the analyzer sweeps three times in peak to find the maximum of all emissions.

Final measurement

- The final measurement is performed for at least six highest peaks according to the requirements of the ANSI C63.4.
- Based on antenna and turntable positions at which the peak values are measured the software maximize the peaks by changing turntable position $\pm 45^\circ$ and antenna height between 1 and 4 m.
- The final measurement is done with quasi-peak detector (as described in ANSI C 63.4).
- Final levels, frequency, measuring time, bandwidth, antenna height, antenna polarization, turntable angle, correction factor, margin to the limit and limit are recorded. A plot with the graph of the premeasurement with marked maximum final results and the limit is stored.

7.3 Sequence of testing radiated spurious 1 GHz to 18 GHz

Setup

- The equipment is set up to simulate normal operation mode as described in the user manual or defined by the manufacturer.
- If the EUT is a tabletop system, a 2-axis positioner with 1.5 m height is used.
- If the EUT is a floor standing device, it is placed directly on the turn table.
- Auxiliary equipment and cables are positioned to simulate normal operation conditions as described in ANSI C 63.4.
- The AC power port of the EUT (if available) is connected to a power outlet below the turntable.
- Measurement distance is 3 m (see ANSI C 63.4) – see test details.
- EUT is set into operation.

Premeasurement

- The turntable rotates from 0° to 315° using 45° steps.
- The antenna is polarized vertical and horizontal.
- The antenna height is 1.5 m.
- At each turntable position and antenna polarization the analyzer sweeps with positive peak detector to find the maximum of all emissions.

Final measurement

- The final measurement is performed for at least six highest peaks according to the requirements of the ANSI C63.4.
- Based on antenna and turntable positions at which the peak values are measured the software maximizes the peaks by rotating the turntable from 0° to 360°. This measurement is repeated for different EUT-table positions (0° to 150° in 30°-steps) and for both antenna polarizations.
- The final measurement is done in the position (turntable, EUT-table and antenna polarization) causing the highest emissions with Peak and RMS detector (as described in ANSI C 63.4).
- Final levels, frequency, measuring time, bandwidth, turntable position, EUT-table position, antenna polarization, correction factor, margin to the limit and limit are recorded. A plot with the graph of the premeasurement with marked maximum final results and the limit is stored.

7.4 Sequence of testing radiated spurious above 18 GHz

Setup

- The equipment is set up to simulate normal operation mode as described in the user manual or defined by the manufacturer.
- Auxiliary equipment and cables are positioned to simulate normal operation conditions as described in ANSI C 63.4.
- The AC power port of the EUT (if available) is connected to a power outlet.
- The measurement distance is as appropriate (e.g. 0.5 m).
- The EUT is set into operation.

Premeasurement

- The test antenna is handheld and moved carefully over the EUT to cover the EUT's whole sphere and different polarizations of the antenna.

Final measurement

- The final measurement is performed at the position and antenna orientation causing the highest emissions with Peak and RMS detector (as described in ANSI C 63.4).
- Final levels, frequency, measuring time, bandwidth, correction factor, margin to the limit and limit are recorded. A plot with the graph of the premeasurement and the limit is stored.

8 Measurement uncertainty

Measurement uncertainty	
Test case	Uncertainty
Antenna gain	± 3 dB
Power spectral density	± 1.5 dB
DTS bandwidth	± 100 kHz (depends on the used RBW)
Occupied bandwidth	± 100 kHz (depends on the used RBW)
Maximum output power	± 1.5 dB
Detailed spurious emissions @ the band edge - conducted	± 1.5 dB
Band edge compliance radiated	± 3 dB
Spurious emissions conducted	± 3 dB
Spurious emissions radiated below 30 MHz	± 3 dB
Spurious emissions radiated 30 MHz to 1 GHz	± 3 dB
Spurious emissions radiated 1 GHz to 12.75 GHz	± 3.7 dB
Spurious emissions radiated above 12.75 GHz	± 4.5 dB
Spurious emissions conducted below 30 MHz (AC conducted)	± 2.6 dB

9 Summary of measurement results

<input checked="" type="checkbox"/>	No deviations from the technical specifications were ascertained
<input type="checkbox"/>	There were deviations from the technical specifications ascertained
<input type="checkbox"/>	This test report is only a partial test report. The content and verdict of the performed test cases are listed below.

TC Identifier	Description	Verdict	Date	Remark
RF-Testing	CFR Part 15 RSS - 247, Issue 2	See table!	2019-09-13	-/-

Test specification clause	Test case	Guideline	Temperature conditions	Power source voltages	Mode	C	NC	NA	NP	Remark
§15.247(b)(4) RSS - 247 / 5.4 (f)(ii)	Antenna gain	-/-	Nominal	Nominal	DSSS	-/-				-/-
§15.35	Duty cycle	-/-	Nominal	Nominal	DSSS OFDM	-/-				-/-
§15.247(e) RSS - 247 / 5.2 (b)	Power spectral density	KDB 558074 DTS clause: 8.4	Nominal	Nominal	DSSS OFDM	<input checked="" type="checkbox"/>	<input type="checkbox"/>	<input type="checkbox"/>	<input type="checkbox"/>	-/-
§15.247(a)(2) RSS - 247 / 5.2 (a)	DTS bandwidth	KDB 558074 DTS clause: 8.2	Nominal	Nominal	DSSS OFDM	<input checked="" type="checkbox"/>	<input type="checkbox"/>	<input type="checkbox"/>	<input type="checkbox"/>	-/-
RSS Gen clause 4.6.1	Occupied bandwidth	-/-	Nominal	Nominal	DSSS OFDM	<input checked="" type="checkbox"/>	<input type="checkbox"/>	<input type="checkbox"/>	<input type="checkbox"/>	-/-
§15.247(b)(3) RSS - 247 / 5.4 (d)	Maximum output power	KDB 558074 DTS clause: 8.3.1.3	Nominal	Nominal	DSSS OFDM	<input checked="" type="checkbox"/>	<input type="checkbox"/>	<input type="checkbox"/>	<input type="checkbox"/>	-/-
§15.247(d) RSS - 247 / 5.5	Detailed spurious emissions @ the band edge – cond.	-/-	Nominal	Nominal	DSSS OFDM	<input checked="" type="checkbox"/>	<input type="checkbox"/>	<input type="checkbox"/>	<input type="checkbox"/>	-/-
§15.205 RSS - 247 / 5.5 RSS - Gen	Band edge compliance cond. & rad.	KDB 558074 DTS clause: 8.7.3	Nominal	Nominal	DSSS OFDM	<input checked="" type="checkbox"/>	<input type="checkbox"/>	<input type="checkbox"/>	<input type="checkbox"/>	-/-
§15.247(d) RSS - 247 / 5.5	TX spurious emissions cond.	KDB 558074 DTS clause: 8.5	Nominal	Nominal	DSSS OFDM	<input checked="" type="checkbox"/>	<input type="checkbox"/>	<input type="checkbox"/>	<input type="checkbox"/>	-/-
§15.209(a) RSS-Gen	TX spurious emissions rad. below 30 MHz	-/-	Nominal	Nominal	DSSS OFDM	<input checked="" type="checkbox"/>	<input type="checkbox"/>	<input type="checkbox"/>	<input type="checkbox"/>	-/-
§15.247(d) RSS - 247 / 5.5 RSS-Gen	TX spurious emissions rad. 30 MHz to 1 GHz	-/-	Nominal	Nominal	DSSS OFDM	<input checked="" type="checkbox"/>	<input type="checkbox"/>	<input type="checkbox"/>	<input type="checkbox"/>	-/-
§15.247(d) RSS - 247 / 5.5 RSS-Gen	TX spurious emissions rad. above 1 GHz	-/-	Nominal	Nominal	DSSS OFDM	<input checked="" type="checkbox"/>	<input type="checkbox"/>	<input type="checkbox"/>	<input type="checkbox"/>	-/-
§15.109 RSS-Gen	RX spurious emissions rad. 30 MHz to 1 GHz	-/-	Nominal	Nominal	RX / idle	<input checked="" type="checkbox"/>	<input type="checkbox"/>	<input type="checkbox"/>	<input type="checkbox"/>	-/-
§15.109 RSS-Gen	RX spurious emissions rad. above 1 GHz	-/-	Nominal	Nominal	RX / idle	<input checked="" type="checkbox"/>	<input type="checkbox"/>	<input type="checkbox"/>	<input type="checkbox"/>	-/-
§15.107(a) §15.207	Conducted emissions < 30 MHz	-/-	Nominal	Nominal	DSSS OFDM	<input checked="" type="checkbox"/>	<input type="checkbox"/>	<input type="checkbox"/>	<input type="checkbox"/>	-/-

Notes:

C	Compliant	NC	Not compliant	NA	Not applicable	NP	Not performed
----------	-----------	-----------	---------------	-----------	----------------	-----------	---------------

10 Additional comments

Reference documents: None

Special test descriptions: None

Configuration descriptions: None

Provided channels:

Channels with 20 MHz channel bandwidth:

channel number & center frequency													
channel	1	2	3	4	5	6	7	8	9	10	11	12	13
f _c / MHz	2412	2417	2422	2427	2432	2437	2442	2447	2452	2457	2462	2467	2472

Channels with 40 MHz channel bandwidth:

channel number & center frequency													
channel	-/-	-/-	3	4	5	6	7	8	9	10	11	-/-	-/-
f _c / MHz	-/-	-/-	2422	2427	2432	2437	2442	2447	2452	2457	2462	-/-	-/-

Note: The channels used for the tests are marked in bold in the list.

11 Additional EUT parameter

- Test mode:
- No test mode available
Iperf was used to ping another device with the largest support packet size
 - Test mode available
Special software is used.
EUT is transmitting pseudo random data by itself
- Modulation types:
- Wide Band Modulation (None Hopping – e.g. DSSS, OFDM)
 - Frequency Hopping Spread Spectrum (FHSS)
- Antennas and transmit operating modes:
- Operating mode 1 (single antenna)
 - *Equipment with 1 antenna,*
 - *Equipment with 2 diversity antennas operating in switched diversity mode by which at any moment in time only 1 antenna is used,*
 - *Smart antenna system with 2 or more transmit/receive chains, but operating in a mode where only 1 transmit/receive chain is used)*
 - Operating mode 2 (multiple antennas, no beamforming)
 - *Equipment operating in this mode contains a smart antenna system using two or more transmit/receive chains simultaneously but without beamforming.*
 - Operating mode 3 (multiple antennas, with beamforming)
 - *Equipment operating in this mode contains a smart antenna system using two or more transmit/receive chains simultaneously with beamforming.
In addition to the antenna assembly gain (G), the beamforming gain (Y) may have to be taken into account when performing the measurements.*

12 Measurement results

12.1 Antenna gain

Description:

The antenna gain of the complete system is calculated by the difference of radiated power (@ 3 MHz) in EIRP and the conducted power (@ 3 MHz) of the module.

Measurement:

Measurement parameter	
Detector	Peak
Sweep time	Auto
Resolution bandwidth	3 MHz
Video bandwidth	3 MHz / 10 MHz
Trace mode	Max hold
Test setup	See chapter 6.4 A (conducted) See chapter 6.2 A (radiated)
Measurement uncertainty	See chapter 8

Limits:

FCC	IC
6 dBi / > 6 dBi output power and power density reduction required	

Results:

	lowest channel	middle channel	highest channel
Conducted power [dBm] Measured with DSSS modulation	10.0	10.4	10.4
Radiated power [dBm] Measured with DSSS modulation	5.2	6.4	7.0
Gain [dBi] / Calculated	-4.8	-4.0	-3.4

Plots: DSSS / b – mode

Plot 1: Lowest channel

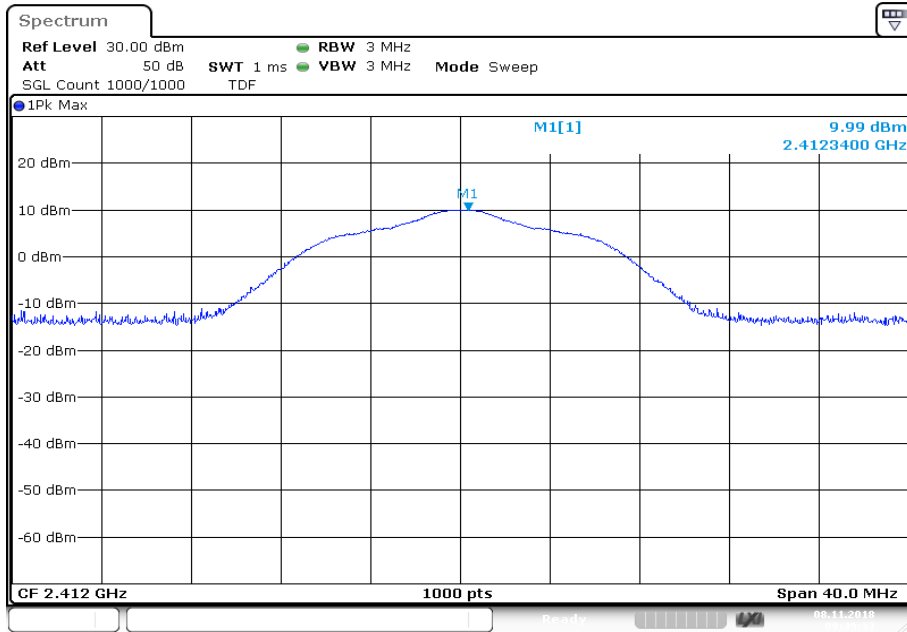

Plot 2: Middle channel

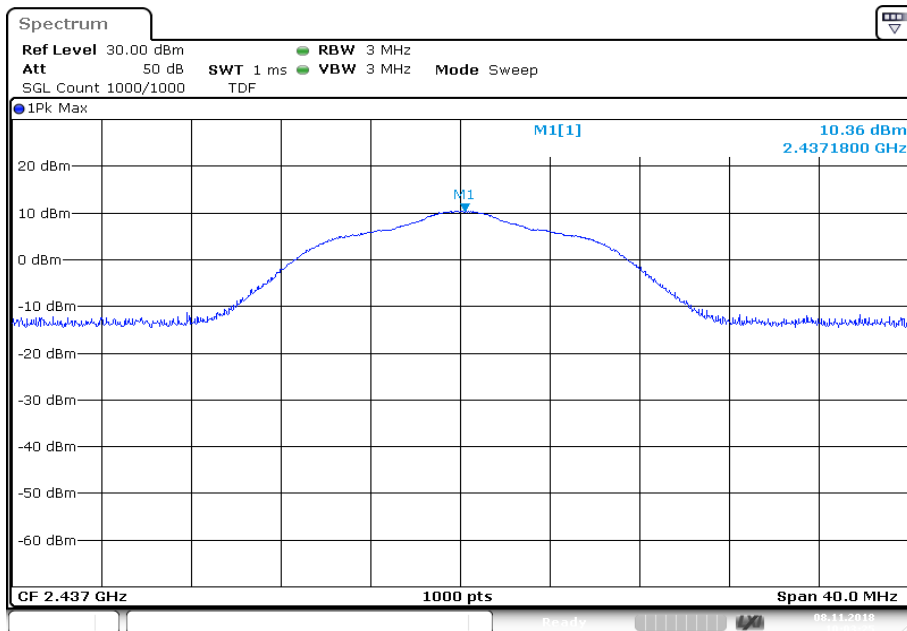

Plot 3: Highest channel

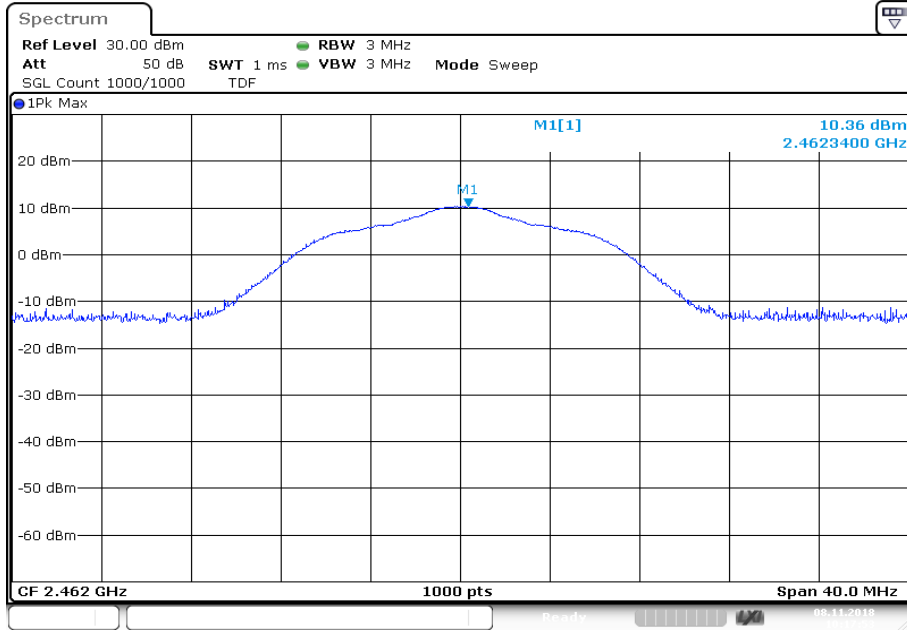

Date: 8.NOV.2018 10:17:53

12.2 Identify worst case data rate

Measurement:

All modes of the module will be measured with an average power meter or spectrum analyzer to identify the maximum transmission power.

In further tests only the identified worst case modulation scheme or bandwidth will be measured and this mode is used as representative mode for all other modulation schemes.

Additional the band edge compliance test will be performed in the lowest and highest modulation scheme.

Measurement:

Measurement parameter	
Detector	Peak
Sweep time	Auto
Resolution bandwidth	3 MHz
Video bandwidth	3 MHz
Trace mode	Max hold
Test setup	See chapter 6.4 A
Measurement uncertainty	-/-

Results:

Modulation scheme / bandwidth	
DSSS / b – mode	1 Mbit/s
OFDM / g – mode	6 Mbit/s
OFDM / n HT20 – mode	MCS0
OFDM / n HT40 – mode	MCS0

12.3 Maximum output power

Description:

Measurement of the maximum output power conducted and radiated. The measurements are performed using the data rate producing the highest conducted output power.

Measurement:

Measurement parameter	
According to DTS clause: 8.3.1.3	
Peak power meter	
Test setup	See chapter 6.2 B
Measurement uncertainty	See chapter 8

Limits:

FCC	IC
Conducted 1.0 W / 30 dBm with an antenna gain of max. 6 dBi	

Results:

	maximum output power / dBm		
	lowest channel	middle channel	highest channel
Output power conducted DSSS / b – mode	12.0	12.4	12.5
Output power conducted OFDM / g – mode	17.6	17.9	17.9
Output power conducted OFDM / n HT20 – mode	17.7	18.0	18.0
Output power conducted OFDM / n HT40 – mode	17.9	18.0	18.0

12.4 Duty cycle

Description:

Measurement of the timing behavior.

Measurement:

Measurement parameter	
Detector	Peak
Sweep time	Depends on the signal see plot
Resolution bandwidth	10 MHz
Video bandwidth	10 MHz
Trace mode	Max hold
Test setup	See chapter 6.2 A
Measurement uncertainty	See chapter 8

Limits:

FCC	IC
No limitation!	

Results:

T_{nom}	V_{nom}	lowest channel	middle channel	highest channel
DSSS / b – mode		99.1 % / 0.04 dB	99.1 % / 0.04 dB	98.8 % / 0.05 dB
OFDM / g – mode		93.4 % / 0.30 dB	93.4 % / 0.30 dB	93.1 % / 0.31 dB
OFDM / n HT20 – mode		92.8 % / 0.32 dB	92.8 % / 0.32 dB	92.8 % / 0.32 dB
OFDM / n HT40 – mode		86.2 % / 0.64 dB	85.9 % / 0.66 dB	86.2 % / 0.64 dB

Plots: DSSS / b – mode

Plot 1: Lowest channel

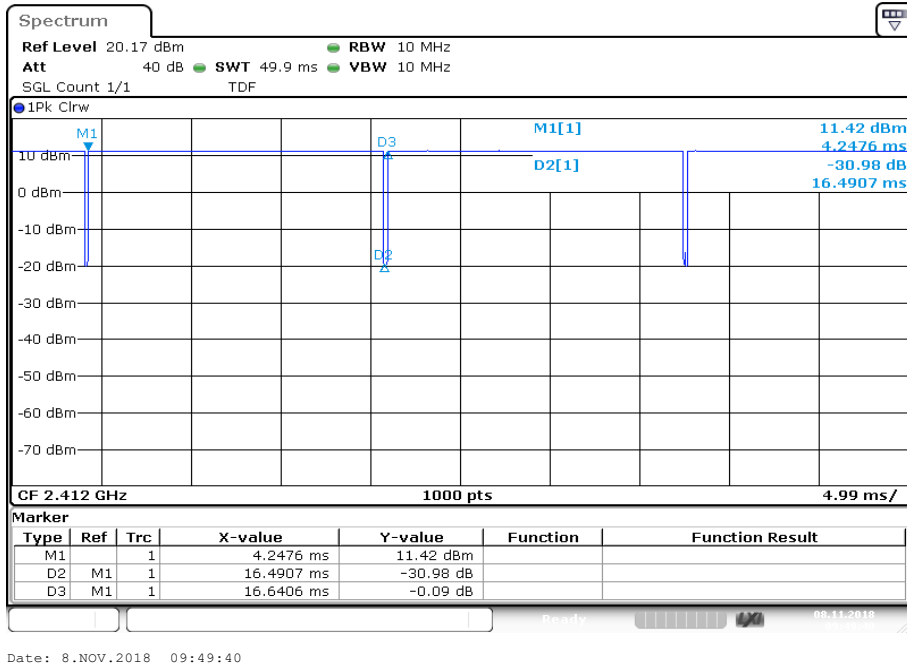

Plot 2: Middle channel

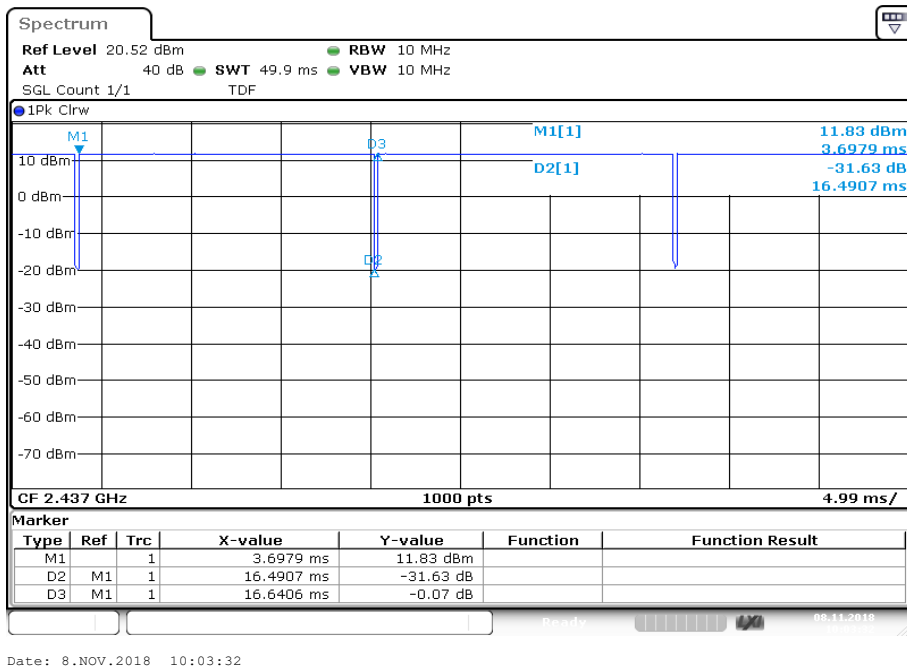

Plot 3: Highest channel

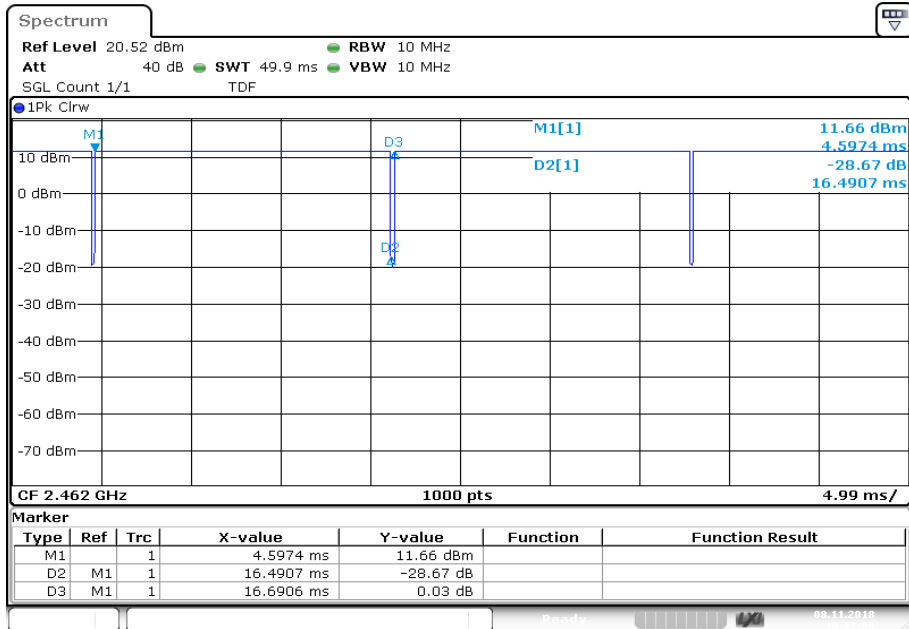

Date: 8.NOV.2018 10:17:59

Plots: OFDM / g – mode

Plot 1: Lowest channel

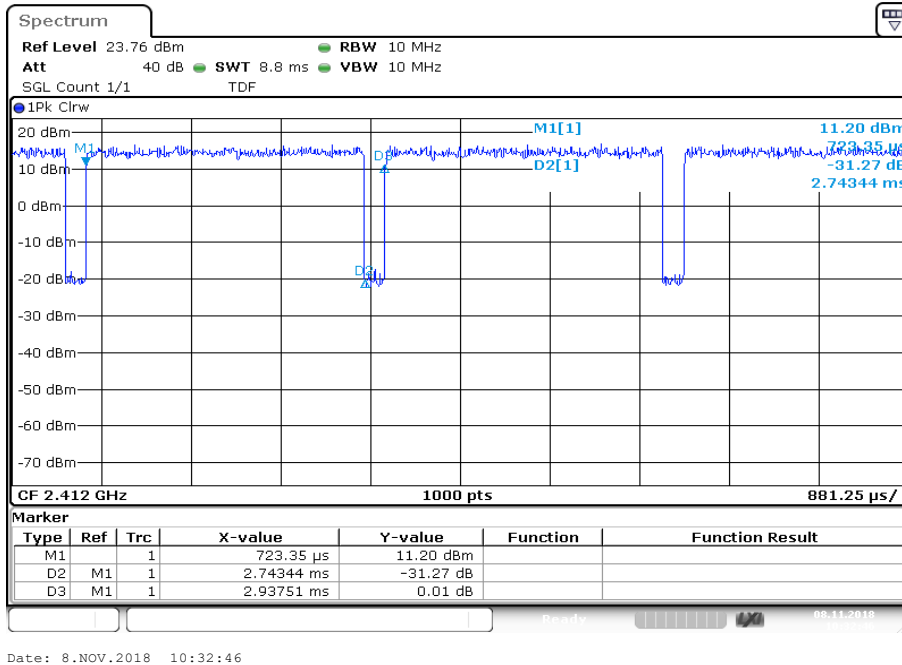

Plot 2: Middle channel

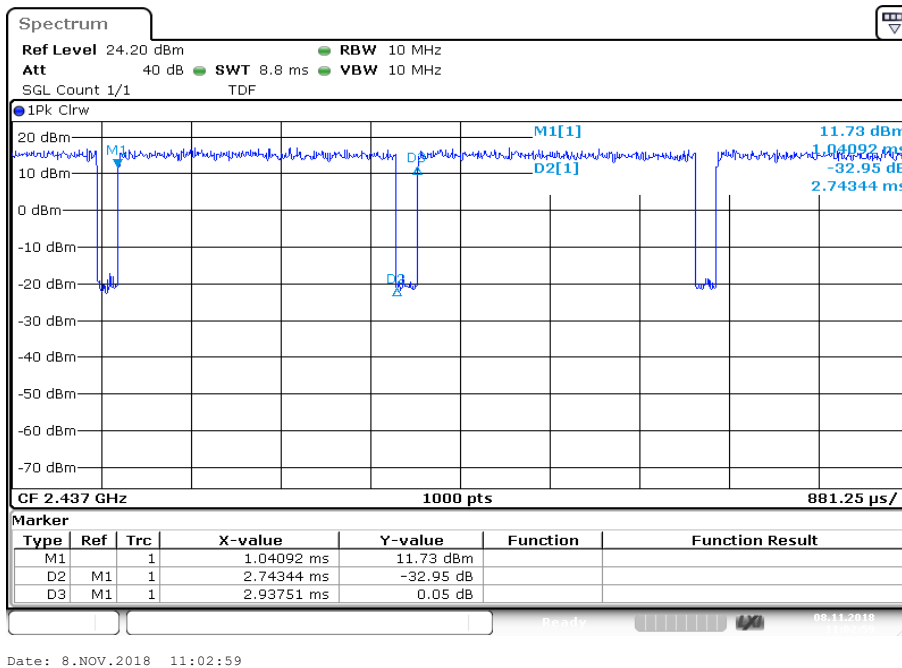

Plot 3: Highest channel

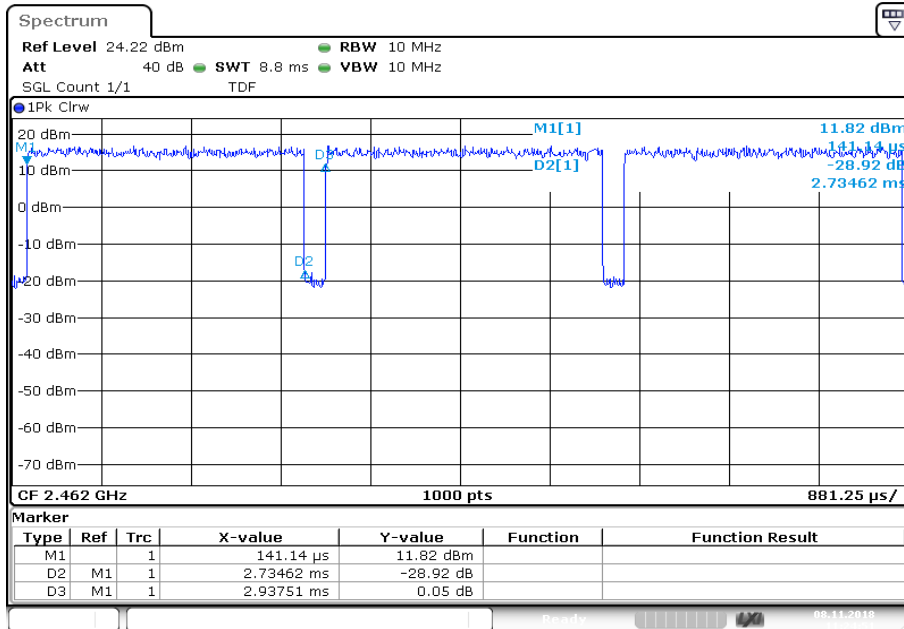

Date: 8.NOV.2018 11:24:51

Plots: OFDM / n HT20 – mode

Plot 1: Lowest channel

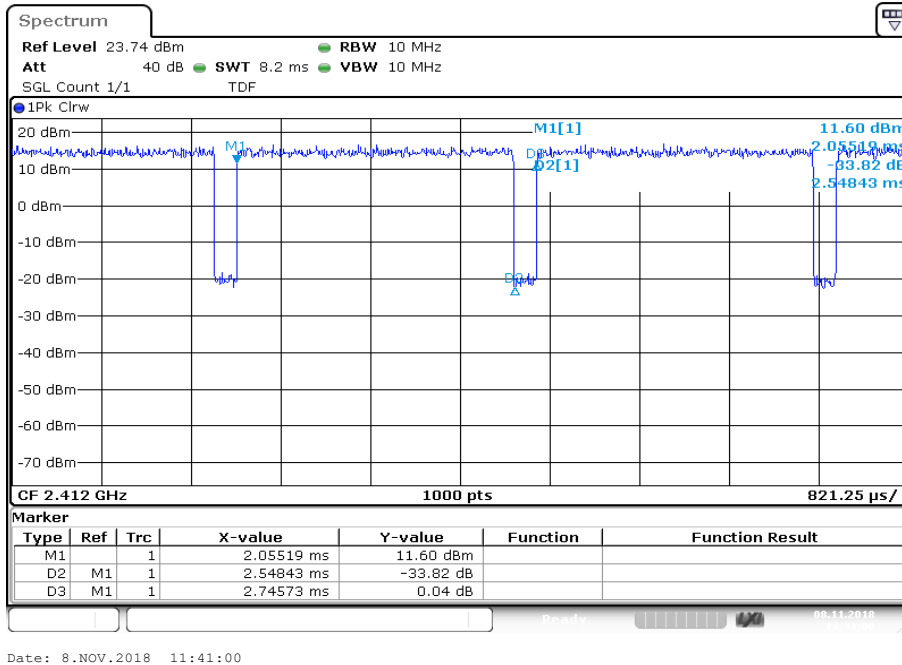

Plot 2: Middle channel

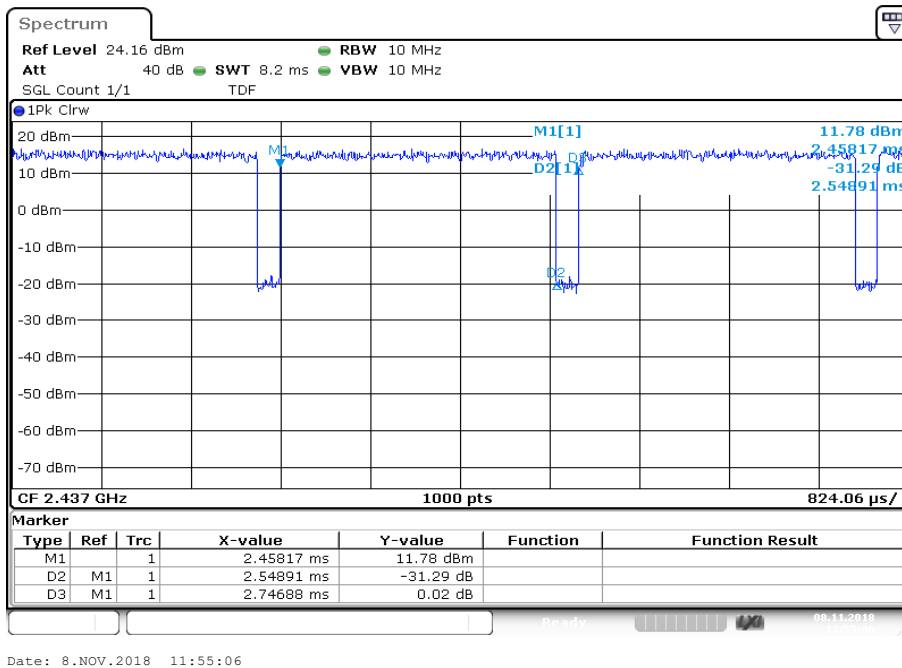

Plot 3: Highest channel

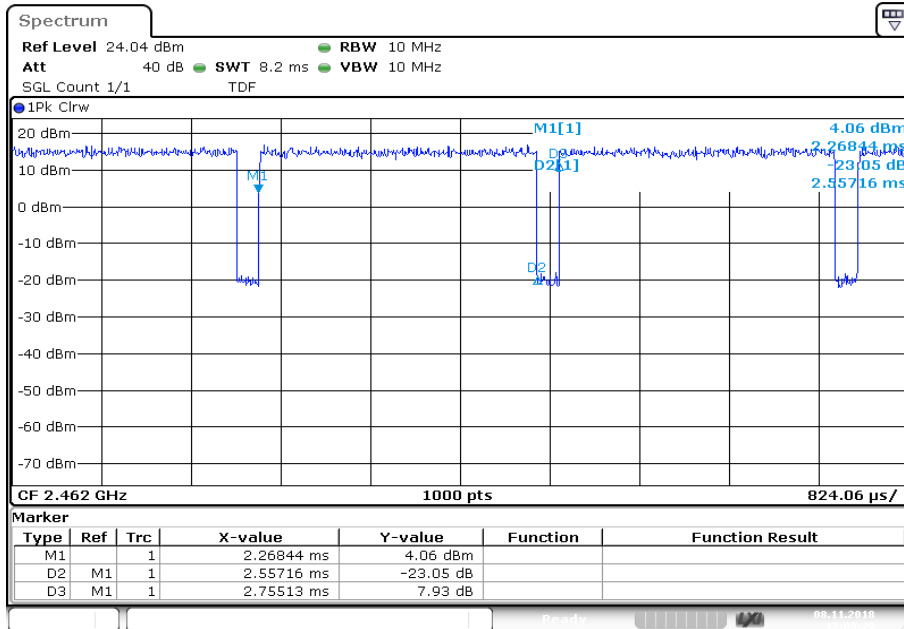

Date: 8.NOV.2018 12:09:29

Plots: OFDM / n HT40 – mode

Plot 1: Lowest channel

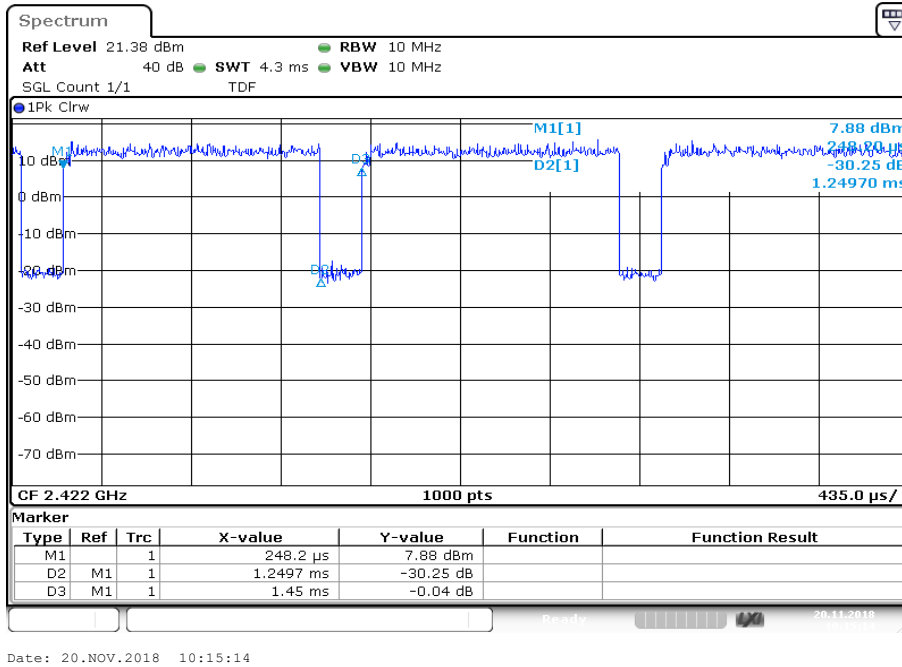

Plot 2: Middle channel

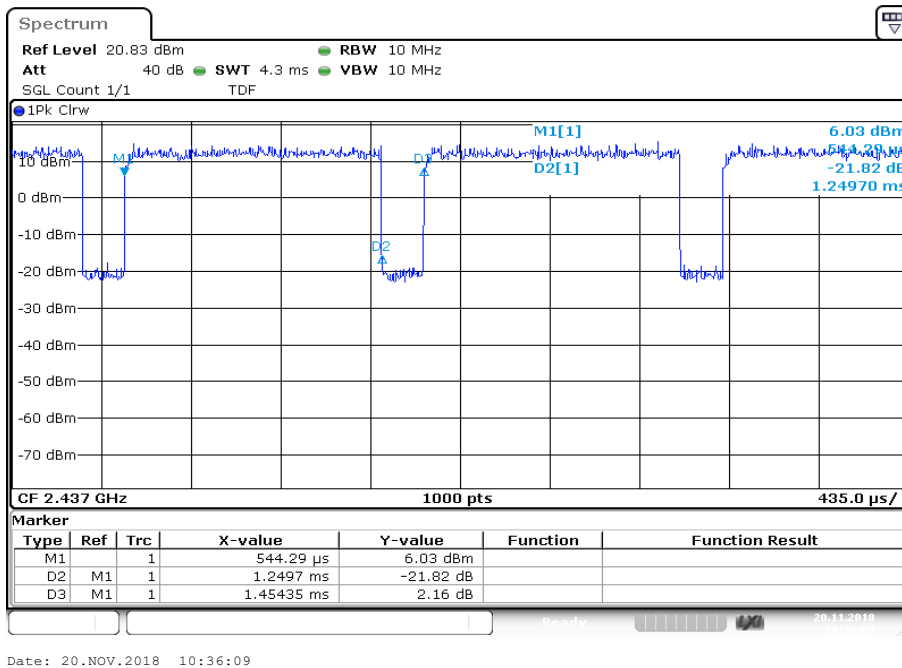

Plot 3: Highest channel

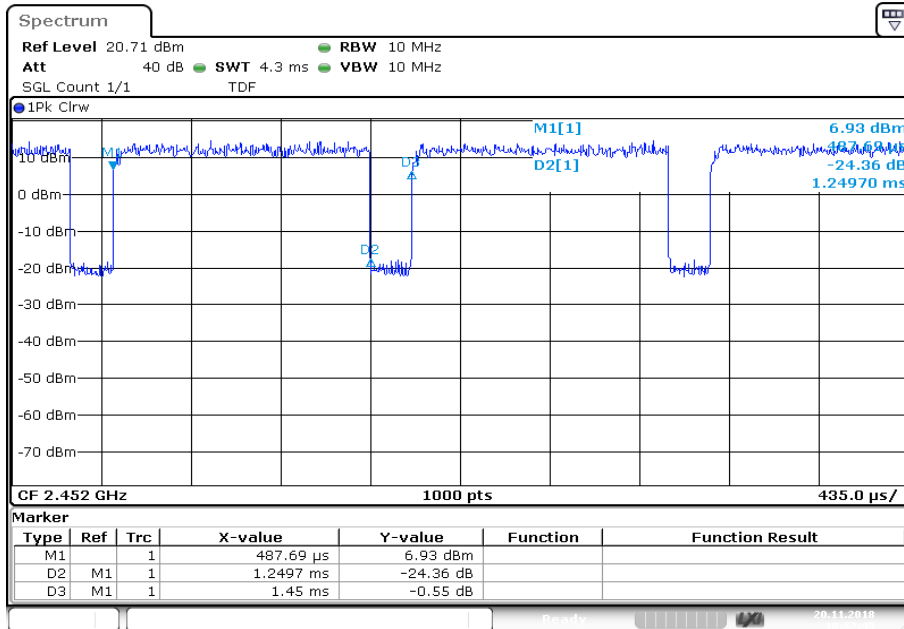

Date: 20.NOV.2018 10:52:45

12.5 Peak power spectral density

Description:

Measurement of the peak power spectral density of a digital modulated system. The PSD shows the strength of the variations as a function of the frequency. The measurement is repeated for both modulations at the lowest, middle and highest channel.

Measurement:

Measurement parameter	
According to DTS clause: 8.4	
Detector	Positive Peak
Sweep time	Auto
Resolution bandwidth	100 kHz
Video bandwidth	300 kHz
Span	30 MHz
Trace mode	Max. hold (allow trace to fully stabilize)
Test setup	See chapter 6.2 A
Measurement uncertainty	See chapter 8

Limits:

FCC	IC
8 dBm / 3 kHz (conducted)	

Results:

measured	peak power spectral density / dBm @ 100 kHz		
	Lowest channel	Middle channel	Highest channel
DSSS / b – mode	0.80	0.71	0.72
OFDM / g – mode	-1.30	-0.80	-0.69
OFDM / n HT20 – mode	-0.84	-0.45	-0.54
OFDM / n HT40 – mode	-3.44	-3.66	-3.36

Formula for PKPSD calculation: $PKPSD_{calculated} = PKPSD_{measured} + 10 \cdot \log(3\text{kHz}/RBW_{measured}[\text{kHz}])$

calculated	peak power spectral density / dBm @ 3 kHz		
	Lowest channel	Middle channel	Highest channel
DSSS / b – mode	-14.43	-14.52	-14.51
OFDM / g – mode	-16.53	-16.03	-15.92
OFDM / n HT20 – mode	-16.07	-15.68	-15.77
OFDM / n HT40 – mode	-18.67	-18.89	-18.59

Plots: DSSS / b – mode

Plot 1: Lowest channel

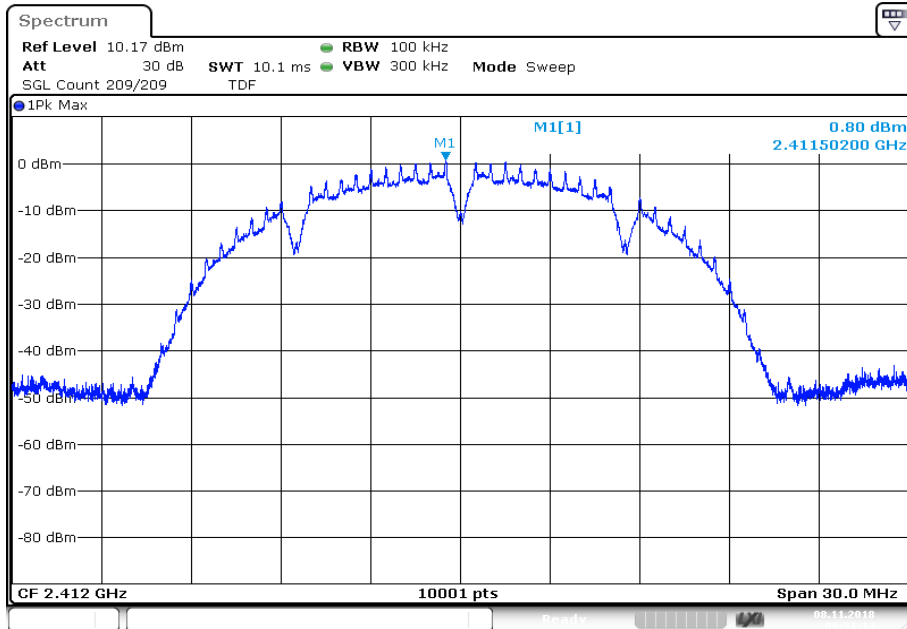

Plot 2: Middle channel

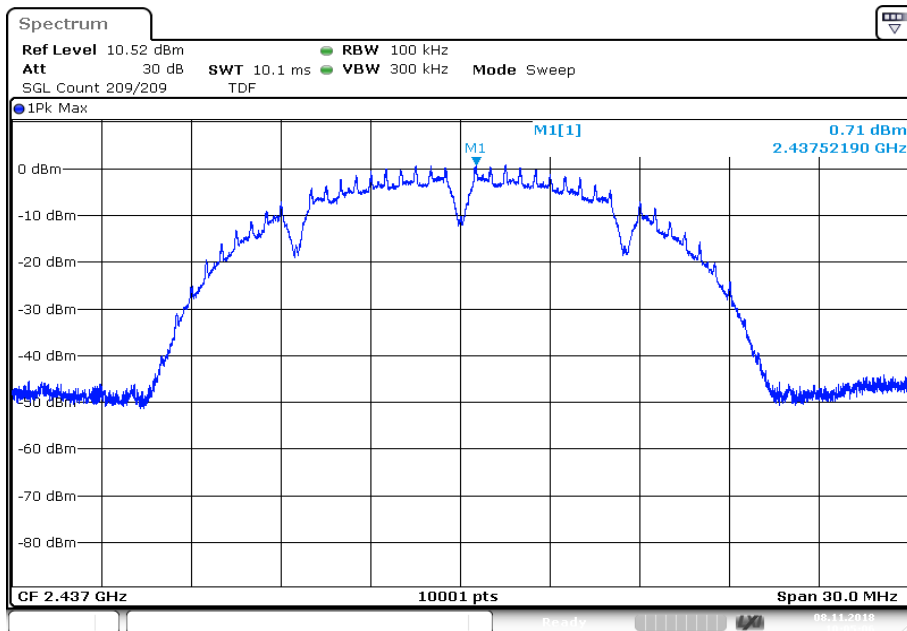

Plot 3: Highest channel

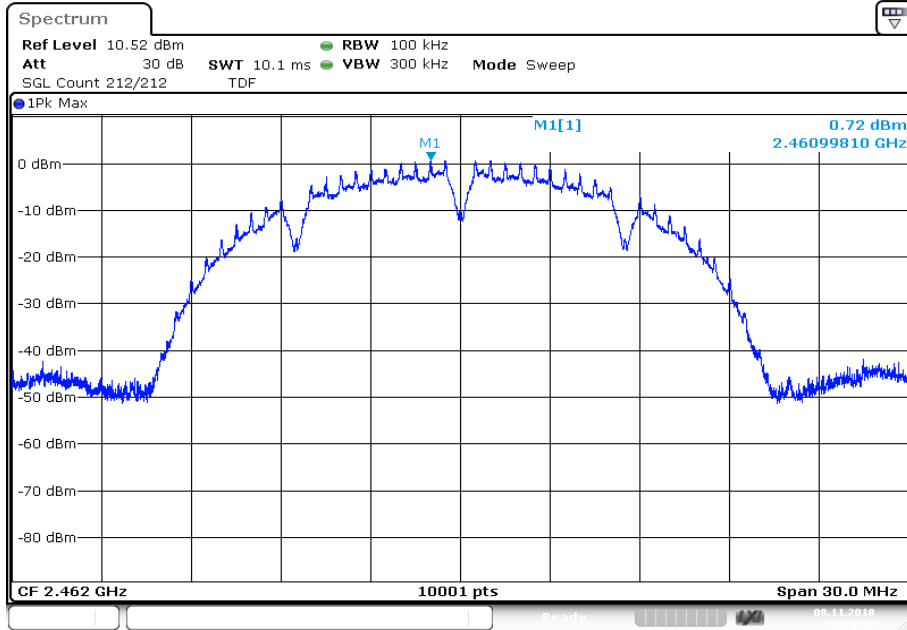

Date: 8.NOV.2018 10:19:37

Plots: OFDM / g – mode

Plot 1: Lowest channel

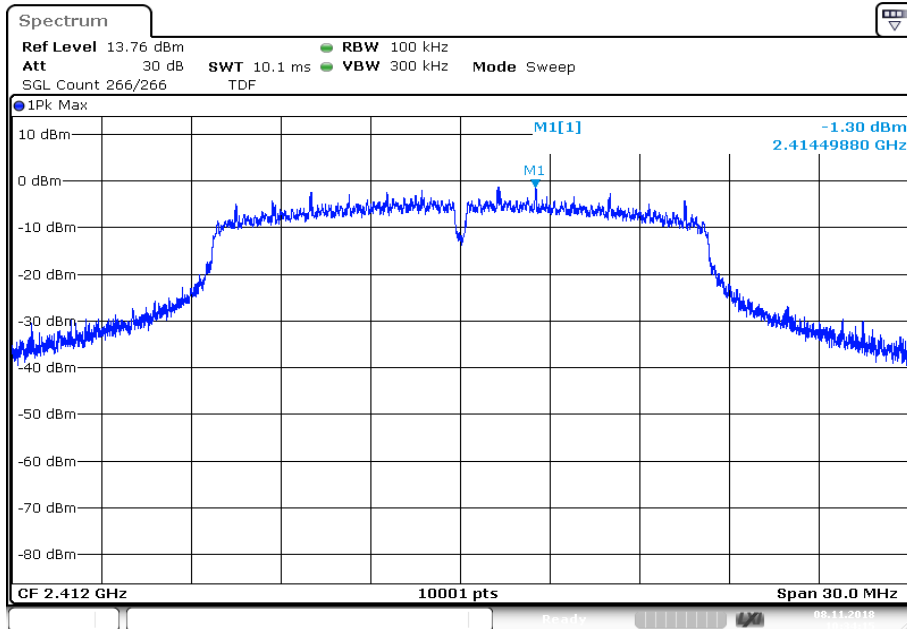

Date: 8.NOV.2018 10:34:15

Plot 2: Middle channel

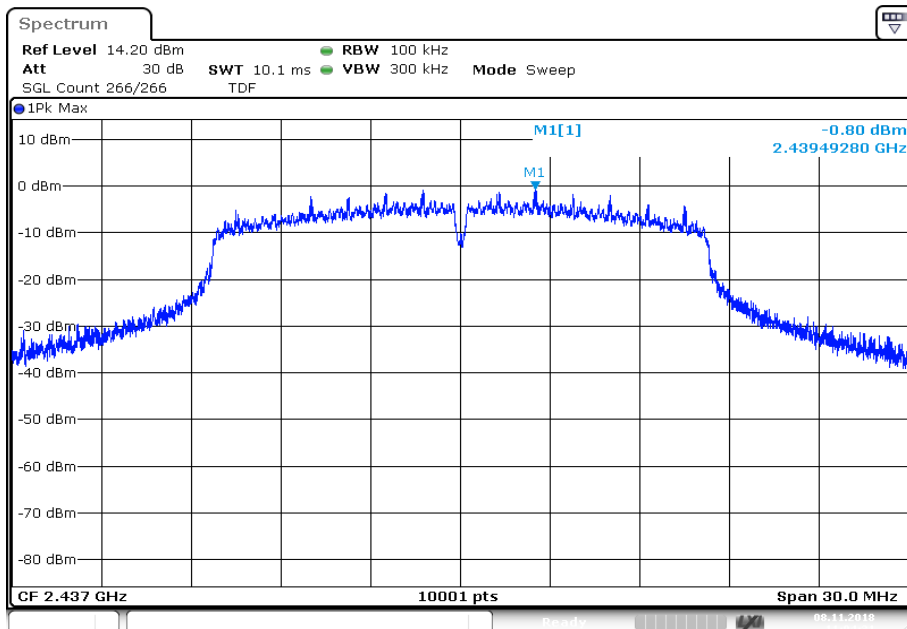

Date: 8.NOV.2018 11:04:31

Plot 3: Highest channel

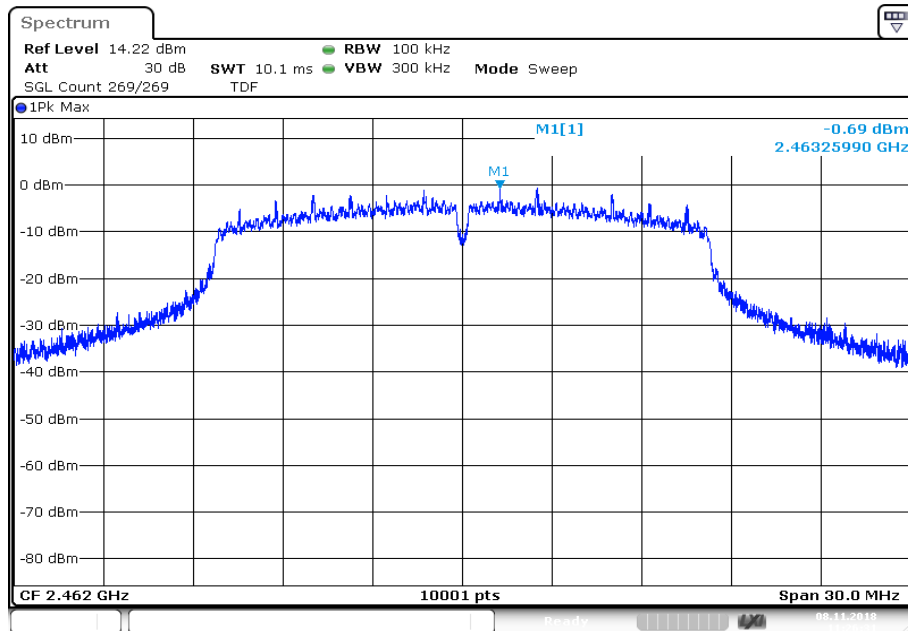

Date: 8.NOV.2018 11:26:31

Plots: OFDM / n HT20 – mode

Plot 1: Lowest channel

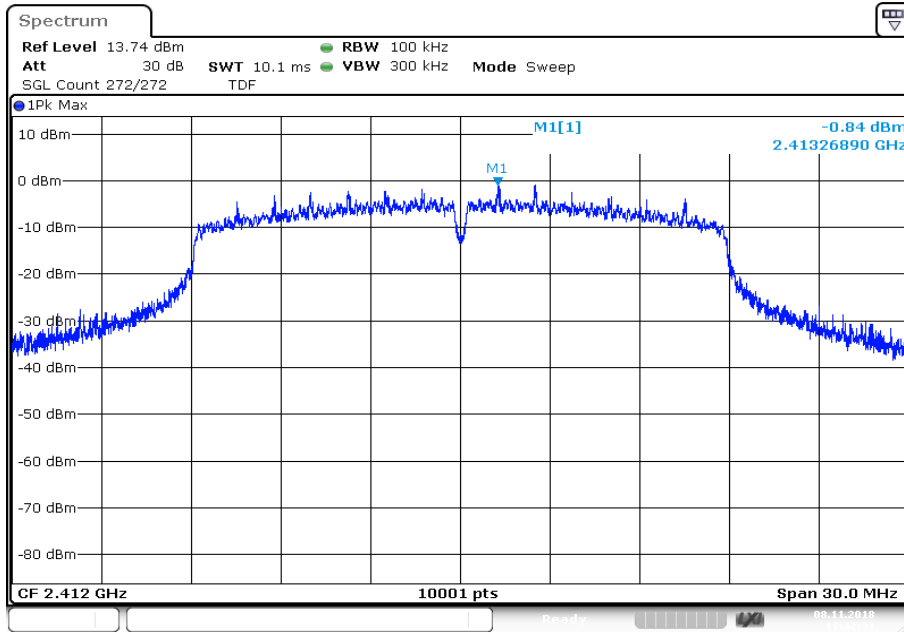

Date: 8.NOV.2018 11:42:31

Plot 2: Middle channel

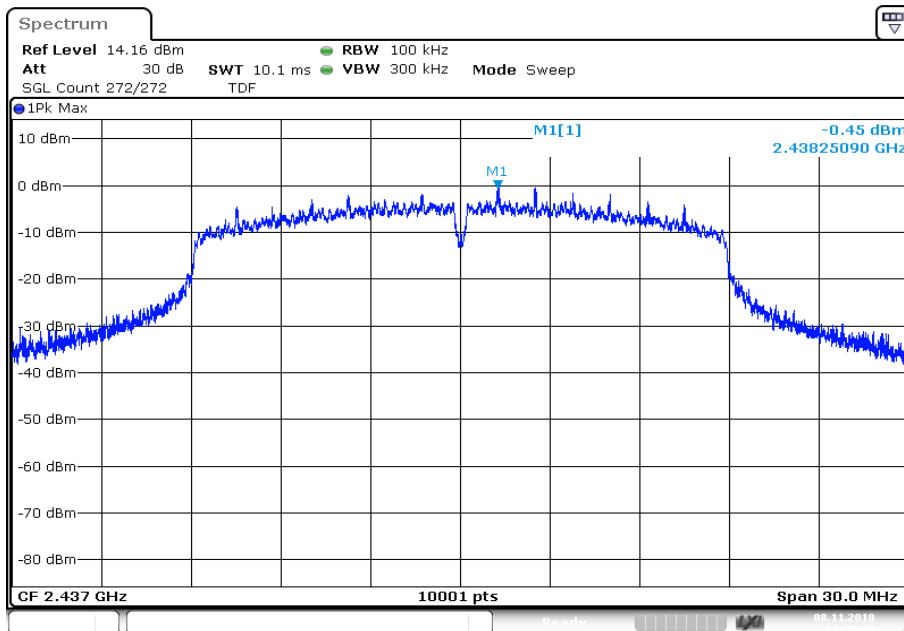

Date: 8.NOV.2018 11:56:40

Plot 3: Highest channel

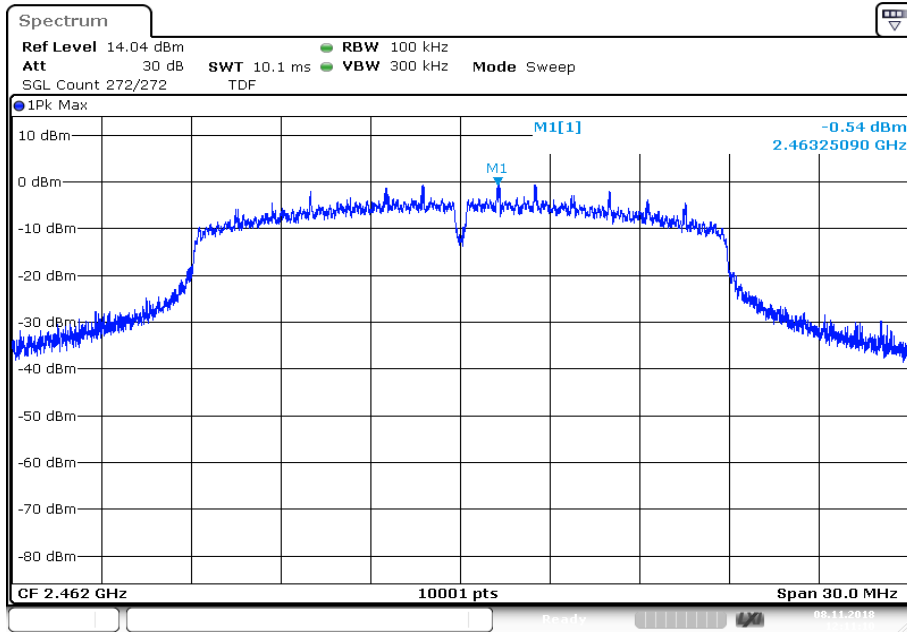

Date: 8.NOV.2018 12:11:10

Plots: OFDM / n HT40 – mode

Plot 1: Lowest channel

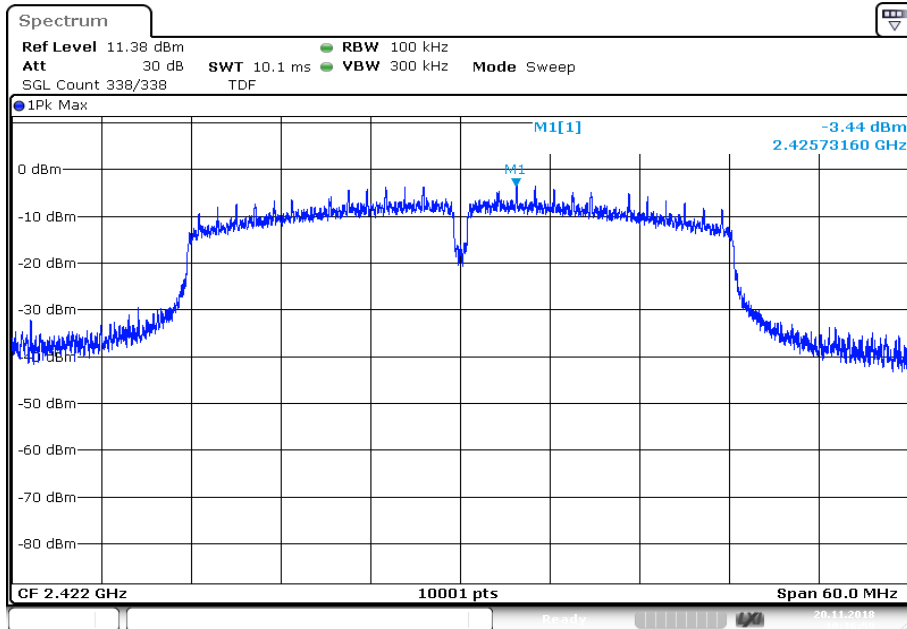

Date: 20.NOV.2018 10:17:00

Plot 2: Middle channel

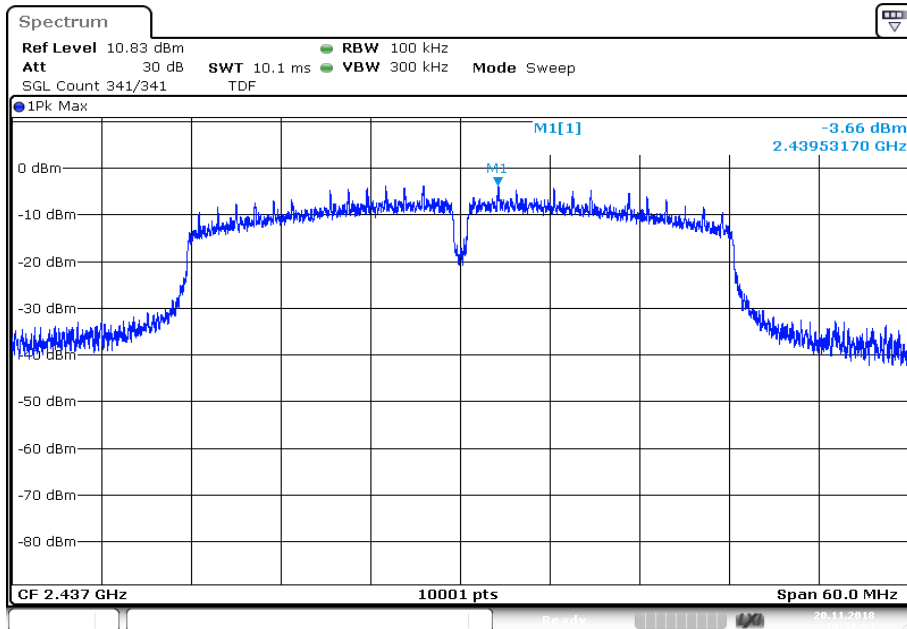

Date: 20.NOV.2018 10:37:54

Plot 3: Highest channel

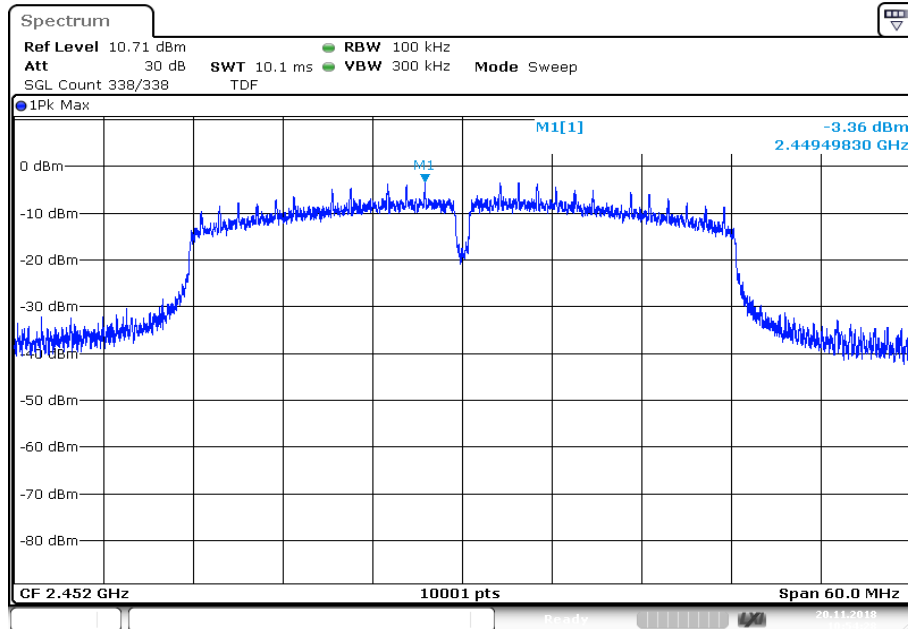

Date: 20.NOV.2018 10:54:29

12.6 6 dB DTS bandwidth

Description:

Measurement of the 6 dB bandwidth of the modulated signal.

Measurement:

Measurement parameter	
According to DTS clause: 8.2	
Detector	Peak
Sweep time	Auto
Resolution bandwidth	100 kHz
Video bandwidth	500 kHz
Span	30 MHz / 50 MHz
Trace mode	Single count with 200 counts
Test setup	See chapter 6.2 A
Measurement uncertainty	See chapter 8

Limits:

FCC	IC
Systems using digital modulation techniques may operate in the 2400–2483.5 MHz band. The minimum 6 dB bandwidth shall be at least 500 kHz.	

Results:

	6 dB DTS bandwidth / kHz		
	lowest channel	middle channel	highest channel
DSSS / b – mode	10052	10037	10034
OFDM / g – mode	15112	15100	15074
OFDM / n HT20 – mode	15115	15101	15097
OFDM / n HT40 – mode	33836	33825	33831

Plots: DSSS / b – mode

Plot 1: Lowest channel

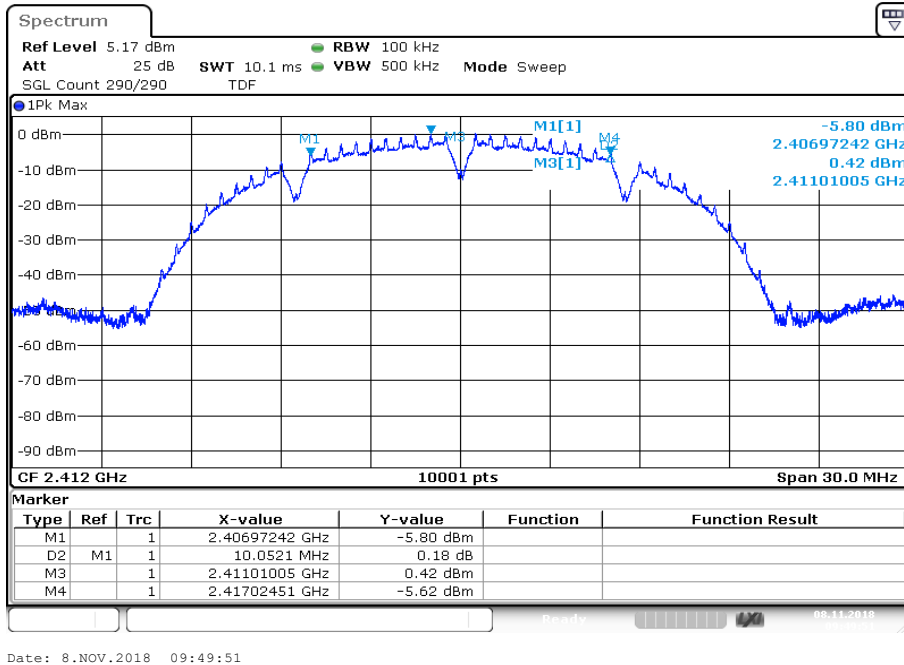

Plot 2: Middle channel

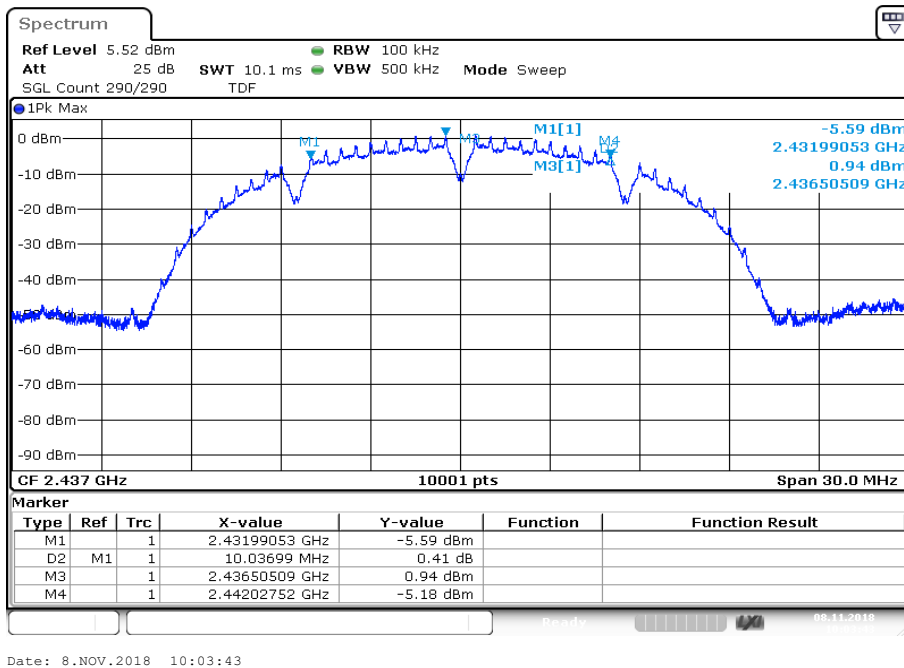

Plot 3: Highest channel

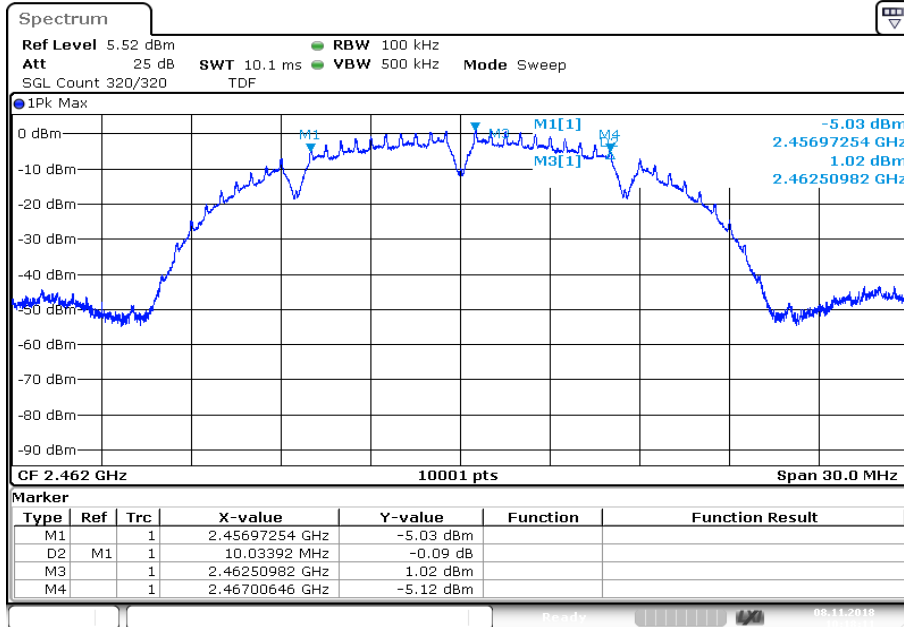

Date: 8.NOV.2018 10:18:11

Plots: OFDM / g – mode

Plot 1: Lowest channel

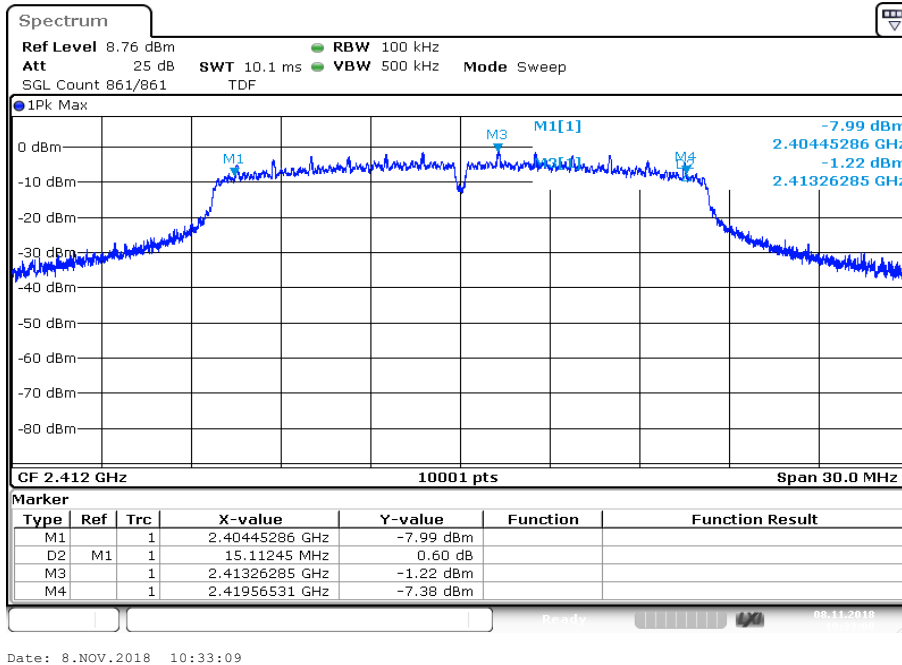

Plot 2: Middle channel

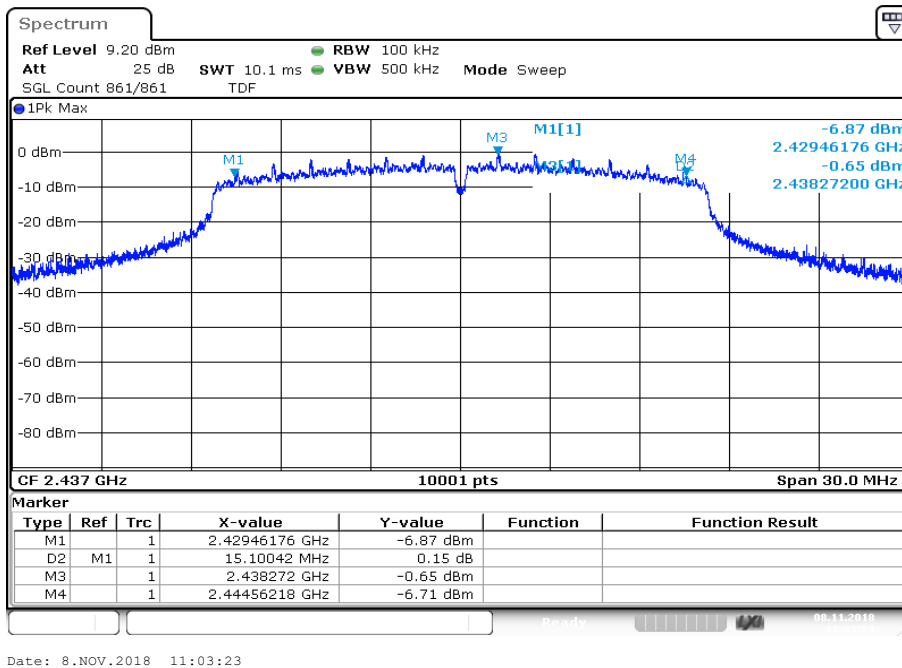

Plot 3: Highest channel

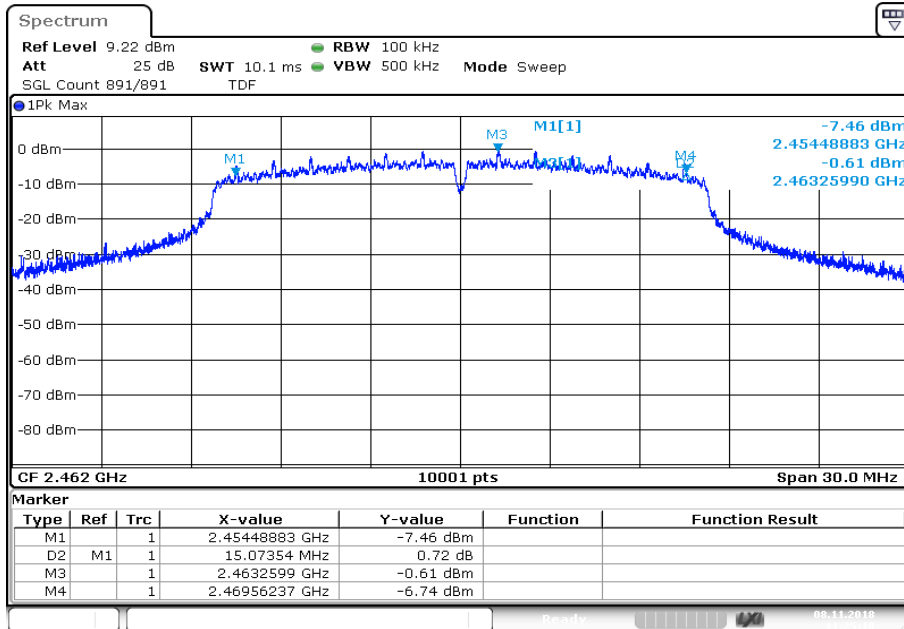

Plots: OFDM / n HT20 – mode

Plot 1: Lowest channel

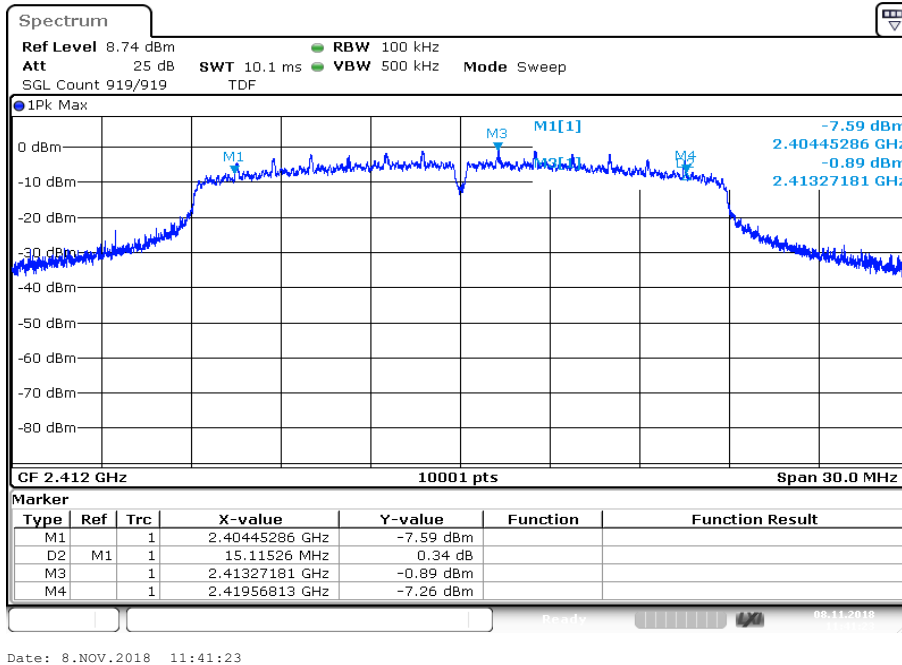

Plot 2: Middle channel

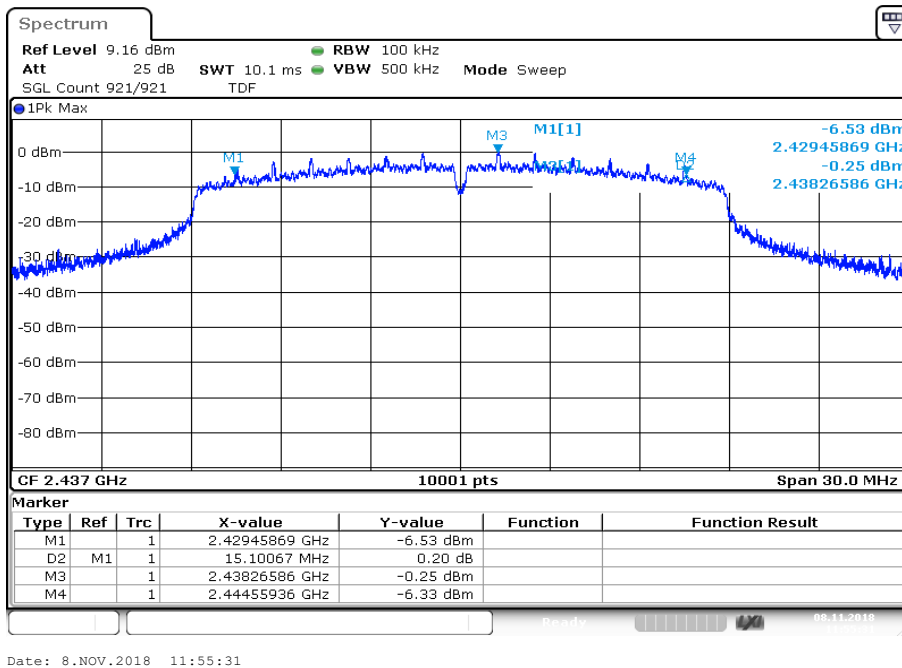

Plot 3: Highest channel

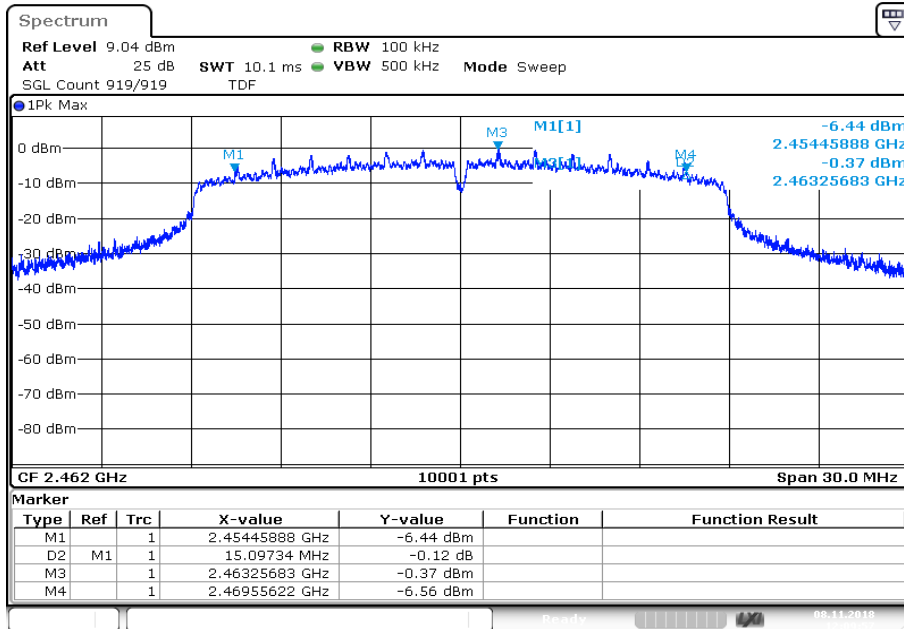

Date: 8.NOV.2018 12:09:57

Plots: OFDM / n HT40 – mode

Plot 1: Lowest channel

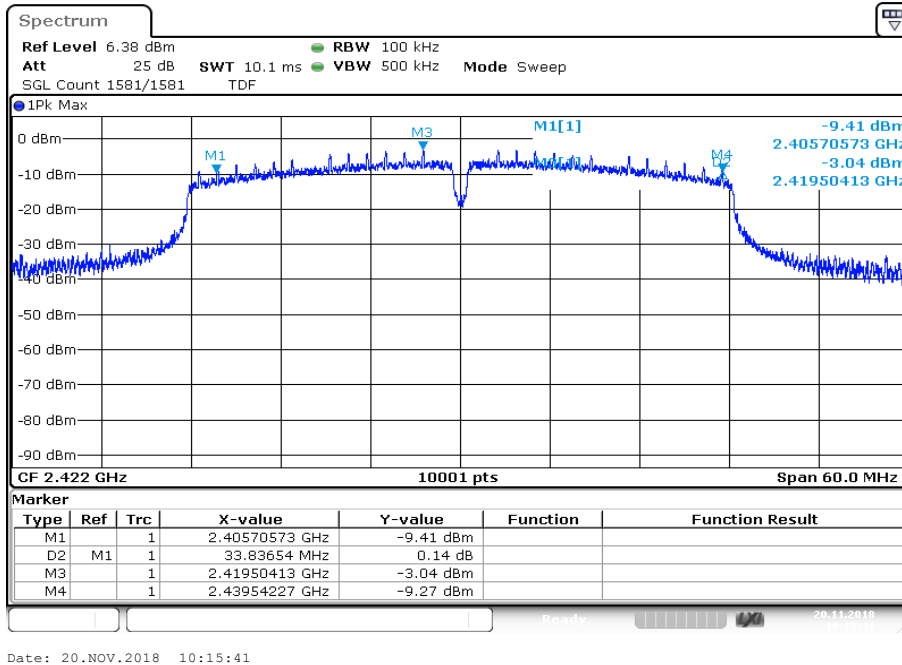

Plot 2: Middle channel

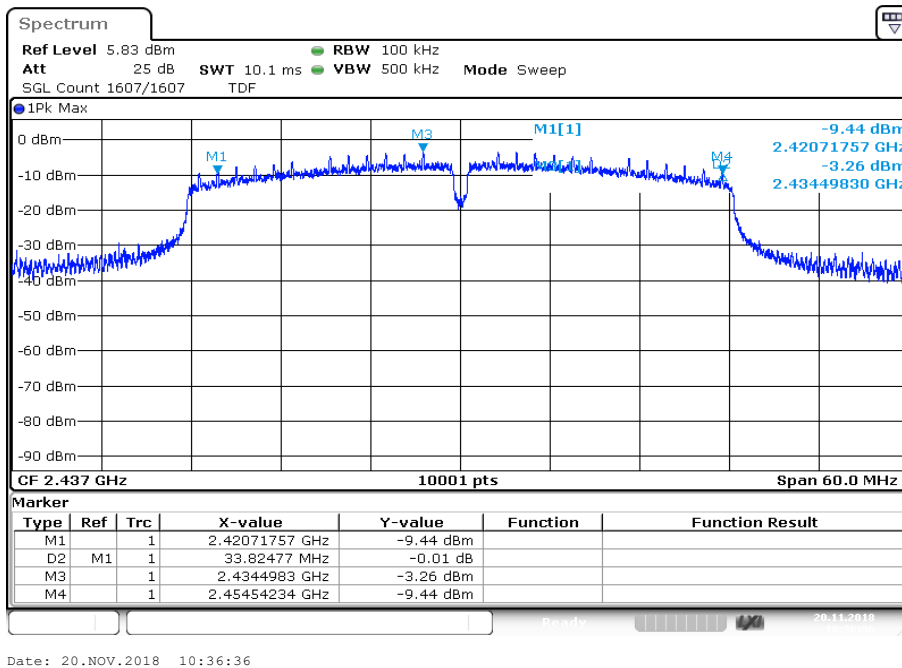

12.7 Occupied bandwidth – 99% emission bandwidth

Description:

Measurement of the 99% bandwidth of the modulated signal acc. RSS-GEN.

Measurement:

Measurement parameter	
Detector	Peak
Sweep time	Auto
Resolution bandwidth	300 kHz
Video bandwidth	1 MHz
Span	30 MHz / 50 MHz
Measurement procedure	Measurement of the 99% bandwidth using the integration function of the analyzer
Trace mode	Single count with 200 counts
Test setup	See chapter 6.2 A
Measurement uncertainty	See chapter 8

Usage:

-/-	IC
OBW is necessary for Emission Designator	

Results:

	99% emission bandwidth / kHz		
	lowest channel	middle channel	highest channel
DSSS / b – mode	14495	14453	14435
OFDM / g – mode	16873	16777	16780
OFDM / n HT20 – mode	17977	17848	17851
OFDM / n HT40 – mode	36650	36650	36686

Plots: DSSS / b – mode

Plot 1: Lowest channel

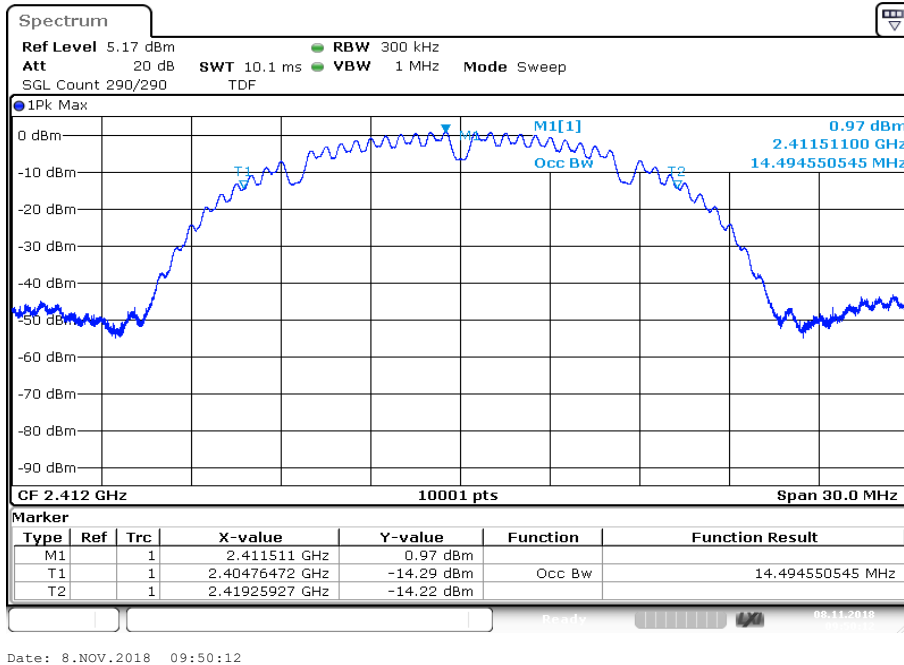

Plot 2: Middle channel

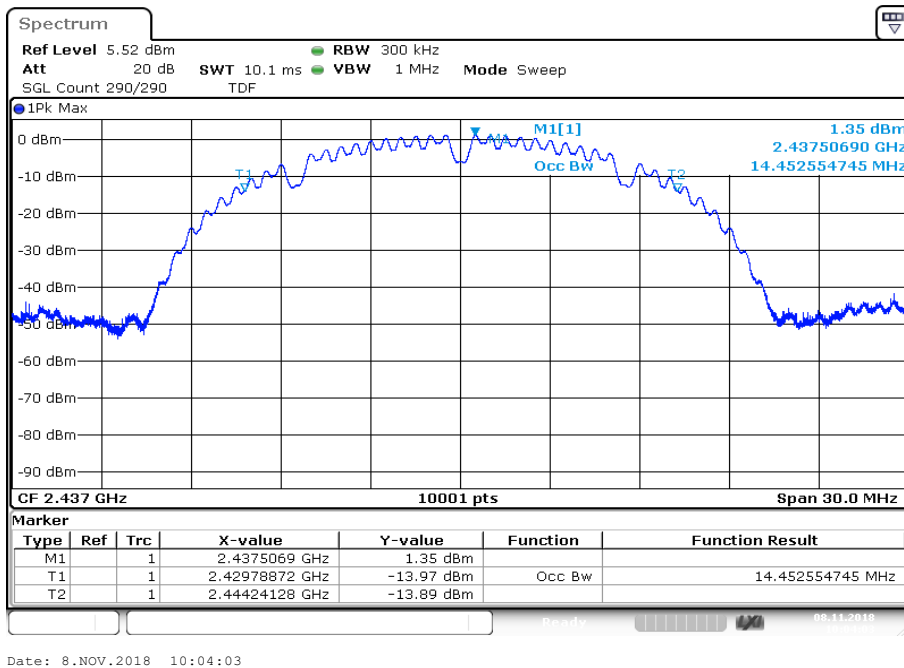

Plot 3: Highest channel

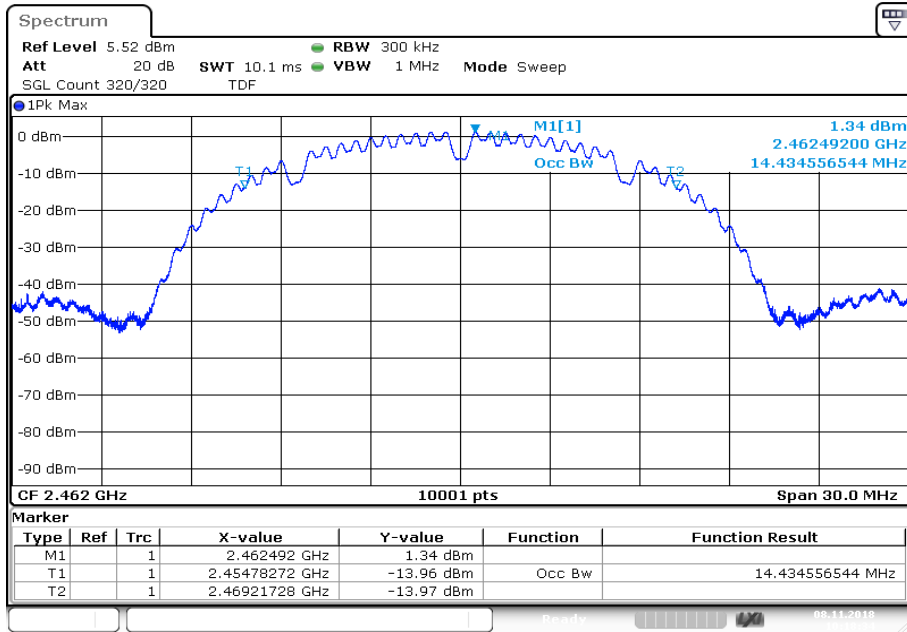

Date: 8.NOV.2018 10:18:34

Plots: OFDM / g – mode

Plot 1: Lowest channel

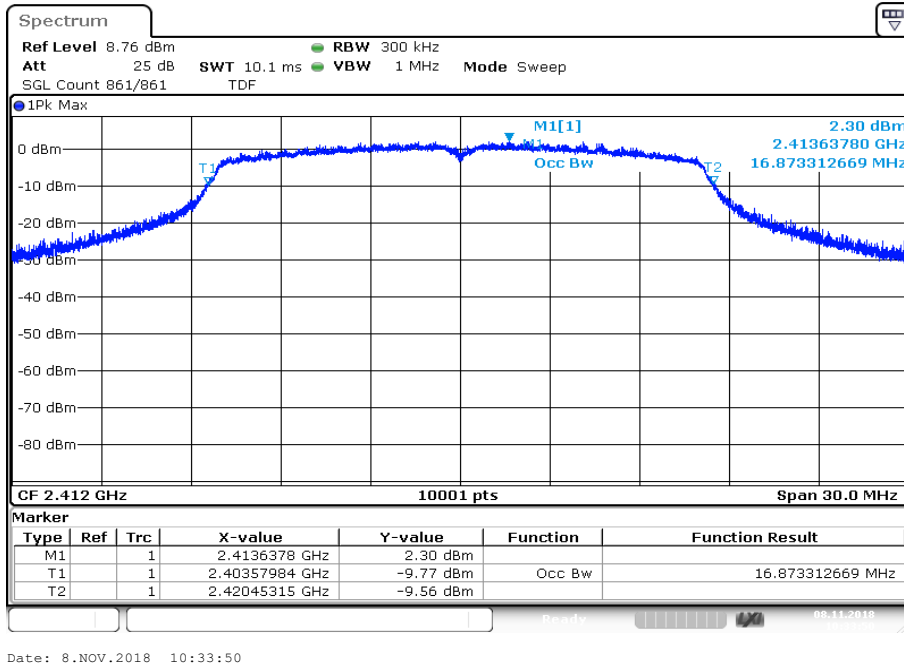

Plot 2: Middle channel

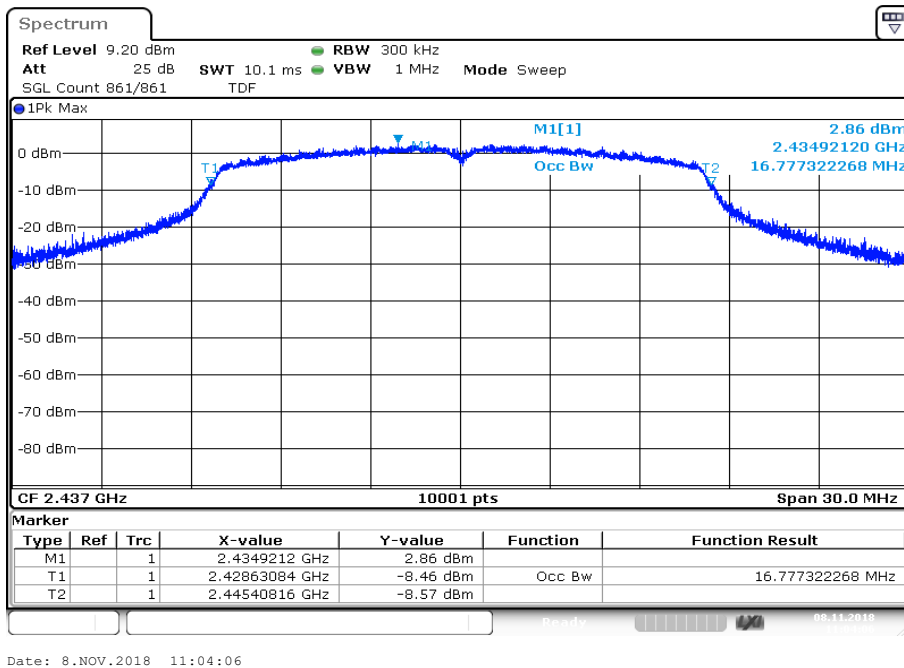

Plot 3: Highest channel

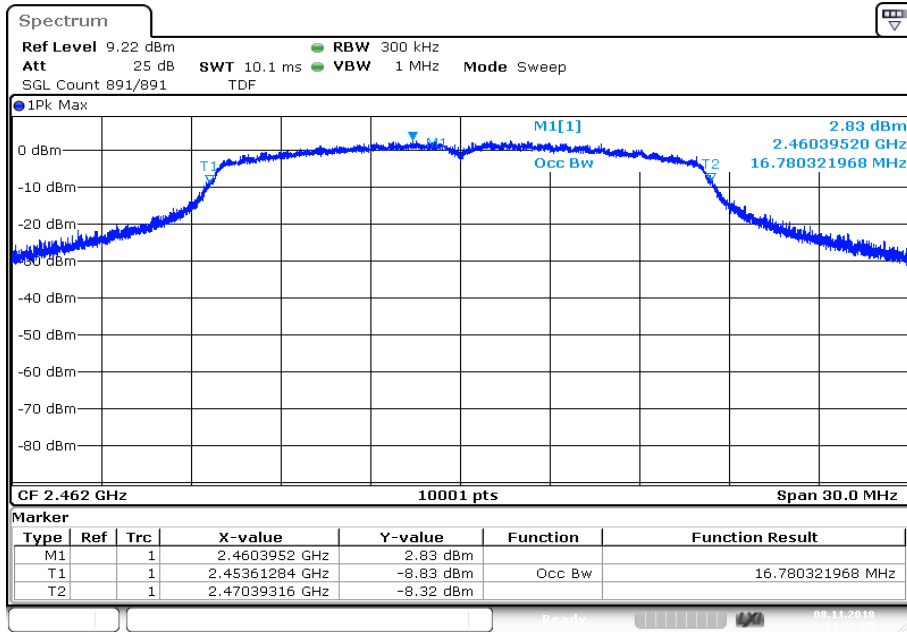

Date: 8.NOV.2018 11:26:05

Plots: OFDM / n HT20 – mode

Plot 1: Lowest channel

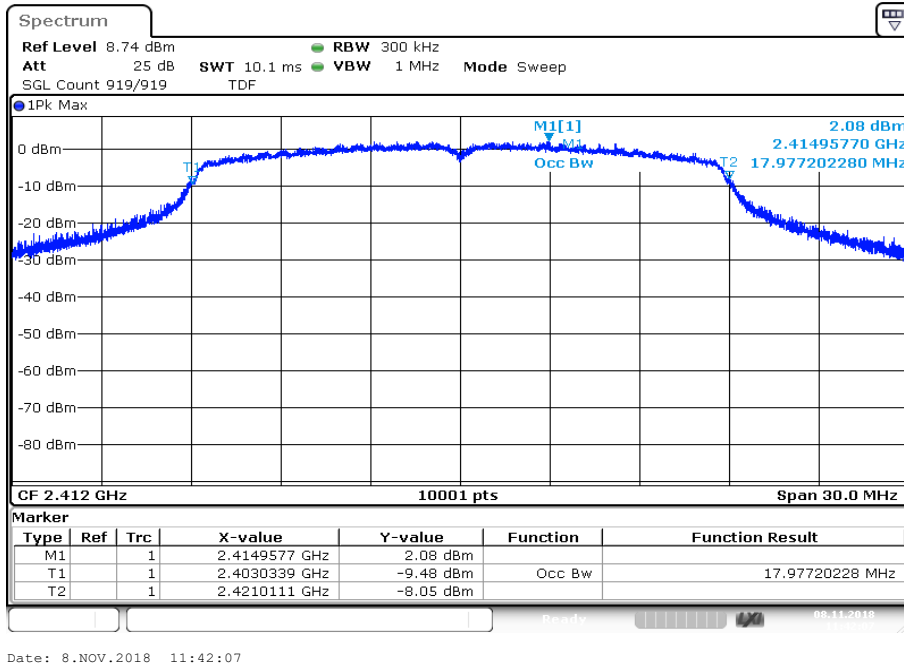

Plot 2: Middle channel

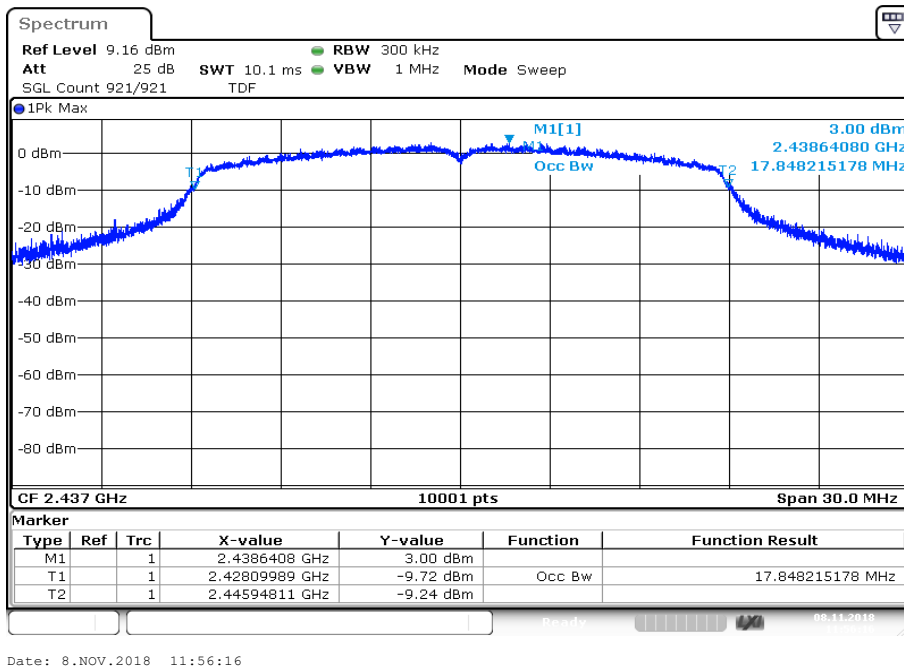

Plot 3: Highest channel

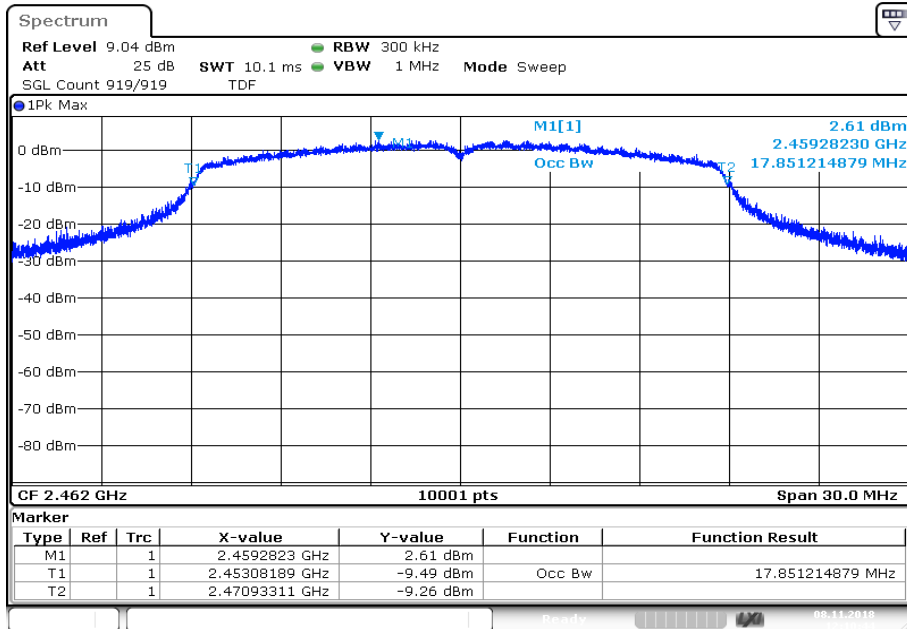

Date: 8.NOV.2018 12:10:45

Plots: OFDM / n HT40 – mode

Plot 1: Lowest channel

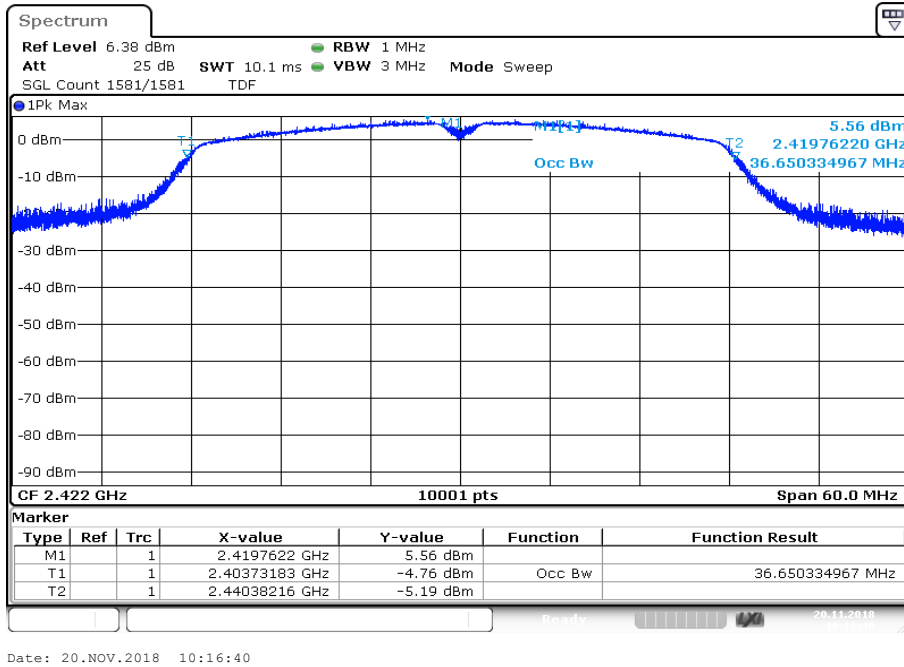

Plot 2: Middle channel

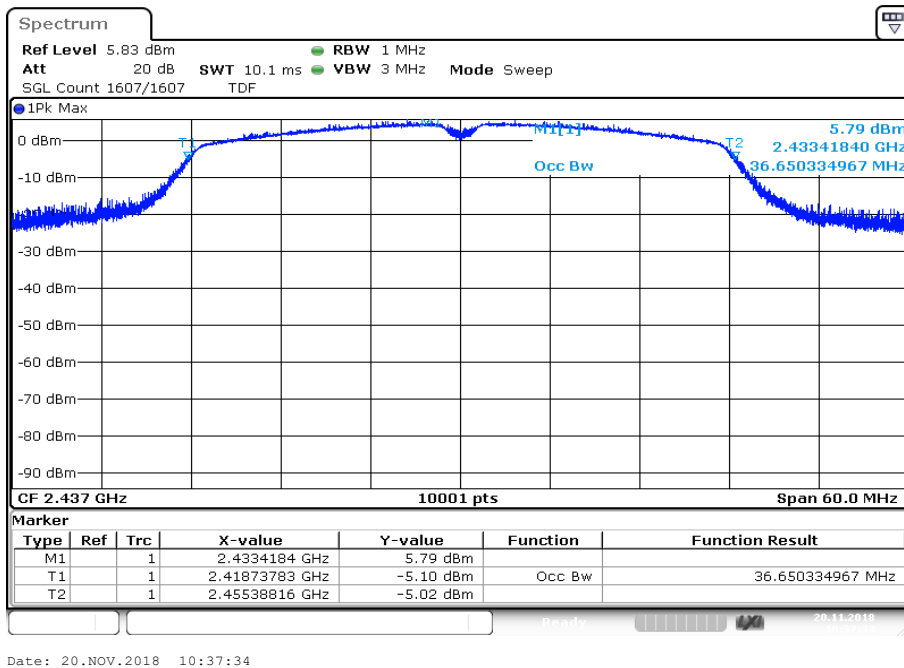

Plot 3: Highest channel

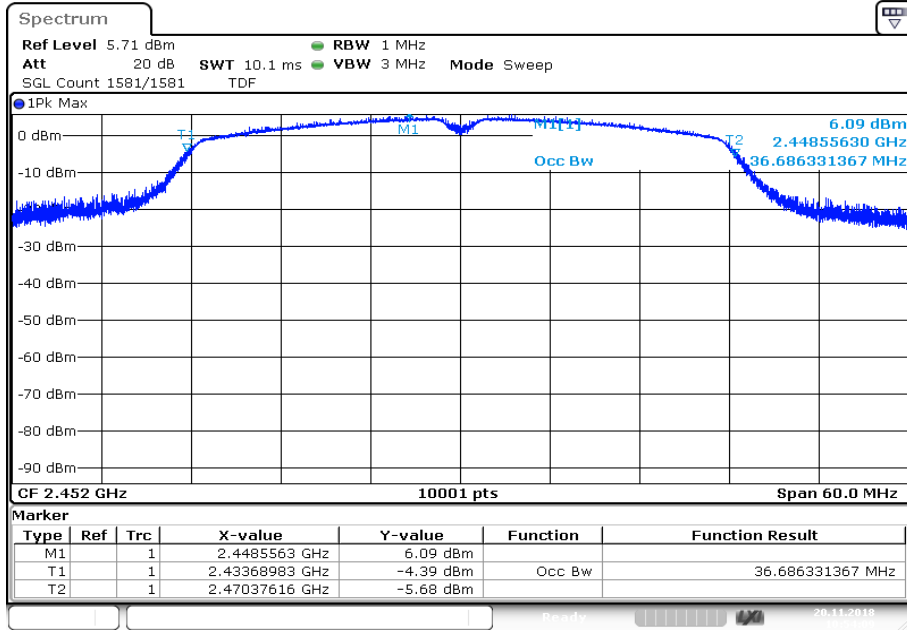

Date: 20.NOV.2018 10:54:10

12.8 Occupied bandwidth – 20 dB bandwidth

Description:

Measurement of the 20 dB bandwidth of the modulated carrier.

Measurement:

Measurement parameter	
Detector	Peak
Sweep time	Auto
Resolution bandwidth	100 kHz
Video bandwidth	500 kHz
Span	30 MHz / 50 MHz
Trace mode	Single count with min. 200 counts
Test setup	See chapter 6.2 A
Measurement uncertainty	See chapter 8

Usage:

-/-	IC
Within the used band!	

Results:

	20 dB bandwidth / MHz		
	lowest channel	middle channel	highest channel
DSSS / b – mode	16.1	16.1	16.1
OFDM / g – mode	17.6	17.5	17.5
OFDM / n HT20 – mode	18.8	18.4	18.4
OFDM / n HT40 – mode	37.0	37.1	37.0

Plots: DSSS / b – mode

Plot 1: Lowest channel

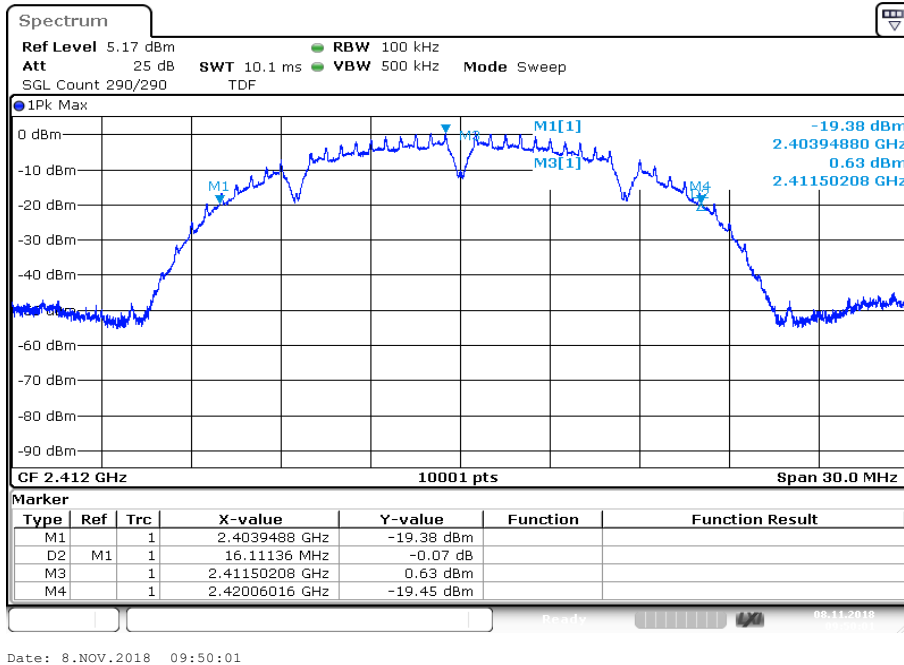

Plot 2: Middle channel

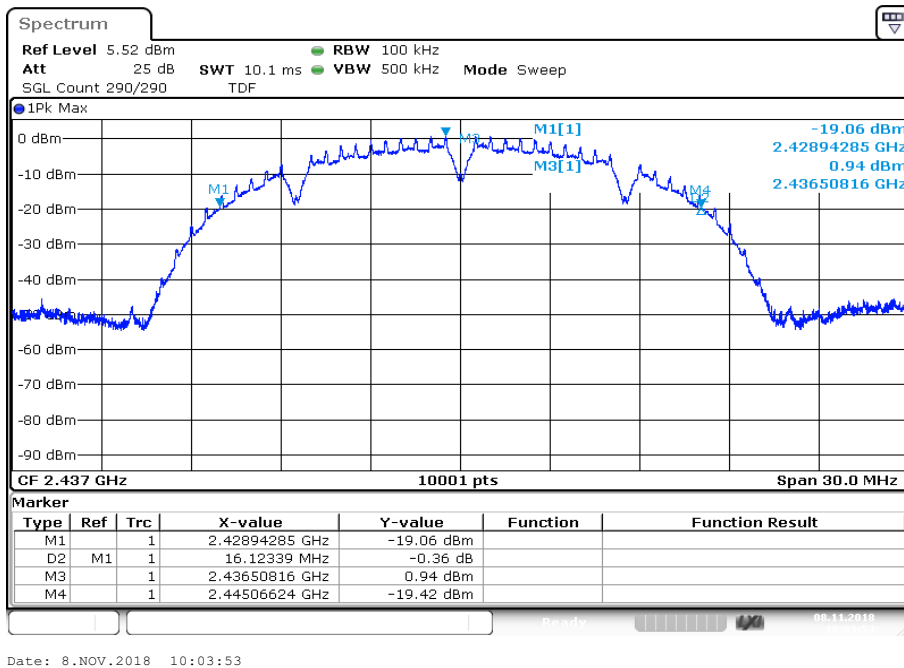

Plot 3: Highest channel

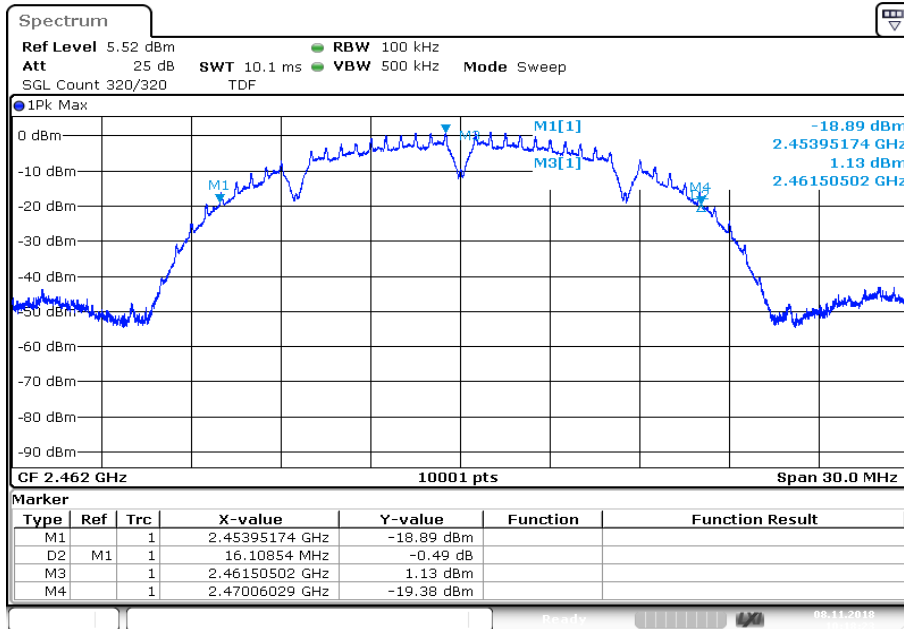

Date: 8.NOV.2018 10:18:23

Plots: OFDM / g – mode

Plot 1: Lowest channel

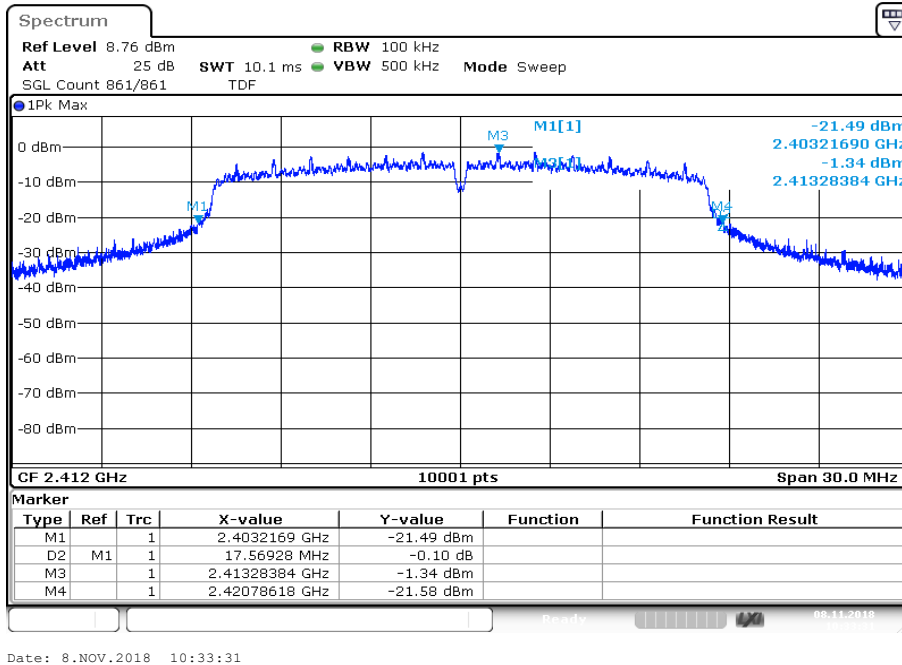

Plot 2: Middle channel

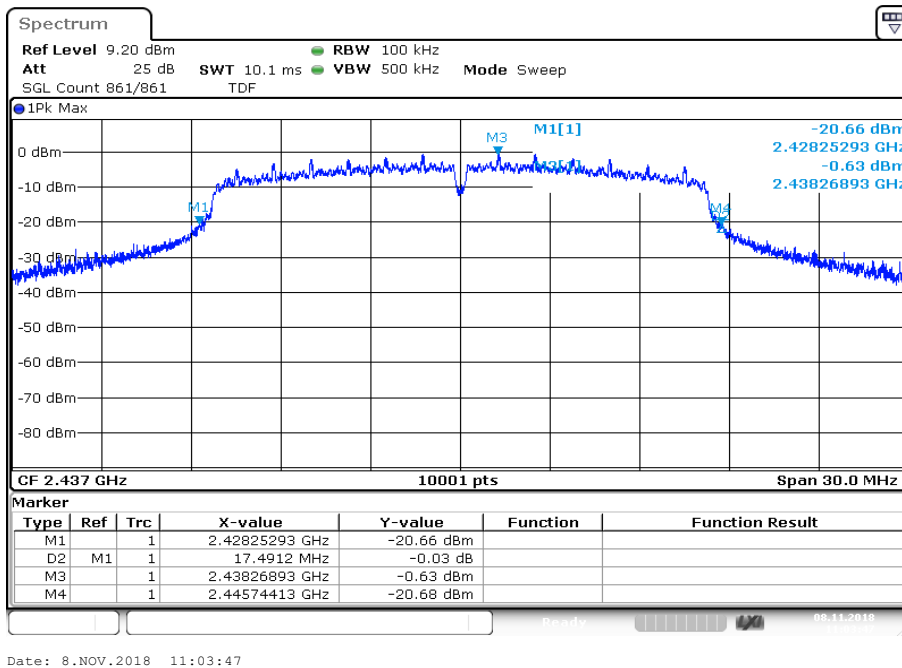

Plot 3: Highest channel

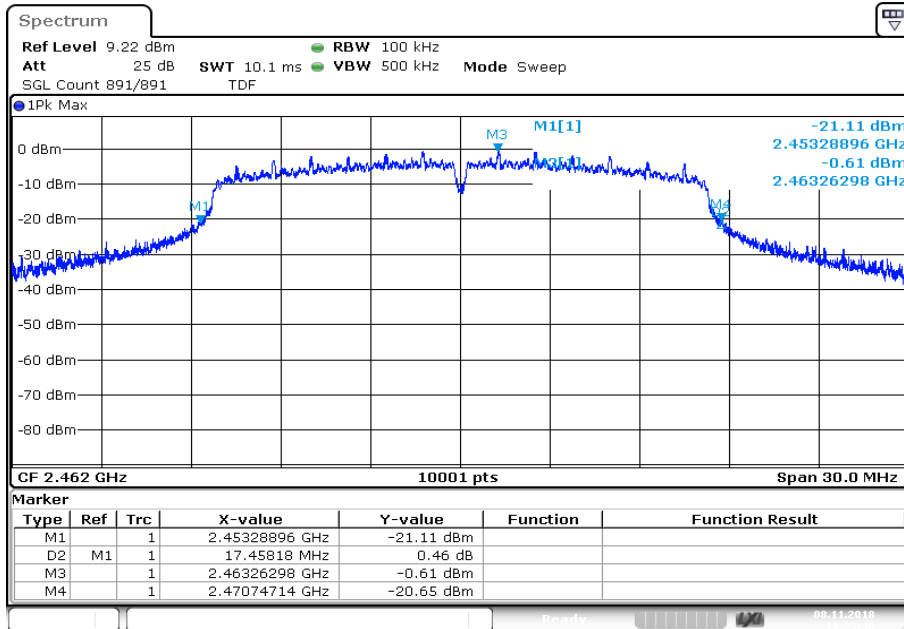

Date: 8.NOV.2018 11:25:46

Plots: OFDM / n HT20 – mode

Plot 1: Lowest channel

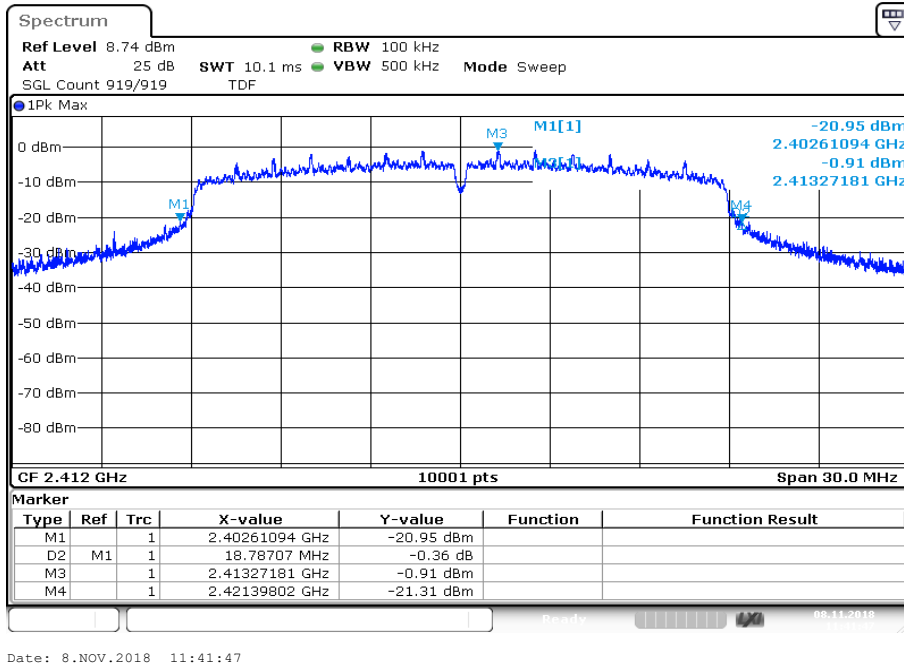

Plot 2: Middle channel

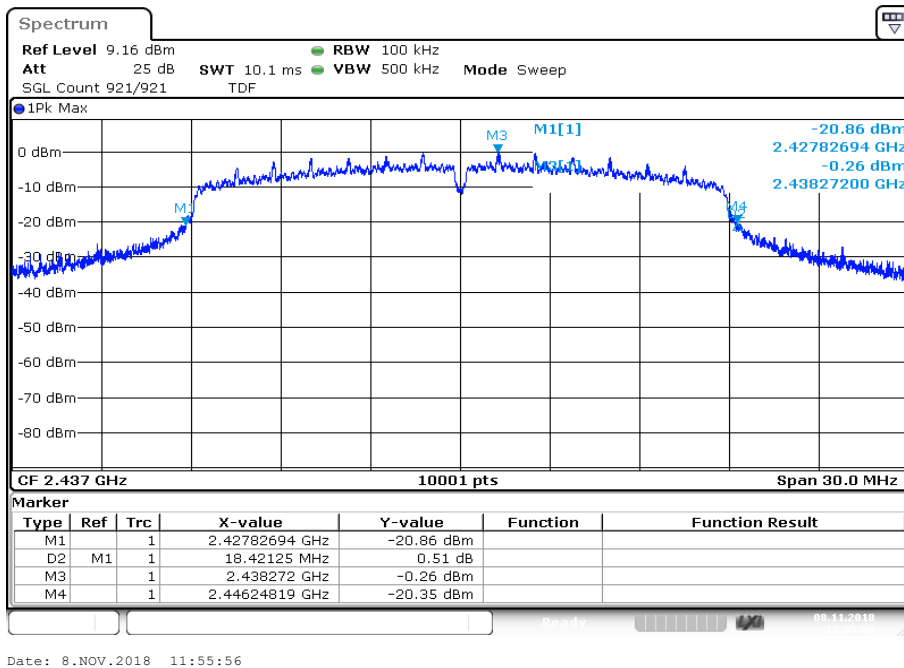

Plot 3: Highest channel

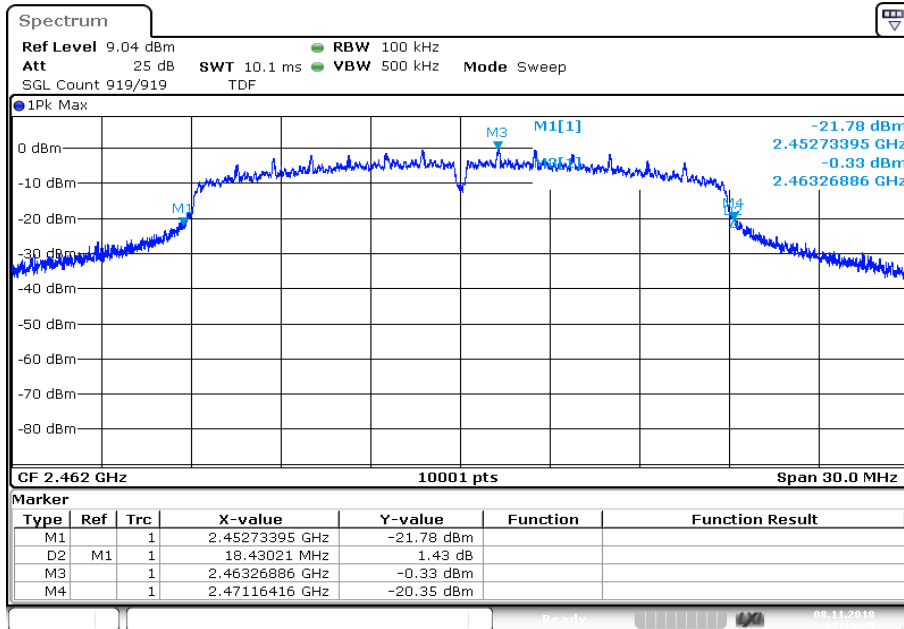

Plots: OFDM / n HT40 – mode

Plot 1: Lowest channel

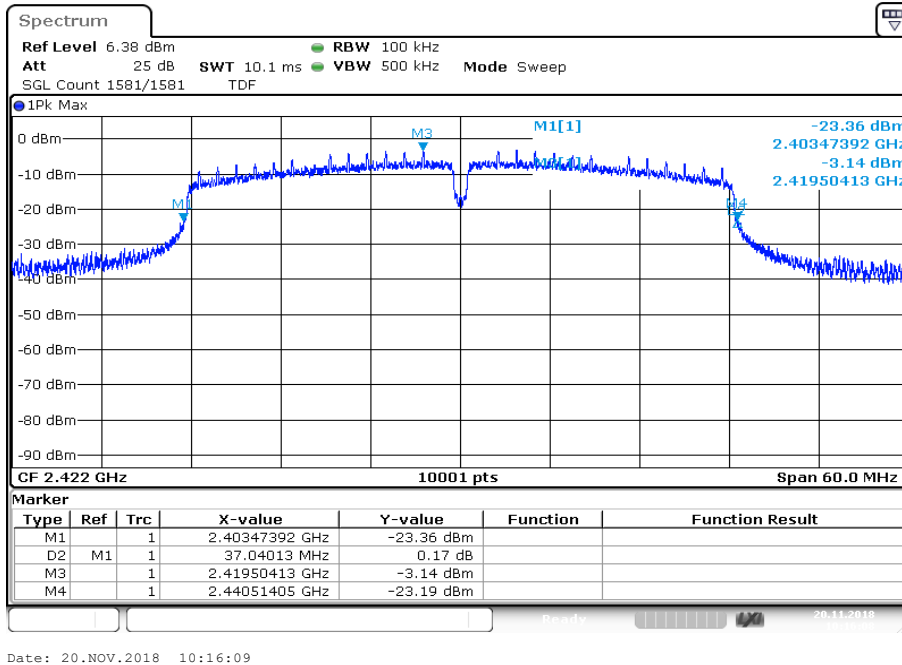

Plot 2: Middle channel

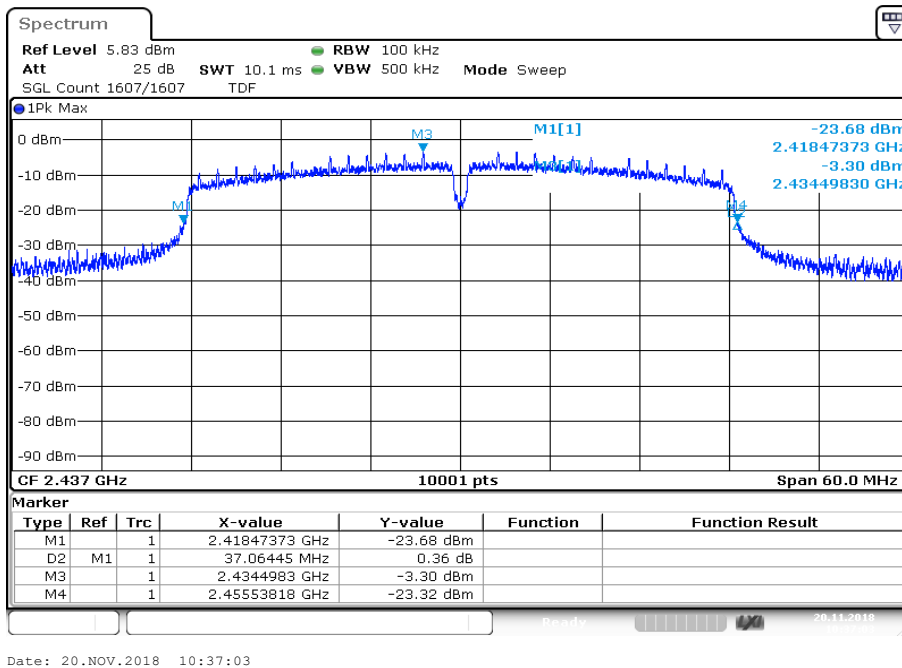

Plot 3: Highest channel

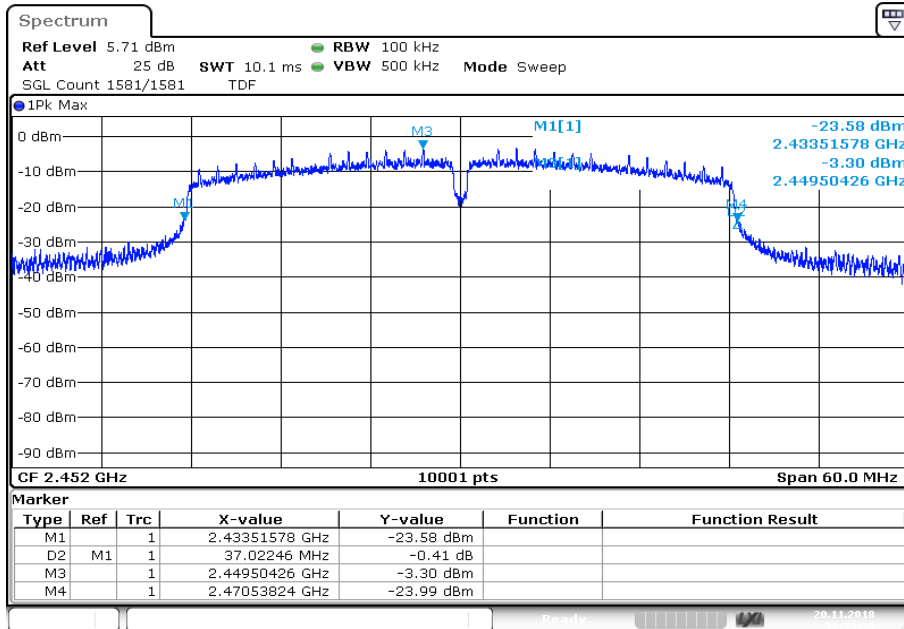

Date: 20.NOV.2018 10:53:39

12.9 Band edge compliance conducted - restricted bands

Description:

Measurement of the radiated band edge compliance with a conducted test setup.

Measurement:

Measurement parameter for measurements				
According to DTS clause: 8.7.3 and clause 12.2.2				
Detector	RMS			
Sweep time	Auto			
Resolution bandwidth	100 kHz			
Video bandwidth	300 kHz			
Span	2 MHz			
	lower band edge	2388 MHz	to	2390 MHz
	upper band edge	2483.5 MHz	to	2485.5 MHz
Trace mode	Trace average with 200 counts			
Test setup	See chapter 6.2 A			
Measurement uncertainty	See chapter 8			

Limits:

FCC	IC
-41.26 dBm	

Results:

	band edge compliance / dBm (gain calculation)			
Modulation:	DSSS / b – mode	OFDM / g – mode	OFDM / n HT20 – mode	OFDM / n HT40 – mode
Max. lower band edge power conducted	-63.23	-49.37	-46.71	-39.54
Antenna gain / dBi	-4.8			
Max. lower band edge power radiated	-68.03	-54.17	-51.51	-44.34
Max. upper band edge power conducted	-58.80	-48.40	-46.75	-40.11
Antenna gain / dBi	-3.4			
Max. upper band edge power radiated	-62.2	-51.8	-50.15	-43.51

Plots: DSSS / b – mode

Plot 1: Lower band edge

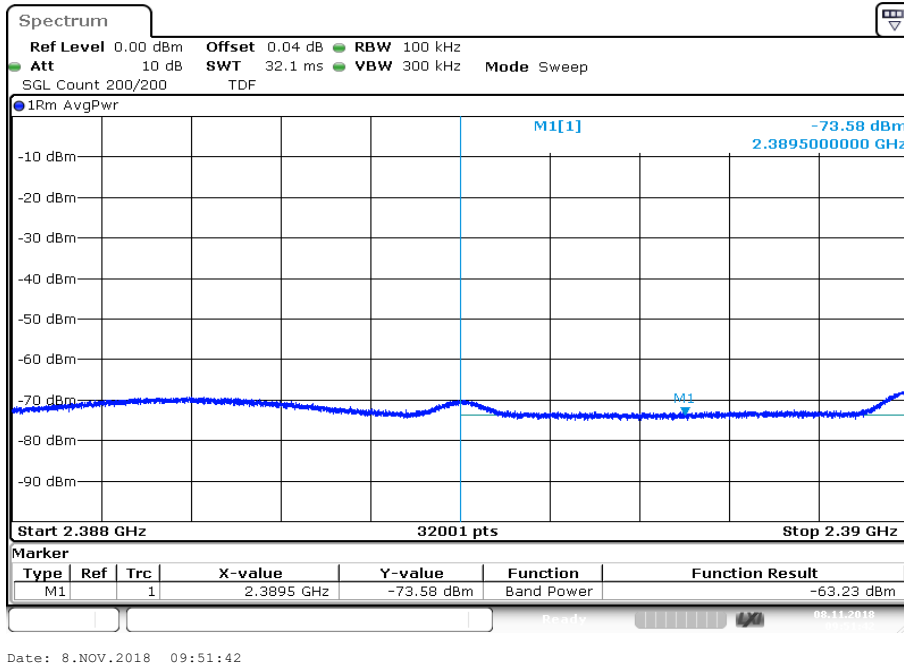

Plot 2: Upper band edge

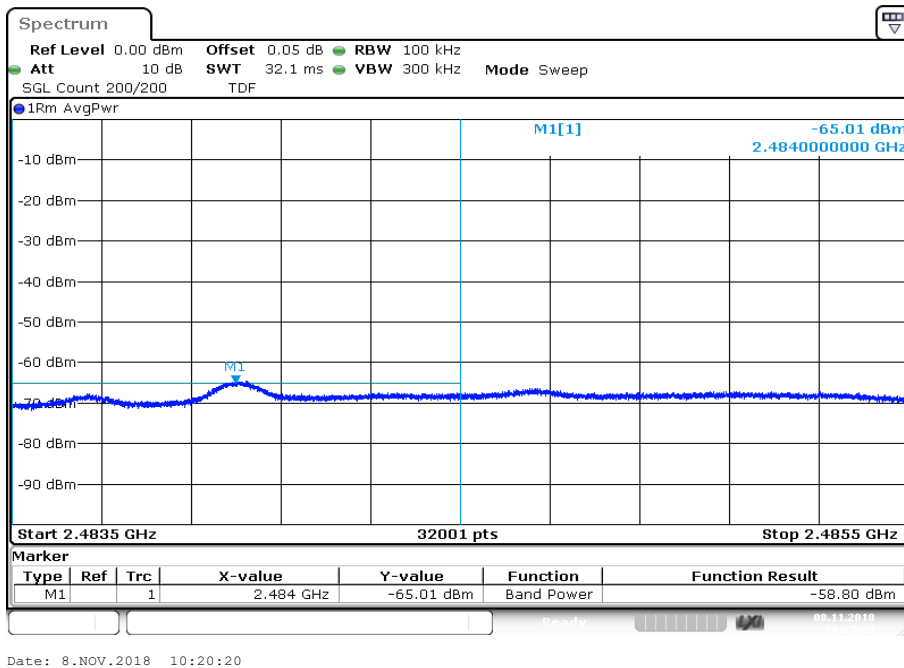

Plots: OFDM / g – mode

Plot 1: Lower band edge

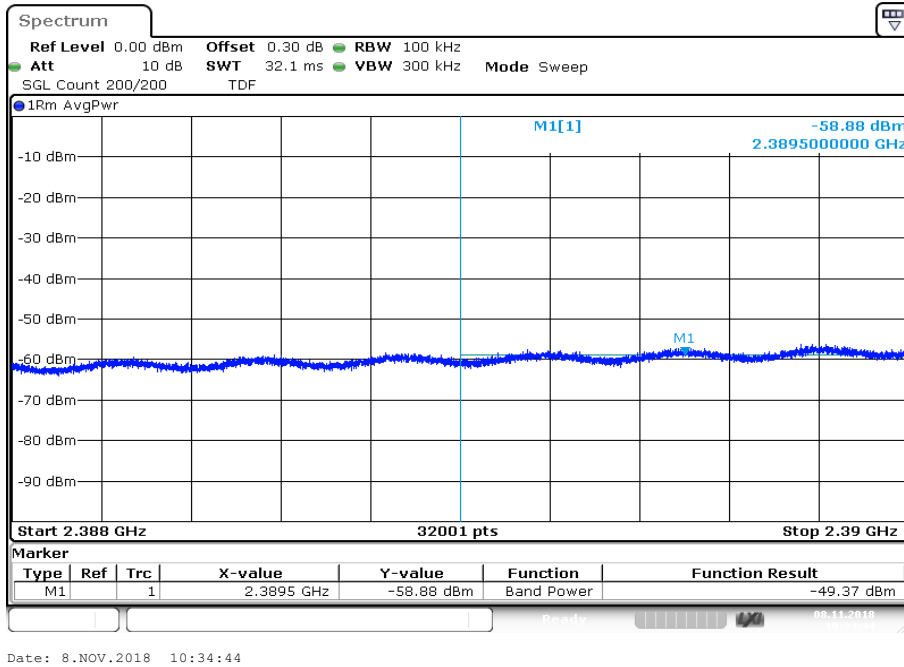

Plot 2: Upper band edge

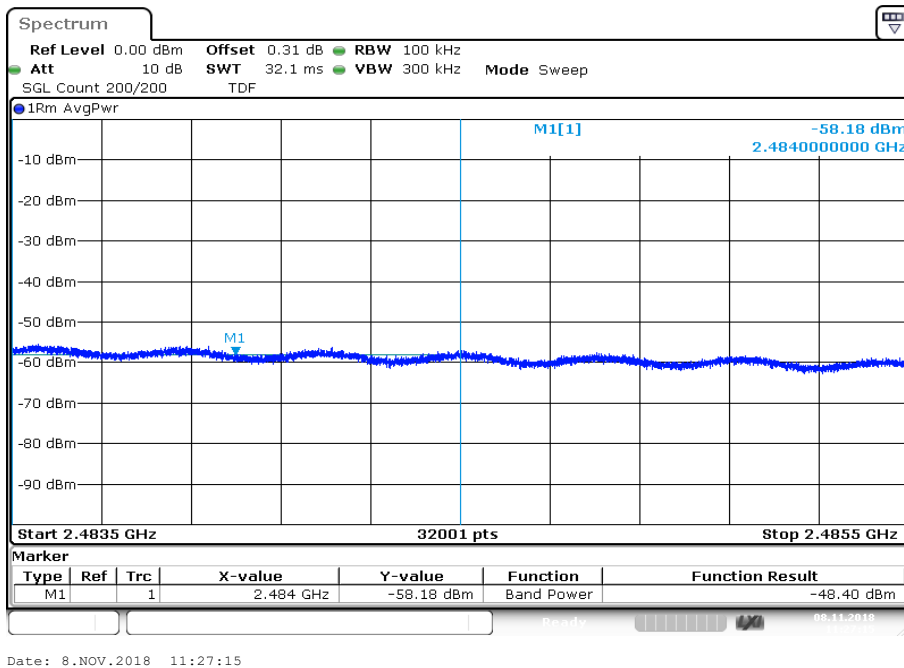

Plots: OFDM / n HT20 – mode

Plot 1: Lower band edge

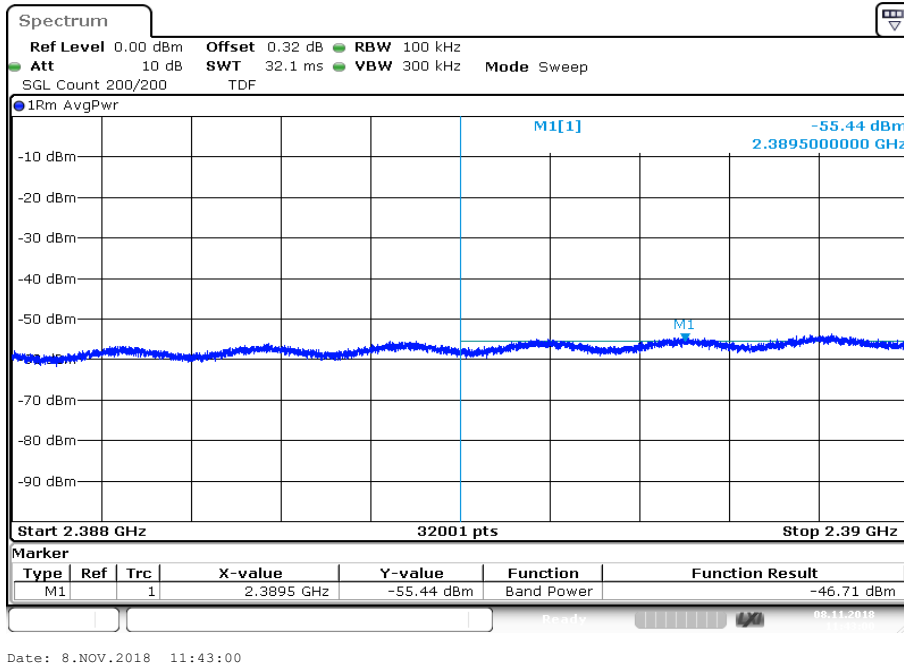

Plot 2: Upper band edge

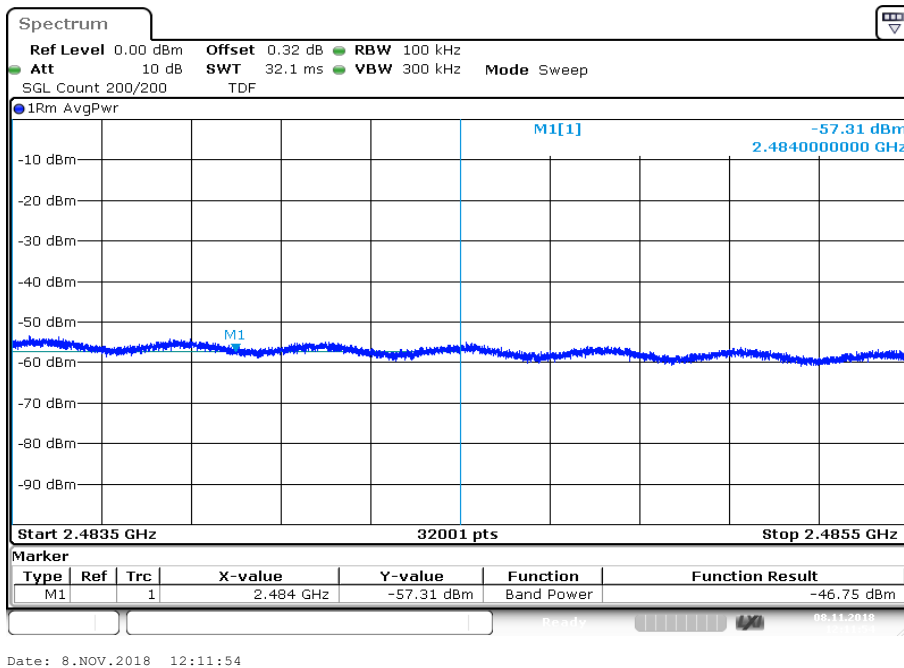

Plots: OFDM / n HT40 – mode

Plot 1: Lower band edge

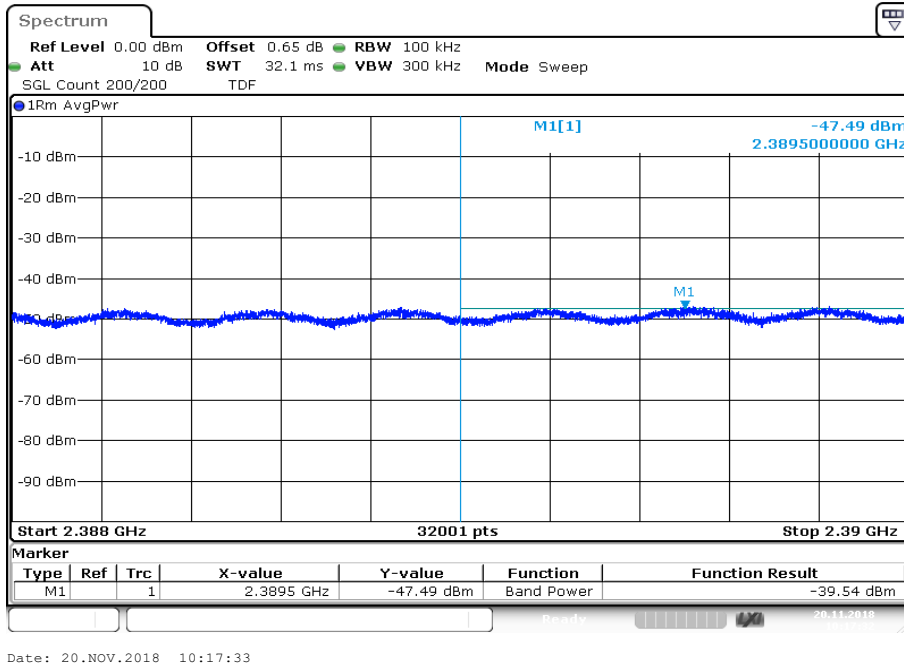

Plot 2: Upper band edge

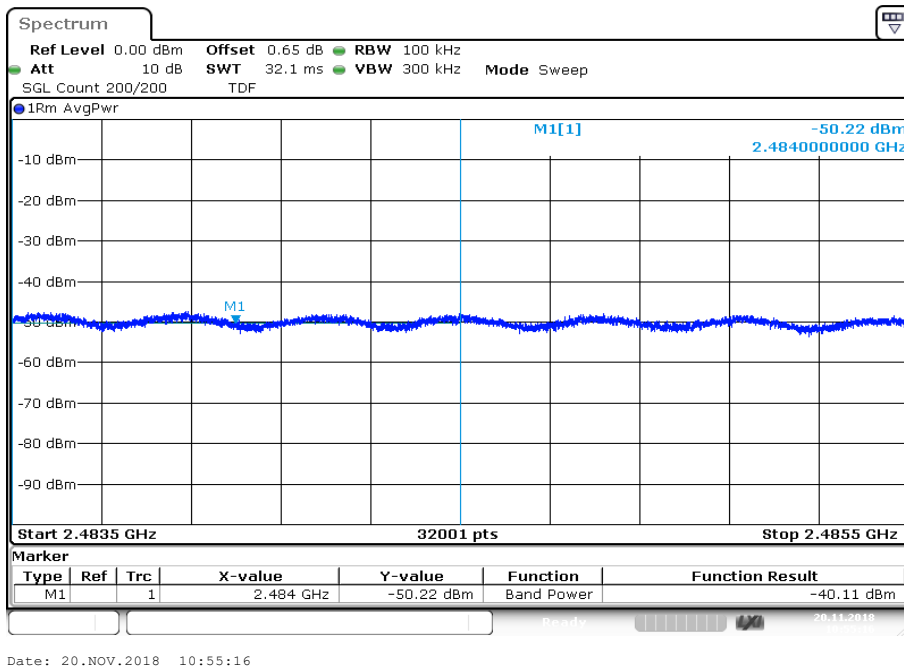

12.10 Spurious emissions conducted

Description:

Measurement of the conducted spurious emissions in transmit mode. The measurement is performed at the lowest; the middle and the highest channel. The measurement is repeated for all modulations.

Measurement:

Measurement parameter	
Detector	Peak
Sweep time	Auto
Resolution bandwidth	100 kHz
Video bandwidth	500 kHz
Span	9 kHz to 25 GHz
Trace mode	Max Hold
Test setup	See chapter 6.2 A
Measurement uncertainty	See chapter 8

Limits:

FCC	IC
<p>In any 100 kHz bandwidth outside the frequency band in which the spread spectrum or digitally modulated intentional radiator is operating, the radio frequency power that is produced by the intentional radiator shall be at least 30 dB below that in the 100 kHz bandwidth within the band that contains the highest level of the desired power, based on either an RF conducted or a radiated measurement. Attenuation below the general limits specified in Section 15.209(a)/RSS-Gen is not required</p>	

Results:

Results: DSSS / b – mode

TX spurious emissions conducted					
f [MHz]		amplitude of emission [dBm]	limit max. allowed emission power	actual attenuation below frequency of operation [dB]	results
Lowest channel		-0.51	30 dBm		Operating frequency
No peaks detected.			-20 dBc (peak) -30 dBc (average)		compliant
Middle channel		-0.92	30 dBm		Operating frequency
No peaks detected.			-20 dBc (peak) -30 dBc (average)		compliant
Highest channel		-0.61	30 dBm		Operating frequency
No peaks detected.			-20 dBc (peak) -30 dBc (average)		compliant

Results: OFDM / g – mode

TX spurious emissions conducted					
f [MHz]		amplitude of emission [dBm]	limit max. allowed emission power	actual attenuation below frequency of operation [dB]	results
Lowest channel		-1.46	30 dBm		Operating frequency
No peaks detected.			-20 dBc (peak) -30 dBc (average)		compliant
Middle channel		-1.36	30 dBm		Operating frequency
No peaks detected.			-20 dBc (peak) -30 dBc (average)		compliant
Highest channel		-0.70	30 dBm		Operating frequency
No peaks detected.			-20 dBc (peak) -30 dBc (average)		compliant

Results: OFDM / n HT20 – mode

TX spurious emissions conducted					
f [MHz]		amplitude of emission [dBm]	limit max. allowed emission power	actual attenuation below frequency of operation [dB]	results
Lowest channel		-0.78	30 dBm		Operating frequency
No peaks detected.			-20 dBc (peak) -30 dBc (average)		compliant
Middle channel		-3.62	30 dBm		Operating frequency
No peaks detected.			-20 dBc (peak) -30 dBc (average)		compliant
Highest channel		-0.65	30 dBm		Operating frequency
No peaks detected.			-20 dBc (peak) -30 dBc (average)		compliant

Results: OFDM / n HT40 – mode

TX spurious emissions conducted					
f [MHz]		amplitude of emission [dBm]	limit max. allowed emission power	actual attenuation below frequency of operation [dB]	results
Lowest channel		-5.54	30 dBm		Operating frequency
No peaks detected.			-20 dBc (peak) -30 dBc (average)		compliant
Middle channel		-3.26	30 dBm		Operating frequency
No peaks detected.			-20 dBc (peak) -30 dBc (average)		compliant
Highest channel		-3.42	30 dBm		Operating frequency
No peaks detected.			-20 dBc (peak) -30 dBc (average)		compliant

Plots: DSSS / b – mode

Plot 1: Lowest channel, up to 25 GHz

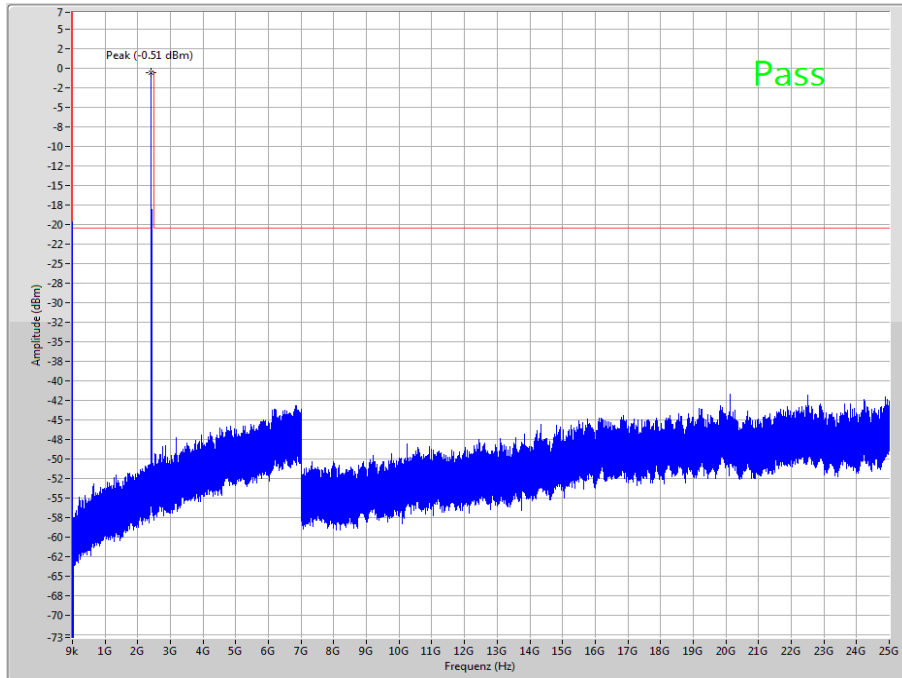

The peak at the beginning of the plot is the LO from the SA.

Plot 2: Lowest channel, zoomed carrier

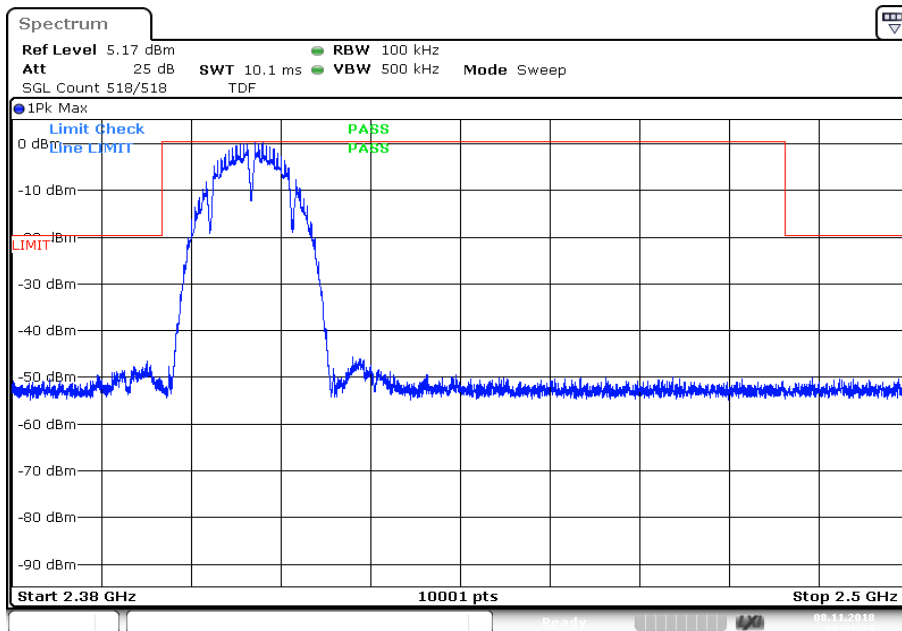

Plot 3: Middle channel, up to 25 GHz

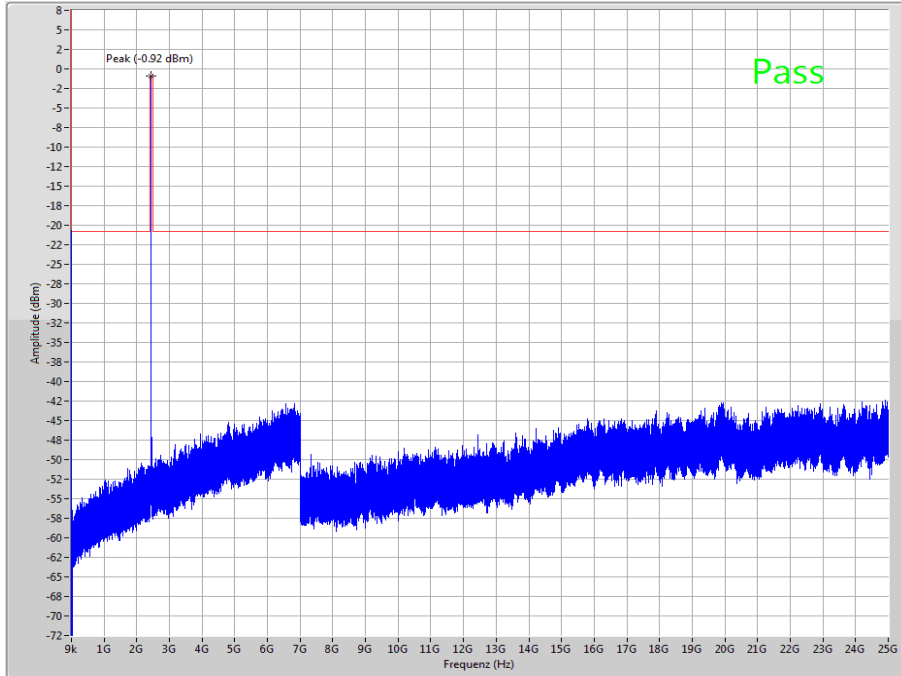

The peak at the beginning of the plot is the LO from the SA.

Plot 4: Middle channel, zoomed carrier

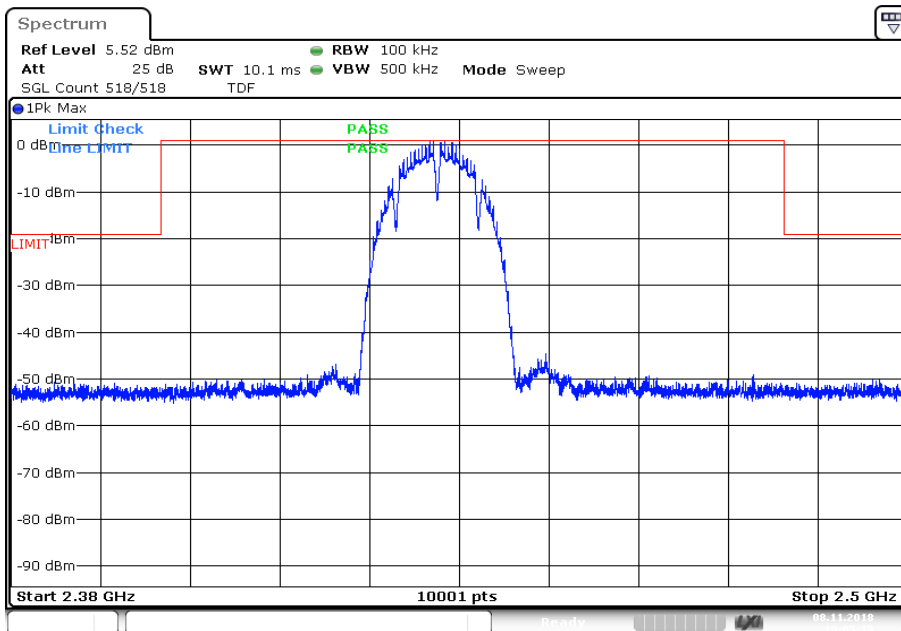

Date: 8.NOV.2018 10:05:19

Plot 5: Highest channel, up to 25 GHz

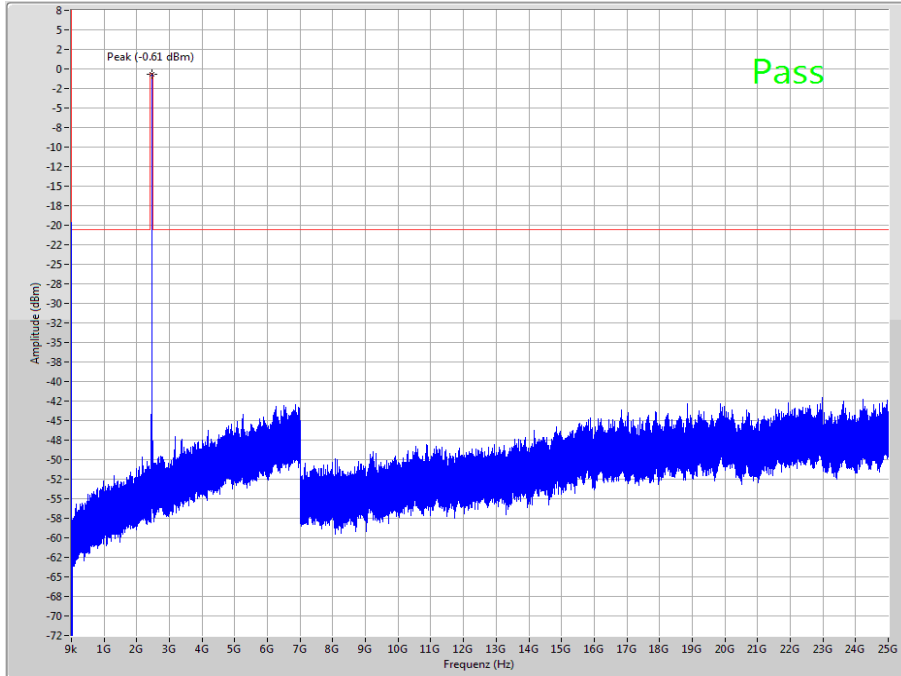

The peak at the beginning of the plot is the LO from the SA.

Plot 6: Highest channel, zoomed carrier

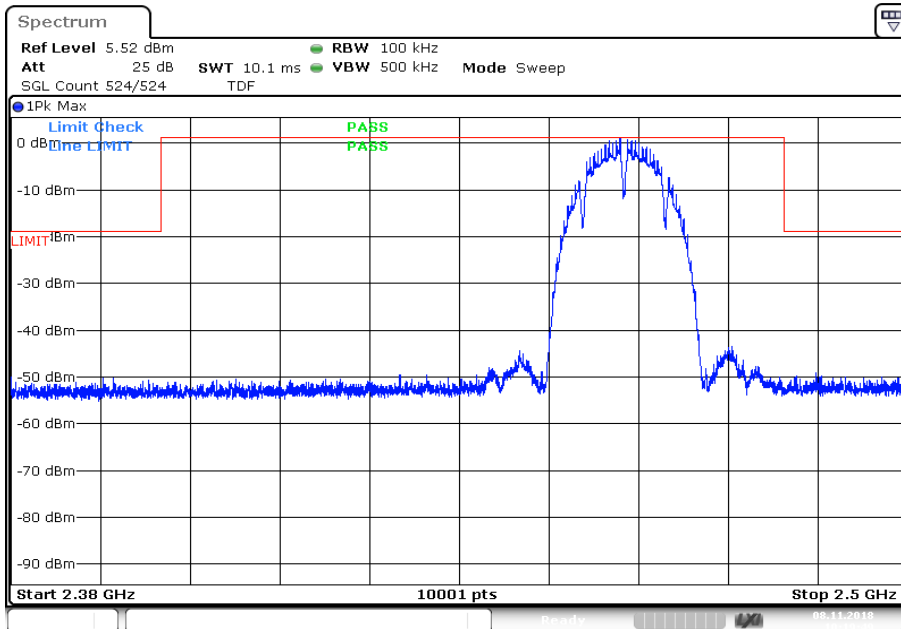

Date: 8.NOV.2018 10:19:50

Plots: OFDM / g – mode

Plot 1: Lowest channel, up to 25 GHz

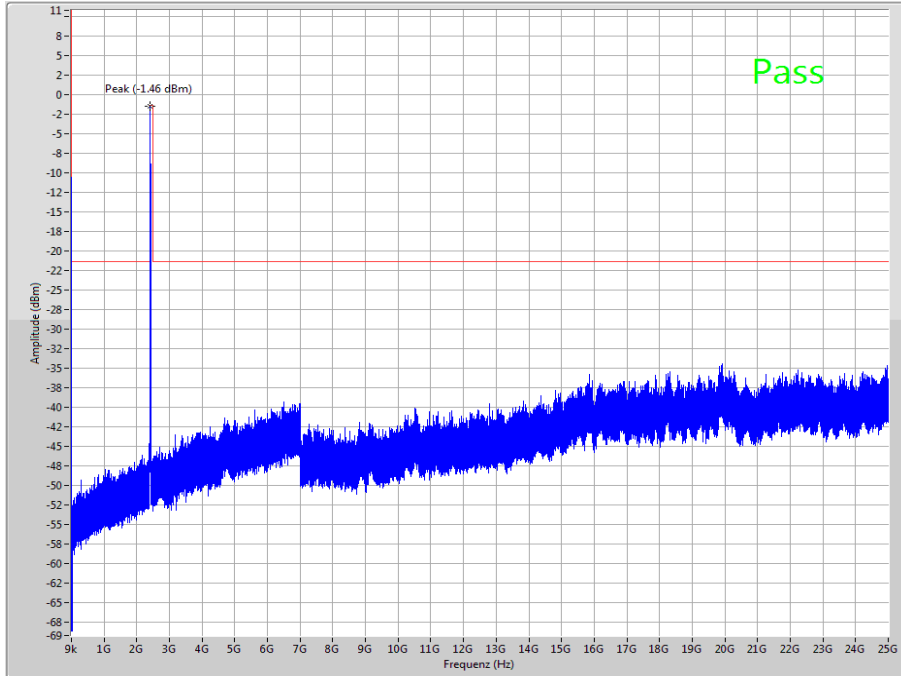

The peak at the beginning of the plot is the LO from the SA.

Plot 2: Lowest channel, zoomed carrier

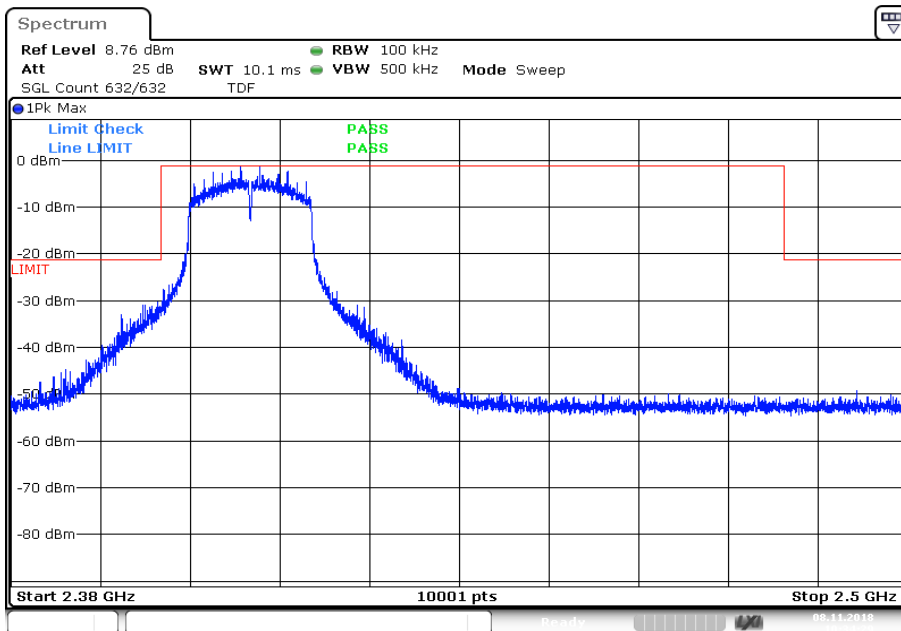

Date: 8.NOV.2018 10:34:29

Plot 3: Middle channel, up to 25 GHz

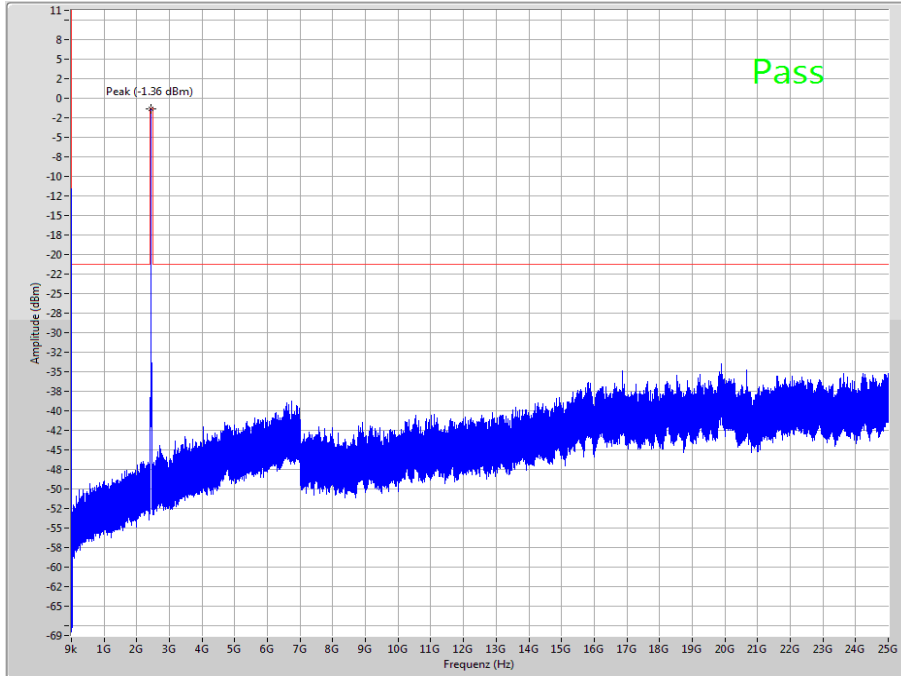

The peak at the beginning of the plot is the LO from the SA.

Plot 4: Middle channel, zoomed carrier

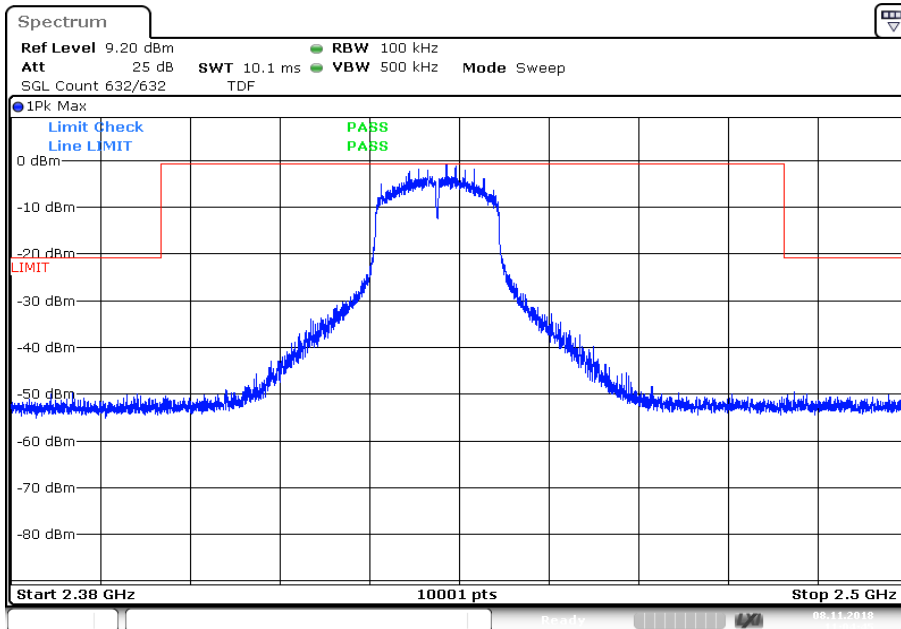

Date: 8.NOV.2018 11:04:45

Plot 5: Highest channel, up to 25 GHz

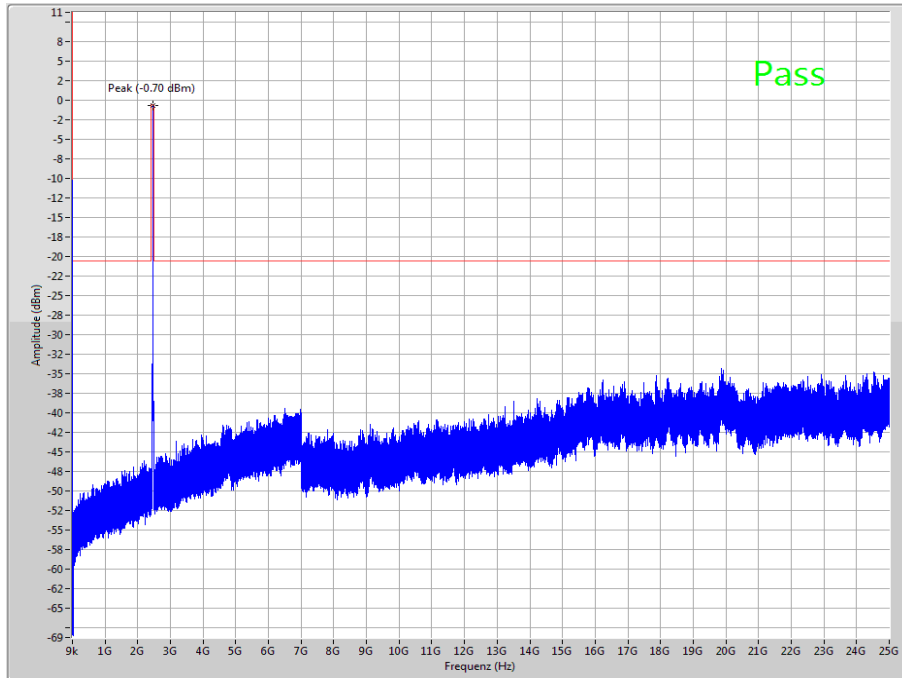

The peak at the beginning of the plot is the LO from the SA.

Plot 6: Highest channel, zoomed carrier

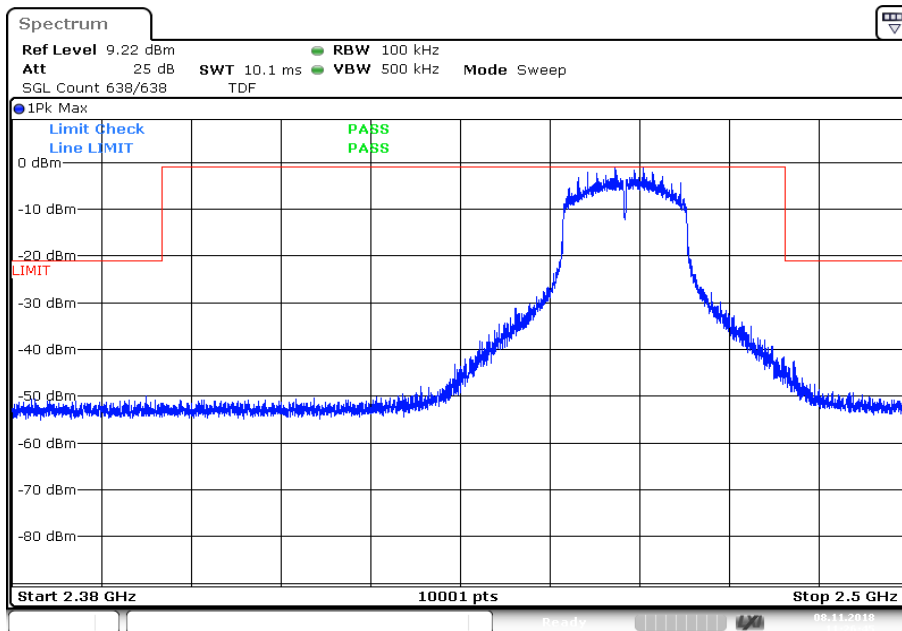

Date: 8.NOV.2018 11:26:46

Plots: OFDM / n HT 20 – mode

Plot 1: Lowest channel, up to 25 GHz

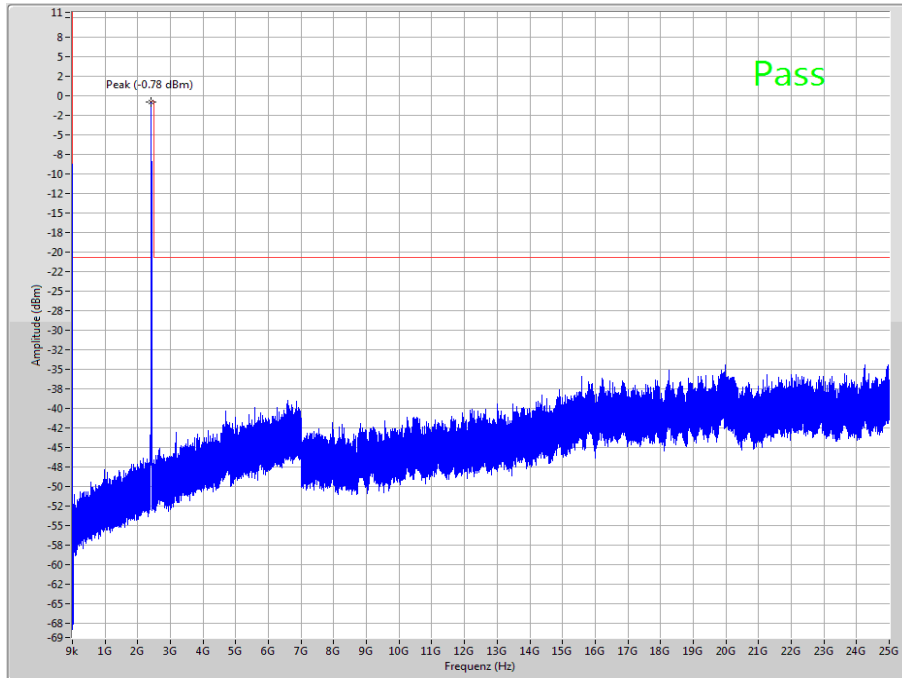

The peak at the beginning of the plot is the LO from the SA.

Plot 2: Lowest channel, zoomed carrier

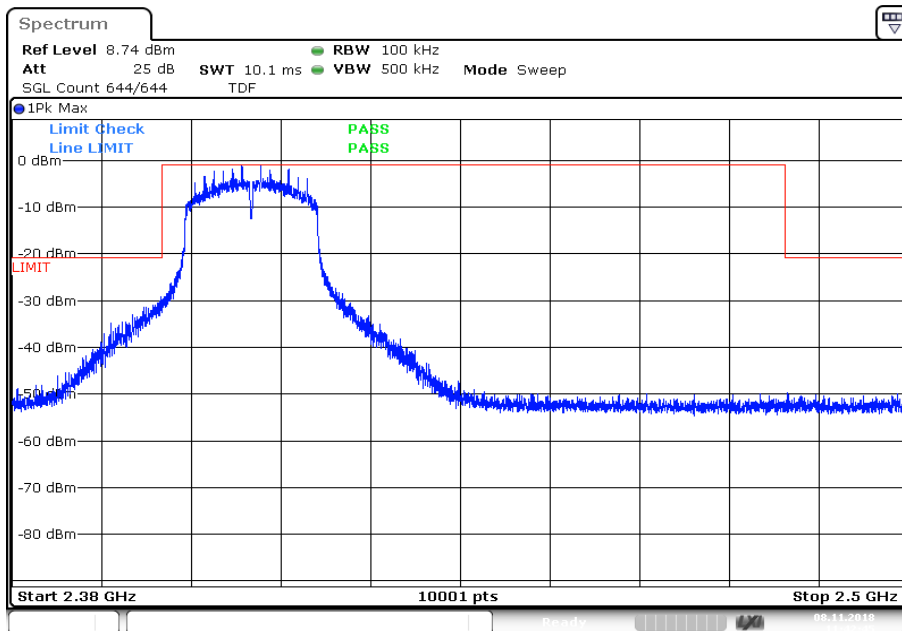

Date: 8.NOV.2018 11:42:45

Plot 3: Middle channel, up to 25 GHz

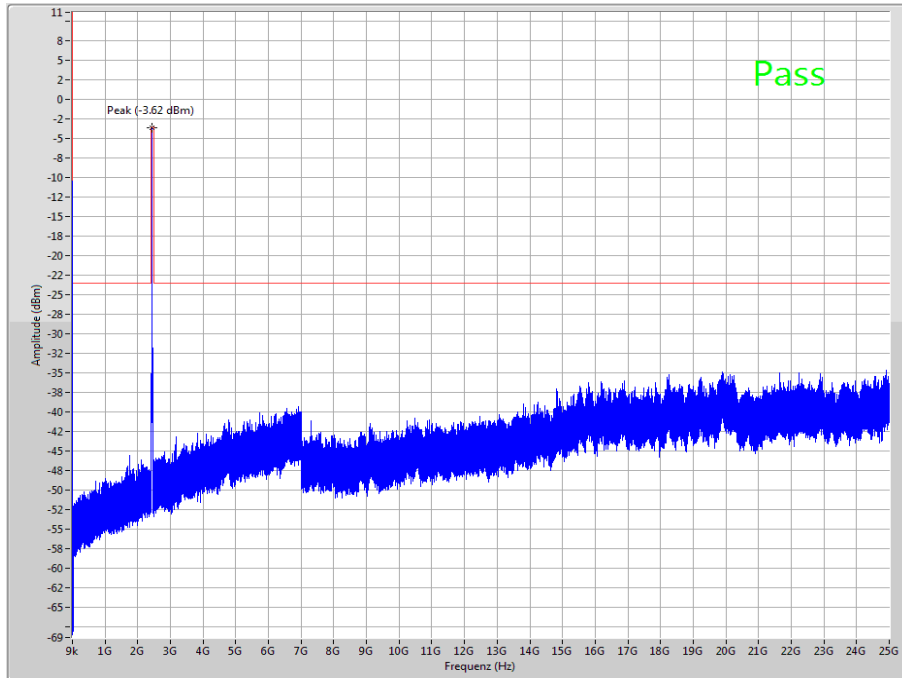

The peak at the beginning of the plot is the LO from the SA.

Plot 4: Middle channel, zoomed carrier

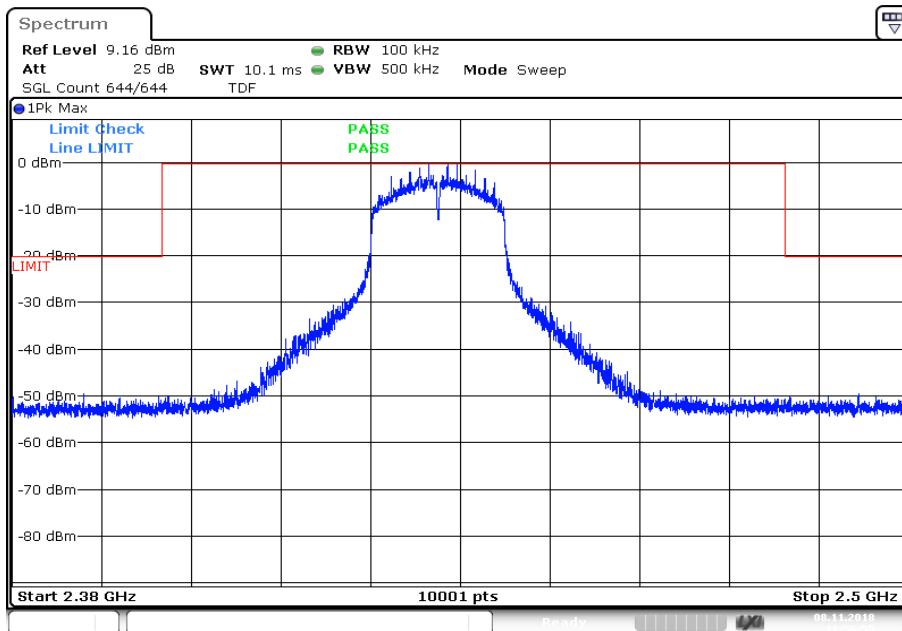

Date: 8.NOV.2018 11:56:55

Plot 5: Highest channel, up to 25 GHz

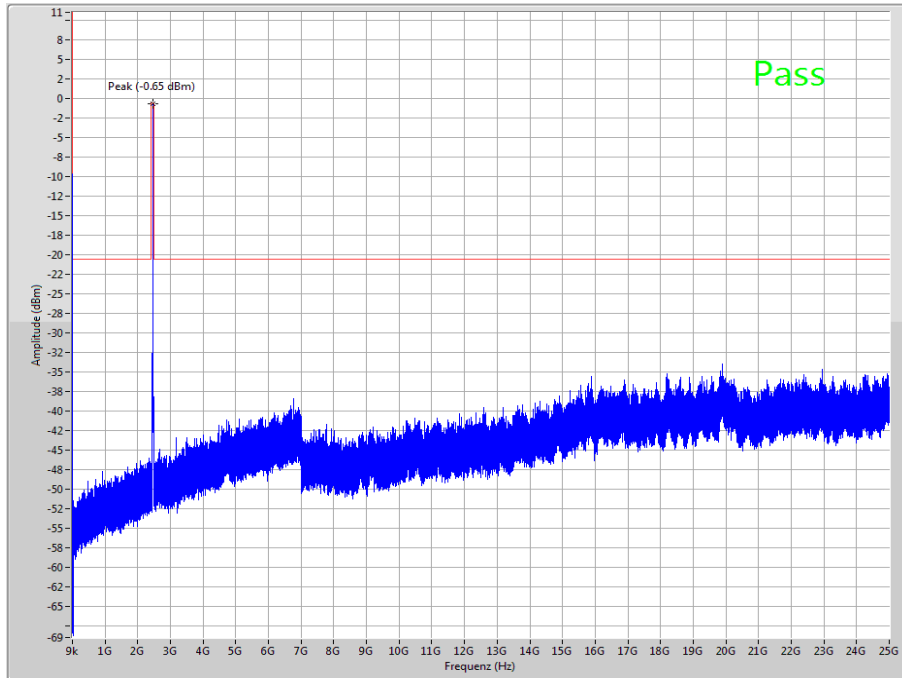

The peak at the beginning of the plot is the LO from the SA.

Plot 6: Highest channel, zoomed carrier

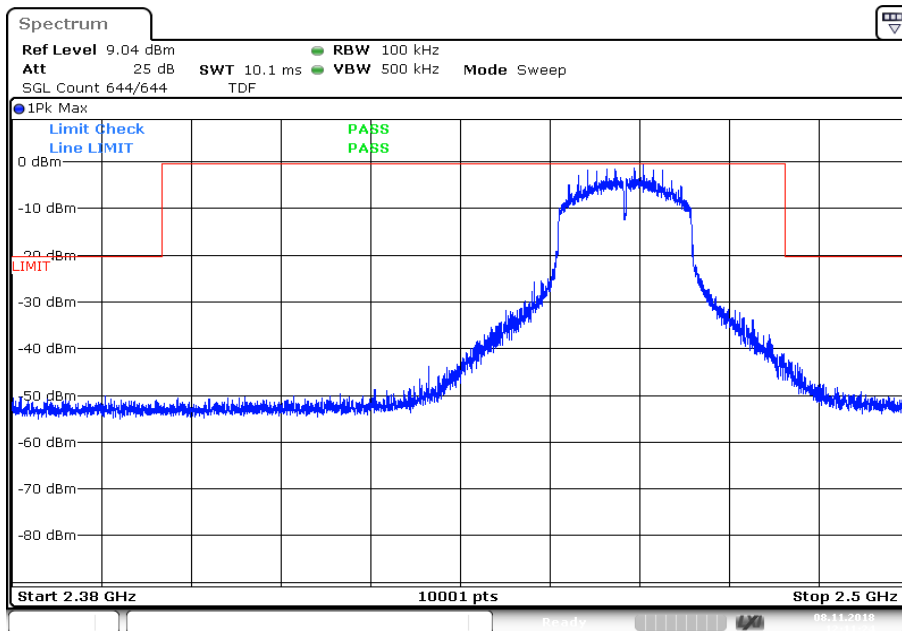

Plots: OFDM / n HT 40 – mode

Plot 1: Lowest channel, up to 25 GHz

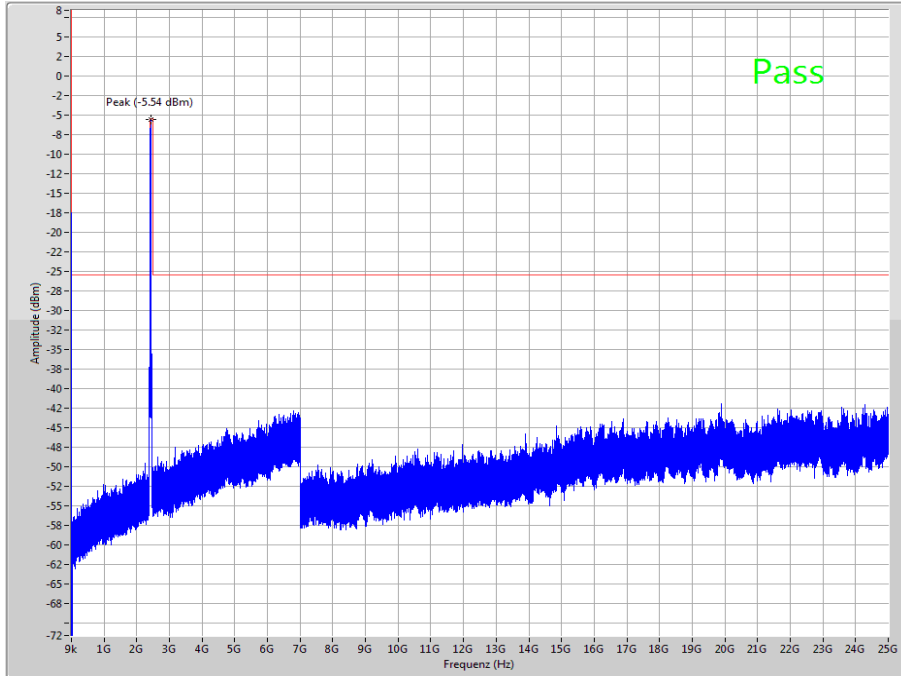

The peak at the beginning of the plot is the LO from the SA.

Plot 2: Lowest channel, zoomed carrier

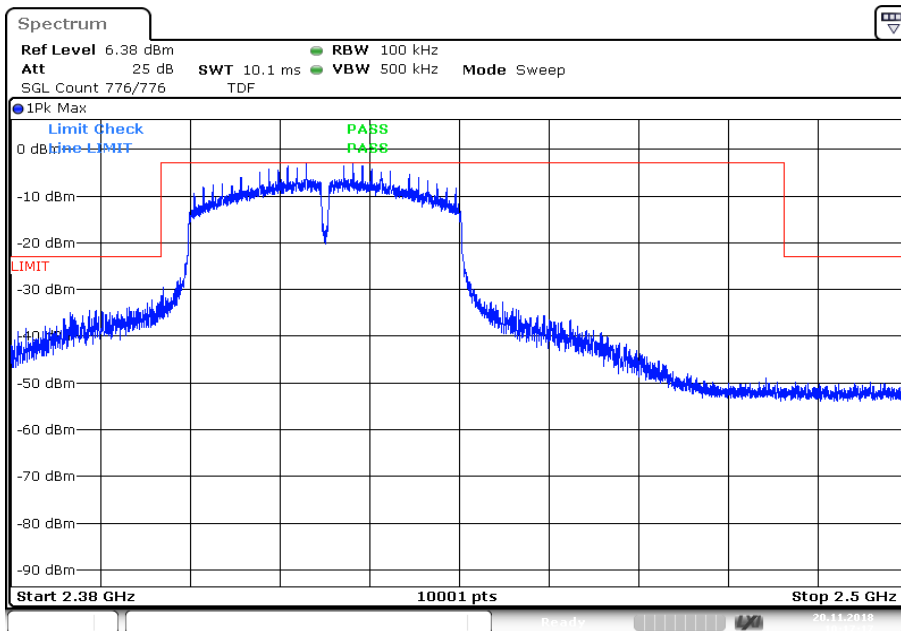

Plot 3: Middle channel, up to 25 GHz

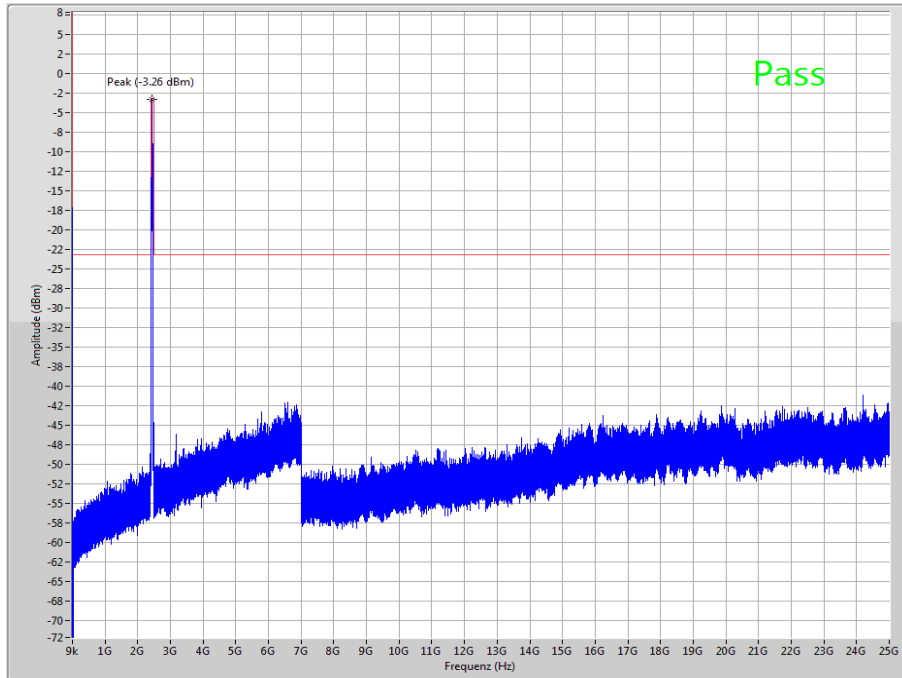

The peak at the beginning of the plot is the LO from the SA.

Plot 4: Middle channel, zoomed carrier

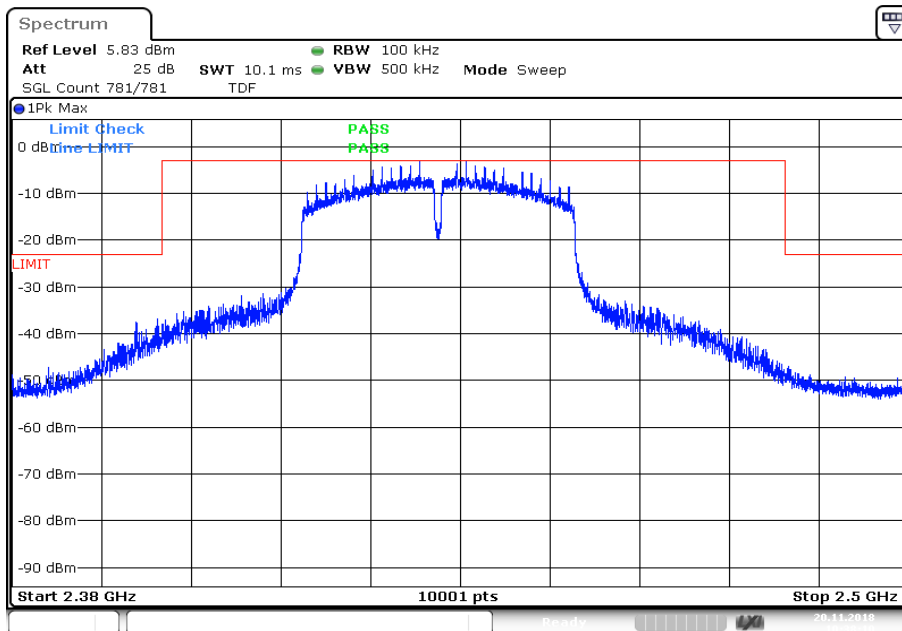

Date: 20.NOV.2018 10:38:11

Plot 5: Highest channel, up to 25 GHz

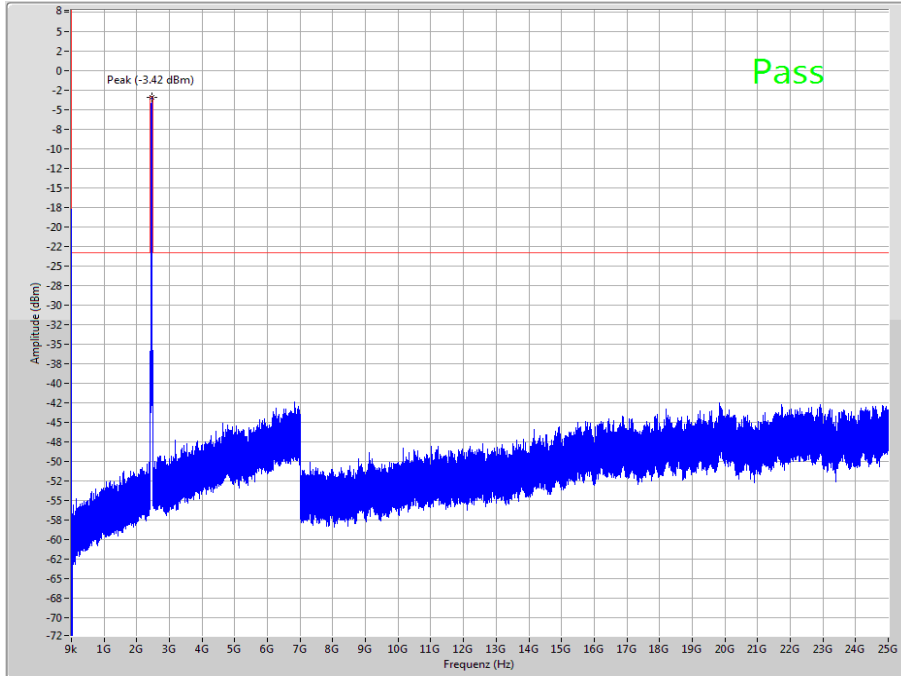

The peak at the beginning of the plot is the LO from the SA.

Plot 6: Highest channel, zoomed carrier

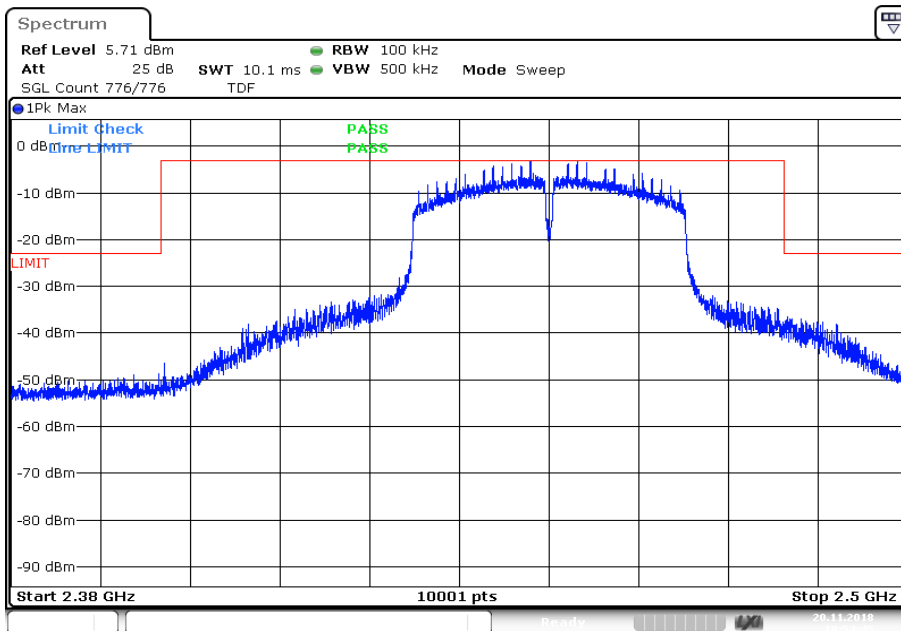

12.11 Spurious emissions radiated below 30 MHz

Description:

Measurement of the radiated spurious emissions in transmit mode below 30 MHz. The limits are recalculated to a measurement distance of 3 m with 40 dB/decade according CFR Part 2.

Measurement:

Measurement parameter	
Detector	Peak / Quasi Peak
Sweep time	Auto
Resolution bandwidth	F < 150 kHz: 200 Hz F > 150 kHz: 9 kHz
Video bandwidth	F < 150 kHz: 1 kHz F > 150 kHz: 100 kHz
Span	9 kHz to 30 MHz
Trace mode	Max Hold
Measured modulation	<input checked="" type="checkbox"/> DSSS b – mode <input type="checkbox"/> OFDM g – mode <input checked="" type="checkbox"/> OFDM n HT20 – mode <input checked="" type="checkbox"/> OFDM n HT40 – mode
Test setup	See chapter 6.2 C
Measurement uncertainty	See chapter 8

Limits:

FCC		IC
Frequency / MHz	Field Strength / (dBµV / m)	Measurement distance / m
0.009 – 0.490	2400/F(kHz)	300
0.490 – 1.705	24000/F(kHz)	30
1.705 – 30.0	30	30

Results:

TX spurious emissions radiated < 30 MHz / (dBµV / m) @ 3 m		
Frequency / MHz	Detector	Level / (dBµV / m)
All detected peaks are more than 20 dB below the limit.		

Plots: DSSS

Plot 1: 9 kHz to 30 MHz, low channel

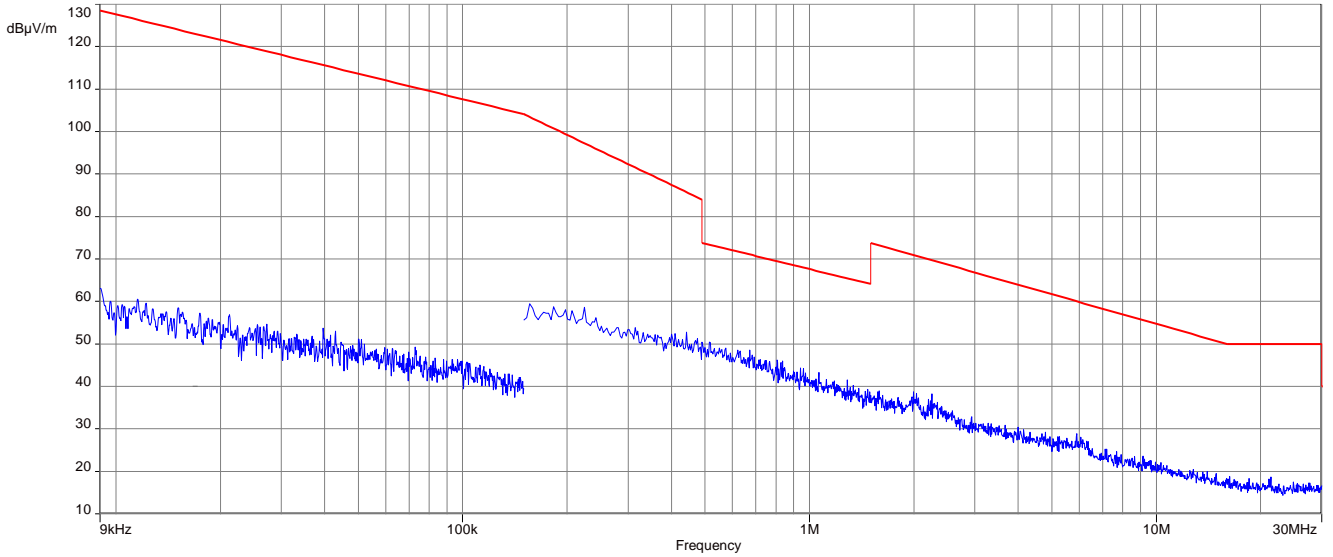

Plot 2: 9 kHz to 30 MHz, mid channel

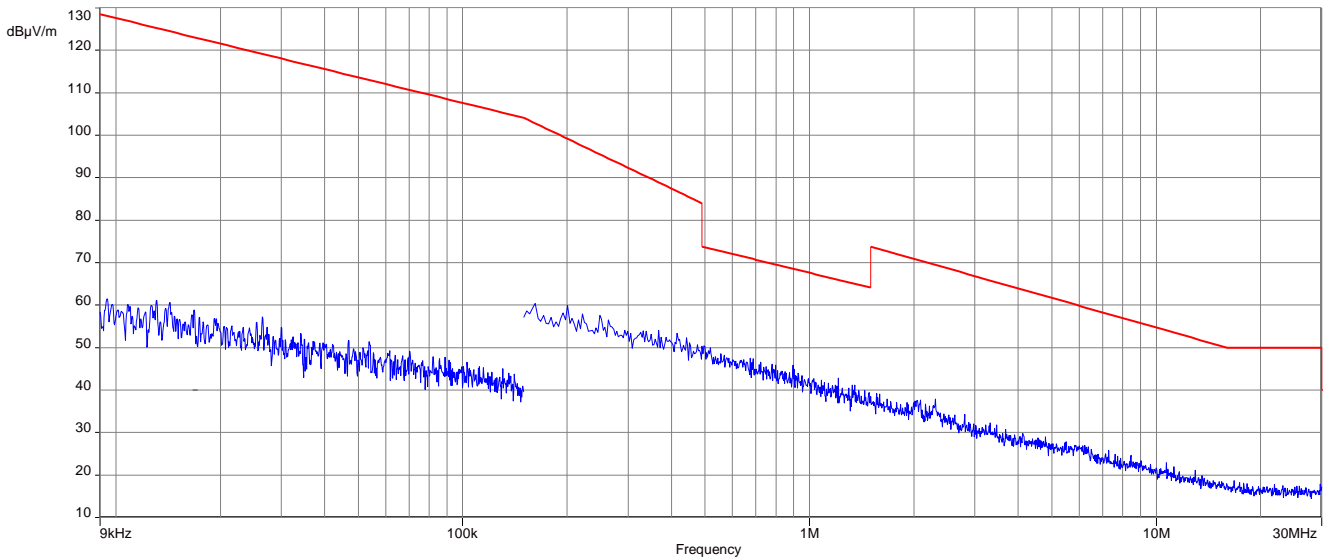

Plot 3: 9 kHz to 30 MHz, high channel

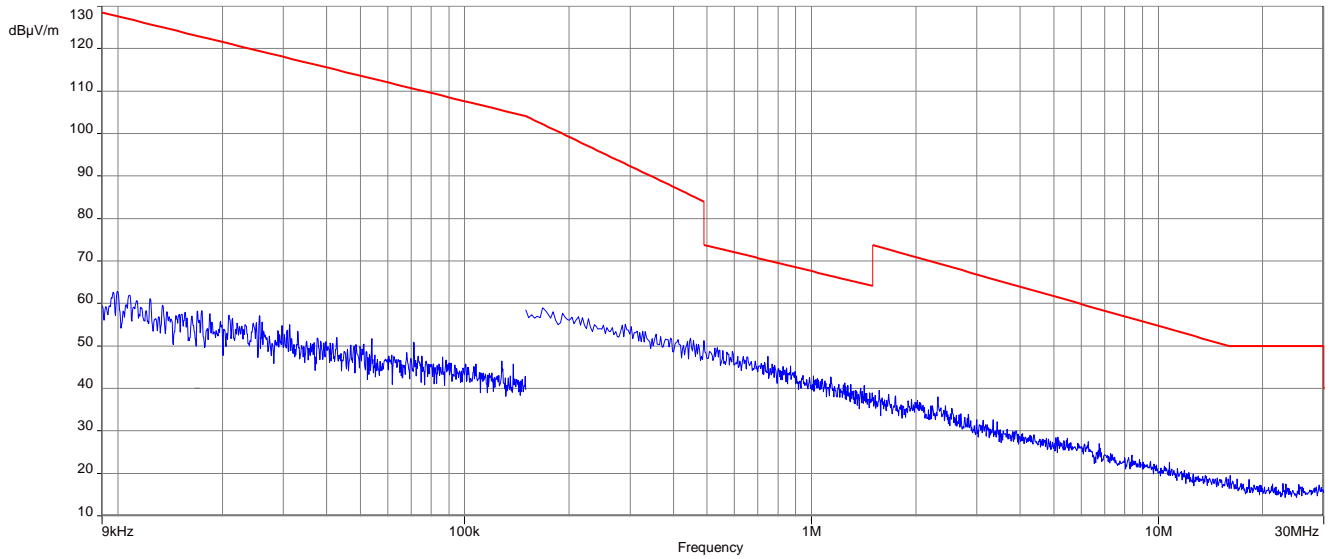

Plots: OFDM (20 MHz bandwidth)

Plot 1: 9 kHz to 30 MHz, low channel

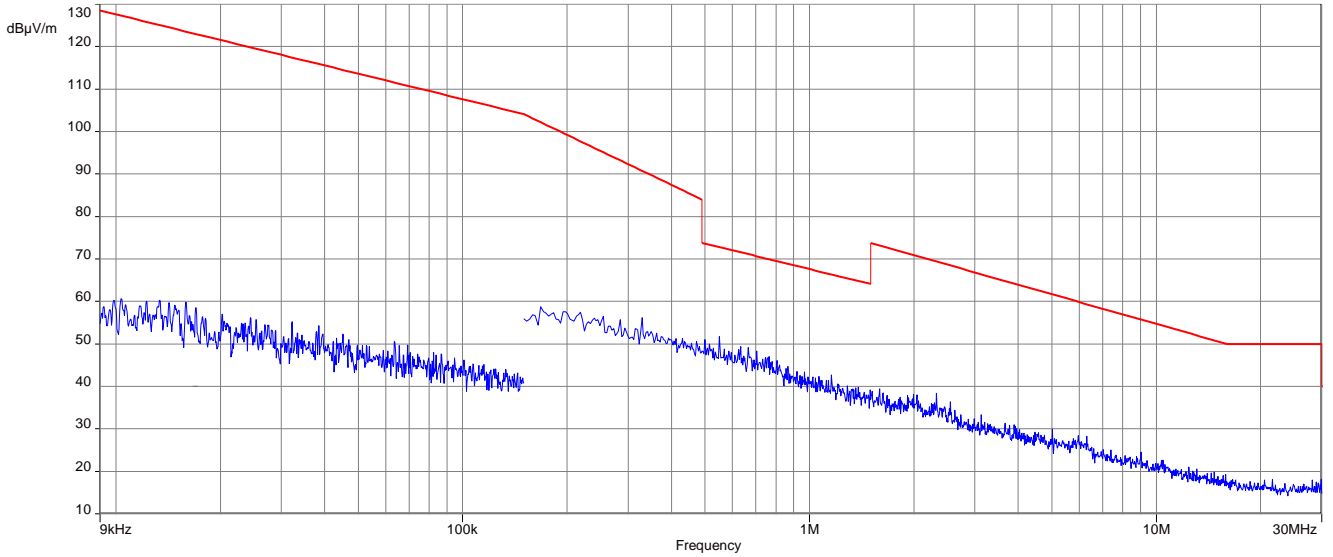

Plot 2: 9 kHz to 30 MHz, mid channel

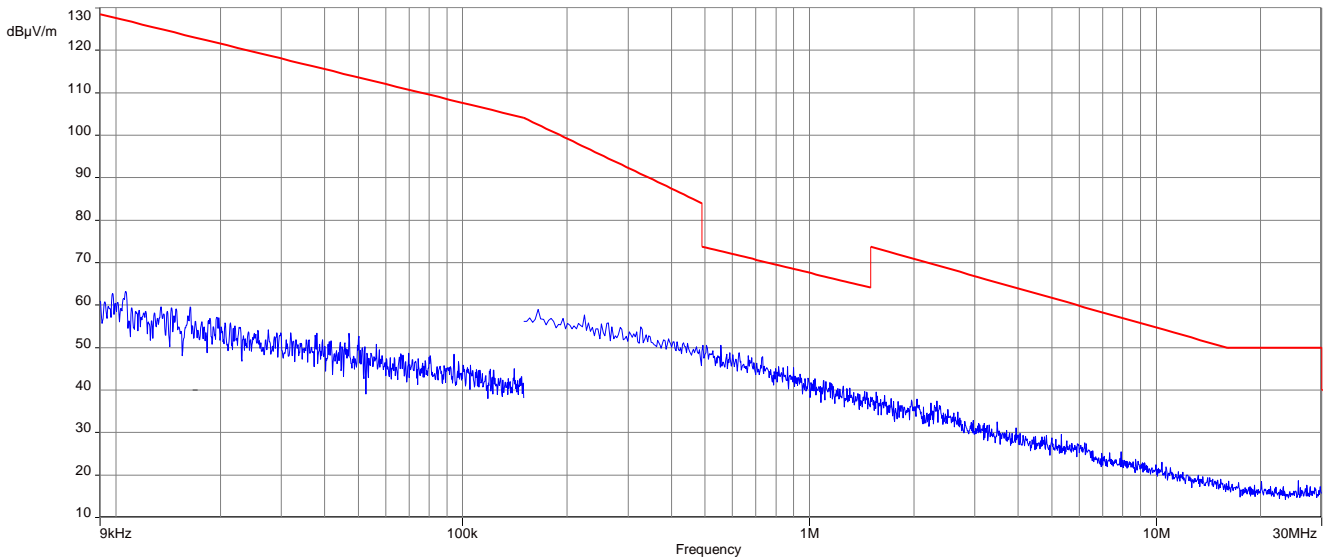

Plot 3: 9 kHz to 30 MHz, high channel

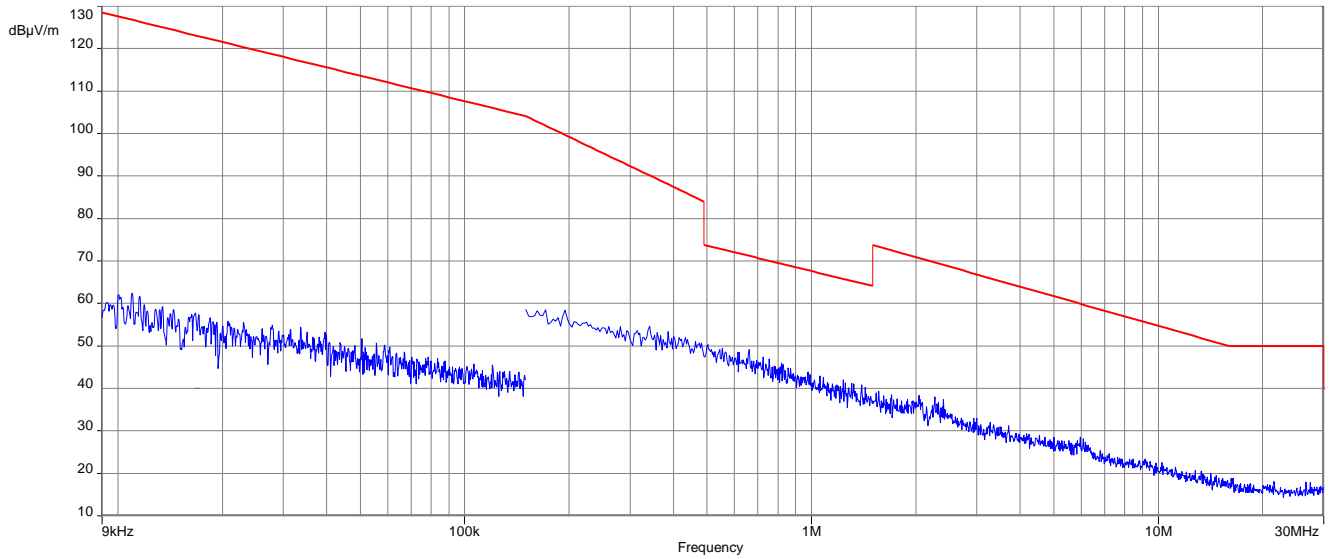

Plots: OFDM (40 MHz bandwidth)

Plot 1: 9 kHz to 30 MHz, low channel

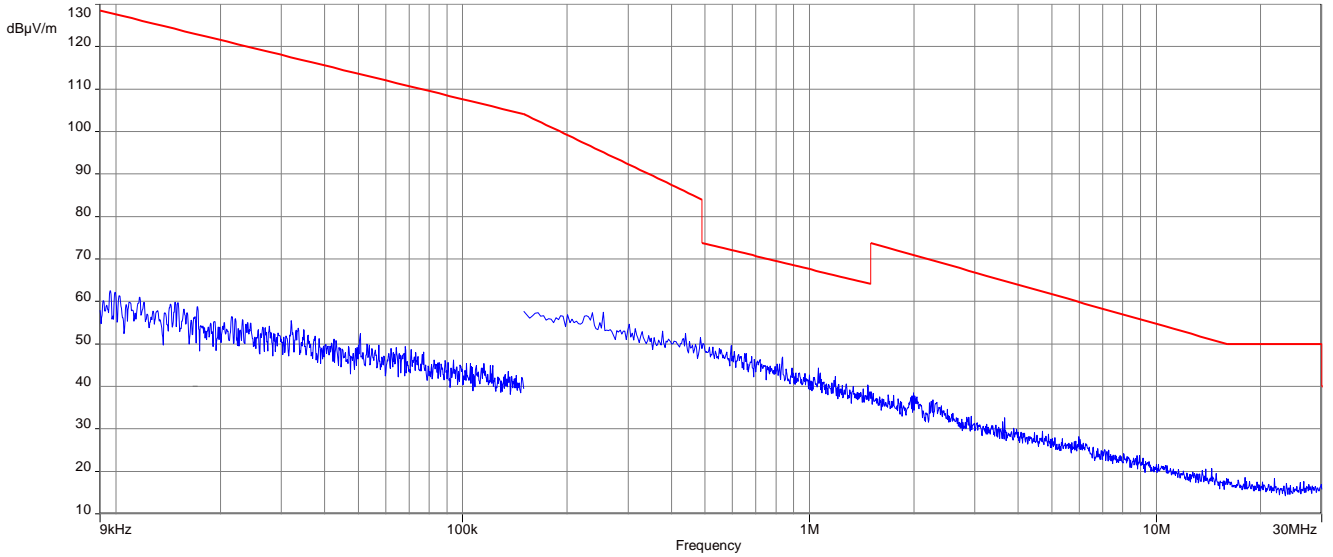

Plot 2: 9 kHz to 30 MHz, mid channel

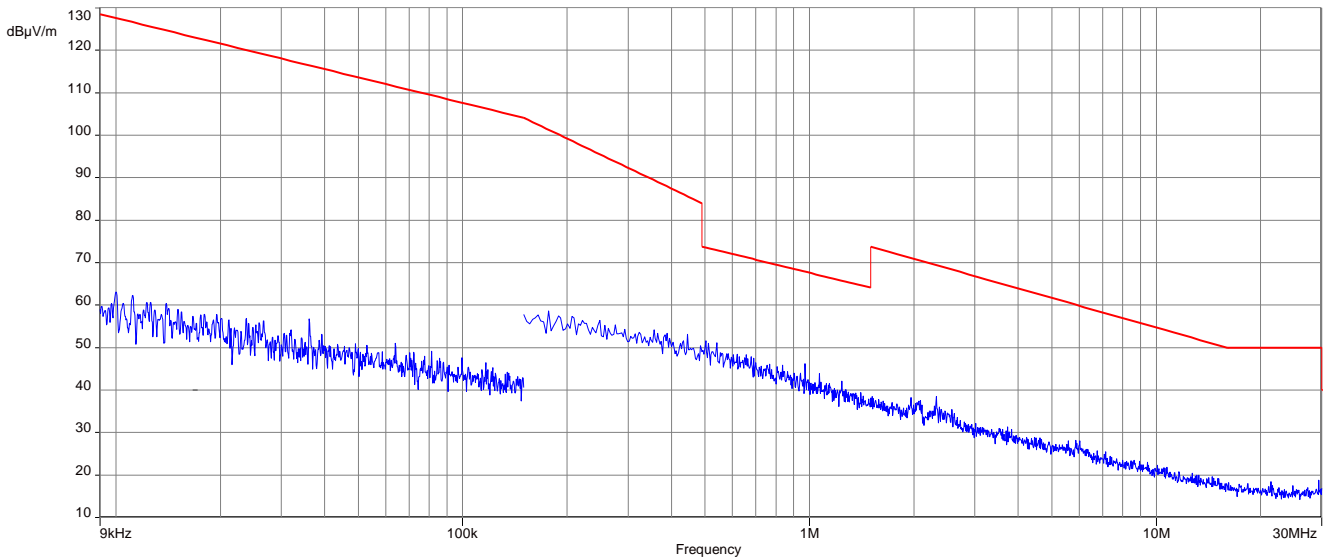

Plot 3: 9 kHz to 30 MHz, high channel

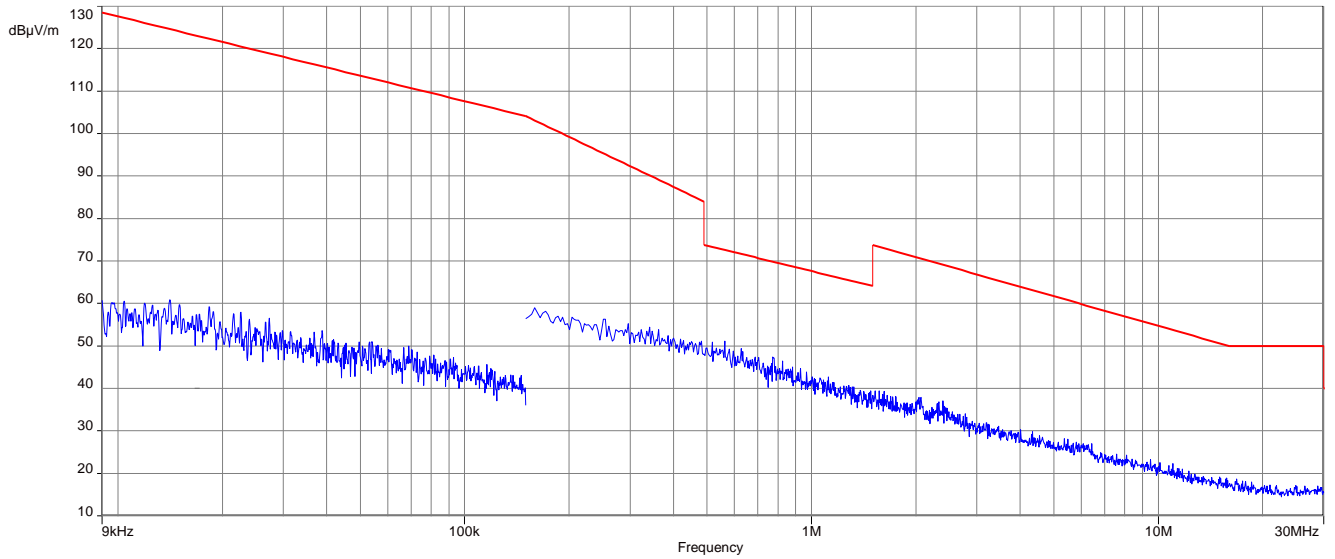

12.12 Spurious emissions radiated 30 MHz to 1 GHz

Description:

Measurement of the radiated spurious emissions and cabinet radiations below 1 GHz.

Measurement:

Measurement parameter	
Detector	Peak / Quasi Peak
Sweep time	Auto
Resolution bandwidth	120 kHz
Video bandwidth	3 x RBW
Span	30 MHz to 1 GHz
Trace mode	Max Hold
Measured modulation	<input checked="" type="checkbox"/> DSSS b – mode <input type="checkbox"/> OFDM g – mode <input checked="" type="checkbox"/> OFDM n HT20 – mode <input checked="" type="checkbox"/> OFDM n HT40 – mode <input checked="" type="checkbox"/> RX / Idle – mode
Test setup	See chapter 6.1 A
Measurement uncertainty	See chapter 8

Limits:

FCC	IC	
In any 100 kHz bandwidth outside the frequency band in which the spread spectrum or digitally modulated intentional radiator is operating, the radio frequency power that is produced by the intentional radiator shall be at least 20 dB below that in the 100 kHz bandwidth within the band that contains the highest level of the desired power, based on either an RF conducted or a radiated measurement. Attenuation below the general limits specified in Section 15.209(a) is not required. In addition, radiated emissions which fall in the restricted bands, as defined in §15.205(a), must also comply with the radiated emission limits specified in §15.209(a) (see §15.205(c)).		
Frequency / MHz	Field Strength / (dBµV / m)	Measurement distance / m
30 – 88	30.0	10
88 – 216	33.5	10
216 – 960	36.0	10

Plot: DSSS

Plot 1: 30 MHz to 1 GHz, vertical & horizontal polarization, low channel

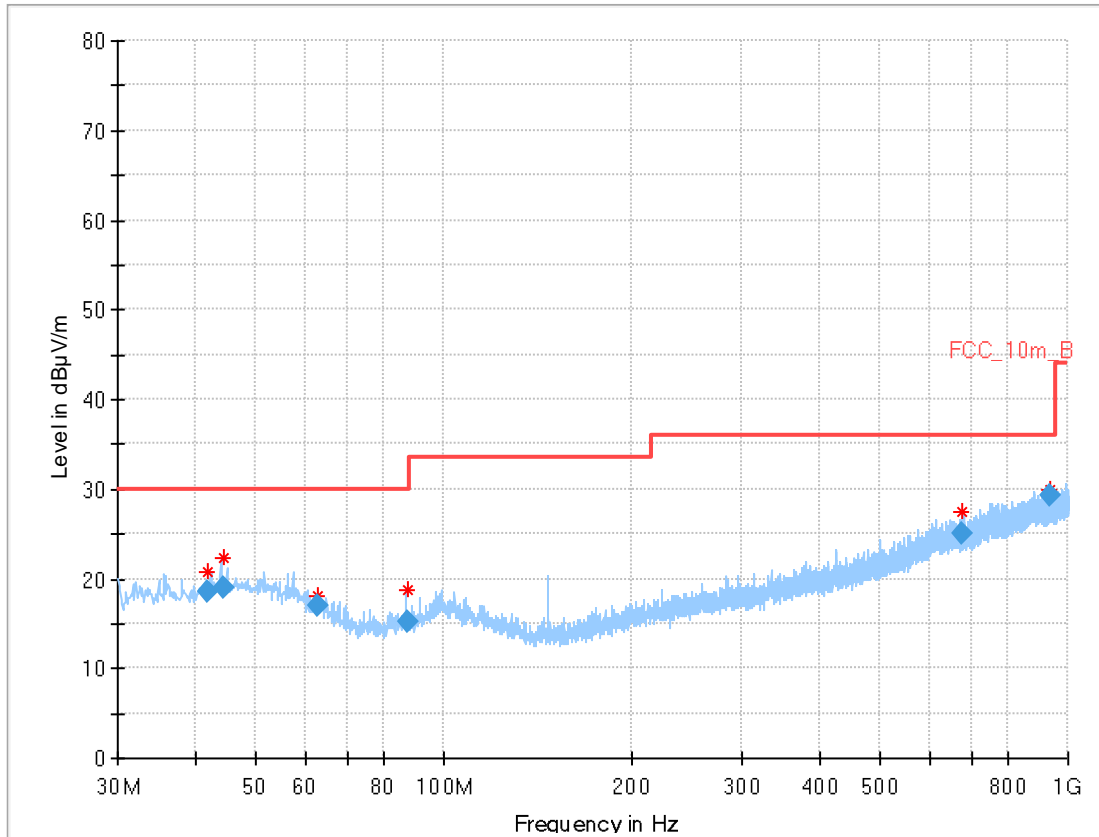

Final_Result:

Frequency (MHz)	QuasiPeak (dBµV/m)	Limit (dBµV/m)	Margin (dB)	Meas. Time (ms)	Bandwidth (kHz)	Height (cm)	Pol	Azimuth (deg)	Corr. (dB)
41.902	18.61	30.0	11.39	1000	120	101.0	H	297.0	14.5
44.472	18.93	30.0	11.07	1000	120	160.0	V	251.0	14.7
62.985	17.04	30.0	12.96	1000	120	101.0	V	91.0	12.3
87.380	15.12	30.0	14.88	1000	120	160.0	H	0.0	11.3
674.365	25.08	36.0	10.92	1000	120	160.0	V	217.0	20.9
935.385	29.19	36.0	6.81	1000	120	160.0	V	157.0	24.0

Plot 2: 30 MHz to 1 GHz, vertical & horizontal polarization, mid channel

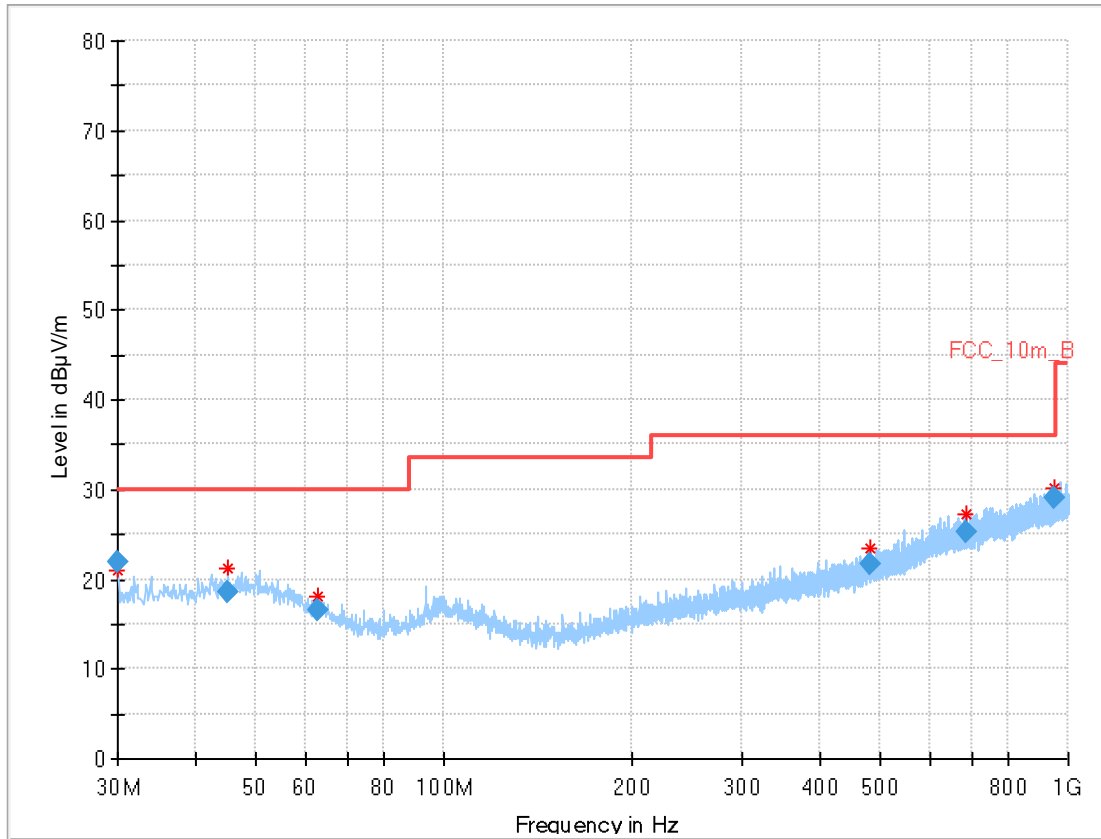

Final_Result:

Frequency (MHz)	QuasiPeak (dBµV/m)	Limit (dBµV/m)	Margin (dB)	Meas. Time (ms)	Bandwidth (kHz)	Height (cm)	Pol	Azimuth (deg)	Corr. (dB)
30.000	22.00	30.0	8.00	1000	120	160.0	V	121.0	13.0
44.877	18.65	30.0	11.35	1000	120	100.0	V	233.0	14.8
62.702	16.64	30.0	13.36	1000	120	98.0	V	30.0	12.4
481.556	21.63	36.0	14.37	1000	120	98.0	V	160.0	17.9
686.130	25.25	36.0	10.75	1000	120	160.0	V	1.0	21.0
953.100	29.07	36.0	6.93	1000	120	98.0	H	14.0	24.1

Plot 3: 30 MHz to 1 GHz, vertical & horizontal polarization, high channel

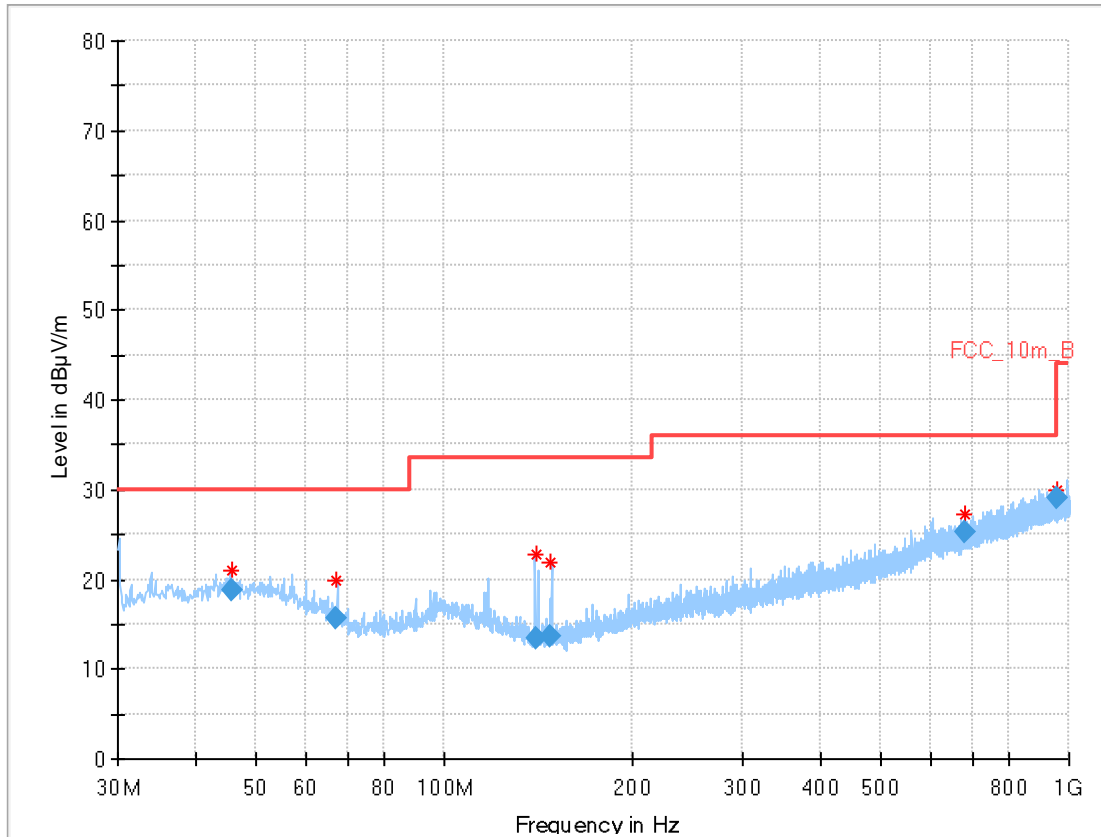

Final_Result:

Frequency (MHz)	QuasiPeak (dBµV/m)	Limit (dBµV/m)	Margin (dB)	Meas. Time (ms)	Bandwidth (kHz)	Height (cm)	Pol	Azimuth (deg)	Corr. (dB)
45.775	18.72	30.0	11.28	1000	120	98.0	H	124.0	14.8
66.882	15.55	30.0	14.45	1000	120	98.0	H	309.0	11.5
140.272	13.37	33.5	20.13	1000	120	160.0	H	0.0	9.8
147.996	13.74	33.5	19.76	1000	120	160.0	H	339.0	10.1
682.319	25.25	36.0	10.75	1000	120	160.0	V	98.0	21.0
956.355	29.09	36.0	6.91	1000	120	160.0	H	150.0	24.1

Plot: OFDM (20 MHz bandwidth)

Plot 1: 30 MHz to 1 GHz, vertical & horizontal polarization, low channel

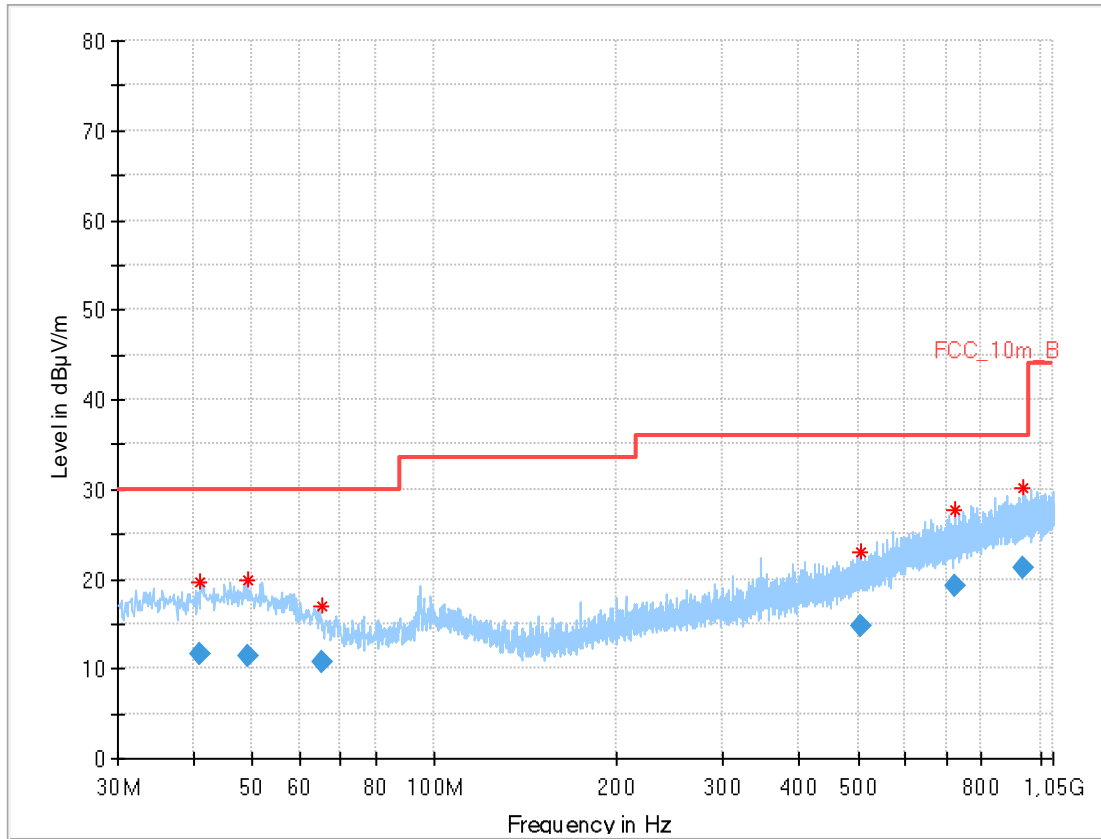

Final_Result:

Frequency (MHz)	QuasiPeak (dBµV/m)	Limit (dBµV/m)	Margin (dB)	Meas. Time (ms)	Bandwidth (kHz)	Height (cm)	Pol	Azimuth (deg)	Corr. (dB)
41.054	11.55	30.0	18.45	1000	120	170.0	V	90.0	14.4
49.199	11.38	30.0	18.62	1000	120	100.0	H	0.0	14.9
65.002	10.62	30.0	19.38	1000	120	98.0	H	270.0	11.9
506.640	14.79	36.0	21.21	1000	120	101.0	V	270.0	18.4
724.054	19.21	36.0	16.79	1000	120	170.0	V	270.0	21.7
936.612	21.28	36.0	14.72	1000	120	101.0	V	90.0	24.0

Plot 2: 30 MHz to 1 GHz, vertical & horizontal polarization, mid channel

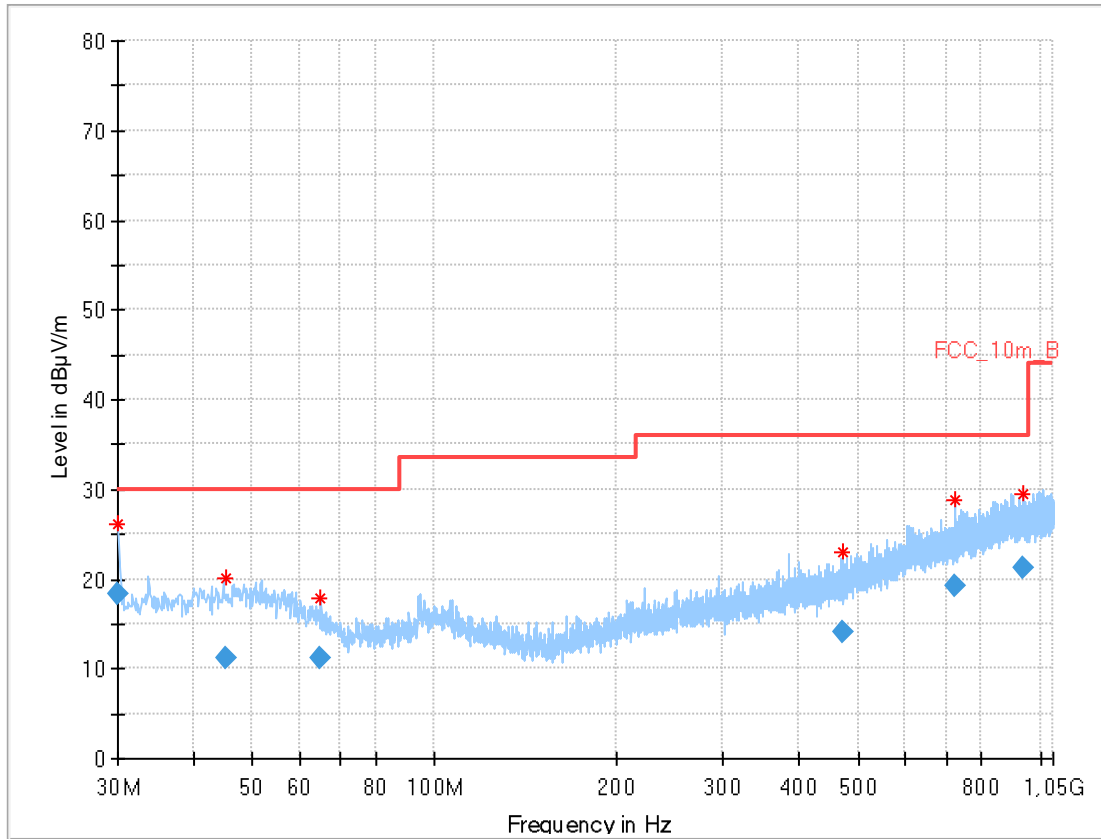

Final_Result:

Frequency (MHz)	QuasiPeak (dBµV/m)	Limit (dBµV/m)	Margin (dB)	Meas. Time (ms)	Bandwidth (kHz)	Height (cm)	Pol	Azimuth (deg)	Corr. (dB)
30.042	18.38	30.0	11.62	1000	120	170.0	H	0.0	13.0
45.272	11.17	30.0	18.83	1000	120	170.0	H	90.0	14.8
64.667	11.09	30.0	18.91	1000	120	98.0	V	90.0	12.0
472.025	14.00	36.0	22.00	1000	120	170.0	H	0.0	17.7
724.472	19.22	36.0	16.78	1000	120	170.0	H	180.0	21.7
939.399	21.33	36.0	14.67	1000	120	170.0	H	90.0	24.0

Plot 3: 30 MHz to 1 GHz, vertical & horizontal polarization, high channel

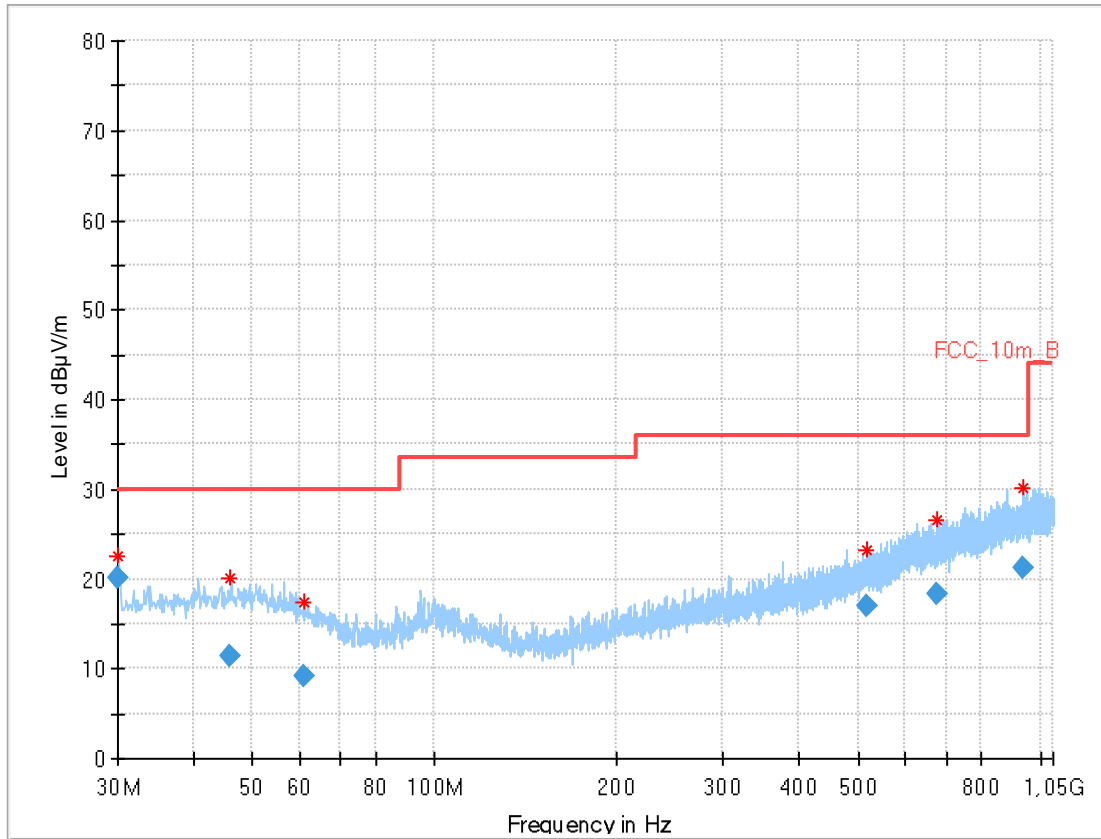

Final_Result:

Frequency (MHz)	QuasiPeak (dBµV/m)	Limit (dBµV/m)	Margin (dB)	Meas. Time (ms)	Bandwidth (kHz)	Height (cm)	Pol	Azimuth (deg)	Corr. (dB)
30.030	20.12	30.0	9.88	1000	120	101.0	V	180.0	13.0
45.916	11.46	30.0	18.54	1000	120	101.0	H	180.0	14.8
60.880	9.09	30.0	20.91	1000	120	101.0	V	180.0	12.8
515.364	17.09	36.0	18.91	1000	120	170.0	V	90.0	18.5
675.078	18.38	36.0	17.62	1000	120	170.0	H	0.0	20.9
935.813	21.28	36.0	14.72	1000	120	98.0	V	270.0	24.0

Plot: OFDM (40 MHz bandwidth)

Plot 1: 30 MHz to 1 GHz, vertical & horizontal polarization, low channel

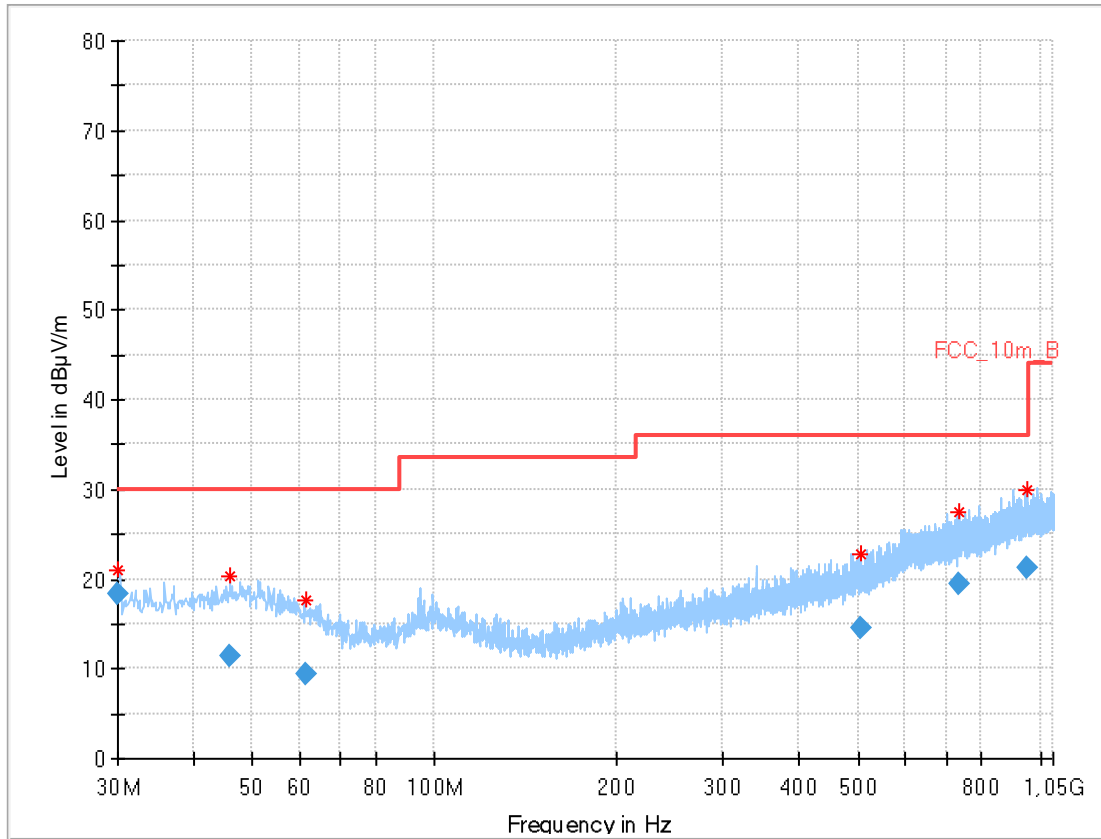

Final_Result:

Frequency (MHz)	QuasiPeak (dBµV/m)	Limit (dBµV/m)	Margin (dB)	Meas. Time (ms)	Bandwidth (kHz)	Height (cm)	Pol	Azimuth (deg)	Corr. (dB)
30.059	18.38	30.0	11.62	1000	120	170.0	H	90.0	13.0
45.820	11.42	30.0	18.58	1000	120	101.0	H	270.0	14.8
61.494	9.31	30.0	20.69	1000	120	101.0	H	90.0	12.7
504.931	14.62	36.0	21.38	1000	120	170.0	V	270.0	18.3
735.926	19.35	36.0	16.65	1000	120	170.0	V	90.0	22.0
953.135	21.33	36.0	14.67	1000	120	101.0	H	90.0	24.1

Plot 2: 30 MHz to 1 GHz, vertical & horizontal polarization, mid channel

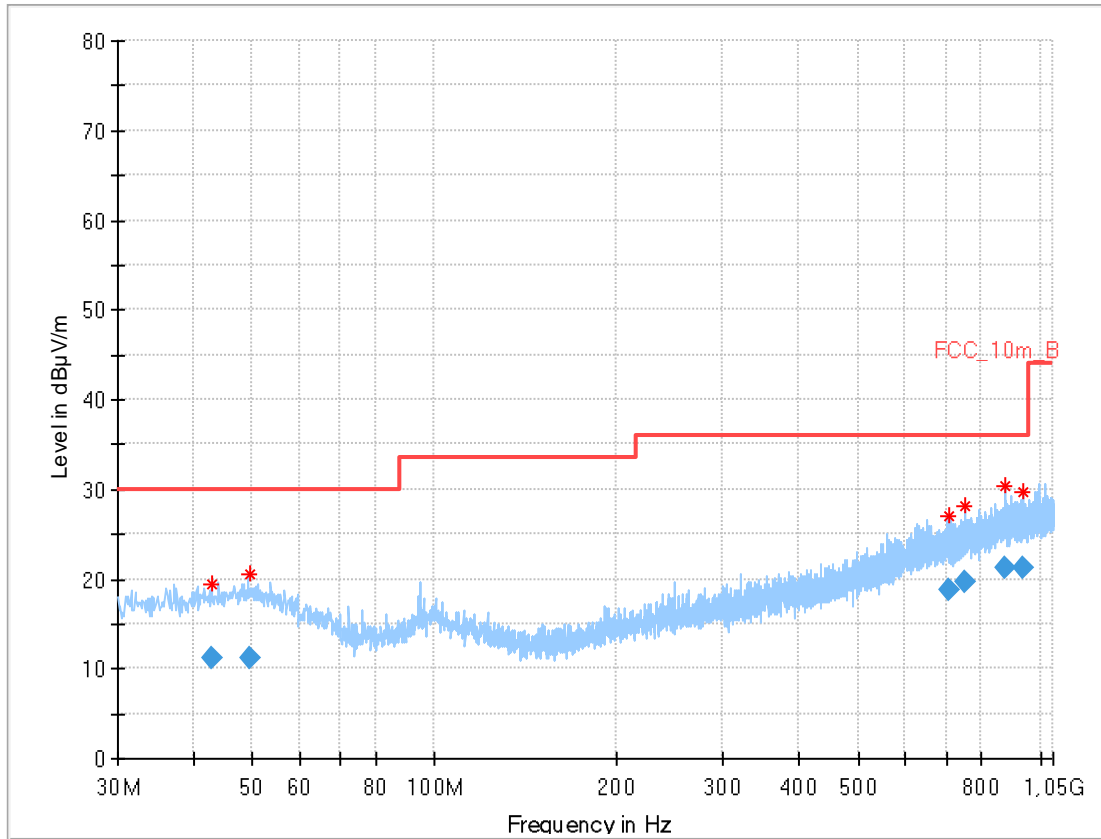

Final_Result:

Frequency (MHz)	QuasiPeak (dBµV/m)	Limit (dBµV/m)	Margin (dB)	Meas. Time (ms)	Bandwidth (kHz)	Height (cm)	Pol	Azimuth (deg)	Corr. (dB)
42.853	11.19	30.0	18.81	1000	120	98.0	V	270.0	14.6
49.646	11.17	30.0	18.83	1000	120	170.0	H	0.0	14.9
708.935	18.80	36.0	17.20	1000	120	170.0	V	0.0	21.3
750.123	19.65	36.0	16.35	1000	120	98.0	V	180.0	22.3
875.416	21.22	36.0	14.78	1000	120	170.0	H	0.0	23.5
934.252	21.31	36.0	14.69	1000	120	101.0	H	180.0	24.0

Plot 3: 30 MHz to 1 GHz, vertical & horizontal polarization, high channel

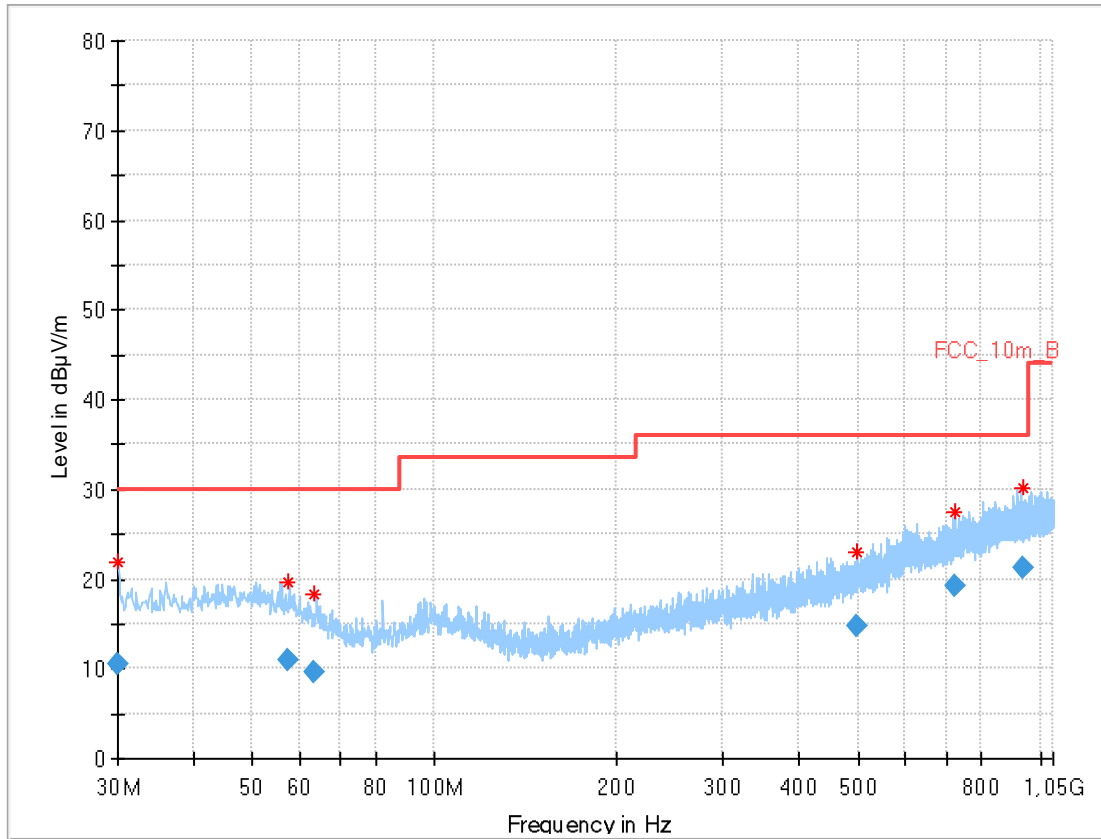

Final_Result:

Frequency (MHz)	QuasiPeak (dBµV/m)	Limit (dBµV/m)	Margin (dB)	Meas. Time (ms)	Bandwidth (kHz)	Height (cm)	Pol	Azimuth (deg)	Corr. (dB)
30.001	10.60	30.0	19.40	1000	120	101.0	H	0.0	13.0
57.491	10.90	30.0	19.10	1000	120	101.0	V	270.0	13.6
63.444	9.71	30.0	20.29	1000	120	101.0	H	180.0	12.2
499.355	14.78	36.0	21.22	1000	120	98.0	H	270.0	18.2
722.679	19.11	36.0	16.89	1000	120	101.0	V	90.0	21.7
933.501	21.29	36.0	14.71	1000	120	170.0	H	270.0	24.0

Plot: RX / Idle mode

Plot 1: 30 MHz to 1 GHz, vertical & horizontal polarization

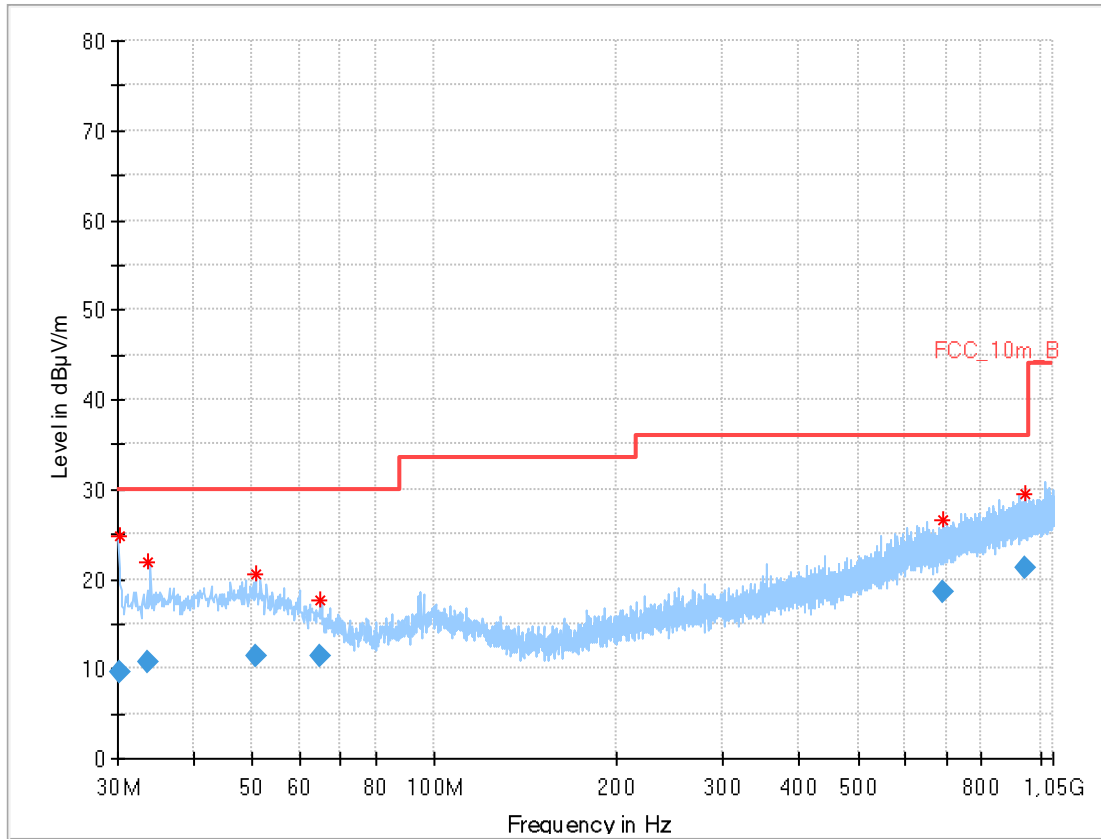

Final_Result:

Frequency (MHz)	QuasiPeak (dBµV/m)	Limit (dBµV/m)	Margin (dB)	Meas. Time (ms)	Bandwidth (kHz)	Height (cm)	Pol	Azimuth (deg)	Corr. (dB)
30.253	9.69	30.0	20.31	1000	120	101.0	H	180.0	13.0
33.721	10.75	30.0	19.25	1000	120	101.0	H	90.0	13.6
50.857	11.40	30.0	18.60	1000	120	98.0	H	180.0	14.8
64.796	11.38	30.0	18.62	1000	120	101.0	V	180.0	11.9
691.324	18.52	36.0	17.48	1000	120	100.0	V	0.0	21.1
944.504	21.29	36.0	14.71	1000	120	170.0	V	0.0	24.0

12.13 Spurious emissions radiated above 1 GHz

Description:

Measurement of the radiated spurious emissions above 1 GHz in transmit mode and receiver / idle mode.

Measurement:

Measurement parameter	
Detector	Peak / RMS
Sweep time	Auto
Resolution bandwidth	1 MHz
Video bandwidth	3 x RBW
Span	1 GHz to 26 GHz
Trace mode	Max Hold
Measured modulation	<input checked="" type="checkbox"/> DSSS b – mode <input type="checkbox"/> OFDM g – mode <input checked="" type="checkbox"/> OFDM n HT20 – mode <input checked="" type="checkbox"/> OFDM n HT40 – mode <input checked="" type="checkbox"/> RX / Idle – mode
Test setup	See chapter 6.2 B
Measurement uncertainty	See chapter 8

Limits:

FCC		IC
In any 100 kHz bandwidth outside the frequency band in which the spread spectrum or digitally modulated intentional radiator is operating, the radio frequency power that is produced by the intentional radiator shall be at least 30 dB below that in the 100 kHz bandwidth within the band that contains the highest level of the desired power, based on either an RF conducted or a radiated measurement. Attenuation below the general limits specified in Section 15.209(a) is not required. In addition, radiated emissions which fall in the restricted bands, as defined in §15.205(a), must also comply with the radiated emission limits specified in §15.209(a) (see §15.205(c)).		
Frequency / MHz	Field Strength / (dBµV / m)	Measurement distance / m
Above 960	54.0 (AVG)	3
	74.0 (peak)	

Results:

Results: DSSS

TX spurious emissions radiated / dBµV/m @ 3 m								
lowest channel			middle channel			highest channel		
F [MHz]	Detector	Level [dBµV/m]	F [MHz]	Detector	Level [dBµV/m]	F [MHz]	Detector	Level [dBµV/m]
4824	Peak	54.6	4874	Peak	Peak below average limit.	4924	Peak	Peak below average limit.
	AVG	50.9		AVG				
7236	Peak	46.5	7311	Peak	No RB	7386	Peak	No RB
	AVG	-/-		AVG				
9648	Peak	No RB	9748	Peak	No RB	9848	Peak	No RB
	AVG			AVG				
-/-	Peak	-/-	-/-	Peak	-/-	-/-	Peak	-/-
	AVG	-/-		AVG	-/-		AVG	-/-

Results: OFDM (20 MHz bandwidth)

TX spurious emissions radiated / dBµV/m @ 3 m								
lowest channel			middle channel			highest channel		
F [MHz]	Detector	Level [dBµV/m]	F [MHz]	Detector	Level [dBµV/m]	F [MHz]	Detector	Level [dBµV/m]
4824	Peak	Peak below average limit.	4874	Peak	Peak below average limit.	4924	Peak	Peak below average limit.
	AVG			AVG				
7236	Peak	Peak below average limit.	7311	Peak	No RB	7386	Peak	No RB
	AVG			AVG				
9648	Peak	No RB	9748	Peak	No RB	9848	Peak	No RB
	AVG			AVG				
-/-	Peak	-/-	-/-	Peak	-/-	-/-	Peak	-/-
	AVG	-/-		AVG	-/-		AVG	-/-

Results: OFDM (40 MHz bandwidth)

TX spurious emissions radiated / dBµV/m @ 3 m								
lowest channel			middle channel			highest channel		
F [MHz]	Detector	Level [dBµV/m]	F [MHz]	Detector	Level [dBµV/m]	F [MHz]	Detector	Level [dBµV/m]
4822	Peak	Peak below average limit.	4874	Peak	Peak below average limit.	4904	Peak	Peak below average limit.
	AVG			AVG				
7366	Peak	Peak below average limit.	7311	Peak	No RB	7356	Peak	Peak below average limit.
	AVG			AVG				
9688	Peak	No RB	9748	Peak	No RB	9808	Peak	No RB
	AVG			AVG				
-/-	Peak	-/-	-/-	Peak	-/-	-/-	Peak	-/-
	AVG			AVG				

Results: RX / idle – mode

TX spurious emissions radiated / dBµV/m @ 3 m		
F [MHz]	Detector	Level [dBµV/m]
No emissions detected.		
-/-	Peak	-/-
	AVG	-/-

Plots: DSSS

Plot 1: Lowest channel, 1 GHz to 18 GHz, vertical & horizontal polarization

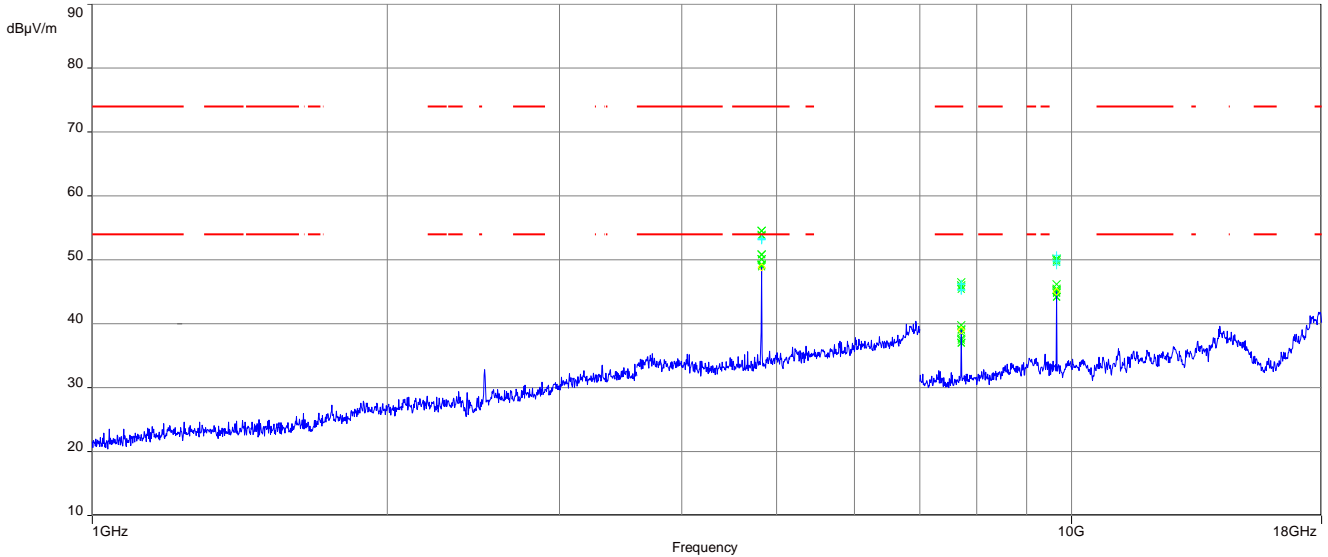

The carrier signal is notched with a 2.4 GHz band rejection filter.

Plot 2: Lowest channel, 18 GHz to 26 GHz, vertical & horizontal polarization

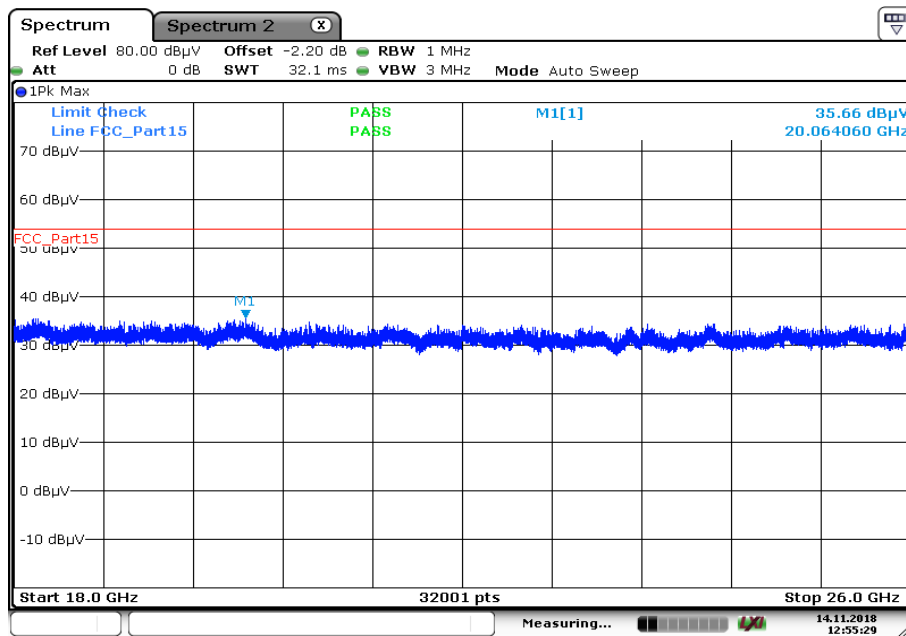

Date: 14.NOV.2018 12:55:29

Plot 3: Middle channel, 1 GHz to 18 GHz, vertical & horizontal polarization

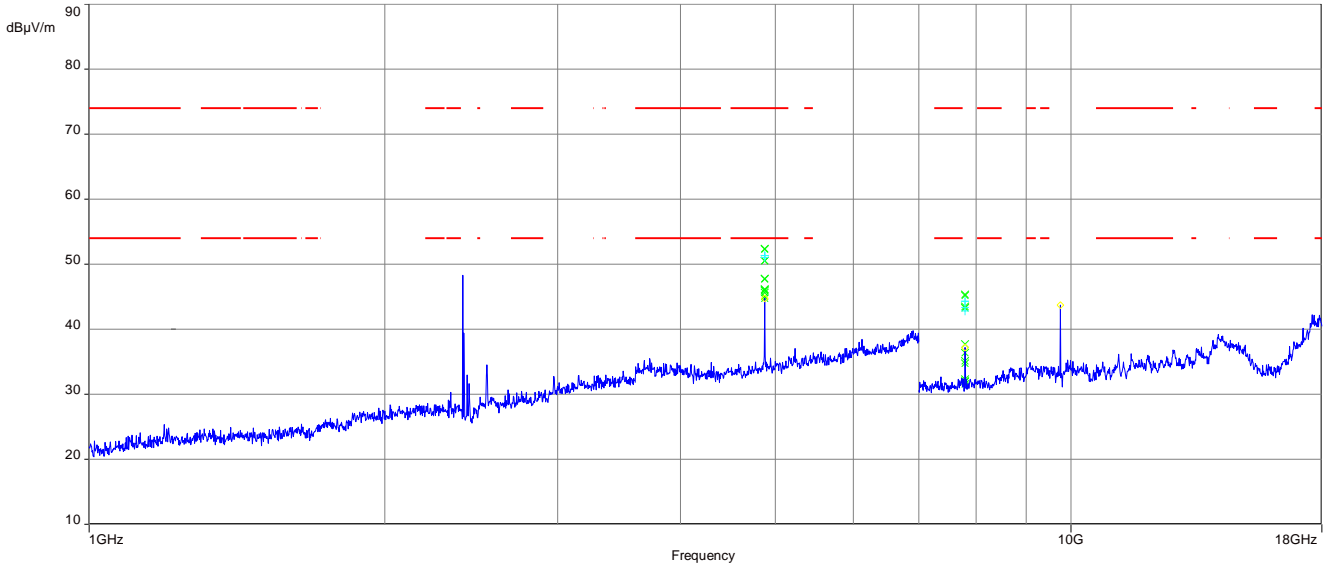

The carrier signal is notched with a 2.4 GHz band rejection filter.

Plot 4: Middle channel, 18 GHz to 26 GHz, vertical & horizontal polarization

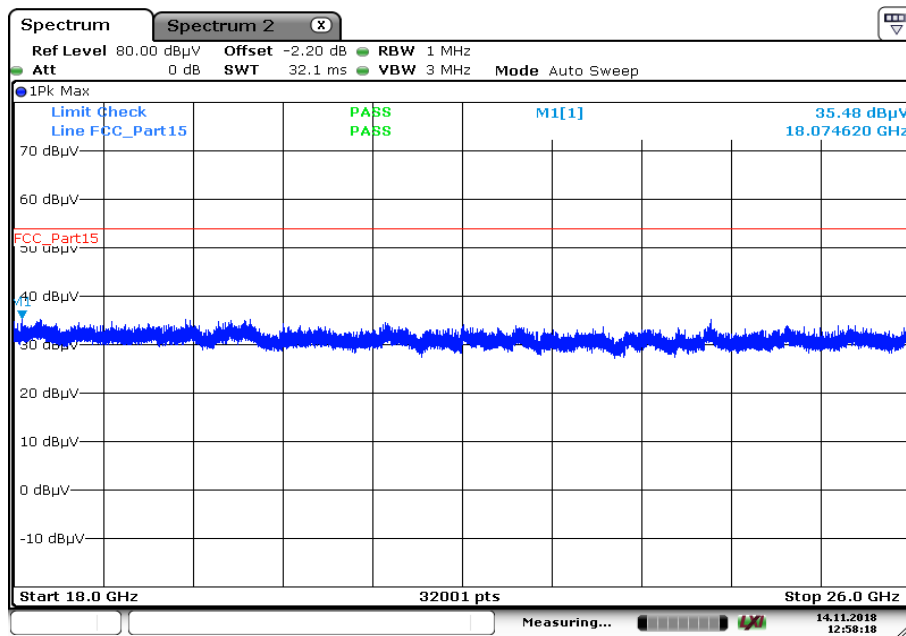

Date: 14.NOV.2018 12:58:18

Plot 5: Highest channel, 1 GHz to 18 GHz, vertical & horizontal polarization

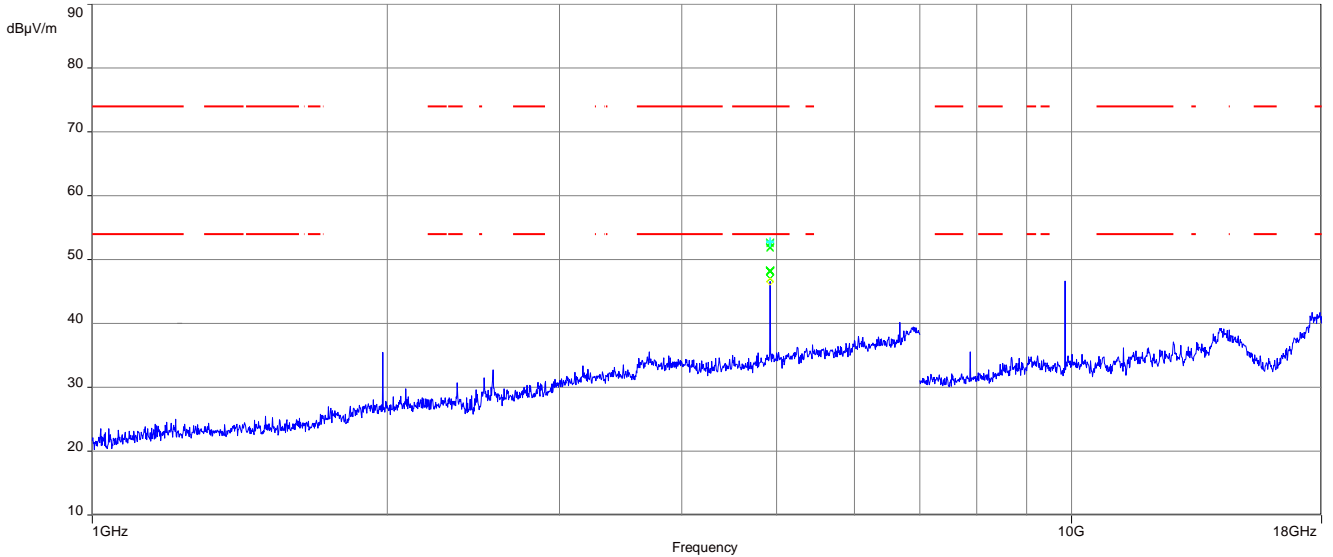

The carrier signal is notched with a 2.4 GHz band rejection filter.

Plot 6: Highest channel, 18 GHz to 26 GHz, vertical & horizontal polarization

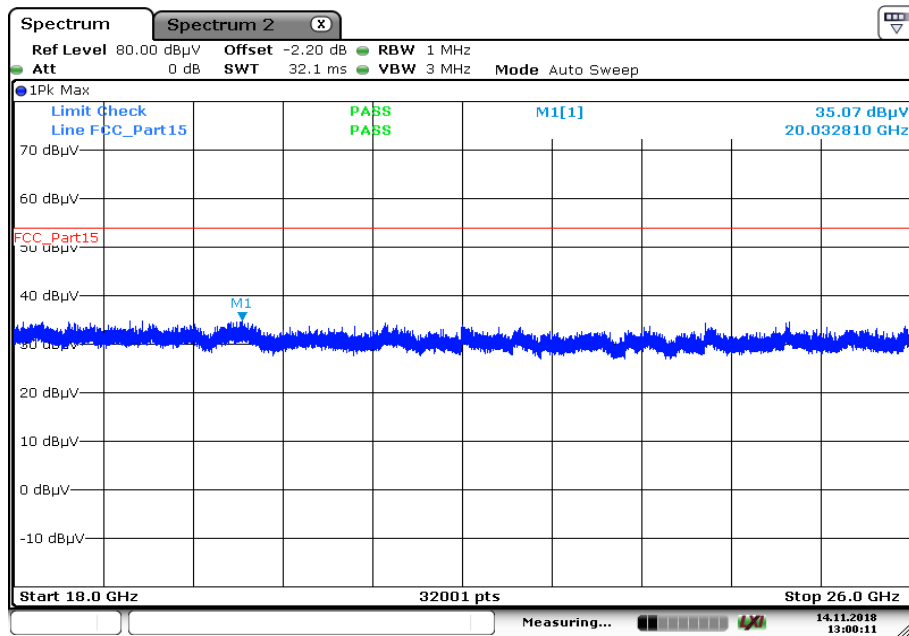

Plots: OFDM (20 MHz bandwidth)

Plot 1: Lowest channel, 1 GHz to 18 GHz, vertical & horizontal polarization

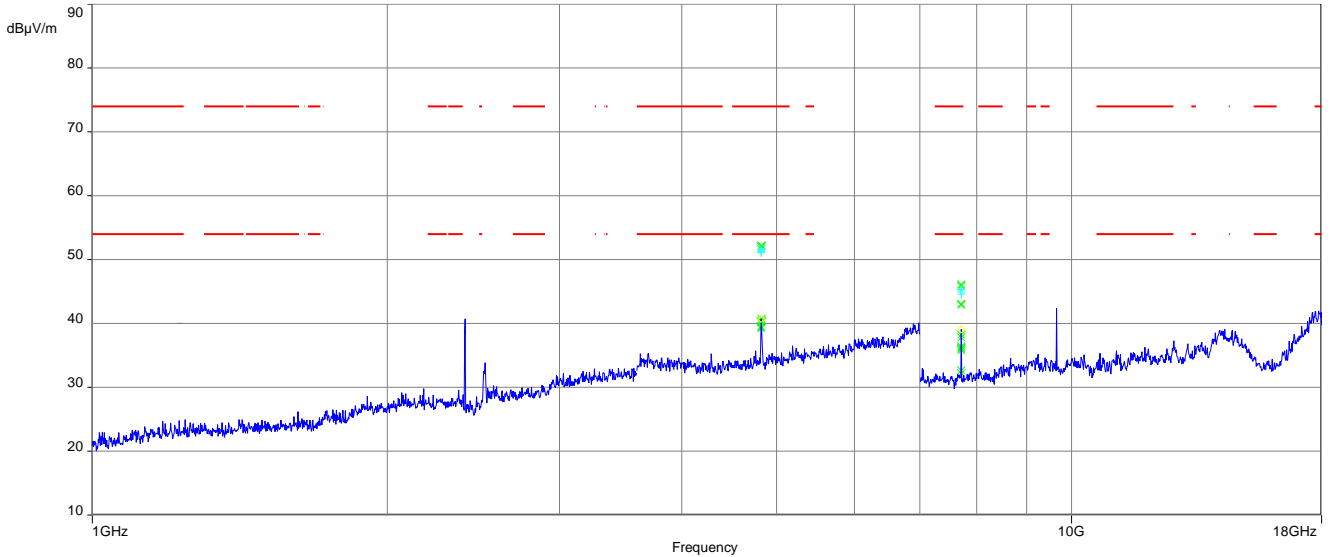

The carrier signal is notched with a 2.4 GHz band rejection filter.

Plot 2: Lowest channel, 18 GHz to 26 GHz, vertical & horizontal polarization

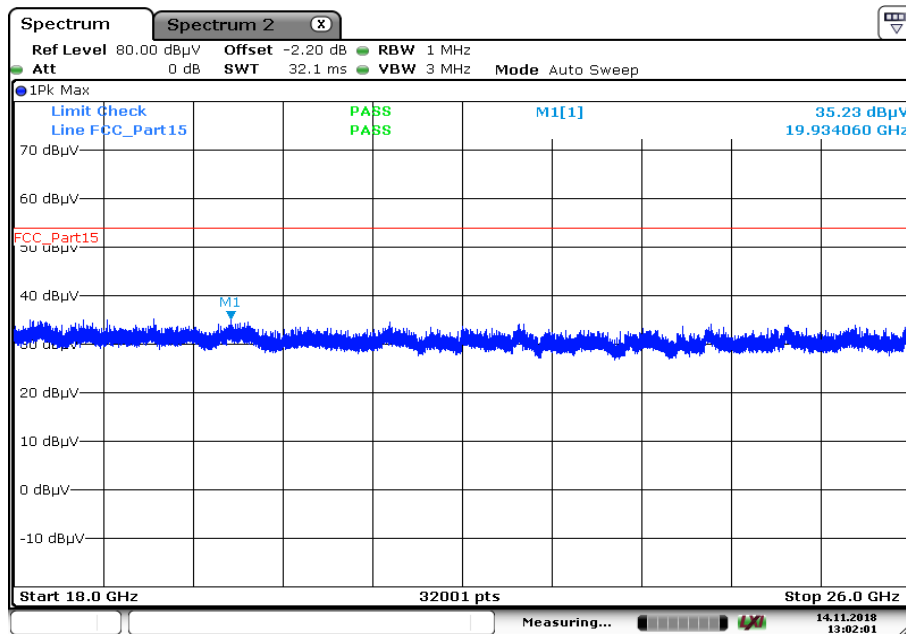

Date: 14.NOV.2018 13:02:01

Plot 3: Middle channel, 1 GHz to 18 GHz, vertical & horizontal polarization

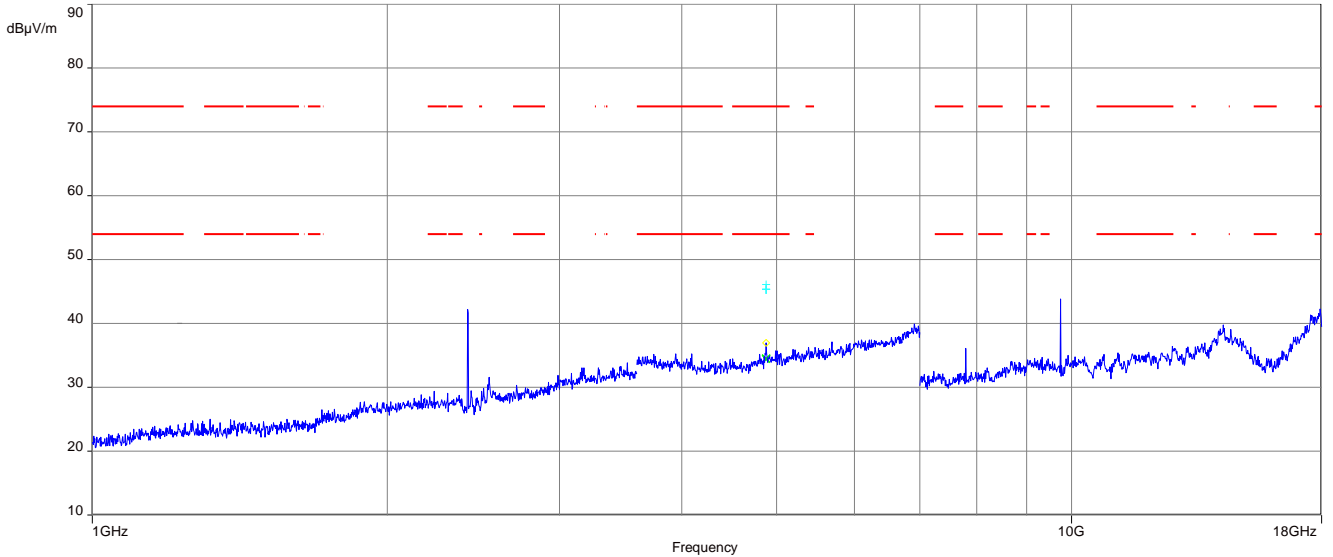

The carrier signal is notched with a 2.4 GHz band rejection filter.

Plot 4: Middle channel, 18 GHz to 26 GHz, vertical & horizontal polarization

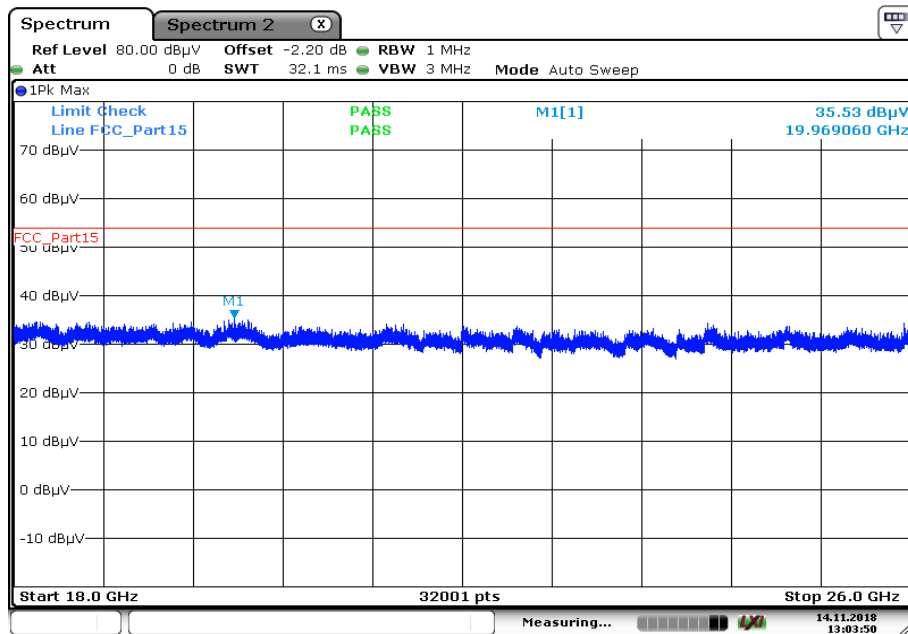

Date: 14.NOV.2018 13:03:51

Plot 5: Highest channel, 1 GHz to 18 GHz, vertical & horizontal polarization

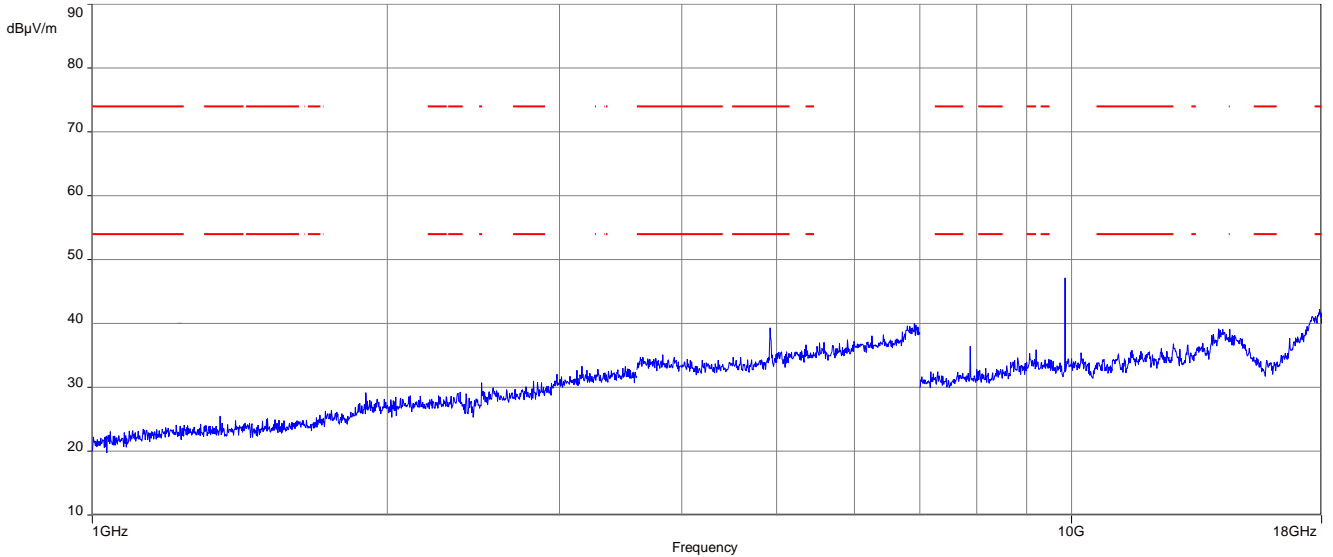

The carrier signal is notched with a 2.4 GHz band rejection filter.

Plot 6: Highest channel, 18 GHz to 26 GHz, vertical & horizontal polarization

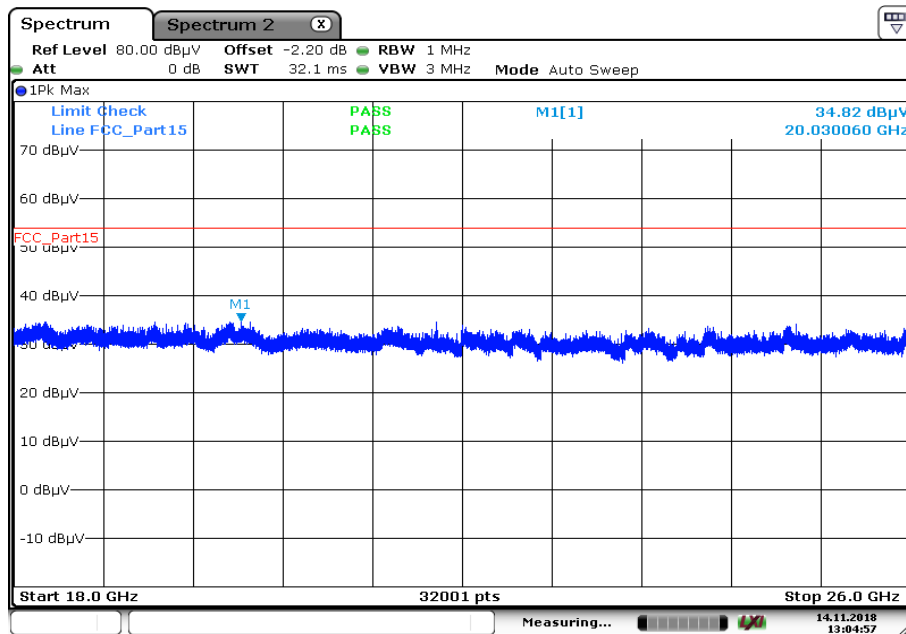

Date: 14.NOV.2018 13:04:57

Plots: OFDM (40 MHz bandwidth)

Plot 1: Lowest channel, 1 GHz to 18 GHz, vertical & horizontal polarization

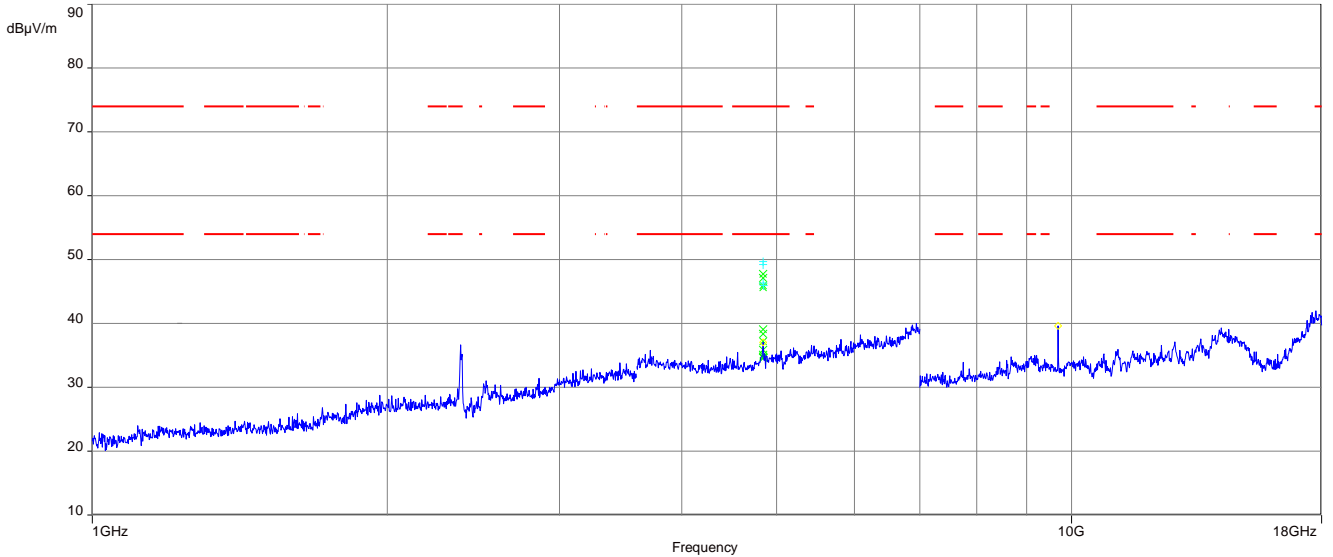

The carrier signal is notched with a 2.4 GHz band rejection filter.

Plot 2: Lowest channel, 18 GHz to 26 GHz, vertical & horizontal polarization

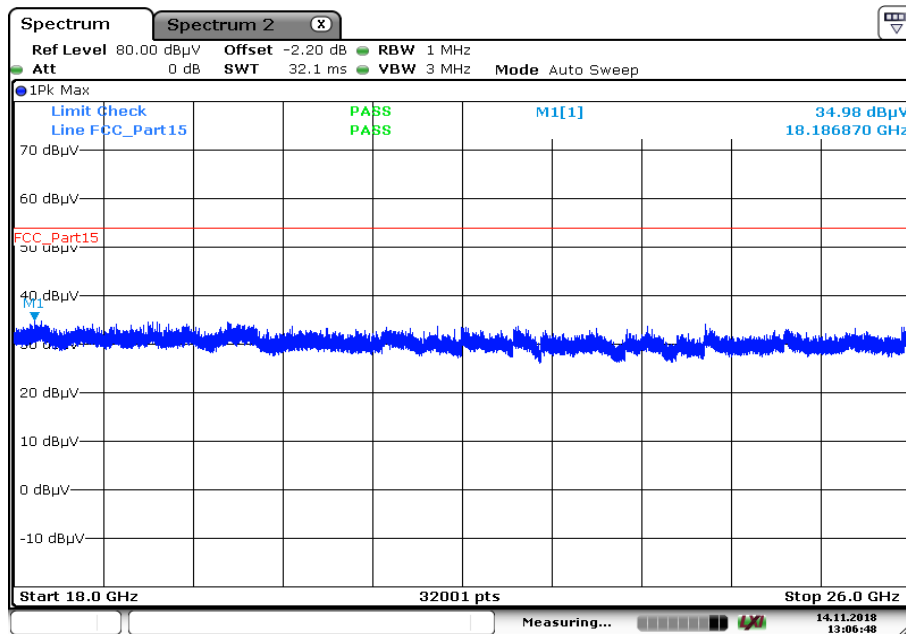

Date: 14.NOV.2018 13:06:48

Plot 3: Middle channel, 1 GHz to 18 GHz, vertical & horizontal polarization

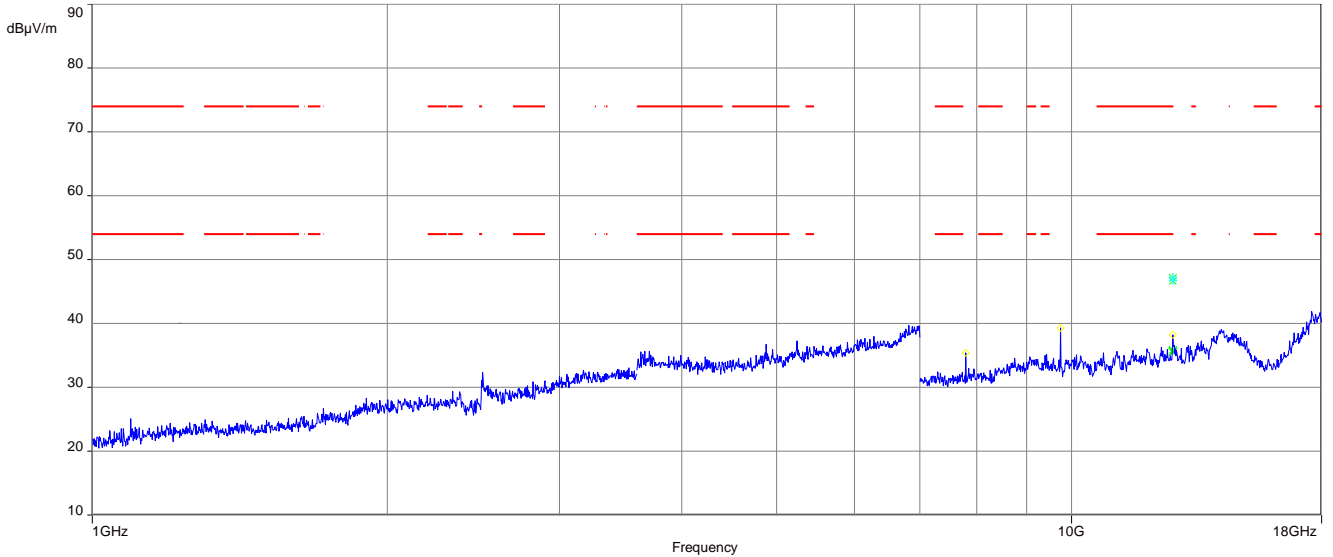

The carrier signal is notched with a 2.4 GHz band rejection filter.

Plot 4: Middle channel, 18 GHz to 26 GHz, vertical & horizontal polarization

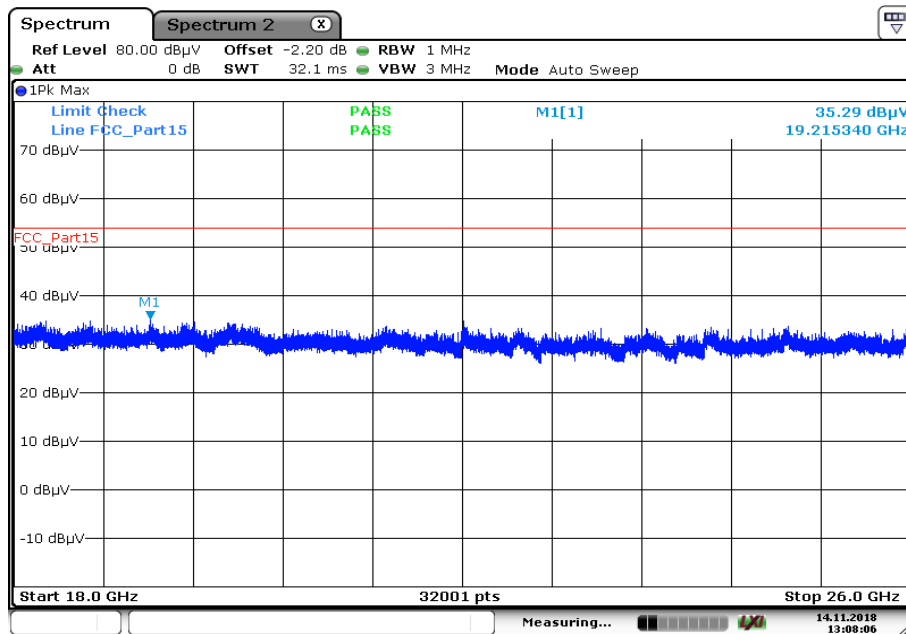

Plot 5: Highest channel, 1 GHz to 18 GHz, vertical & horizontal polarization

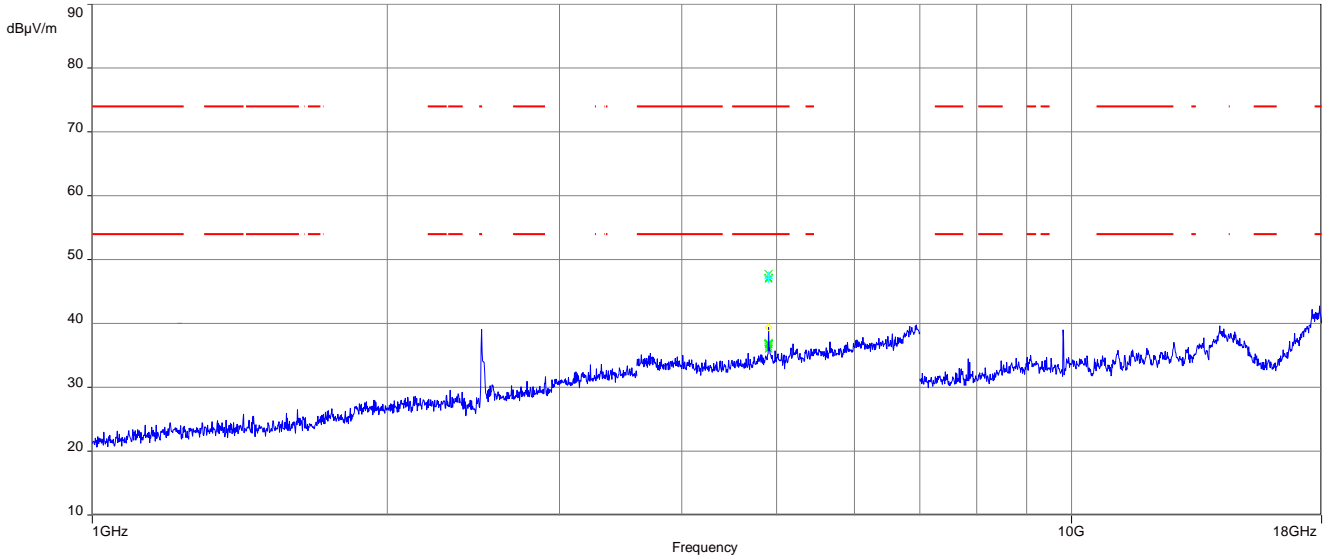

The carrier signal is notched with a 2.4 GHz band rejection filter.

Plot 6: Highest channel, 18 GHz to 26 GHz, vertical & horizontal polarization

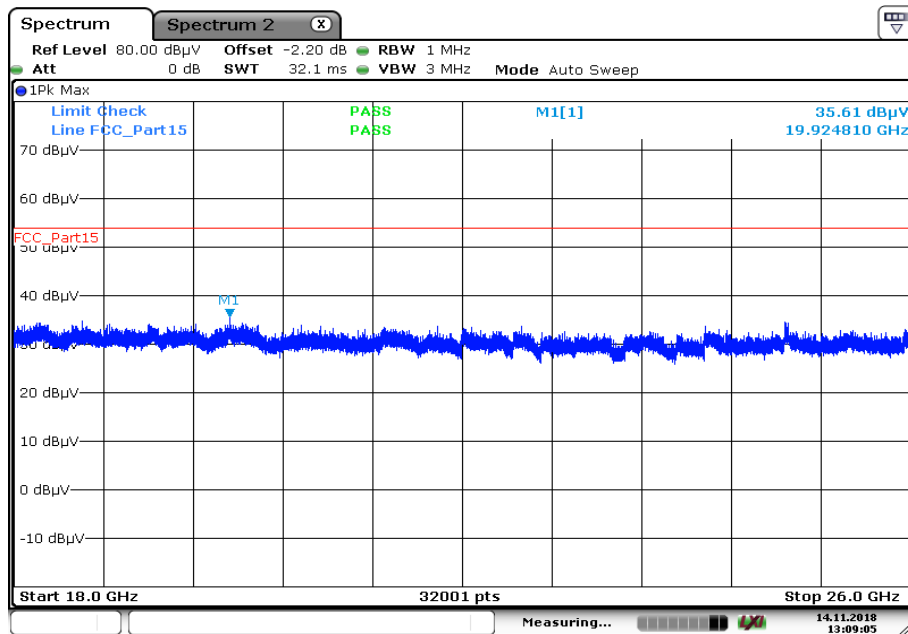

Date: 14.NOV.2018 13:09:05

Plots: RX / idle mode

Plot 1: 1 GHz to 18 GHz, vertical & horizontal polarization

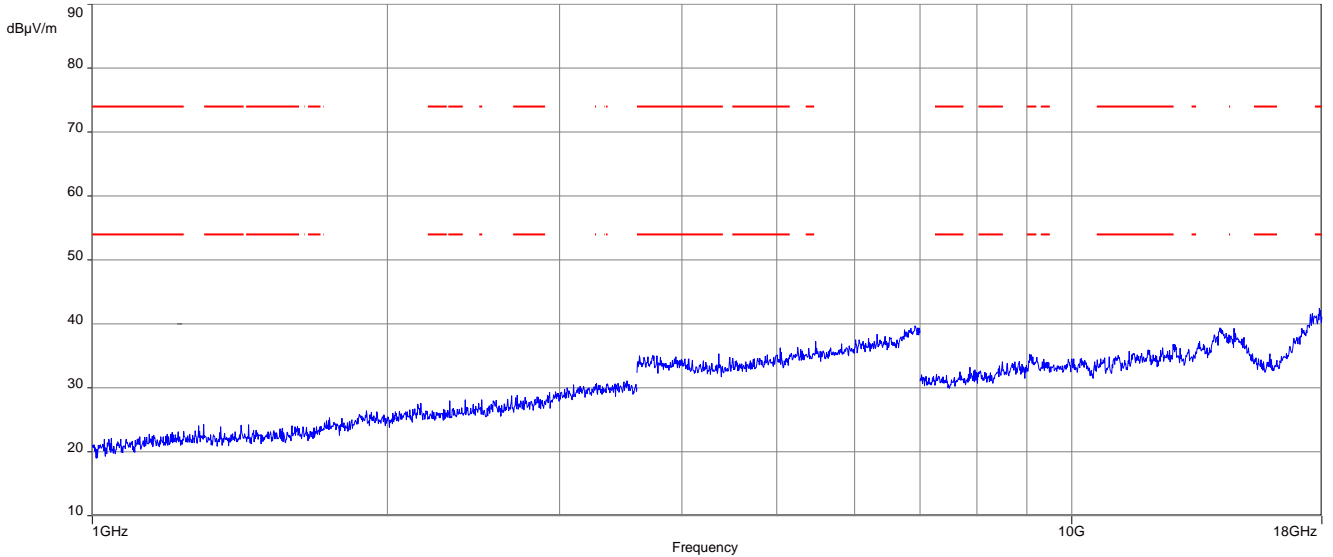

Plot 2: 18 GHz to 26 GHz, vertical & horizontal polarization

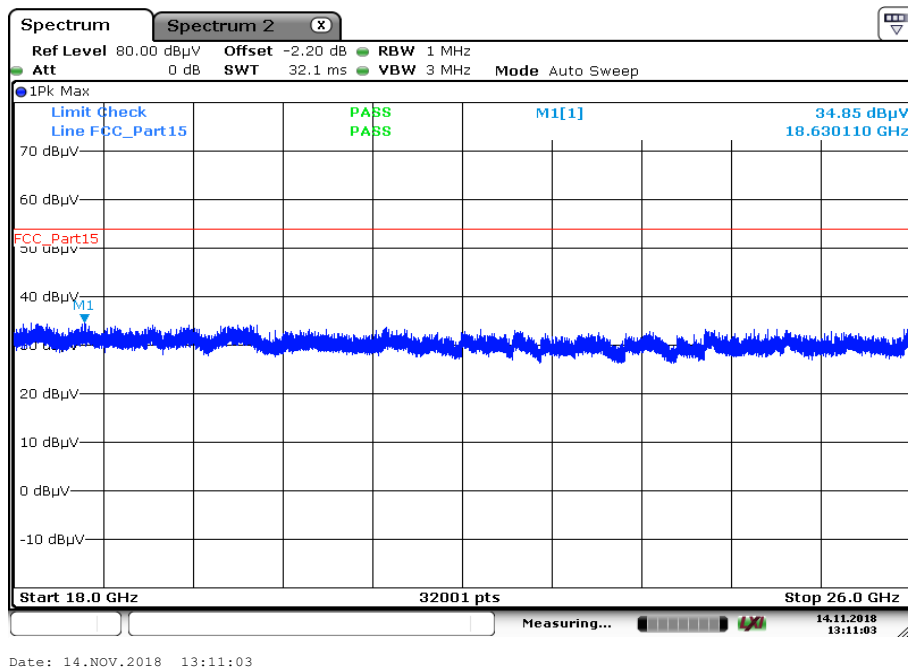

13 Observations

No observations except those reported with the single test cases have been made.

Annex A Glossary

EUT	Equipment under test
DUT	Device under test
UUT	Unit under test
GUE	GNSS User Equipment
ETSI	European Telecommunications Standards Institute
EN	European Standard
FCC	Federal Communications Commission
FCC ID	Company Identifier at FCC
IC	Industry Canada
PMN	Product marketing name
HMN	Host marketing name
HVIN	Hardware version identification number
FVIN	Firmware version identification number
EMC	Electromagnetic Compatibility
HW	Hardware
SW	Software
Inv. No.	Inventory number
S/N or SN	Serial number
C	Compliant
NC	Not compliant
NA	Not applicable
NP	Not performed
PP	Positive peak
QP	Quasi peak
AVG	Average
OC	Operating channel
OCW	Operating channel bandwidth
OBW	Occupied bandwidth
OOB	Out of band
DFS	Dynamic frequency selection
CAC	Channel availability check
OP	Occupancy period
NOP	Non occupancy period
DC	Duty cycle
PER	Packet error rate
CW	Clean wave
MC	Modulated carrier
WLAN	Wireless local area network
RLAN	Radio local area network
DSSS	Dynamic sequence spread spectrum
OFDM	Orthogonal frequency division multiplexing
FHSS	Frequency hopping spread spectrum
GNSS	Global Navigation Satellite System
C/N₀	Carrier to noise-density ratio, expressed in dB-Hz

Annex B Document history

Version	Applied changes	Date of release
-/-	Initial release	2018-12-12
A	PMN changed	2019-09-13

Annex C Accreditation Certificate

first page	last page
 <p>Deutsche Akkreditierungsstelle GmbH</p> <p>Entrusted according to Section 8 subsection 1 AkkStelleG in connection with Section 1 subsection 1 AkkStelleGBV Signatory to the Multilateral Agreements of EA, ILAC and IAF for Mutual Recognition</p> <p>Accreditation </p> <p>The Deutsche Akkreditierungsstelle GmbH attests that the testing laboratory CTC advanced GmbH Untertürkheimer Straße 6-10, 66117 Saarbrücken</p> <p>is competent under the terms of DIN EN ISO/IEC 17025:2005 to carry out tests in the following fields: Telecommunication</p> <p>The accreditation certificate shall only apply in connection with the notice of accreditation of 02.06.2017 with the accreditation number D-PL-12076-01 and is valid until 21.04.2021. It comprises the cover sheet, the reverse side of the cover sheet and the following annex with a total of 43 pages. Registration number of the certificate: D-PL-12076-01-03</p> <p>Frankfurt, 02.06.2017  Digital (f) Head of Division</p>	<p>Deutsche Akkreditierungsstelle GmbH</p> <p>Office Berlin Spittelmarkt 10 10117 Berlin</p> <p>Office Frankfurt am Main Europa-Allee 52 60327 Frankfurt am Main</p> <p>Office Braunschweig Bundesallee 100 38116 Braunschweig</p> <p>The publication of extracts of the accreditation certificate is subject to the prior written approval by Deutsche Akkreditierungsstelle GmbH (DAkKS). Exempted is the unchanged form of separate disseminations of the cover sheet by the conformity assessment body mentioned overleaf.</p> <p>No impression shall be made that the accreditation also extends to fields beyond the scope of accreditation attested by DAkKS.</p> <p>The accreditation was granted pursuant to the Act on the Accreditation Body (AkkStelleG) of 31 July 2009 (Federal Law Gazette I p. 2625) and the Regulation (EC) No 765/2008 of the European Parliament and of the Council of 9 July 2008 setting out the requirements for accreditation and market surveillance relating to the marketing of products (Official Journal of the European Union L 218 of 9 July 2008, p. 30). DAkKS is a signatory to the Multilateral Agreements for Mutual Recognition of the European co-operation for Accreditation (EA), International Accreditation Forum (IAF) and International Laboratory Accreditation Cooperation (ILAC). The signatories to these agreements recognise each other's accreditations.</p> <p>The up-to-date state of membership can be retrieved from the following websites: EA: www.european-accreditation.org ILAC: www.ilac.org IAF: www.iaf.nu</p>

Note: The current certificate annex is published on the website (link see below) of the Accreditation Body DAkKS or may be received by CTC advanced GmbH on request

<https://www.dakks.de/as/ast/d/D-PL-12076-01-03e.pdf>

END OF TEST REPORT