



TEST REPORT

Test report no.: 1-5116_22-01-03

BNetzA-CAB-02/21-102

Testing laboratory

CTC advanced GmbH
Untertuerkheimer Strasse 6 – 10
66117 Saarbruecken / Germany
Phone: + 49 681 5 98 - 0
Fax: + 49 681 5 98 - 9075
Internet: <https://www.ctcadvanced.com>
e-mail: mail@ctcadvanced.com

Accredited Testing Laboratory:

The testing laboratory (area of testing) is accredited according to DIN EN ISO/IEC 17025 (2018-03) by the Deutsche Akkreditierungsstelle GmbH (DAkkS)
The accreditation is valid for the scope of testing procedures as stated in the accreditation certificate starting with the registration number: D-PL-12076-01.

Applicant

BURY Sp. z o.o.
ul. Wojska Polskiego 4
PL-39-300 Mielec / POLAND
Phone: +48 017 788 46 00
Contact: Wojciech Pazdro
e-mail: Wojciech.Pazdro@bury.com

Manufacturer

BURY Sp. z o.o.
ul. Wojska Polskiego 4
PL-39-300 Mielec / POLAND

Test standard/s

FCC - Title 47 CFR Part 15 FCC - Title 47 of the Code of Federal Regulations; Chapter I; Part 15 - Radio frequency devices
RSS - 247 Issue 2 Digital Transmission Systems (DTSS), Frequency Hopping Systems (FHSs) and Licence - Exempt Local Area Network (LE-LAN) Devices
For further applied test standards please refer to section 3 of this test report.

Test Item

Kind of test item: **Base Station**
Model name: **Car Gate (CG3)**
FCC ID: **QZ9-CG3**
ISED certification number: **5927A-CG3**
Frequency: 2400 MHz to 2483.5 MHz
Technology tested: Bluetooth® + EDR
Antenna: Inverted F antenna
Power supply: 12.0 V DC by vehicle battery
Temperature range: -40°C to +85°C

This test report is electronically signed and valid without handwritten signature. For verification of the electronic signatures, the public keys can be requested at the testing laboratory.

Test report authorized:

Marco Bertolino
Lab Manager
Radio Communications

Test performed:

Michael Dorongovski
Lab Manager
Radio Communications

1 Table of contents

1	Table of contents	2
2	General information	4
2.1	Notes and disclaimer	4
2.2	Application details	4
2.3	Test laboratories sub-contracted	4
3	Test standard/s, references and accreditations	5
4	Reporting statements of conformity – decision rule	6
5	Test environment	7
6	Test item.....	7
6.1	General description	7
6.2	Additional information	7
7	Sequence of testing	8
7.1	Sequence of testing radiated spurious 9 kHz to 30 MHz	8
7.2	Sequence of testing radiated spurious 30 MHz to 1 GHz	9
7.3	Sequence of testing radiated spurious 1 GHz to 18 GHz	10
7.4	Sequence of testing radiated spurious above 18 GHz	11
8	Description of the test setup.....	12
8.1	Shielded semi anechoic chamber	13
8.2	Shielded fully anechoic chamber.....	14
8.3	Radiated measurements > 18 GHz.....	15
8.4	Conducted measurements Bluetooth system	16
9	Measurement uncertainty	17
10	Summary of measurement results	18
11	Additional comments.....	19
12	Measurement results	20
12.1	Antenna gain.....	20
12.2	Carrier frequency separation	21
12.3	Number of hopping channels	22
12.4	Time of occupancy (dwell time)	23
12.5	Spectrum bandwidth of a FHSS system	24
12.6	Maximum output power.....	25
12.7	Band edge compliance radiated	26
12.8	Spurious emissions conducted	31
12.9	Spurious emissions radiated below 30 MHz.....	34
12.10	Spurious emissions radiated 30 MHz to 1 GHz	37
12.11	Spurious emissions radiated above 1 GHz	41
13	Glossary	45
14	Document history.....	46
15	Accreditation Certificate – D-PL-12076-01-04.....	46

16 **Accreditation Certificate – D-PL-12076-01-05.....47**

2 General information

2.1 Notes and disclaimer

The test results of this test report relate exclusively to the test item specified in this test report. CTC advanced GmbH does not assume responsibility for any conclusions and generalizations drawn from the test results with regard to other specimens or samples of the type of the equipment represented by the test item.

The test report may only be reproduced or published in full. Reproduction or publication of extracts from the report requires the prior written approval of CTC advanced GmbH.

The testing service provided by CTC advanced GmbH has been rendered under the current "General Terms and Conditions for CTC advanced GmbH".

CTC advanced GmbH will not be liable for any loss or damage resulting from false, inaccurate, inappropriate or incomplete product information provided by the customer.

Under no circumstances does the CTC advanced GmbH test report include any endorsement or warranty regarding the functionality, quality or performance of any other product or service provided.

Under no circumstances does the CTC advanced GmbH test report include or imply any product or service warranties from CTC advanced GmbH, including, without limitation, any implied warranties of merchantability, fitness for purpose, or non-infringement, all of which are expressly disclaimed by CTC advanced GmbH.

All rights and remedies regarding vendor's products and services for which CTC advanced GmbH has prepared this test report shall be provided by the party offering such products or services and not by CTC advanced GmbH. In no case this test report can be considered as a Letter of Approval.

This test report is electronically signed and valid without handwritten signature. For verification of the electronic signatures, the public keys can be requested at the testing laboratory.

2.2 Application details

Date of receipt of order:	2022-09-29
Date of receipt of test item:	2022-11-10
Start of test:*	2022-11-14
End of test:*	2022-11-22
Person(s) present during the test:	-/-

*Date of each measurement, if not shown in the plot, can be requested. Dates are stored in the measurement software.

2.3 Test laboratories sub-contracted

None

3 Test standard/s, references and accreditations

Test standard	Date	Description
FCC - Title 47 CFR Part 15	-/-	FCC - Title 47 of the Code of Federal Regulations; Chapter I; Part 15 - Radio frequency devices
RSS - 247 Issue 2	February 2017	Digital Transmission Systems (DTSs), Frequency Hopping Systems (FHSs) and Licence - Exempt Local Area Network (LE-LAN) Devices
RSS - Gen Issue 5 incl. Amendment 1 & 2	February 2021	Spectrum Management and Telecommunications Radio Standards Specification - General Requirements for Compliance of Radio Apparatus

Guidance	Version	Description
KDB 558074 D01	v05r02	GUIDANCE FOR COMPLIANCE MEASUREMENTS ON DIGITAL TRANSMISSION SYSTEM, FREQUENCY HOPPING SPREAD SPECTRUM SYSTEM, AND HYBRID SYSTEM DEVICES OPERATING UNDER SECTION 15.247 OF THE FCC RULES
ANSI C63.4-2014	-/-	American National Standard for Methods of Measurement of Radio-Noise Emissions from Low-Voltage Electrical and Electronic Equipment in the Range of 9 kHz to 40 GHz
ANSI C63.10-2013	-/-	American National Standard of Procedures for Compliance Testing of Unlicensed Wireless Devices

Accreditation	Description	
D-PL-12076-01-04	Telecommunication and EMC Canada https://www.dakks.de/as/ast/d/D-PL-12076-01-04e.pdf	  Deutsche Akkreditierungsstelle D-PL-12076-01-04
D-PL-12076-01-05	Telecommunication FCC requirements https://www.dakks.de/as/ast/d/D-PL-12076-01-05e.pdf	  Deutsche Akkreditierungsstelle D-PL-12076-01-05

ISED Testing Laboratory Recognized Listing Number: DE0001
FCC designation number: DE0002

4 Reporting statements of conformity – decision rule

Only the measured values related to their corresponding limits will be used to decide whether the equipment under test meets the requirements of the test standards listed in chapter 3.

The measurement uncertainty is mentioned in this test report, see chapter 8, but is not taken into account - neither to the limits nor to the measurement results. Measurement results with a smaller margin to the corresponding limits than the measurement uncertainty have a potential risk of more than 5% that the decision might be wrong."

measured value, measurement uncertainty, verdict

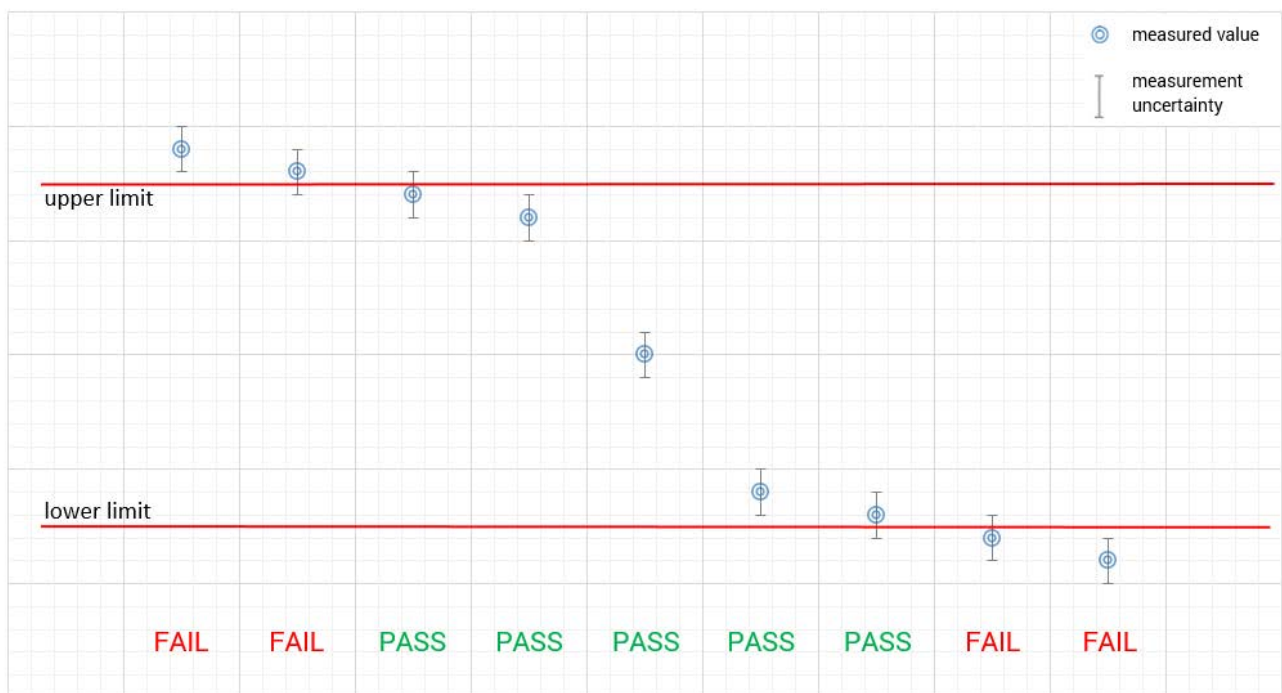

5 Test environment

Temperature	:	T_{nom} T_{max} T_{min}	+22 °C during room temperature tests No tests under extreme environmental conditions required. No tests under extreme environmental conditions required.
Relative humidity content	:		42 %
Barometric pressure	:		1021 hpa
Power supply	:	V_{nom} V_{max} V_{min}	12.0 V DC by external power supply No tests under extreme environmental conditions required. No tests under extreme environmental conditions required.

6 Test item

6.1 General description

Kind of test item	:	Base Station
Model name	:	Car Gate (CG3)
HMN	:	-/-
PMN	:	Car Gate (CG3)
HVIN	:	Car Gate (CG3)
FVIN	:	-/-
S/N serial number	:	Rad. SN.: 32 20 00 00 00 00 02 16 85 05 Cond. SN.: 32 20 00 00 00 00 02 16 85 00
Hardware status	:	H04
Software status	:	X600
Firmware status	:	NA
Frequency band	:	2400 MHz to 2483.5 MHz
Type of radio transmission	:	FHSS
Use of frequency spectrum	:	
Type of modulation	:	GFSK, Pi/4-DQPSK, 8DPSK
Number of channels	:	79
Antenna	:	Inverted F antenna
Power supply	:	12.0 V DC by vehicle battery
Temperature range	:	-40°C to +85°C

6.2 Additional information

The content of the following annexes is defined in the QA. It may be that not all of the listed annexes are necessary for this report, thus some values in between may be missing.

Test setup and EUT photos are included in test report:

- 1-5116_22-01-01_AnnexA
- 1-5116_22-01-01_AnnexB
- 1-5116_22-01-01_AnnexD

7 Sequence of testing

7.1 Sequence of testing radiated spurious 9 kHz to 30 MHz

Setup

- The equipment is set up to simulate normal operation mode as described in the user manual or defined by the manufacturer.
- If the EUT is a tabletop system, it is placed on a table with 0.8 m height.
- If the EUT is a floor standing device, it is placed directly on the turn table.
- Auxiliary equipment and cables are positioned to simulate normal operation conditions as described in ANSI C 63.4.
- The AC power port of the EUT (if available) is connected to a power outlet below the turntable.
- Measurement distance is 3 m (see ANSI C 63.4) – see test details.
- EUT is set into operation.

Premeasurement*

- The turntable rotates from 0° to 315° using 45° steps.
- The antenna height is 1 m.
- At each turntable position the analyzer sweeps with positive-peak detector to find the maximum of all emissions.

Final measurement

- Identified emissions during the pre-measurement are maximized by the software by rotating the turntable from 0° to 360°.
- Loop antenna is rotated about its vertical axis for maximum response at each azimuth about the EUT. (For certain applications, the loop antenna plane may also need to be positioned horizontally at the specified distance from the EUT)
- The final measurement is done in the position (turntable and elevation) causing the highest emissions with quasi-peak (as described in ANSI C 63.4).
- Final levels, frequency, measuring time, bandwidth, turntable position, correction factor, margin to the limit and limit will be recorded. A plot with the graph of the premeasurement and the limit is stored.

*Note: The sequence will be repeated three times with different EUT orientations.

7.2 Sequence of testing radiated spurious 30 MHz to 1 GHz

Setup

- The equipment is set up to simulate normal operation mode as described in the user manual or defined by the manufacturer.
- If the EUT is a tabletop system, a table with 0.8 m height is used, which is placed on the ground plane.
- If the EUT is a floor standing device, it is placed on the ground plane with insulation between both.
- Auxiliary equipment and cables are positioned to simulate normal operation conditions as described in ANSI C 63.4.
- The AC power port of the EUT (if available) is connected to a power outlet below the turntable.
- Measurement distance is 10 m or 3 m (see ANSI C 63.4) – see test details.
- EUT is set into operation.

Premeasurement

- The turntable rotates from 0° to 315° using 45° steps.
- The antenna is polarized vertical and horizontal.
- The antenna height changes from 1 m to 3 m.
- At each turntable position, antenna polarization and height the analyzer sweeps three times in peak to find the maximum of all emissions.

Final measurement

- The final measurement is performed for at least six highest peaks according to the requirements of the ANSI C63.4.
- Based on antenna and turntable positions at which the peak values are measured the software maximize the peaks by changing turntable position $\pm 45^\circ$ and antenna height between 1 and 4 m.
- The final measurement is done with quasi-peak detector (as described in ANSI C 63.4).
- Final levels, frequency, measuring time, bandwidth, antenna height, antenna polarization, turntable angle, correction factor, margin to the limit and limit are recorded. A plot with the graph of the premeasurement with marked maximum final results and the limit is stored.

7.3 Sequence of testing radiated spurious 1 GHz to 18 GHz

Setup

- The equipment is set up to simulate normal operation mode as described in the user manual or defined by the manufacturer.
- If the EUT is a tabletop system, a 2-axis positioner with 1.5 m height is used.
- If the EUT is a floor standing device, it is placed directly on the turn table.
- Auxiliary equipment and cables are positioned to simulate normal operation conditions as described in ANSI C 63.4.
- The AC power port of the EUT (if available) is connected to a power outlet below the turntable.
- Measurement distance is 3 m (see ANSI C 63.4) – see test details.
- EUT is set into operation.

Premeasurement

- The turntable rotates from 0° to 315° using 45° steps.
- The antenna is polarized vertical and horizontal.
- The antenna height is 1.5 m.
- At each turntable position and antenna polarization the analyzer sweeps with positive peak detector to find the maximum of all emissions.

Final measurement

- The final measurement is performed for at least six highest peaks according to the requirements of the ANSI C63.4.
- Based on antenna and turntable positions at which the peak values are measured the software maximizes the peaks by rotating the turntable from 0° to 360°. This measurement is repeated for different EUT-table positions (0° to 150° in 30°-steps) and for both antenna polarizations.
- The final measurement is done in the position (turntable, EUT-table and antenna polarization) causing the highest emissions with Peak and RMS detector (as described in ANSI C 63.4).
- Final levels, frequency, measuring time, bandwidth, turntable position, EUT-table position, antenna polarization, correction factor, margin to the limit and limit are recorded. A plot with the graph of the premeasurement with marked maximum final results and the limit is stored.

7.4 Sequence of testing radiated spurious above 18 GHz

Setup

- The equipment is set up to simulate normal operation mode as described in the user manual or defined by the manufacturer.
- Auxiliary equipment and cables are positioned to simulate normal operation conditions as described in ANSI C 63.4.
- The AC power port of the EUT (if available) is connected to a power outlet.
- The measurement distance is as appropriate (e.g. 0.5 m).
- The EUT is set into operation.

Premeasurement

- The test antenna is handheld and moved carefully over the EUT to cover the EUT's whole sphere and different polarizations of the antenna.

Final measurement

- The final measurement is performed at the position and antenna orientation causing the highest emissions with Peak and RMS detector (as described in ANSI C 63.4).
- Final levels, frequency, measuring time, bandwidth, correction factor, margin to the limit and limit are recorded. A plot with the graph of the premeasurement and the limit is stored.

8 Description of the test setup

Typically, the calibrations of the test apparatus are commissioned to and performed by an accredited calibration laboratory. The calibration intervals are determined in accordance with the DIN EN ISO/IEC 17025. In addition to the external calibrations, the laboratory executes comparison measurements with other calibrated test systems or effective verifications. Weekly chamber inspections and range calibrations are performed. Where possible, RF generating and signaling equipment as well as measuring receivers and analyzers are connected to an external high-precision 10 MHz reference (GPS-based or rubidium frequency standard).

In order to simplify the identification of the equipment used at some special tests, some items of test equipment and ancillaries can be provided with an identifier or number in the equipment list below (Lab/Item).

Each block diagram listed can contain several test setup configurations. All devices belonging to a test setup are identified with the same letter syntax. For example: Column Setup and all devices with an A.

Agenda: Kind of Calibration

k	calibration / calibrated	EK	limited calibration
ne	not required (k, ev, izw, zw not required)	zw	cyclical maintenance (external cyclical maintenance)
ev	periodic self verification	izw	internal cyclical maintenance
Ve	long-term stability recognized	g	blocked for accredited testing
vlk!	Attention: extended calibration interval		
NK!	Attention: not calibrated	*)	next calibration ordered / currently in progress

8.1 Shielded semi anechoic chamber

The radiated measurements are performed in vertical and horizontal plane in the frequency range from 30 MHz to 1 GHz in semi-anechoic chambers. The EUT is positioned on a non-conductive support with a height of 0.80 m above a conductive ground plane that covers the whole chamber. The receiving antennas are conform to specifications ANSI C63. These antennas can be moved over the height range between 1.0 m and 4.0 m in order to search for maximum field strength emitted from EUT. The measurement distances between EUT and receiving antennas are indicated in the test setups for the various frequency ranges. For each measurement, the EUT is rotated in all three axes until the maximum field strength is received. The wanted and unwanted emissions are received by spectrum analyzers where the detector modes and resolution bandwidths over various frequency ranges are set according to requirement ANSI C63.

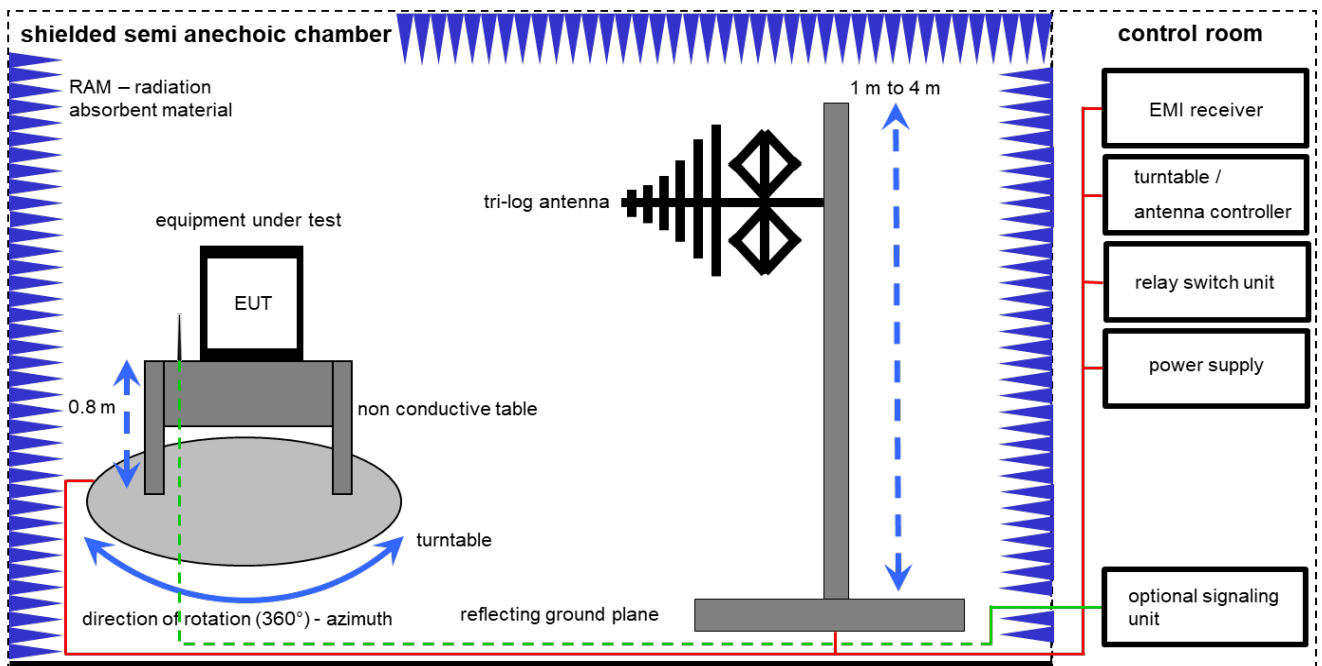

Measurement distance: tri-log antenna 10 meter; EMC32 software version: 10.59.00

$$FS = UR + CL + AF$$

(FS-field strength; UR-voltage at the receiver; CL-loss of the cable; AF-antenna factor)

Example calculation:

$$FS [dB\mu V/m] = 12.35 [dB\mu V/m] + 1.90 [dB] + 16.80 [dB/m] = 31.05 [dB\mu V/m] (35.69 \mu V/m)$$

Equipment table:

No.	Setup	Equipment	Type	Manufacturer	Serial No.	INV. No.	Kind of Calibration	Last Calibration	Next Calibration
1	A	Switch-Unit	3488A	HP	2719A14505	300000368	ev	-/-	-/-
2	A	Semi anechoic chamber	3000023	MWB AG	-/-	300000551	ne	-/-	-/-
3	A	Antenna Tower	Model 2175	ETS-Lindgren	64762	300003745	izw	-/-	-/-
4	A	Positioning Controller	Model 2090	ETS-Lindgren	64672	300003746	izw	-/-	-/-
5	A	Turntable Interface-Box	Model 105637	ETS-Lindgren	44583	300003747	izw	-/-	-/-
6	A	TRILOG Broadband Test-Antenna 30 MHz - 3 GHz	VULB9163	Schwarzbeck Mess - Elektronik	318	300003696	vKI!	30.09.2021	29.09.2023
7	A	Turntable	2089-4.0	EMCO	-/-	300004394	ne	-/-	-/-
8	A	PC	TecLine	F+W	-/-	300004388	ne	-/-	-/-
9	A	EMI Test Receiver	ESR3	Rohde & Schwarz	102587	300005771	k	20.05.2022	19.05.2023

8.2 Shielded fully anechoic chamber

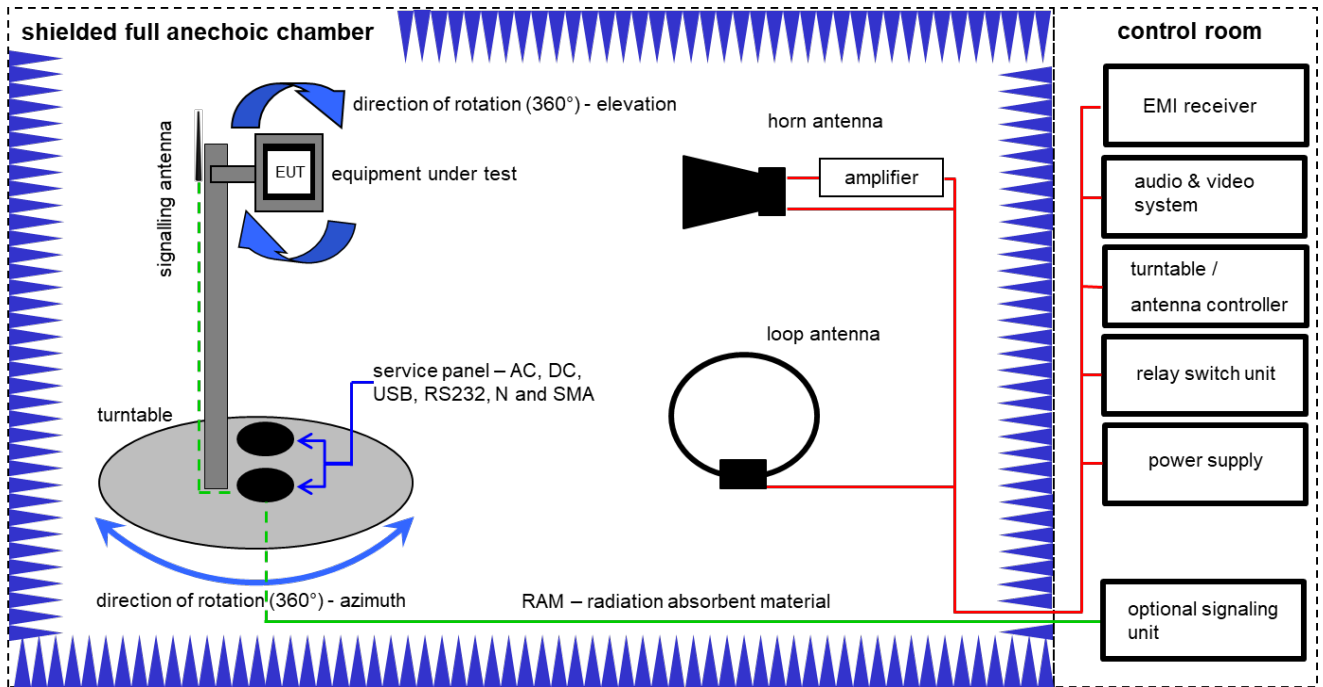

Measurement distance: horn antenna 3 meter; loop antenna 3 meter

$$FS = UR + CA + AF$$

(FS-field strength; UR-voltage at the receiver; CA-loss of the signal path; AF-antenna factor)

Example calculation:

$$FS \text{ [dB}\mu\text{V/m]} = 40.0 \text{ [dB}\mu\text{V/m]} + (-35.8) \text{ [dB]} + 32.9 \text{ [dB/m]} = 37.1 \text{ [dB}\mu\text{V/m]} \text{ (71.61 } \mu\text{V/m)}$$

Equipment table:

No.	Setup	Equipment	Type	Manufacturer	Serial No.	INV. No.	Kind of Calibration	Last Calibration	Next Calibration
1	A	Active Loop Antenna 9 kHz to 30 MHz	6502	EMCO	2210	300001015	vKI!	01.07.2021	31.07.2023
2	C	Highpass Filter	WHK1.1/15G-10SS	Wainwright	37	400000148	ne	-/-	-/-
3	C	Highpass Filter	WHKX7.0/18G-8SS	Wainwright	18	300003789	ne	-/-	-/-
4	C	Band Reject Filter	WRCG2400/2483-2375/2505-50/10SS	Wainwright	26	300003792	ne	-/-	-/-
5	B, C	Broadband Amplifier 0.5-18 GHz	CBLU5184540	CERNEX	22051	300004483	ev	-/-	-/-
6	A, B, C	4U RF Switch Platform	L4491A	Agilent Technologies	MY50000032	300004510	ne	-/-	-/-
7	A, B, C	Computer	Intel Core i3 3220/3,3 GHz, Prozessor	-/-	2V2403033A54 21	300004591	ne	-/-	-/-
8	A, B, C	NEXIO EMV-Software	BAT EMC V3.21.0.32	EMCO	-/-	300004682	ne	-/-	-/-
9	A, B, C	Anechoic chamber	-/-	TDK	-/-	300003726	ne	-/-	-/-
10	A, B, C	EMI Test Receiver 9kHz-26,5GHz	ESR26	Rohde & Schwarz	101376	300005063	k	15.12.2021	31.12.2022
11	C	RF-Amplifier	AMF-6F06001800-30-10P-R	NARDA-MITEQ Inc	2011571	300005240	ev	-/-	-/-

8.3 Radiated measurements > 18 GHz

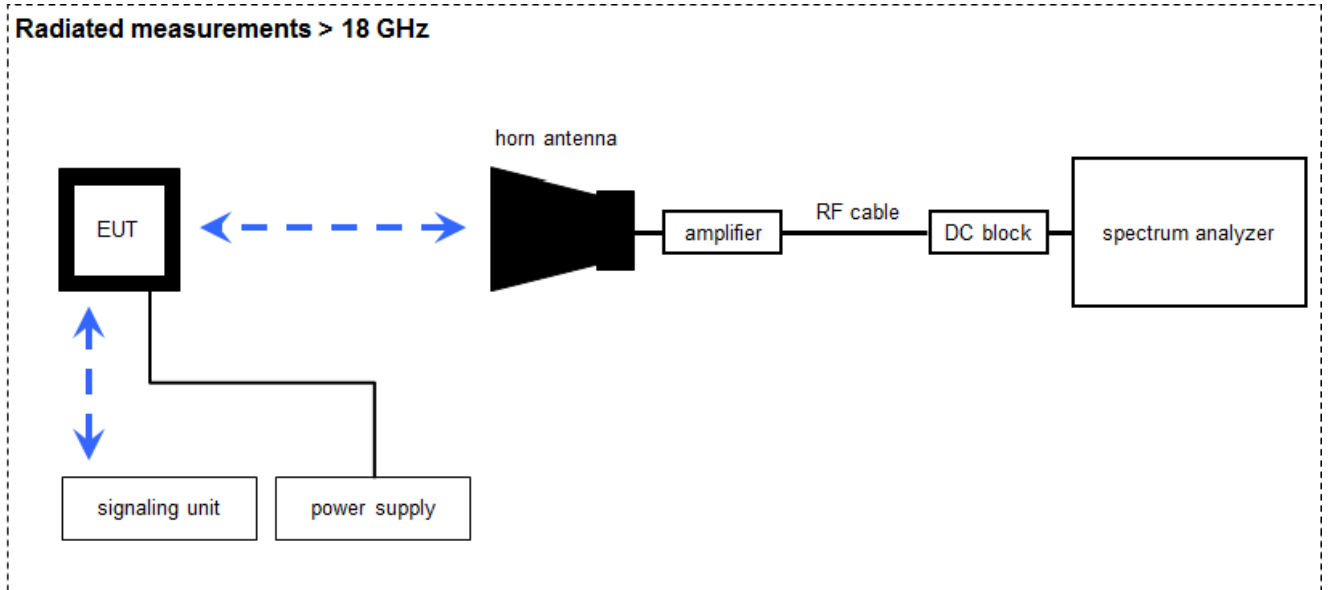

Measurement distance: horn antenna 50 cm

$$FS = UR + CA + AF$$

(FS-field strength; UR-voltage at the receiver; CA-loss signal path & distance correction; AF-antenna factor)

Example calculation:

$$FS [dB\mu V/m] = 40.0 [dB\mu V/m] + (-60.1) [dB] + 36.74 [dB/m] = 16.64 [dB\mu V/m] (6.79 \mu V/m)$$

Equipment table:

No.	Setup	Equipment	Type	Manufacturer	Serial No.	INV. No.	Kind of Calibration	Last Calibration	Next Calibration
1	A	Microwave System Amplifier, 0.5-26.5 GHz	83017A	HP	00419	300002268	ev	-/-	-/-
2	A	Std. Gain Horn Antenna 18.0-26.5 GHz	638	Narda	8205	300002442	k	17.01.2022	31.01.2024
3	A	Amplifier 2-40 GHz	JS32-02004000-57-5P	MITEQ	1777200	300004541	ev	-/-	-/-
4	A	RF-Cable	ST18/SMAm/SMAm/48	Huber & Suhner	Batch no. 127377	400001183	ev	-/-	-/-
5	A	DC-Blocker 0.1-40 GHz	8141A	Inmet	-/-	400001185	ev	-/-	-/-

8.4 Conducted measurements Bluetooth system

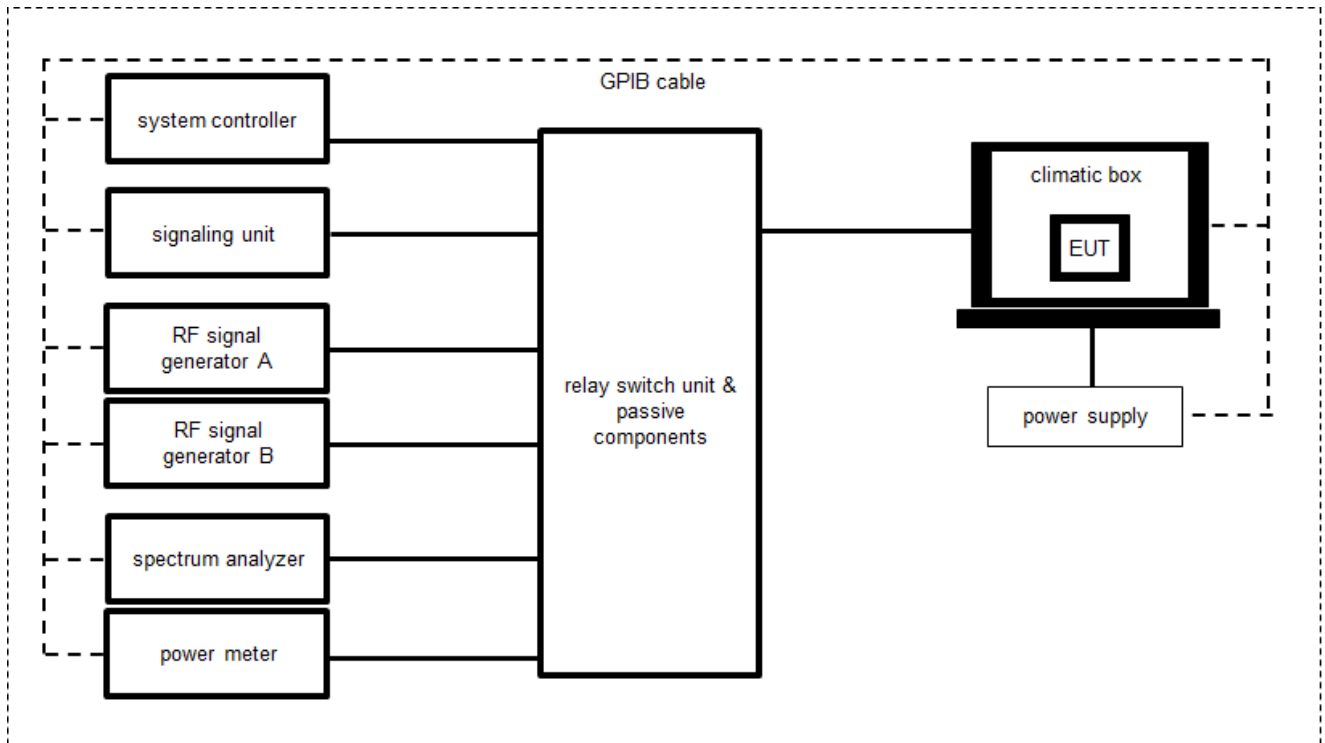

OP = AV + CA
(OP-output power; AV-analyzer value; CA-loss signal path)

Example calculation:

OP [dBm] = 6.0 [dBm] + 11.7 [dB] = 17.7 [dBm] (58.88 mW)

Equipment table:

No.	Setup	Equipment	Type	Manufacturer	Serial No.	INV. No.	Kind of Calibration	Last Calibration	Next Calibration
1	A	USB/GPIB interface	82357B	Agilent Technologies	MY52103346	300004390	ne	-/-	-/-
2	A	PC Laboratory	Exone	Fröhlich + Walter	S2642279-03 / 10	300004179	ne	-/-	-/-
3	A	Signal analyzer	FSV30	Rohde&Schwarz	1321.3008K30/103809	300005359	vKI!	08.12.2020	31.12.2022
4	A	Switch matrix	RSM-1	CTC advanced GmbH	29655273	400001355	ev	26.01.2022	31.01.2023
5	A	Tester Software RadioStar (C.BER2 for BT Conformance)	Version 1.0.0.X	CTC advanced GmbH	0001	400001380	ne	-/-	-/-
6	A	Wideband Radio Communication Tester	CMW270	Rohde & Schwarz	102550	300006253	k	17.09.2021	30.09.2023

9 Measurement uncertainty

Measurement uncertainty	
Test case	Uncertainty
Antenna gain	± 3 dB
Carrier frequency separation	± 21.5 kHz
Number of hopping channels	-/-
Time of occupancy	According BT Core specification
Spectrum bandwidth	± 21.5 kHz absolute; ± 15.0 kHz relative
Maximum output power	± 1 dB
Detailed conducted spurious emissions @ the band edge	± 1 dB
Band edge compliance radiated	± 3 dB
Spurious emissions conducted	± 3 dB
Spurious emissions radiated below 30 MHz	± 3 dB
Spurious emissions radiated 30 MHz to 1 GHz	± 3 dB
Spurious emissions radiated 1 GHz to 12.75 GHz	± 3.7 dB
Spurious emissions radiated above 12.75 GHz	± 4.5 dB
Spurious emissions conducted below 30 MHz (AC conducted)	± 2.6 dB

10 Summary of measurement results

<input checked="" type="checkbox"/>	No deviations from the technical specifications were ascertained
<input type="checkbox"/>	There were deviations from the technical specifications ascertained
<input type="checkbox"/>	This test report is only a partial test report. The content and verdict of the performed test cases are listed below.

TC Identifier	Description	Verdict	Date	Remark
RF-Testing	CFR Part 15 RSS - 247, Issue 2	See table!	2022-12-07	-/-

Test specification clause	Test case	Temperature & voltage conditions	Mode	C	NC	NA	NP	Remark
§15.247(b)(4) RSS - 247 / 5.4.(f)(ii)	Antenna gain	Nominal	GFSK	<input checked="" type="checkbox"/>	<input type="checkbox"/>	<input type="checkbox"/>	<input type="checkbox"/>	-/-
§15.247(a)(1) RSS - 247 / 5.1.(b)	Carrier frequency separation	Nominal	GFSK	<input checked="" type="checkbox"/>	<input type="checkbox"/>	<input type="checkbox"/>	<input type="checkbox"/>	-/-
§15.247(a)(1) RSS - 247 / 5.1 (d)	Number of hopping channels	Nominal	GFSK	<input checked="" type="checkbox"/>	<input type="checkbox"/>	<input type="checkbox"/>	<input type="checkbox"/>	-/-
§15.247(a)(1) (iii) RSS - 247 / 5.1 (c)	Time of occupancy (dwell time)	Nominal	GFSK	<input checked="" type="checkbox"/>	<input checked="" type="checkbox"/>	<input type="checkbox"/>	<input type="checkbox"/>	-/-
			Pi/4 DQPSK	<input checked="" type="checkbox"/>				
			8 DPSK	<input checked="" type="checkbox"/>				
§15.247(a)(1) RSS - 247 / 5.1 (a)	Spectrum bandwidth of a FHSS system bandwidth	Nominal	GFSK	<input checked="" type="checkbox"/>	<input checked="" type="checkbox"/>	<input type="checkbox"/>	<input type="checkbox"/>	-/-
			Pi/4 DQPSK	<input checked="" type="checkbox"/>				
			8 DPSK	<input checked="" type="checkbox"/>				
§15.247(b)(1) RSS - 247 / 5.4 (b)	Maximum output power	Nominal	GFSK	<input checked="" type="checkbox"/>	<input checked="" type="checkbox"/>	<input type="checkbox"/>	<input type="checkbox"/>	-/-
			Pi/4 DQPSK	<input checked="" type="checkbox"/>				
			8 DPSK	<input checked="" type="checkbox"/>				
§15.205 RSS - 247 / 5.5 RSS - Gen	Band edge compliance radiated	Nominal	GFSK	<input checked="" type="checkbox"/>	<input checked="" type="checkbox"/>	<input type="checkbox"/>	<input type="checkbox"/>	-/-
			Pi/4 DQPSK	<input checked="" type="checkbox"/>				
			8 DPSK	<input checked="" type="checkbox"/>				
§15.247(d) RSS - 247 / 5.5	Spurious emissions conducted	Nominal	GFSK	<input checked="" type="checkbox"/>	<input checked="" type="checkbox"/>	<input type="checkbox"/>	<input type="checkbox"/>	-/-
			Pi/4 DQPSK	<input checked="" type="checkbox"/>				
			8 DPSK	<input checked="" type="checkbox"/>				
§15.209(a) RSS - Gen	Spurious emissions radiated below 30 MHz	Nominal	GFSK	<input checked="" type="checkbox"/>	<input type="checkbox"/>	<input type="checkbox"/>	<input type="checkbox"/>	-/-
§15.247(d) RSS - 247 / 5.5 §15.109 RSS - Gen	Spurious emissions radiated 30 MHz to 1 GHz	Nominal	GFSK	<input checked="" type="checkbox"/>	<input type="checkbox"/>	<input type="checkbox"/>	<input type="checkbox"/>	-/-
§15.247(d) RSS - 247 / 5.5 §15.109 RSS - Gen	Spurious emissions radiated above 1 GHz	Nominal	GFSK	<input checked="" type="checkbox"/>	<input type="checkbox"/>	<input type="checkbox"/>	<input type="checkbox"/>	-/-
§15.107(a) §15.207	Conducted emissions below 30 MHz (AC conducted)	Nominal	GFSK	<input type="checkbox"/>	<input type="checkbox"/>	<input checked="" type="checkbox"/>	<input type="checkbox"/>	-/-

Notes:

C	Compliant	NC	Not compliant	NA	Not applicable	NP	Not performed
----------	-----------	-----------	---------------	-----------	----------------	-----------	---------------

11 Additional comments

The Bluetooth® word mark and logos are owned by the Bluetooth SIG Inc. and any use of such marks by CTC advanced GmbH is under license.

Reference documents: None

Co-applicable documents: 1-5116_22-01-03_Annex_MR_A1.pdf

Special test descriptions: None

Configuration descriptions: TX tests: were performed with x-DH5 packets and static PRBS pattern payload.
RX/Standby tests: BT test mode enabled, scan enabled, TX Idle

EUT selection:

- Only one device available
- Devices selected by the customer
- Devices selected by the laboratory (Randomly)

Test mode:

- Bluetooth Test mode loop back enabled (EUT is controlled over CBT/CMU/CMW)
- Special software is used.
EUT is transmitting pseudo random data by itself

Antennas and transmit operating modes:

- Operating mode 1 (single antenna)
 - Equipment with 1 antenna,
 - Equipment with 2 diversity antennas operating in switched diversity mode by which at any moment in time only 1 antenna is used,
 - Smart antenna system with 2 or more transmit/receive chains, but operating in a mode where only 1 transmit/receive chain is used)

12 Measurement results

12.1 Antenna gain

Measurement:

The antenna gain of the complete system is calculated by the difference of radiated power in EIRP and the conducted power of the module.

Measurement parameters (radiated)	
Detector	Peak
Sweep time	Auto
Resolution bandwidth	3 MHz
Video bandwidth	3 MHz
Span	5 MHz
Trace mode	Max hold
Test setup	See sub clause 8.2 setup B
Measurement uncertainty	See sub clause 9

Measurement parameters (conducted)	
External result file	1-5116_22-01-03_Annex_MR_A1.pdf Common2G4 Peak Output Power conducted 3MHz_3MHz
Test setup	See sub clause 8.4 setup A
Measurement uncertainty	See sub clause 9

Limits:

FCC	ISED
6 dBi / > 6 dBi output power and power density reduction required	

Results:

T_{nom}	V_{nom}	lowest channel 2402 MHz	middle channel 2441 MHz	highest channel 2480 MHz
Conducted power [dBm] Measured with GFSK modulation		3.2	2.3	1.9
Radiated power [dBm] Measured with GFSK modulation		7.9	7.1	4.9
Gain [dBi] Calculated		4.7	4.8	3.0

12.2 Carrier frequency separation

Description:

Measurement of the carrier frequency separation of a hopping system. The carrier frequency separation is constant for all modulation-modes. We use GFSK-modulation to show compliance. EUT in hopping mode.

Measurement parameters	
External result file	1-5116_22-01-03_Annex_MR_A1.pdf FCC Part 15.247 Carrier Frequency Separation FHSS
Test setup	See sub clause 8.4 setup A
Measurement uncertainty	See sub clause 9

Limits:

FCC	ISED
Carrier frequency separation	
Minimum 25 kHz or two-thirds of the 20 dB bandwidth of the hopping system whichever is greater.	

Result:

Carrier frequency separation	~ 1 MHz
------------------------------	---------

12.3 Number of hopping channels

Description:

Measurement of the total number of used hopping channels. The number of hopping channels is constant for all modulation-modes. We use GFSK-modulation to show compliance. EUT in hopping mode.

Measurement parameters	
External result file	1-5116_22-01-03_Annex_MR_A1.pdf FCC Part 15.247 Number Of Hopping Channels FHSS
Test setup	See sub clause 8.4 setup A
Measurement uncertainty	See sub clause 9

Limits:

FCC	ISED
Number of hopping channels	
At least 15 non overlapping hopping channels	

Result:

Number of hopping channels	79
----------------------------	----

12.4 Time of occupancy (dwell time)

Measurement:

For Bluetooth® devices no measurements mandatory depending on the fixed requirements according to the Bluetooth® Core Specifications!

For Bluetooth® devices:

The channel staying time of 0.4 s within a 31.6 second period in data mode is constant for Bluetooth® devices and independent from the packet type (packet length). The calculation for a 31.6 second period is as follows:

Channel staying time = time slot length * hop rate / number of hopping channels * 31.6 s

Example for a DH1 packet (with a maximum length of one time slot)

Channel staying time = $625 \mu\text{s} * 1600 * 1/\text{s} / 79 * 31.6 \text{ s} = 0.4 \text{ s}$ (in a 31.6 s period)

For multi-slot packets the hopping is reduced according to the length of the packet.

Example for a DH3 packet (with a maximum length of three time slots)

Channel staying time = $3 * 625 \mu\text{s} * 1600/3 * 1/\text{s} / 79 * 31.6 \text{ s} = 0.4 \text{ s}$ (in a 31.6 s period)

Example for a DH5 packet (with a maximum length of five time slots)

Channel staying time = $5 * 625 \mu\text{s} * 1600/5 * 1/\text{s} / 79 * 31.6 \text{ s} = 0.4 \text{ s}$ (in a 31.6 s period)

This is according to the Bluetooth® Core Specification 5.0 (and lower) for all Bluetooth® devices and all modulations.

The following table shows the relations:

Packet Size	Pulse Width [ms] *	Max. number of transmissions per channel in 31.6 sec
DH1	0.366	640
DH3	1.622	214
DH5	2.870	128

* according Bluetooth® specification

Results:

Packet Size	Pulse Width [ms]*	Max. number of transmissions in 31.6 sec	Time of occupancy (dwell time) [Pulse width * Number of transmissions]
DH1	0.366	640	234.2 ms
DH3	1.622	214	347.1 ms
DH5	2.870	128	367.4 ms

Limits:

FCC	ISED
Time of occupancy (dwell time)	
The frequency hopping operation shall have an average time of occupancy on any frequency not exceeding 0.4 seconds within a duration in seconds equal to the number of hopping frequencies multiplied by 0.4.	

12.5 Spectrum bandwidth of a FHSS system

Description:

Measurement of the 20dB bandwidth and 99% bandwidth of the modulated signal. EUT in single channel mode.

Measurement parameters	
External result file	1-5116_22-01-03_Annex_MR_A1.pdf FCC Part 15.247 Bandwidth 99PCT
Test setup	See sub clause 8.4 setup A
Measurement uncertainty	See sub clause 9

Limits:

FCC	ISED
Spectrum bandwidth of a FHSS system	
The complete bandwidth has to be within the frequency range of the band.	

Results:

Modulation	20 dB bandwidth [kHz]		
	2402 MHz	2441 MHz	2480 MHz
Frequency	2402 MHz	2441 MHz	2480 MHz
GFSK	866	868	867
Pi/4 DQPSK	1260	1260	1268
8DPSK	1253	1253	1253

Results:

Modulation	99 % bandwidth [kHz]		
	2402 MHz	2441 MHz	2480 MHz
Frequency	2402 MHz	2441 MHz	2480 MHz
GFSK	857	858	855
Pi/4 DQPSK	1172	1174	1171
8DPSK	1181	1179	1178

12.6 Maximum output power

Description:

Measurement of the maximum output power conducted. EUT in single channel mode.

Measurement parameters	
External result file	1-5116_22-01-03_Annex_MR_A1.pdf FCC Part 15.247 Maximum Peak Conducted Output Power FHSS
Test setup	See sub clause 8.4 setup A
Measurement uncertainty	See sub clause 9

Limits:

FCC	ISED
Maximum output power	
[Conducted: 0.125 W – antenna gain max. 6 dBi] Systems using more than 75 hopping channels: Conducted: 1.0 W – antenna gain max. 6 dBi	

Results:

Modulation	Maximum output power conducted [dBm]		
	2402 MHz	2441 MHz	2480 MHz
Frequency			
GFSK	3.2	2.4	1.9
Pi/4/DQPSK	4.5	3.6	3.2
8DPSK	5.0	4.2	3.7

12.7 Band edge compliance radiated

Description:

Measurement of the radiated band edge compliance. The EUT is turned in the position that results in the maximum level at the band edge. Then a sweep over the corresponding restricted band is performed. The EUT is set to single channel mode and the transmit channel is channel 00 for the lower restricted band and channel 78 for the upper restricted band. The measurement is repeated for all modulations. Measurement distance is 3m.

Measurement parameters	
Detector	Peak / RMS
Sweep time	Auto
Resolution bandwidth	1 MHz
Video bandwidth	3 MHz
Span	Lower Band: 2370 – 2400 MHz Upper Band: 2480 – 2500 MHz
Trace mode	Max hold
Test setup	See sub clause 8.2 setup B
Measurement uncertainty	See sub clause 9

Limits:

FCC	ISED
Band edge compliance radiated	
<p>In any 100 kHz bandwidth outside the frequency band in which the spread spectrum or digitally modulated intentional radiator is operating, the radio frequency power that is produced by the intentional radiator shall be at least 20 dB below that in the 100 kHz bandwidth within the band that contains the highest level of the desired power, based on either an RF conducted or a radiated measurement. Attenuation below the general limits specified in Section 15.209(a) is not required. In addition, radiated emissions which fall in the restricted bands, as defined in Section 15.205(a), must also comply with the radiated emission limits specified in Section 15.209(a) (see Section 5.205(c)).</p>	
54 dB μ V/m AVG 74 dB μ V/m Peak	

Results:

Scenario	Band edge compliance radiated [dBµV/m]			
	Modulation	GFSK	Pi/4 DQPSK	8DPSK
Lower restricted band		10.0* dBµV/m AVG 40.1 dBµV/m Peak	10.4* dBµV/m AVG 40.5 dBµV/m Peak	10.5* dBµV/m AVG 40.6 dBµV/m Peak
Upper restricted band		26.3* dBµV/m AVG 56.4 dBµV/m Peak	28.5* dBµV/m AVG 58.6 dBµV/m Peak	28.9* dBµV/m AVG 59.0 dBµV/m Peak

*) Average emission adjusting factor:

$$F = 20 * \log (\text{dwell time} / 100 \text{ ms})$$

The dwell time of the longest possible Bluetooth transmission (DH5-packet) is 3.125 ms.

In a period of 100 ms, we have a maximum of 1 transmission and that implies a correction factor for spurious measurement emissions:

$$F = 20 * \log (1 * 3.125 / 100) = -30.1 \text{ dB}$$

Plots:

Plot 1: Lower band edge, GFSK modulation, vertical & horizontal polarization

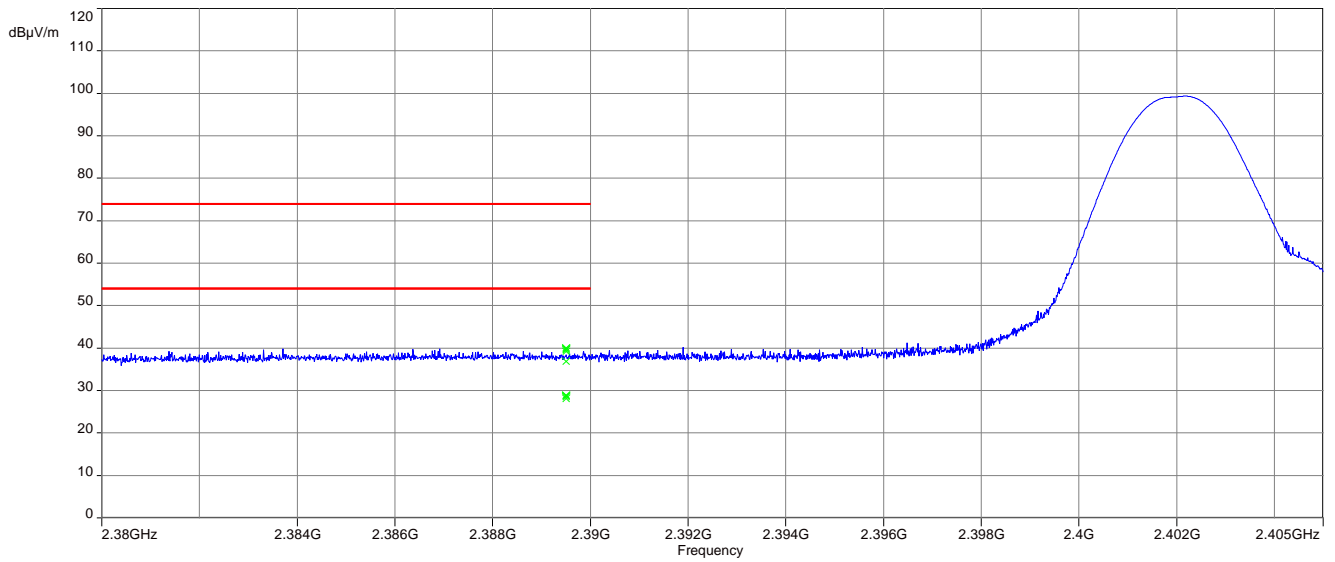

Plot 2: Upper band edge, GFSK modulation, vertical & horizontal polarization

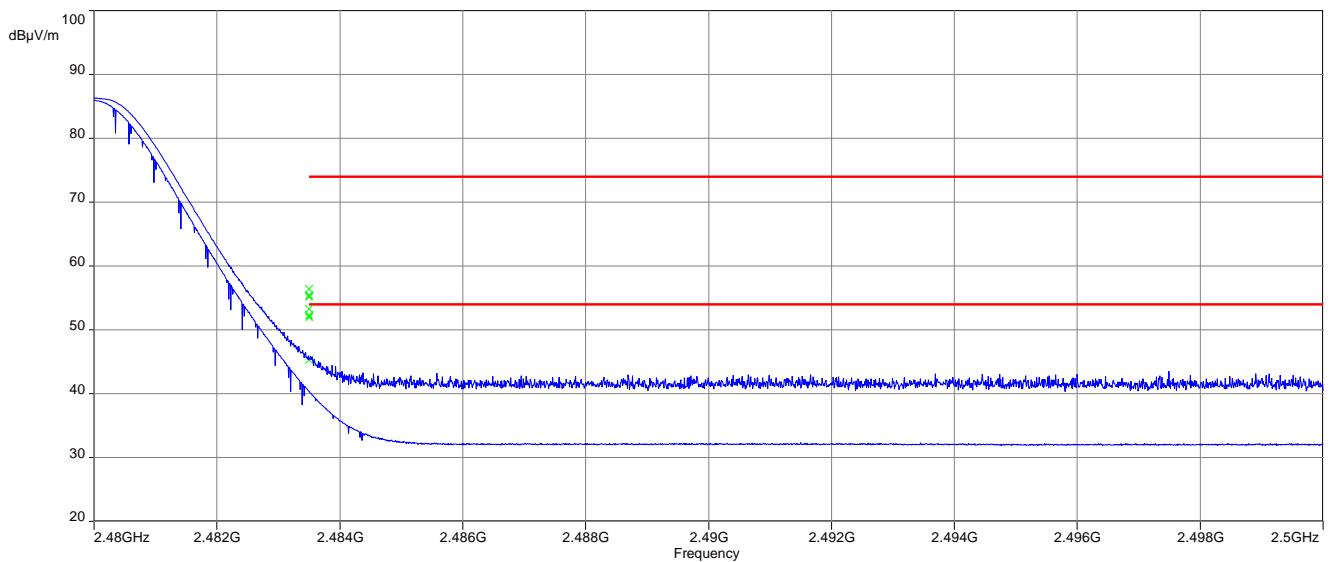

Plot 3: Lower band edge, Pi/4 DQPSK modulation, vertical & horizontal polarization

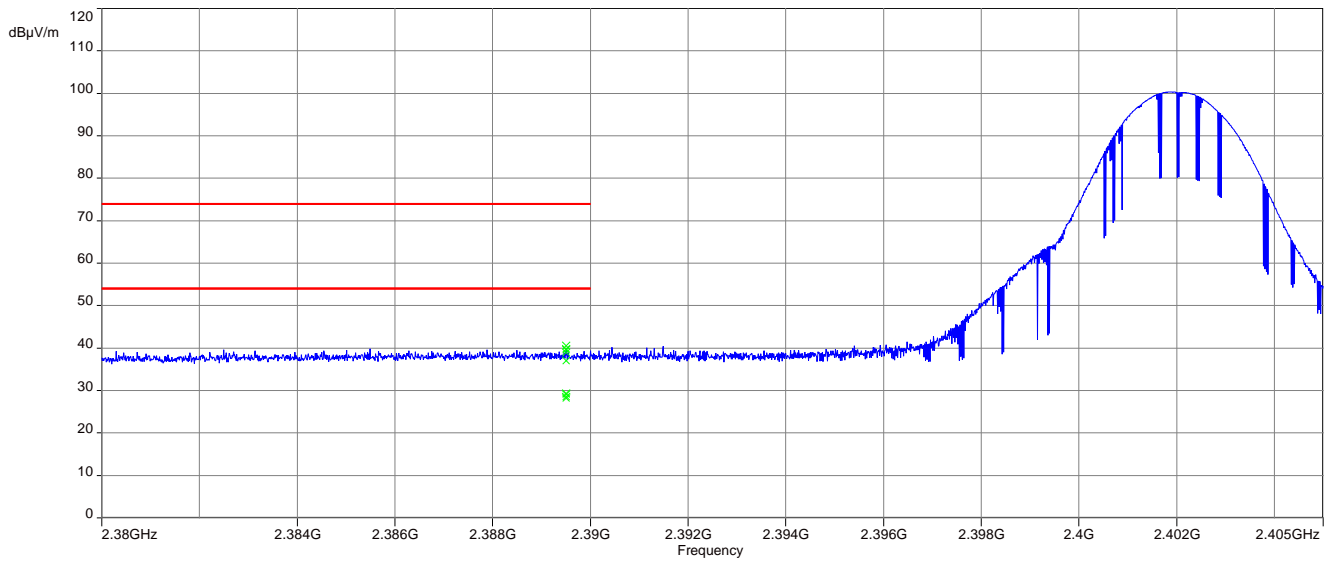

Plot 4: Upper band edge, Pi/4 DQPSK modulation, vertical & horizontal polarization

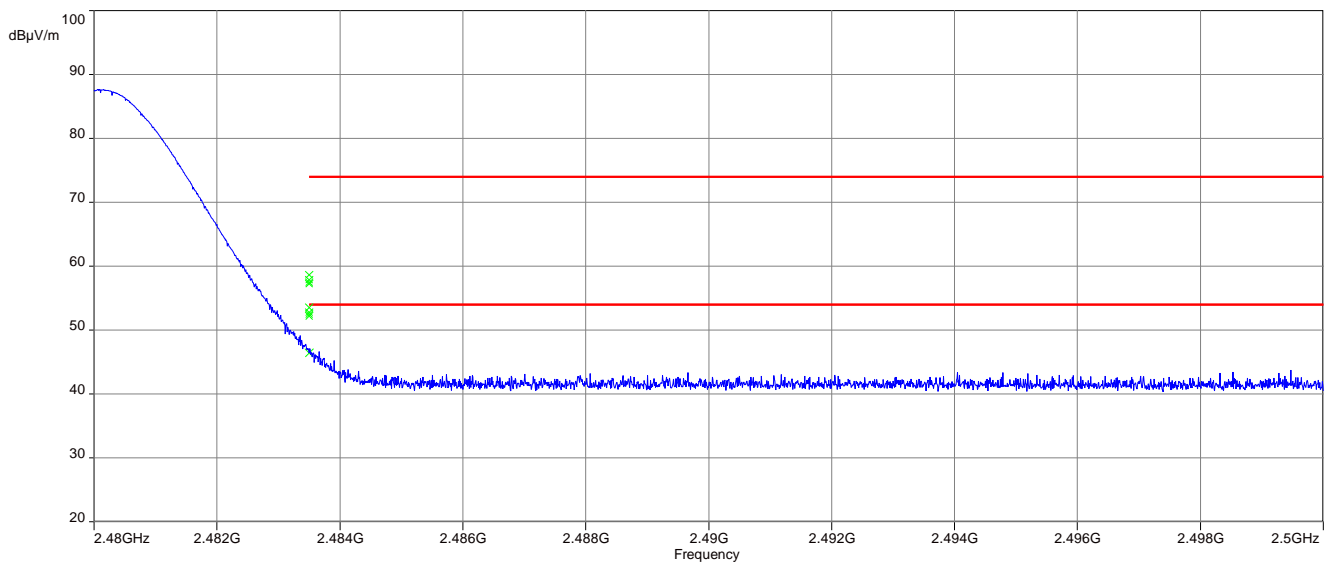

Plot 5: Lower band edge, 8 DPSK modulation, vertical & horizontal polarization

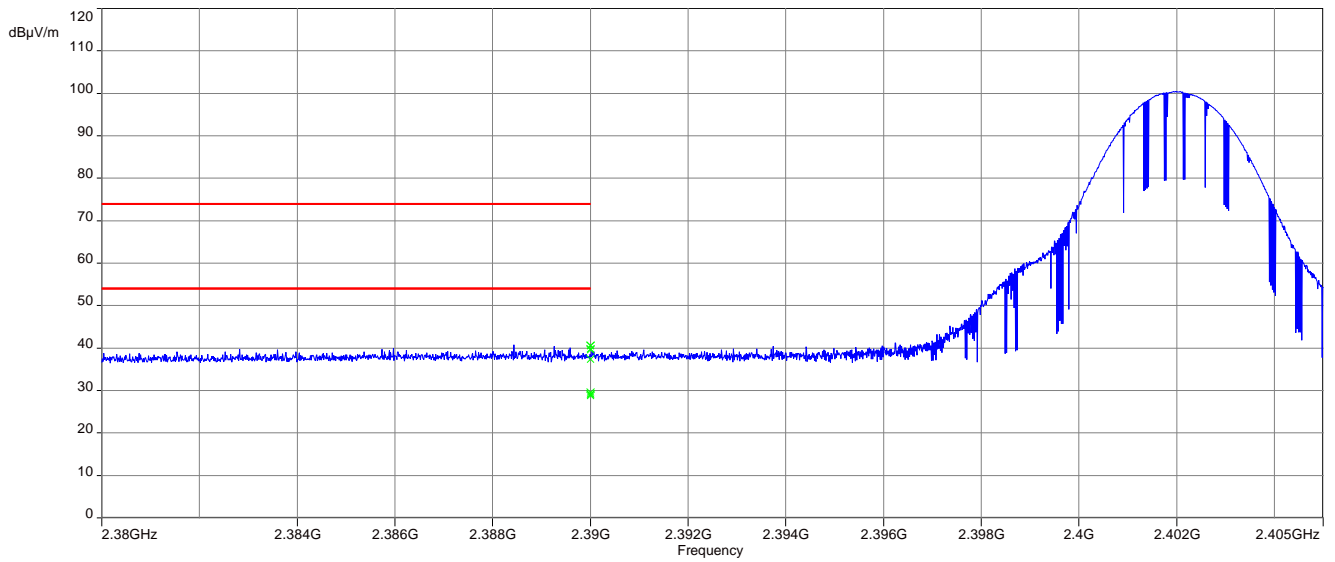

Plot 6: Upper band edge, 8 DPSK modulation, vertical & horizontal polarization

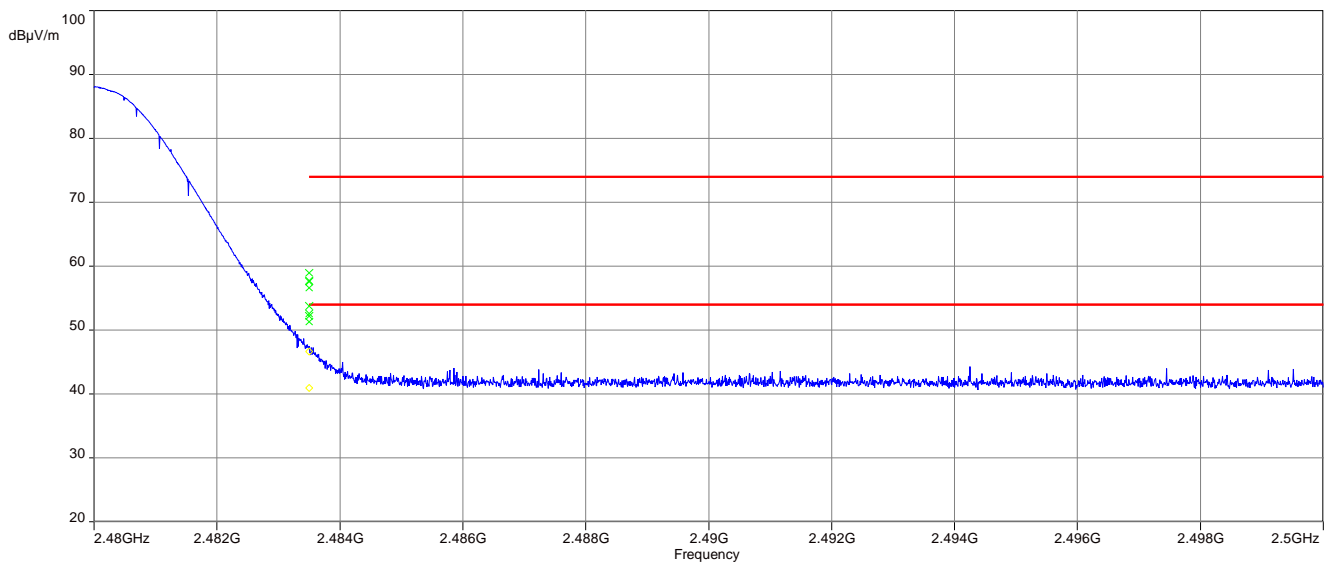

12.8 Spurious emissions conducted

Description:

Measurement of the conducted spurious emissions in transmit mode. The EUT is set to single channel mode and the transmit channel is channel 00, channel 39 and channel 78. The measurement is repeated for all modulations.

Measurement parameters	
External result file	1-5116_22-01-03_Annex_MR_A1.pdf FCC Part 15.247 TX Spurious Conducted
Test setup	See sub clause 8.4 setup A
Measurement uncertainty	See sub clause 9

Limits:

FCC	ISED
TX spurious emissions conducted	
In any 100 kHz bandwidth outside the frequency band in which the spread spectrum or digitally modulated intentional radiator is operating, the radio frequency power that is produced by the intentional radiator shall be at least 20 dB below that in the 100 kHz bandwidth within the band that contains the highest level of the desired power, based on either an RF conducted or a radiated measurement. Attenuation below the general limits specified in Section 15.209(a) is not required	

Results:

TX spurious emissions conducted					
GFSK - mode					
f [MHz]		amplitude of emission [dBm]	limit max. allowed emission power	actual attenuation below frequency of operation [dB]	results
2402		2.3	30 dBm		Operating frequency
All detected emissions are below the -20 dBc criteria. Please take a look at the plot!			-20 dBc		compliant
2441		1.5	30 dBm		Operating frequency
All detected emissions are below the -20 dBc criteria. Please take a look at the plot!			-20 dBc		compliant
2480		0.9	30 dBm		Operating frequency
All detected emissions are below the -20 dBc criteria. Please take a look at the plot!			-20 dBc		compliant

Results:

TX spurious emissions conducted					
Pi/4-DQPSK - mode					
f [MHz]		amplitude of emission [dBm]	limit max. allowed emission power	actual attenuation below frequency of operation [dB]	results
2402		2.8	30 dBm		Operating frequency
All detected emissions are below the -20 dBc criteria. Please take a look at the plot!			-20 dBc		compliant
2441		2.0	30 dBm		Operating frequency
All detected emissions are below the -20 dBc criteria. Please take a look at the plot!			-20 dBc		compliant
2480		1.0	30 dBm		Operating frequency
All detected emissions are below the -20 dBc criteria. Please take a look at the plot!			-20 dBc		compliant

Results:

TX spurious emissions conducted					
8DPSK - mode					
f [MHz]		amplitude of emission [dBm]	limit max. allowed emission power	actual attenuation below frequency of operation [dB]	results
2402		0.5	30 dBm		Operating frequency
All detected emissions are below the -20 dBc criteria. Please take a look at the plot!			-20 dBc		compliant
2441		-1.4	30 dBm		Operating frequency
All detected emissions are below the -20 dBc criteria. Please take a look at the plot!			-20 dBc		compliant
2480		0.2	30 dBm		Operating frequency
All detected emissions are below the -20 dBc criteria. Please take a look at the plot!			-20 dBc		compliant

12.9 Spurious emissions radiated below 30 MHz

Description:

Measurement of the radiated spurious emissions in transmit mode below 30 MHz. The EUT is set to single channel mode and the transmit channels are 00; 39 and 78. The measurement is performed in the mode with the highest output power. The limits are recalculated to a measurement distance of 3 m according the ANSI C63.10.

Measurement parameters	
Detector	Peak / Quasi peak
Sweep time	Auto
Resolution bandwidth	F < 150 kHz: 200 Hz F > 150 kHz: 9 kHz
Video bandwidth	F < 150 kHz: 1 kHz F > 150 kHz: 100 kHz
Span	9 kHz to 30 MHz
Trace mode	Max hold
Test setup	See sub clause 8.2 setup A
Measurement uncertainty	See sub clause 9

Limits:

FCC		ISED	
TX spurious emissions radiated below 30 MHz			
Frequency (MHz)	Field strength (dBµV/m)	Measurement distance	
0.009 – 0.490	2400/F(kHz)	300	
0.490 – 1.705	24000/F(kHz)	30	
1.705 – 30.0	30	30	

Results:

TX spurious emissions radiated below 30 MHz [dBµV/m]		
F [MHz]	Detector	Level [dBµV/m]
All detected emissions are more than 20 dB below the limit.		

Plots:

Plot 1: 9 kHz to 30 MHz, channel 00, transmit mode

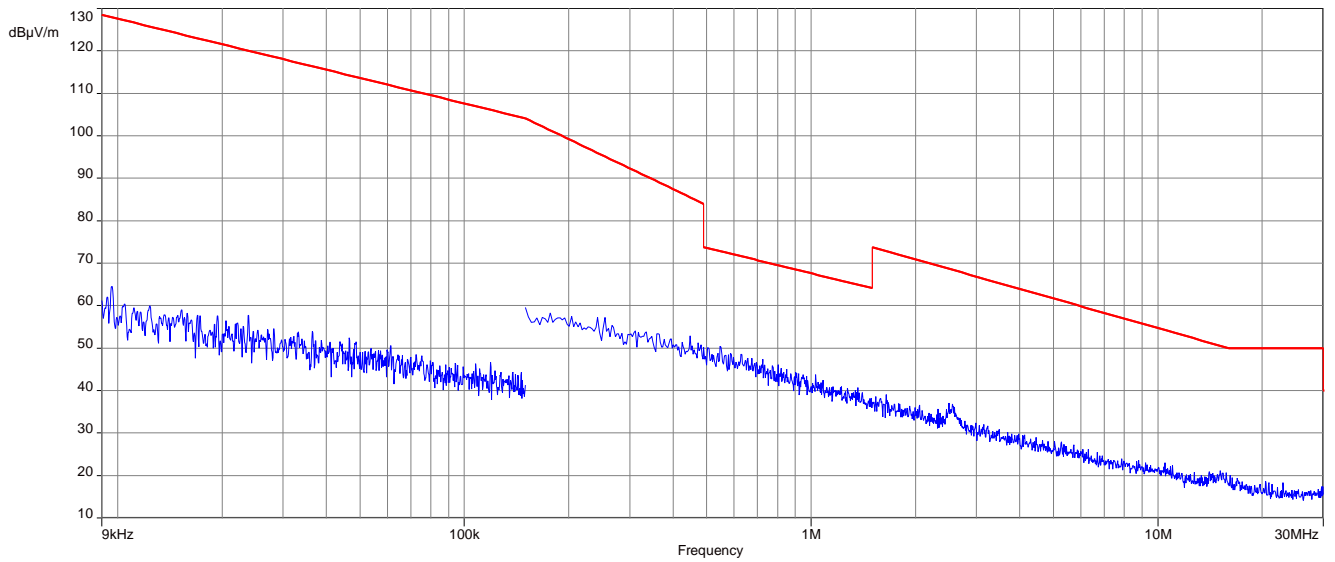

Plot 2: 9 kHz to 30 MHz, channel 39, transmit mode

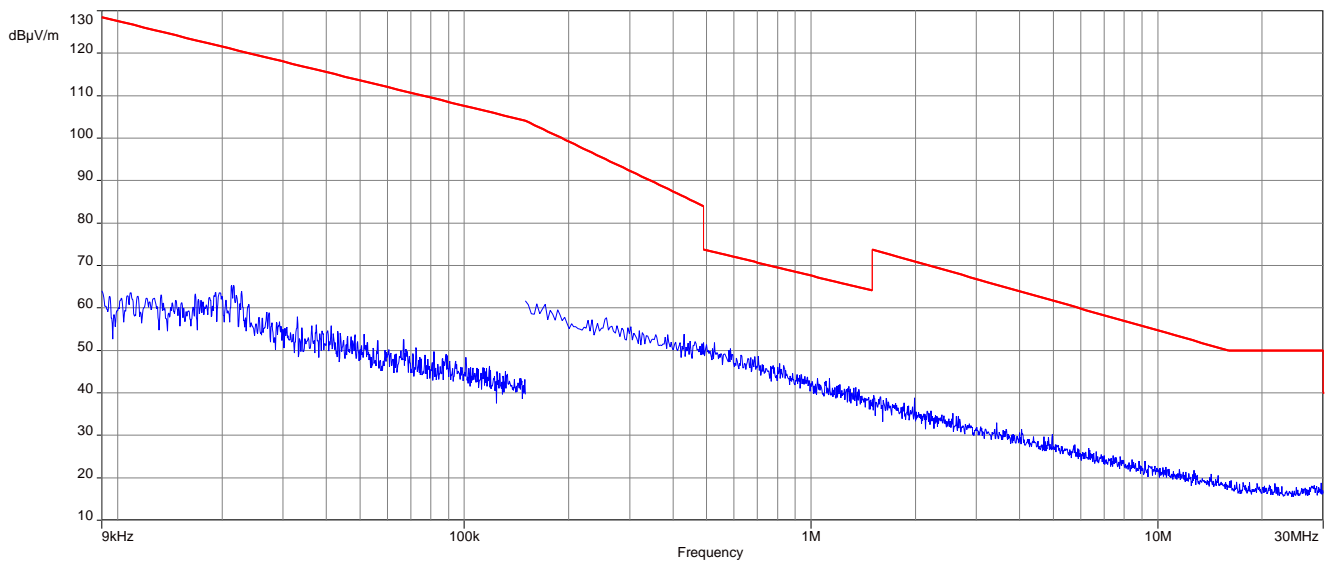

Plot 3: 9 kHz to 30 MHz, channel 78, transmit mode

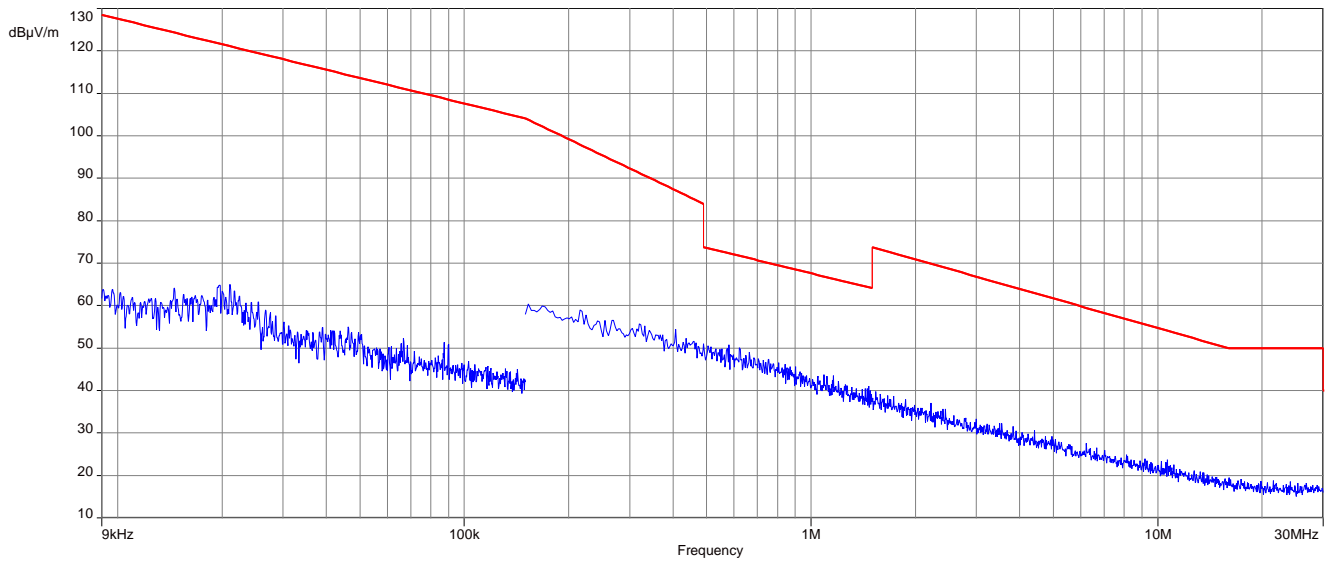

12.10 Spurious emissions radiated 30 MHz to 1 GHz

Description:

Measurement of the radiated spurious emissions in transmit mode. The EUT is set to single channel mode and the transmit channel is channel 00, channel 39 and channel 78. The measurement is performed in the mode with the highest output power.

Measurement parameters	
Detector	Peak / Quasi Peak
Sweep time	Auto
Resolution bandwidth	120 kHz
Video bandwidth	3 x RBW
Span	30 MHz to 1 GHz
Trace mode	Max hold
Measured modulation	<input type="checkbox"/> GFSK <input type="checkbox"/> Pi/4 DQPSK <input checked="" type="checkbox"/> 8DPSK
Test setup	See sub clause 8.1 setup A
Measurement uncertainty	See sub clause 9

The modulation with the highest output power was used to perform the transmitter spurious emissions. If spurious were detected a re-measurement was performed on the detected frequency with each modulation.

Limits:

FCC		ISED	
TX spurious emissions radiated			
In any 100 kHz bandwidth outside the frequency band in which the spread spectrum or digitally modulated intentional radiator is operating, the radio frequency power that is produced by the intentional radiator shall be at least 20 dB below that in the 100 kHz bandwidth within the band that contains the highest level of the desired power, based on either an RF conducted or a radiated measurement. Attenuation below the general limits specified in Section 15.209(a) is not required. In addition, radiated emissions which fall in the restricted bands, as defined in §15.205(a), must also comply with the radiated emission limits specified in §15.209(a) (see §15.205(c)).			
§15.209			
Frequency (MHz)	Field strength (dBµV/m)	Measurement distance	
30 - 88	30.0	10	
88 – 216	33.5	10	
216 – 960	36.0	10	
Above 960	54.0	3	

Plots: Transmit mode

Plot 1: 30 MHz to 1 GHz, TX mode, vertical & horizontal polarization, channel 00 (valid for all channels)

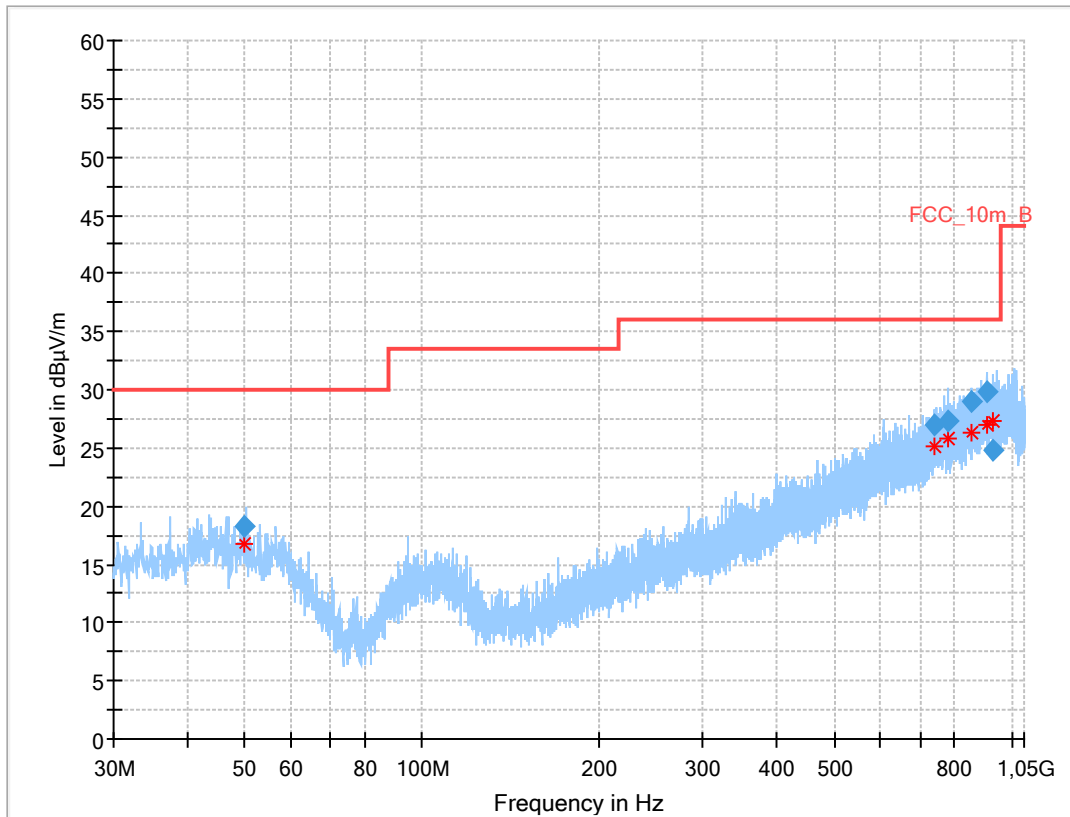

Final results:

Frequency (MHz)	QuasiPeak (dBµV/m)	Limit (dBµV/m)	Margin (dB)	Meas. Time (ms)	Bandwidth (kHz)	Height (cm)	Pol	Azimuth (deg)	Corr. (dB)
49.886	18.23	30.0	11.8	1000	120.0	144.0	V	254	16
738.351	26.95	36.0	9.1	1000	120.0	195.0	H	52	24
780.864	27.33	36.0	8.7	1000	120.0	105.0	V	52	24
852.556	28.96	36.0	7.0	1000	120.0	195.0	V	-37	25
905.632	29.83	36.0	6.2	1000	120.0	195.0	V	232	26
930.785	24.81	36.0	11.2	1000	120.0	195.0	V	217	26

Plot 2: 30 MHz to 1 GHz, TX mode, vertical & horizontal polarization, channel 39

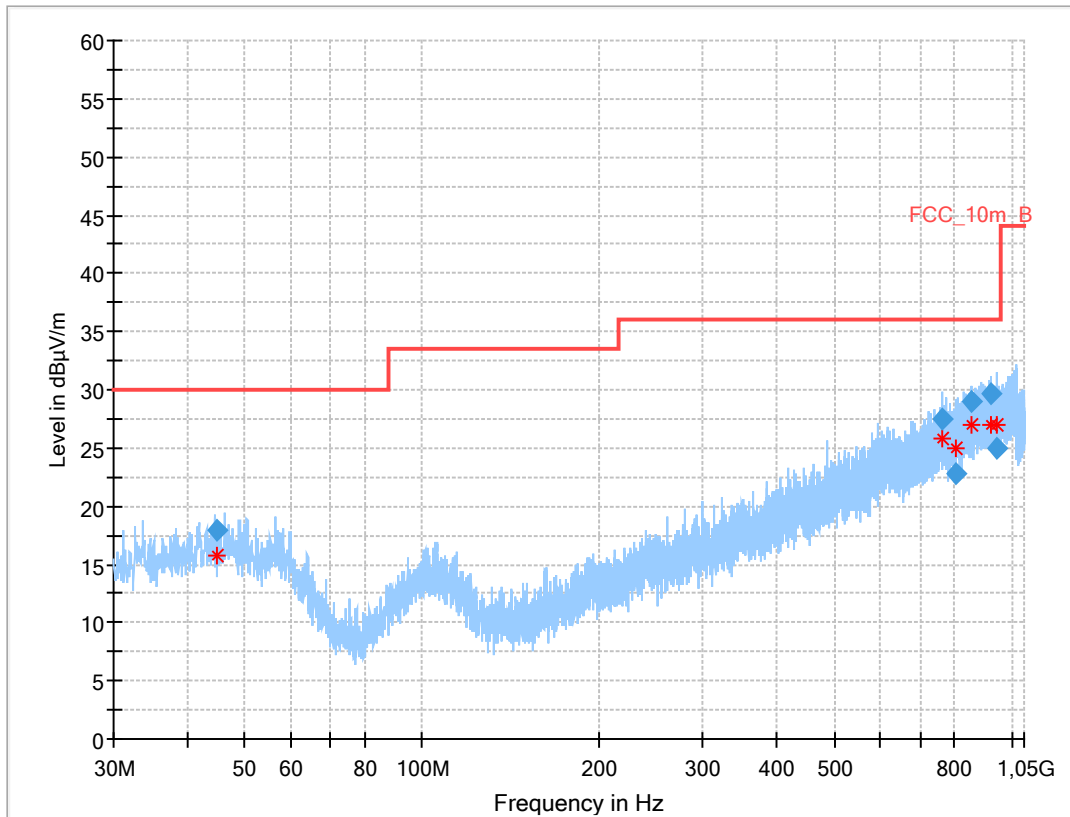

Final results:

Frequency (MHz)	QuasiPeak (dBµV/m)	Limit (dBµV/m)	Margin (dB)	Meas. Time (ms)	Bandwidth (kHz)	Height (cm)	Pol	Azimuth (deg)	Corr. (dB)
44.993	17.94	30.0	12.1	1000	120.0	195.0	H	110	16
762.496	27.50	36.0	8.5	1000	120.0	195.0	H	232	24
804.749	22.80	36.0	13.2	1000	120.0	195.0	H	62	24
853.444	28.97	36.0	7.0	1000	120.0	195.0	H	232	25
923.102	29.65	36.0	6.4	1000	120.0	128.0	H	242	26
943.841	24.90	36.0	11.1	1000	120.0	195.0	V	142	25

Plot 3: 30 MHz to 1 GHz, TX mode, vertical & horizontal polarization, channel 78

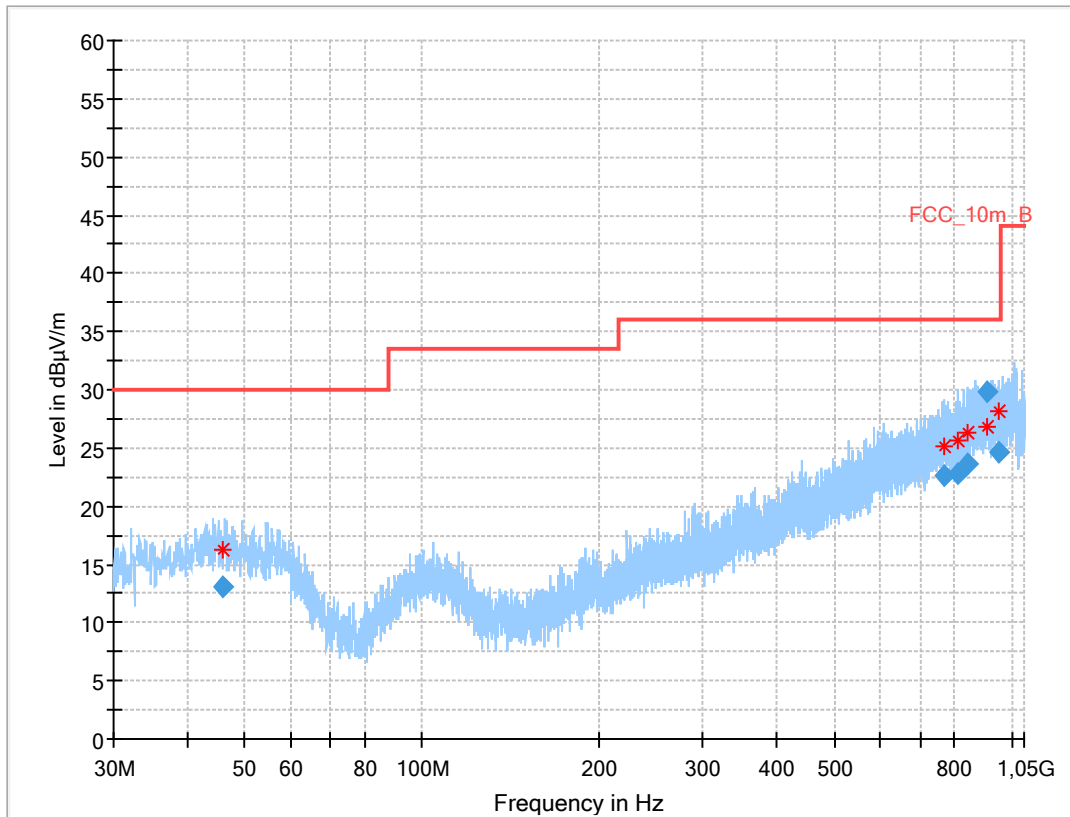

Final results:

Frequency (MHz)	QuasiPeak (dBµV/m)	Limit (dBµV/m)	Margin (dB)	Meas. Time (ms)	Bandwidth (kHz)	Height (cm)	Pol	Azimuth (deg)	Corr. (dB)
45.913	13.06	30.0	16.9	1000	120.0	195.0	H	250	16
766.020	22.59	36.0	13.4	1000	120.0	98.0	H	232	24
812.796	22.87	36.0	13.1	1000	120.0	195.0	V	52	24
844.700	23.63	36.0	12.4	1000	120.0	195.0	V	307	25
909.275	29.87	36.0	6.1	1000	120.0	195.0	H	232	26
949.224	24.72	36.0	11.3	1000	120.0	195.0	V	52	25

12.11 Spurious emissions radiated above 1 GHz

Description:

Measurement of the radiated spurious emissions in transmit mode. The EUT is set to single channel mode and the transmit channel is channel 00, channel 39 and channel 78. The measurement is performed in the mode with the highest output power.

Measurement parameters	
Detector	Peak / RMS
Sweep time	Auto
Resolution bandwidth	1 MHz
Video bandwidth	3 x RBW
Span	1 GHz to 26 GHz
Trace mode	Max hold
Measured modulation	<input type="checkbox"/> GFSK <input type="checkbox"/> Pi/4 DQPSK <input checked="" type="checkbox"/> 8DPSK
Test setup	See sub clause 8.2 setup C (1 GHz - 18 GHz) See sub clause 8.3 setup A (18 GHz - 26 GHz)
Measurement uncertainty	See sub clause 9

The modulation with the highest output power was used to perform the transmitter spurious emissions. If spurious were detected a re-measurement was performed on the detected frequency with each modulation.

Limits:

FCC		ISED	
TX spurious emissions radiated			
In any 100 kHz bandwidth outside the frequency band in which the spread spectrum or digitally modulated intentional radiator is operating, the radio frequency power that is produced by the intentional radiator shall be at least 20 dB below that in the 100 kHz bandwidth within the band that contains the highest level of the desired power, based on either an RF conducted or a radiated measurement. Attenuation below the general limits specified in Section 15.209(a) is not required. In addition, radiated emissions which fall in the restricted bands, as defined in §15.205(a), must also comply with the radiated emission limits specified in §15.209(a) (see §15.205(c)).			
§15.209			
Frequency (MHz)	Field strength (dBµV/m)	Measurement distance	
Above 960	54.0	3	

Results: Transmitter mode

TX spurious emissions radiated [dBµV/m]								
2402 MHz			2441 MHz			2480 MHz		
F [MHz]	Detector	Level [dBµV/m]	F [MHz]	Detector	Level [dBµV/m]	F [MHz]	Detector	Level [dBµV/m]
2323	Peak	47.0	2363	Peak	49.5	2376	Peak	49.6
	AVG	42.7		AVG	45.5		AVG	45.5
-/-	Peak	-/-	7323	Peak	52.6	-/-	Peak	-/-
	AVG	-/-		AVG	46.4		AVG	-/-
-/-	Peak	-/-	-/-	Peak	-/-	-/-	Peak	-/-
	AVG	-/-		AVG	-/-		AVG	-/-

Plots: Transmitter mode

Plot 1: 1 GHz to 18 GHz, TX mode, channel 00, vertical & horizontal polarization

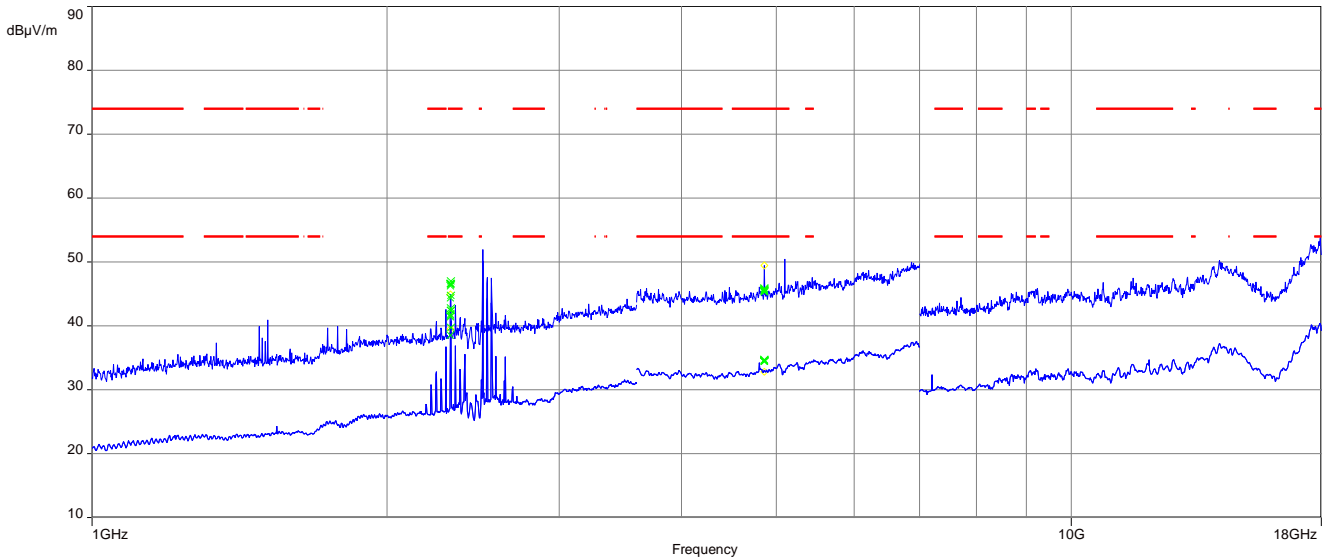

The carrier signal is notched with a 2.4 GHz band rejection filter.

Plot 2: 1 GHz to 18 GHz, TX mode, channel 39, vertical & horizontal polarization

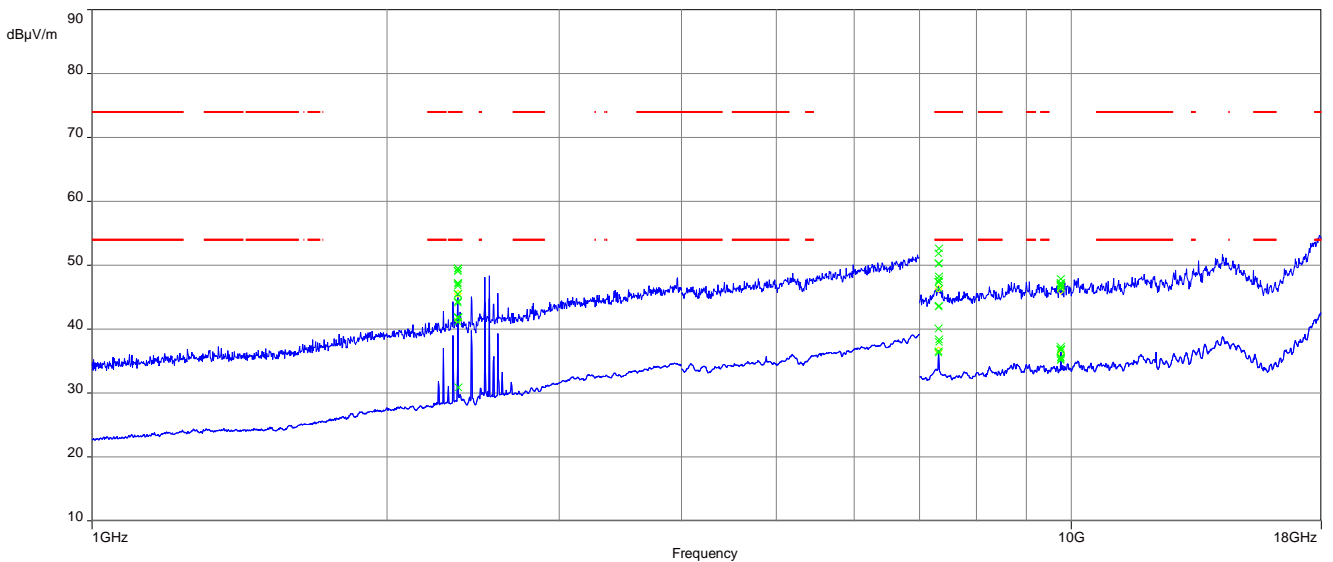

The carrier signal is notched with a 2.4 GHz band rejection filter.

Plot 3: 1 GHz to 18 GHz, TX mode, channel 78, vertical & horizontal polarization

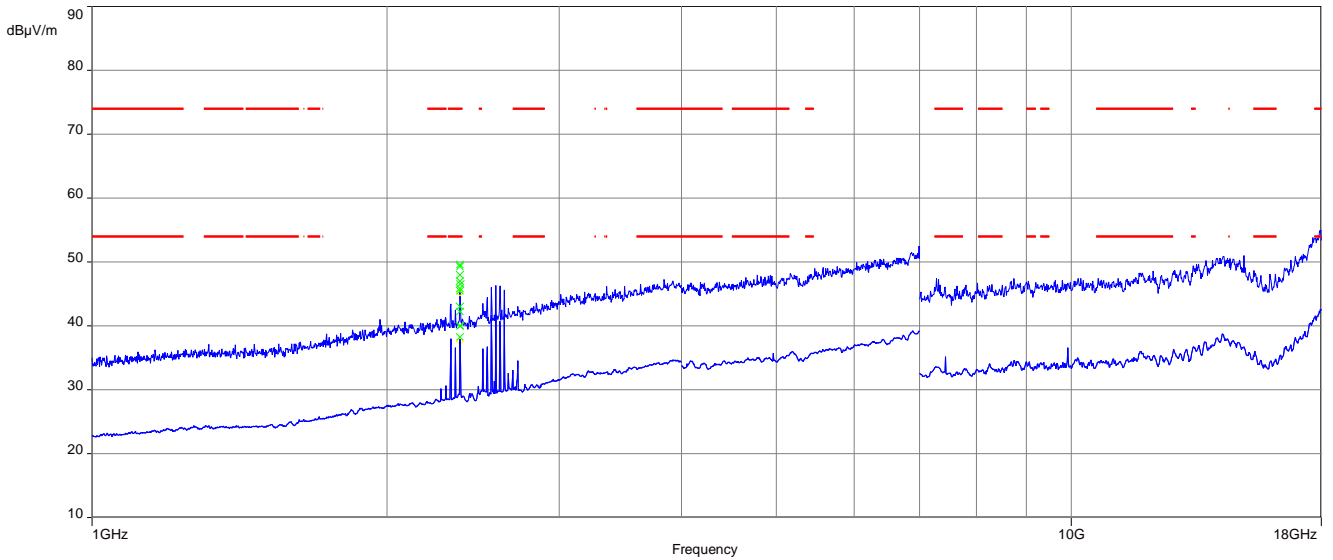

The carrier signal is notched with a 2.4 GHz band rejection filter.

Plot 4: 18 GHz to 26 GHz, TX mode, vertical & horizontal polarization, valid for all channels

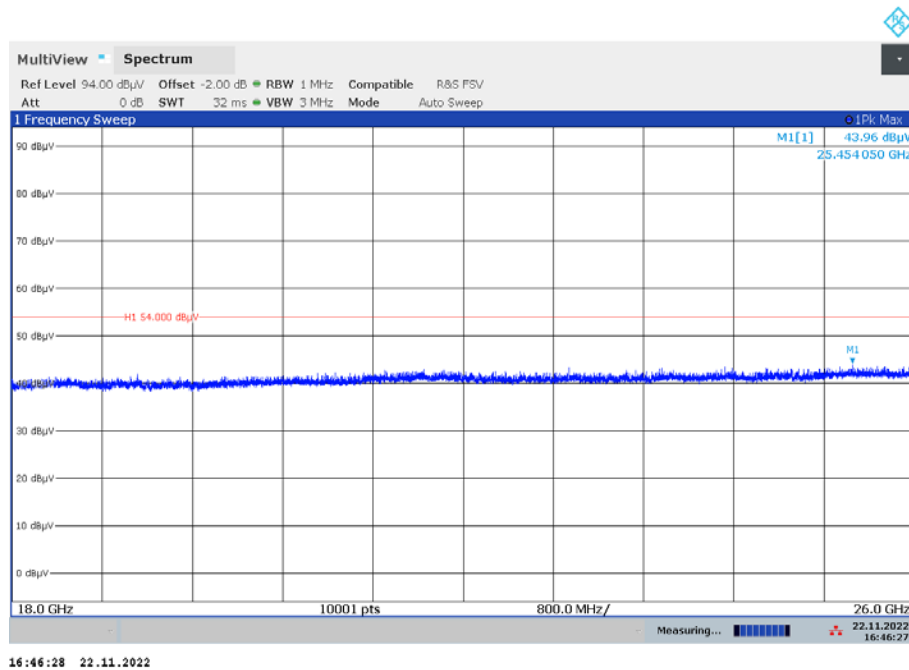

13 Glossary

EUT	Equipment under test
DUT	Device under test
UUT	Unit under test
GUE	GNSS User Equipment
ETSI	European Telecommunications Standards Institute
EN	European Standard
FCC	Federal Communications Commission
FCC ID	Company Identifier at FCC
IC	Industry Canada
PMN	Product marketing name
HMN	Host marketing name
HVIN	Hardware version identification number
FVIN	Firmware version identification number
EMC	Electromagnetic Compatibility
HW	Hardware
SW	Software
Inv. No.	Inventory number
S/N or SN	Serial number
C	Compliant
NC	Not compliant
NA	Not applicable
NP	Not performed
PP	Positive peak
QP	Quasi peak
AVG	Average
OC	Operating channel
OCW	Operating channel bandwidth
OBW	Occupied bandwidth
OOB	Out of band
DFS	Dynamic frequency selection
CAC	Channel availability check
OP	Occupancy period
NOP	Non occupancy period
DC	Duty cycle
PER	Packet error rate
CW	Clean wave
MC	Modulated carrier
WLAN	Wireless local area network
RLAN	Radio local area network
DSSS	Dynamic sequence spread spectrum
OFDM	Orthogonal frequency division multiplexing
FHSS	Frequency hopping spread spectrum
GNSS	Global Navigation Satellite System
C/N₀	Carrier to noise-density ratio, expressed in dB-Hz

14 Document history

Version	Applied changes	Date of release
-/-	Initial release	2022-12-07

15 Accreditation Certificate – D-PL-12076-01-04

first page	last page
 <p>The first page of the accreditation certificate includes the DAKKS logo (Deutsche Akkreditierungsstelle), the company name 'Deutsche Akkreditierungsstelle GmbH', and accreditation details for CTC advanced GmbH. It states that the company is competent under the terms of DIN EN ISO/IEC 17025:2018 for testing in the fields of Telecommunication (TC) and Electromagnetic Compatibility (EMC) for Canadian Standards. The certificate is signed by the Head of Division, dated 09.06.2020.</p>	 <p>The last page of the certificate provides contact information for three offices: Berlin, Frankfurt am Main, and Braunschweig. It also contains detailed text regarding the accreditation process, including references to the Act on the Accreditation Body (AkkStelleG) and the Multilateral Agreements for Mutual Recognition (EA, ILAC, IAF).</p>

Note: The current certificate annex is published on the websites (link see below).

<https://www.dakks.de/files/data/as/pdf/D-PL-12076-01-04e.pdf>

OR

https://ctcadvanced.com/app/uploads/2020/06/D-PL-12076-01-04_Canada_TCEMC.pdf

16 Accreditation Certificate – D-PL-12076-01-05

first page	last page			
 <p>Deutsche Akkreditierungsstelle GmbH</p> <p>Entrusted according to Section 8 subsection 1 AkkStelleG in connection with Section 1 subsection 1 AkkStelleGBV Signatory to the Multilateral Agreements of EA, ILAC and IAF for Mutual Recognition</p> <p>Accreditation </p> <p>The Deutsche Akkreditierungsstelle GmbH attests that the testing laboratory CTC advanced GmbH Untertürkheimer Straße 6-10, 66117 Saarbrücken is competent under the terms of DIN EN ISO/IEC 17025:2018 to carry out tests in the following fields: Telecommunication (FCC Requirements)</p> <p>The accreditation certificate shall only apply in connection with the notice of accreditation of 09.06.2020 with the accreditation number D-PL-12076-01. It comprises the cover sheet, the reverse side of the cover sheet and the following annex with a total of 05 pages. Registration number of the certificate: D-PL-12076-01-05</p> <p>Frankfurt am Main, 09.06.2020  by Dipl.-Ing. (FH) Alf Egner Head of Division</p> <p><small>The certificate together with its annex reflects the status at the time of the date of issue. The current status of the scope of accreditation can be found in the database of accredited bodies of Deutsche Akkreditierungsstelle GmbH. https://www.dakks.de/en/content/accredited-bodies-dakks See also Annex 1.</small></p>	<p>Deutsche Akkreditierungsstelle GmbH</p> <table border="0"> <tr> <td>Office Berlin Spittelmarkt 10 10117 Berlin</td> <td>Office Frankfurt am Main Europa-Allee 52 60327 Frankfurt am Main</td> <td>Office Braunschweig Bundesallee 100 38116 Braunschweig</td> </tr> </table> <p>The publication of extracts of the accreditation certificate is subject to the prior written approval by Deutsche Akkreditierungsstelle GmbH (DAkKS). Exempted is the unchanged form of separate disseminations of the cover sheet by the conformity assessment body mentioned overleaf.</p> <p>No impression shall be made that the accreditation also extends to fields beyond the scope of accreditation attested by DAkKS.</p> <p>The accreditation was granted pursuant to the Act on the Accreditation Body (AkkStelleG) of 31 July 2009 (Federal Law Gazette I p. 2625) and the Regulation (EC) No 765/2008 of the European Parliament and of the Council of 9 July 2008 setting out the requirements for accreditation and market surveillance relating to the marketing of products (Official Journal of the European Union L 218 of 9 July 2008, p. 30). DAkKS is a signatory to the Multilateral Agreements for Mutual Recognition of the European co-operation for Accreditation (EA), International Accreditation Forum (IAF) and International Laboratory Accreditation Cooperation (ILAC). The signatories to these agreements recognise each other's accreditations.</p> <p>The up-to-date state of membership can be retrieved from the following websites: EA: www.european-accreditation.org ILAC: www.ilac.org IAF: www.iaf.nu</p>	Office Berlin Spittelmarkt 10 10117 Berlin	Office Frankfurt am Main Europa-Allee 52 60327 Frankfurt am Main	Office Braunschweig Bundesallee 100 38116 Braunschweig
Office Berlin Spittelmarkt 10 10117 Berlin	Office Frankfurt am Main Europa-Allee 52 60327 Frankfurt am Main	Office Braunschweig Bundesallee 100 38116 Braunschweig		

Note: The current certificate annex is published on the websites (link see below).

<https://www.dakks.de/files/data/as/pdf/D-PL-12076-01-05e.pdf>

or

https://ctcadvanced.com/app/uploads/2020/06/D-PL-12076-01-05_TCB_USA.pdf

END OF TEST REPORT