

SANGSHIN

APPROVAL SHEET



Description	Bluetooth Antenna
Model No.	KSCA-B2442BP
Item No.	

CUSTOMER :

	Design	Check	Approval
Signature			

Company	KOREA SANGSHIN ELECTRIC CO.,LTD	Tel.	(82)-041 -865-9000
Address	614-1 Wolhari Suhmyon Yunkikun Choongnam The Republic of Korea		

1. Features

- a) Small size and low profile
- b) Wide frequency range
- c) Omnidirectional radiational pattern

2. Specification

Type	KSCA-2442B
Dimensions	6.0 x 4.0 x 1.0 mm
Operation frequency	2400 – 2484 MHz

3. Characteristics (Reference)

Return Loss @ f_c	16 dB min.
Bandwidth in $S_{11} \leq -10\text{dB}$	200 MHz min.
Gain - peak -	-2.5 dB _d (figure 8-(b))
Gain - average -	-7 dB _d (figure 8-(a))

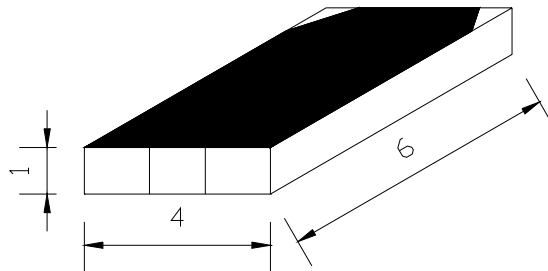
4. Dimensions

(unit : mm)

5. Test board

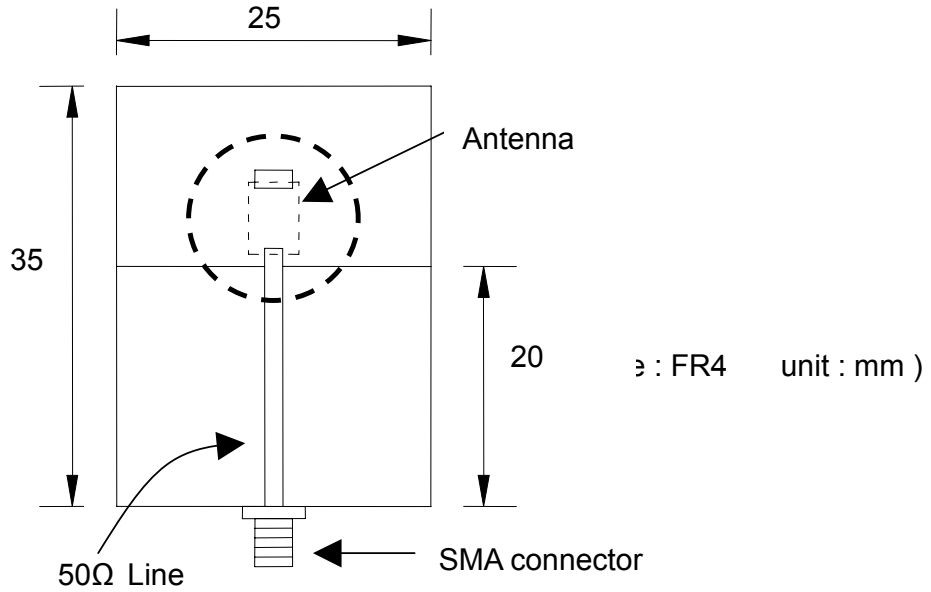

6. Recommend land pattern

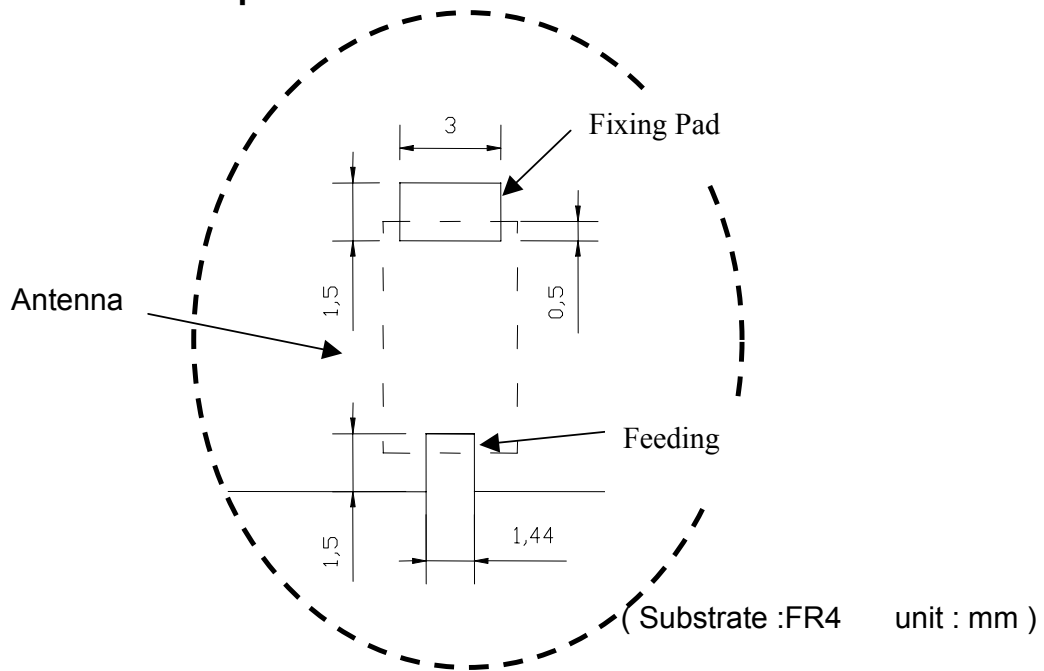

7. Return Loss

4 May 2001 10:06:22

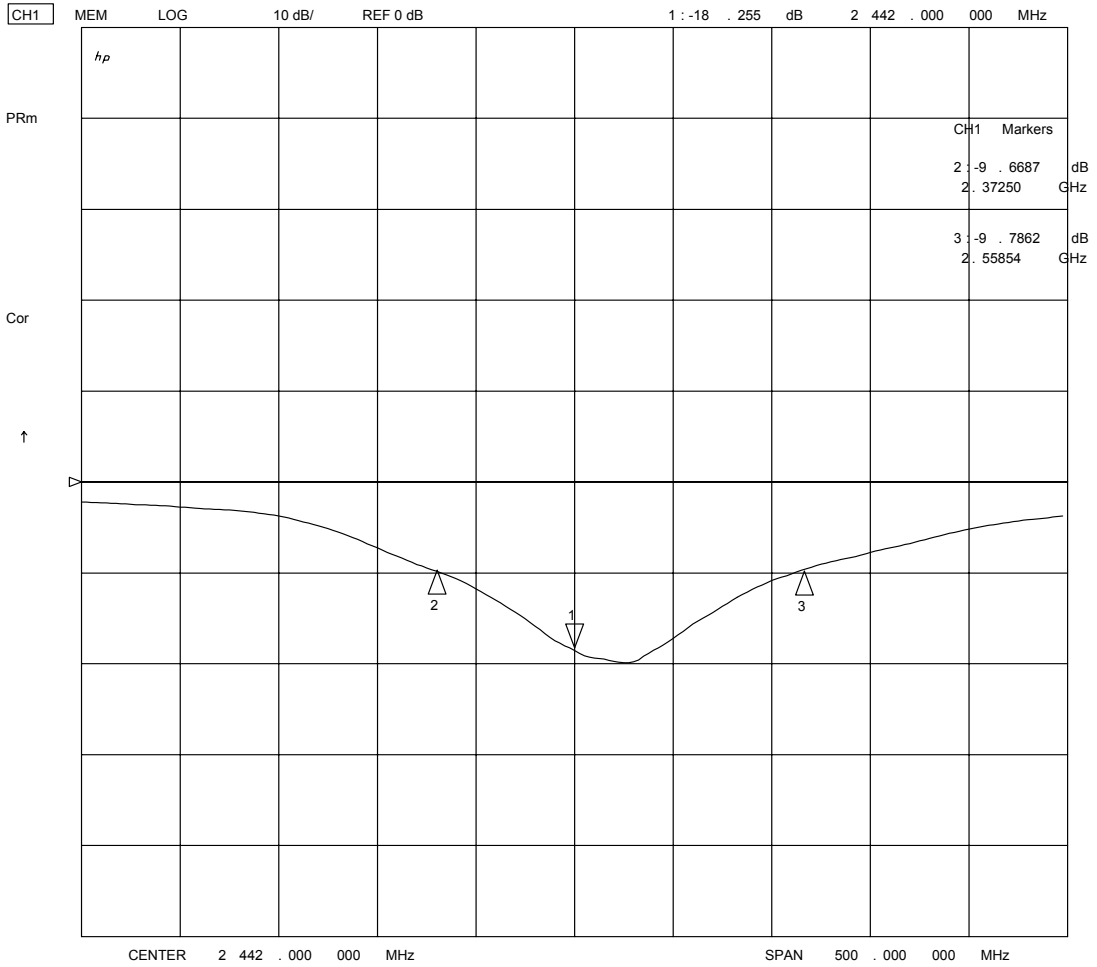

8. Radiation Pattern

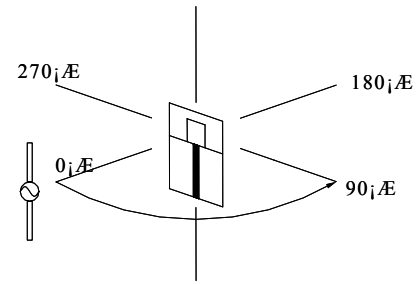
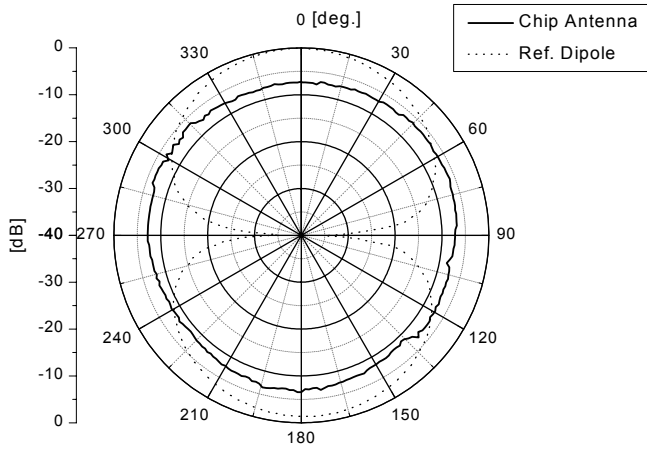

(a) H-plane : Longitude

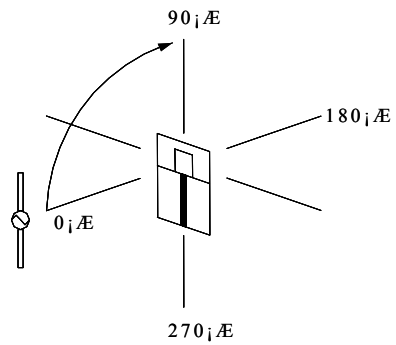
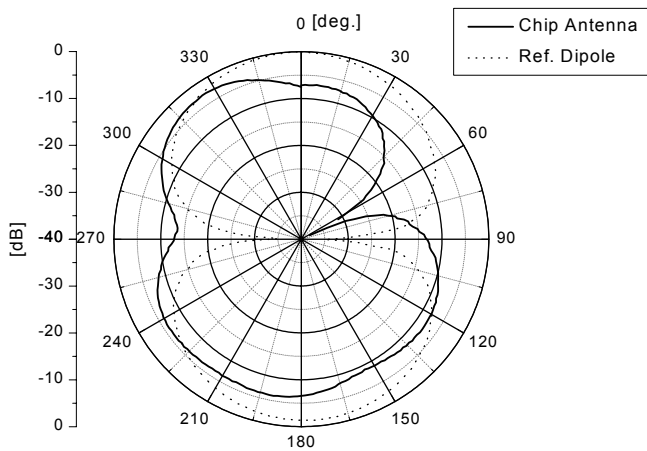

(b) E-plane : Longitude

