

FCC Test Report

Report No.: RF161004C26B

FCC ID: QYLZX70U

Test Model: AS3993

Received Date: Jul. 17, 2017

Test Date: Jul. 26, 2017 ~ Aug. 15, 2017

Issued Date: Aug. 16, 2017

Applicant: Getac Technology Corporation.

Address: 5F., Building A, No. 209, Sec.1, Nangang Rd., Nangang Dist., Taipei City 11568, Taiwan, R.O.C.

Issued By: Bureau Veritas Consumer Products Services (H.K.) Ltd., Taoyuan Branch

Lab Address: No. 47-2, 14th Ling, Chia Pau Vil., Lin Kou Dist., New Taipei City, Taiwan (R.O.C)

Test Location: No. 19, Hwa Ya 2nd Rd, Wen Hwa Tsuen, Kwei Shan Hsiang, Taoyuan Hsien 333, Taiwan, R.O.C.



This report is for your exclusive use. Any copying or replication of this report to or for any other person or entity, or use of our name or trademark, is permitted only with our prior written permission. This report sets forth our findings solely with respect to the test samples identified herein. The results set forth in this report are not indicative or representative of the quality or characteristics of the lot from which a test sample was taken or any similar or identical product unless specifically and expressly noted. Our report includes all of the tests requested by you and the results thereof based upon the information that you provided to us. You have 60 days from date of issuance of this report to notify us of any material error or omission caused by our negligence, provided, however, that such notice shall be in writing and shall specifically address the issue you wish to raise. A failure to raise such issue within the prescribed time shall constitute your unqualified acceptance of the completeness of this report, the tests conducted and the correctness of the report contents. Unless specifically mentioned, the uncertainty of measurement has been explicitly taken into account to declare the compliance or non-compliance to the specification.

Table of Contents

Release Control Record	4
1 Certificate of Conformity	5
2 Summary of Test Results	6
2.1 Measurement Uncertainty	6
2.2 Modification Record	6
3 General Information	7
3.1 General Description of EUT	7
3.2 Description of Test Modes	8
3.2.1 Test Mode Applicability and Tested Channel Detail	9
3.3 Description of Support Units	10
3.3.1 Configuration of System under Test	10
3.4 General Description of Applied Standards	10
4 Test Types and Results	11
4.1 Radiated Emission and Bandedge Measurement	11
4.1.1 Limits of Radiated Emission and Bandedge Measurement	11
4.1.2 Test Instruments	12
4.1.3 Test Procedures	13
4.1.4 Deviation from Test Standard	13
4.1.5 Test Set Up	14
4.1.6 EUT Operating Conditions	14
4.1.7 Test Results	15
4.2 Conducted Emission Measurement	24
4.2.1 Limits of Conducted Emission Measurement	24
4.2.2 Test Instruments	24
4.2.3 Test Procedures	25
4.2.4 Deviation from Test Standard	25
4.2.5 Test Setup	25
4.2.6 EUT Operating Condition	25
4.2.7 Test Results	26
4.3 Number of Hopping Frequency Used	28
4.3.1 Limits of Hopping Frequency Used Measurement	28
4.3.2 Test Setup	28
4.3.3 Test Instruments	28
4.3.4 Test Procedure	28
4.3.5 Deviation from Test Standard	28
4.3.6 Test Results	29
4.4 Dwell Time on Each Channel	30
4.4.1 Limits of Dwell Time on Each Channel Measurement	30
4.4.2 Test Setup	30
4.4.3 Test Instruments	30
4.4.4 Test Procedures	30
4.4.5 Deviation from Test Standard	30
4.4.6 Test Results	31
4.5 Channel Bandwidth	32
4.5.1 Limits of Channel Bandwidth Measurement	32
4.5.2 Test Setup	32
4.5.3 Test Instruments	32
4.5.4 Test Procedure	32
4.5.5 Deviation from Test Standard	32
4.5.6 EUT Operating Condition	32
4.5.7 Test Results	33
4.6 Occupied Bandwidth Measurement	34
4.6.1 Test Setup	34

4.6.2	Test Instruments	34
4.6.3	Test Procedure	34
4.6.4	Deviation from Test Standard	34
4.6.5	EUT Operating Conditions.....	34
4.6.6	Test Results	35
4.7	Hopping Channel Separation.....	36
4.7.1	Limits of Hopping Channel Separation Measurement.....	36
4.7.2	Test Setup.....	36
4.7.3	Test Instruments	36
4.7.4	Test Procedure	36
4.7.5	Deviation from Test Standard	36
4.7.6	Test Results	37
4.8	Maximum Output Power	38
4.8.1	Limits of Maximum Output Power Measurement	38
4.8.2	Test Setup.....	38
4.8.3	Test Instruments	38
4.8.4	Test Procedure	38
4.8.5	Deviation from Test Standard	38
4.8.6	EUT Operating Condition	38
4.8.7	Test Results	39
4.9	Conducted Out of Band Emission Measurement	40
4.9.1	Limits Of Conducted Out Of Band Emission Measurement	40
4.9.2	Test Instruments	40
4.9.3	Test Procedure	40
4.9.4	Deviation from Test Standard	40
4.9.5	EUT Operating Condition	40
4.9.6	Test Results	40
5	Pictures of Test Arrangements.....	42
	Appendix – Information on the Testing Laboratories	43

Release Control Record

Issue No.	Description	Date Issued
RF161004C26B	Original Release	Aug. 16, 2017

1 Certificate of Conformity

Product: UHF RFID reader

Brand: Getac

Test Model: AS3993

Sample Status: Identical Prototype

Applicant: Getac Technology Corporation.

Test Date: Jul. 26, 2017 ~ Aug. 15, 2017

Standards: 47 CFR FCC Part 15, Subpart C (Section 15.247)
ANSI C63.10:2013

The above equipment has been tested by **Bureau Veritas Consumer Products Services (H.K.) Ltd., Taoyuan Branch**, and found compliance with the requirement of the above standards. The test record, data evaluation & Equipment Under Test (EUT) configurations represented herein are true and accurate accounts of the measurements of the sample's EMC characteristics under the conditions specified in this report.

Prepared by : Evonne Liu , **Date:** Aug. 16, 2017
Evonne Liu / Specialist

Approved by : David Huang , **Date:** Aug. 16, 2017
David Huang / Project Engineer

2 Summary of Test Results

47 CFR FCC Part 15, Subpart C (Section 15.247)			
FCC Clause	Test Item	Result	Remarks
15.207	AC Power Conducted Emission	Pass	Meet the requirement of limit. Minimum passing margin is -19.29 dB at 0.36239 MHz.
15.247(a)(1)(i)	Number of Hopping Frequency Used	Pass	Meet the requirement of limit.
15.247(a)(1)(i)	Dwell Time on Each Channel	Pass	Meet the requirement of limit.
15.247(a)(1)	1. Hopping Channel Separation 2. Spectrum Bandwidth of a Frequency Hopping Sequence Spread Spectrum System	Pass	Meet the requirement of limit.
15.247(b)	Maximum Peak Output Power	Pass	Meet the requirement of limit.
15.205 & 209	Radiated Emissions	Pass	Meet the requirement of limit. Minimum passing margin is -2.95 dB at 121.18 MHz.
15.247(d)	Band Edge Measurement	Pass	Meet the requirement of limit.
15.247(d)	Antenna Port Emission	Pass	Meet the requirement of limit.
15.203	Antenna Requirement	Pass	No antenna connector is used.

NOTE: If The Frequency Hopping System operating in 2400-2483.5 MHz band and the output power less than 125 mW. The hopping channel carrier frequencies separated by a minimum of 25 kHz or two-thirds of the 20 dB bandwidth of hopping channel whichever is greater.

2.1 Measurement Uncertainty

Where relevant, the following measurement uncertainty levels have been estimated for tests performed on the EUT:

The listed uncertainties are the worst case uncertainty for the entire range of measurement. Please note that the uncertainty values are provided for informational purposes only and are not used in determining the PASS/FAIL results.

Measurement	Frequency	Expanded Uncertainty (k=2) (±)
Conducted Emissions at mains ports	150 kHz ~ 30 MHz	2.44 dB
Radiated Emissions up to 1 GHz	30 MHz ~ 200 MHz	2.93 dB
	200 MHz ~ 1000 MHz	2.95 dB
Radiated Emissions above 1 GHz	1 GHz ~ 18 GHz	2.26 dB
	18 GHz ~ 40 GHz	1.94 dB

2.2 Modification Record

There were no modifications required for compliance.

3 General Information

3.1 General Description of EUT

Product	UHF RFID reader
Brand	Getac
Test Model	AS3993
Status of EUT	Identical Prototype
Power Supply Rating	12.0 Vdc (adapter) 3.8 Vdc (Li-ion battery)
Modulation Type	ASK
Transfer Rate	40 kbps
Operating Frequency	902.75 ~ 927.25 MHz
Number of Channel	50
Output Power	665.273 mW
Antenna Type	PIFA antenna with 1.15 dBi gain
Antenna Connector	N/A
Accessory Device	Refer to Note as below
Data Cable Supplied	Refer to Note as below

Note:

- The EUT is authorized for use in specific End-product. Please refer to below table for more details.

Item	Brand	Model
Tablet	Getac	ZX70

- The End-product contains following accessory devices.

Product	Brand	Model	Description
Adapter	APD	WA24Q12R	I/P: 100-240 Vac, 50/60 Hz, 0.7 A O/P: 12 Vdc, 2 A 1.75m shielded cable with 1 core
Battery	Getac	BP1S2P4240L	3.8 Vdc, 8480 mAh
LCD Panel	Truly	TDO-HD0698K61701	7"
Photo Camera	Chicony	CWFFF2520005340LH	2MPs HD Fix focus camera
Video Camera	Chicony	CYAF82520005340LH	8MPs auto focus camera
CPU	intel	Atom Z8350	592 PIN
Memorry	Samsung	K4E8E304EE-EGC	DDR3 2G (1G*2)
Storage	Samsung	KL MAG2GEND-B031	16G
GPS	U-blox	MAX-M8N	--
BT/WLAN Module	AMPAK	AP6234	--

- The above EUT information is declared by manufacturer and for more detailed features description, please refer to the manufacturer's specifications or User's Manual.

3.2 Description of Test Modes

50 channels are provided to this EUT:

Ch	Freq. (MHz)	Ch	Freq. (MHz)	Ch	Freq. (MHz)	Ch	Freq. (MHz)	Ch	Freq. (MHz)
1	902.75	11	907.75	21	912.75	31	917.75	41	922.75
2	903.25	12	908.25	22	913.25	32	918.25	42	923.25
3	903.75	13	908.75	23	913.75	33	918.75	43	923.75
4	904.25	14	909.25	24	914.25	34	919.25	44	924.25
5	904.75	15	909.75	25	914.75	35	919.75	45	924.75
6	905.25	16	910.25	26	915.25	36	920.25	46	925.25
7	905.75	17	910.75	27	915.75	37	920.75	47	925.75
8	906.25	18	911.25	28	916.25	38	921.25	48	926.25
9	906.75	19	911.75	29	916.75	39	921.75	49	926.75
10	907.25	20	912.25	30	917.25	40	922.25	50	927.25

3.2.1 Test Mode Applicability and Tested Channel Detail

EUT Configure Mode	Applicable To				Description
	RE \geq 1G	RE $<$ 1G	PLC	APCM	
-	√	√	√	√	-

Where **RE \geq 1G**: Radiated Emission above 1 GHz **RE $<$ 1G**: Radiated Emission below 1 GHz
PLC: Power Line Conducted Emission **APCM**: Antenna Port Conducted Measurement

NOTE:

1. The EUT had been pre-tested on the positioned of each 3 axis. The worst case was found when positioned on **Y-plane**.
2. "-" means no effect.

Radiated Emission Test (Above 1 GHz):

- Pre-Scan has been conducted to determine the worst-case mode from all possible combinations between available modulations, data rates and antenna ports (if EUT with antenna diversity architecture).
- Following channel(s) was (were) selected for the final test as listed below.

EUT Configure Mode	Available Channel	Tested Channel	Modulation Technology
-	0 to 50	1, 25, 50	ASK

Radiated Emission Test (Below 1 GHz):

- Pre-Scan has been conducted to determine the worst-case mode from all possible combinations between available modulations, data rates and antenna ports (if EUT with antenna diversity architecture).
- Following channel(s) was (were) selected for the final test as listed below.

EUT Configure Mode	Available Channel	Tested Channel	Modulation Technology
-	1 to 50	1, 25, 50	ASK

Power Line Conducted Emission Test:

- Pre-Scan has been conducted to determine the worst-case mode from all possible combinations between available modulations, data rates and antenna ports (if EUT with antenna diversity architecture).
- Following channel(s) was (were) selected for the final test as listed below.

EUT Configure Mode	Available Channel	Tested Channel	Modulation Technology
-	0 to 50	50	ASK

Antenna Port Conducted Measurement:

- This item includes all test value of each mode, but only includes spectrum plot of worst value of each mode.
- Pre-Scan has been conducted to determine the worst-case mode from all possible combinations between available modulations, data rates and antenna ports (if EUT with antenna diversity architecture).
- Following channel(s) was (were) selected for the final test as listed below.

EUT Configure Mode	Available Channel	Tested Channel	Modulation Technology
-	0 to 50	0, 62, 124	ASK

Test Condition:

Applicable To	Environmental Conditions	Input Power	Tested by
RE≥1G	25 deg. C, 65 % RH	120 Vac, 60 Hz	Getaz Yang
RE<1G	25 deg. C, 65 % RH	120 Vac, 60 Hz	Getaz Yang
PLC	25 deg. C, 65 % RH	120 Vac, 60 Hz	Anson Lin
APCM	25 deg. C, 65 % RH	3.8 Vdc	Anson Lin

3.3 Description of Support Units

The EUT has been tested as an independent unit together with other necessary accessories or support units.

3.3.1 Configuration of System under Test

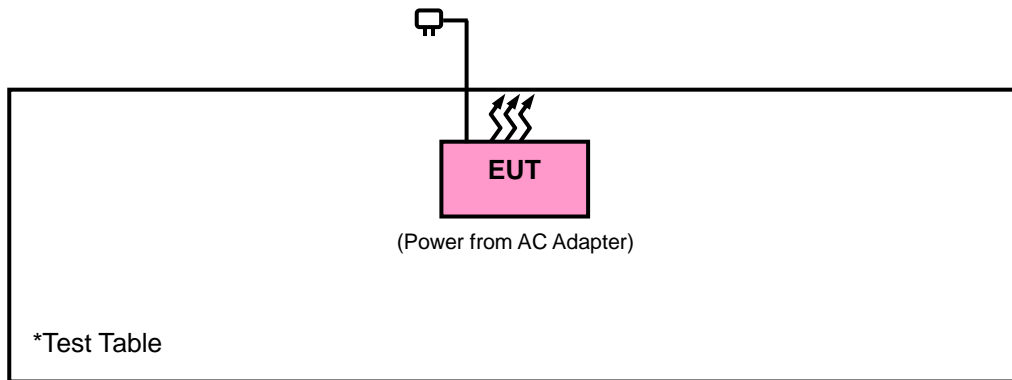

3.4 General Description of Applied Standards

The EUT is a RF Product. According to the specifications of the manufacturer, it must comply with the requirements of the following standards:

FCC Part 15, Subpart C (15.247)

FCC Public Notice DA 00-705

ANSI C63.10-2013

All test items have been performed and recorded as per the above standards.

NOTE: The EUT has been verified to comply with the requirements of FCC Part 15, Subpart B, Class B (DoC).
The test report has been issued separately.

4 Test Types and Results

4.1 Radiated Emission and Bandedge Measurement

4.1.1 Limits of Radiated Emission and Bandedge Measurement

Radiated emissions which fall in the restricted bands must comply with the radiated emission limits specified as below table. Other emissions shall be at least 20 dB below the highest level of the desired power:

Frequencies (MHz)	Field Strength (microvolts/meter)	Measurement Distance (meters)
0.009 ~ 0.490	2400/F (kHz)	300
0.490 ~ 1.705	24000/F (kHz)	30
1.705 ~ 30.0	30	30
30 ~ 88	100	3
88 ~ 216	150	3
216 ~ 960	200	3
Above 960	500	3

NOTE:

1. The lower limit shall apply at the transition frequencies.
2. Emission level (dBuV/m) = 20 log Emission level (uV/m).
3. For frequencies above 1000 MHz, the field strength limits are based on average detector, however, the peak field strength of any emission shall not exceed the maximum permitted average limits, specified above by more than 20 dB under any condition of modulation.

4.1.2 Test Instruments

Description & Manufacturer	Model No.	Serial No.	Date of Calibration	Due Date of Calibration
Test Receiver Agilent	N9038A	MY51210203	Feb. 17, 2017	Feb. 16, 2018
Spectrum Analyzer Agilent	N9010A	MY52220314	Dec. 16, 2016	Dec. 15, 2017
Spectrum Analyzer ROHDE & SCHWARZ	FSU43	101261	Dec. 13, 2016	Dec. 12, 2017
BILOG Antenna SCHWARZBECK	VULB9168	9168-472	Dec. 26, 2016	Dec. 25, 2017
HORN Antenna SCHWARZBECK	BBHA 9120 D	9120D-969	Dec. 12, 2016	Dec. 11, 2017
HORN Antenna SCHWARZBECK	BBHA 9170	9170-480	Dec. 14, 2016	Dec. 13, 2017
Loop Antenna	HLA 6121	45745	May 19, 2017	May 18, 2018
Preamplifier EMCI	EMC 012645	980115	Oct. 21, 2016	Oct. 20, 2017
Preamplifier EMCI	EMC 184045	980116	Oct. 21, 2016	Oct. 20, 2017
Preamplifier EMCI	EMC 330H	980112	Oct. 21, 2016	Oct. 20, 2017
Power Meter Anritsu	ML2495A	1232002	Sep. 08, 2016	Sep. 07, 2017
Power Sensor Anritsu	MA2411B	1207325	Sep. 08, 2016	Sep. 07, 2017
RF signal cable HUBER+SUHNNER	SUCOFLEX 104	309219/4 2950114	Oct. 21, 2016	Oct. 20, 2017
RF signal cable HUBER+SUHNNER	SUCOFLEX 104	250130/4	Oct. 21, 2016	Oct. 20, 2017
RF Coaxial Cable Worken	8D-FB	Cable-Ch10-01	Oct. 21, 2016	Oct. 20, 2017
Software BV ADT	E3 6.120103	NA	NA	NA
Antenna Tower MF	MFA-440H	NA	NA	NA
Turn Table MF	MFT-201SS	NA	NA	NA
Antenna Tower & Turn Table Controller MF	MF-7802	NA	NA	NA

- Note: 1. The calibration interval of the above test instruments is 12 months and the calibrations are traceable to NML/ROC and NIST/USA.
2. The test was performed in HwaYa Chamber 10.
3. The horn antenna and preamplifier (model: EMC 184045) are used only for the measurement of emission frequency above 1 GHz if tested.
4. The FCC Site Registration No. is 690701.
5. The IC Site Registration No. is IC7450F-10.

4.1.3 Test Procedures

- a. The EUT was placed on the top of a rotating table 0.8 meters (for below 1 GHz) / 1.5 meters (for above 1 GHz) above the ground at 3 meter chamber room for test. The table was rotated 360 degrees to determine the position of the highest radiation.
- b. The EUT was set 3 meters away from the interference-receiving antenna, which was mounted on the top of a variable-height antenna tower.
- c. The height of antenna is varied from one meter to four meters above the ground to determine the maximum value of the field strength. Both horizontal and vertical polarizations of the antenna are set to make the measurement.
- d. For each suspected emission, the EUT was arranged to its worst case and then the antenna was tuned to heights from 1 meter to 4 meters and the rotatable table was turned from 0 degrees to 360 degrees to find the maximum reading.
- e. The test-receiver system was set to quasi-peak detect function and specified bandwidth with maximum hold mode when the test frequency is below 1 GHz.
- f. The test-receiver system was set to peak and average detected function and specified bandwidth with maximum hold mode when the test frequency is above 1 GHz. If the peak reading value also meets average limit, measurement with the average detector is unnecessary.

Note:

1. The resolution bandwidth and video bandwidth of test receiver/spectrum analyzer is 120 kHz for Quasi-peak detection at frequency below 1 GHz.
2. The resolution bandwidth of test receiver/spectrum analyzer is 1 MHz and video bandwidth is 3 MHz for Peak detection at frequency above 1 GHz.
3. The resolution bandwidth of test receiver/spectrum analyzer is 1 MHz and the video bandwidth is $\geq 1/T$ (Duty cycle < 98 %) or 10 Hz (Duty cycle > 98 %) for Average detection (AV) at frequency above 1 GHz.
4. All modes of operation were investigated and the worst-case emissions are reported.

4.1.4 Deviation from Test Standard

No deviation.

4.1.5 Test Set Up

<Frequency Range below 1 GHz>

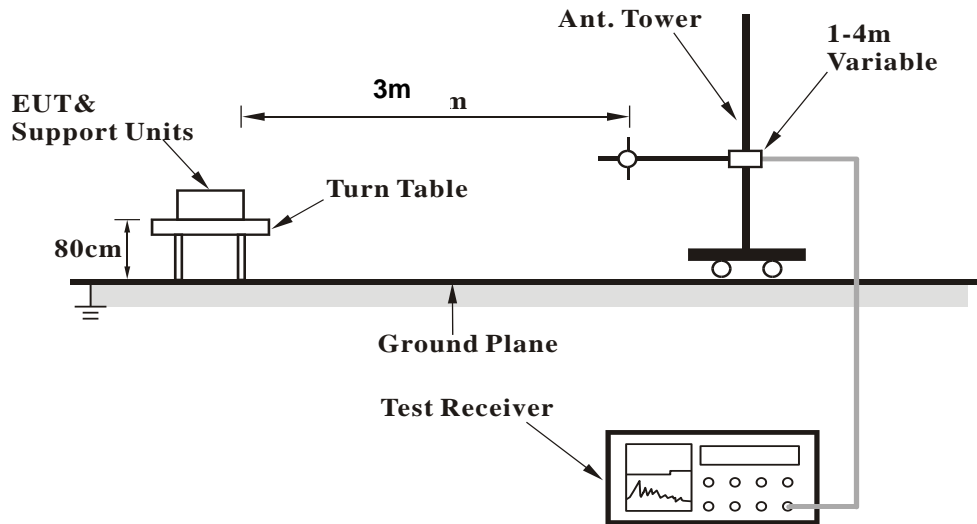

<Frequency Range above 1 GHz>

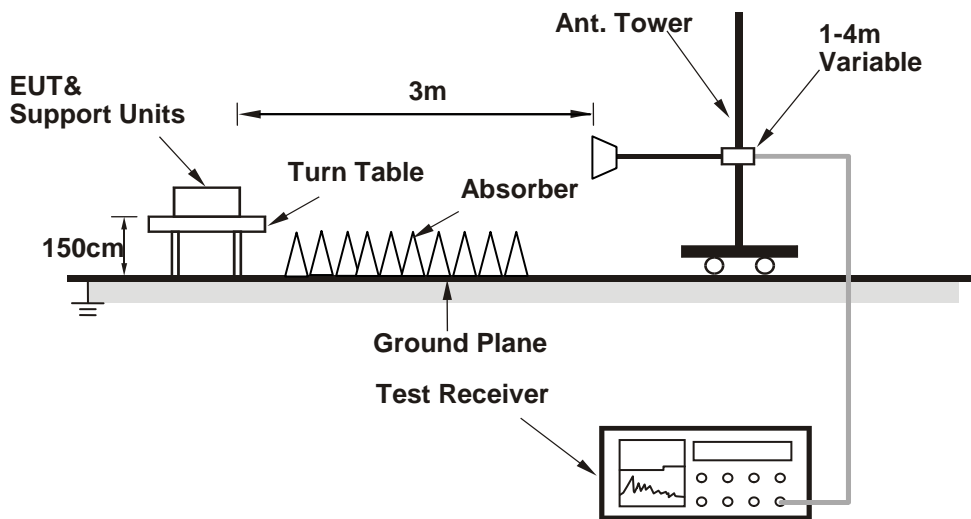

For the actual test configuration, please refer to the attached file (Test Setup Photo).

4.1.6 EUT Operating Conditions

Set the EUT under transmission condition continuously at specific channel frequency.

4.1.7 Test Results

ABOVE 1 GHz DATA :

EUT Test Condition		Measurement Detail	
Channel	Channel 1	Frequency Range	1 GHz ~ 25 GHz
Input Power	120 Vac, 60 Hz	Detector Function	Peak (PK) Average (AV)
Environmental Conditions	25 deg. C, 65 % RH	Tested By	Getaz Yang

Antenna Polarity & Test Distance: Horizontal at 3 m										
Frequency (MHz)	Emission Level (dBuV/m)	Read Level (dBuV)	Limit (dBuV/m)	Margin (dB)	Antenna Factor (dB/m)	Cable Loss (dB)	Preamp Factor (dB)	Antenna Height (cm)	Table Angle (Degree)	Remark
1805.5	37.88	61.53	54	-16.12	25.72	4.22	53.59	115	64	Average
1805.5	40.21	63.86	74	-33.79	25.72	4.22	53.59	115	64	Peak
2708.25	45.63	66.26	54	-8.37	27.72	5.14	53.49	130	253	Average
2708.25	50.23	70.86	74	-23.77	27.72	5.14	53.49	130	253	Peak
3611	36.33	55.5	54	-17.67	28.99	5.88	54.04	148	75	Average
3611	41.07	60.24	74	-32.93	28.99	5.88	54.04	148	75	Peak

Antenna Polarity & Test Distance: Vertical at 3 m										
Frequency (MHz)	Emission Level (dBuV/m)	Read Level (dBuV)	Limit (dBuV/m)	Margin (dB)	Antenna Factor (dB/m)	Cable Loss (dB)	Preamp Factor (dB)	Antenna Height (cm)	Table Angle (Degree)	Remark
1805.5	33.85	57.5	54	-20.15	25.72	4.22	53.59	129	219	Average
1805.5	38.43	62.08	74	-35.57	25.72	4.22	53.59	129	219	Peak
2708.25	45.81	66.44	54	-8.19	27.72	5.14	53.49	133	251	Average
2708.25	50.41	71.04	74	-23.59	27.72	5.14	53.49	133	251	Peak
3611	34.26	53.43	54	-19.74	28.99	5.88	54.04	118	181	Average
3611	39.75	58.92	74	-34.25	28.99	5.88	54.04	118	181	Peak

Remarks:

- Emission Level = Read Level + Antenna Factor + Cable Loss - Preamp Factor
Margin value = Emission level – Limit value

EUT Test Condition		Measurement Detail	
Channel	Channel 25	Frequency Range	1 GHz ~ 25 GHz
Input Power	120 Vac, 60 Hz	Detector Function	Peak (PK) Average (AV)
Environmental Conditions	25 deg. C, 65 % RH	Tested By	Getaz Yang

Antenna Polarity & Test Distance: Horizontal at 3 m										
Frequency (MHz)	Emission Level (dBuV/m)	Read Level (dBuV)	Limit (dBuV/m)	Margin (dB)	Antenna Factor (dB/m)	Cable Loss (dB)	Preamp Factor (dB)	Antenna Height (cm)	Table Angle (Degree)	Remark
1829.5	39.25	62.87	54	-14.75	25.73	4.25	53.6	132	264	Average
1829.5	40.84	64.46	74	-33.16	25.73	4.25	53.6	132	264	Peak
2744.25	50.17	70.68	54	-3.83	27.85	5.18	53.54	148	92	Average
2744.25	54.77	75.28	74	-19.23	27.85	5.18	53.54	148	92	Peak
3659	36	54.97	54	-18	29.05	5.95	53.97	132	341	Average
3659	41	59.97	74	-33	29.05	5.95	53.97	132	341	Peak
Antenna Polarity & Test Distance: Vertical at 3 m										
Frequency (MHz)	Emission Level (dBuV/m)	Read Level (dBuV)	Limit (dBuV/m)	Margin (dB)	Antenna Factor (dB/m)	Cable Loss (dB)	Preamp Factor (dB)	Antenna Height (cm)	Table Angle (Degree)	Remark
1829.5	36.79	60.41	54	-17.21	25.73	4.25	53.6	115	246	Average
1829.5	40.77	64.39	74	-33.23	25.73	4.25	53.6	115	246	Peak
2744.25	50.56	71.07	54	-3.44	27.85	5.18	53.54	113	287	Average
2744.25	55.16	75.67	74	-18.84	27.85	5.18	53.54	113	287	Peak
3659	36.48	55.45	54	-17.52	29.05	5.95	53.97	105	303	Average
3659	41.63	60.6	74	-32.37	29.05	5.95	53.97	105	303	Peak

Remarks:

- Emission Level = Read Level + Antenna Factor + Cable Loss - Preamp Factor
Margin value = Emission level – Limit value

EUT Test Condition		Measurement Detail	
Channel	Channel 50	Frequency Range	1 GHz ~ 25 GHz
Input Power	120 Vac, 60 Hz	Detector Function	Peak (PK) Average (AV)
Environmental Conditions	25 deg. C, 65 % RH	Tested By	Getaz Yang

Antenna Polarity & Test Distance: Horizontal at 3 m										
Frequency (MHz)	Emission Level (dBuV/m)	Read Level (dBuV)	Limit (dBuV/m)	Margin (dB)	Antenna Factor (dB/m)	Cable Loss (dB)	Preamp Factor (dB)	Antenna Height (cm)	Table Angle (Degree)	Remark
1854.5	33.5	57.43	54	-20.5	25.74	4.28	53.95	139	270	Average
1854.5	37.59	61.52	74	-36.41	25.74	4.28	53.95	139	270	Peak
2781.75	50.75	71.59	54	-3.25	27.94	5.23	54.01	192	63	Average
2781.75	55.36	76.2	74	-18.64	27.94	5.23	54.01	192	63	Peak
3709	35.78	54.74	54	-18.22	29.13	6.01	54.1	106	90	Average
3709	41.74	60.7	74	-32.26	29.13	6.01	54.1	106	90	Peak
Antenna Polarity & Test Distance: Vertical at 3 m										
Frequency (MHz)	Emission Level (dBuV/m)	Read Level (dBuV)	Limit (dBuV/m)	Margin (dB)	Antenna Factor (dB/m)	Cable Loss (dB)	Preamp Factor (dB)	Antenna Height (cm)	Table Angle (Degree)	Remark
1854.5	33.91	57.84	54	-20.09	25.74	4.28	53.95	129	318	Average
1854.5	38.34	62.27	74	-35.66	25.74	4.28	53.95	129	318	Peak
2781.75	50.38	71.22	54	-3.62	27.94	5.23	54.01	105	227	Average
2781.75	54.99	75.83	74	-19.01	27.94	5.23	54.01	105	227	Peak
3709	36.58	55.54	54	-17.42	29.13	6.01	54.1	100	264	Average
3709	41.7	60.66	74	-32.3	29.13	6.01	54.1	100	264	Peak

Remarks:

- Emission Level = Read Level + Antenna Factor + Cable Loss - Preamp Factor
Margin value = Emission level – Limit value

30 MHz ~ 1 GHz WORST-CASE DATA:

EUT Test Condition		Measurement Detail	
Channel	Channel 1	Frequency Range	30 MHz ~ 1 GHz
Input Power	120 Vac, 60 Hz	Detector Function	Peak (PK) Quasi-peak (QP)
Environmental Conditions	25 deg. C, 65 % RH	Tested By	Getaz Yang

Antenna Polarity & Test Distance: Horizontal at 3 m										
Frequency (MHz)	Emission Level (dBuV/m)	Read Level (dBuV)	Limit (dBuV/m)	Margin (dB)	Antenna Factor (dB/m)	Cable Loss (dB)	Preamp Factor (dB)	Antenna Height (cm)	Table Angle (Degree)	Remark
902	35.44	39.89	84.23	-48.79	23.52	4.05	32.02	130	354	QP
902	52.01	56.46	88.84	-36.83	23.52	4.05	32.02	130	354	Peak
902.75	104.23	108.67	-----	-----	23.53	4.05	32.02	130	354	QP
902.75	108.84	113.28	-----	-----	23.53	4.05	32.02	130	354	Peak
Antenna Polarity & Test Distance: Vertical at 3 m										
Frequency (MHz)	Emission Level (dBuV/m)	Read Level (dBuV)	Limit (dBuV/m)	Margin (dB)	Antenna Factor (dB/m)	Cable Loss (dB)	Preamp Factor (dB)	Antenna Height (cm)	Table Angle (Degree)	Remark
902	37.92	42.37	84.21	-46.29	23.52	4.05	32.02	119	358	QP
902	59.3	63.75	88.82	-29.52	23.52	4.05	32.02	119	358	Peak
902.75	104.21	108.65	-----	-----	23.53	4.05	32.02	119	358	QP
902.75	108.82	113.26	-----	-----	23.53	4.05	32.02	119	358	Peak

Remarks:

- Emission Level = Read Level + Antenna Factor + Cable Loss - Preamp Factor
Margin value = Emission level – Limit value

EUT Test Condition		Measurement Detail	
Channel	Channel 25	Frequency Range	30 MHz ~ 1 GHz
Input Power	120 Vac, 60 Hz	Detector Function	Peak (PK) Quasi-peak (QP)
Environmental Conditions	25 deg. C, 65 % RH	Tested By	Getaz Yang

Antenna Polarity & Test Distance: Horizontal at 3 m										
Frequency (MHz)	Emission Level (dBuV/m)	Read Level (dBuV)	Limit (dBuV/m)	Margin (dB)	Antenna Factor (dB/m)	Cable Loss (dB)	Preamp Factor (dB)	Antenna Height (cm)	Table Angle (Degree)	Remark
914.75	104.28	108.61	-----	-----	23.59	4.11	32.03	132	342	QP
914.75	108.87	113.2	-----	-----	23.59	4.11	32.03	132	342	Peak
Antenna Polarity & Test Distance: Vertical at 3 m										
Frequency (MHz)	Emission Level (dBuV/m)	Read Level (dBuV)	Limit (dBuV/m)	Margin (dB)	Antenna Factor (dB/m)	Cable Loss (dB)	Preamp Factor (dB)	Antenna Height (cm)	Table Angle (Degree)	Remark
914.75	104.27	108.6	-----	-----	23.59	4.11	32.03	120	355	QP
914.75	108.86	113.19	-----	-----	23.59	4.11	32.03	120	355	Peak

Remarks:

- Emission Level = Read Level + Antenna Factor + Cable Loss - Preamp Factor
Margin value = Emission level – Limit value

EUT Test Condition		Measurement Detail	
Channel	Channel 50	Frequency Range	30 MHz ~ 1 GHz
Input Power	120 Vac, 60 Hz	Detector Function	Peak (PK) Quasi-peak (QP)
Environmental Conditions	25 deg. C, 65 % RH	Tested By	Getaz Yang

Antenna Polarity & Test Distance: Horizontal at 3 m										
Frequency (MHz)	Emission Level (dBuV/m)	Read Level (dBuV)	Limit (dBuV/m)	Margin (dB)	Antenna Factor (dB/m)	Cable Loss (dB)	Preamp Factor (dB)	Antenna Height (cm)	Table Angle (Degree)	Remark
927.25	104.32	108.5	-----	-----	23.66	4.15	31.99	141	330	QP
927.25	108.92	113.1	-----	-----	23.66	4.15	31.99	141	330	Peak
928	30.95	35.11	84.32	-53.37	23.67	4.16	31.99	141	330	QP
928	55.8	59.96	88.92	-33.12	23.67	4.16	31.99	141	330	Peak
Antenna Polarity & Test Distance: Vertical at 3 m										
Frequency (MHz)	Emission Level (dBuV/m)	Read Level (dBuV)	Limit (dBuV/m)	Margin (dB)	Antenna Factor (dB/m)	Cable Loss (dB)	Preamp Factor (dB)	Antenna Height (cm)	Table Angle (Degree)	Remark
927.25	104.3	108.48	-----	-----	23.66	4.15	31.99	116	350	QP
927.25	108.9	113.08	-----	-----	23.66	4.15	31.99	116	350	Peak
928	36.48	40.64	84.3	-47.82	23.67	4.16	31.99	116	350	QP
928	57.32	61.48	88.9	-31.58	23.67	4.16	31.99	116	350	Peak

Remarks:

- Emission Level = Read Level + Antenna Factor + Cable Loss - Preamp Factor
Margin value = Emission level – Limit value

EUT Test Condition		Measurement Detail	
Channel	Channel 1	Frequency Range	30 MHz ~ 1 GHz
Input Power	120 Vac, 60 Hz	Detector Function	Peak (PK) Quasi-peak (QP)
Environmental Conditions	25 deg. C, 65 % RH	Tested By	Getaz Yang

Antenna Polarity & Test Distance: Horizontal at 3 m										
Frequency (MHz)	Emission Level (dBuV/m)	Read Level (dBuV)	Limit (dBuV/m)	Margin (dB)	Antenna Factor (dB/m)	Cable Loss (dB)	Preamp Factor (dB)	Antenna Height (cm)	Table Angle (Degree)	Remark
72.68	28.89	49.93	40	-11.11	10.05	0.65	31.74	127	135	Peak
121.18	40.55	60.51	43.5	-2.95	11.09	0.85	31.9	132	241	Peak
169.68	34.03	52.93	43.5	-9.47	11.76	1.07	31.73	126	207	Peak
250.19	30.18	49.17	46	-15.82	11.48	1.47	31.94	136	288	Peak
291.9	28.18	45.54	46	-17.82	12.71	1.63	31.7	108	141	Peak
646.92	32.23	41	46	-13.77	20.17	3.1	32.04	145	79	Peak
Antenna Polarity & Test Distance: Vertical at 3 m										
Frequency (MHz)	Emission Level (dBuV/m)	Read Level (dBuV)	Limit (dBuV/m)	Margin (dB)	Antenna Factor (dB/m)	Cable Loss (dB)	Preamp Factor (dB)	Antenna Height (cm)	Table Angle (Degree)	Remark
68.8	33.41	53.66	40	-6.59	10.89	0.63	31.77	132	315	Peak
121.18	38.38	58.34	43.5	-5.12	11.09	0.85	31.9	104	216	Peak
169.68	38.2	57.1	43.5	-5.3	11.76	1.07	31.73	123	140	Peak
220.12	31.7	51.86	46	-14.3	10.22	1.33	31.71	109	15	Peak
294.81	22.22	39.55	46	-23.78	12.8	1.63	31.76	120	305	Peak
646.92	32.39	41.16	46	-13.61	20.17	3.1	32.04	105	224	Peak

Remarks:

- Emission Level = Read Level + Antenna Factor + Cable Loss - Preamp Factor
Margin value = Emission level – Limit value

EUT Test Condition		Measurement Detail	
Channel	Channel 25	Frequency Range	30 MHz ~ 1 GHz
Input Power	120 Vac, 60 Hz	Detector Function	Peak (PK) Quasi-peak (QP)
Environmental Conditions	25 deg. C, 65 % RH	Tested By	Getaz Yang

Antenna Polarity & Test Distance: Horizontal at 3 m										
Frequency (MHz)	Emission Level (dBuV/m)	Read Level (dBuV)	Limit (dBuV/m)	Margin (dB)	Antenna Factor (dB/m)	Cable Loss (dB)	Preamp Factor (dB)	Antenna Height (cm)	Table Angle (Degree)	Remark
72.68	28.97	50.01	40	-11.03	10.05	0.65	31.74	111	168	Peak
113.42	40.47	61.15	43.5	-3.03	10.37	0.81	31.86	104	97	Peak
169.68	34.14	53.04	43.5	-9.36	11.76	1.07	31.73	140	4	Peak
206.54	31.02	51.77	43.5	-12.48	9.65	1.26	31.66	108	253	Peak
252.13	30.65	49.56	46	-15.35	11.54	1.47	31.92	104	118	Peak
291.9	28.31	45.67	46	-17.69	12.71	1.63	31.7	132	264	Peak
Antenna Polarity & Test Distance: Vertical at 3 m										
Frequency (MHz)	Emission Level (dBuV/m)	Read Level (dBuV)	Limit (dBuV/m)	Margin (dB)	Antenna Factor (dB/m)	Cable Loss (dB)	Preamp Factor (dB)	Antenna Height (cm)	Table Angle (Degree)	Remark
36.79	30.44	47.9	40	-9.56	13.09	0.48	31.03	114	216	Peak
68.8	33.74	53.99	40	-6.26	10.89	0.63	31.77	120	94	Peak
113.42	38.32	59	43.5	-5.18	10.37	0.81	31.86	127	171	Peak
169.68	39.44	58.34	43.5	-4.06	11.76	1.07	31.73	118	181	Peak
210.42	30.55	51.05	43.5	-12.95	9.81	1.28	31.59	129	219	Peak
646.92	32.39	41.16	46	-13.61	20.17	3.1	32.04	109	133	Peak

Remarks:

- Emission Level = Read Level + Antenna Factor + Cable Loss - Preamp Factor
Margin value = Emission level – Limit value

EUT Test Condition		Measurement Detail	
Channel	Channel 50	Frequency Range	30 MHz ~ 1 GHz
Input Power	120 Vac, 60 Hz	Detector Function	Peak (PK) Quasi-peak (QP)
Environmental Conditions	25 deg. C, 65 % RH	Tested By	Getaz Yang

Antenna Polarity & Test Distance: Horizontal at 3 m										
Frequency (MHz)	Emission Level (dBuV/m)	Read Level (dBuV)	Limit (dBuV/m)	Margin (dB)	Antenna Factor (dB/m)	Cable Loss (dB)	Preamp Factor (dB)	Antenna Height (cm)	Table Angle (Degree)	Remark
75.59	27.74	49.4	40	-12.26	9.33	0.66	31.65	133	337	Peak
119.24	40.45	60.57	43.5	-3.05	10.93	0.84	31.89	117	125	Peak
169.68	33.16	52.06	43.5	-10.34	11.76	1.07	31.73	112	220	Peak
206.54	31.41	52.16	43.5	-12.09	9.65	1.26	31.66	119	168	Peak
292.87	28.5	45.85	46	-17.5	12.74	1.63	31.72	136	171	Peak
646.92	32.66	41.43	46	-13.34	20.17	3.1	32.04	111	268	Peak

Antenna Polarity & Test Distance: Vertical at 3 m										
Frequency (MHz)	Emission Level (dBuV/m)	Read Level (dBuV)	Limit (dBuV/m)	Margin (dB)	Antenna Factor (dB/m)	Cable Loss (dB)	Preamp Factor (dB)	Antenna Height (cm)	Table Angle (Degree)	Remark
36.79	30.96	48.42	40	-9.04	13.09	0.48	31.03	119	331	Peak
69.77	32.93	53.34	40	-7.07	10.77	0.64	31.82	117	107	Peak
114.39	38.37	58.97	43.5	-5.13	10.46	0.81	31.87	119	61	Peak
169.68	38.92	57.82	43.5	-4.58	11.76	1.07	31.73	139	89	Peak
220.12	32.26	52.42	46	-13.74	10.22	1.33	31.71	107	219	Peak
646.92	30.98	39.75	46	-15.02	20.17	3.1	32.04	136	334	Peak

Remarks:

- Emission Level = Read Level + Antenna Factor + Cable Loss - Preamp Factor
Margin value = Emission level – Limit value

4.2 Conducted Emission Measurement

4.2.1 Limits of Conducted Emission Measurement

Frequency (MHz)	Conducted Limit (dBuV)	
	Quasi-peak	Average
0.15 - 0.5	66 - 56	56 - 46
0.50 - 5.0	56	46
5.0 - 30.0	60	50

- Note: 1. The lower limit shall apply at the transition frequencies.
 2. The limit decreases in line with the logarithm of the frequency in the range of 0.15 to 0.50 MHz.
 3. All emanations from a class A/B digital device or system, including any network of conductors and apparatus connected thereto, shall not exceed the level of field strengths specified above.

4.2.2 Test Instruments

Description & Manufacturer	Model No.	Serial No.	Date Of Calibration	Due Date Of Calibration
Test Receiver ROHDE & SCHWARZ	ESCI	100613	Nov. 21, 2016	Nov. 20, 2017
RF signal cable (with 10dB PAD) Woken	5D-FB	Cable-cond1-01	Dec. 22, 2016	Dec. 21, 2017
LISN/AMN ROHDE & SCHWARZ (EUT)	ESH3-Z5	835239/001	Mar. 10, 2017	Mar. 09, 2018
LISN/AMN ROHDE & SCHWARZ (Peripheral)	ENV216	101196	Apr. 20, 2017	Apr. 19, 2018
Software ADT	BV ADT_Cond_ V7.3.7.3	NA	NA	NA

- Note: 1. The calibration interval of the above test instruments is 12 months and the calibrations are traceable to NML/ROC and NIST/USA.
 2. The test was performed in HwaYa Shielded Room 1.
 3. The VCCI Site Registration No. is C-2040.

4.2.3 Test Procedures

- a. The EUT was placed 0.4 meters from the conducting wall of the shielded room with EUT being connected to the power mains through a line impedance stabilization network (LISN). Other support units were connected to the power mains through another LISN. The two LISNs provide 50 ohm/ 50 uH of coupling impedance for the measuring instrument.
- b. Both lines of the power mains connected to the EUT were checked for maximum conducted interference.
- c. The frequency range from 150 kHz to 30 MHz was searched. Emission levels under (Limit – 20 dB) was not recorded.

NOTE: All modes of operation were investigated and the worst-case emissions are reported.

4.2.4 Deviation from Test Standard

No deviation.

4.2.5 Test Setup

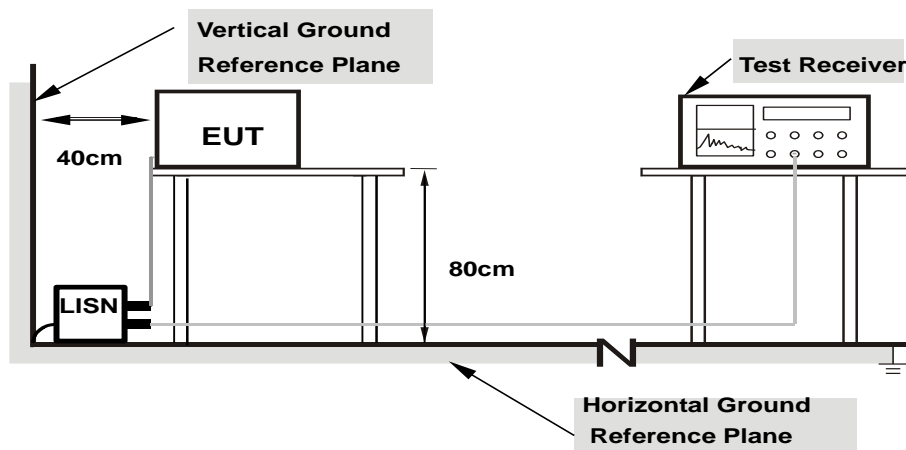

- Note:**
1. Support units were connected to second LISN.
 2. Both of LISNs (AMN) are 80 cm from EUT and at least 80 cm from other units and other metal planes

For the actual test configuration, please refer to the attached file (Test Setup Photo).

4.2.6 EUT Operating Condition

Set the EUT under transmission condition continuously at specific channel frequency.

4.2.7 Test Results

Frequency Range	150kHz ~ 30MHz	Detector Function & Resolution Bandwidth	Quasi-Peak (QP) / Average (AV), 9kHz
Input Power	120Vac, 60Hz	Environmental Conditions	25°C, 64%RH
Tested by	Han Wu	Test Date	2017/8/15

Phase Of Power : Line (L)										
No	Frequency (MHz)	Correction Factor (dB)	Reading Value (dBuV)		Emission Level (dBuV)		Limit (dBuV)		Margin (dB)	
			Q.P.	AV.	Q.P.	AV.	Q.P.	AV.	Q.P.	AV.
1	0.20783	10.37	26.16	20.24	36.53	30.61	63.29	53.29	-26.76	-22.68
2	0.36239	10.39	25.26	18.99	35.65	29.38	58.67	48.67	-23.02	-19.29
3	4.27505	10.58	16.46	9.75	27.04	20.33	56.00	46.00	-28.96	-25.67
4	8.26946	10.76	12.33	6.52	23.09	17.28	60.00	50.00	-36.91	-32.72
5	12.59162	10.96	9.74	4.42	20.70	15.38	60.00	50.00	-39.30	-34.62
6	20.63840	11.38	11.70	5.23	23.08	16.61	60.00	50.00	-36.92	-33.39

Remarks:

1. Q.P. and AV. are abbreviations of quasi-peak and average individually.
2. The emission levels of other frequencies were very low against the limit.
3. Margin value = Emission level – Limit value
4. Correction factor = Insertion loss + Cable loss
5. Emission Level = Correction Factor + Reading Value

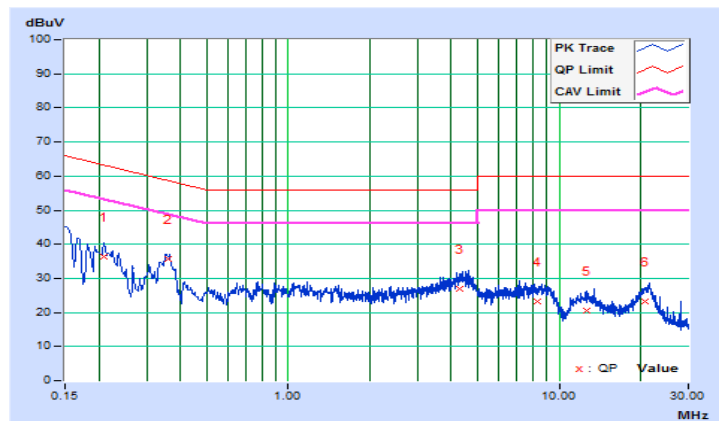

Frequency Range	150kHz ~ 30MHz	Detector Function & Resolution Bandwidth	Quasi-Peak (QP) / Average (AV), 9kHz
Input Power	120Vac, 60Hz	Environmental Conditions	25°C, 64%RH
Tested by	Han Wu	Test Date	2017/8/15

Phase Of Power : Neutral (N)										
No	Frequency (MHz)	Correction Factor (dB)	Reading Value (dBuV)		Emission Level (dBuV)		Limit (dBuV)		Margin (dB)	
			Q.P.	AV.	Q.P.	AV.	Q.P.	AV.	Q.P.	AV.
1	0.23277	10.14	25.03	17.73	35.17	27.87	62.35	52.35	-27.18	-24.48
2	0.34651	10.15	25.62	14.46	35.77	24.61	59.05	49.05	-23.28	-24.44
3	0.78840	10.17	10.16	3.51	20.33	13.68	56.00	46.00	-35.67	-32.32
4	2.16281	10.24	15.64	9.22	25.88	19.46	56.00	46.00	-30.12	-26.54
5	4.66831	10.36	18.69	11.49	29.05	21.85	56.00	46.00	-26.95	-24.15
6	20.68141	10.98	9.28	2.80	20.26	13.78	60.00	50.00	-39.74	-36.22

Remarks:

1. Q.P. and AV. are abbreviations of quasi-peak and average individually.
2. The emission levels of other frequencies were very low against the limit.
3. Margin value = Emission level – Limit value
4. Correction factor = Insertion loss + Cable loss
5. Emission Level = Correction Factor + Reading Value

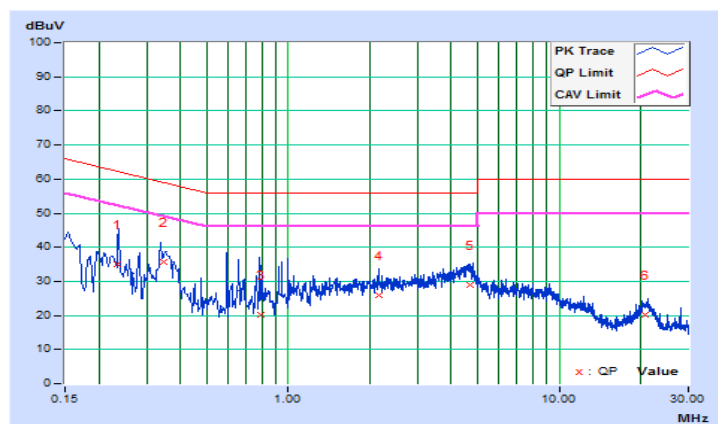

4.3 Number of Hopping Frequency Used

4.3.1 Limits of Hopping Frequency Used Measurement

At least 15 channels frequencies, and should be equally spaced.

4.3.2 Test Setup

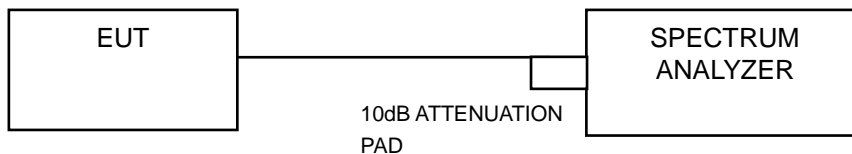

4.3.3 Test Instruments

Refer to section 4.1.2 to get information of above instrument.

4.3.4 Test Procedure

- a. Check the calibration of the measuring instrument (SA) using either an internal calibrator or a known signal from an external generator.
- b. Turn on the EUT and connect its antenna terminal to measurement via a low loss cable. Then set it to any one measured frequency within its operating range and make sure the instrument is operated in its linear range.
- c. Set the SA on MaxHold Mode, and then keep the EUT in hopping mode. Record all the signals from each channel until each one has been recorded.
- d. Set the SA on View mode and then plot the result on SA screen.
- e. Repeat above procedures until all frequencies measured were complete.

4.3.5 Deviation from Test Standard

No deviation.

4.3.6 Test Results

There are 50 hopping frequencies in the hopping mode. Please refer to next page for the test result. On the plots, it shows that the hopping frequencies are equally spaced.

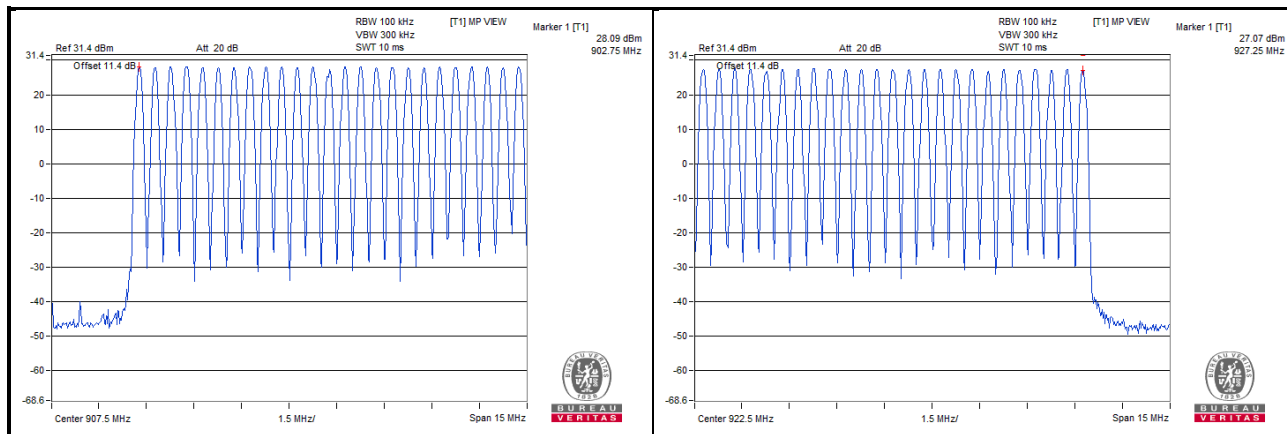

4.4 Dwell Time on Each Channel

4.4.1 Limits of Dwell Time on Each Channel Measurement

The average time of occupancy on any channel shall not be greater than 0.4 seconds within a period of 0.4 seconds multiplied by the number of hopping channels employed.

4.4.2 Test Setup

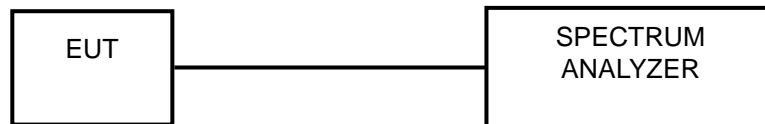

4.4.3 Test Instruments

Refer to section 4.1.2 to get information of above instrument.

4.4.4 Test Procedures

- a. Check the calibration of the measuring instrument (SA) using either an internal calibrator or a known signal from an external generator.
- b. Turn on the EUT and connect its antenna terminal to measurement via a low loss cable. Then set it to any one measured frequency within its operating range and make sure the instrument is operated in its linear range.
- c. Adjust the center frequency of SA on any frequency be measured and set SA to zero span mode. And then, set RBW and VBW of spectrum analyzer to proper value.
- d. Measure the time duration of one transmission on the measured frequency. And then plot the result with time difference of this time duration.
- e. Repeat above procedures until all different time-slot modes have been completed.

4.4.5 Deviation from Test Standard

No deviation.

4.4.6 Test Results

Average Hopping Channel	Package Transfer Time (usec)	Result (sec)	Limit (sec)
0.10	17.40	0.035	0.4

NOTE:

1. Test plots of the transmitting time slot are shown as below.

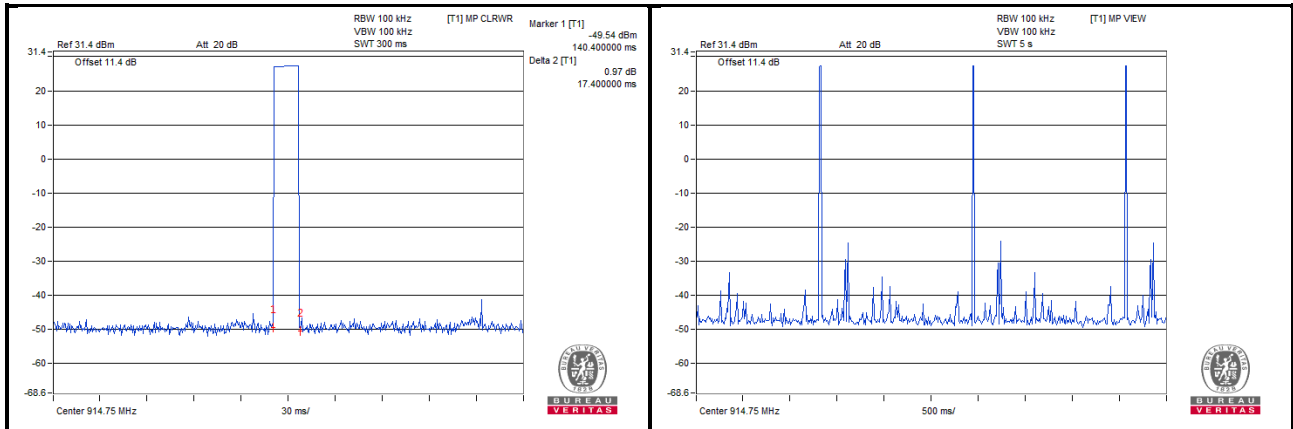

4.5 Channel Bandwidth

4.5.1 Limits of Channel Bandwidth Measurement

The 20 dB bandwidth of the hopping channel shall be less than 250 kHz.

4.5.2 Test Setup

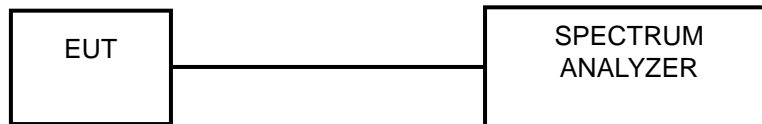

4.5.3 Test Instruments

Refer to section 4.1.2 to get information of above instrument.

4.5.4 Test Procedure

- Check the calibration of the measuring instrument using either an internal calibrator or a known signal from an external generator.
- Turn on the EUT and connect it to measurement instrument. Then set it to any one convenient frequency within its operating range. Set a reference level on the measuring instrument equal to the highest peak value.
- Measure the frequency difference of two frequencies that were attenuated 20 dB from the reference level. Record the frequency difference as the emission bandwidth.
- Repeat above procedures until all frequencies measured were complete.

4.5.5 Deviation from Test Standard

No deviation.

4.5.6 EUT Operating Condition

The software provided by client enabled the EUT to transmit and receive data at lowest, middle and highest channel frequencies individually.

4.5.7 Test Results

Channel	Frequency (MHz)	20 dB Bandwidth (kHz)	Limiti (kHz)
1	902.75	50	250
25	914.75	50	250
50	927.25	60	250

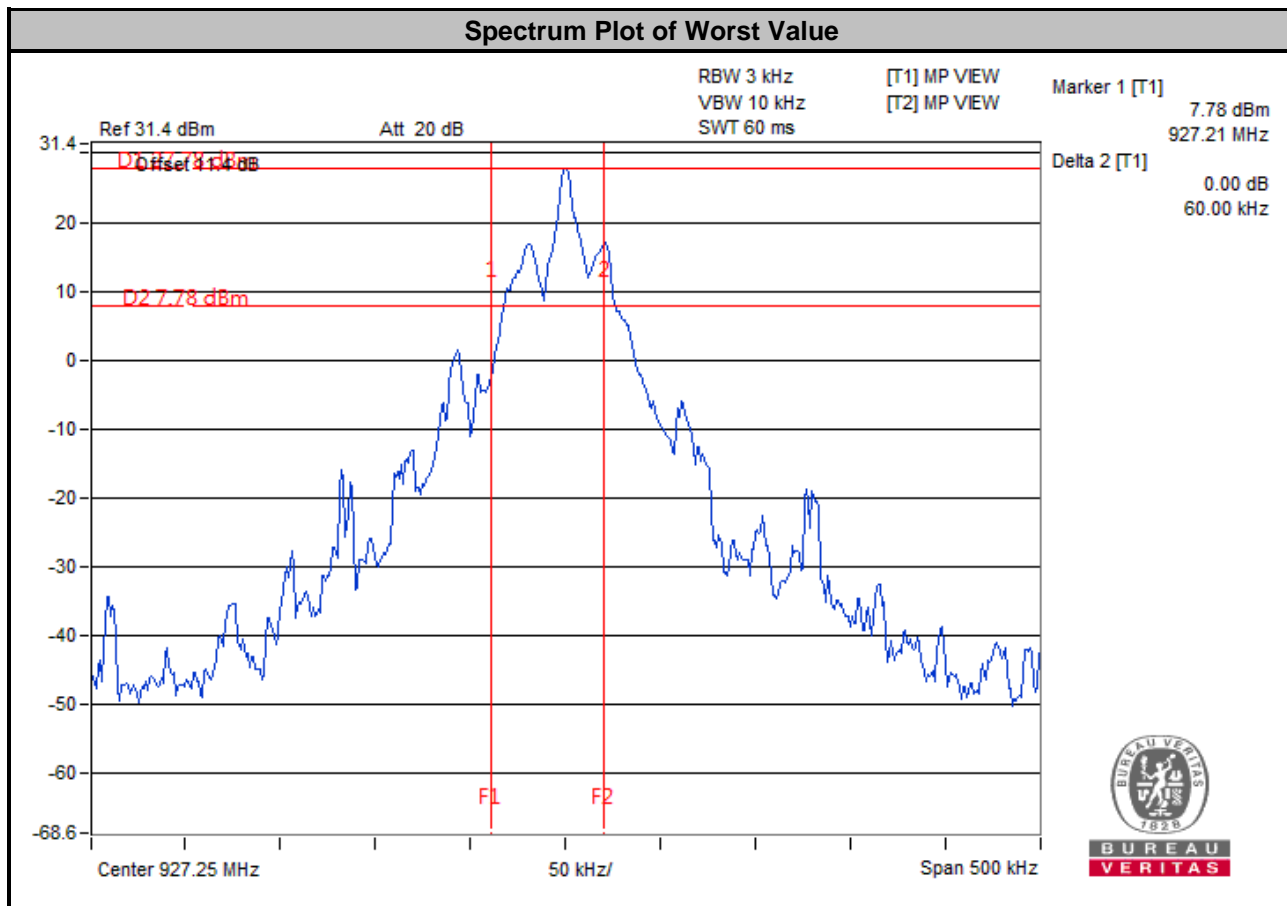

4.6 Occupied Bandwidth Measurement

4.6.1 Test Setup

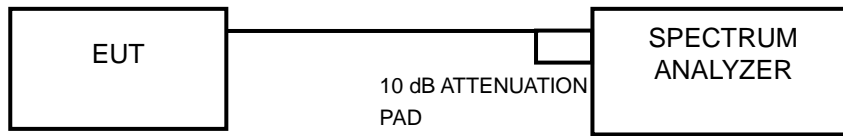

4.6.2 Test Instruments

Refer to section 4.1.2 to get information of above instrument

4.6.3 Test Procedure

The transmitter output was connected to the spectrum analyzer through an attenuator. The bandwidth of the fundamental frequency was measured by spectrum analyzer with resolution bandwidth in the range of 1 % to 5 % of the anticipated emission bandwidth, and a video bandwidth at least 3x the resolution bandwidth and set the detector to PEAK. The width of a frequency band such that, below the lower and above the upper frequency limits, the mean powers emitted are each equal to a specified percentage 0.5 % of the total mean power of a given emission.

4.6.4 Deviation from Test Standard

No deviation.

4.6.5 EUT Operating Conditions

The software provided by client to enable the EUT under transmission condition continuously at lowest, middle and highest channel frequencies individually.

4.6.6 Test Results

Channel	Frequency (MHz)	Occupied Bandwidth (kHz)
1	902.75	60
25	914.75	60
50	927.25	60

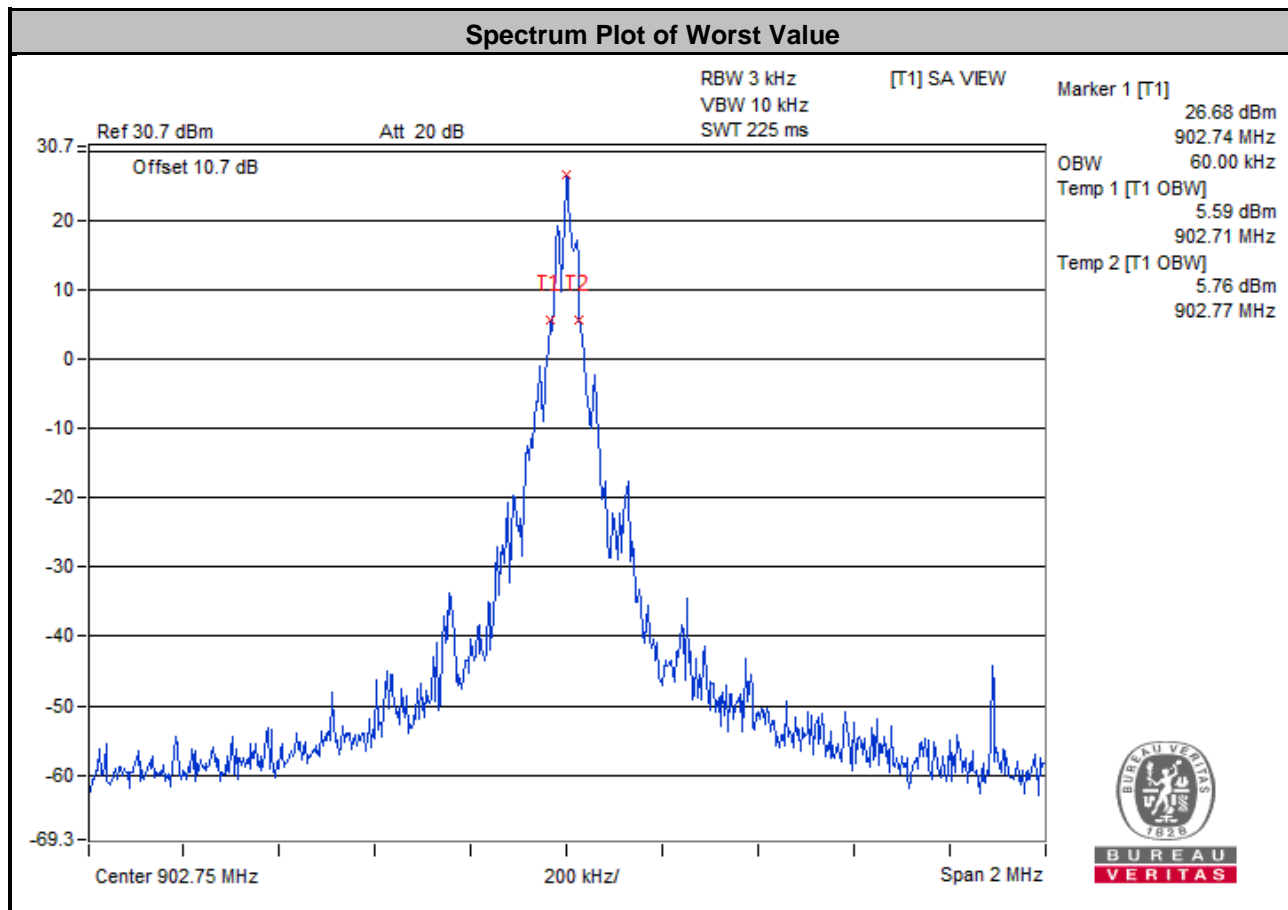

4.7 Hopping Channel Separation

4.7.1 Limits of Hopping Channel Separation Measurement

At least 25 kHz or two-third of 20 dB hopping channel bandwidth (whichever is greater).

4.7.2 Test Setup

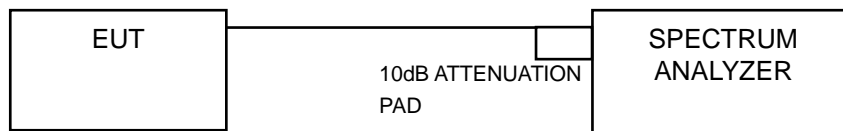

4.7.3 Test Instruments

Refer to section 4.1.2 to get information of above instrument.

4.7.4 Test Procedure

- Check the calibration of the measuring instrument using either an internal calibrator or a known signal from an external generator.
- Turn on the EUT and connect it to measurement instrument. Then set it to any one convenient frequency within its operating range.
- By using the MaxHold function record the separation of two adjacent channels.
- Measure the frequency difference of these two adjacent channels by SA MARK function. And then plot the result on SA screen.
- Repeat above procedures until all frequencies measured were complete.

4.7.5 Deviation from Test Standard

No deviation.

4.7.6 Test Results

Channel	Freq. (MHz)	Adjacent Channel Separation (MHz)	20 dB Bandwidth (kHz)	Minimum Limit (MHz)	Pass / Fail
1	902.75	500	50	33.33	Pass
25	914.75	503	50	33.33	Pass
50	927.25	505	60	40.00	Pass

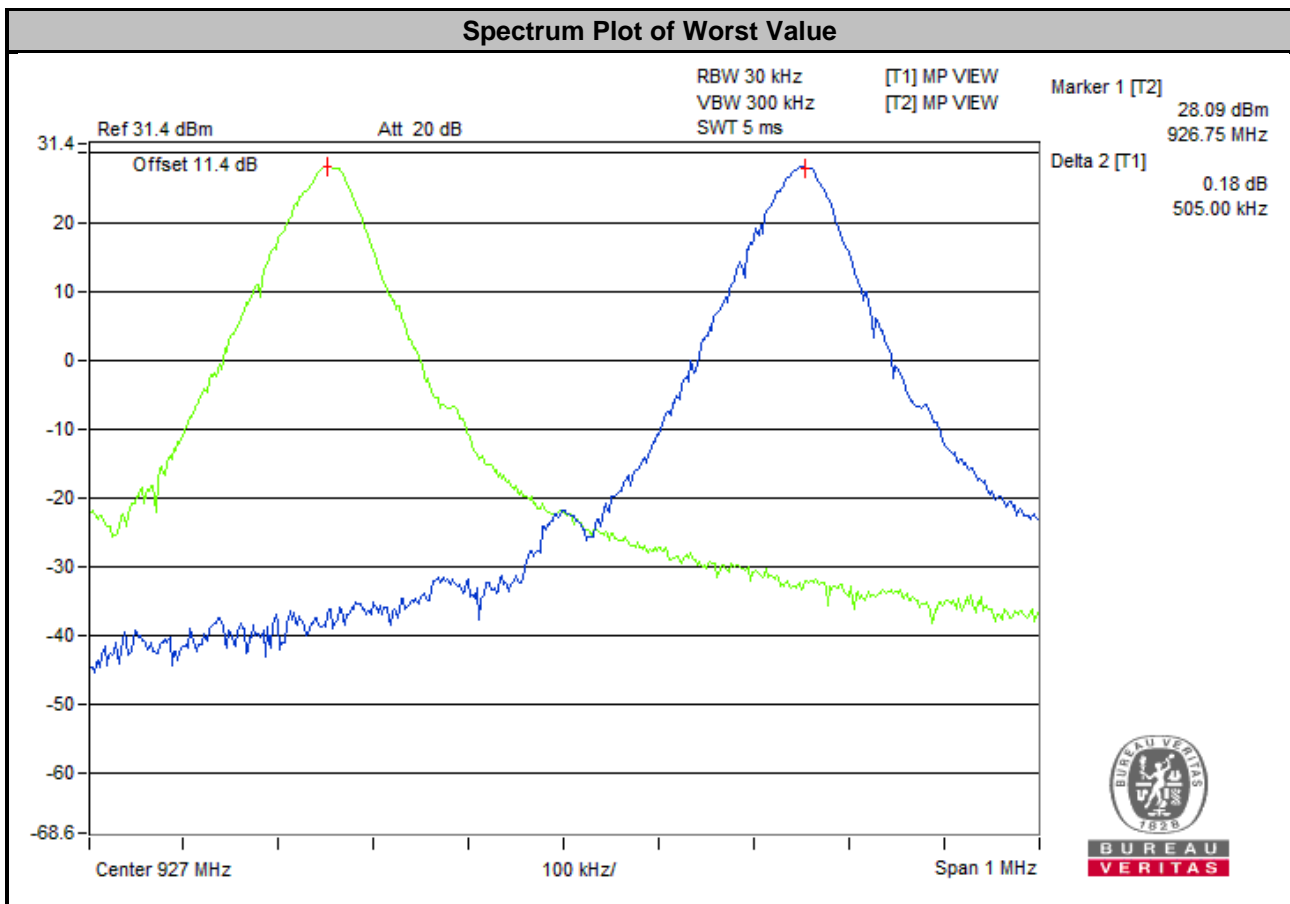

4.8 Maximum Output Power

4.8.1 Limits of Maximum Output Power Measurement

The Maximum Output Power Measurement is 30 dBm.

4.8.2 Test Setup

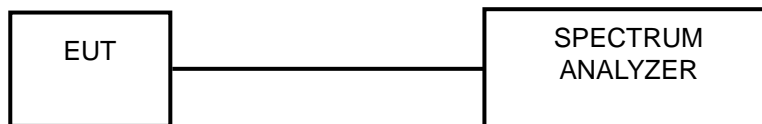

4.8.3 Test Instruments

Refer to section 4.1.2 to get information of above instrument.

4.8.4 Test Procedure

- Check the calibration of the measuring instrument using either an internal calibrator or a known signal from an external generator.
- Turn on the EUT and connect it to measurement instrument. Then set it to any one convenient frequency within its operating range. Set a reference level on the measuring instrument equal to the highest peak value.
- The center frequency of the spectrum analyzer is set to the fundamental frequency and using 3 MHz RBW and 10 MHz VBW.
- Measure the captured power within the band and recording the plot.
- Repeat above procedures until all frequencies required were complete.

4.8.5 Deviation from Test Standard

No deviation.

4.8.6 EUT Operating Condition

The software provided by client enabled the EUT to transmit and receive data at lowest, middle and highest channel frequencies individually.

4.8.7 Test Results

Channel	Frequency (MHz)	Output Power (mW)	Output Power (dBm)	Power Limit (dBm)	Pass / Fail
1	902.75	665.273	28.23	30	PASS
25	914.75	635.331	28.03	30	PASS
50	927.25	629.506	27.99	30	PASS

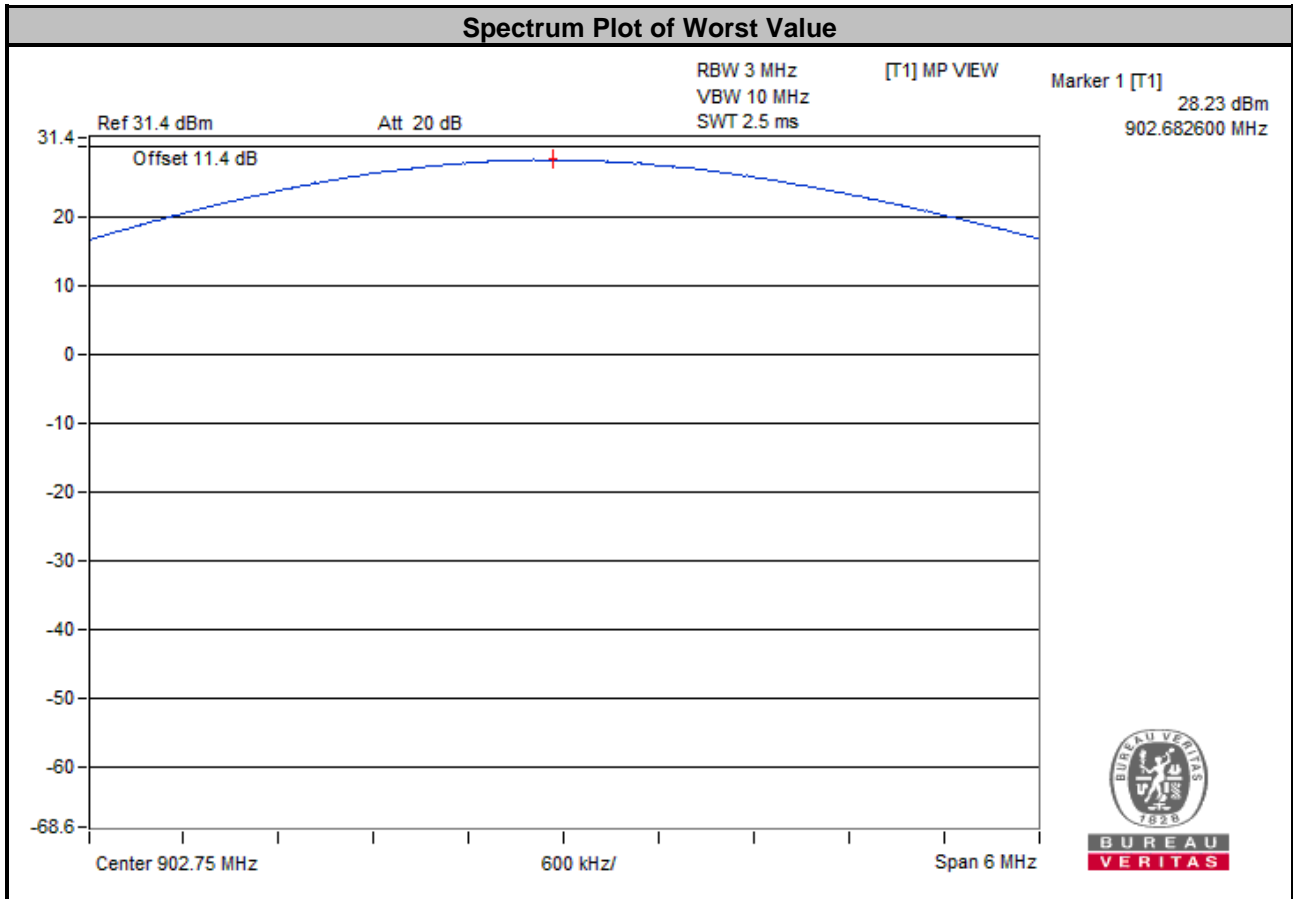

4.9 Conducted Out of Band Emission Measurement

4.9.1 Limits Of Conducted Out Of Band Emission Measurement

Below -20 dB of the highest emission level of operating band (in 100 kHz RBW).

4.9.2 Test Instruments

Refer to section 4.1.2 to get information of above instrument.

4.9.3 Test Procedure

The transmitter output was connected to the spectrum analyzer via a low lose cable. Set both RBW and VBW of spectrum analyzer to 100 kHz and 300 kHz with suitable frequency span including 100 MHz bandwidth from band edge. The band edges was measured and recorded.

4.9.4 Deviation from Test Standard

No deviation.

4.9.5 EUT Operating Condition

The software provided by client enabled the EUT to transmit and receive data at lowest, middle and highest channel frequencies individually.

4.9.6 Test Results

The spectrum plots are attached on the following images. D1 line indicates the highest level, D2 line indicates the 20 dB offset below D1. It shows compliance with the requirement.

Hopping disabled_Low Channel

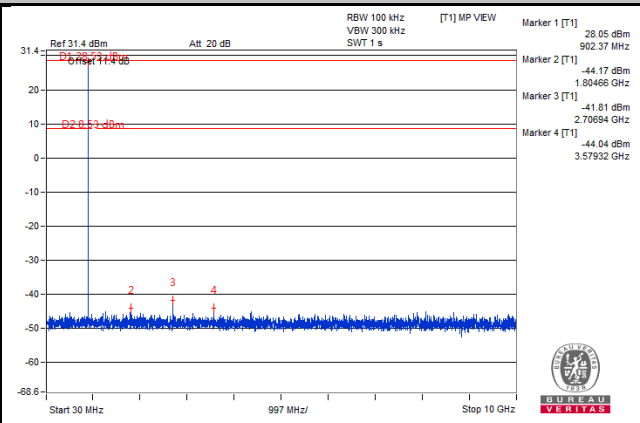
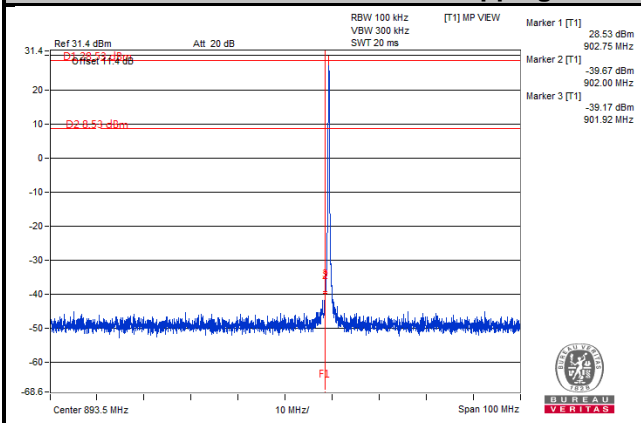

Hopping disabled_High Channel

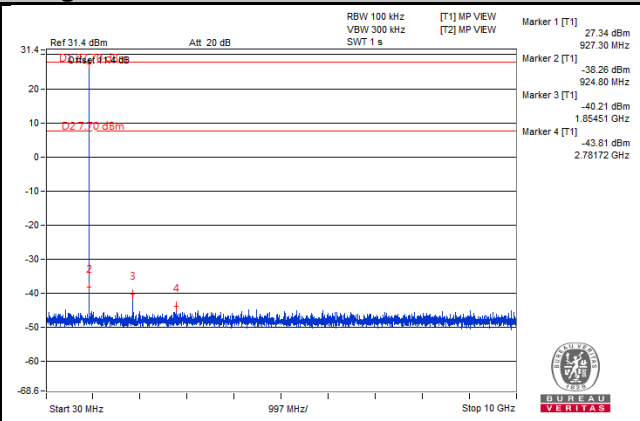
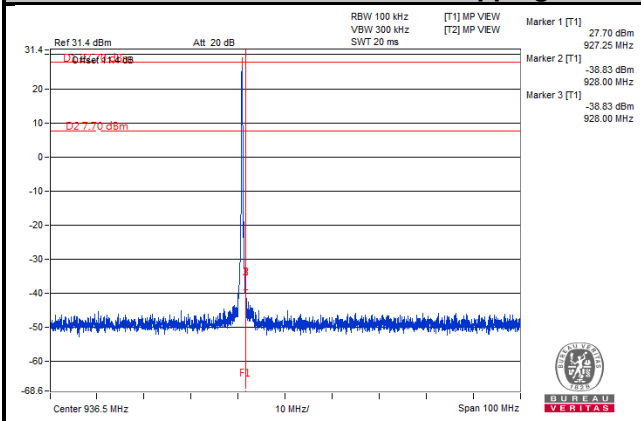

Hopping Enabled

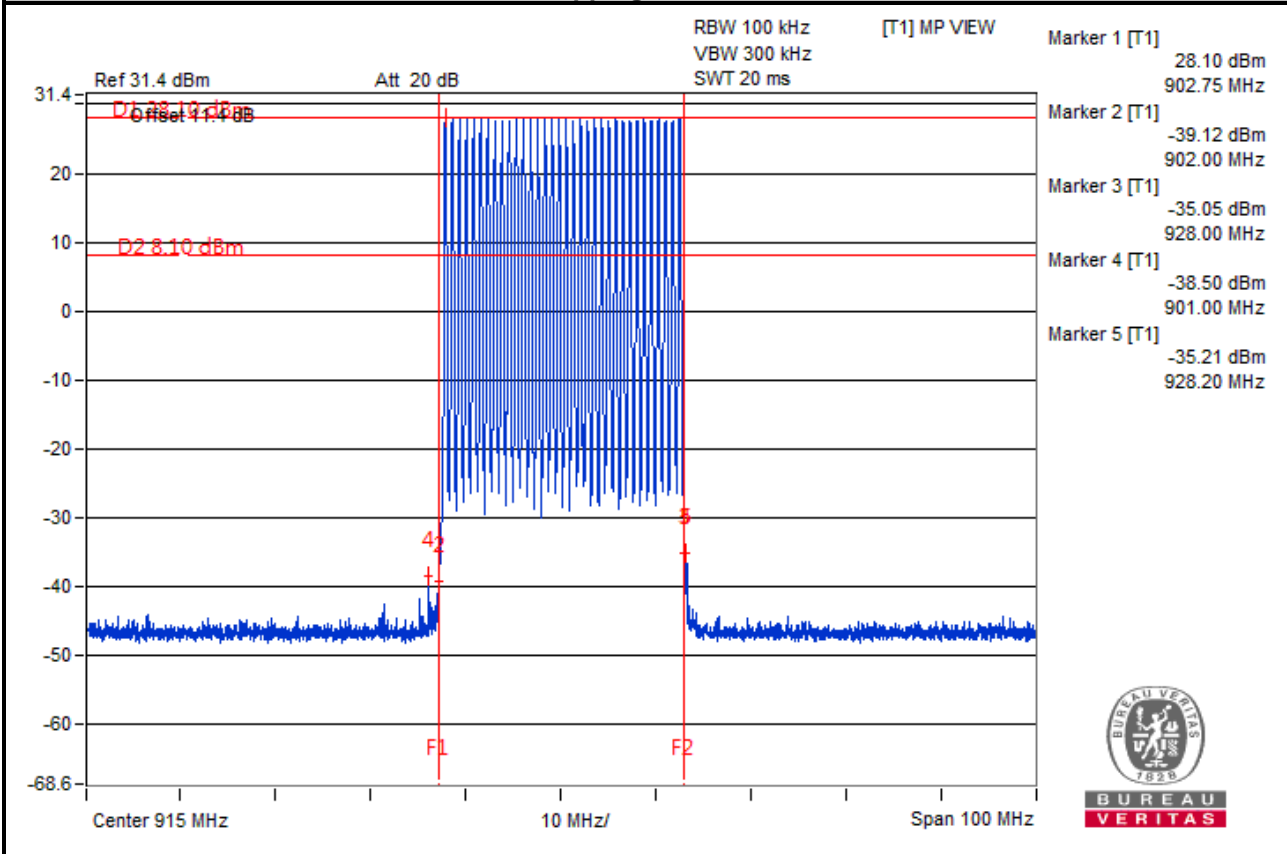

5 Pictures of Test Arrangements

Please refer to the attached file (Test Setup Photo).

Appendix – Information on the Testing Laboratories

We, Bureau Veritas Consumer Products Services (H.K.) Ltd., Taoyuan Branch, were founded in 1988 to provide our best service in EMC, Radio, Telecom and Safety consultation. Our laboratories are accredited and approved according to ISO/IEC 17025.

If you have any comments, please feel free to contact us at the following:

Linko EMC/RF Lab

Tel: 886-2-26052180

Fax: 886-2-26051924

Hsin Chu EMC/RF/Telecom Lab

Tel: 886-3-6668565

Fax: 886-3-6668323

Hwa Ya EMC/RF/Safety

Tel: 886-3-3183232

Fax: 886-3-3270892

Email: service.adt@tw.bureauveritas.com

Web Site: www.bureauveritas-adt.com

The address and road map of all our labs can be found in our web site also.

--- END ---