



# FCC RF Test Report

APPLICANT : Getac Technology Corporation  
EQUIPMENT : Tablet  
BRAND NAME : Getac  
MODEL NAME : Z710  
MARKETING NAME : Z710  
FCC ID : QYLZ710R  
STANDARD : FCC Part 15 Subpart C §15.247  
CLASSIFICATION : (DSS) Spread Spectrum Transmitter

The product was received on Jun. 20, 2012 and completely tested on Aug. 29, 2012. We, SPORTON INTERNATIONAL INC., would like to declare that the tested sample has been evaluated in accordance with the procedures and shown the compliance with the applicable technical standards.

The test results in this report apply exclusively to the tested model / sample. Without written approval of SPORTON INTERNATIONAL INC., the test report shall not be reproduced except in full.

Reviewed by:

Jones Tsai / Manager



## SPORTON INTERNATIONAL INC.

No. 52, Hwa Ya 1<sup>st</sup> Rd., Hwa Ya Technology Park, Kwei-Shan Hsiang, Tao Yuan Hsien, Taiwan, R.O.C.

SPORTON INTERNATIONAL INC.

TEL : 886-3-327-3456

FAX : 886-3-328-4978

FCC ID : QYLZ710R

Page Number : 1 of 73

Report Issued Date : Sep. 05, 2012

Report Version : Rev. 01



TABLE OF CONTENTS

REVISION HISTORY ..... 3
SUMMARY OF TEST RESULT ..... 4
1 GENERAL DESCRIPTION ..... 5
1.1 Applicant ..... 5
1.2 Manufacturer ..... 5
1.3 Feature of Equipment Under Test ..... 5
1.4 Testing Site ..... 6
1.5 Applied Standards ..... 6
1.6 Ancillary Equipment List ..... 7
2 TEST CONFIGURATION OF EQUIPMENT UNDER TEST ..... 8
2.1 RF Output Power ..... 8
2.2 Test Mode ..... 9
2.3 Connection Diagram of Test System ..... 11
2.4 RF Utility ..... 15
3 TEST RESULT ..... 16
3.1 Number of Channel Measurement ..... 16
3.2 Hopping Channel Separation Measurement ..... 18
3.3 Dwell Time Measurement ..... 25
3.4 20dB Bandwidth Measurement ..... 27
3.5 Peak Output Power Measurement ..... 34
3.6 Conducted Band Edges Measurement ..... 41
3.7 Conducted Spurious Emission Measurement ..... 44
3.8 Radiated Band Edges Measurement ..... 48
3.9 Radiated Spurious Emission Measurement ..... 54
3.10 AC Conducted Emission Measurement ..... 67
3.11 Antenna Requirements ..... 71
4 LIST OF MEASURING EQUIPMENT ..... 72
5 UNCERTAINTY OF EVALUATION ..... 73
APPENDIX A. PHOTOGRAPHS OF EUT
APPENDIX B. SETUP PHOTOGRAPHS



### REVISION HISTORY

REPORT NO.	VERSION	DESCRIPTION	ISSUED DATE
FR262032-02A	Rev. 01	Initial issue of report	Sep. 05, 2012

**SUMMARY OF TEST RESULT**

Report Section	FCC Rule	IC Rule	Description	Limit	Result	Remark
3.1	15.247(a)(1)	A8.4(2)	Number of Channels	≥ 15Chs	Pass	-
3.2	15.247(a)(1)	A8.1(b)	Hopping Channel Separation	≥ 2/3 of 20dB BW	Pass	-
3.3	15.247(a)(1)	A8.1(d)	Dwell Time of Each Channel	≤ 0.4sec in 31.6sec period	Pass	-
3.4	15.247(a)(1)	A8.1(a)	20dB Bandwidth	NA	Pass	-
3.5	15.247(b)(1)	A8.1(b)	Peak Output Power	≤ 1 w for 1Mbps ≤ 125 Mw for 2, 3Mbps	Pass	-
3.6	15.247(d)	A8.5	Conducted Band Edges	≤ 20dBc	Pass	-
3.7	15.247(d)	A8.5	Conducted Spurious Emission	≤ 20dBc	Pass	-
3.8	15.247(d)	A8.5	Radiated Band Edges	15.209(a) & 15.247(d)	Pass	-
3.9	15.247(d)	A8.5	Radiated Spurious Emission	15.209(a) & 15.247(d)	Pass	Under limit 4.32 dB at 34.860 MHz
3.10	15.207	Gen 7.2.4	AC Conducted Emission	15.207(a)	Pass	Under limit 9.40 dB at 0.150 MHz
3.11	15.203 & 15.247(b)	A8.4	Antenna Requirement	N/A	Pass	-

# 1 General Description

## 1.1 Applicant

**Getac Technology Corporation**

5F., Building A, No. 209, Sec. 1, Nangang Rd., Nangang Dist., Taipei City 11568, Taiwan, R.O.C.

## 1.2 Manufacturer

**Getac Technology (Kunshan) Co., LTD.**

No. 269, No. 2 Avenue, Kunshan Comprehensive Free Trade Zone, Jiangsu Province, P.R.C.

## 1.3 Feature of Equipment Under Test

Product Feature	
Equipment	Tablet
Brand Name	Getac
Model Name	Z710
Marketing Name	Z710
FCC ID	QYLZ710R
Integrated Module	Brand Name : Jorjin Model Name : WG7310
EUT supports Radios application	GSM/EGPRS/WCDMA/HSPA/ WLAN 11bgn / Bluetooth / RFID
HW Version	R0A
SW Version	G0.0621.09.MU2
EUT Stage	Production Unit

**Remark:** The above EUT's information was declared by manufacturer. Please refer to the specifications or user's manual for more detailed description.

Product Specification subjective to this standard	
Tx/Rx Frequency Range	2402 MHz ~ 2480 MHz
Number of Channels	79
Carrier Frequency of Each Channel	2402+n*1 MHz; n=0~78
Maximum Output Power to Antenna	Bluetooth (1Mbps) : 10.09 dBm (0.0102 W) Bluetooth EDR (2Mbps) : 9.74 dBm (0.0094 W) Bluetooth EDR (3Mbps) : 10.47 dBm (0.0111 W)
Antenna Type	PIFA Antenna with gain 2.90 dBi
Type of Modulation	Bluetooth (1Mbps) : GFSK Bluetooth 2.1 EDR (2Mbps) : $\pi/4$ -DQPSK Bluetooth 2.1 EDR (3Mbps) : 8-DPSK

## 1.4 Testing Site

<b>Test Site</b>	SPORTON INTERNATIONAL INC.			
<b>Test Site Location</b>	No. 52, Hwa Ya 1 <sup>st</sup> Rd., Hwa Ya Technology Park, Kwei-Shan Hsiang, Tao Yuan Hsien, Taiwan, R.O.C. TEL: +886-3-3273456 / FAX: +886-3-3284978			
<b>Test Site No.</b>	<b>Sporton Site No.</b>			<b>FCC/IC Registration No.</b>
	TH02-HY	CO05-HY	03CH05-HY	722060/4086B-1

## 1.5 Applied Standards

According to the specifications of the manufacturer, the EUT must comply with the requirements of the following standards:

- ♦ FCC Part 15 Subpart C §15.247
- ♦ FCC Public Notice DA 00-705
- ♦ ANSI C63.4-2003 and ANSI C63.10-2009
- ♦ IC RSS-210 Issue 8
- ♦ IC RSS-Gen Issue 3

**Remark:**

1. All test items were verified and recorded according to the standards and without any deviation during the test.
2. This EUT has also been tested and complied with the requirements of FCC Part 15, Subpart B, recorded in a separate test report.



### 1.6 Ancillary Equipment List

Item	Equipment	Trade Name	Model Name	FCC ID	Data Cable	Power Cord
1.	System Simulator	R&S	CMU 200	N/A	N/A	Unshielded, 1.8 m
2.	WLAN AP	D-Link	DIR-628	KA2DIR628A2	N/A	Unshielded, 1.8 m
3.	Bluetooth Base Station	R&S	CBT32	N/A	N/A	Unshielded, 1.8 m
4.	Car Battery	YUASA	46B24R(S)	N/A	N/A	N/A
5.	Notebook	DELL	Vostro 1510	FCC DoC	N/A	AC I/P: Unshielded, 1.2 m DC O/P: Shielded, 1.8 m
6.	LCD Monitor	Dell	U2410	FCC DoC	Shielded, 1.6 m	Unshielded, 1.8 m
7.	Bluetooth Earphone	Sony Ericsson	MW600	PY7DDA-2029	N/A	N/A
8.	Earphone	Ergotech	ET-E200	FCC DoC	Unshielded, 1.8 m	N/A
9.	USB3.0 HD	WD	WDBAAR5000A BK-PESN	FCC DoC	Unshielded, 0.5 m	N/A
10.	(USB) Mouse	DELL	MOC5UO	FCC DoC	Shielded, 1.8 m	N/A
11.	iPod	Apple	A1285	FCC DoC	Shielded, 1.0 m	N/A
12.	iPod Earphone	Apple	N/A	FCC DoC	Unshielded, 1.0 m	N/A

## 2 Test Configuration of Equipment Under Test

### 2.1 RF Output Power

Preliminary tests were performed in different data rate and recorded the RF output power in the following table:

Channel	Frequency	Bluetooth RF Output Power		
		Data Rate / Modulation		
		GFSK	$\pi/4$ -DQPSK	8-DPSK
		1Mbps	2Mbps	3Mbps
Ch00	2402MHz	10.09 dBm	9.74 dBm	10.47 dBm
Ch39	2441MHz	9.99 dBm	9.63 dBm	10.28 dBm
Ch78	2480MHz	9.67 dBm	9.30 dBm	9.91 dBm

**Remark:**

1. All the test data for each data rate were verified, but only the worst case was reported.
2. The data rate was set in 3Mbps for all the test items due to the highest RF output power.
3. The EUT is programmed to transmit signals continuously for all testing.



## 2.2 Test Mode

The EUT has been associated with peripherals pursuant to ANSI C63.4-2003 and ANSI C63.10-2009 and configuration operated in a manner tended to maximize its emission characteristics in a typical application. Frequency range investigated: conduction (150 KHz to 30 MHz), radiation (9 KHz to the 10th harmonic of the highest fundamental frequency or to 40 GHz, whichever is lower).

Pre-scanned tests, X, Y, Z in three orthogonal panels, were conducted to determine the final configuration from all possible combinations.

The following tables are showing the test modes as the worst cases (X plane) and recorded in this report.

Test Cases			
Test Item	Data Rate / Modulation		
	Bluetooth 1Mbps GFSK	Bluetooth EDR 2Mbps $\pi/4$ -DQPSK	Bluetooth EDR 3Mbps 8-DPSK
<b>Conducted TCs</b>	Mode 1: CH00_2402 MHz Mode 2: CH39_2441 MHz Mode 3: CH78_2480 MHz	Mode 4: CH00_2402 MHz Mode 5: CH39_2441 MHz Mode 6: CH78_2480 MHz	Mode 7: CH00_2402 MHz Mode 8: CH39_2441 MHz Mode 9: CH78_2480 MHz
<b>Radiated TCs</b>	Pretest	Pretest	Mode 1: CH00_2402 MHz + Adapter 1 <Fig. 1> Mode 2: CH39_2441 MHz + Adapter 1 <Fig. 1> Mode 3: CH78_2480 MHz + Adapter 1 <Fig. 1> Mode 4: CH78_2480 MHz + Docking 1 + Adapter 2 <Fig. 2> Mode5: CH78_2480 MHz + Docking 2 + Car Charger 12V <Fig. 3>



Test Cases	
<b>AC Conducted Emission</b>	Mode 1 :RFID On + TC1 <Fig. 4> Mode 2 :WCDMA Band II Idle + WLAN Link + Bluetooth Link + RFID On + Camera + TC2 <Fig. 5> Mode 3 :GSM1900 (GPRS 8) Idle + WLAN Link + Bluetooth Link + RFID On + MPEG4 + TC3 <Fig. 6> Mode 4 :GSM1900 (GPRS 8) Idle + WLAN Link + Bluetooth Link + RFID On + MPEG4 + TC4 <Fig. 7> Mode 5 :GSM1900 (GPRS 8) Idle + RFID On + MPEG4 + TC5 <Fig. 8> Mode 6 :WLAN Link + Bluetooth Link + RFID On + Camera + TC2 <Fig. 9>
<b>Remark:</b> <ol style="list-style-type: none"><li>1. TC1 stands for Test Configuration, and consists of USB Cable (Data Link with Notebook), Adapter 1, SD Card, and USB 3.0 HD.</li><li>2. TC2 stands for Test Configuration, and consists of SD Card, HDMI Cable, earphone, docking 1, RJ-45 Load, USB Cable (Link with Notebook), mouse, USB 3.0 HD, and adapter 2.</li><li>3. TC3 stands for Test Configuration, and consists of SD Card, HDMI Cable, earphone, docking 1, RJ-45 Link, USB Cable (Load with Notebook), mouse, USB 3.0 HD, and adapter 2.</li><li>4. TC4 stands for Test Configuration, and consists of SD Card, HDMI Cable, earphone, docking 2, RJ-45 Load, RS-232 Load, mouse, USB 3.0 HD, and car charger (12V).</li><li>5. TC5 stands for Test Configuration, and consists of SD Card, HDMI Cable, earphone, docking 2, RJ-45 Link, RS-232 Load, USB Load, mouse, USB 3.0 HD, and car charger (24V).</li><li>6. For radiated TCs, the data rate was set in 3Mbps due to the highest RF output power; only the data of these modes was reported.</li><li>7. For conducted emission, the worst case is mode 3; only the test data of this mode was reported.</li></ol>	

## 2.3 Connection Diagram of Test System

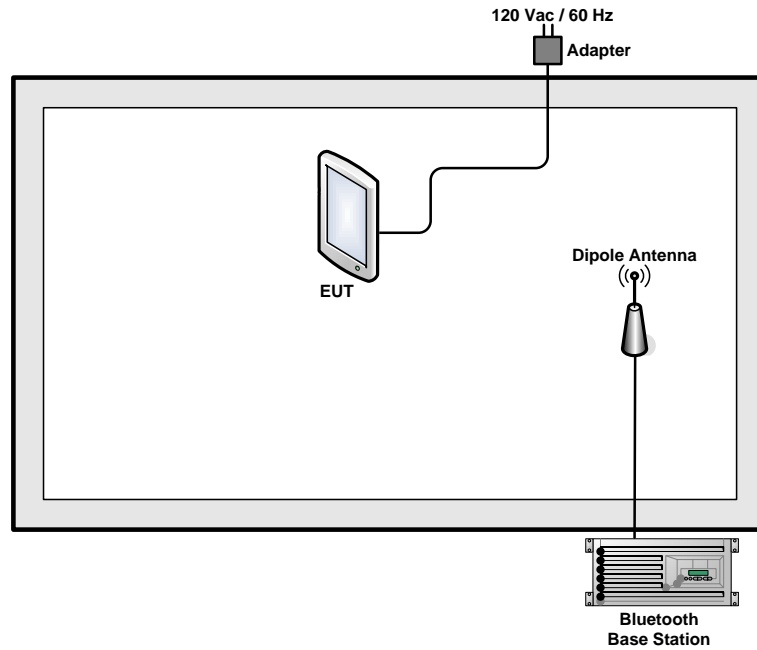

<Fig. 1>

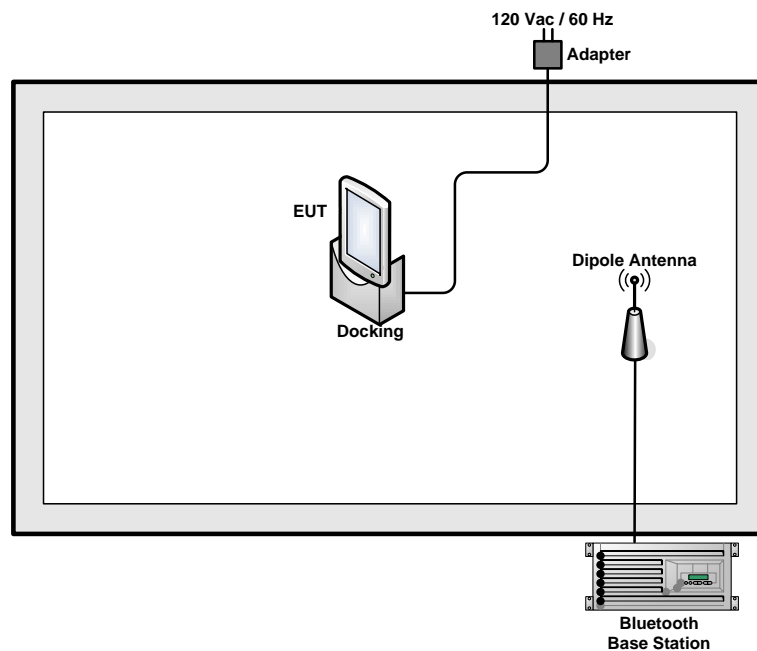

<Fig. 2>

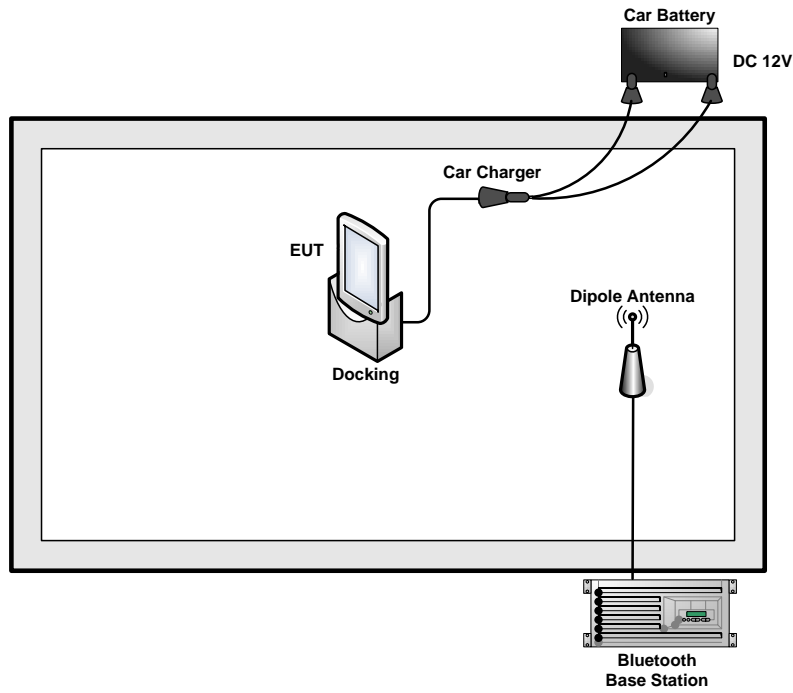

<Fig. 3>

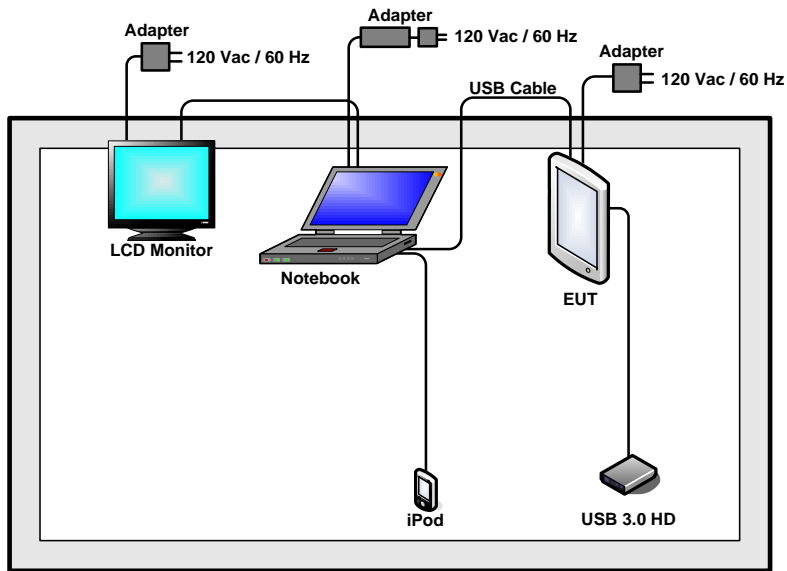

<Fig. 4>

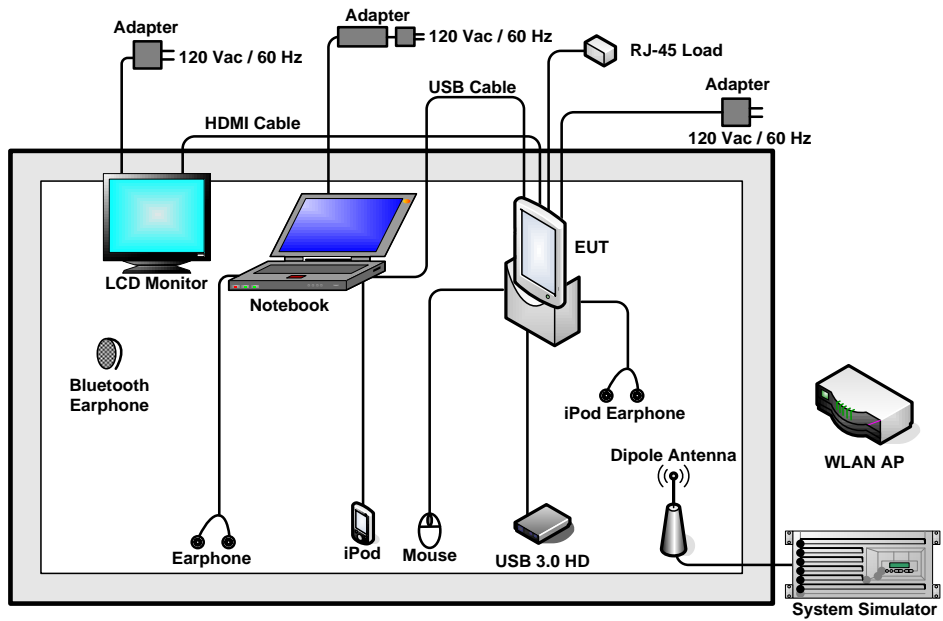

<Fig. 5>

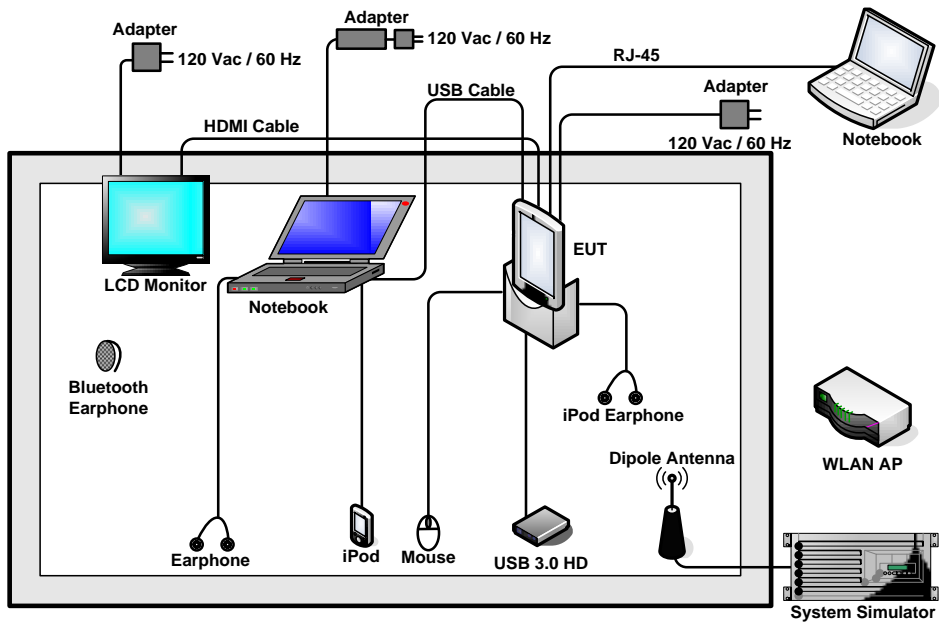

<Fig. 6>

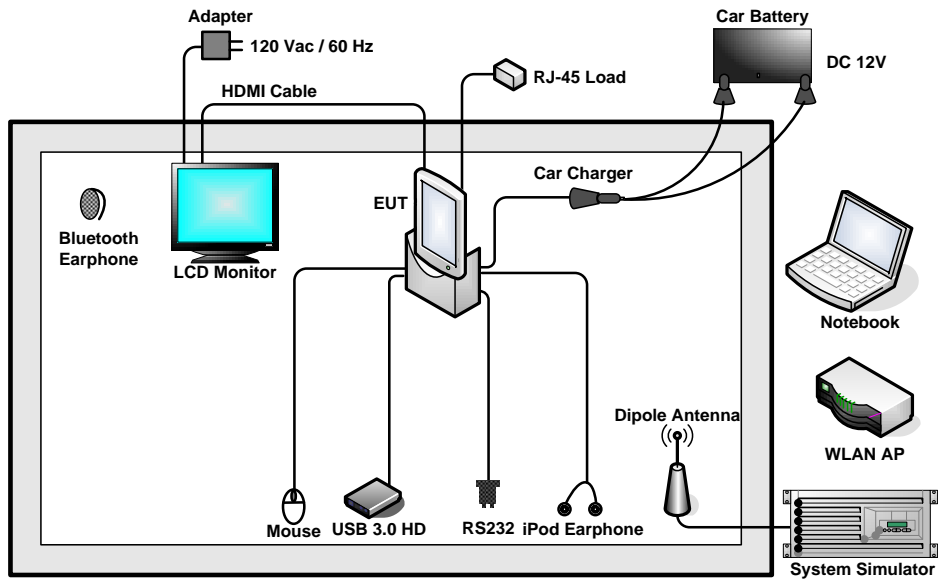

<Fig. 7>

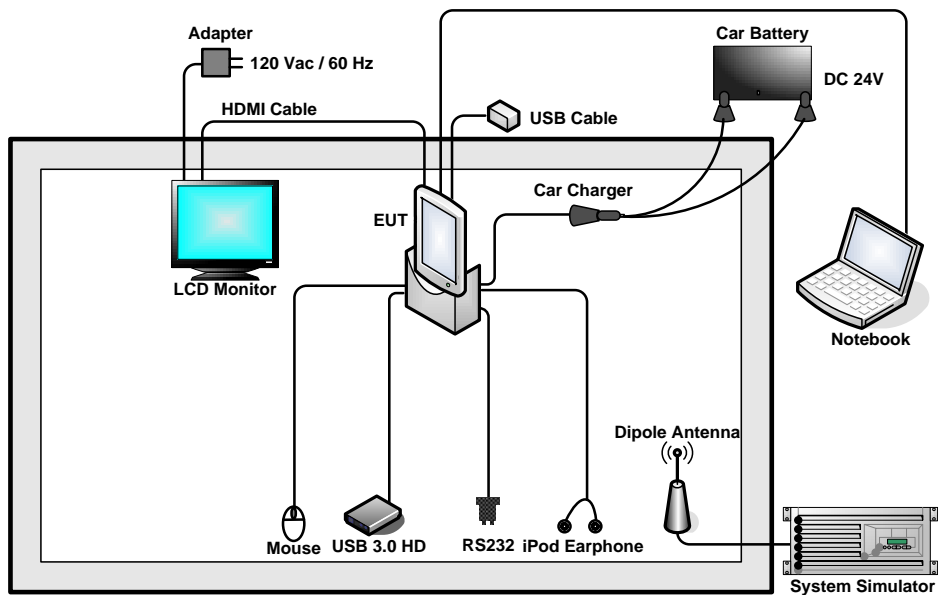

<Fig. 8>

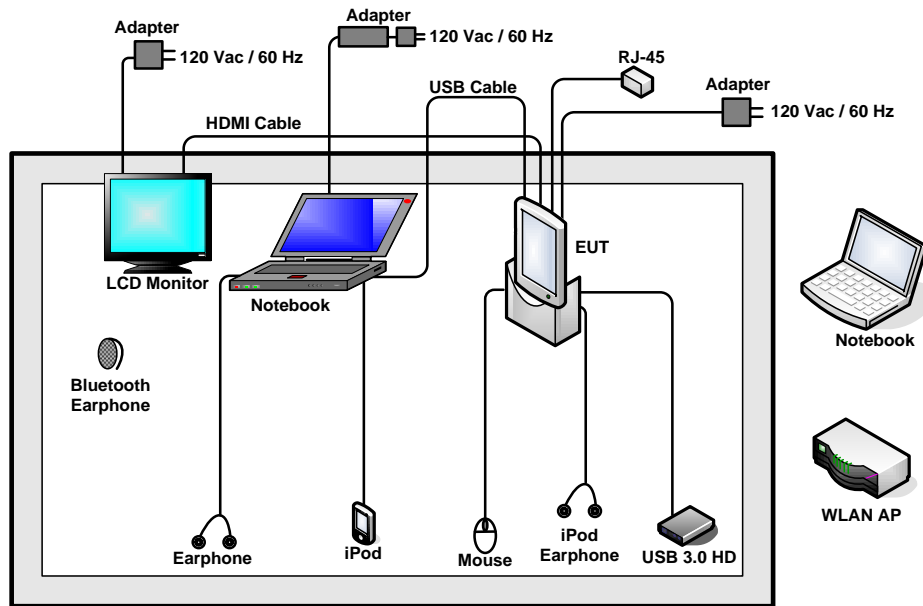

<Fig. 9>

## 2.4 RF Utility

For Bluetooth function, the RF utility, "Z710\_BTEnterTestmode Tool" was installed in EUT which was programmed in order to make the EUT into the engineering modes to contact with Bluetooth base station for continuous transmitting and receiving signals.

### 3 Test Result

#### 3.1 Number of Channel Measurement

##### 3.1.1 Limits of Number of Hopping Frequency

Frequency hopping systems in the 2400-2483.5 MHz band shall use at least 15 channels.

##### 3.1.2 Measuring Instruments

See list of measuring instruments of this test report.

##### 3.1.3 Test Procedure

1. The testing follows FCC Public Notice DA 00-705 Measurement Guidelines.
2. The RF output of EUT was connected to the spectrum analyzer by a low loss cable.
3. Set to the maximum power setting and enable the EUT transmit continuously.
4. Enable the EUT hopping function.
5. Use the following spectrum analyzer settings: Span = the frequency band of operation; RBW  $\geq$  1% of the span; VBW  $\geq$  RBW; Sweep = auto; Detector function = peak; Trace = max hold.
6. The number of hopping frequency used is defined as the number of total channel.

##### 3.1.4 Test Setup

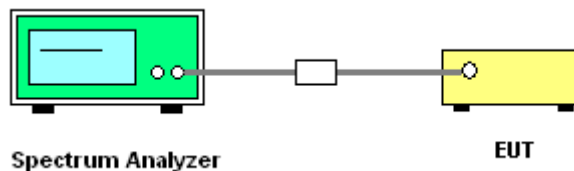

##### 3.1.5 Test Result of Number of Hopping Frequency

<b>Test Mode :</b>	3Mbps	<b>Temperature :</b>	24~26°C
<b>Test Engineer :</b>	Book Lin	<b>Relative Humidity :</b>	50~53%
<b>Number of Hopping Channels (Channel)</b>		<b>Limits (Channel)</b>	<b>Pass/Fail</b>
79		> 15	Pass





Number of Hopping Channel Plot on Channel 00 - 78

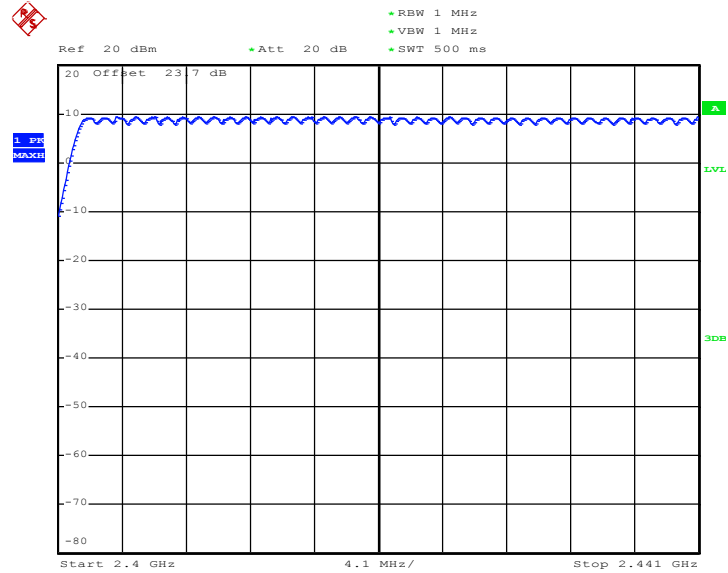

Date: 20.AUG.2012 22:43:33

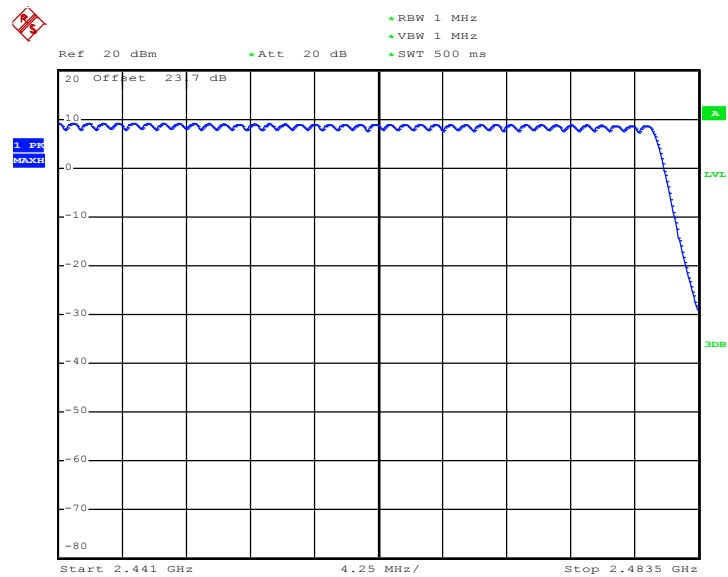

Date: 20.AUG.2012 22:52:19

## 3.2 Hopping Channel Separation Measurement

### 3.2.1 Limit of Hopping Channel Separation

Frequency hopping systems operating in the 2400-2483.5 MHz band may have hopping channel carrier frequencies that are separated by 25 KHz or two-thirds of the 20 dB bandwidth of the hopping channel, whichever is greater.

### 3.2.2 Measuring Instruments

See list of measuring instruments of this test report.

### 3.2.3 Test Procedures

1. The testing follows FCC Public Notice DA 00-705 Measurement Guidelines.
2. The RF output of EUT was connected to the spectrum analyzer by a low loss cable.
3. Set to the maximum power setting and enable the EUT transmit continuously.
4. Enable the EUT hopping function.
5. Use the following spectrum analyzer settings:  
Span = wide enough to capture the peaks of two adjacent channels; RBW  $\geq$  1% of the span;  
VBW  $\geq$  RBW; Sweep = auto; Detector function = peak; Trace = max hold.

### 3.2.4 Test Setup

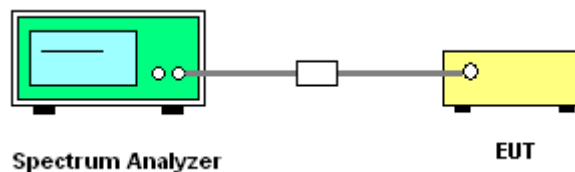

### 3.2.5 Test Result of Hopping Channel Separation

Test Mode :	1Mbps	Temperature :	24~26°C
Test Engineer :	Book Lin	Relative Humidity :	50~53%

Channel	Frequency (MHz)	Frequency Separation (MHz)	(2/3 of 20dB BW) Limits (MHz)	Pass/Fail
00	2402	1.008	0.6027	Pass
39	2441	1.002	0.6000	Pass
78	2480	1.002	0.6000	Pass

Channel Separation Plot on Channel 00 - 01

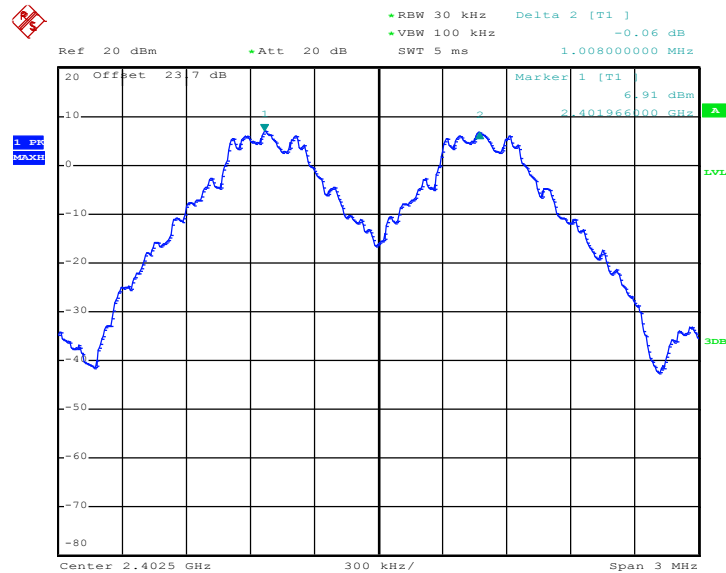

Date: 20.AUG.2012 22:07:30



### Channel Separation Plot on Channel 39 - 40

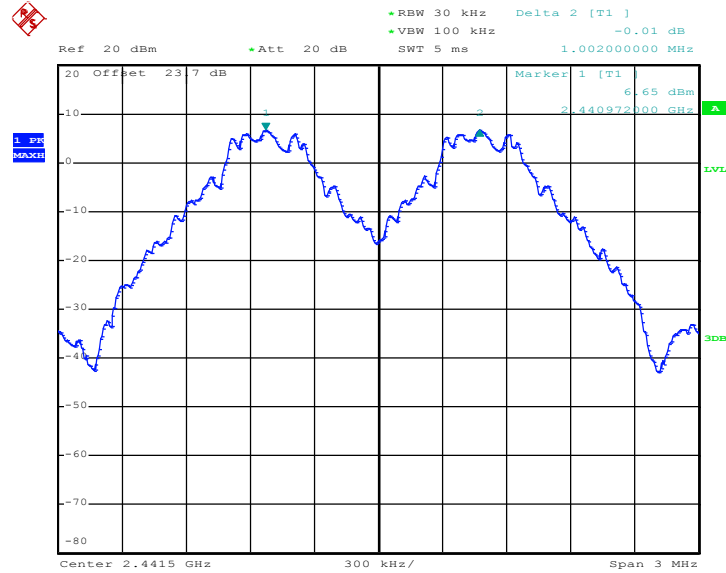

Date: 20.AUG.2012 22:08:21

### Channel Separation Plot on Channel 77 - 78

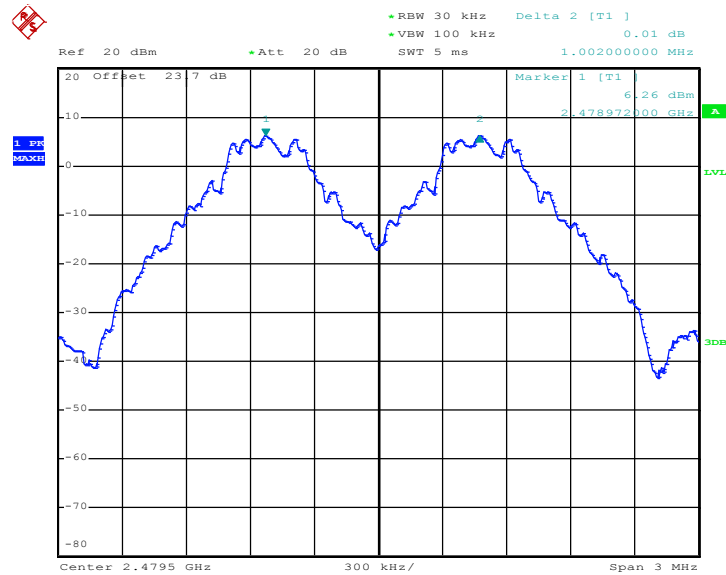

Date: 20.AUG.2012 22:10:22



Test Mode :	2Mbps	Temperature :	24~26°C
Test Engineer :	Book Lin	Relative Humidity :	50~53%

Channel	Frequency (MHz)	Frequency Separation (MHz)	(2/3 of 20dB BW) Limits (MHz)	Pass/Fail
00	2402	1.002	0.8800	Pass
39	2441	1.002	0.8800	Pass
78	2480	1.002	0.8840	Pass

Channel Separation Plot on Channel 00 - 01

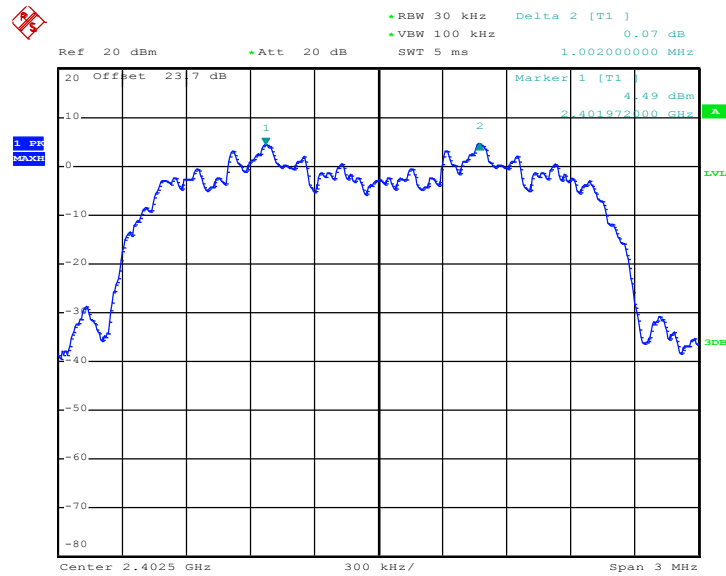

Date: 20.AUG.2012 22:05:22



Channel Separation Plot on Channel 39 - 40

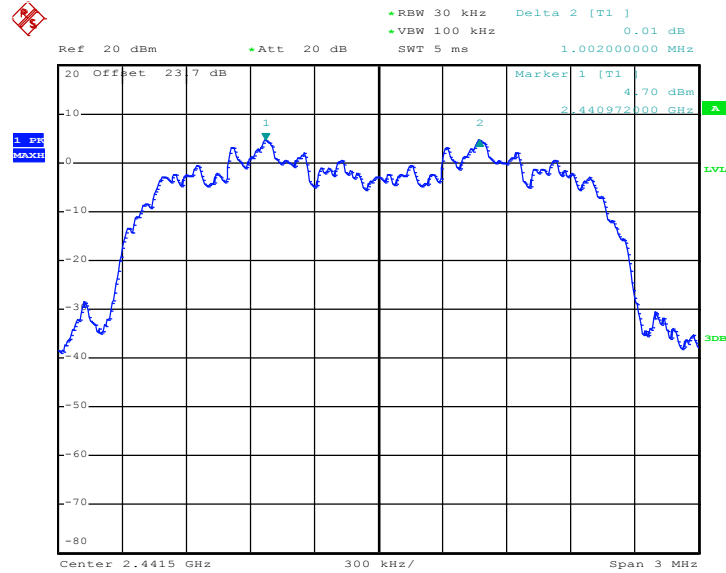

Date: 20.AUG.2012 22:03:13

Channel Separation Plot on Channel 77 - 78

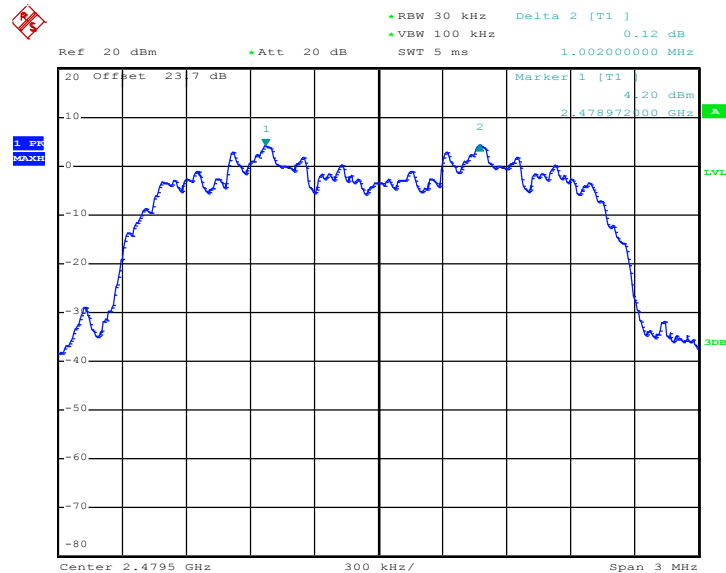

Date: 20.AUG.2012 22:02:20



Test Mode :	3Mbps	Temperature :	24~26°C
Test Engineer :	Book Lin	Relative Humidity :	50~53%

Channel	Frequency (MHz)	Frequency Separation (MHz)	(2/3 of 20dB BW) Limits (MHz)	Pass/Fail
00	2402	1.002	0.8560	Pass
39	2441	1.002	0.8560	Pass
78	2480	1.008	0.8560	Pass

Channel Separation Plot on Channel 00 - 01

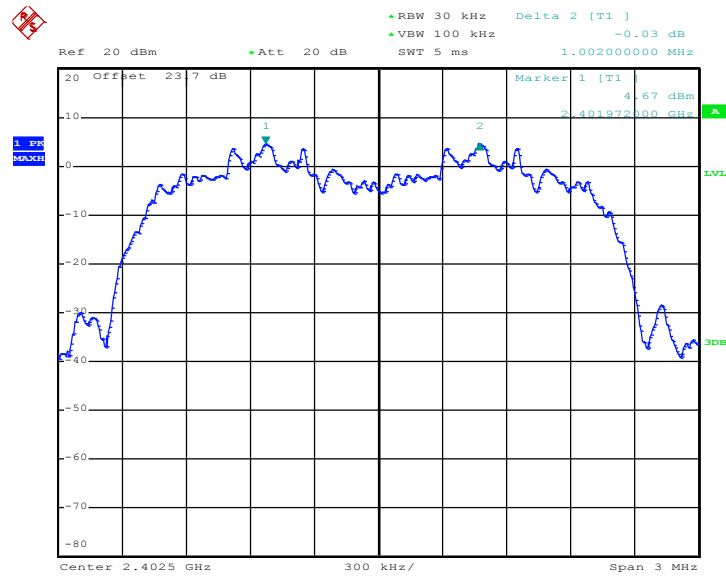

Date: 20.AUG.2012 21:53:47



Channel Separation Plot on Channel 39 - 40

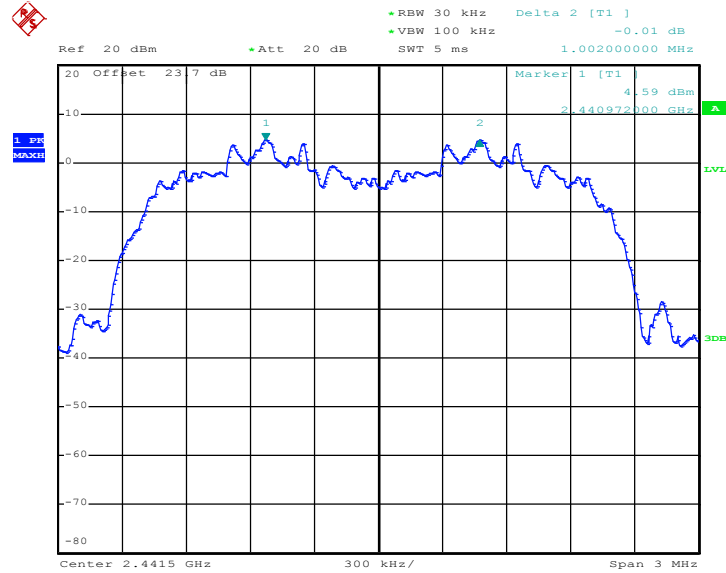

Date: 20.AUG.2012 21:54:39

Channel Separation Plot on Channel 77 - 78

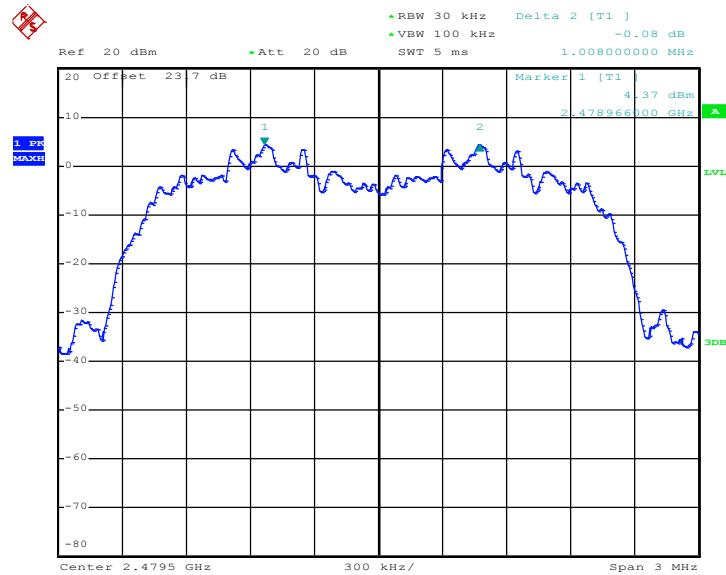

Date: 20.AUG.2012 21:56:38



### 3.3 Dwell Time Measurement

#### 3.3.1 Limit of Dwell Time

The average time of occupancy on any channel shall not be greater than 0.4 seconds within a period of 0.4 seconds multiplied by the number of hopping channels employed.

#### 3.3.2 Measuring Instruments

See list of measuring instruments of this test report.

#### 3.3.3 Test Procedures

1. The testing follows FCC Public Notice DA 00-705 Measurement Guidelines.
2. The RF output connector was connected to the spectrum analyzer through a low loss cable.
3. Set to the maximum power setting and enable the EUT transmit continuously.
4. Enable the EUT hopping function.
5. Use the following spectrum analyzer settings: Span = zero span, centered on a hopping channel; RBW = 1 MHz; VBW ≥ RBW; Sweep = as necessary to capture the entire dwell time per hopping channel; Detector function = peak; Trace = max hold.

#### 3.3.4 Test Setup

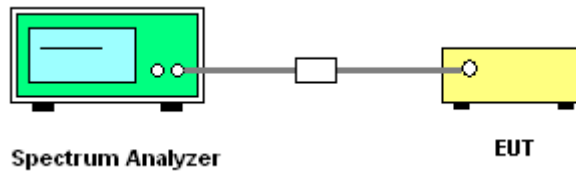

#### 3.3.5 Test Result of Dwell Time

Test Mode :	3DH1	Temperature :	24~26°C
Test Engineer :	Book Lin	Relative Humidity :	50~53%

Package Mode	Average Hopping Channel	Package Transfer Time (usec)	Dwell Time (sec)	Limits (sec)	Pass/Fail
3DH1	9.70	431.41	0.13	0.4	Pass

**Remark:**

1. Dwell Time=79(channels) x 0.4(s) x average hopping channel x package transfer time
2. 79 channels come from the Hopping Channel number.
3. Average Hopping Channel = hops/sweep time
4. T: Package Transfer Time(us)



### 3DH1 Dwell Time (One Pulse) Plot on Channel 39

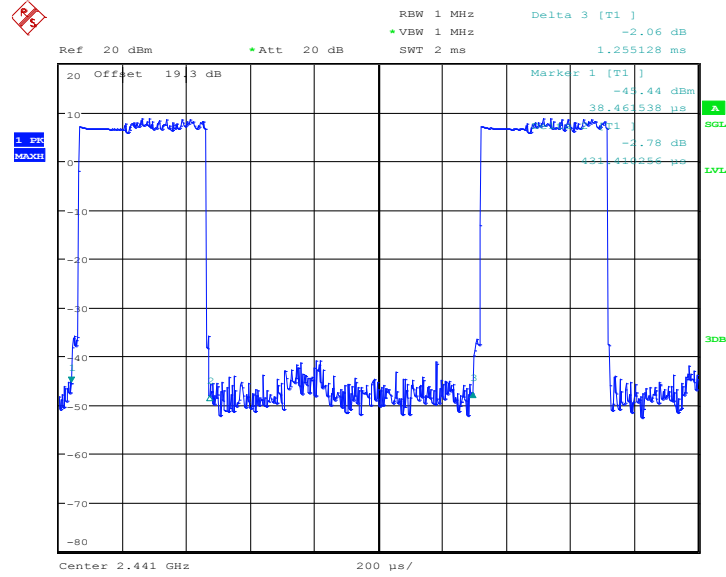

Date: 30.JUL.2012 16:30:14

### 3DH1 Dwell Time (Count Pulses) Plot on Channel 39

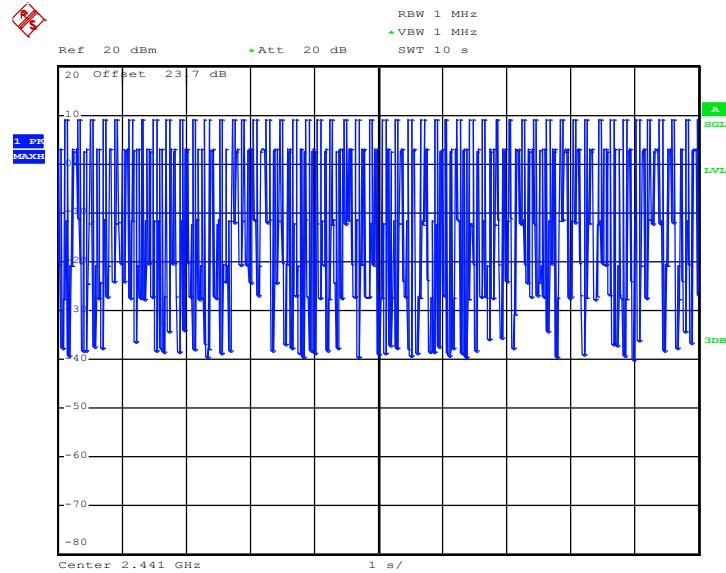

Date: 20.AUG.2012 22:35:46

### 3.4 20dB Bandwidth Measurement

#### 3.4.1 Limit of 20dB Bandwidth

Reporting only

#### 3.4.2 Measuring Instruments

See list of measuring instruments of this test report.

#### 3.4.3 Test Procedures

1. The testing follows FCC Public Notice DA 00-705 Measurement Guidelines.
2. The RF output of EUT was connected to the spectrum analyzer by a low loss cable.
3. Set to the maximum power setting and enable the EUT transmit continuously.
4. Use the following spectrum analyzer settings:  
Span = approximately 2 to 3 times the 20 dB bandwidth, centered on a hopping channel;  
RBW  $\geq$  1% of the 20 dB bandwidth; VBW  $\geq$  RBW; Sweep = auto; Detector function = peak;  
Trace = max hold.

#### 3.4.4 Test Setup

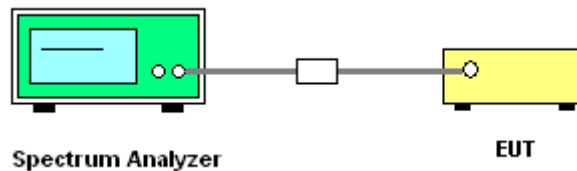



3.4.5 Test Result of 20dB Bandwidth

Test Mode :	1Mbps	Temperature :	24~26°C
Test Engineer :	Book Lin	Relative Humidity :	50~53%

Channel	Frequency (MHz)	20dB Bandwidth (MHz)
00	2402	0.904
39	2441	0.900
78	2480	0.900

20 dB Bandwidth Plot on Channel 00

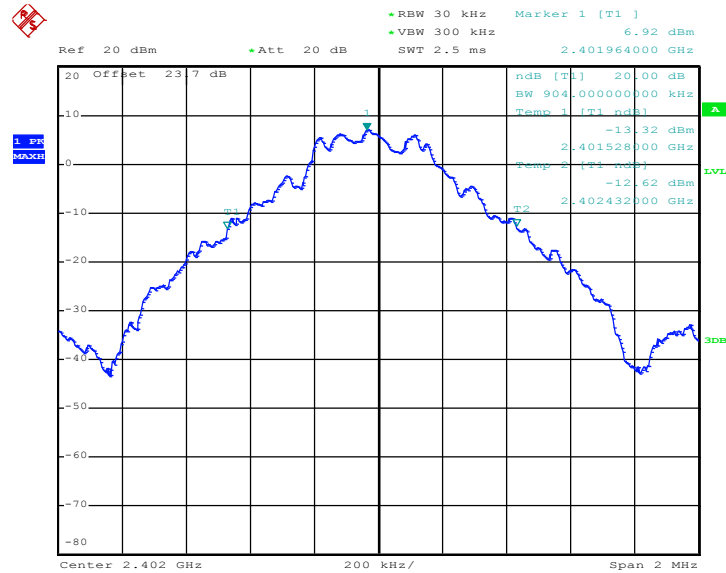

Date: 20.AUG.2012 22:11:01



20 dB Bandwidth Plot on Channel 39

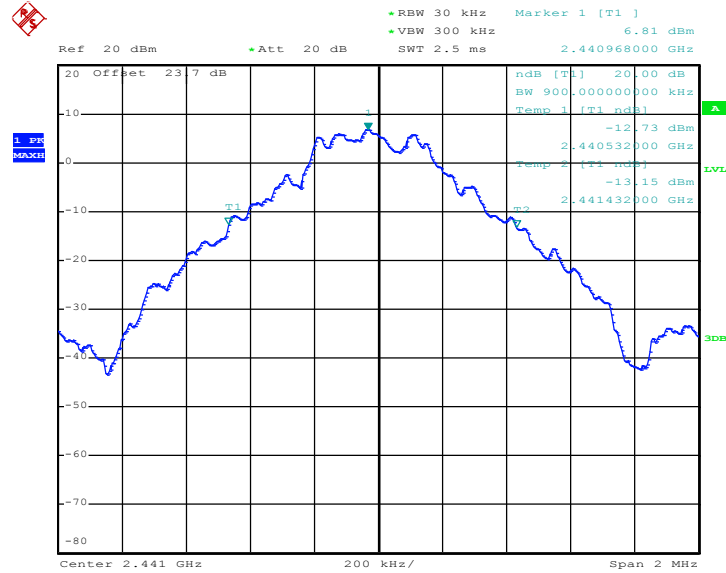

Date: 20.AUG.2012 22:11:24

20 dB Bandwidth Plot on Channel 78

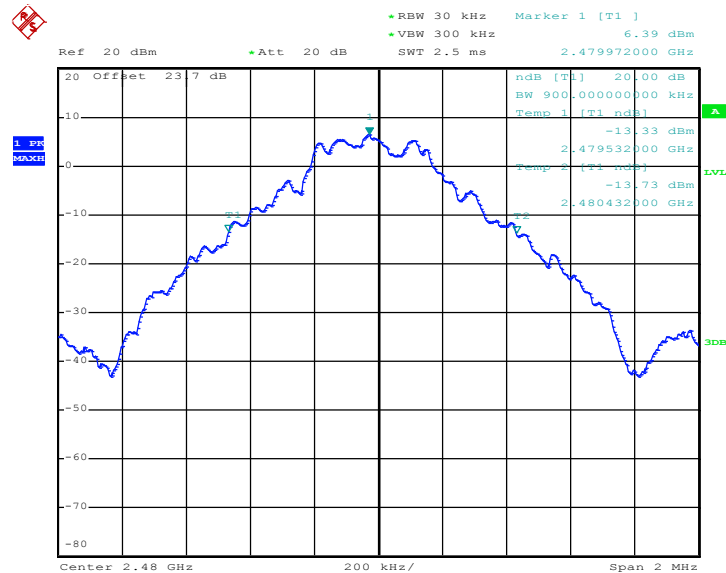

Date: 20.AUG.2012 22:11:42



Test Mode :	2Mbps	Temperature :	24~26°C
Test Engineer :	Book Lin	Relative Humidity :	50~53%

Channel	Frequency (MHz)	20dB Bandwidth (MHz)
00	2402	1.320
39	2441	1.320
78	2480	1.326

20 dB Bandwidth Plot on Channel 00

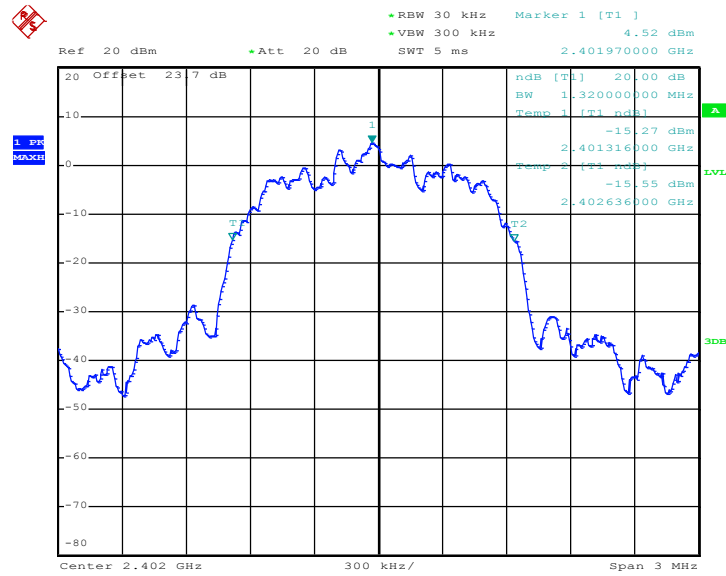

Date: 20.AUG.2012 22:12:04



### 20 dB Bandwidth Plot on Channel 39

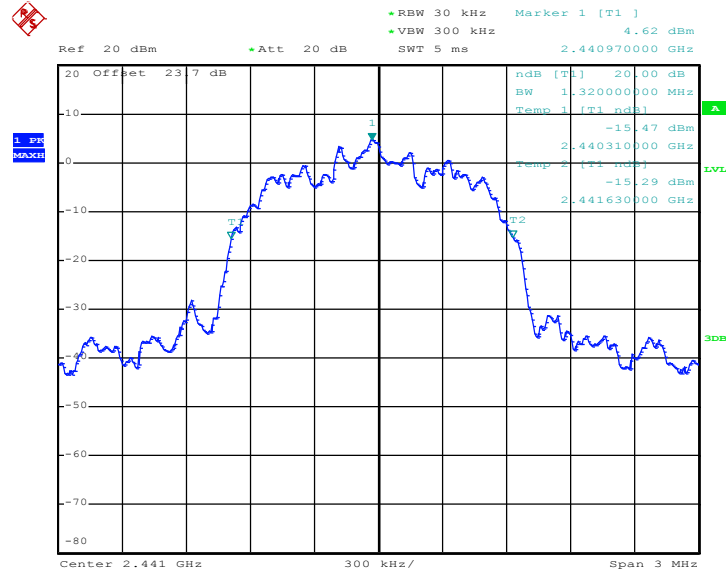

Date: 20.AUG.2012 22:12:24

### 20 dB Bandwidth Plot on Channel 78

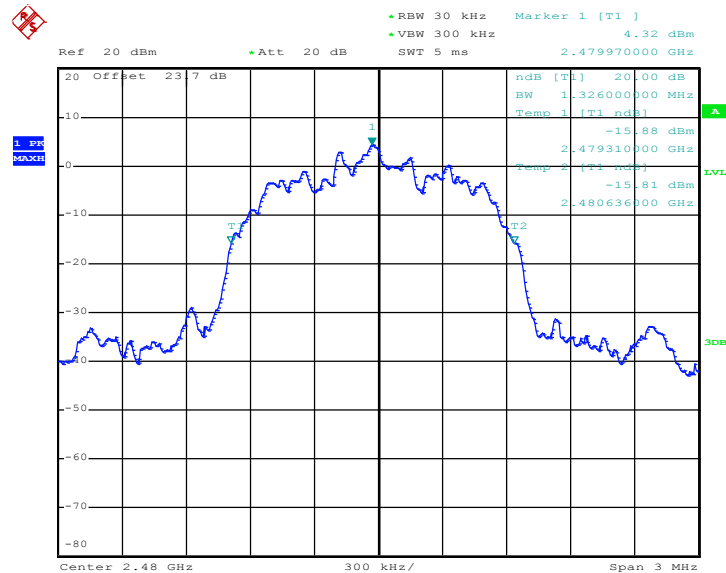

Date: 20.AUG.2012 22:12:57



Test Mode :	3Mbps	Temperature :	24~26°C
Test Engineer :	Book Lin	Relative Humidity :	50~53%

Channel	Frequency (MHz)	20dB Bandwidth (MHz)
00	2402	1.284
39	2441	1.284
78	2480	1.284

20 dB Bandwidth Plot on Channel 00

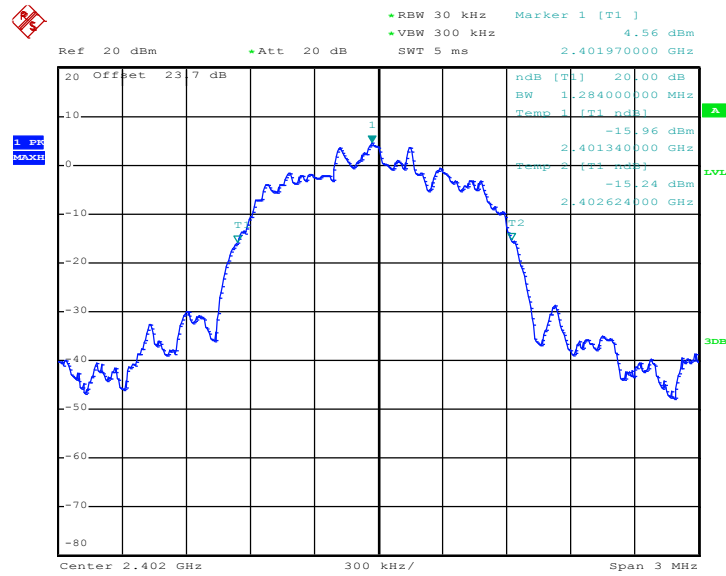

Date: 20.AUG.2012 22:13:32





### 20 dB Bandwidth Plot on Channel 39

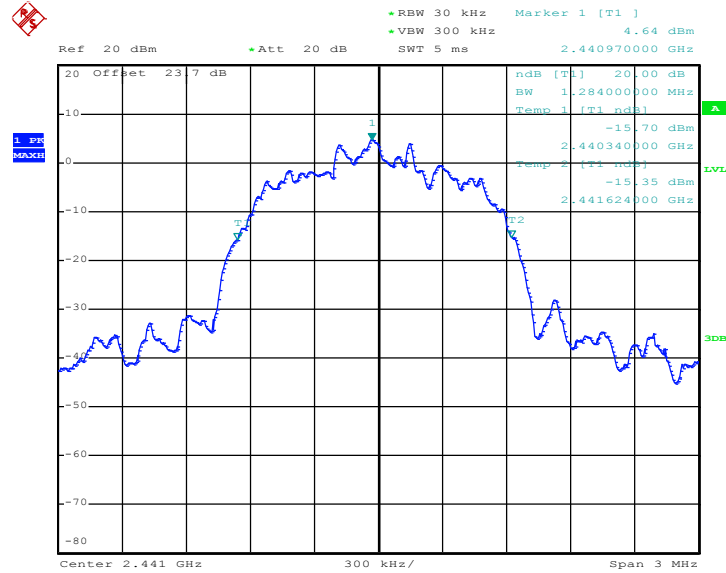

Date: 20.AUG.2012 22:14:15

### 20 dB Bandwidth Plot on Channel 78

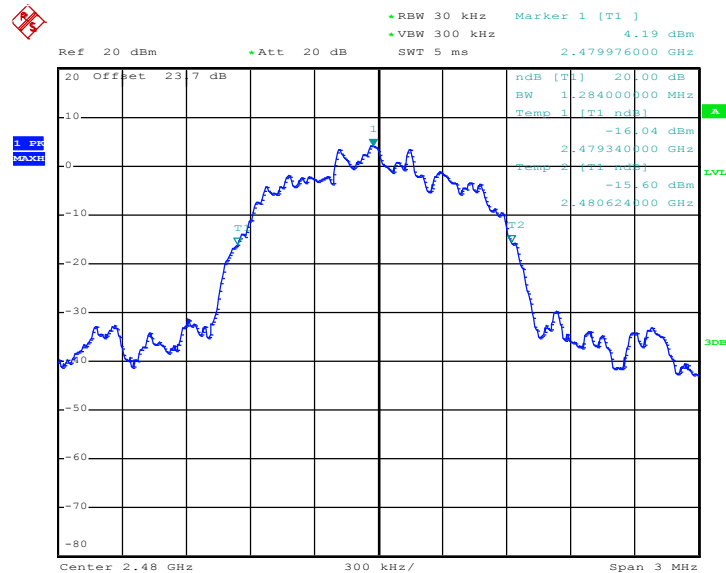

Date: 20.AUG.2012 22:14:44

## 3.5 Peak Output Power Measurement

### 3.5.1 Limit of Peak Output Power

Section 15.247 (b) The maximum peak conducted output power of the intentional radiator shall not exceed the following: (1) For frequency hopping systems operating in the 2400-2483.5 MHz band employing at least 75 non-overlapping hopping channels, and all frequency hopping systems in the 5725-5850 MHz band: 1 watt. For all other frequency hopping systems in the 2400-2483.5 MHz band 0.125 watts. The power limit for 1Mbps is 1watt, and for 2Mbps, and 3Mbps are 0.125 watts.

### 3.5.2 Measuring Instruments

See list of measuring instruments of this test report.

### 3.5.3 Test Procedures

1. The testing follows FCC Public Notice DA 00-705 Measurement Guidelines.
2. The RF output of EUT was connected to the spectrum analyzer by a low loss cable.
3. Set to the maximum power setting and enable the EUT transmit continuously.
4. Measure the conducted output power and record the results in the test report.

### 3.5.4 Test Setup

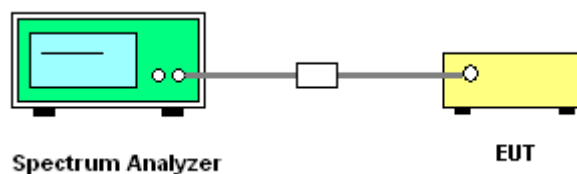



3.5.5 Test Result of Peak Output Power

Test Mode :	1Mbps	Temperature :	24~26°C
Test Engineer :	Book Lin	Relative Humidity :	50~53%

Channel	Frequency (MHz)	RF Power (dBm)		
		GFSK	Max. Limits (dBm)	Pass/Fail
		1 Mbps		
00	2402	10.09	30.00	Pass
39	2441	9.99	30.00	Pass
78	2480	9.67	30.00	Pass

Peak Output Power Plot on Channel 00

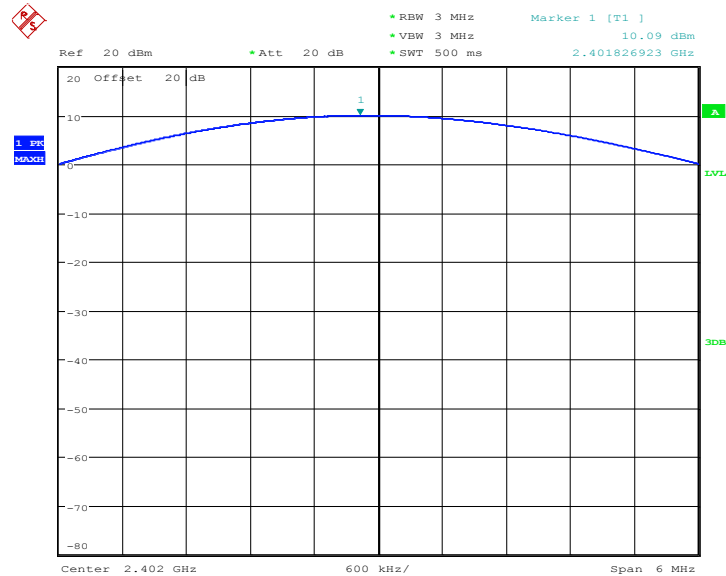

Date: 30.JUL.2012 16:43:45



### Peak Output Power Plot on Channel 39

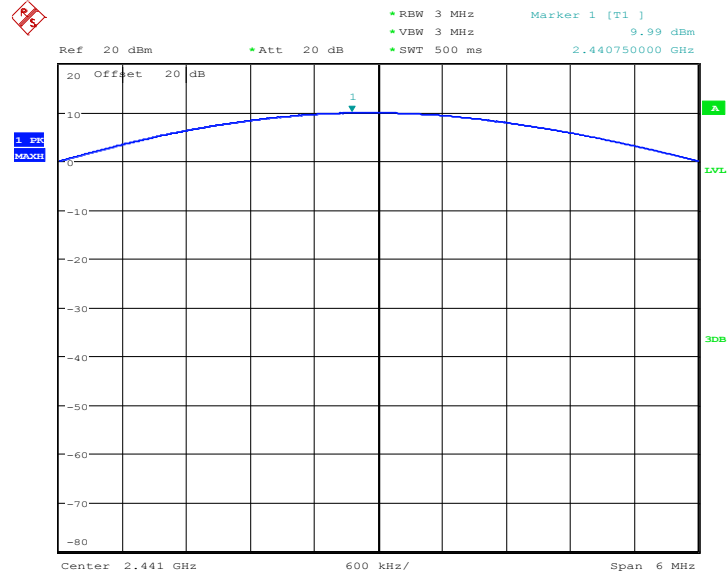

Date: 30.JUL.2012 16:44:57

### Peak Output Power Plot on Channel 78

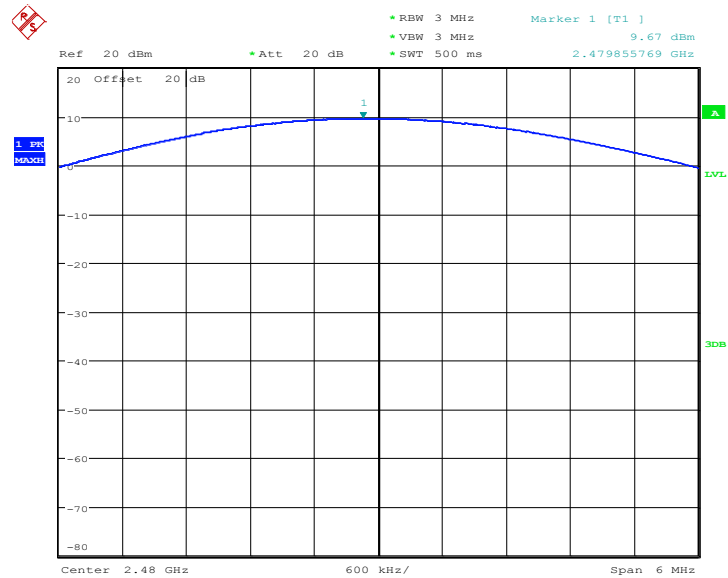

Date: 30.JUL.2012 16:46:09



Test Mode :	2Mbps	Temperature :	24~26°C
Test Engineer :	Book Lin	Relative Humidity :	50~53%

Channel	Frequency (MHz)	RF Power (dBm)		
		$\pi/4$ -DQPSK	Max. Limits (dBm)	Pass/Fail
		2 Mbps		
00	2402	9.74	20.97	Pass
39	2441	9.63	20.97	Pass
78	2480	9.30	20.97	Pass

Peak Output Power Plot on Channel 00

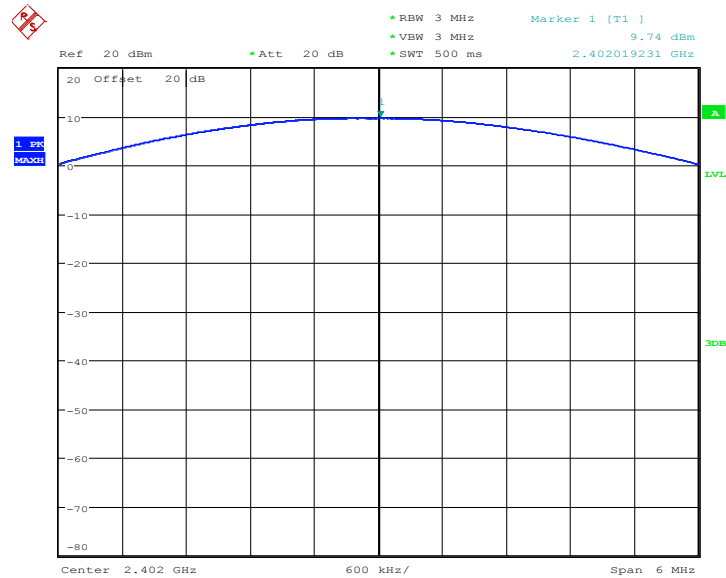

Date: 30.JUL.2012 16:44:09



### Peak Output Power Plot on Channel 39

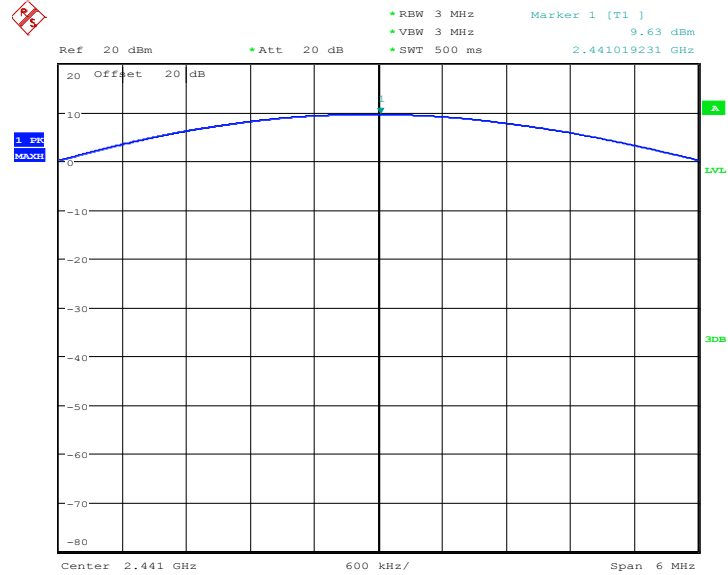

Date: 30.JUL.2012 16:45:21

### Peak Output Power Plot on Channel 78

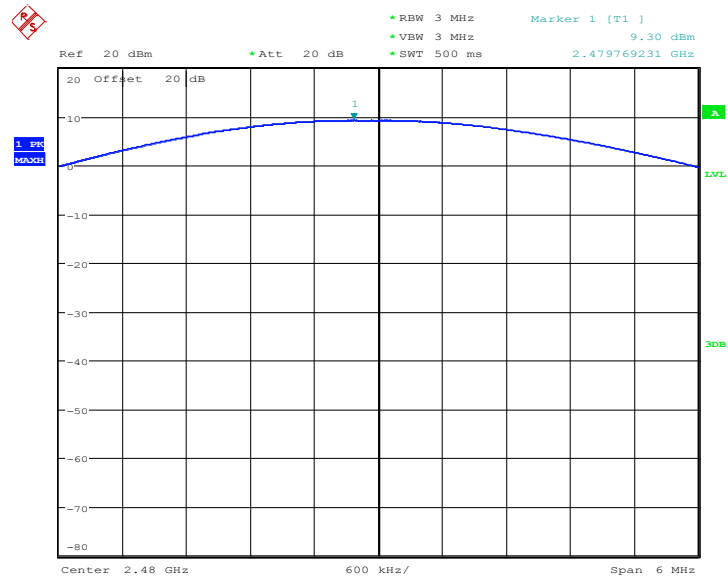

Date: 30.JUL.2012 16:46:33



Test Mode :	3Mbps	Temperature :	24~26°C
Test Engineer :	Book Lin	Relative Humidity :	50~53%

Channel	Frequency (MHz)	RF Power (dBm)		
		8-DPSK	Max. Limits (dBm)	Pass/Fail
		3 Mbps		
00	2402	10.47	20.97	Pass
39	2441	10.28	20.97	Pass
78	2480	9.91	20.97	Pass

Peak Output Power Plot on Channel 00

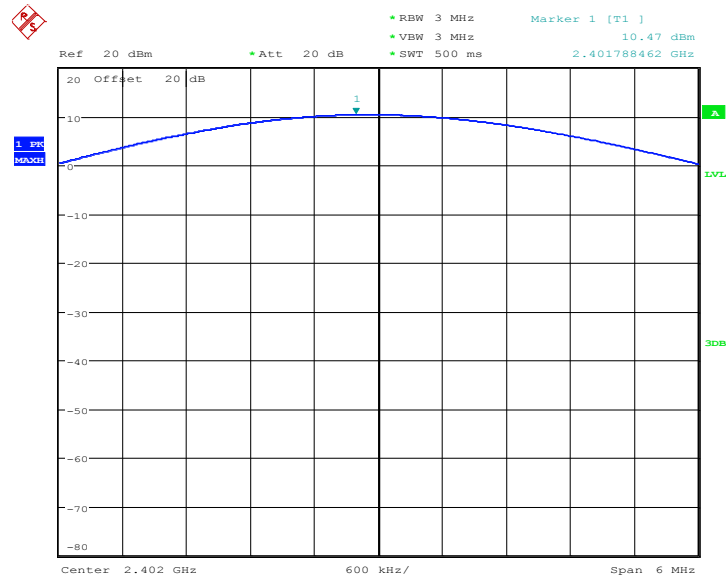

Date: 30.JUL.2012 17:03:26



### Peak Output Power Plot on Channel 39

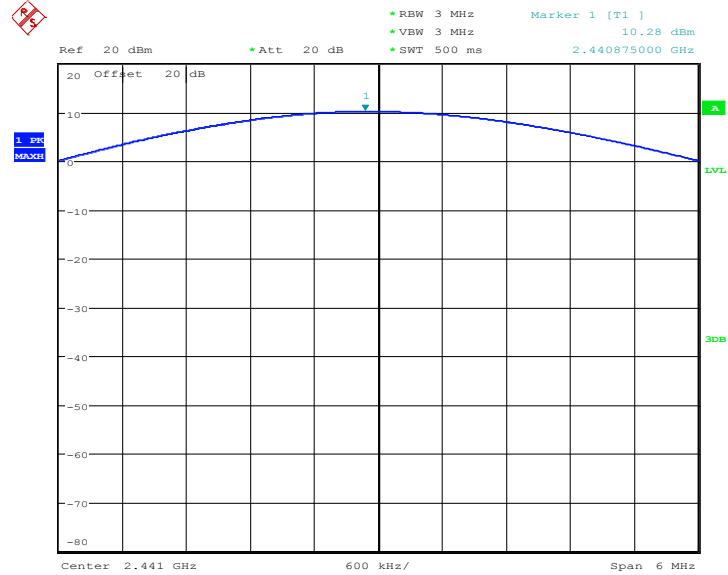

Date: 30.JUL.2012 16:45:45

### Peak Output Power Plot on Channel 78

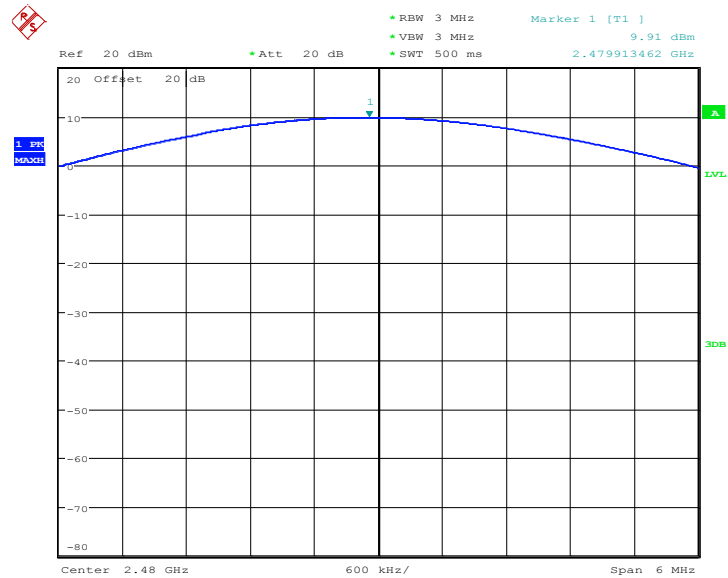

Date: 30.JUL.2012 16:46:58



## 3.6 Conducted Band Edges Measurement

### 3.6.1 Limit of Band Edges

In any 100 KHz bandwidth outside the intentional radiation frequency band, the radio frequency power shall be at least 20 dB below the highest level of the radiated power. In addition, radiated emissions which fall in the restricted bands must also comply with the radiated emission limits.

### 3.6.2 Measuring Instruments

See list of measuring instruments of this test report.

### 3.6.3 Test Procedures

1. The testing follows the guidelines in Band-edge Compliance of RF Conducted Emissions of FCC Public Notice DA 00-705 Measurement Guidelines.
2. Set to the maximum power setting and enable the EUT transmit continuously.
3. Set RBW = 300KHz ( $\geq 1\%$  span=30MHz ), VBW = 300KHz ( $\geq$  RBW). Band edge emissions must be at least 20 dB down from the highest emission level within the authorized band as measured with a 300k Hz RBW. Note: If the device complies with the use of power option 2 the attenuation under this paragraph shall be 30 dB instead of 20 dB.
4. Enable hopping function of the EUT and then repeat step 2. and 3.
5. Record the results in the test report.

### 3.6.4 Test Setup

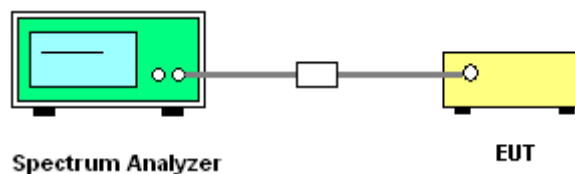

### 7.6.5 Test Result of Conducted Band Edges

Test Mode :	3Mbps	Temperature :	24~26°C
Test Channel :	00 and 78	Relative Humidity :	50~53%
		Test Engineer :	Book Lin

Low Band Edge Plot on Channel 00

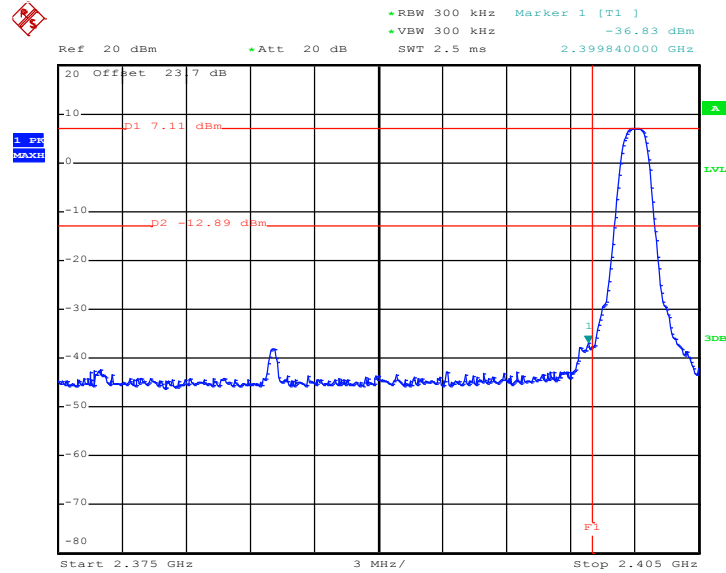

Date: 20.AUG.2012 22:19:38

High Band Edge Plot on Channel 78

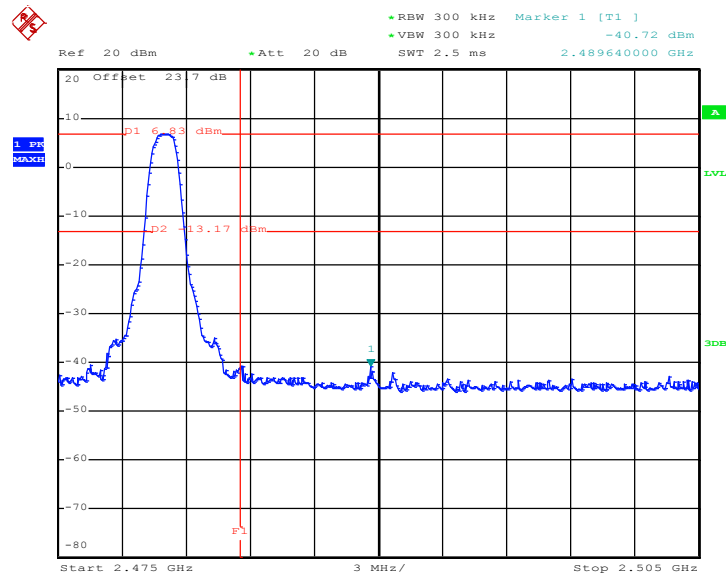

Date: 20.AUG.2012 22:20:44

### 7.6.6 Test Result of Conducted Hopping Mode Band Edges

Test Mode :	3Mbps	Temperature :	24~26°C
Test Engineer :	Book Lin	Relative Humidity :	50~53%

Hopping Mode Low Band Edge Plot

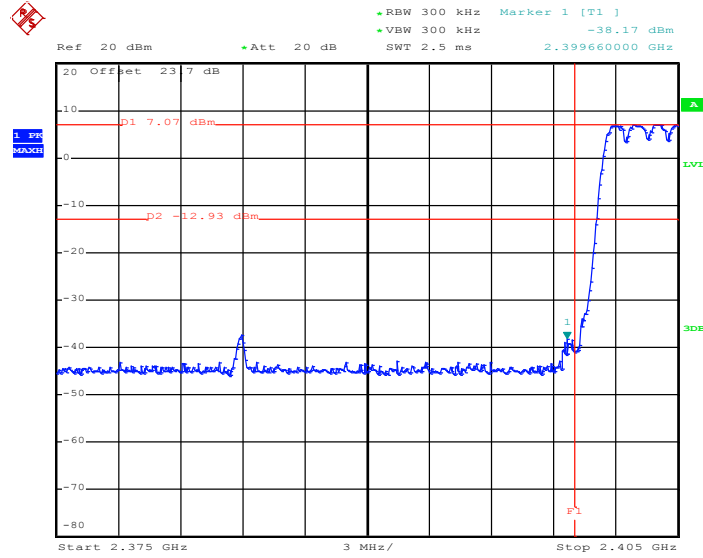

Date: 21.AUG.2012 00:31:24

Hopping Mode High Band Edge Plot

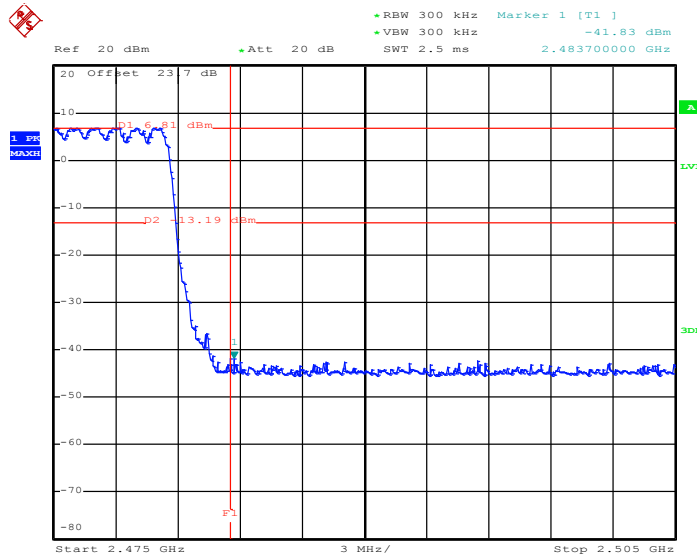

Date: 21.AUG.2012 00:54:13

## 3.7 Conducted Spurious Emission Measurement

### 3.7.1 Limit of Spurious Emission Measurement

In any 100 KHz bandwidth outside the intentional radiation frequency band, the radio frequency power shall be at least 20 dB below the highest level of the radiated power. In addition, radiated emissions which fall in the restricted bands must also comply with the radiated emission limits.

### 3.7.2 Measuring Instruments

See list of measuring instruments of this test report.

### 3.7.3 Test Procedure

1. The testing follows the guidelines in Spurious RF Conducted Emissions of FCC Public Notice DA 00-705 Measurement Guidelines
2. The transmitter output was connected to the spectrum analyzer via a low lose cable.
3. Set to the maximum power setting and enable the EUT transmit continuously.
4. Set RBW = 100 KHz, VBW = 300KHz, scan up through 10th harmonic. All harmonics / spurs must be at least 20 dB down from the highest emission level within the authorized band as measured with a 100 KHz RBW.
5. Record the results in the test report.

### 3.7.4 Test Setup

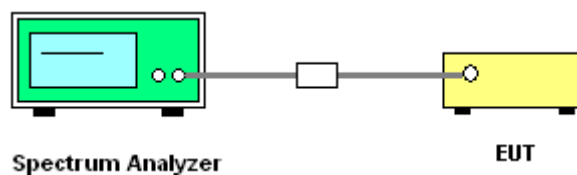



### 3.7.5 Test Result

Test Mode :	3Mbps	Temperature :	24~26°C
Test Channel :	00	Relative Humidity :	50~53%
		Test Engineer :	Book Lin

#### Conducted Spurious Emission Plot between 30MHz ~ 3 GHz

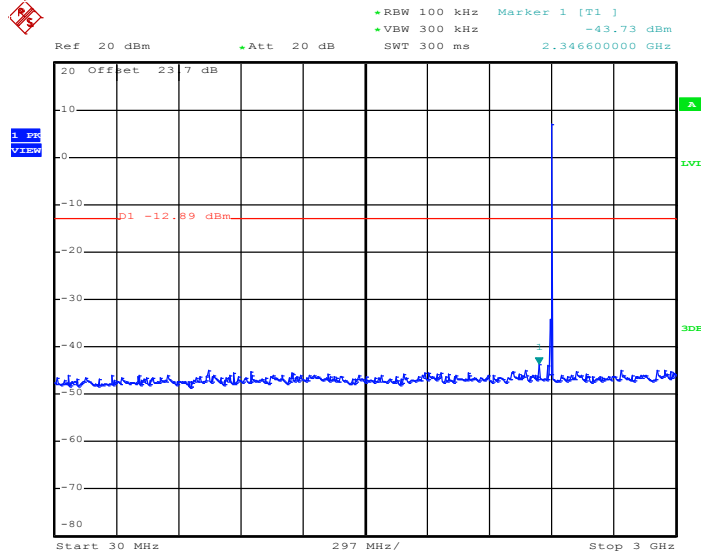

Date: 20.AUG.2012 22:27:28

#### Conducted Spurious Emission Plot between 2 GHz ~ 25 GHz

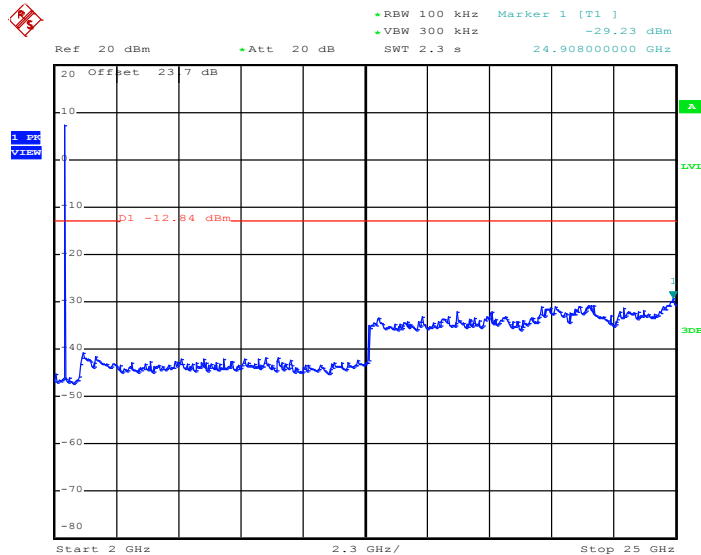

Date: 20.AUG.2012 22:28:22



Test Mode :	3Mbps	Temperature :	24~26°C
Test Channel :	39	Relative Humidity :	50~53%
		Test Engineer :	Book Lin

Conducted Spurious Emission Plot between 30MHz ~ 3 GHz

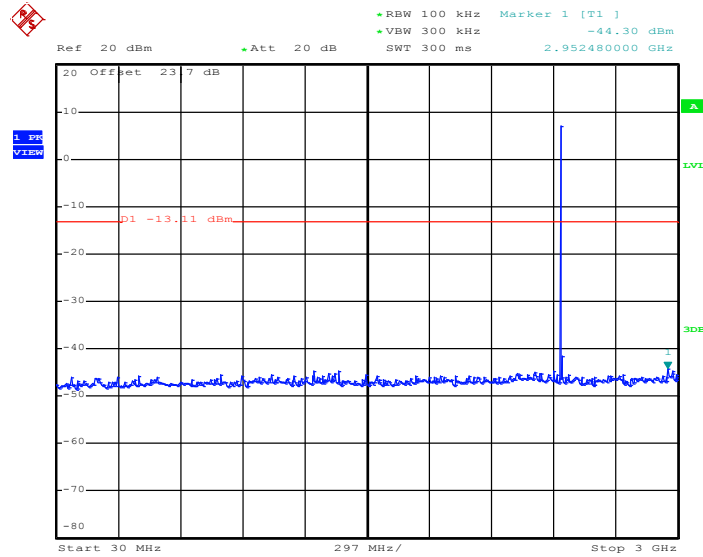

Date: 20.AUG.2012 22:29:15

Conducted Spurious Emission Plot between 2 GHz ~ 25 GHz

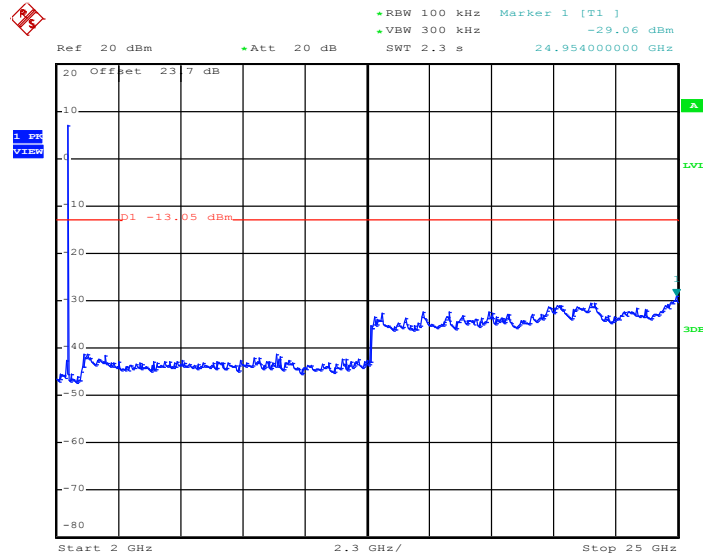

Date: 20.AUG.2012 22:30:11



Test Mode :	3Mbps	Temperature :	24~26°C
Test Channel :	78	Relative Humidity :	50~53%
		Test Engineer :	Book Lin

Conducted Spurious Emission Plot between 30MHz ~ 3 GHz

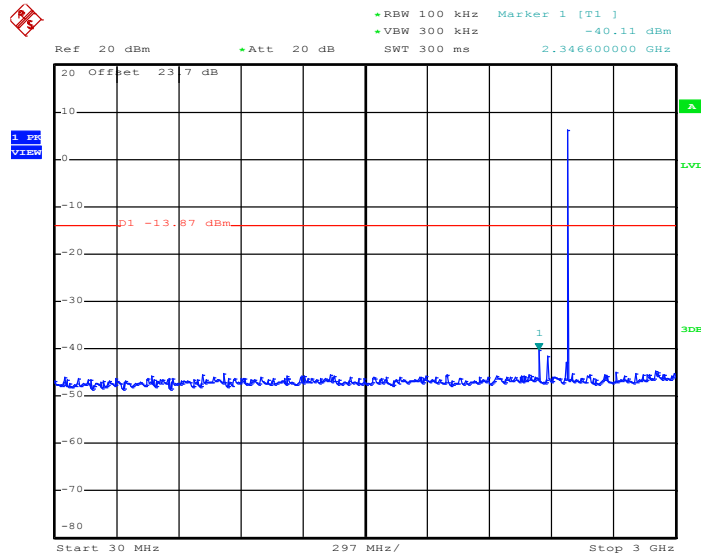

Date: 20.AUG.2012 22:31:05

Conducted Spurious Emission Plot between 2 GHz ~ 25 GHz

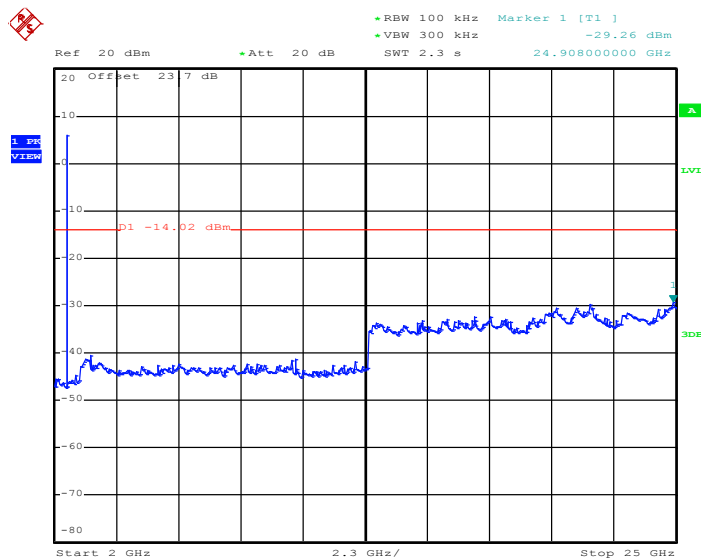

Date: 20.AUG.2012 22:31:59



### 3.8 Radiated Band Edges Measurement

#### 3.8.1 Limit of Radiated Band Edges

In any 100 KHz bandwidth outside the intentional radiator frequency band, all harmonics/spurious must be at least 20 dB below the highest emission level within the authorized band. In addition, radiated emissions which fall in the restricted bands must also comply with the FCC section 15.209 limits as below.

Frequency (MHz)	Field Strength (microvolts/meter)	Measurement Distance (meters)
0.009 – 0.490	2400/F(KHz)	300
0.490 – 1.705	24000/F(KHz)	30
1.705 – 30.0	30	30
30 – 88	100	3
88 – 216	150	3
216 - 960	200	3
Above 960	500	3

#### 3.8.2 Measuring Instruments

See list of measuring instruments of this test report.





### 3.8.3 Test Procedures

1. The testing follows the guidelines in Spurious Radiated Emissions of FCC Public Notice DA 00-705 Measurement Guidelines and fulfills ANSI C63.4-2003 and the guidelines in ANSI C63.10-2009 test site requirement.
2. The EUT was placed on a turntable with 0.8 meter above ground.
3. The EUT was set 3 meters from the interference receiving antenna, which was mounted on the top of a variable height antenna tower.
4. For each suspected emission, the EUT was arranged to its worst case and then tune the Antenna tower (from 1 m to 4 m) and turntable (from 0 degree to 360 degrees) to find the maximum reading. A pre-amp and a high pass filter are used for the test in order to get better signal level to comply with the guidelines.
5. Set to the maximum power setting and enable the EUT transmit continuously.
6. Use the following spectrum analyzer settings:
  - (1) Span shall wide enough to fully capture the emission being measured;
  - (2) Set RBW=100 KHz for  $f < 1$  GHz, RBW=1MHz for  $f > 1$ GHz ; VBW  $\geq$  RBW; Sweep = auto; Detector function = peak; Trace = max hold for peak
  - (3) For average measurement: use duty cycle correction factor method.  
Duty cycle = On time/100 milliseconds  
On time =  $N_1 * L_1 + N_2 * L_2 + \dots + N_{n-1} * L_{n-1} + N_n * L_n$   
Where  $N_1$  is number of type 1 pulses,  $L_1$  is length of type 1 pulses, etc.  
Average Level = Peak Level +  $20 * \log(\text{Duty cycle})$
7. Corrected Reading: Antenna Factor + Cable Loss + Read Level - Preamp Factor = Level

Note: The average levels were calculated from the peak level corrected with duty cycle correction factor (24.5dB) derived from  $20 \log(\text{dwell time}/100\text{ms})$ .

For example: Average level =  $45.61\text{dBuV/m} - 24.5 \text{ (dB)} = 21.11\text{dBuV/m}$ .

### 3.8.4 Test Setup

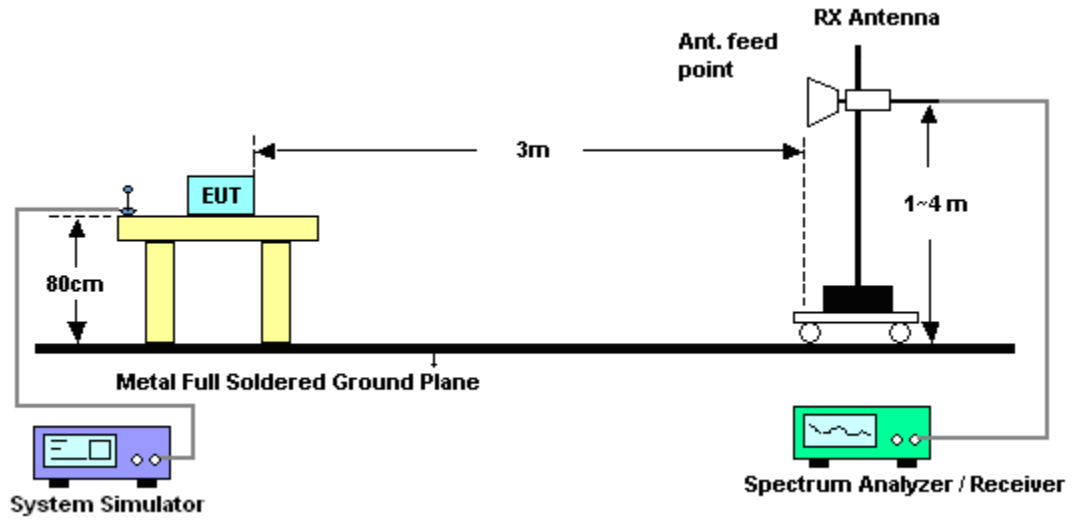

### 3.8.5 Duty cycle correction factor for average measurement

#### 3DH5 on time/100ms (One Pulse) Plot on Channel 39

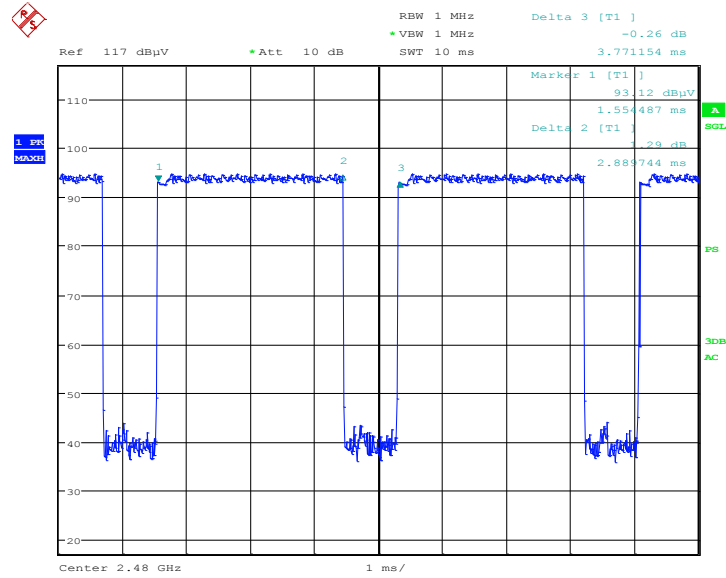

Date: 23.AUG.2012 05:11:23

#### 3DH5 on time/100ms (Count Pulses) Plot on Channel 39

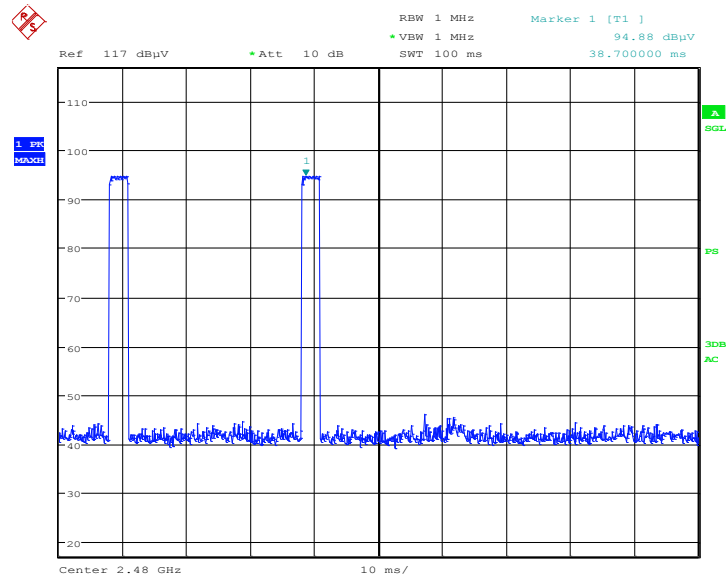

Date: 23.AUG.2012 05:07:33

Note: Duty cycle = on time/100 milliseconds =  $2 * 2.890 / 100 = 5.78 \%$

Duty cycle correction factor =  $20 * \log(\text{Duty cycle}) = -24.76 \text{ dB}$

### 3.8.6 Test Result of Radiated Band Edges

<EUT with Adapter 1>

Test Mode :	3Mbps	Temperature :	22~23°C
Test Channel :	00	Relative Humidity :	50~52%
		Test Engineer :	David Yang

ANTENNA POLARITY : HORIZONTAL										
Frequency ( MHz )	Level ( dBμV/m )	Over Limit ( dB )	Limit Line ( dBμV/m )	Read Level ( dBμV )	Antenna Factor ( dB )	Cable Loss ( dB )	Preamp Factor ( dB )	Ant Pos ( cm )	Table Pos ( deg )	Remark
2371.65	61.85	-12.15	74	61	32.16	4.57	35.88	192	299	Peak
2371.65	37.09	-16.91	54	-	-	-	-	-	-	Average

ANTENNA POLARITY : VERTICAL										
Frequency ( MHz )	Level ( dBμV/m )	Over Limit ( dB )	Limit Line ( dBμV/m )	Read Level ( dBμV )	Antenna Factor ( dB )	Cable Loss ( dB )	Preamp Factor ( dB )	Ant Pos ( cm )	Table Pos ( deg )	Remark
2371.74	53.79	-20.21	74	52.94	32.16	4.57	35.88	190	12	Peak
2371.74	29.03	-24.97	54	-	-	-	-	-	-	Average

Note: The average levels were calculated from the peak level corrected with duty cycle correction factor (24.5dB) derived from 20log (dwell time/100ms).

For example: Average level = 61.85dBuV/m – 24.76 (dB) = 37.09dBuV/m.

Test Mode :	3Mbps	Temperature :	22~23°C
Test Channel :	78	Relative Humidity :	50~52%
		Test Engineer :	David Yang

ANTENNA POLARITY : HORIZONTAL										
Frequency ( MHz )	Level ( dBμV/m )	Over Limit ( dB )	Limit Line ( dBμV/m )	Read Level ( dBμV )	Antenna Factor ( dB )	Cable Loss ( dB )	Preamp Factor ( dB )	Ant Pos ( cm )	Table Pos ( deg )	Remark
2483.5	65.07	-8.93	74	63.96	32.28	4.64	35.81	182	308	Peak
2483.5	40.31	-13.69	54	-	-	-	-	-	-	Average

ANTENNA POLARITY : VERTICAL										
Frequency ( MHz )	Level ( dBμV/m )	Over Limit ( dB )	Limit Line ( dBμV/m )	Read Level ( dBμV )	Antenna Factor ( dB )	Cable Loss ( dB )	Preamp Factor ( dB )	Ant Pos ( cm )	Table Pos ( deg )	Remark
2483.5	57.22	-16.78	74	56.11	32.28	4.64	35.81	100	217	Peak
2483.5	32.46	-21.54	54	-	-	-	-	-	-	Average

<EUT with Docking 1 and Adapter 2>

Test Mode :	3Mbps	Temperature :	22~23°C
Test Channel :	78	Relative Humidity :	50~52%
		Test Engineer :	David Yang

ANTENNA POLARITY : HORIZONTAL										
Frequency ( MHz )	Level ( dBμV/m )	Over Limit ( dB )	Limit Line ( dBμV/m )	Read Level ( dBμV )	Antenna Factor ( dB )	Cable Loss ( dB )	Preamp Factor ( dB )	Ant Pos ( cm )	Table Pos ( deg )	Remark
2483.5	62.51	-11.49	74	61.4	32.28	4.64	35.81	100	116	Peak
2483.5	37.75	-16.25	54	-	-	-	-	-	-	Average

ANTENNA POLARITY : VERTICAL										
Frequency ( MHz )	Level ( dBμV/m )	Over Limit ( dB )	Limit Line ( dBμV/m )	Read Level ( dBμV )	Antenna Factor ( dB )	Cable Loss ( dB )	Preamp Factor ( dB )	Ant Pos ( cm )	Table Pos ( deg )	Remark
2483.5	59.39	-14.61	74	58.28	32.28	4.64	35.81	100	28	Peak
2483.5	34.63	-19.37	54	-	-	-	-	-	-	Average

Note: The average levels were calculated from the peak level corrected with duty cycle correction factor (24.5dB) derived from 20log (dwell time/100ms).

For example: Average level = 62.51dBuV/m – 24.76 (dB) = 37.75dBuV/m.

<EUT with Docking 2 and Car Charger 12V>

Test Mode :	3Mbps	Temperature :	22~23°C
Test Channel :	78	Relative Humidity :	50~52%
		Test Engineer :	David Yang

ANTENNA POLARITY : HORIZONTAL										
Frequency ( MHz )	Level ( dBμV/m )	Over Limit ( dB )	Limit Line ( dBμV/m )	Read Level ( dBμV )	Antenna Factor ( dB )	Cable Loss ( dB )	Preamp Factor ( dB )	Ant Pos ( cm )	Table Pos ( deg )	Remark
2483.5	64.9	-9.1	74	63.79	32.28	4.64	35.81	123	58	Peak

ANTENNA POLARITY : VERTICAL										
Frequency ( MHz )	Level ( dBμV/m )	Over Limit ( dB )	Limit Line ( dBμV/m )	Read Level ( dBμV )	Antenna Factor ( dB )	Cable Loss ( dB )	Preamp Factor ( dB )	Ant Pos ( cm )	Table Pos ( deg )	Remark
2483.52	59.8	-14.2	74	58.69	32.28	4.64	35.81	185	203	Peak



### 3.9 Radiated Spurious Emission Measurement

#### 3.9.1 Limit of Radiated Emission

In any 100 KHz bandwidth outside the intentional radiator frequency band, all harmonics/spurious must be at least 20 dB below the highest emission level within the authorized band. In addition, radiated emissions which fall in the restricted bands must also comply with the FCC section 15.209 limits as below.

Frequency (MHz)	Field Strength (microvolts/meter)	Measurement Distance (meters)
0.009 – 0.490	2400/F(KHz)	300
0.490 – 1.705	24000/F(KHz)	30
1.705 – 30.0	30	30
30 – 88	100	3
88 – 216	150	3
216 - 960	200	3
Above 960	500	3

#### 3.9.2 Measuring Instruments

See list of measuring instruments of this test report.



### 3.9.3 Test Procedures

1. The testing follows the guidelines in Spurious Radiated Emissions of FCC Public Notice DA 00-705 Measurement Guidelines and fulfills ANSI C63.4-2003 and the guidelines in ANSI C63.10-2009 test site requirement.
2. The EUT was placed on a turntable with 0.8 meter above ground.
3. The EUT was set 3 meters from the interference receiving antenna, which was mounted on the top of a variable height antenna tower.
4. For each suspected emission, the EUT was arranged to its worst case and then tune the Antenna tower (from 1 m to 4 m) and turntable (from 0 degree to 360 degrees) to find the maximum reading. A pre-amp and a high pass filter are used for the test in order to get better signal level to comply with the guidelines.
5. Set to the maximum power setting and enable the EUT transmit continuously.
6. Use the following spectrum analyzer settings:
  - (1) Span shall wide enough to fully capture the emission being measured;
  - (2) Set RBW=100 KHz for  $f < 1$  GHz, RBW=1MHz for  $f > 1$ GHz ; VBW  $\geq$  RBW; Sweep = auto; Detector function = peak; Trace = max hold for peak
  - (3) For average measurement: use duty cycle correction factor method.  
Duty cycle = On time/100 milliseconds  
On time =  $N_1 * L_1 + N_2 * L_2 + \dots + N_{n-1} * L_{n-1} + N_n * L_n$   
Where  $N_1$  is number of type 1 pulses,  $L_1$  is length of type 1 pulses, etc.  
Average Level = Peak Level +  $20 * \log(\text{Duty cycle})$
7. Corrected Reading: Antenna Factor + Cable Loss + Read Level - Preamp Factor = Level
8. For measurement below 1GHz, if the emission level of the EUT measured by the peak detector is more than 3 dB lower than the applicable limit, the peak emission level will be reported. Otherwise, the emission measurement by using the quasi-peak detector will be reported.

Note: The average levels were calculated from the peak level corrected with duty cycle correction factor (24.5dB) derived from  $20 \log(\text{dwell time}/100\text{ms})$ .

For example: Average level =  $45.61\text{dBuV/m} - 24.5 \text{ (dB)} = 21.11\text{dBuV/m}$ .

### 3.9.4 Test Setup

For radiated emissions below 30MHz

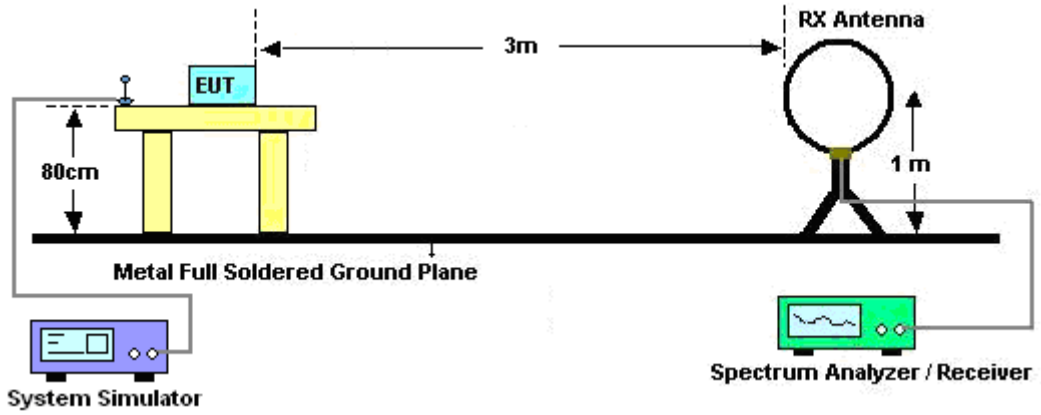

For radiated emissions from 30MHz to 1GHz

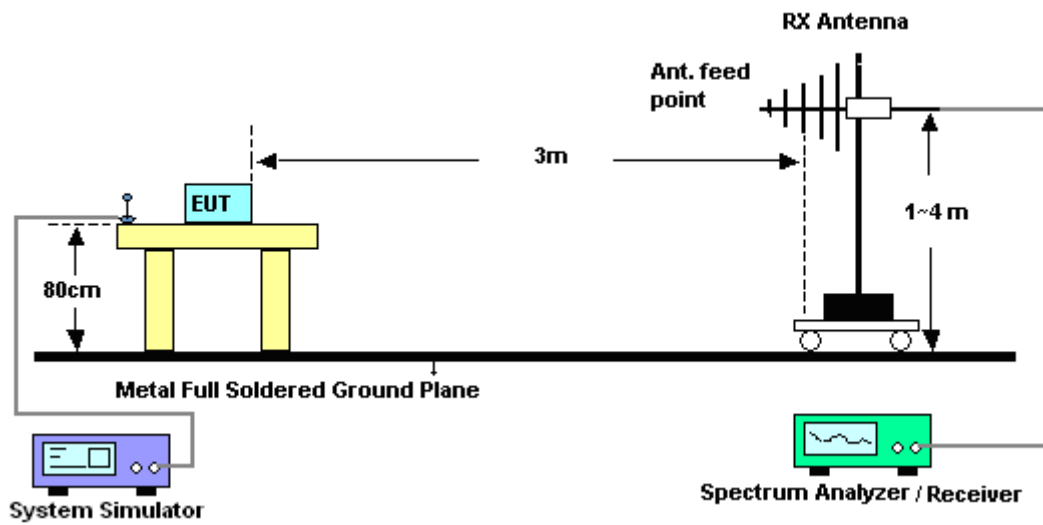



For radiated emissions above 1GHz

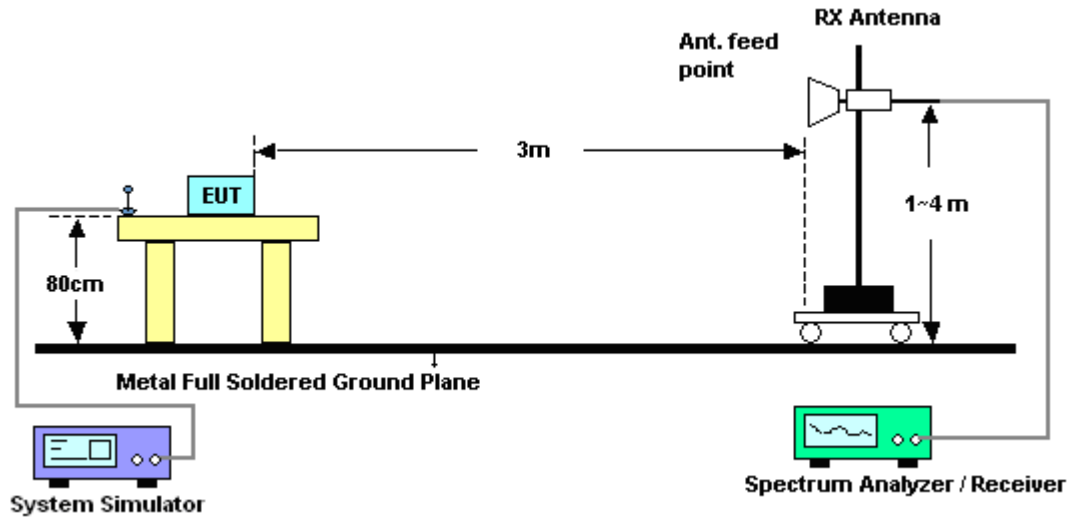

### 3.9.5 Test Results of Radiated Emissions (9 KHz ~ 30 MHz)

The low frequency, which started from 9 KHz to 30MHz, was pre-scanned and the result which was 20dB lower than the limit line per 15.31(o) was not reported.

### 3.9.6 Duty cycle correction factor for average measurement

#### 3DH5 on time/100ms (One Pulse) Plot on Channel 39

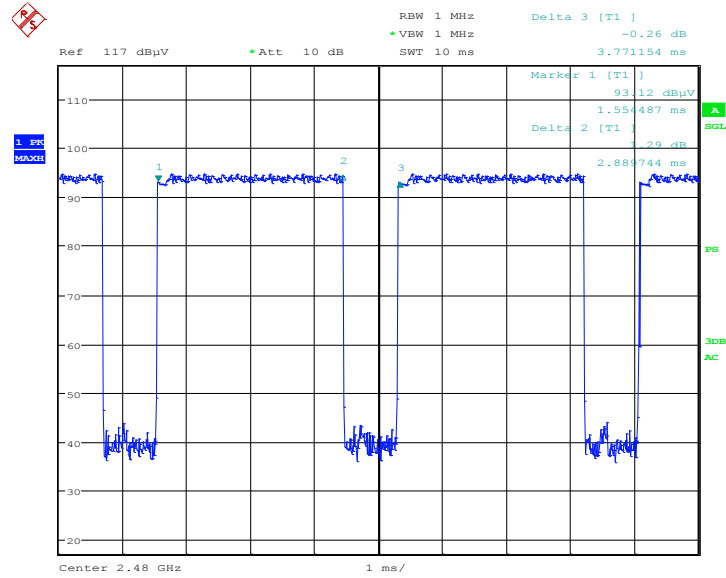

Date: 23.AUG.2012 05:11:23

#### 3DH5 on time/100ms (Count Pulses) Plot on Channel 39

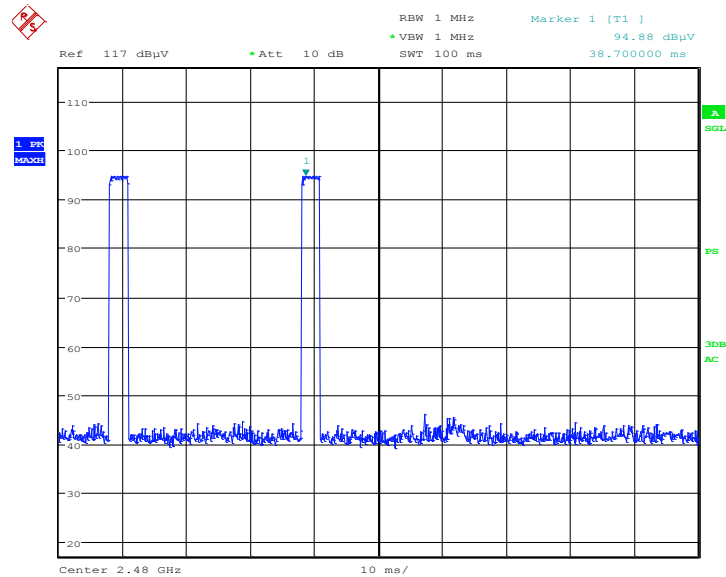

Date: 23.AUG.2012 05:07:33

Note: Duty cycle = on time/100 milliseconds =  $2 * 2.890 / 100 = 5.78 \%$

Duty cycle correction factor =  $20 * \log(\text{Duty cycle}) = -24.76 \text{ dB}$

3.9.7 Test Result of Radiated Emission (30 MHz ~ 10<sup>th</sup> Harmonic)

<EUT with Adapter 1>

Test Mode :	3Mbps	Temperature :	22~23°C
Test Channel :	00	Relative Humidity :	50~52%
Test Engineer :	David Yang	Polarization :	Horizontal
Remark :	1. 2402 MHz is fundamental signal which can be ignored. 2. 7206 MHz and 9606 MHz are not within the restricted band, and there's limit line are 20dB below the highest emission level. For example, 107.63 dBuV/m - 20dB = 87.63dBuV/m.		

Frequency ( MHz )	Level ( dBμV/m )	Over Limit ( dB )	Limit Line ( dBμV/m )	Read Level ( dBμV )	Antenna Factor ( dB )	Cable Loss ( dB )	Preamp Factor ( dB )	Ant Pos ( cm )	Table Pos ( deg )	Remark
2402	107.63	-	-	106.73	32.18	4.58	35.86	192	299	Peak
2402	82.87	-	-	-	-	-	-	-	-	Average
7206	47.67	-39.96	87.63	61.17	36.06	8.25	57.81	100	0	Peak
9606	48.06	-39.57	87.63	57.53	37.02	9.48	55.97	100	0	Peak

Note: The average levels were calculated from the peak level corrected with duty cycle correction factor (24.5dB) derived from 20log (dwell time/100ms).

For example: Average level = 45.61dBuV/m – 24.5 (dB) = 21.11dBuV/m.

Test Mode :	3Mbps	Temperature :	22~23°C
Test Channel :	00	Relative Humidity :	50~52%
Test Engineer :	David Yang	Polarization :	Vertical
Remark :	2402 MHz is fundamental signal which can be ignored.		

Frequency ( MHz )	Level ( dBμV/m )	Over Limit ( dB )	Limit Line ( dBμV/m )	Read Level ( dBμV )	Antenna Factor ( dB )	Cable Loss ( dB )	Preamp Factor ( dB )	Ant Pos ( cm )	Table Pos ( deg )	Remark
2402	101.55	-	-	100.65	32.18	4.58	35.86	190	12	Peak
2402	76.79	-	-							Average



<b>Test Mode :</b>	3Mbps	<b>Temperature :</b>	22~23°C
<b>Test Channel :</b>	39	<b>Relative Humidity :</b>	50~52%
<b>Test Engineer :</b>	David Yang	<b>Polarization :</b>	Horizontal
<b>Remark :</b>	1. 2441 MHz is fundamental signal which can be ignored. 2. 9762 MHz is not within a restricted band.		

Frequency ( MHz )	Level ( dBμV/m )	Over Limit ( dB )	Limit Line ( dBμV/m )	Read Level ( dBμV )	Antenna Factor ( dB )	Cable Loss ( dB )	Preamp Factor ( dB )	Ant Pos ( cm )	Table Pos ( deg )	Remark
2441	107.35	-	-	106.33	32.24	4.61	35.83	102	304	Peak
2441	82.59	-	-	-	-	-	-	-	-	Average
7323	48.21	-25.79	74	61.77	36.03	8.42	58.01	100	0	Peak
7323	23.45	-30.55	54	-	-	-	-	-	-	Average
9762	47.41	-39.94	87.35	56.59	37.21	9.5	55.89	100	0	Peak

<b>Test Mode :</b>	3Mbps	<b>Temperature :</b>	22~23°C
<b>Test Channel :</b>	39	<b>Relative Humidity :</b>	50~52%
<b>Test Engineer :</b>	David Yang	<b>Polarization :</b>	Vertical
<b>Remark :</b>	2441 MHz is fundamental signal which can be ignored.		

Frequency ( MHz )	Level ( dBμV/m )	Over Limit ( dB )	Limit Line ( dBμV/m )	Read Level ( dBμV )	Antenna Factor ( dB )	Cable Loss ( dB )	Preamp Factor ( dB )	Ant Pos ( cm )	Table Pos ( deg )	Remark
2441	100.81	-	-	99.79	32.24	4.61	35.83	184	10	Peak
2441	76.05	-	-	-	-	-	-	-	-	Average



<b>Test Mode :</b>	3Mbps	<b>Temperature :</b>	22~23°C
<b>Test Channel :</b>	78	<b>Relative Humidity :</b>	50~52%
<b>Test Engineer :</b>	David Yang	<b>Polarization :</b>	Horizontal
<b>Remark :</b>	1. 2480 MHz is fundamental signal which can be ignored. 2. 9918 MHz is not within a restricted band.		

Frequency ( MHz )	Level ( dBμV/m )	Over Limit ( dB )	Limit Line ( dBμV/m )	Read Level ( dBμV )	Antenna Factor ( dB )	Cable Loss ( dB )	Preamp Factor ( dB )	Ant Pos ( cm )	Table Pos ( deg )	Remark
36.75	26.52	-13.48	40	42.23	15.16	0.74	31.61	188	67	Peak
113.7	26.76	-16.74	43.5	45.46	11.6	1.17	31.47	-	-	Peak
198.75	28.22	-15.28	43.5	48.84	9.04	1.46	31.12	-	-	Peak
398	30.08	-15.92	46	43.36	15.9	2.01	31.19	-	-	Peak
454.7	30.15	-15.85	46	41.69	17.3	2.15	30.99	-	-	Peak
682.9	30	-16	46	37.09	20.46	2.63	30.18	-	-	Peak
2480	108.38	-	-	107.27	32.28	4.64	35.81	182	308	Peak
2480	83.62	-	-	-	-	-	-	-	-	Average
7440	48.14	-25.86	74	61.71	36.01	8.63	58.21	100	0	Peak
7440	23.38	-30.62	54	-	-	-	-	-	-	Average
9918	46.32	-42.06	88.38	55.19	37.42	9.51	55.8	100	0	Peak



<b>Test Mode :</b>	3Mbps	<b>Temperature :</b>	22~23°C
<b>Test Channel :</b>	78	<b>Relative Humidity :</b>	50~52%
<b>Test Engineer :</b>	David Yang	<b>Polarization :</b>	Vertical
<b>Remark :</b>	2480 MHz is fundamental signal which can be ignored.		

Frequency ( MHz )	Level ( dBμV/m )	Over Limit ( dB )	Limit Line ( dBμV/m )	Read Level (dBμV)	Antenna Factor ( dB )	Cable Loss ( dB )	Preamp Factor ( dB )	Ant Pos ( cm )	Table Pos ( deg )	Remark
34.86	35.68	-4.32	40	50.17	16.4	0.74	31.63	100	221	Peak
104.25	27.33	-16.17	43.5	46.99	10.7	1.12	31.48	-	-	Peak
193.62	30.16	-13.34	43.5	51.04	8.78	1.45	31.11	-	-	Peak
398	30.75	-15.25	46	44.03	15.9	2.01	31.19	-	-	Peak
568.8	32.44	-13.56	46	40.92	19.97	2.36	30.81	-	-	Peak
910.4	33.02	-12.98	46	36.39	23.63	3.02	30.02	-	-	Peak
2480	100.78	-	-	99.67	32.28	4.64	35.81	100	217	Peak
2480	76.02	-	-	-	-	-	-	-	-	Average



<EUT with Docking 1 and Adapter 2>

Test Mode :	3Mbps	Temperature :	22~23°C
Test Channel :	78	Relative Humidity :	50~52%
Test Engineer :	David Yang	Polarization :	Horizontal
Remark :	1. 2480 MHz is fundamental signal which can be ignored. 2. 14880 MHz is not within a restricted band.		

Frequency ( MHz )	Level ( dBμV/m )	Over Limit ( dB )	Limit Line ( dBμV/m )	Read Level (dBμV)	Antenna Factor ( dB )	Cable Loss ( dB )	Preamp Factor ( dB )	Ant Pos ( cm )	Table Pos ( deg )	Remark
31.35	30.32	-9.68	40	42.13	19.12	0.71	31.64	-	-	Peak
204.96	30.44	-13.06	43.5	50.97	9.15	1.48	31.16	-	-	Peak
236.82	36.28	-9.72	46	54.57	11.04	1.61	30.94	-	-	Peak
341.3	37.34	-8.66	46	52.46	14.14	1.88	31.14	170	302	Peak
398	33.04	-12.96	46	46.32	15.9	2.01	31.19	-	-	Peak
568.8	30.08	-15.92	46	38.56	19.97	2.36	30.81	-	-	Peak
2480	106.07	-	-	104.96	32.28	4.64	35.81	100	116	Peak
2480	81.31	-	-	-	-	-	-	-	-	Average
7440	47.96	-26.04	74	61.53	36.01	8.63	58.21	100	0	Peak
7440	23.2	-30.8	54	-	-	-	-	-	-	Average
12399	47.76	-26.24	74	54.21	39.23	10.61	56.29	100	0	Peak
12399	23	-31	54	-	-	-	-	-	-	Average
14880	49.81	-36.26	86.07	55.31	40.12	11.7	57.32	100	0	Peak



<b>Test Mode :</b>	3Mbps	<b>Temperature :</b>	22~23°C
<b>Test Channel :</b>	78	<b>Relative Humidity :</b>	50~52%
<b>Test Engineer :</b>	David Yang	<b>Polarization :</b>	Vertical
<b>Remark :</b>	2480 MHz is fundamental signal which can be ignored.		

Frequency ( MHz )	Level ( dBμV/m )	Over Limit ( dB )	Limit Line ( dBμV/m )	Read Level (dBμV)	Antenna Factor ( dB )	Cable Loss ( dB )	Preamp Factor ( dB )	Ant Pos ( cm )	Table Pos ( deg )	Remark
31.35	34.53	-5.47	40	46.34	19.12	0.71	31.64	100	152	Peak
202.26	28.61	-14.89	43.5	49.15	9.13	1.47	31.14	-	-	Peak
227.37	31.37	-14.63	46	50.8	9.93	1.57	30.93	-	-	Peak
341.3	34.72	-11.28	46	49.84	14.14	1.88	31.14	-	-	Peak
398	33.99	-12.01	46	47.27	15.9	2.01	31.19	-	-	Peak
568.8	33.08	-12.92	46	41.56	19.97	2.36	30.81	-	-	Peak
2480	102.89	-	-	101.78	32.28	4.64	35.81	100	28	Peak
2480	78.13	-	-	-	-	-	-	-	-	Average
7440	44.99	-29.01	74	58.56	36.01	8.63	58.21	100	0	Peak
7440	20.23	-33.77	54	-	-	-	-	-	-	Average





<EUT with Docking 2 and Car Charger 12V>

Test Mode :	3Mbps	Temperature :	22~23°C
Test Channel :	78	Relative Humidity :	50~52%
Test Engineer :	David Yang	Polarization :	Horizontal
Remark :	2480 MHz is fundamental signal which can be ignored.		

Frequency ( MHz )	Level ( dBμV/m )	Over Limit ( dB )	Limit Line ( dBμV/m )	Read Level (dBμV)	Antenna Factor ( dB )	Cable Loss ( dB )	Preamp Factor ( dB )	Ant Pos ( cm )	Table Pos ( deg )	Remark
32.97	28.76	-11.24	40	41.91	17.76	0.72	31.63	115	341	Peak
165	28.38	-15.12	43.5	48.07	10.1	1.36	31.15	-	-	Peak
195.51	25.55	-17.95	43.5	46.36	8.86	1.45	31.12	-	-	Peak
341.3	32.98	-13.02	46	48.1	14.14	1.88	31.14	-	-	Peak
398	32.56	-13.44	46	45.84	15.9	2.01	31.19	-	-	Peak
568.8	31.19	-14.81	46	39.67	19.97	2.36	30.81	-	-	Peak
2480	108.69	-	-	107.58	32.28	4.64	35.81	123	58	Peak
2480	83.93	-	-	-	-	-	-	-	-	Average
4962	42.63	-31.37	74	60.42	34.29	6.57	58.65	100	0	Peak
4962	17.87	-36.13	54	-	-	-	-	-	-	Average
7440	47.32	-26.68	74	60.89	36.01	8.63	58.21	100	0	Peak
7440	22.56	-31.44	54	-	-	-	-	-	-	Average



<b>Test Mode :</b>	3Mbps	<b>Temperature :</b>	22~23°C
<b>Test Channel :</b>	78	<b>Relative Humidity :</b>	50~52%
<b>Test Engineer :</b>	David Yang	<b>Polarization :</b>	Vertical
<b>Remark :</b>	2480 MHz is fundamental signal which can be ignored.		

Frequency ( MHz )	Level ( dBμV/m )	Over Limit ( dB )	Limit Line ( dBμV/m )	Read Level (dBμV)	Antenna Factor ( dB )	Cable Loss ( dB )	Preamp Factor ( dB )	Ant Pos ( cm )	Table Pos ( deg )	Remark
32.97	32.03	-7.97	40	45.18	17.76	0.72	31.63	105	78	Peak
66.72	22.03	-17.97	40	46.61	6.06	0.89	31.53	-	-	Peak
195.78	27.06	-16.44	43.5	47.87	8.86	1.45	31.12	-	-	Peak
341.3	34.29	-11.71	46	49.41	14.14	1.88	31.14	-	-	Peak
398	32.75	-13.25	46	46.03	15.9	2.01	31.19	-	-	Peak
960.1	36.98	-17.02	54	39.03	24.9	3.1	30.05	-	-	Peak
2480	103.4	-	-	102.29	32.28	4.64	35.81	185	203	Peak
2480	78.64	-	-	-	-	-	-	-	-	Average

### 3.10 AC Conducted Emission Measurement

#### 3.10.1 Limit of AC Conducted Emission

For equipment that is designed to be connected to the public utility (AC) power line, the radio frequency voltage that is conducted back onto the AC power line on any frequency or frequencies within the band 150 KHz to 30 MHz shall not exceed the limits in the following table.

Frequency of emission (MHz)	Conducted limit (dBuV)	
	Quasi-peak	Average
0.15-0.5	66 to 56*	56 to 46*
0.5-5	56	46
5-30	60	50

\*Decreases with the logarithm of the frequency.

#### 3.10.2 Measuring Instruments

See list of measuring instruments of this test report.

#### 3.10.3 Test Procedures

1. The test follows the guidelines in ANSI C63.4-2003 and ANSI C63.10-2009 test site requirement.
2. The EUT was placed 0.4 meter from the conducting wall of the shielding room was kept at least 80 centimeters from any other grounded conducting surface.
3. Connect EUT to the power mains through a line impedance stabilization network (LISN).
4. All the support units are connecting to the other LISN.
5. The LISN provides 50 ohm coupling impedance for the measuring instrument.
6. The FCC states that a 50 ohm, 50 microhenry LISN should be used.
7. Both sides of AC line were checked for maximum conducted interference.
8. The frequency range from 150 KHz to 30 MHz was searched.
9. Set the test-receiver system to Peak Detect Function and specified bandwidth with Maximum Hold Mode.

### 3.10.4 Test Setup



3.10.5 Test Result of AC Conducted Emission

Test Mode :	Mode 3	Temperature :	20~22°C
Test Engineer :	Kai-Chun Chu	Relative Humidity :	49~51%
Test Voltage :	120Vac / 60Hz	Phase :	Line
Function Type :	GSM1900 (GPRS 8) Idle + WLAN Link + Bluetooth Link + RFID On + MPEG4 + TC3		
Remark :	All emissions not reported here are more than 10 dB below the prescribed limit. 13.558 MHz is fundamental signal of RFID/NFC which can be ignored.		

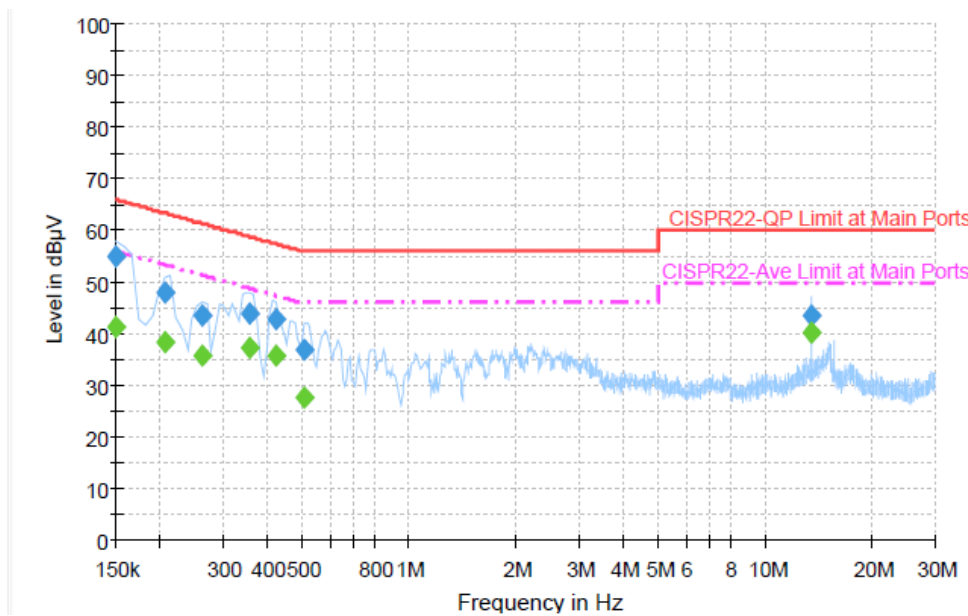

Final Result : Quasi-Peak

Frequency (MHz)	Quasi-Peak (dBµV)	Filter	Line	Corr. (dB)	Margin (dB)	Limit (dBµV)
0.150000	54.8	Off	L1	19.4	11.2	66.0
0.206000	48.1	Off	L1	19.4	15.3	63.4
0.262000	43.4	Off	L1	19.4	18.0	61.4
0.358000	43.8	Off	L1	19.4	15.0	58.8
0.422000	43.0	Off	L1	19.4	14.4	57.4
0.510000	37.0	Off	L1	19.4	19.0	56.0
13.558000	43.4	Off	L1	19.8	16.6	60.0

Final Result : Average

Frequency (MHz)	Average (dBµV)	Filter	Line	Corr. (dB)	Margin (dB)	Limit (dBµV)
0.150000	41.2	Off	L1	19.4	14.8	56.0
0.206000	38.4	Off	L1	19.4	15.0	53.4
0.262000	35.6	Off	L1	19.4	15.8	51.4
0.358000	37.3	Off	L1	19.4	11.5	48.8
0.422000	35.7	Off	L1	19.4	11.7	47.4
0.510000	27.6	Off	L1	19.4	18.4	46.0
13.558000	40.2	Off	L1	19.8	9.8	50.0

Test Mode :	Mode 3	Temperature :	20~22°C
Test Engineer :	Kai-Chun Chu	Relative Humidity :	49~51%
Test Voltage :	120Vac / 60Hz	Phase :	Neutral
Function Type :	GSM1900 (GPRS 8) Idle + WLAN Link + Bluetooth Link + RFID On + MPEG4 + TC3		
Remark :	All emissions not reported here are more than 10 dB below the prescribed limit. 13.558 MHz is fundamental signal of RFID/NFC which can be ignored.		

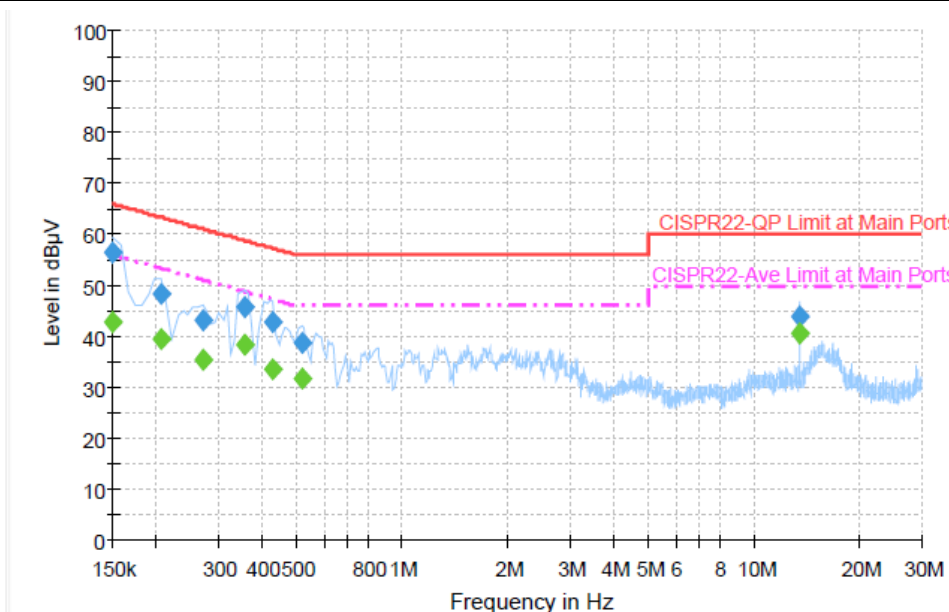

**Final Result : Quasi-Peak**

Frequency (MHz)	Quasi-Peak (dBµV)	Filter	Line	Corr. (dB)	Margin (dB)	Limit (dBµV)
0.150000	56.6	Off	N	19.4	9.4	66.0
0.206000	48.4	Off	N	19.4	15.0	63.4
0.270000	43.3	Off	N	19.4	17.8	61.1
0.358000	45.6	Off	N	19.4	13.2	58.8
0.430000	42.9	Off	N	19.4	14.4	57.3
0.518000	38.8	Off	N	19.4	17.2	56.0
13.558000	43.9	Off	N	19.9	16.1	60.0

**Final Result : Average**

Frequency (MHz)	Average (dBµV)	Filter	Line	Corr. (dB)	Margin (dB)	Limit (dBµV)
0.150000	42.8	Off	N	19.4	13.2	56.0
0.206000	39.6	Off	N	19.4	13.8	53.4
0.270000	35.4	Off	N	19.4	15.7	51.1
0.358000	38.3	Off	N	19.4	10.5	48.8
0.430000	33.7	Off	N	19.4	13.6	47.3
0.518000	31.6	Off	N	19.4	14.4	46.0
13.558000	40.8	Off	N	19.9	9.2	50.0



## **3.11 Antenna Requirements**

### **3.11.1 Standard Applicable**

If directional gain of transmitting antennas is greater than 6dBi, the power shall be reduced by the same level in dB comparing to gain minus 6dBi. The use of a permanently attached antenna or of an antenna that uses a unique coupling to the intentional radiator shall be considered sufficient to comply with the FCC rule.

### **3.11.2 Antenna Connected Construction**

Non-standard connector used.

### **3.11.3 Antenna Gain**

The antenna peak gain of EUT is less than 6 dBi. Therefore, it is not necessary to reduce maximum peak output power limit.

## 4 List of Measuring Equipment

Instrument	Manufacturer	Model No.	Serial No.	Characteristics	Calibration Date	Test Date	Due Date	Remark
Spectrum Analyzer	R&S	FSP40	100055	9kHz~40GHz	Jun. 06, 2012	Jul. 30, 2012 ~ Aug. 21, 2012	Jun. 05, 2013	Conducted (TH02-HY)
Bluetooth Base Station	R&S	CBT32	100519	N/A	Jun. 05, 2012	Jul. 30, 2012 ~ Aug. 21, 2012	Jun. 06, 2013	Conducted (TH02-HY)
Spectrum Analyzer	R&S	ESU26	100390	20Hz ~ 26.5GHz	Dec. 22, 2011	Aug. 23, 2012 ~ Aug. 24, 2012	Dec. 21, 2012	Radiation (03CH05-HY)
Bilog Antenna	SCHAFFNER	CBL6111C	2725	30MHz ~ 2GHz	Oct. 22, 2011	Aug. 23, 2012 ~ Aug. 24, 2012	Oct. 21, 2012	Radiation (03CH05-HY)
Turn Table	HD	Deis HD 2000	420/611	0 ~ 360 degree	N/A	Aug. 23, 2012 ~ Aug. 24, 2012	N/A	Radiation (03CH05-HY)
Antenna Mast	HD	MA 240	240/666	1 m ~ 4 m	N/A	Aug. 23, 2012 ~ Aug. 24, 2012	N/A	Radiation (03CH05-HY)
Horn Antenna	ESCO	3117	66584	1GHz~18GHz	Aug. 10, 2012	Aug. 23, 2012 ~ Aug. 24, 2012	Aug. 09, 2013	Radiation (03CH05-HY)
Pre Amplifier	COM-POWER	PA-103A	161075	10Hz ~ 1000MHz Gain:32dB	Feb. 27, 2012	Aug. 23, 2012 ~ Aug. 24, 2012	Feb. 26, 2013	Radiation (03CH05-HY)
Pre Amplifier	MITEQ	AMF-7D-001 01800-30-10 P	159087	1GHz~18GHz	Feb. 27, 2012	Aug. 23, 2012 ~ Aug. 24, 2012	Feb. 26, 2013	Radiation (03CH05-HY)
Pre Amplifier	Agilent	8449B	3008A01917	1GHz~26.5GHz	Aug. 30, 2011	Aug. 23, 2012 ~ Aug. 24, 2012	Aug. 29, 2012	Radiation (03CH05-HY)
SHF-EHF Horn Antenna	SCHWARZBECK	BBHA 9170	BBHA91702 51	15GHz ~ 40GHz	Oct. 21, 2011	Aug. 23, 2012 ~ Aug. 24, 2012	Oct. 20, 2012	Radiation (03CH05-HY)
Bluetooth Base Station	R&S	CBT32	100519	N/A	Jun. 05, 2012	Aug. 23, 2012 ~ Aug. 24, 2012	Jun. 06, 2013	Radiation (03CH05-HY)
Loop Antenna	R&S	HFH2-Z2	860004/001	9KHz ~ 30MHz	Jul. 03, 2012	Aug. 23, 2012 ~ Aug. 24, 2012	Jul. 02, 2014	Radiation (03CH05-HY)
EMI Test Receiver	R&S	ESCS 30	100356	9KHz ~ 2.75GHz	Oct. 27, 2011	Jul. 13, 2012 ~ Aug. 29, 2012	Oct. 26, 2012	Conduction (CO05-HY)
Two-LISN	R&S	ENV216	11-100081	9KHz ~ 30MHz	Dec. 09, 2011	Jul. 13, 2012 ~ Aug. 29, 2012	Dec. 08, 2012	Conduction (CO05-HY)
Two-LISN	R&S	ENV216	11-100080	9KHz ~ 30MHz	Dec. 06, 2011	Jul. 13, 2012 ~ Aug. 29, 2012	Dec. 05, 2012	Conduction (CO05-HY)
AC Power Source	APC	APC-1000W	N/A	N/A	N/A	Jul. 13, 2012 ~ Aug. 29, 2012	N/A	Conduction (CO05-HY)
System Simulator	R&S	CMU200	117997	N/A	Aug. 22, 2011	Jul. 13, 2012 ~ Aug. 29, 2012	Aug. 21, 2013	Conduction (CO05-HY)





## 5 Uncertainty of Evaluation

### Uncertainty of Conducted Emission Measurement (150 KHz ~ 30 MHz)

Measuring Uncertainty for a Level of Confidence of 95% ( $U = 2Uc(y)$ )	2.26
---	------

### Uncertainty of Radiated Emission Measurement (30 MHz ~ 1000 MHz)

Measuring Uncertainty for a Level of Confidence of 95% ( $U = 2Uc(y)$ )	2.54
---	------

### Uncertainty of Radiated Emission Measurement (1 GHz ~ 40 GHz)

Measuring Uncertainty for a Level of Confidence of 95% ( $U = 2Uc(y)$ )	4.72
---	------



## **Appendix A. Photographs of EUT**

Please refer to Sporton report number EP262032-02 as below.