

RADIO TEST REPORT

FCC 47 CFR PART 15 SUBPART C

INDUSTRY CANADA RSS-247

Test Standard	FCC Part 15.247 IC RSS-247 issue 2 and IC RSS-GEN issue 5
Product name	Body Worn Camera
Brand Name	Getac
Model No.	BC-03
Test Result	Pass

The test Result was tested by Compliance Certification Services Inc. The test data, data evaluation, test procedures, and equipment configurations shown in this report were given in ANSI C63.10: 2013 and compliance standards.

The test results of this report relate only to the tested sample (EUT) identified in this report.

The test Report of full or partial shall not copy. Without written approval of Compliance Certification Services Inc.(Wugu Laboratory)

Approved by:

Tested by:



Kevin Tsai
Deputy Manager



Jerry Chuang
Engineer

Unless otherwise stated the results shown in this test report refer only to the sample(s) tested and such sample(s) are retained for 90 days only.
除非另有說明，此報告結果僅對測試之樣品負責，同時此樣品僅保留90天。本報告未經本公司書面許可，不可部分複製。

This document is issued by the Company subject to its General Conditions of Service printed overleaf, available on request or accessible at www.sgs.com/terms_and_conditions.htm and for electronic format documents, subject to Terms and Conditions for Electronic Documents at www.sgs.com/terms_e-document.htm. Attention is drawn to the limitation of liability, indemnification and jurisdiction issues defined therein. Any holder of this document is advised that information contained hereon reflects the Company's findings at the time of its intervention only and within the limits of Client's instructions, if any. The Company's sole responsibility is to its Client and this document does not exonerate parties to a transaction from exercising all their rights and obligations under the transaction documents. This document cannot be reproduced except in full, without prior written approval of the Company. Any unauthorized alteration, forgery or falsification of the content or appearance of this document is unlawful and offenders may be prosecuted to the fullest extent of the law.



Report No.: T181222W01-RP2

Page: 2 / 44
Rev.: 00

Revision History

Rev.	Issue Date	Revisions	Effect Page	Revised By
00	April 18, 2019	Initial Issue	ALL	May Lin

Table of contents

1.	GENERAL INFORMATION	4
1.1	EUT INFORMATION	4
1.2	EUT CHANNEL INFORMATION	5
1.3	ANTENNA INFORMATION	5
1.4	MEASUREMENT UNCERTAINTY	6
1.5	FACILITIES AND TEST LOCATION	7
1.6	INSTRUMENT CALIBRATION	7
1.7	SUPPORT AND EUT ACCESSORIES EQUIPMENT	9
2.	TEST SUMMERY	10
3.	DESCRIPTION OF TEST MODES.....	11
3.1	THE WORST MODE OF OPERATING CONDITION	11
3.2	THE WORST MODE OF MEASUREMENT	12
3.3	EUT DUTY CYCLE	13
4.	TEST RESULT	14
4.1	AC POWER LINE CONDUCTED EMISSION	14
4.2	6dB BANDWIDTH AND OCCUPIED BANDWIDTH(99%).....	17
4.3	OUTPUT POWER MEASUREMENT	20
4.4	POWER SPECTRAL DENSITY	23
4.5	CONDUCTED BAND EDGE AND SPURIOUS EMISSION	25
4.6	RADIATION BANDEDGE AND SPURIOUS EMISSION	29
APPENDIX 1 - PHOTOGRAPHS OF EUT		

1. GENERAL INFORMATION

1.1 EUT INFORMATION

Applicant	Getac Technology Corp. 5F, Building A2, No.209, Sec.1, Nangang Rd., Nangang Dist., Taipei City 11568, Taiwan.
Manufacturer	Getac Technology Corp. 4F., NO.1, R&D ROAD 2, SCIENCE PARK, HSINCHU, TAIWAN, R.O.C.
Equipment	Body Worn Camera
Model No.	BC-03
Model Discrepancy	N/A
Trade Name	Getac
Received Date	December 22, 2018
Date of Test	January 18 ~ February 20, 2019
Output Power (W)	BLE: 0.0039 (EIRP: 0.0042)
Power Supply	1. Powered from battery: DC 5V 2. Powered from docking
H/W Version	PWA-BWC-BC-03
F/W Version	4.0.

1.2 EUT CHANNEL INFORMATION

Frequency Range	2402MHz-2480MHz
Modulation Type	GFSK for BLE-1Mbps
Number of channel	40 Channels

Remark:

Refer as ANSI C63.10: 2013 clause 5.6.1 Table 4 and RSS-GEN Table 1 for test channels

Number of frequencies to be tested		
Frequency range in which device operates	Number of frequencies	Location in frequency range of operation
<input type="checkbox"/> 1 MHz or less	1	Middle
<input type="checkbox"/> 1 MHz to 10 MHz	2	1 near top and 1 near bottom
<input checked="" type="checkbox"/> More than 10 MHz	3	1 near top, 1 near middle, and 1 near bottom

1.3 ANTENNA INFORMATION

Antenna Type	<input checked="" type="checkbox"/> PIFA <input type="checkbox"/> PCB <input type="checkbox"/> Dipole <input type="checkbox"/> Coils
Antenna Gain	Gain: 0.36 dBi
Antenna Connector	NA

1.4 MEASUREMENT UNCERTAINTY

PARAMETER	UNCERTAINTY
AC Powerline Conducted Emission	+/- 2.96
Emission bandwidth, 20dB bandwidth	+/- 1.4003
RF output power, conducted	+/- 1.1372
Power density, conducted	+/- 1.4003
3M Semi Anechoic Chamber / 30M~200M	+/- 4.0138
3M Semi Anechoic Chamber / 200M~1000M	+/- 3.9483
3M Semi Anechoic Chamber / 1G~8G	+/- 2.5975
3M Semi Anechoic Chamber / 8G~18G	+/- 2.6112
3M Semi Anechoic Chamber / 18G~26G	+/- 2.7389
3M Semi Anechoic Chamber / 26G~40G	+/- 2.9683

Remark:

1. This uncertainty represents an expanded uncertainty expressed at approximately the 95% confidence level using a coverage factor of $k=2$
2. ISO/IEC 17025 requires that an estimate of the measurement uncertainties associated with the emissions test results be included in the report.

1.5 FACILITIES AND TEST LOCATION

All measurement facilities used to collect the measurement data are located at
 No.11, Wugong 6th Rd., Wugu Dist., New Taipei City 24891, Taiwan. (R.O.C.)

Test site	Test Engineer	Remark
AC Conduction Room	Dally Hong	
Radiation	Jerry Chuang	
RF Conducted	Jerry Chuang	

Remark: The sites are constructed in conformance with the requirements of ANSI C63.7, ANSI C63.4 and CISPR Publication 22.

1.6 INSTRUMENT CALIBRATION

RF Conducted Test Site					
Equipment	Manufacturer	Model	S/N	Cal Date	Cal Due
Coaxial Cable	Woken	WC12	CC002	06/29/2018	06/28/2019
Power Meter	Anritsu	ML2495A	1149001	02/06/2018	02/05/2019
Power Seneor	Anritsu	MA2491A	030982	02/07/2018	02/06/2019
Signal Analyzer	R&S	FSV 40	101073	09/27/2018	09/26/2019
3M 966 Chamber Test Site					
Equipment	Manufacturer	Model	S/N	Cal Date	Cal Due
Band Reject Filters	MICRO TRONICS	BRM 50702	120	05/14/2018	05/13/2019
Bilog Antenna	Sunol Sciences	JB3	A030105	07/13/2018	07/12/2019
Cable	HUBER SUHNER	SUCOFLEX 104PEA	25157	06/29/2018	06/28/2019
Cable	HUBER SUHNER	SUCOFLEX 104PEA	20995	06/29/2018	06/28/2019
Digital Thermo-Hygro Meter	WISEWIND	1206	D07	02/08/2018	02/07/2019
double Ridged Guide Horn Antenna	ETC	MCTD 1209	DRH13M02003	08/20/2018	08/19/2019
Loop Ant	COM-POWER	AL-130	121051	03/21/2018	03/20/2019
Pre-Amplifier	EMEC	EM330	060609	06/29/2018	06/28/2019
Pre-Amplifier	HP	8449B	3008A00965	06/29/2018	06/28/2019
PSA Series Spectrum Analyzer	Agilent	E4446A	MY46180323	05/31/2018	05/30/2019
Antenna Tower	CCS	CC-A-1F	N/A	N.C.R	N.C.R
Controller	CCS	CC-C-1F	N/A	N.C.R	N.C.R
Turn Table	CCS	CC-T-1F	N/A	N.C.R	N.C.R

Remark: Each piece of equipment is scheduled for calibration once a year.



Report No.: T181222W01-RP2

Page: 8 / 44
Rev.: 00

AC Conducted Emissions Test Site					
Equipment	Manufacturer	Model	S/N	Cal Date	Cal Due
CABLE	EMCI	CFD300-NL	CERF	06/29/2018	06/28/2019
EMI Test Receiver	R&S	ESCI	100064	07/24/2018	07/23/2019
LISN	SCHWARZBECK	NSLK 8127	8127-541	01/31/2019	01/30/2020
LISN	SCHAFFNER	NNB 41	03/10013	02/13/2019	02/12/2020

Remark: Each piece of equipment is scheduled for calibration once a year.

1.7 SUPPORT AND EUT ACCESSORIES EQUIPMENT

EUT Accessories Equipment					
No.	Equipment	Brand	Model	Series No.	FCC ID
	N/A				

Support Equipment					
No.	Equipment	Brand	Model	Series No.	FCC ID
1	NB(B)	Toshiba	PORTEGE R30-A	N/A	PD97260H

1.8 TEST METHODOLOGY AND APPLIED STANDARDS

The test methodology, setups and results comply with all requirements in accordance with ANSI C63.10:2013, FCC Part 2, FCC Part 15.247, KDB 558074 D01, RSS-247 Issue 2 and RSS-GEN Issue 5



Report No.: T181222W01-RP2

Page: 10 / 44
Rev.: 00

2. TEST SUMMERY

FCC Standard Section	IC Standard Section	Report Section	Test Item	Result
15.203	-	1.3	Antenna Requirement	Pass
15.207(a)	RSS-GEN 8.8	4.1	AC Conducted Emission	Pass
15.247(a)(2)	RSS-247(5.2)(a)	4.2	6 dB Bandwidth	Pass
-	RSS-GEN 6.7	4.2	Occupied Bandwidth (99%)	Pass
15.247(b)(3)	RSS-247(5.4)(d)	4.3	Output Power Measurement	Pass
15.247(e)	RSS-247(5.2)(b)	4.4	Power Spectral Density	Pass
15.247(d)	RSS-247(5.5)	4.5	Conducted Band Edge	Pass
15.247(d)	RSS-247(5.5)	4.5	Conducted Spurious Emission	Pass
15.247(d)	RSS-GEN 8.9, 8.10	4.6	Radiation Band Edge	Pass
15.247(d)	RSS-GEN 8.9, 8.10	4.6	Radiation Spurious Emission	Pass

3. DESCRIPTION OF TEST MODES

3.1 THE WORST MODE OF OPERATING CONDITION

Operation mode	BT4.0 Mode (1Mbps)
Test Channel Frequencies	<ol style="list-style-type: none"> 1. Lowest Channel: 2402MHz 2. Middle Channel: 2440MHz 3. Highest Channel: 2480MHz

Remark:

1. EUT pre-scanned data rate of output power for each mode, the worst data rate were recorded in this report.

.

3.2 THE WORST MODE OF MEASUREMENT

AC Power Line Conducted Emission	
Test Condition	AC Power line conducted emission for line and neutral
Power supply Mode	Mode 1: EUT power by Docking (MD-03_8 Port) Mode 2: EUT power by Docking (VD-03_1 Port)
Worst Mode	<input type="checkbox"/> Mode 1 <input checked="" type="checkbox"/> Mode 2 <input type="checkbox"/> Mode 3 <input type="checkbox"/> Mode 4

Radiated Emission Measurement Above 1G	
Test Condition	Band edge, Emission for Unwanted and Fundamental
Power supply Mode	Mode 1: EUT power by Battery Mode 2: EUT power by Docking (MD-03_8 Port) Mode 3: EUT power by Docking (VD-03_1 Port)
Worst Mode	<input checked="" type="checkbox"/> Mode 1 <input type="checkbox"/> Mode 2 <input type="checkbox"/> Mode 3 <input type="checkbox"/> Mode 4
Worst Position	<input type="checkbox"/> Placed in fixed position. <input checked="" type="checkbox"/> Placed in fixed position at X-Plane (E2-Plane) <input type="checkbox"/> Placed in fixed position at Y-Plane (E1-Plane) <input type="checkbox"/> Placed in fixed position at Z-Plane (H-Plane)
Worst Polarity	<input checked="" type="checkbox"/> Horizontal <input type="checkbox"/> Vertical

Radiated Emission Measurement Below 1G	
Test Condition	Radiated Emission Below 1G
Power supply Mode	Mode 1: EUT power by Battery Mode 2: EUT power by Docking (MD-03_8 Port) Mode 3: EUT power by Docking (VD-03_1 Port)
Worst Mode	<input checked="" type="checkbox"/> Mode 1 <input type="checkbox"/> Mode 2 <input type="checkbox"/> Mode 3 <input type="checkbox"/> Mode 4

Remark:

1. The worst mode was record in this test report.
2. EUT pre-scanned in three axis, X, Y, Z and two polarity, Horizontal and Vertical for radiated measurement. The worst case (X-Plane and Horizontal) were recorded in this report

3.3 EUT DUTY CYCLE

Duty Cycle			
Configuration	TX ON (ms)	TX ALL (ms)	Duty Cycle (%)
BLE	420.0000	630.0000	66.67%

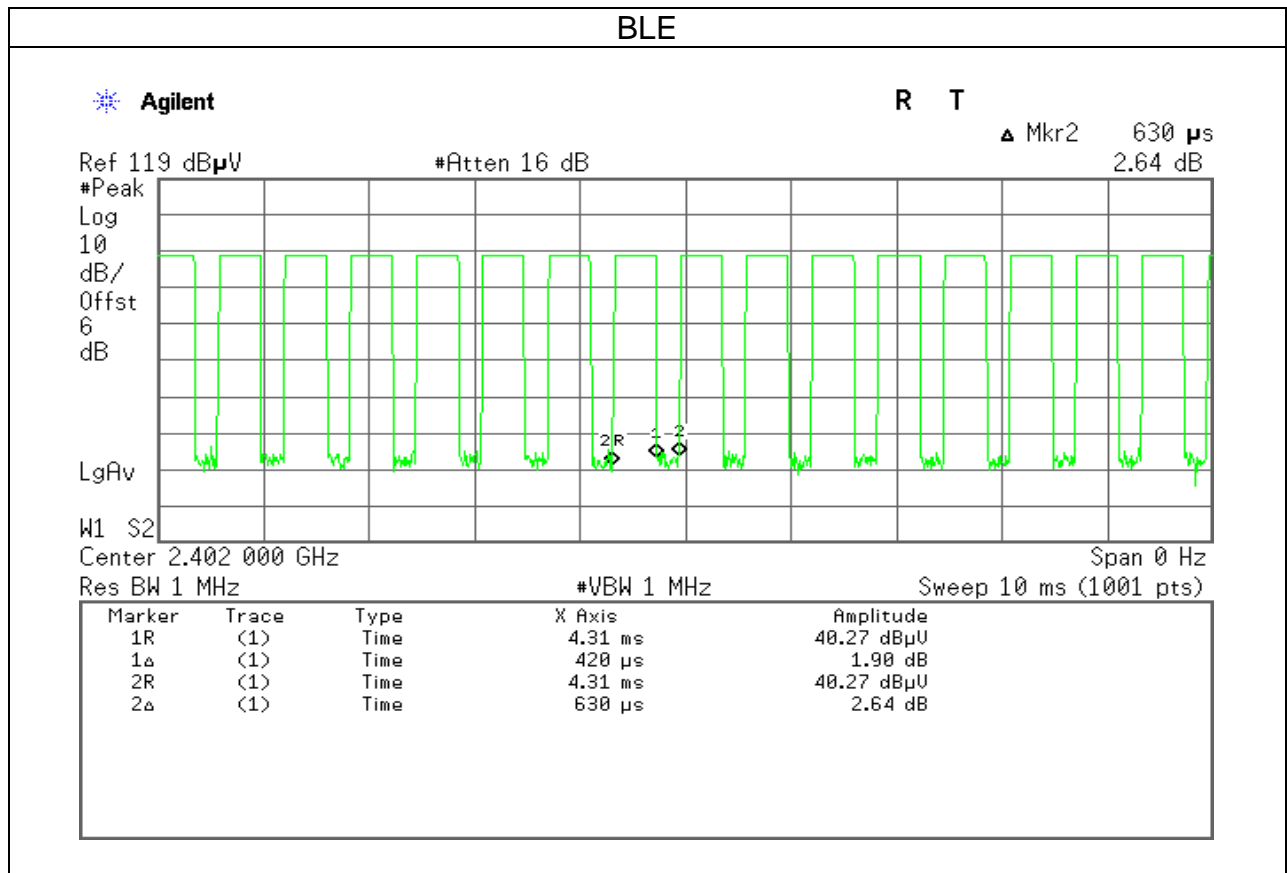

4. TEST RESULT

4.1 AC POWER LINE CONDUCTED EMISSION

4.1.1 Test Limit

According to §15.207(a) and RSS-GEN section 8.8,

Frequency Range (MHz)	Limits(dB μ V)	
	Quasi-peak	Average
0.15 to 0.50	66 to 56*	56 to 46*
0.50 to 5	56	46
5 to 30	60	50

* Decreases with the logarithm of the frequency.

4.1.2 Test Procedure

Test method Refer as ANSI C63.10: 2013 clause 6.2,

1. The EUT was placed on a non-conducted table, which is 0.8m above horizontal ground plane and 0.4m above vertical ground plane.
2. EUT connected to the line impedance stabilization network (LISN)
3. Receiver set RBW of 9kHz and Detector Peak, and note as quasi-peak and average.
4. Maximum procedure was performed on the six highest emissions to ensure EUT compliance.
5. Recorded Line for Neutral and Line.

4.1.3 Test Setup

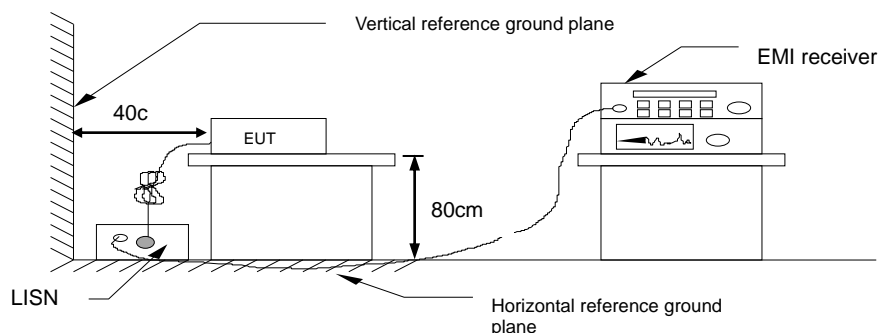

4.1.4 Test Result

Pass

Test Data

Test Mode:	Mode 2	Temp/Hum	24(°C)/ 50%RH
Phase:	Line	Test Date	February 20, 2019
		Test Engineer	Dally Hong

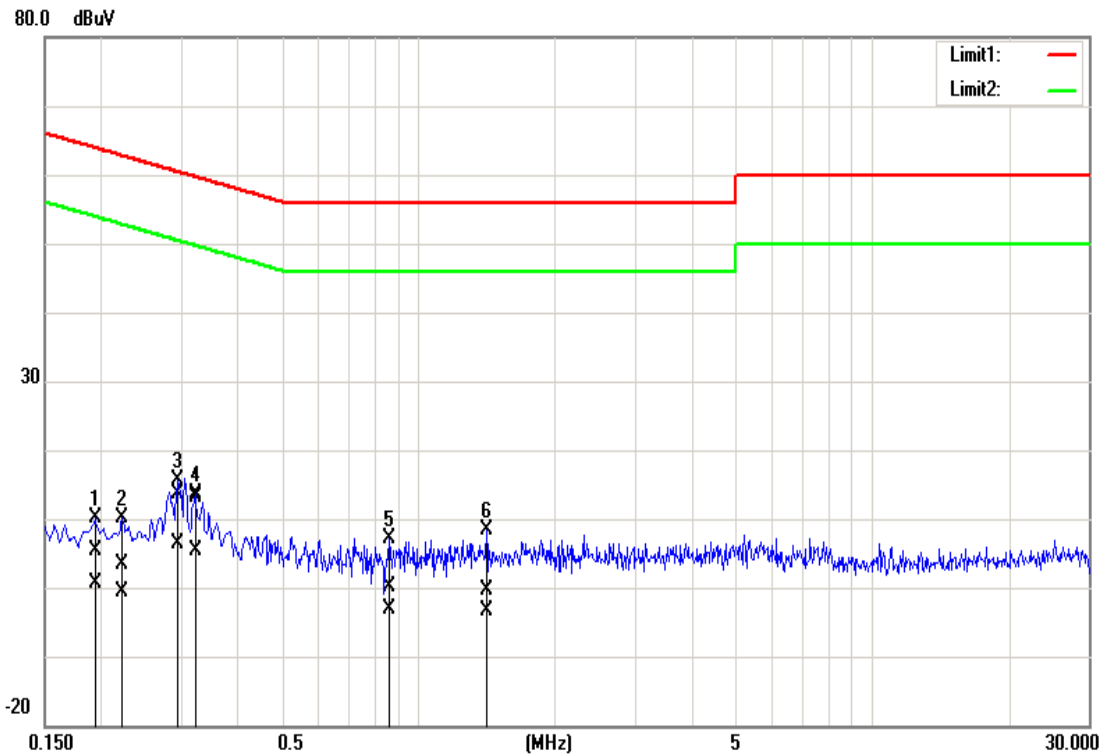

Frequency (MHz)	Quasi Peak reading (dBuV)	Average reading (dBuV)	Correction factor (dB)	Quasi Peak result (dBuV)	Average result (dBuV)	Quasi Peak limit (dBuV)	Average limit (dBuV)	Quasi Peak margin (dB)	Average margin (dB)	Remark
0.1924	5.16	0.51	0.16	5.32	0.67	63.93	53.93	-58.61	-53.26	Pass
0.2220	3.20	-0.87	0.16	3.36	-0.71	62.74	52.74	-59.38	-53.45	Pass
0.2940	13.43	6.26	0.16	13.59	6.42	60.41	50.41	-46.82	-43.99	Pass
0.3200	12.83	5.24	0.18	13.01	5.42	59.71	49.71	-46.70	-44.29	Pass
0.8660	-0.12	-3.44	0.20	0.08	-3.24	56.00	46.00	-55.92	-49.24	Pass
1.4180	-0.50	-3.68	0.21	-0.29	-3.47	56.00	46.00	-56.29	-49.47	Pass

Test Mode:	Mode 2	Temp/Hum	24(°C)/ 50%RH
Phase:	Neutral	Test Date	February 20, 2019
		Test Engineer	Dally Hong

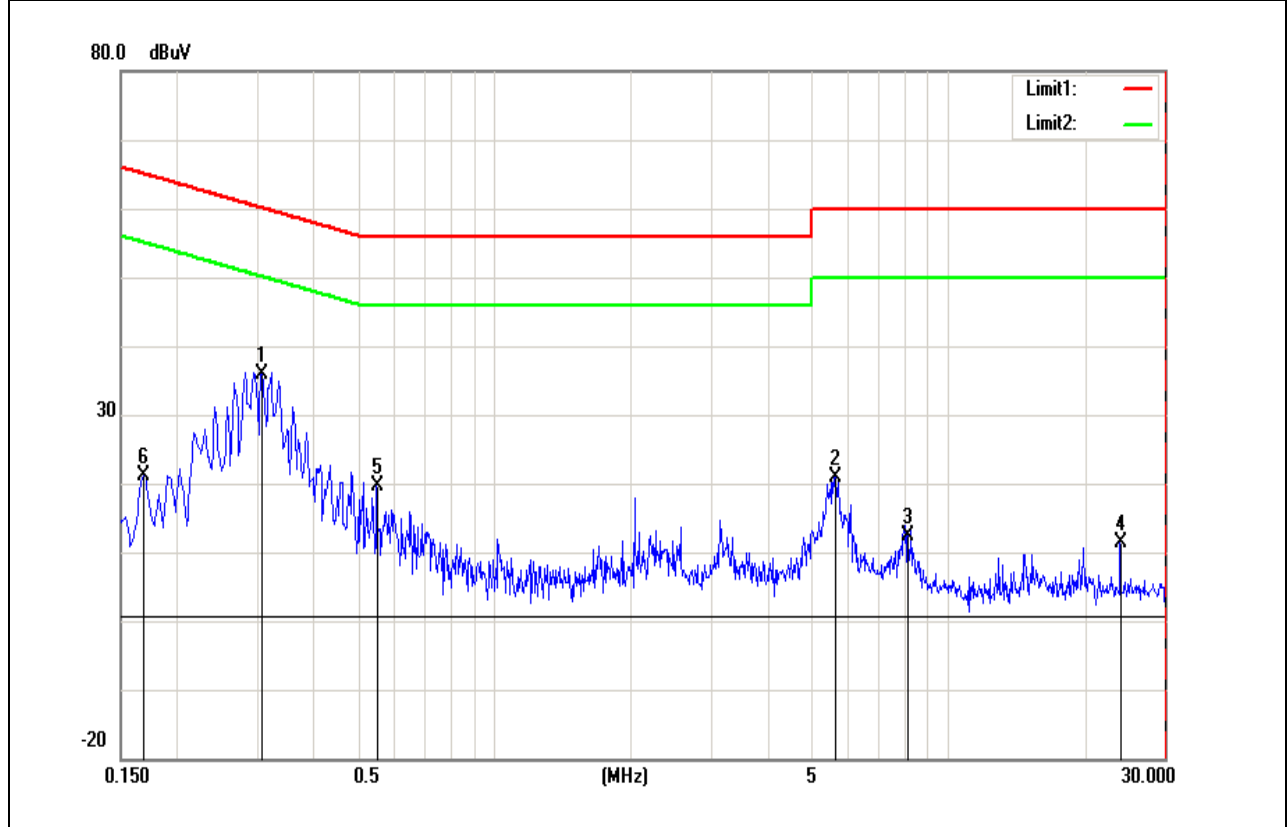

Frequency (MHz)	Quasi Peak reading (dBuV)	Average reading (dBu)	Correction factor (dB)	Quasi Peak result (dBuV)	Average result (dBuV)	Quasi Peak limit (dBuV)	Average limit (dBuV)	Quasi Peak margin (dB)	Average margin (dB)	Remark
0.1685	19.86	13.99	0.19	20.05	14.18	65.03	55.03	-44.98	-40.85	Pass
0.3067	35.65	27.76	0.19	35.84	27.95	60.06	50.06	-24.22	-22.11	Pass
0.5500	13.26	6.62	0.19	13.45	6.81	56.00	46.00	-42.55	-39.19	Pass
5.6060	12.81	4.92	0.35	13.16	5.27	60.00	50.00	-46.84	-44.73	Pass
8.1340	5.35	-2.92	0.41	5.76	-2.51	60.00	50.00	-54.24	-52.51	Pass
23.9180	6.74	3.67	0.74	7.48	4.41	60.00	50.00	-52.52	-45.59	Pass

4.2 6dB BANDWIDTH AND OCCUPIED BANDWIDTH (99%)

4.2.1 Test Limit

According to §15.247(a)(2) and RSS-247 section 5.2(a)

6 dB Bandwidth :

Limit	Shall be at least 500kHz
-------	--------------------------

Occupied Bandwidth(99%) : For reporting purposes only.

4.2.2 Test Procedure

Test method Refer as KDB 558074 D01 and ANSI C63.10: 2013 clause 6.9.2.

1. The EUT RF output connected to the spectrum analyzer by RF cable.
2. Setting maximum power transmit of EUT
3. SA set RBW = 100kHz, VBW = 300kHz and Detector = Peak, to measurement 6 dB Bandwidth and 99% Bandwidth.
4. Measure and record the result of 6 dB Bandwidth and 99% Bandwidth. in the test report.

4.2.3 Test Setup

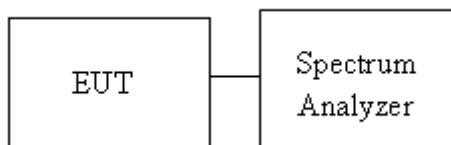

4.2.4 Test Result

Test mode: BLE mode / 2402-2480 MHz				
Channel	Frequency (MHz)	OBW (99%) (MHz)	6dB BW (kHz)	6dB limit (kHz)
Low	2402	1.0593	720.7	>500
Mid	2440	1.0506	729.4	
High	2480	1.0506	716.4	

Test Data (6dB BANDWIDTH)

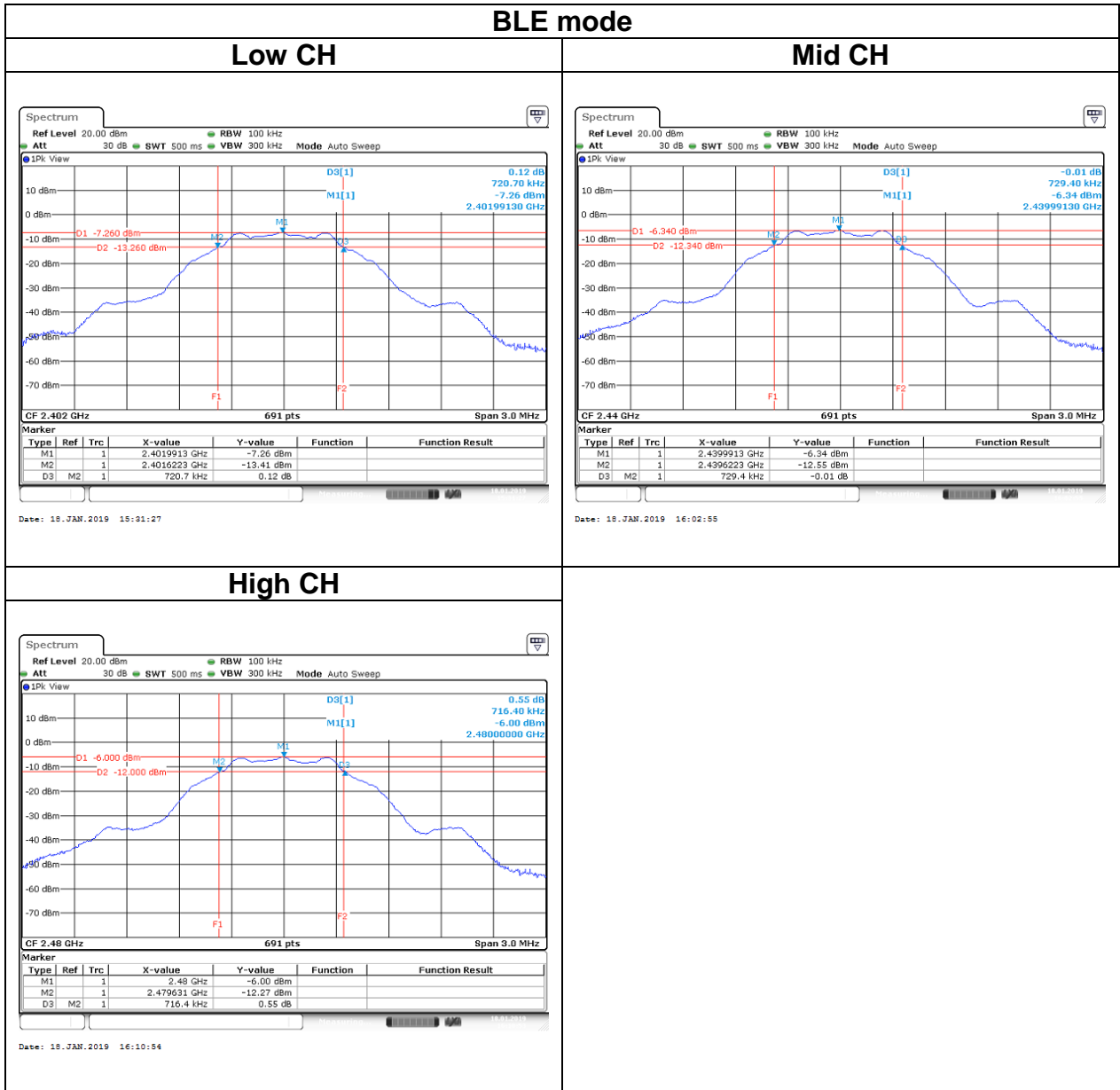

Test Data (BANDWIDTH 99%)

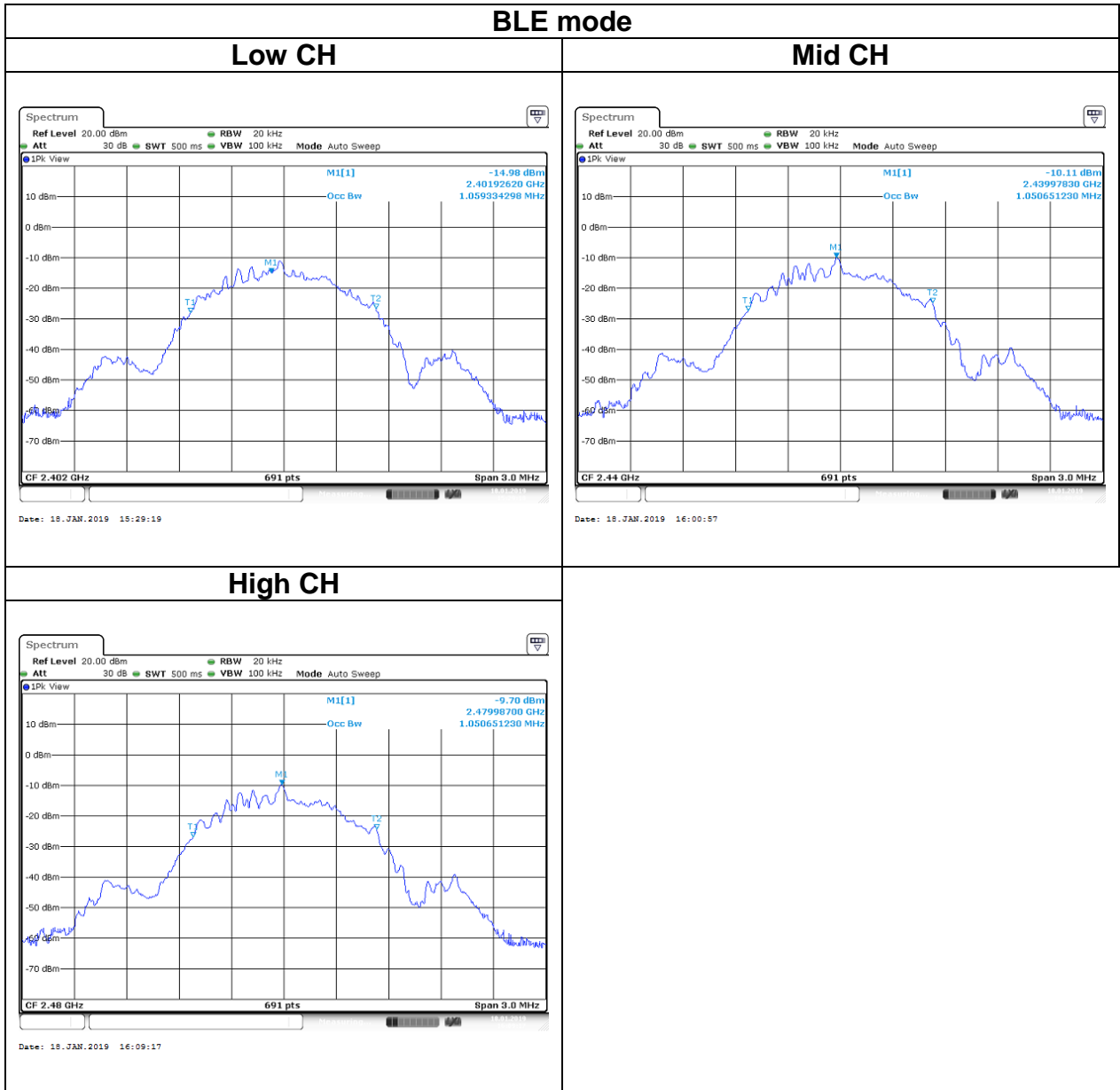

4.3 OUTPUT POWER MEASUREMENT

4.3.1 Test Limit

According to §15.247(b)(3) and RSS-247 section 5.4(d)

Peak output power :

FCC

Alternatively, frequency hopping systems operating in the 2400-2483.5 MHz band may have hopping channel carrier frequencies that are separated by 25 kHz or two-thirds of the 20 dB bandwidth of the hopping channel, whichever is greater, provided the systems operate with an output power no greater than 125 mW.

IC

For DTSs employing digital modulation techniques operating in the bands 902-928 MHz and 2400-2483.5 MHz, the maximum peak conducted output power shall not exceed 1 W. The e.i.r.p. shall not exceed 4 W, except as provided in section 5.4(e), base on the use of antennas with directional gain not exceed 6 dBi If transmitting antennas of directional gain greater than 6dBi are used the peak output power the conducted output power from the intentional radiator shall be reduced by the amount in dB that the directional gain of the antenna exceeds 6 dBi. In case of point-to-point operation, the limit has to be reduced by 1dB for every 3 dB that the directional gain of the antenna exceeds 6 dBi.

Limit	<input checked="" type="checkbox"/> Antenna not exceed 6 dBi : 30dBm <input type="checkbox"/> Antenna with DG greater than 6 dBi [Limit = 30 – (DG – 6)] <input type="checkbox"/> Point-to-point operation
-------	---

Average output power : For reporting purposes only.

4.3.2 Test Procedure

Test method Refer as KDB 558074 D01

1. The EUT RF output connected to the power meter by RF cable.
2. Setting maximum power transmit of EUT.
3. The path loss was compensated to the results for each measurement.
4. Measure and record the result of Peak output power and Average output power. in the test report.

4.3.3 Test Setup

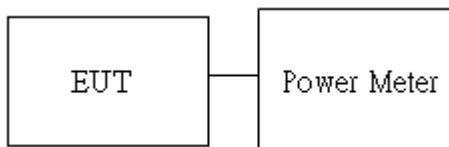

4.3.4 Test Result

Peak output power :

BLE Mode								
Config.	CH	Freq. (MHz)	PK Power (dBm)	EIRP PK Power (dBm)	PK Power (W)	EIRP PK Power (W)	FCC/IC Limit (dBm)	FCC/IC Limit (dBm)
BLE Data rate: 1Mbps	0	2402	4.48	4.84	0.0028	0.0030	30	36
	19	2440	5.54	5.90	0.0036	0.0039		
	39	2480	5.86	6.22	0.0039	0.0042		

Average output power :

BLE Mode			
Config.	CH	Freq. (MHz)	AV Power (dBm)
BLE Data rate: 1Mbps	0	2402	4.38
	19	2440	5.41
	39	2480	5.73

4.4 POWER SPECTRAL DENSITY

4.4.1 Test Limit

According to §15.247(e) and RSS-247 section 5.2(b)

For digitally modulated systems, the power spectral density conducted from the intentional radiator to the antenna shall not be greater than 8 dBm in any 3 kHz band during any time interval of continuous transmission.

Limit	<input checked="" type="checkbox"/> Antenna not exceed 6 dBi : 8dBm <input type="checkbox"/> Antenna with DG greater than 6 dBi [Limit = 8 – (DG – 6)] <input type="checkbox"/> Point-to-point operation :
-------	---

4.4.2 Test Procedure

Test method Refer as KDB 558074 D01

1. The EUT RF output connected to the spectrum analyzer by RF cable.
2. Setting maximum power transmit of EUT
3. SA set RBW = 3kHz, VBW = 30kHz, Span = 1.5 times DTS Bandwidth (6 dB BW), Detector = Peak, Sweep Time = Auto and Trace = Max hold.
4. The path loss was compensated to the results for each measurement by SA.
5. Mark the maximum level.
6. Measure and record the result of power spectral density. in the test report.

4.4.3 Test Setup

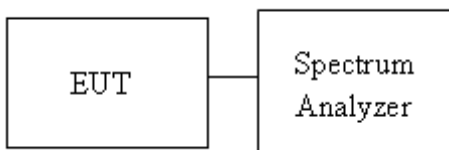

4.4.4 Test Result

Test mode: BLE mode / 2402-2480 MHz			
Channel	Frequency (MHz)	PSD (dBm)	IC/FCC limit (dBm)
Low	2402	-9.51	8
Mid	2440	-8.47	
High	2480	-8.10	

Test Data

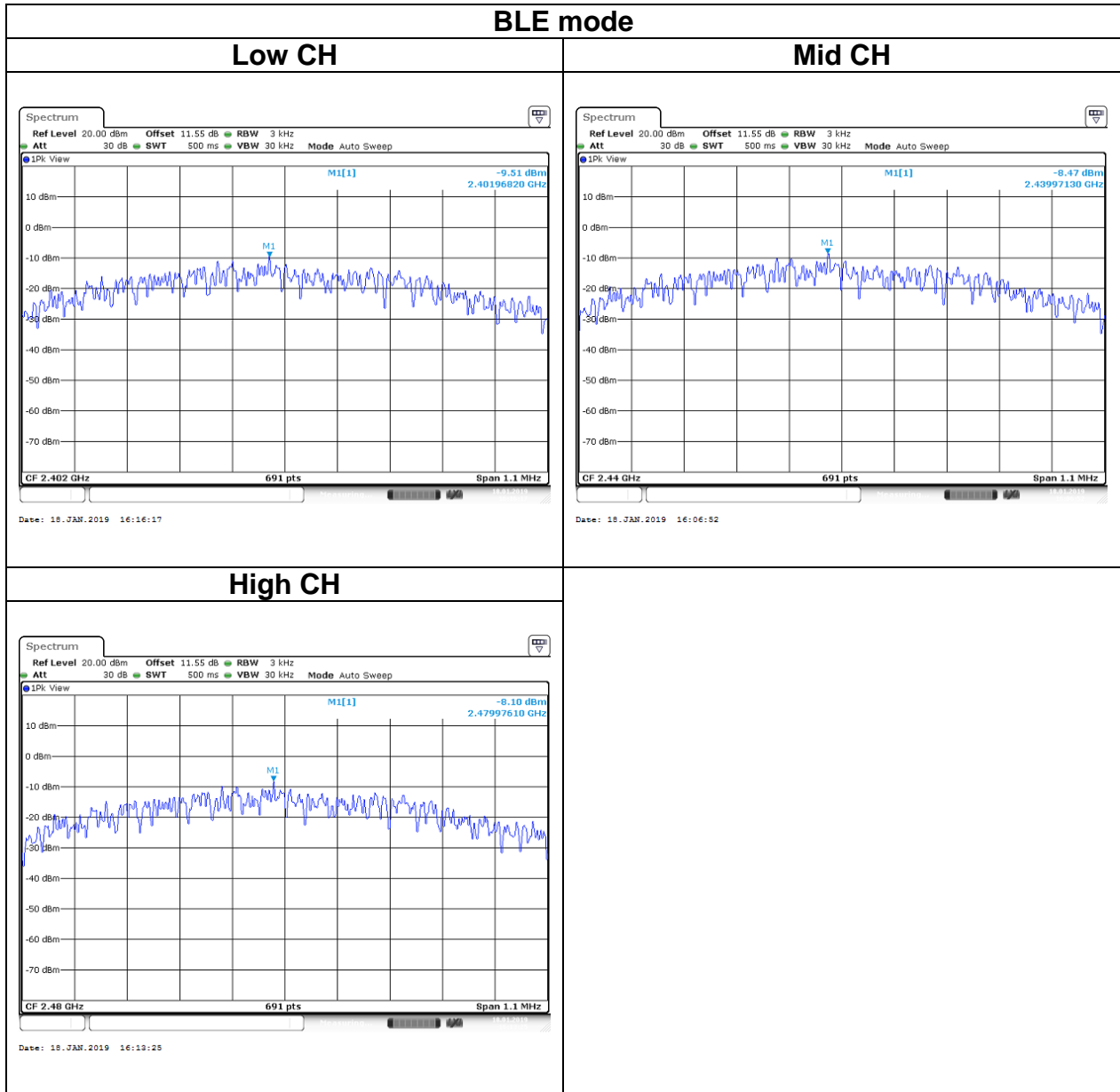

4.5 CONDUCTED BAND EDGE AND SPURIOUS EMISSION

4.5.1 Test Limit

According to §15.247(d) and RSS-247 section 5.5

FCC: In any 100 kHz bandwidth outside the authorized frequency band,

Non-restricted bands shall be attenuated at least 20 dB/30 dB relative to the maximum PSD level in 100 kHz by RF conducted or a radiated measurement which fall in the restricted bands, as defined in §15.205(a), must also comply with the radiated emission limits specified in §15.209(a).

IC: In any 100 kHz bandwidth outside the frequency band in which the spread spectrum or digitally modulated device is operating, the RF power that is produced shall be at least 20 dB below that in the 100 kHz bandwidth within the band that contains the highest level of the desired power, based on either an RF conducted or a radiated measurement, provided that the transmitter demonstrates compliance with the peak conducted power limits. If the transmitter complies with the conducted power limits based on the use of root-mean-square averaging over a time interval, as permitted under section 5.4(d), the attenuation required shall be 30 dB instead of 20 dB. Attenuation below the general field strength limits specified in RSS-Gen is not required.

4.5.2 Test Procedure

Test method Refer as KDB 558074 D01

1. EUT RF output port connected to the SA by RF cable, and the path loss was compensated to result.
2. SA setting, RBW=100kHz, VBW=300kHz, Detector=Peak, Trace mode = max hold, SWT = Auto.
3. In any 100 kHz bandwidth outside the authorized frequency band, shall be attenuated at least 20 dB relative to the maximum in-band peak PSD level in 100 kHz when conducted power procedure is used. If the transmitter complies with the conducted power limits based on the use of RMS averaging over a time interval, the attenuation required under this paragraph shall be 30 dB instead of 20 dB.

4.5.3 Test Setup

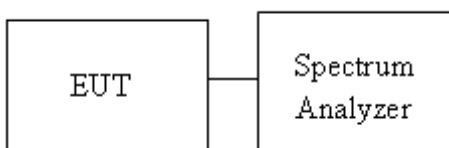

4.5.4 Test Result

Test Data

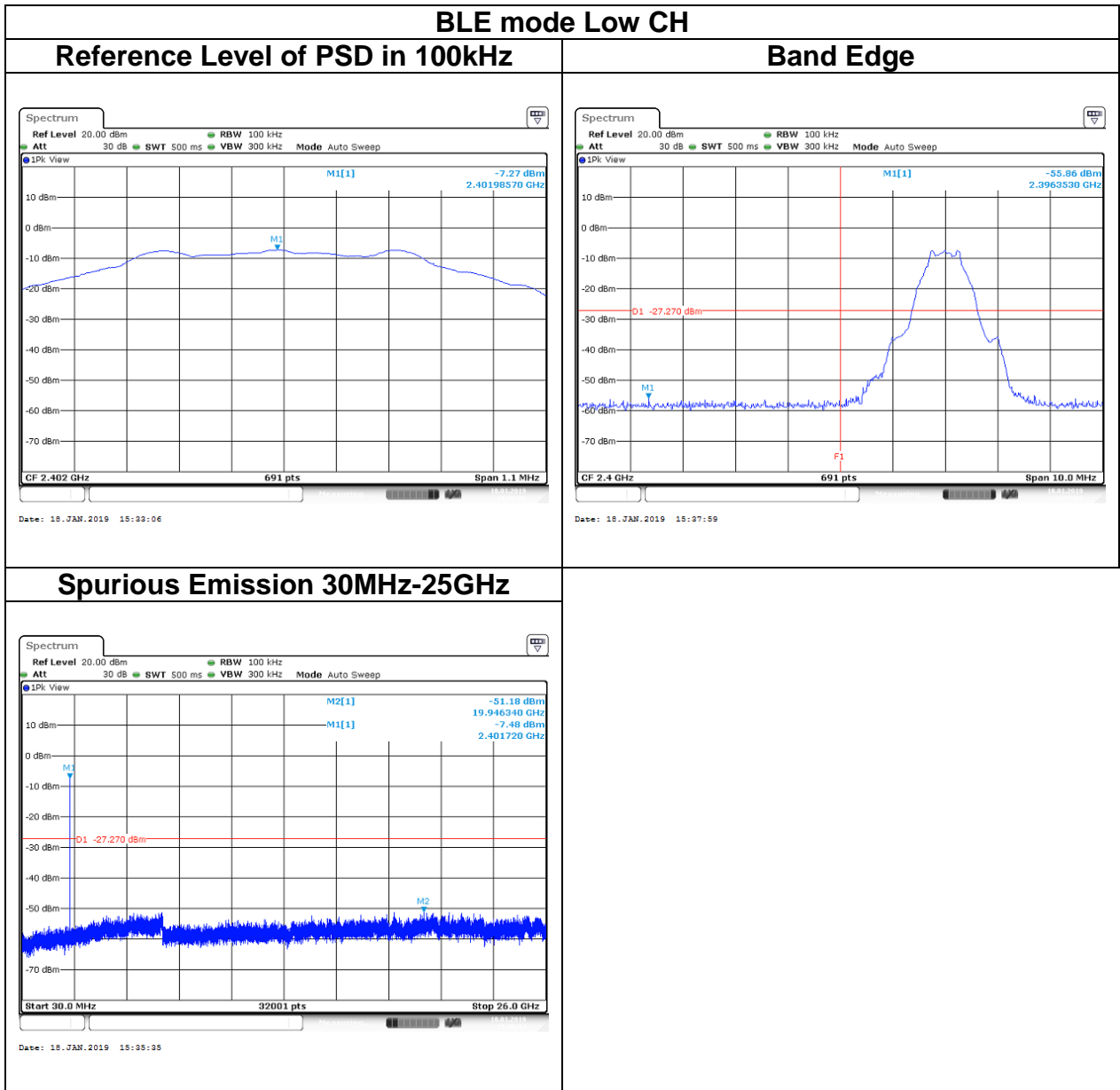

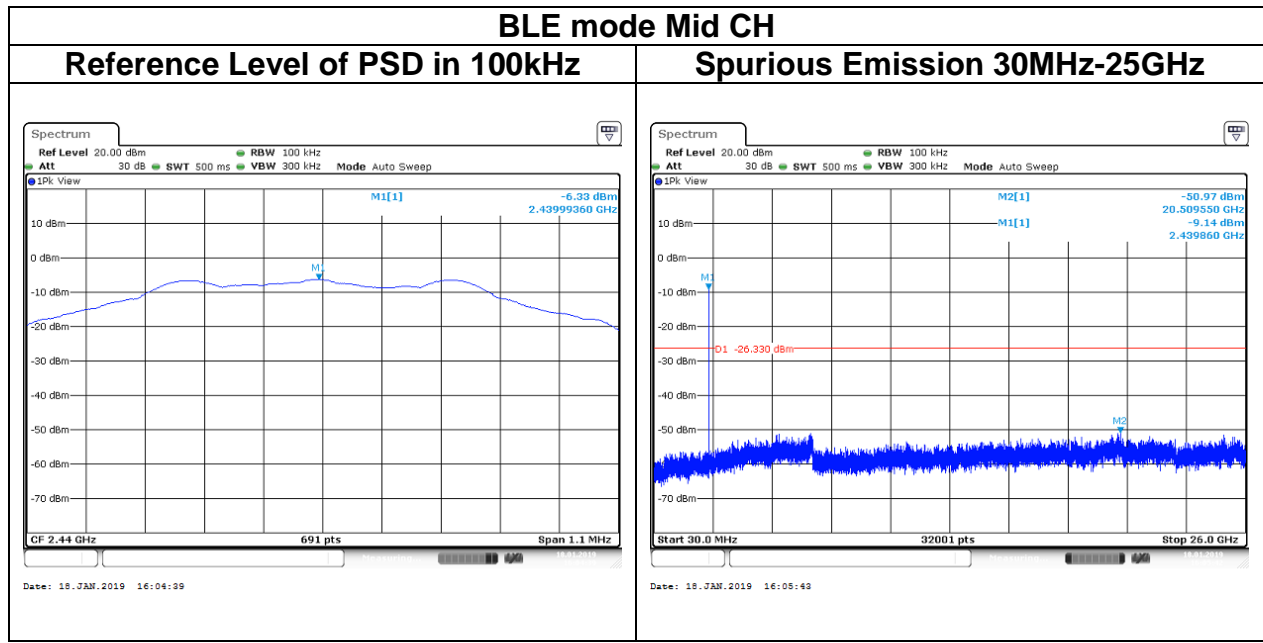

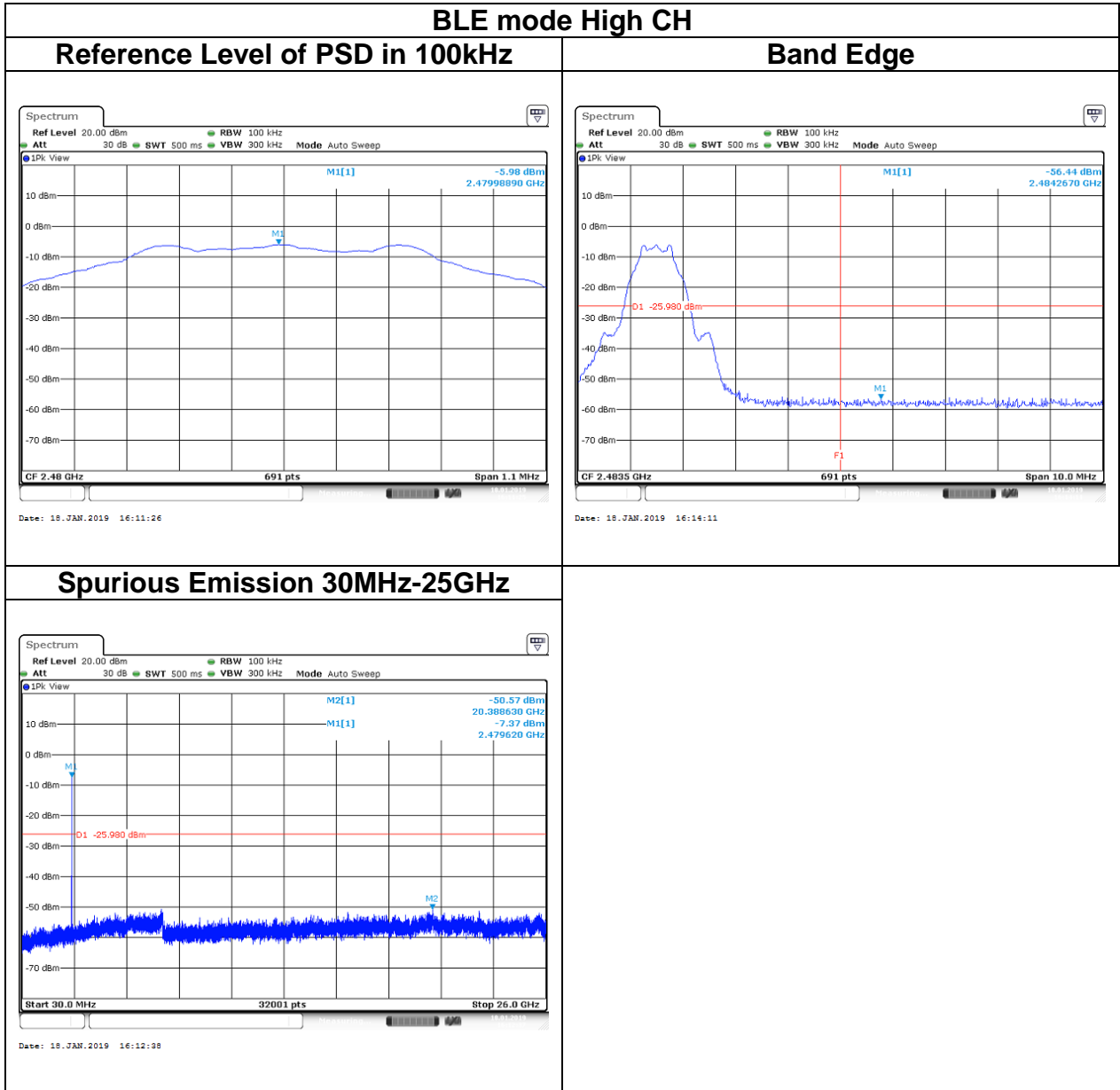

4.6 RADIATION BANDEDGE AND SPURIOUS EMISSION

4.6.1 Test Limit

FCC according to §15.247(d), §15.209 and §15.205,

IC according to RSS-247 section 5.5, RSS-Gen, Section 8.9 and 8.10

In any 100 kHz bandwidth outside the authorized frequency band, all harmonic and spurious must be least 20 dB below the highest emission level with the authorized frequency band. Radiation emission which fall in the restricted bands must also follow the FCC section 15.209 as below limit in table.

Below 30 MHz

Frequency	Field Strength (microvolts/m)	Magnetic H-Field (microamperes/m)	Measurement Distance (metres)
9-490 kHz	2,400/F (F in kHz)	2,400/F (F in kHz)	300
490-1,705 kHz	24,000/F (F in kHz)	24,000/F (F in kHz)	30
1.705-30 MHz	30	N/A	30

Above 30 MHz

Frequency (MHz)	Field Strength microvolts/m at 3 metres (watts, e.i.r.p.)	
	Transmitters	Receivers
30-88	100 (3 nW)	100 (3 nW)
88-216	150 (6.8 nW)	150 (6.8 nW)
216-960	200 (12 nW)	200 (12 nW)
Above 960	500 (75 nW)	500 (75 nW)

Remark:

Although these tests were performed other than open area test site, adequate comparison measurements were confirmed against 30 m open area test site. Therefore sufficient tests were made to demonstrate that the alternative site produces results that correlate with the ones of tests made in an open field based on KDB 414788.

4.6.2 Test Procedure

Test method Refer as KDB 558074 D01

1. The EUT is placed on a turntable, Above 1 GHz is 1.5m and below 1 GHz is 0.8m above ground plane. The EUT Configured un accordance with ANSI C63.10, and the EUT set in a continuous mode.
2. The turntable shall be rotated for 360 degrees to determine the position of maximum emission level. And EUT is set 3m away from the receiving antenna, which is scanned from 1m to 4m above the ground plane to find out the highest emissions. Measurement are made polarized in both the vertical and the horizontal positions with antenna.
3. Span shall wide enough to full capture the emission measured. The SA from 9KHz to 26.5GHz set to the low, Mid and High channels with the EUT transmit.
4. No emission found between lowest internal used/generated frequency to 30MHz (9KHz~30MHz)

Remark:

Although these tests were performed other than open area test site, adequate comparison measurements were confirmed against 30 m open are test site. Therefore sufficient tests were made to demonstrate that the alternative site produces results that correlate with the ones of tests made in an open field based on KDB 414788.

5. The SA setting following :

- (1) Below 1G : RBW = 100kHz, VBW \geq 3 RBW, Sweep = Auto, Detector = Peak, Trace = Max hold.
- (2) Above 1G :
 - (2.1) For Peak measurement : RBW = 1MHz, VBW \geq 3 RBW, Sweep = Auto, Detector = Peak, Trace = Max hold.
 - (2.2) For Average measurement : RBW = 1MHz, VBW
 - If Duty Cycle \geq 98%, VBW=10Hz.
 - If Duty Cycle < 98%, VBW=1/T.

Configuration	Duty Cycle (%)	T(ms)	1/T (kHz)	VBW Setting
BLE	66.67%	420.0000	0.002	300Hz

4.6.3 Test Setup

9kHz ~ 30MHz

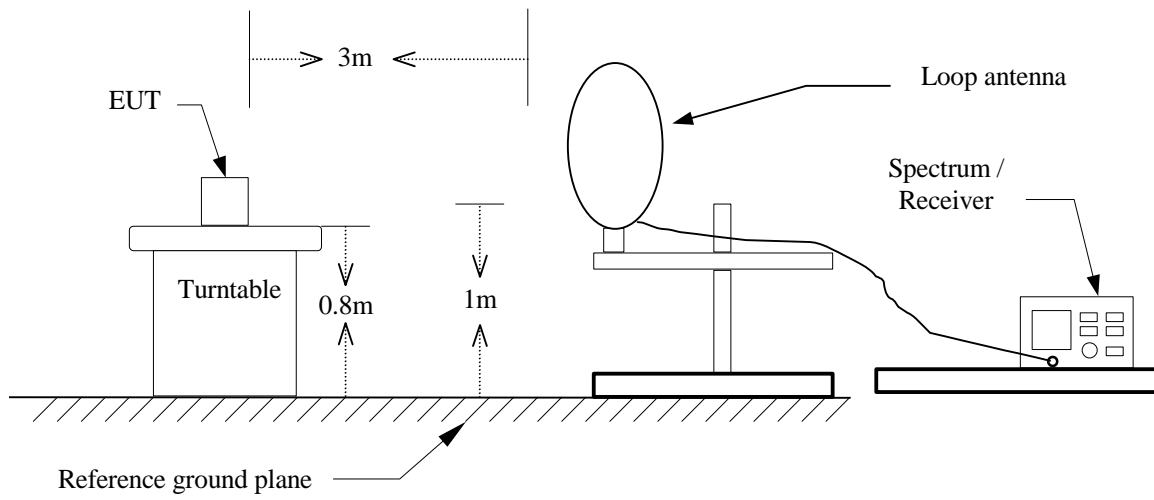

30MHz ~ 1GHz

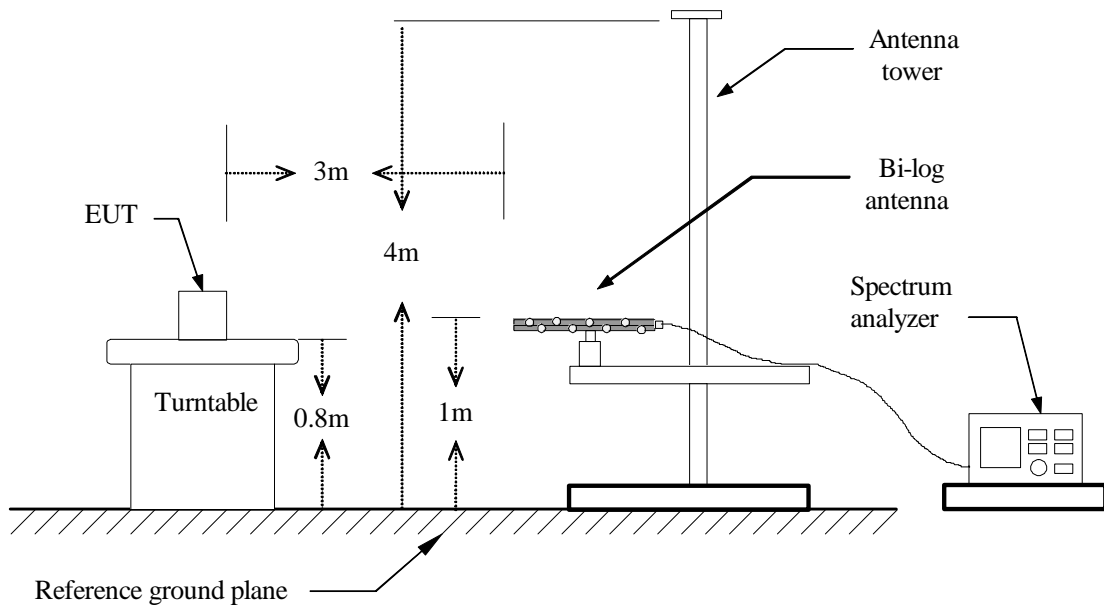

Above 1 GHz

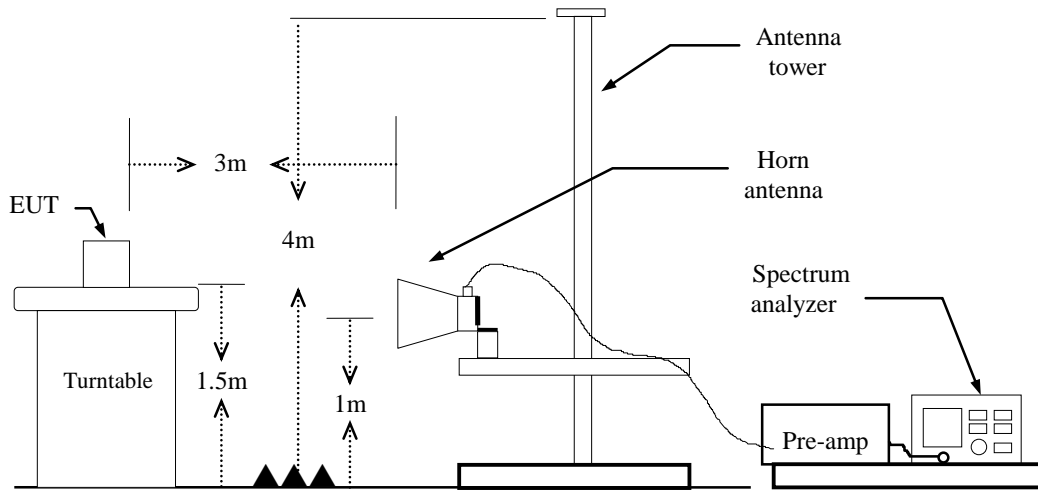

4.6.4 Test Result

Band Edge Test Data

Test Mode:	BLE Low CH	Temp/Hum	22.7(°C)/ 52%RH
Test Item	Band Edge	Test Date	January 19, 2019
Polarize	Vertical	Test Engineer	Jerry Chuang
Detector	Peak		

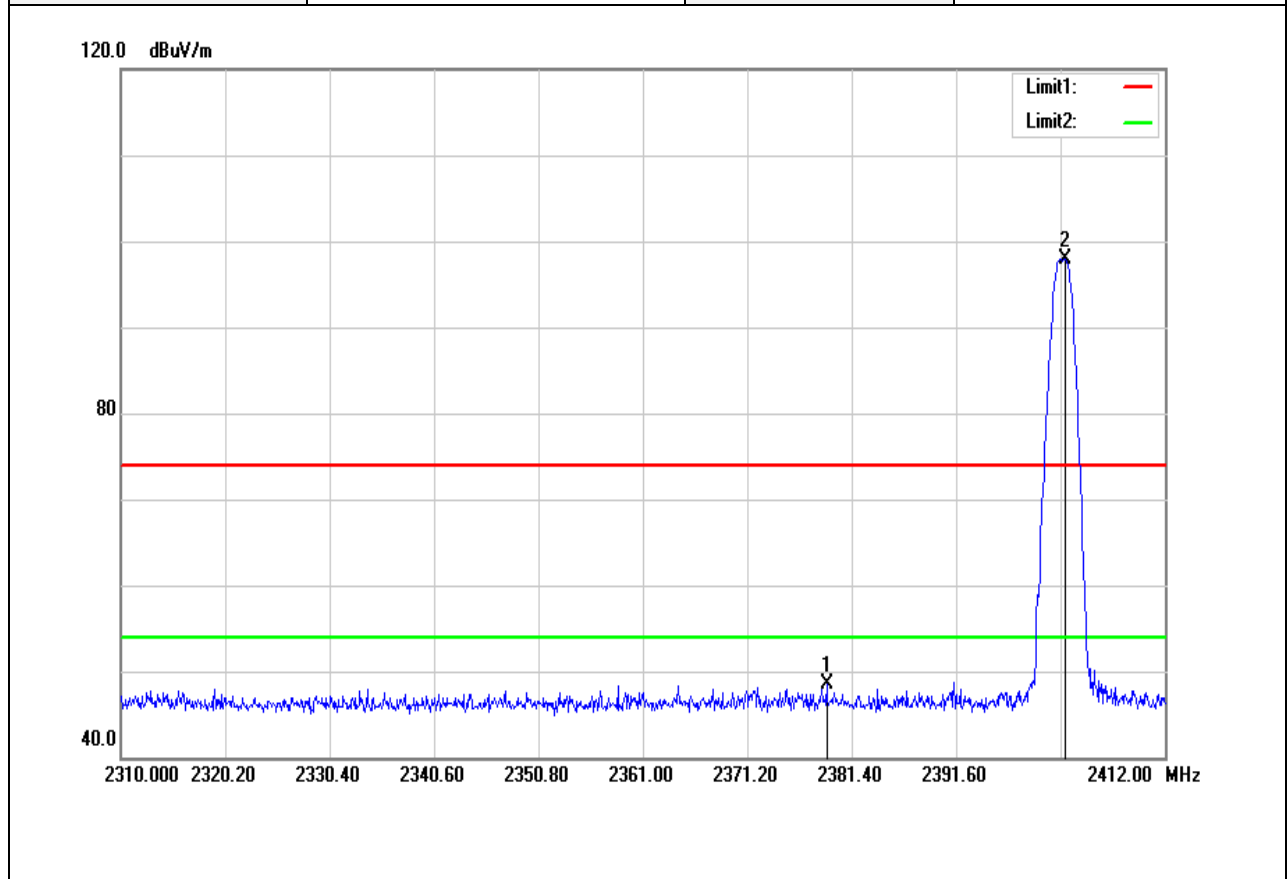

No.	Frequency (MHz)	Reading (dBuV)	Correct Factor(dB/m)	Result (dBuV/m)	Limit (dBuV/m)	Margin (dB)	Remark
1	2378.952	51.68	-3.11	48.57	74.00	-25.43	peak
2	2402.208	101.06	-3.13	97.93	-	-	peak

Test Mode:	BLE Low CH	Temp/Hum	22.7(°C)/ 52%RH
Test Item	Band Edge	Test Date	January 19, 2019
Polarize	Vertical	Test Engineer	Jerry Chuang
Detector	Average		

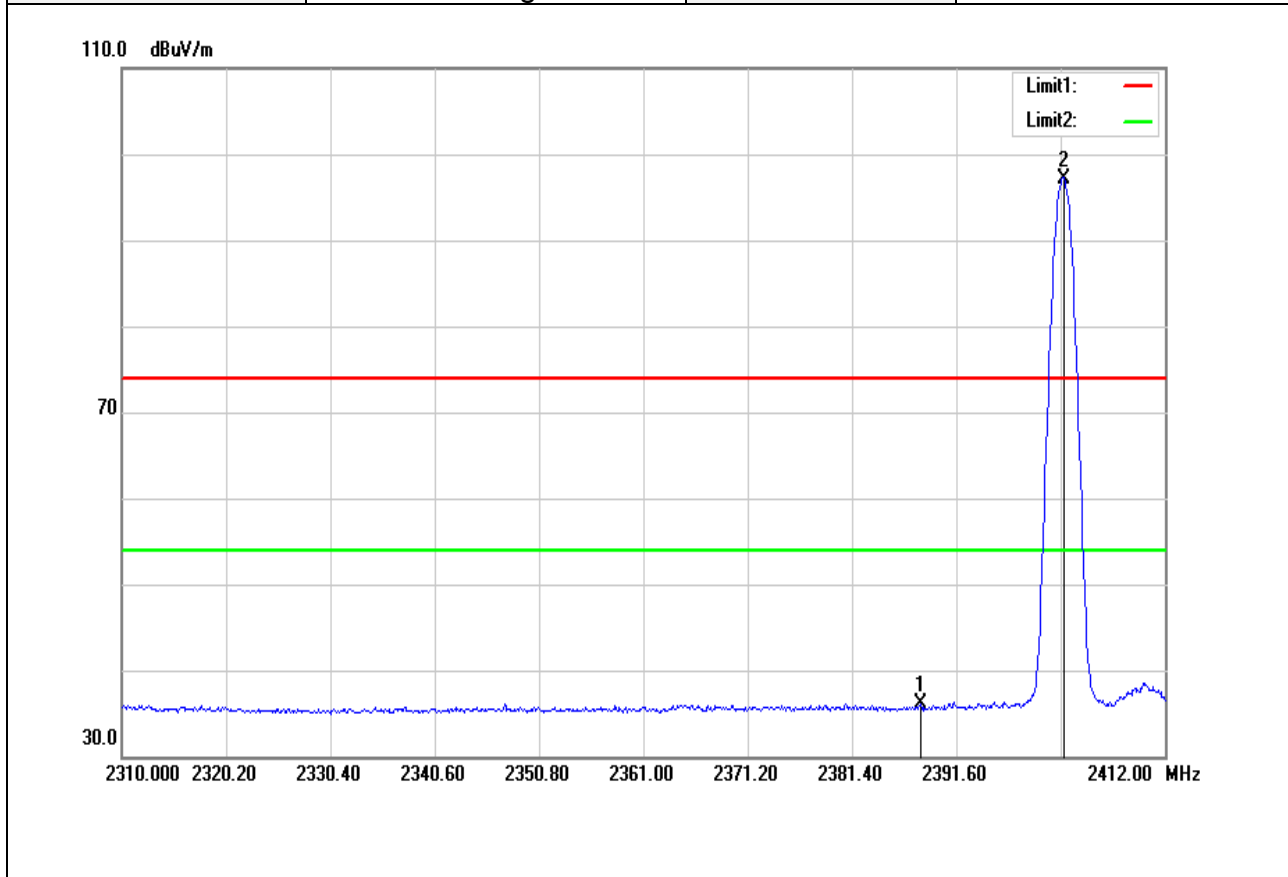

No.	Frequency (MHz)	Reading (dBuV)	Correct Factor(dB/m)	Result (dBuV/m)	Limit (dBuV/m)	Margin (dB)	Remark
1	2388.132	39.23	-3.12	36.11	54.00	-17.89	AVG
2	2402.106	100.33	-3.13	97.20	-	-	AVG

Test Mode:	BLE High CH	Temp/Hum	22.7(°C)/ 52%RH
Test Item	Band Edge	Test Date	January 19, 2019
Polarize	Vertical	Test Engineer	Jerry Chuang
Detector	Peak		

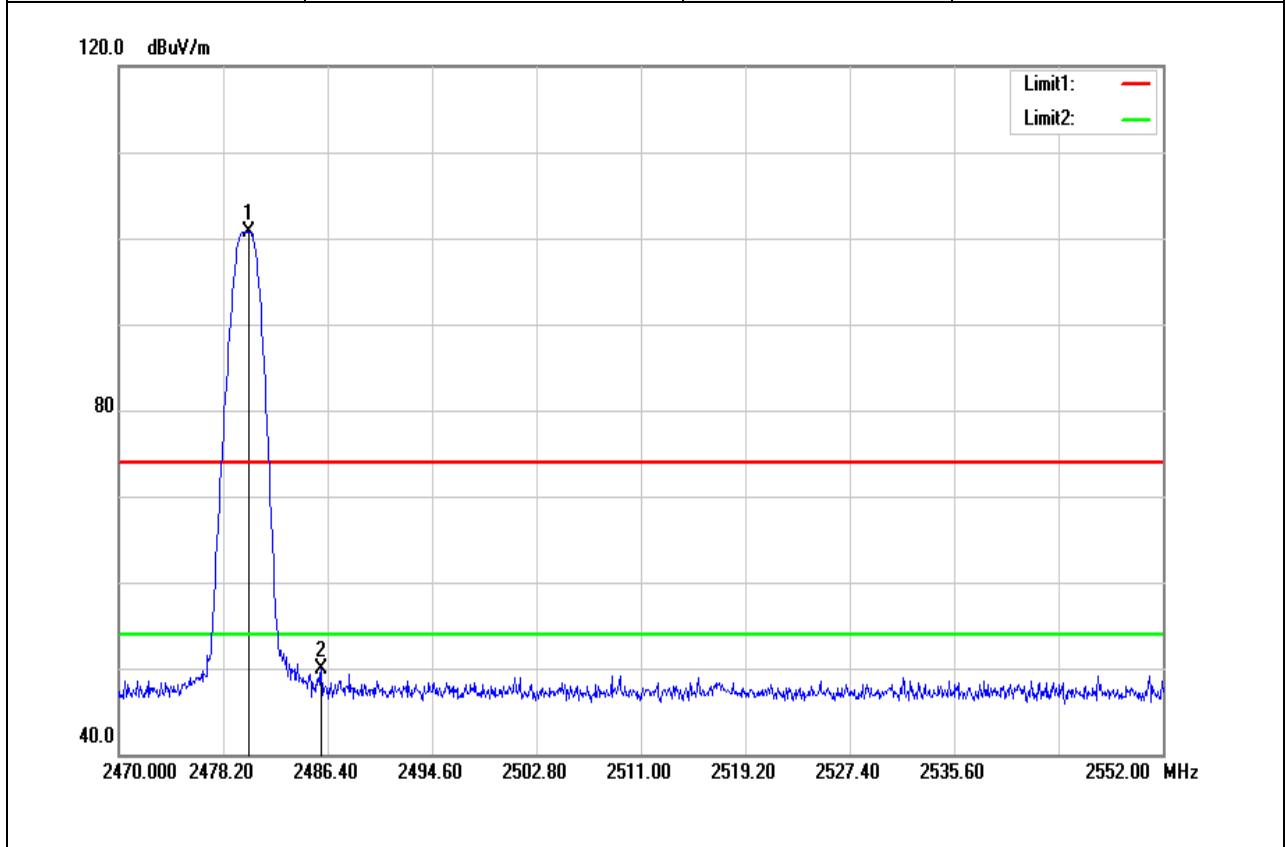

No.	Frequency (MHz)	Reading (dBuV)	Correct Factor(dB/m)	Result (dBuV/m)	Limit (dBuV/m)	Margin (dB)	Remark
1	2480.250	103.50	-2.73	100.77	-	-	peak
2	2485.908	52.60	-2.70	49.90	74.00	-24.10	peak

Test Mode:	BLE High CH	Temp/Hum	22.7(°C)/ 52%RH
Test Item	Band Edge	Test Date	January 19, 2019
Polarize	Vertical	Test Engineer	Jerry Chuang
Detector	Average		

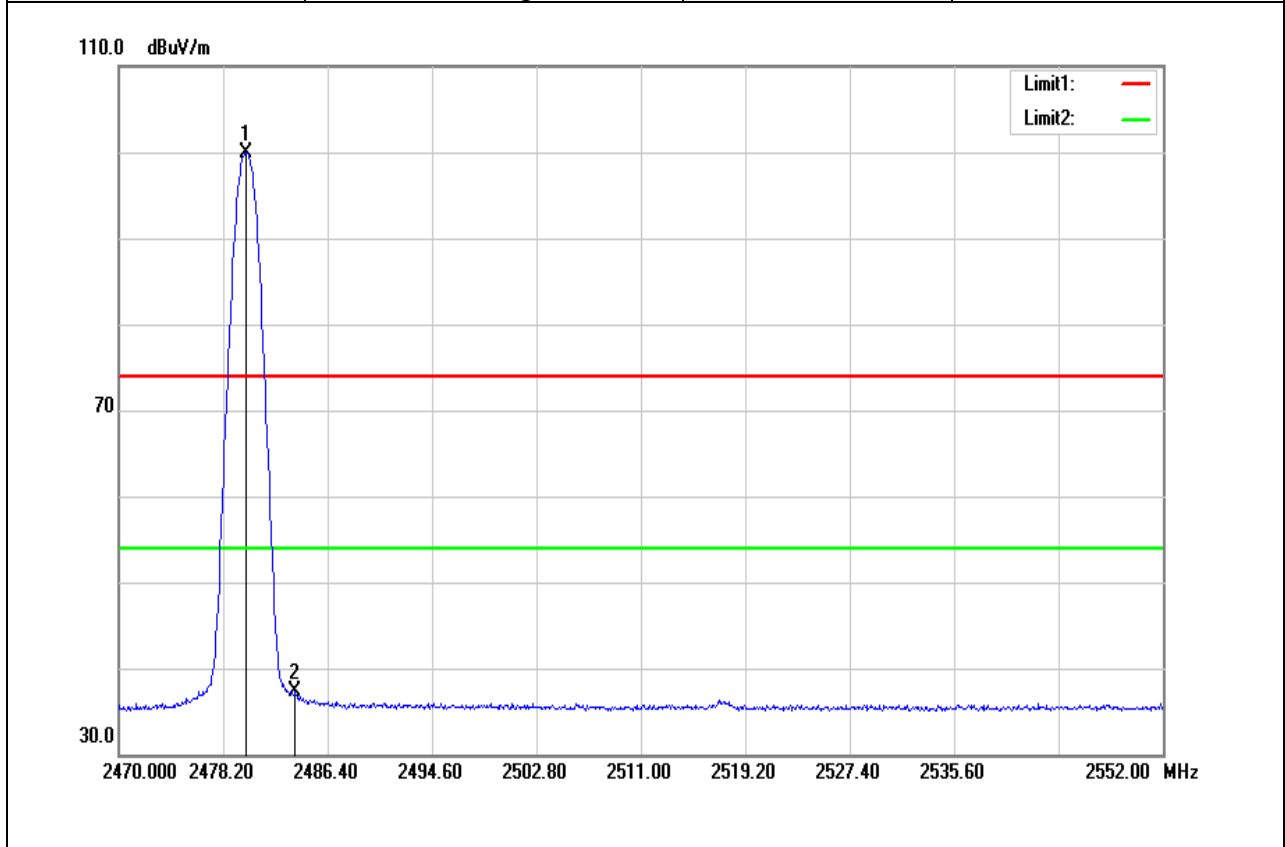

No.	Frequency (MHz)	Reading (dBuV)	Correct Factor(dB/m)	Result (dBuV/m)	Limit (dBuV/m)	Margin (dB)	Remark
1	2480.004	102.71	-2.73	99.98	-	-	AVG
2	2483.858	40.09	-2.71	37.38	54.00	-16.62	AVG

Above 1G Test Data

Test Mode:	BLE Low CH	Temp/Hum	22.7(°C)/ 52%RH
Test Item	Harmonic	Test Date	January 19, 2019
Polarize	Vertical	Test Engineer	Jerry Chuang
Detector	Peak		

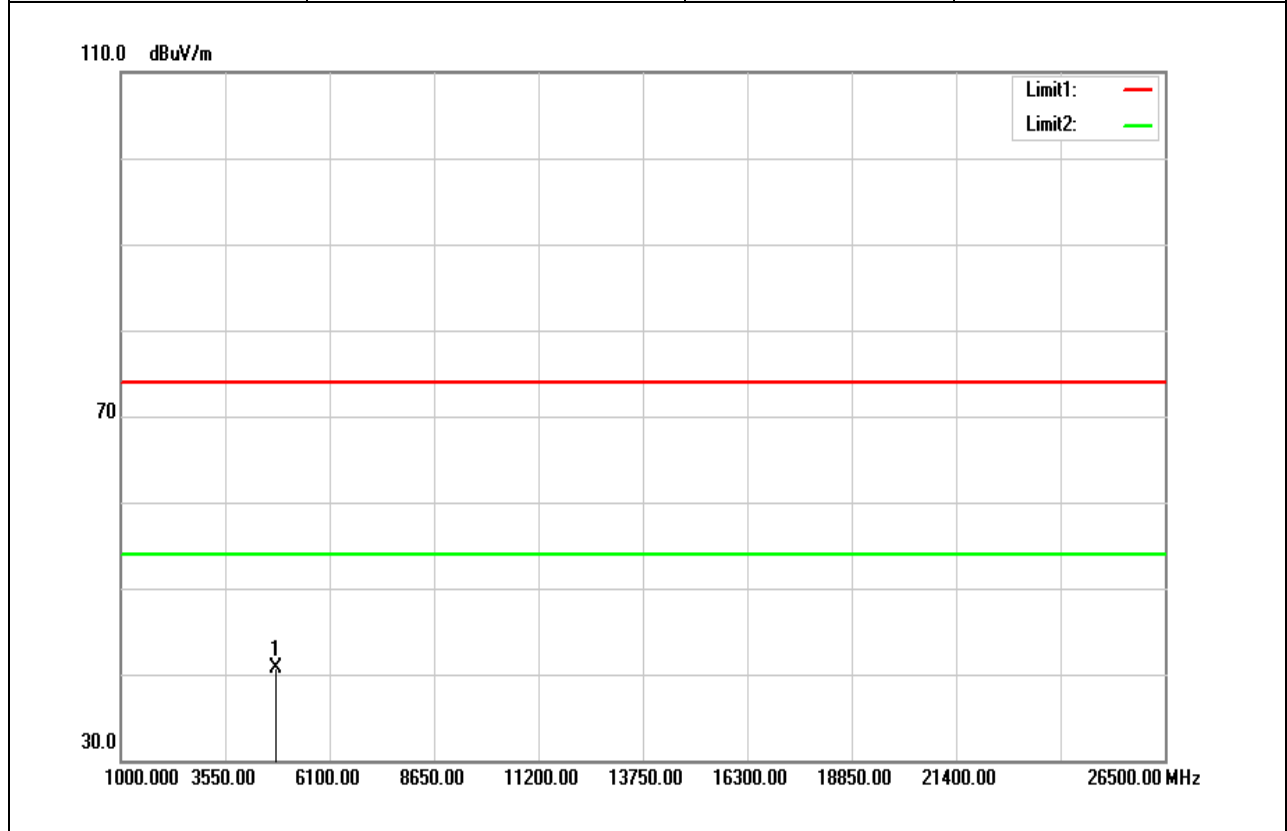

Frequency (MHz)	Reading (dBuV)	Correct Factor (dB/m)	Result (dBuV/m)	Limit (dBuV/m)	Margin (dB)	Remark
4804.000	37.62	3.09	40.71	74.00	-33.29	peak
N/A						

Remark:

- Measuring frequencies from 1 GHz to the 10th harmonic of highest fundamental frequency.
- For above 1GHz, the EUT peak value was under average limit, therefore the Average value compliance with the average limit

Test Mode:	BLE Low CH	Temp/Hum	22.7(°C)/ 52%RH
Test Item	Harmonic	Test Date	January 19, 2019
Polarize	Horizontal	Test Engineer	Jerry Chuang
Detector	Peak		

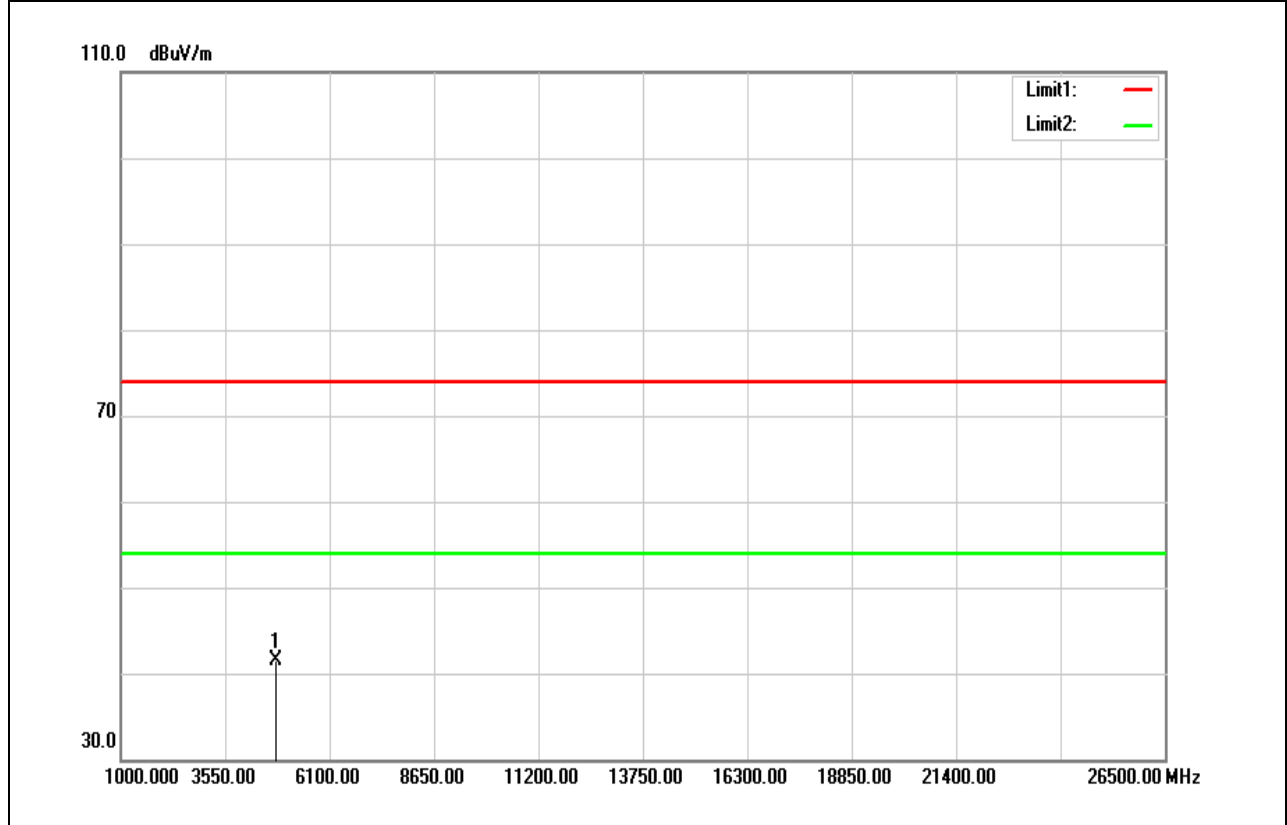

Frequency (MHz)	Reading (dBuV)	Correct Factor (dB/m)	Result (dBuV/m)	Limit (dBuV/m)	Margin (dB)	Remark
4804.000	38.39	3.09	41.48	74.00	-32.52	peak
N/A						

Remark:

- Measuring frequencies from 1 GHz to the 10th harmonic of highest fundamental frequency.
- For above 1GHz, the EUT peak value was under average limit, therefore the Average value compliance with the average limit

Test Mode:	BLE Mid CH	Temp/Hum	22.7(°C)/ 52%RH
Test Item	Harmonic	Test Date	January 19, 2019
Polarize	Vertical	Test Engineer	Jerry Chuang
Detector	Peak		

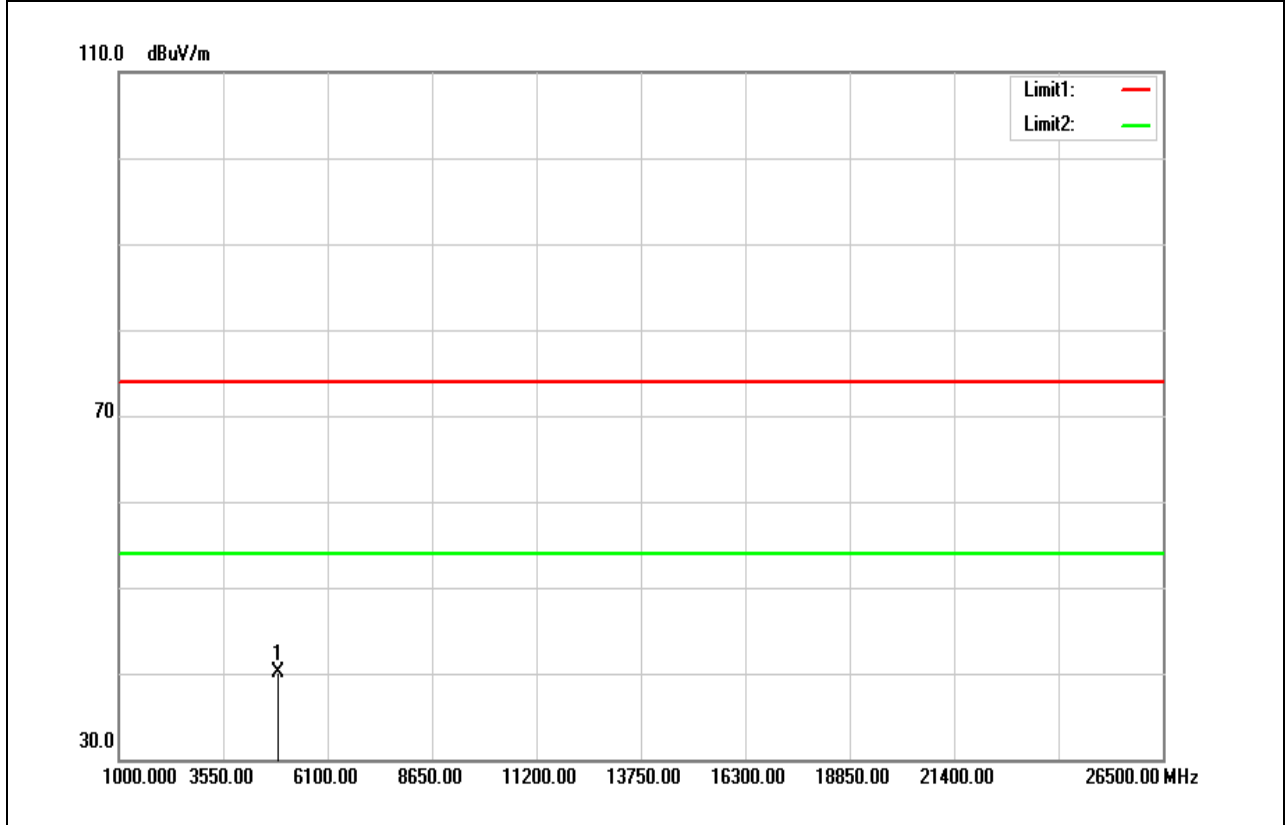

Frequency (MHz)	Reading (dBuV)	Correct Factor (dB/m)	Result (dBuV/m)	Limit (dBuV/m)	Margin (dB)	Remark
4880.000	36.42	3.60	40.02	74.00	-33.98	peak
N/A						

Remark:

1. Measuring frequencies from 1 GHz to the 10th harmonic of highest fundamental frequency.
2. For above 1GHz, the EUT peak value was under average limit, therefore the Average value compliance with the average limit

Test Mode:	BLE Mid CH	Temp/Hum	22.7(°C)/ 52%RH
Test Item	Harmonic	Test Date	January 19, 2019
Polarize	Horizontal	Test Engineer	Jerry Chuang
Detector	Peak		

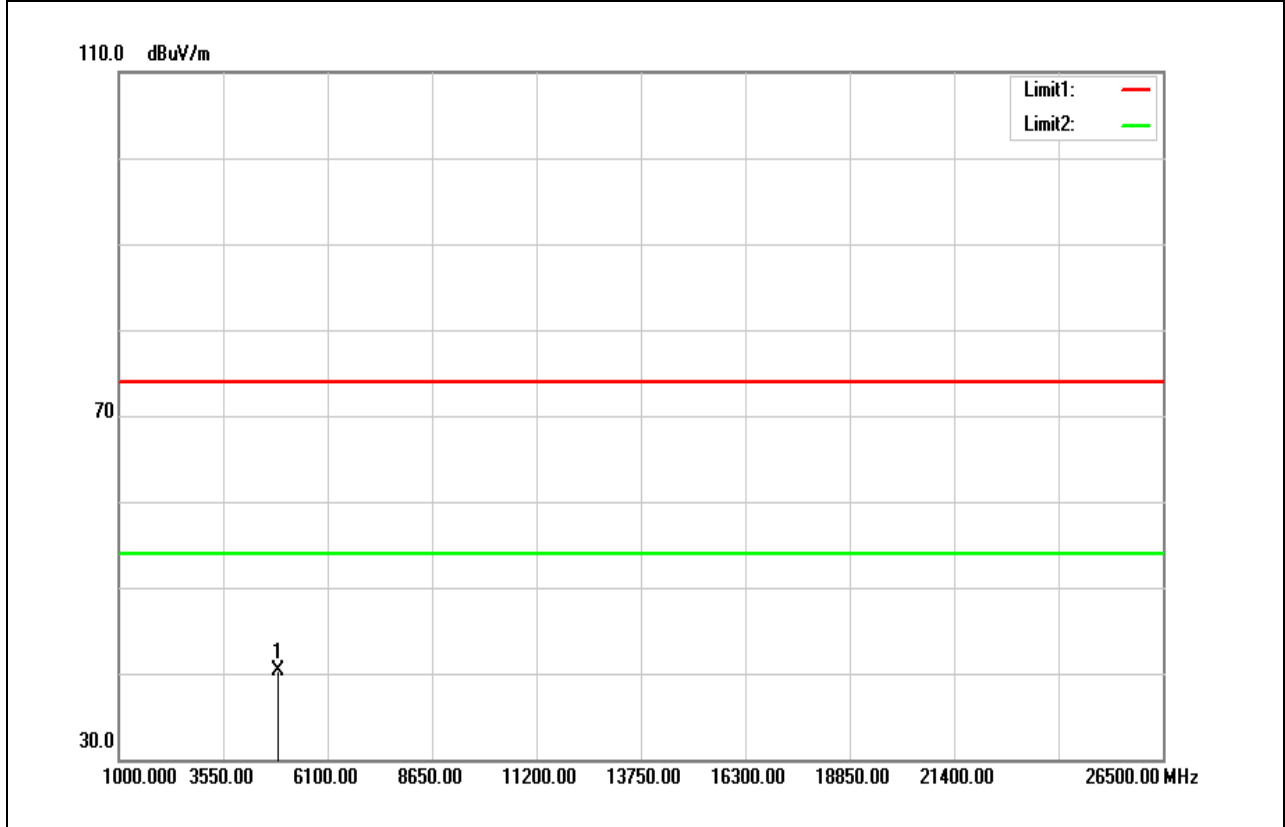

Frequency (MHz)	Reading (dBuV)	Correct Factor (dB/m)	Result (dBuV/m)	Limit (dBuV/m)	Margin (dB)	Remark
4880.000	36.80	3.60	40.40	74.00	-33.60	peak
N/A						

Remark:

1. Measuring frequencies from 1 GHz to the 10th harmonic of highest fundamental frequency.
2. For above 1GHz, the EUT peak value was under average limit, therefore the Average value compliance with the average limit

Test Mode:	BLE High CH	Temp/Hum	22.7(°C)/ 52%RH
Test Item	Harmonic	Test Date	January 19, 2019
Polarize	Vertical	Test Engineer	Jerry Chuang
Detector	Peak		

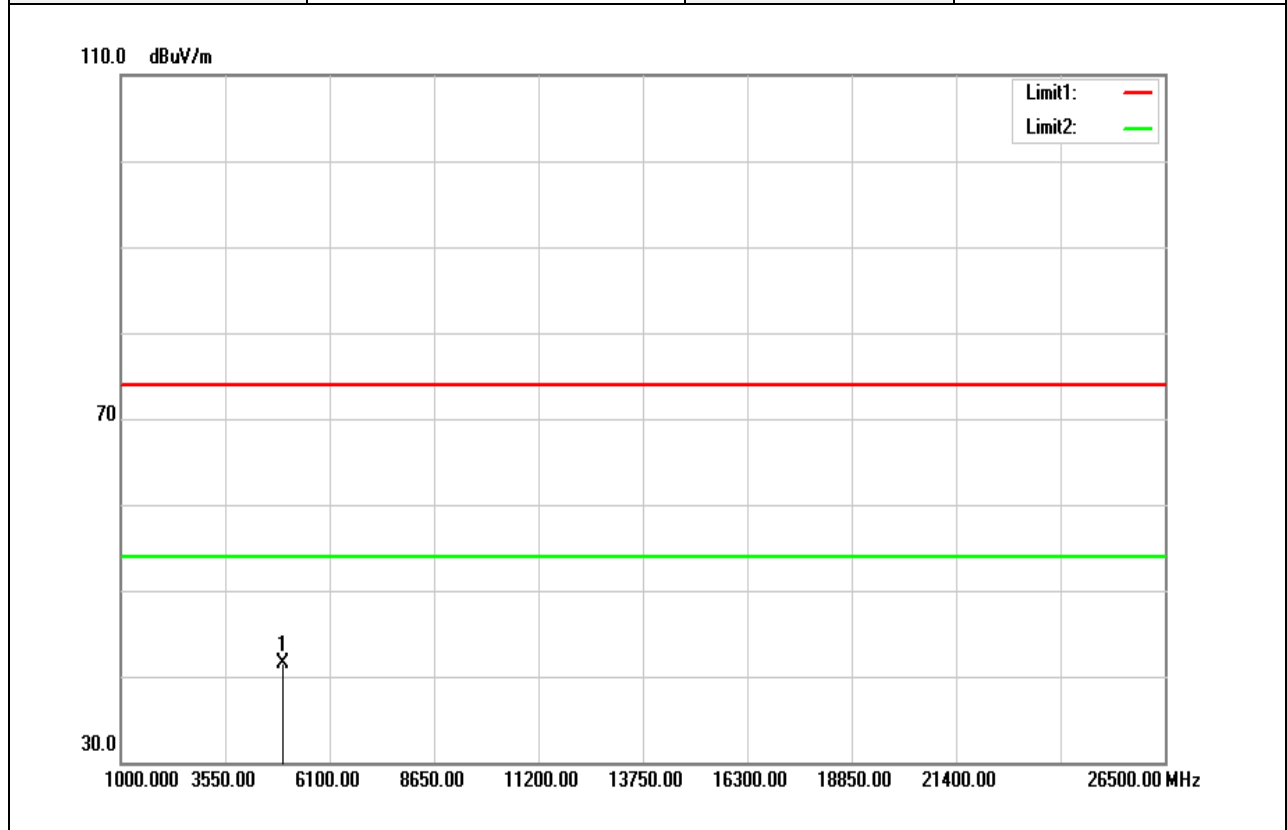

Frequency (MHz)	Reading (dBuV)	Correct Factor (dB/m)	Result (dBuV/m)	Limit (dBuV/m)	Margin (dB)	Remark
4960.000	37.34	4.14	41.48	74.00	-32.52	peak
N/A						

Remark:

1. Measuring frequencies from 1 GHz to the 10th harmonic of highest fundamental frequency.
2. For above 1GHz, the EUT peak value was under average limit, therefore the Average value compliance with the average limit

Test Mode:	BLE High CH	Temp/Hum	22.7(°C)/ 52%RH
Test Item	Harmonic	Test Date	January 19, 2019
Polarize	Horizontal	Test Engineer	Jerry Chuang
Detector	Peak		

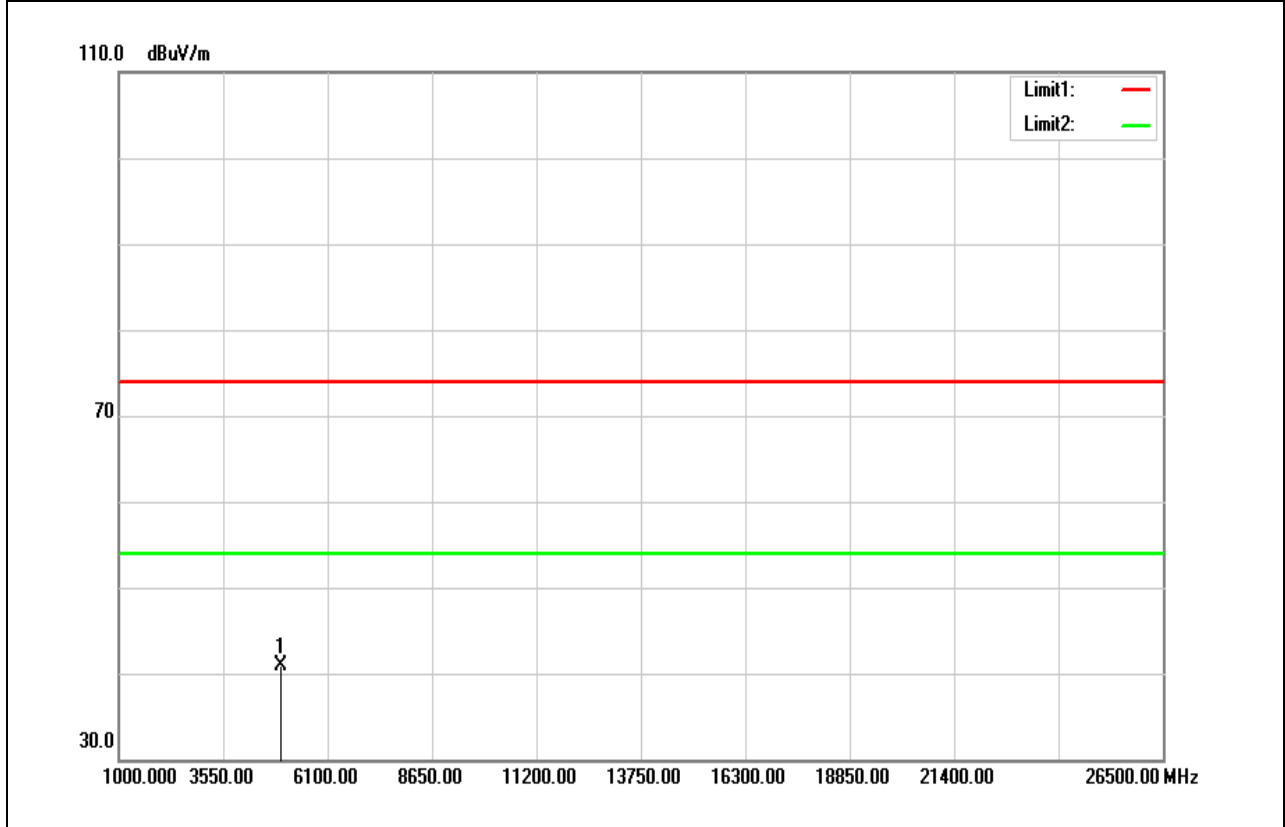

Frequency (MHz)	Reading (dBuV)	Correct Factor (dB/m)	Result (dBuV/m)	Limit (dBuV/m)	Margin (dB)	Remark
4960.000	36.80	4.14	40.94	74.00	-33.06	peak
N/A						

Remark:

1. Measuring frequencies from 1 GHz to the 10th harmonic of highest fundamental frequency.
2. For above 1GHz, the EUT peak value was under average limit, therefore the Average value compliance with the average limit

Below 1G Test Data

Test Mode:	BT Mode	Temp/Hum	22.7(°C)/ 52%RH
Test Item	30MHz-1GHz	Test Date	January 19, 2019
Polarize	Vertical	Test Engineer	Jerry Chuang
Detector	Peak and Quasi-peak		

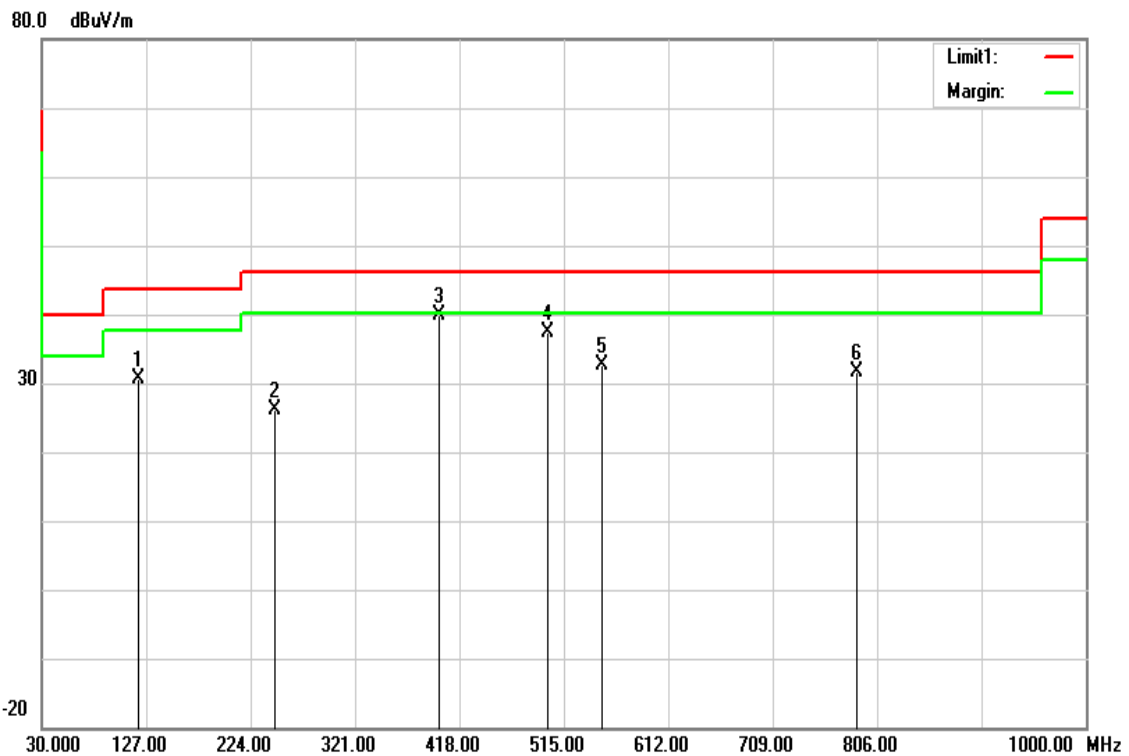

Frequency (MHz)	Reading (dBuV)	Correct Factor (dB/m)	Result (dBuV/m)	Limit (dBuV/m)	Margin (dB)	Remark
119.2400	39.30	-8.55	30.75	43.52	-12.77	peak
246.3100	35.69	-9.44	26.25	46.02	-19.77	peak
399.5700	44.77	-4.81	39.96	46.02	-6.06	peak
500.4500	39.66	-2.28	37.38	46.02	-8.64	peak
549.9200	34.03	-1.41	32.62	46.02	-13.40	peak
786.6000	28.86	2.77	31.63	46.02	-14.39	peak

Note: No emission found between lowest internal used/generated frequency to 30MHz(9KHz~30MHz)

Test Mode:	BT Mode	Temp/Hum	22.7(°C)/ 52%RH
Test Item	30MHz-1GHz	Test Date	January 19, 2019
Polarize	Horizontal	Test Engineer	Jerry Chuang
Detector	Peak and Quasi-peak		

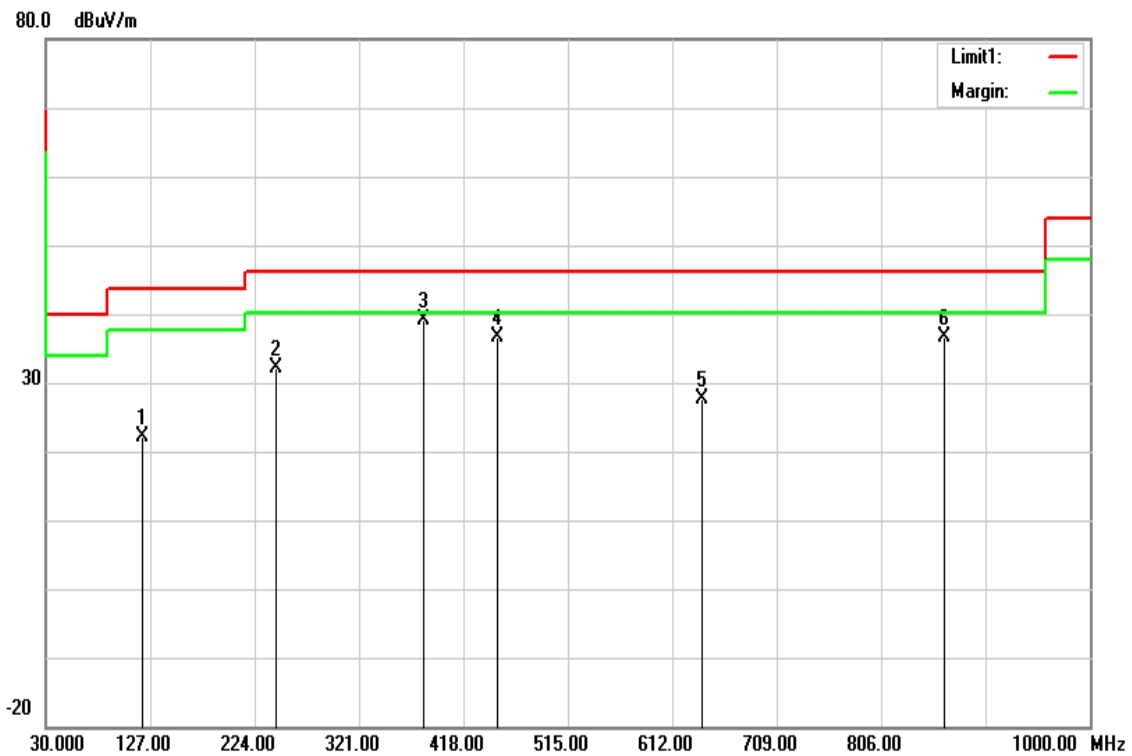

Frequency (MHz)	Reading (dBuV)	Correct Factor (dB/m)	Result (dBuV/m)	Limit (dBuV/m)	Margin (dB)	Remark
120.2100	30.53	-8.41	22.12	43.52	-21.40	peak
244.3700	41.75	-9.51	32.24	46.02	-13.78	peak
381.1400	44.60	-5.50	39.10	46.02	-6.92	peak
450.0100	39.92	-3.25	36.67	46.02	-9.35	peak
640.1300	27.09	0.60	27.69	46.02	-18.33	peak
864.2000	32.66	3.96	36.62	46.02	-9.40	peak

Note: No emission found between lowest internal used/generated frequency to 30MHz(9KHz~30MHz)

--End Report--