

Test Mode	IEEE 802.11a / 5240MHZ	Temp/Hum	23.2(°C)/ 52%RH
Test Item	Harmonic	Test Date	February 15, 2019
Polarize	Vertical	Test Engineer	Jerry Chuang
Detector	Peak		

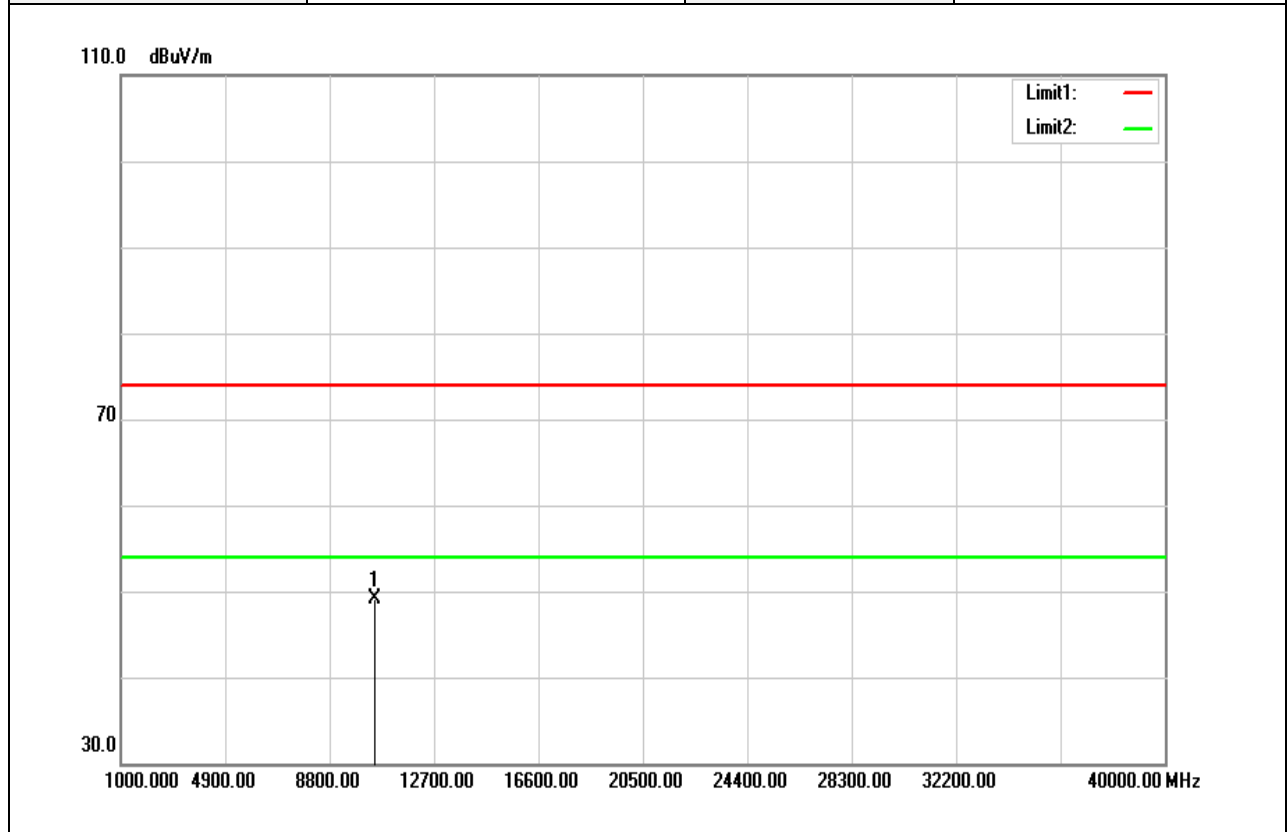

Frequency (MHz)	Reading (dBuV)	Correct Factor (dB/m)	Result (dBuV/m)	Limit (dBuV/m)	Margin (dB)	Remark
10480.000	34.03	15.06	49.09	74.00	-24.91	peak
N/A						

**Remark:**

- Measuring frequencies from 1 GHz to the 10th harmonic of highest fundamental frequency.
- For above 1GHz, the EUT peak value was under average limit, therefore the Average value compliance with the average limit

Test Mode	IEEE 802.11a / 5240MHZ	Temp/Hum	23.2(°C) / 52%RH
Test Item	Harmonic	Test Date	February 15, 2019
Polarize	Horizontal	Test Engineer	Jerry Chuang
Detector	Peak		

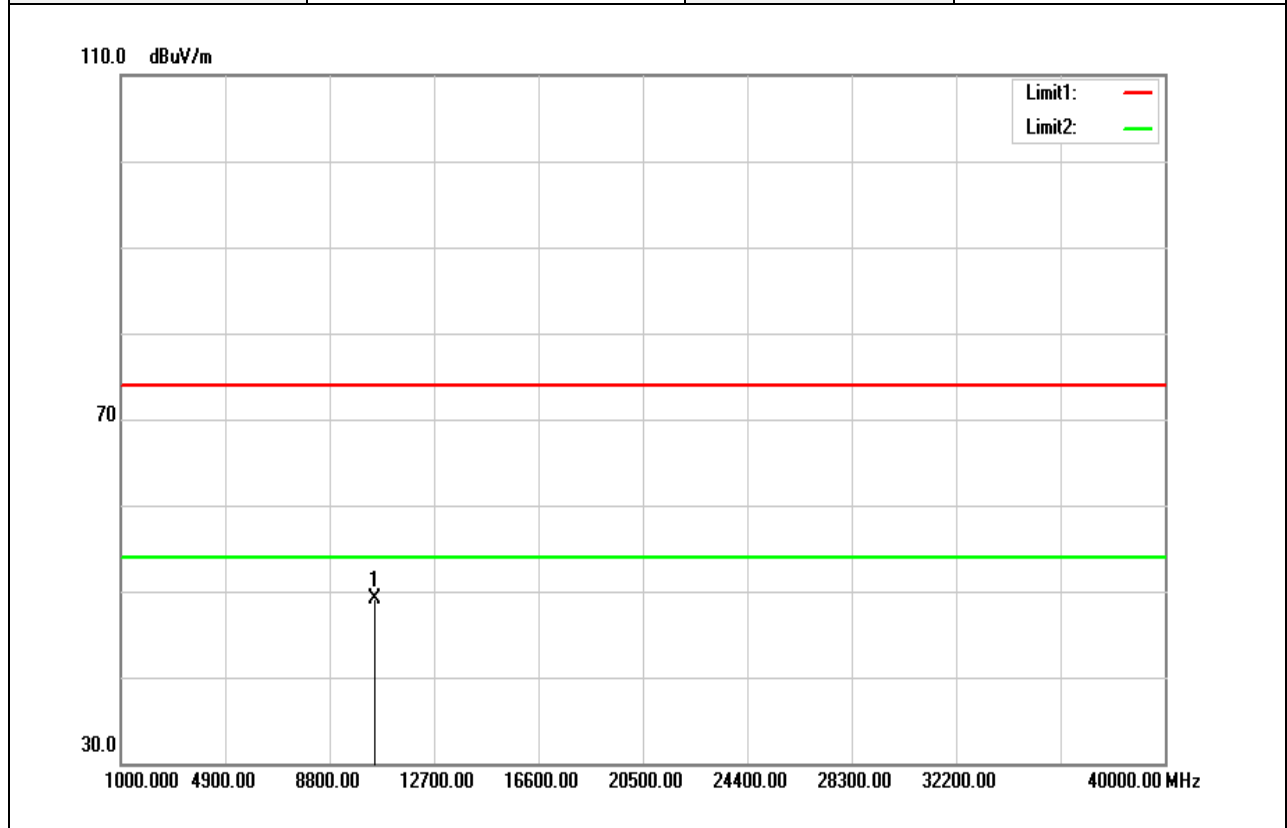

Frequency (MHz)	Reading (dBuV)	Correct Factor (dB/m)	Result (dBuV/m)	Limit (dBuV/m)	Margin (dB)	Remark
10480.000	34.02	15.06	49.08	74.00	-24.92	peak
N/A						

**Remark:**

- Measuring frequencies from 1 GHz to the 10th harmonic of highest fundamental frequency.
- For above 1GHz, the EUT peak value was under average limit, therefore the Average value compliance with the average limit

Test Mode	IEEE 802.11n HT20 / 5180MHZ	Temp/Hum	23.2(°C) / 52%RH
Test Item	Harmonic	Test Date	February 15, 2019
Polarize	Vertical	Test Engineer	Jerry Chuang
Detector	Peak		

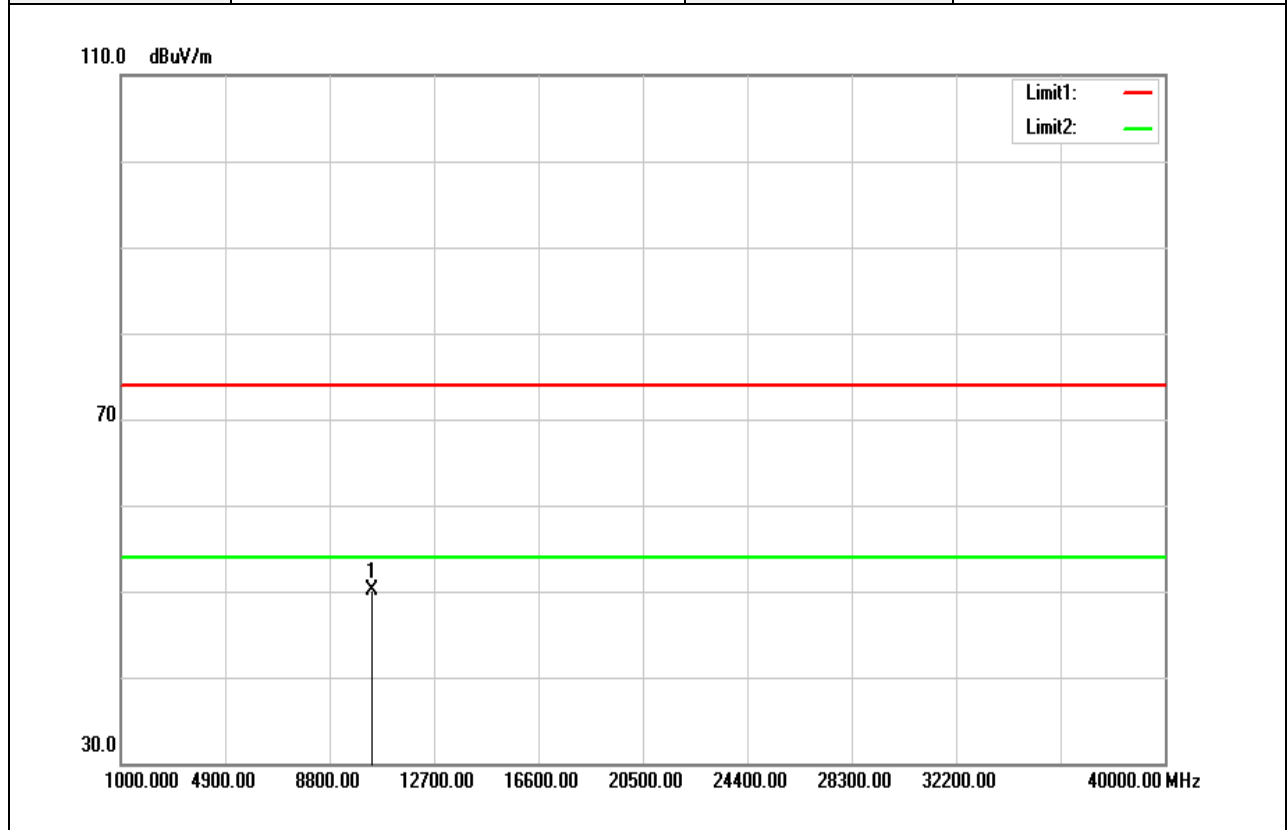

Frequency (MHz)	Reading (dBuV)	Correct Factor (dB/m)	Result (dBuV/m)	Limit (dBuV/m)	Margin (dB)	Remark
10360.000	35.26	14.75	50.01	74.00	-23.99	peak
N/A						

**Remark:**

- Measuring frequencies from 1 GHz to the 10th harmonic of highest fundamental frequency.
- For above 1GHz, the EUT peak value was under average limit, therefore the Average value compliance with the average limit

Test Mode	IEEE 802.11n HT20/ 5180MHZ	Temp/Hum	23.2(°C)/ 52%RH
Test Item	Harmonic	Test Date	February 15, 2019
Polarize	Horizontal	Test Engineer	Jerry Chuang
Detector	Peak		

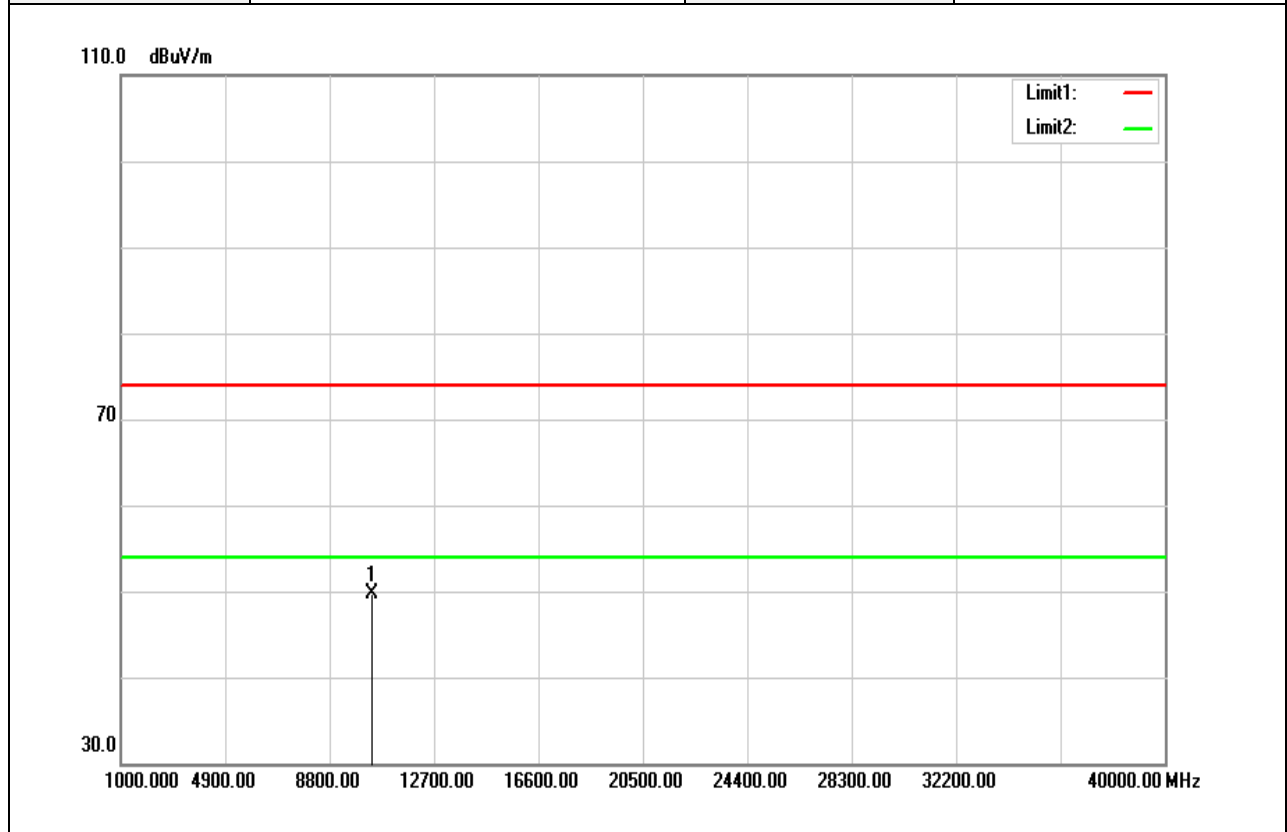

Frequency (MHz)	Reading (dBuV)	Correct Factor (dB/m)	Result (dBuV/m)	Limit (dBuV/m)	Margin (dB)	Remark
10360.000	34.91	14.75	49.66	74.00	-24.34	peak
N/A						

**Remark:**

- Measuring frequencies from 1 GHz to the 10th harmonic of highest fundamental frequency.
- For above 1GHz, the EUT peak value was under average limit, therefore the Average value compliance with the average limit

Test Mode	IEEE 802.11n HT20 / 5220MHZ	Temp/Hum	23.2(°C)/ 52%RH
Test Item	Harmonic	Test Date	February 15, 2019
Polarize	Vertical	Test Engineer	Jerry Chuang
Detector	Peak		

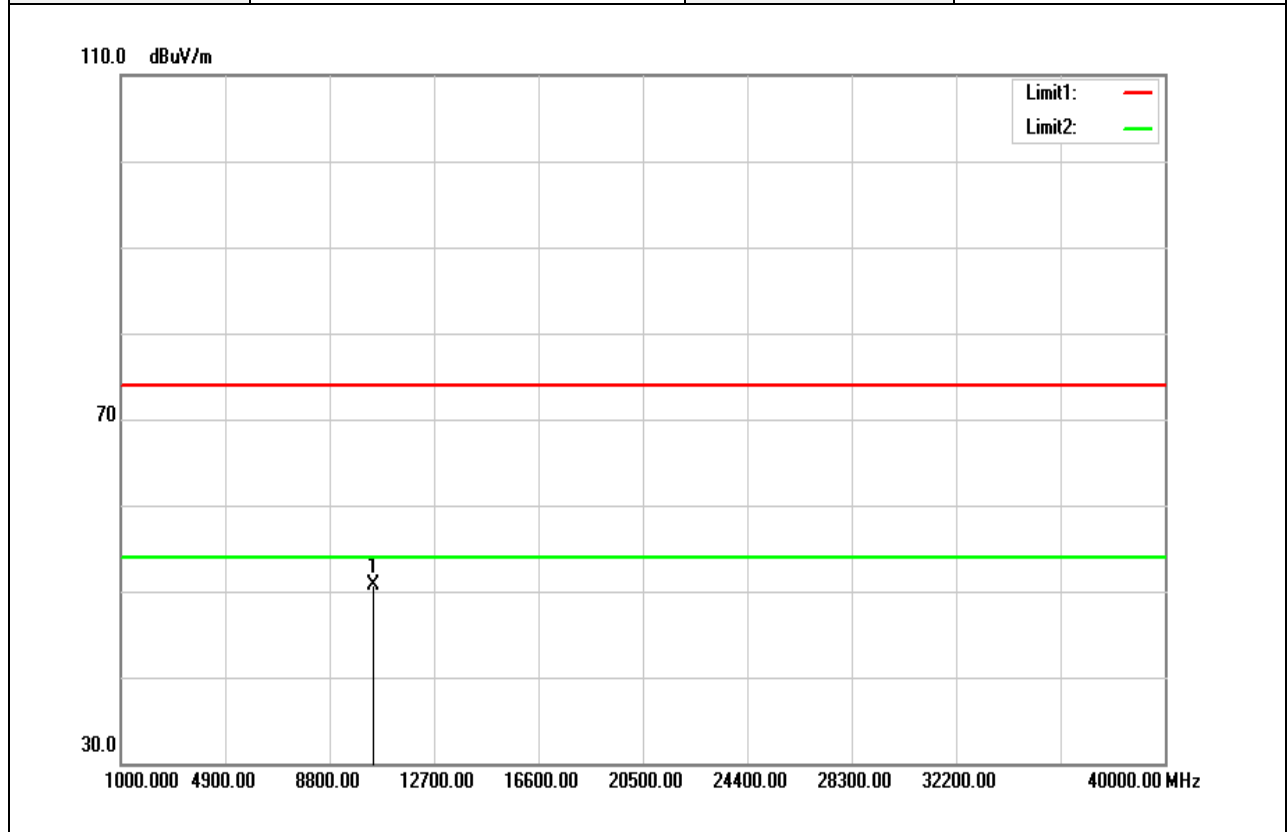

Frequency (MHz)	Reading (dBuV)	Correct Factor (dB/m)	Result (dBuV/m)	Limit (dBuV/m)	Margin (dB)	Remark
10440.000	35.66	15.00	50.66	74.00	-23.34	peak
N/A						

**Remark:**

- Measuring frequencies from 1 GHz to the 10th harmonic of highest fundamental frequency.
- For above 1GHz, the EUT peak value was under average limit, therefore the Average value compliance with the average limit

Test Mode	IEEE 802.11n HT20 / 5220MHZ	Temp/Hum	23.2(°C) / 52%RH
Test Item	Harmonic	Test Date	February 15, 2019
Polarize	Horizontal	Test Engineer	Jerry Chuang
Detector	Peak		

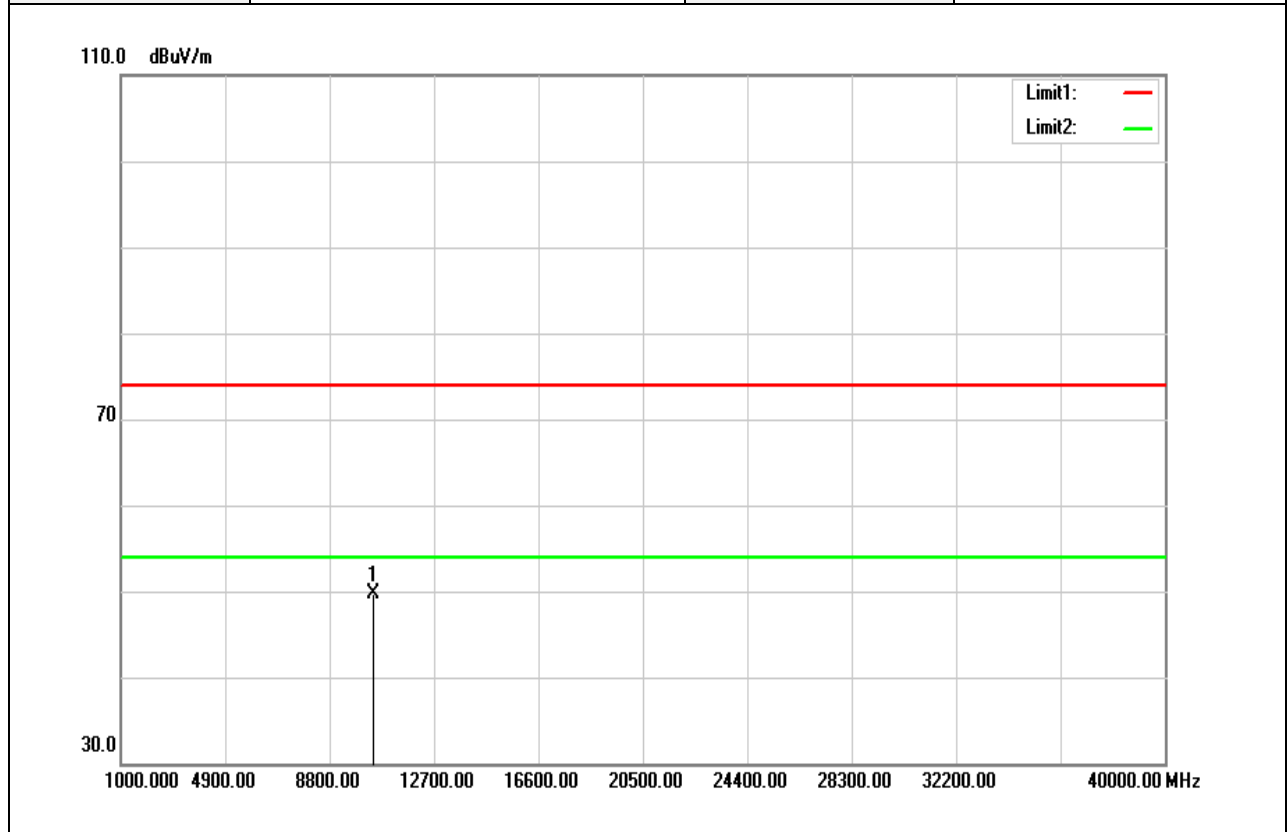

Frequency (MHz)	Reading (dBuV)	Correct Factor (dB/m)	Result (dBuV/m)	Limit (dBuV/m)	Margin (dB)	Remark
10440.000	34.68	15.00	49.68	74.00	-24.32	peak
N/A						

**Remark:**

- Measuring frequencies from 1 GHz to the 10th harmonic of highest fundamental frequency.
- For above 1GHz, the EUT peak value was under average limit, therefore the Average value compliance with the average limit

Test Mode	IEEE 802.11n HT20 / 5240MHZ	Temp/Hum	23.2(°C) / 52%RH
Test Item	Harmonic	Test Date	February 15, 2019
Polarize	Vertical	Test Engineer	Jerry Chuang
Detector	Peak		

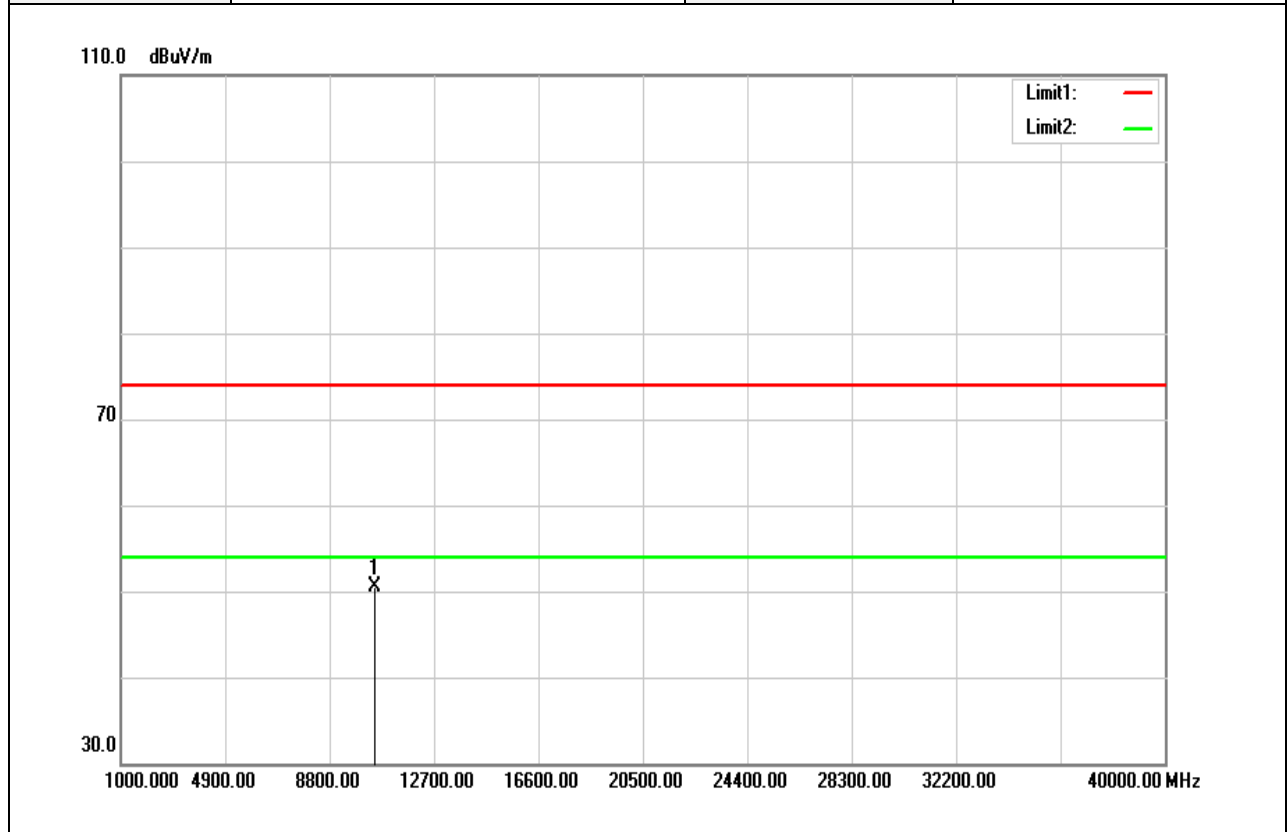

Frequency (MHz)	Reading (dBuV)	Correct Factor (dB/m)	Result (dBuV/m)	Limit (dBuV/m)	Margin (dB)	Remark
10480.000	35.45	15.06	50.51	74.00	-23.49	peak
N/A						

**Remark:**

- Measuring frequencies from 1 GHz to the 10th harmonic of highest fundamental frequency.
- For above 1GHz, the EUT peak value was under average limit, therefore the Average value compliance with the average limit

Test Mode	IEEE 802.11n HT20 / 5240MHZ	Temp/Hum	23.2(°C)/ 52%RH
Test Item	Harmonic	Test Date	February 15, 2019
Polarize	Horizontal	Test Engineer	Jerry Chuang
Detector	Peak		

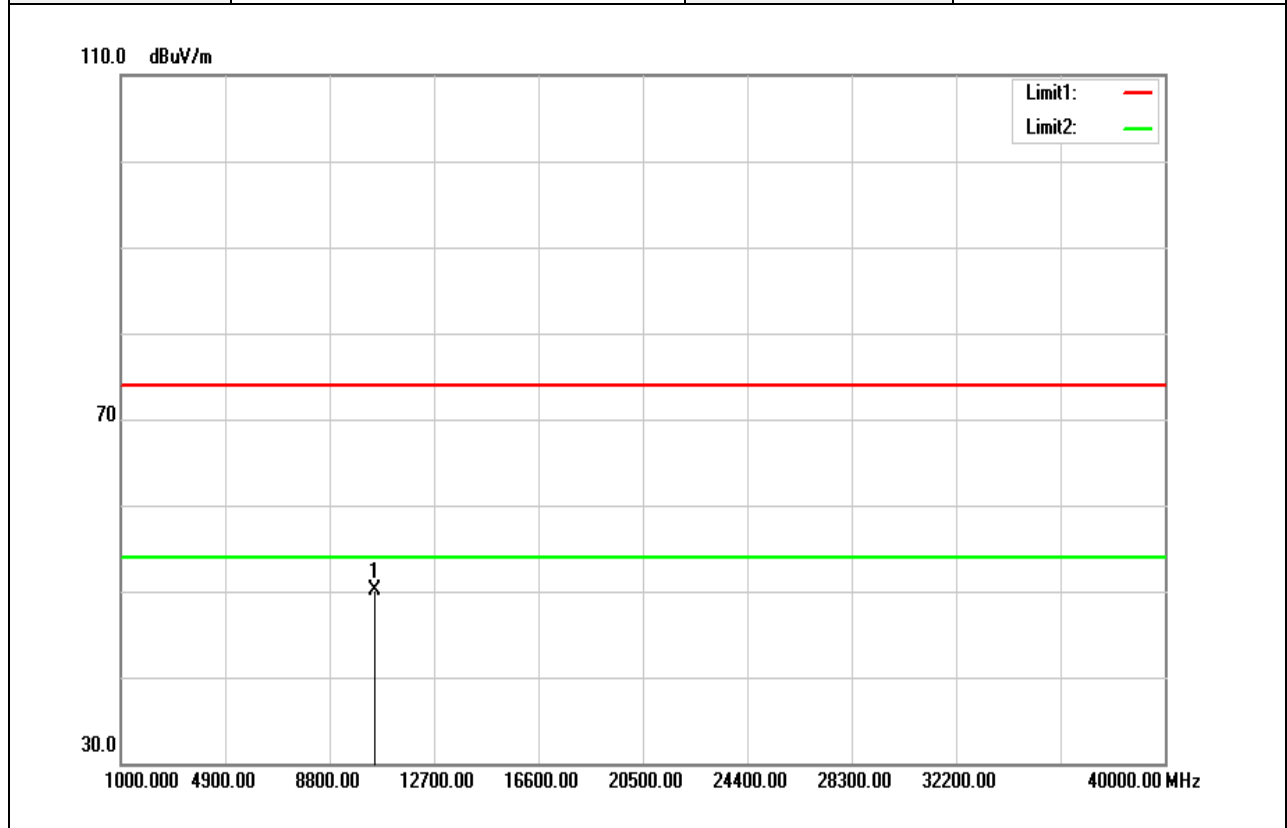

Frequency (MHz)	Reading (dBuV)	Correct Factor (dB/m)	Result (dBuV/m)	Limit (dBuV/m)	Margin (dB)	Remark
10480.000	35.06	15.06	50.12	74.00	-23.88	peak
N/A						

**Remark:**

- Measuring frequencies from 1 GHz to the 10th harmonic of highest fundamental frequency.
- For above 1GHz, the EUT peak value was under average limit, therefore the Average value compliance with the average limit



Test Mode	IEEE 802.11n HT40 / 5190MHZ	Temp/Hum	23.2(°C) / 52%RH
Test Item	Harmonic	Test Date	February 15, 2019
Polarize	Vertical	Test Engineer	Jerry Chuang
Detector	Peak		

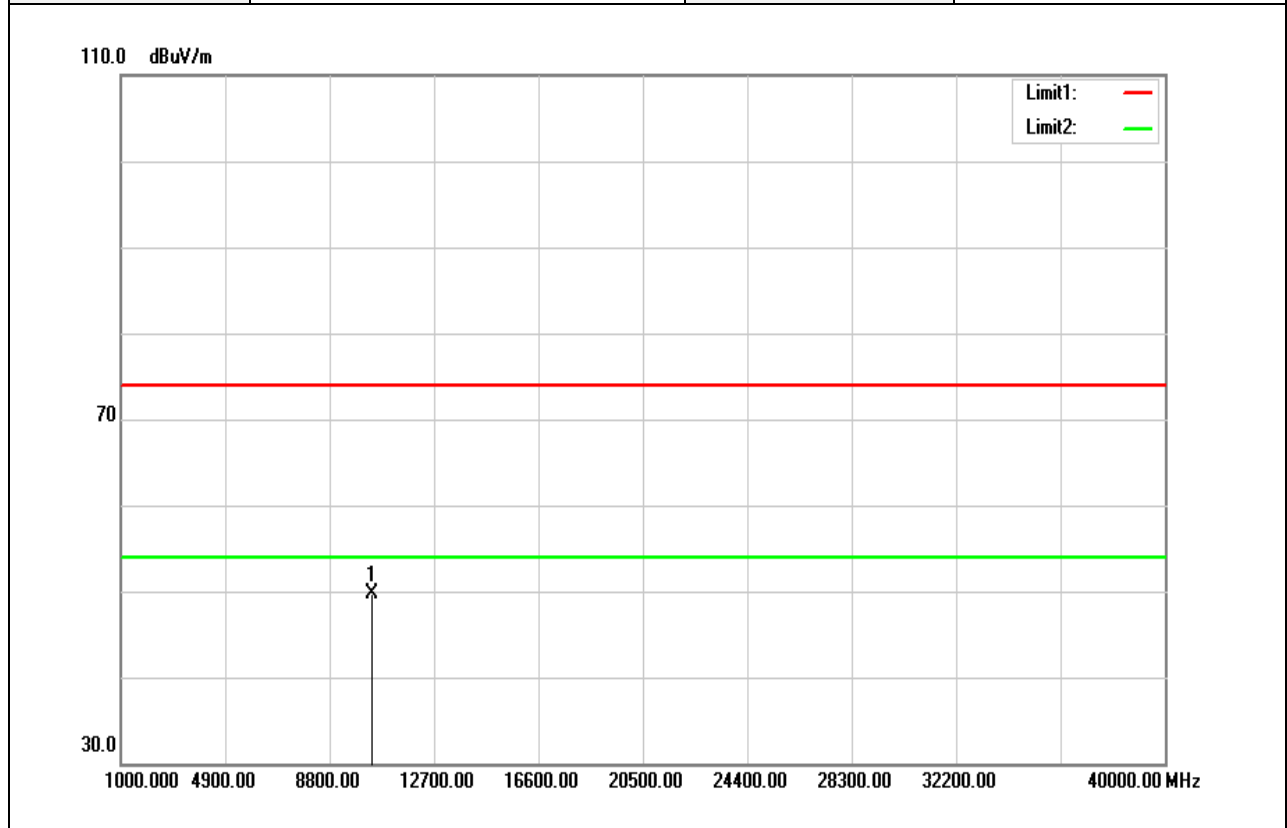

Frequency (MHz)	Reading (dBuV)	Correct Factor (dB/m)	Result (dBuV/m)	Limit (dBuV/m)	Margin (dB)	Remark
10380.000	34.93	14.83	49.76	74.00	-24.24	peak
N/A						

**Remark:**

- Measuring frequencies from 1 GHz to the 10th harmonic of highest fundamental frequency.
- For above 1GHz, the EUT peak value was under average limit, therefore the Average value compliance with the average limit

Test Mode	IEEE 802.11n HT40 / 5190MHZ	Temp/Hum	23.2(°C) / 52%RH
Test Item	Harmonic	Test Date	February 15, 2019
Polarize	Horizontal	Test Engineer	Jerry Chuang
Detector	Peak		

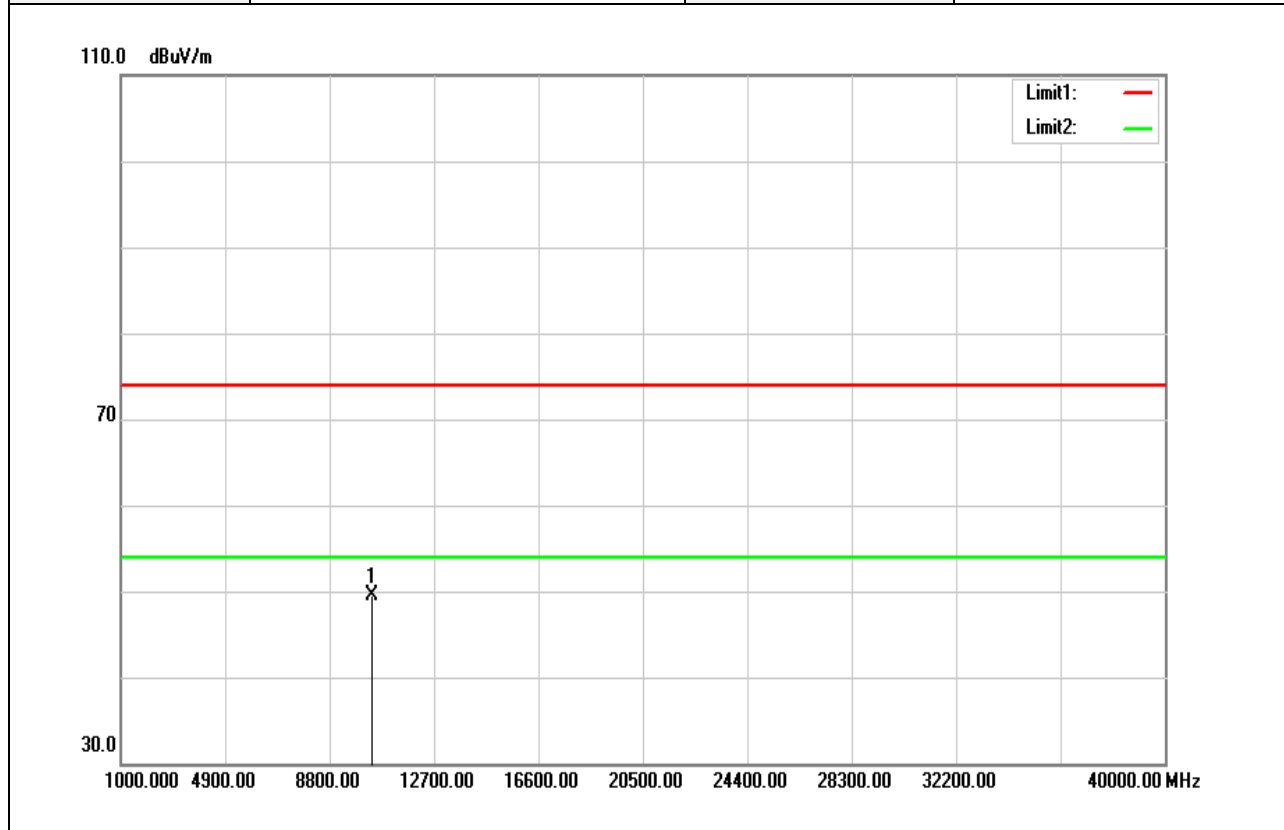

Frequency (MHz)	Reading (dBuV)	Correct Factor (dB/m)	Result (dBuV/m)	Limit (dBuV/m)	Margin (dB)	Remark
10380.000	34.76	14.83	49.59	74.00	-24.41	peak
N/A						

**Remark:**

- Measuring frequencies from 1 GHz to the 10th harmonic of highest fundamental frequency.
- For above 1GHz, the EUT peak value was under average limit, therefore the Average value compliance with the average limit

Test Mode	IEEE 802.11n HT40 / 5230MHZ	Temp/Hum	23.2(°C)/ 52%RH
Test Item	Harmonic	Test Date	February 15, 2019
Polarize	Vertical	Test Engineer	Jerry Chuang
Detector	Peak		

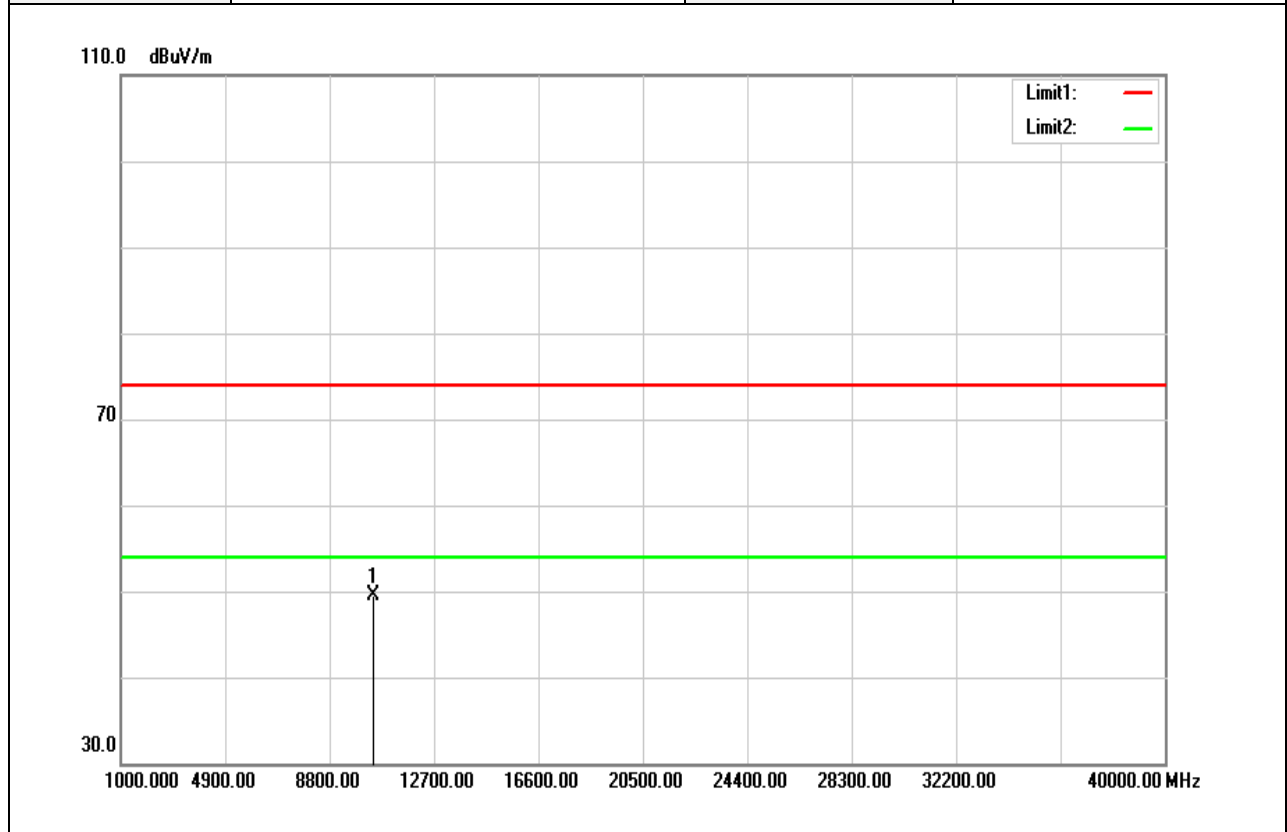

Frequency (MHz)	Reading (dBuV)	Correct Factor (dB/m)	Result (dBuV/m)	Limit (dBuV/m)	Margin (dB)	Remark
10460.000	34.40	15.02	49.42	74.00	-24.58	peak
N/A						

**Remark:**

- Measuring frequencies from 1 GHz to the 10th harmonic of highest fundamental frequency.
- For above 1GHz, the EUT peak value was under average limit, therefore the Average value compliance with the average limit

Test Mode	IEEE 802.11n HT40 / 5230MHZ	Temp/Hum	23.2(°C)/ 52%RH
Test Item	Harmonic	Test Date	February 15, 2019
Polarize	Horizontal	Test Engineer	Jerry Chuang
Detector	Peak		

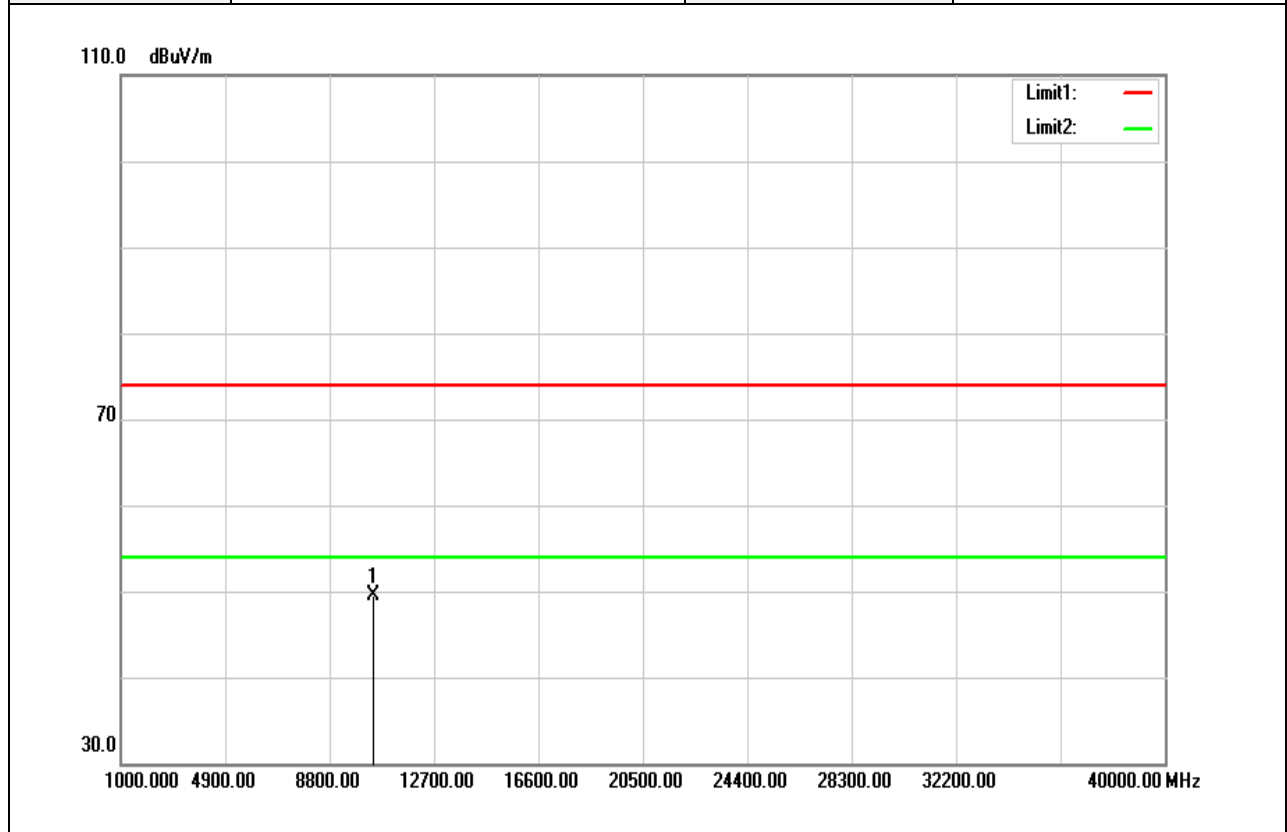

Frequency (MHz)	Reading (dBuV)	Correct Factor (dB/m)	Result (dBuV/m)	Limit (dBuV/m)	Margin (dB)	Remark
10460.000	34.51	15.02	49.53	74.00	-24.47	peak
N/A						

**Remark:**

1. Measuring frequencies from 1 GHz to the 10th harmonic of highest fundamental frequency.
2. For above 1GHz, the EUT peak value was under average limit, therefore the Average value compliance with the average limit

Test Mode	IEEE 802.11ac VHT80 / 5210MHZ	Temp/Hum	23.2(°C)/ 52%RH
Test Item	Harmonic	Test Date	February 15, 2019
Polarize	Vertical	Test Engineer	Jerry Chuang
Detector	Peak		

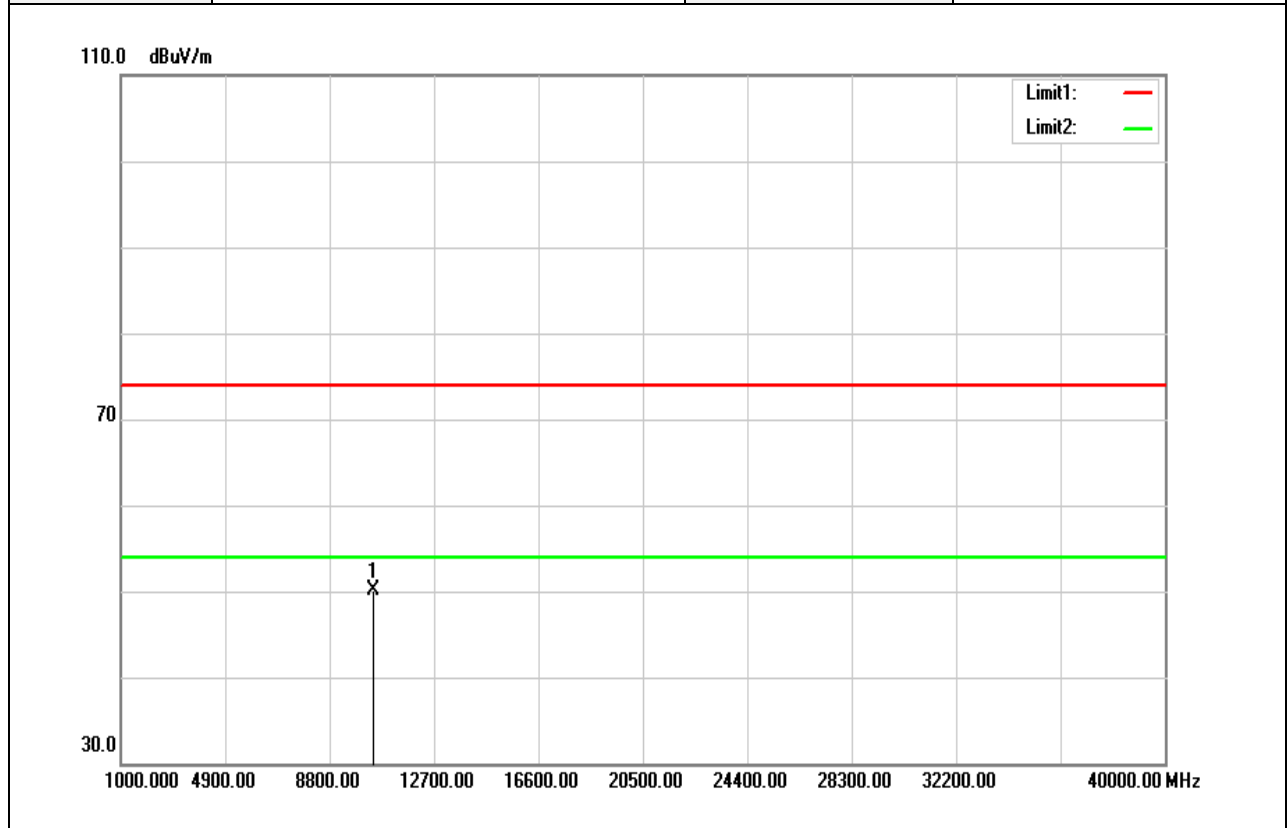

Frequency (MHz)	Reading (dBuV)	Correct Factor (dB/m)	Result (dBuV/m)	Limit (dBuV/m)	Margin (dB)	Remark
10420.000	35.23	14.96	50.19	74.00	-23.81	peak
N/A						

**Remark:**

- Measuring frequencies from 1 GHz to the 10th harmonic of highest fundamental frequency.
- For above 1GHz, the EUT peak value was under average limit, therefore the Average value compliance with the average limit

Test Mode	IEEE 802.11ac VHT80 / 5210MHZ	Temp/Hum	23.2(°C)/ 52%RH
Test Item	Harmonic	Test Date	February 15, 2019
Polarize	Horizontal	Test Engineer	Jerry Chuang
Detector	Peak		

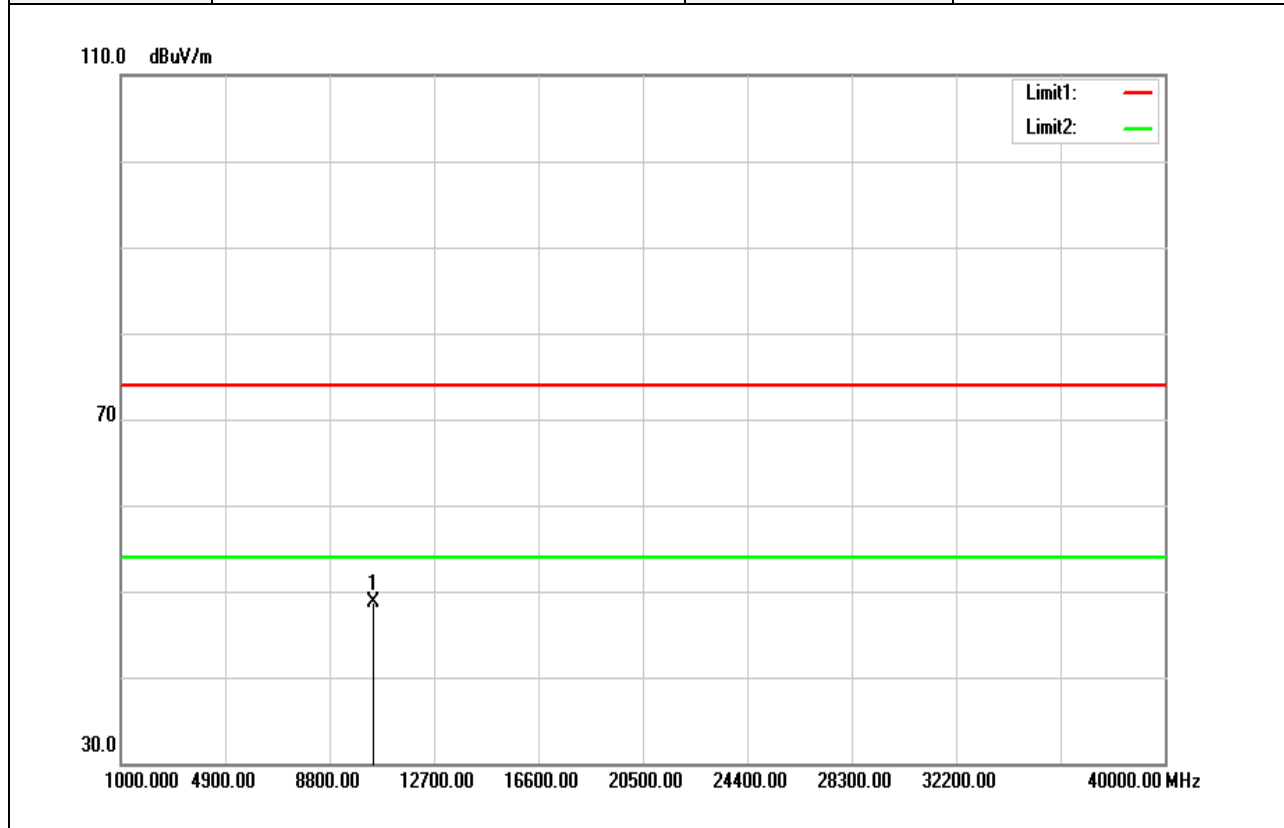

Frequency (MHz)	Reading (dBuV)	Correct Factor (dB/m)	Result (dBuV/m)	Limit (dBuV/m)	Margin (dB)	Remark
10420.000	33.66	14.96	48.62	74.00	-25.38	peak
N/A						

**Remark:**

- Measuring frequencies from 1 GHz to the 10th harmonic of highest fundamental frequency.
- For above 1GHz, the EUT peak value was under average limit, therefore the Average value compliance with the average limit

Report No.: T181222W01-RP4

**Above 1G Test Data for UNII-2a**

Test Mode	IEEE 802.11a / 5260 MHz	Temp/Hum	23.2(°C)/ 52%RH
Test Item	Harmonic	Test Date	February 15, 2019
Polarize	Vertical	Test Engineer	Jerry Chuang
Detector	Peak		

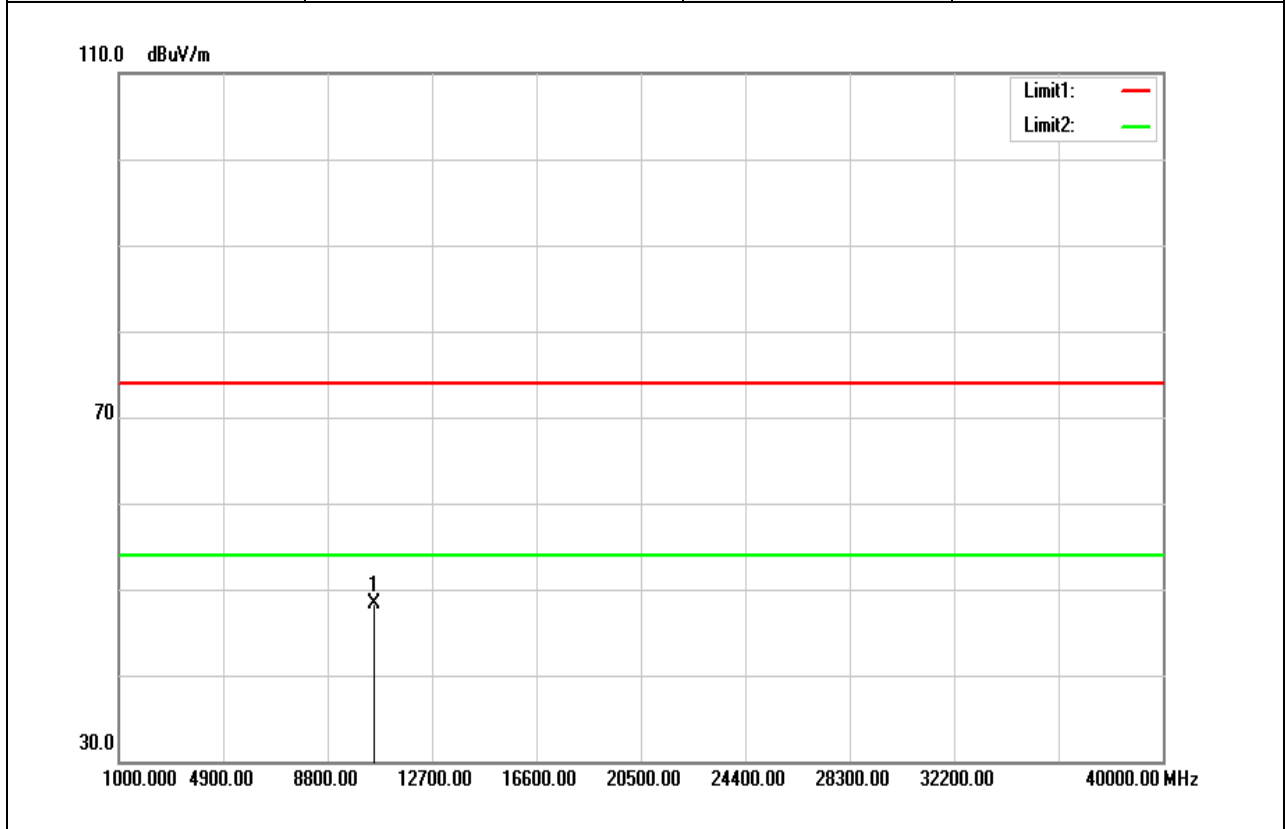

Frequency (MHz)	Reading (dBuV)	Correct Factor (dB/m)	Result (dBuV/m)	Limit (dBuV/m)	Margin (dB)	Remark
10520.000	33.25	15.11	48.36	74.00	-25.64	peak
N/A						

**Remark:**

1. Measuring frequencies from 1 GHz to the 10th harmonic of highest fundamental frequency.
2. For above 1GHz, the EUT peak value was under average limit, therefore the Average value compliance with the average limit

Test Mode	IEEE 802.11a / 5260 MHz	Temp/Hum	23.2(°C)/ 52%RH
Test Item	Harmonic	Test Date	February 15, 2019
Polarize	Horizontal	Test Engineer	Jerry Chuang
Detector	Peak		

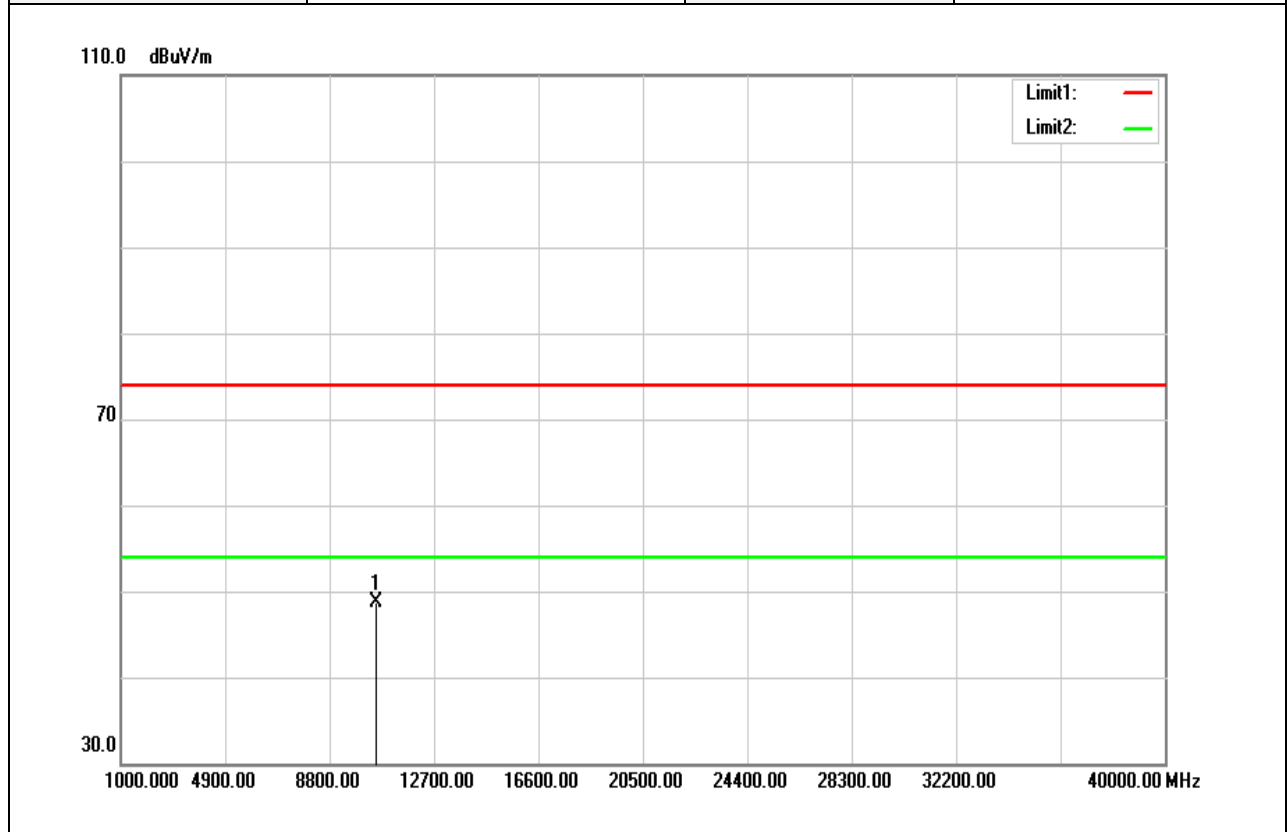

Frequency (MHz)	Reading (dBuV)	Correct Factor (dB/m)	Result (dBuV/m)	Limit (dBuV/m)	Margin (dB)	Remark
10520.000	33.69	15.11	48.80	74.00	-25.20	peak
N/A						

**Remark:**

- Measuring frequencies from 1 GHz to the 10th harmonic of highest fundamental frequency.
- For above 1GHz, the EUT peak value was under average limit, therefore the Average value compliance with the average limit



Test Mode	IEEE 802.11a / 5280 MHz	Temp/Hum	23.2(°C) / 52%RH
Test Item	Harmonic	Test Date	February 15, 2019
Polarize	Vertical	Test Engineer	Jerry Chuang
Detector	Peak		

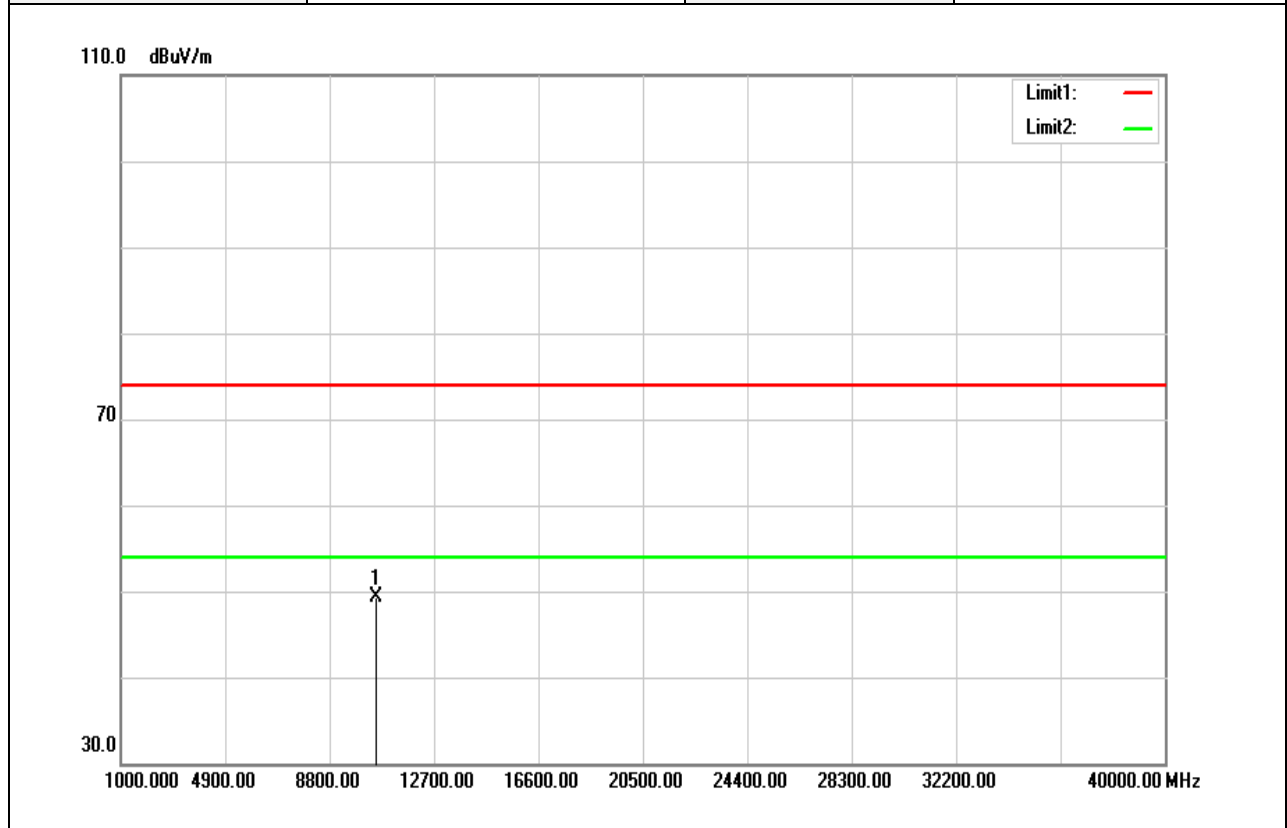

Frequency (MHz)	Reading (dBuV)	Correct Factor (dB/m)	Result (dBuV/m)	Limit (dBuV/m)	Margin (dB)	Remark
10560.000	34.26	15.13	49.39	74.00	-24.61	peak
N/A						

**Remark:**

- Measuring frequencies from 1 GHz to the 10th harmonic of highest fundamental frequency.
- For above 1GHz, the EUT peak value was under average limit, therefore the Average value compliance with the average limit

Test Mode	IEEE 802.11a / 5280 MHz	Temp/Hum	23.2(°C)/ 52%RH
Test Item	Harmonic	Test Date	February 15, 2019
Polarize	Horizontal	Test Engineer	Jerry Chuang
Detector	Peak		

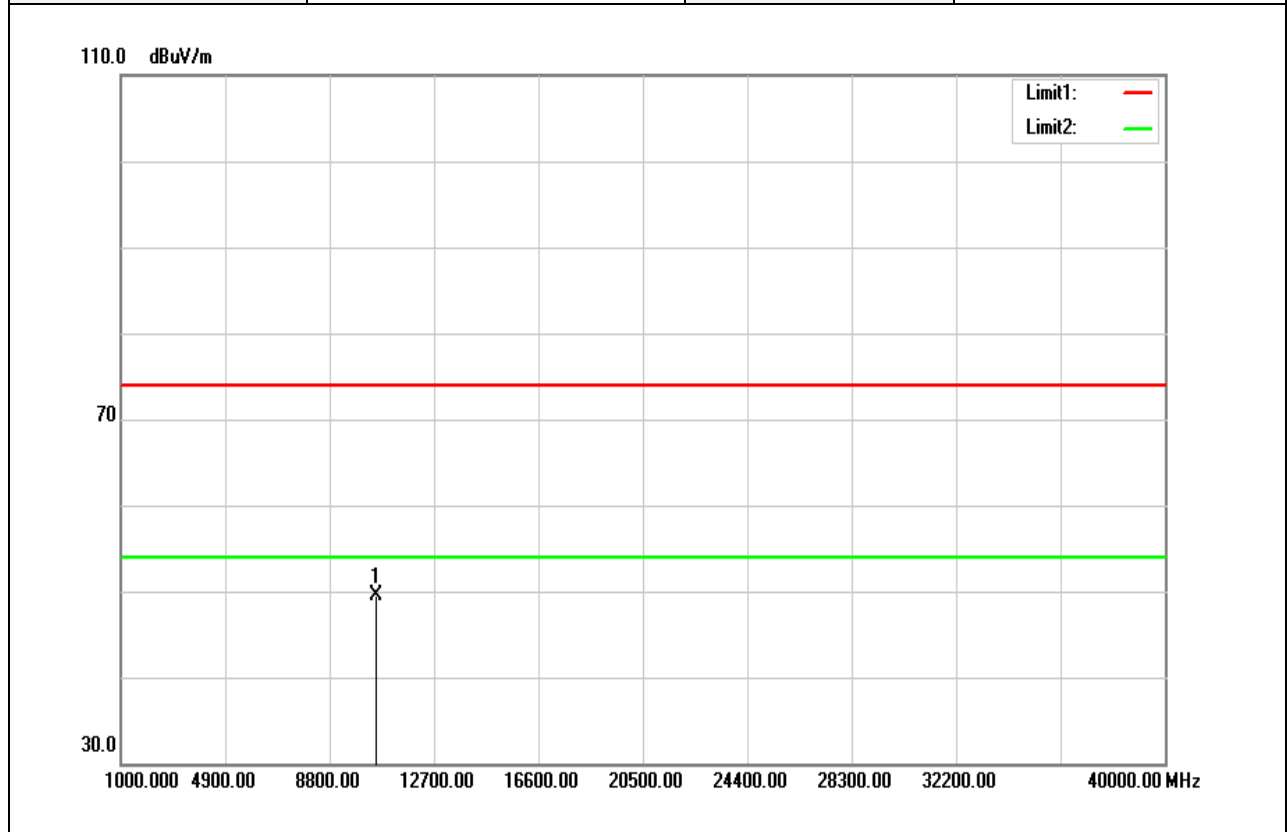

Frequency (MHz)	Reading (dBuV)	Correct Factor (dB/m)	Result (dBuV/m)	Limit (dBuV/m)	Margin (dB)	Remark
10560.000	34.36	15.13	49.49	74.00	-24.51	peak
N/A						

**Remark:**

- Measuring frequencies from 1 GHz to the 10th harmonic of highest fundamental frequency.
- For above 1GHz, the EUT peak value was under average limit, therefore the Average value compliance with the average limit

Test Mode	IEEE 802.11a / 5320 MHz	Temp/Hum	23.2(°C) / 52%RH
Test Item	Harmonic	Test Date	February 15, 2019
Polarize	Vertical	Test Engineer	Jerry Chuang
Detector	Peak		

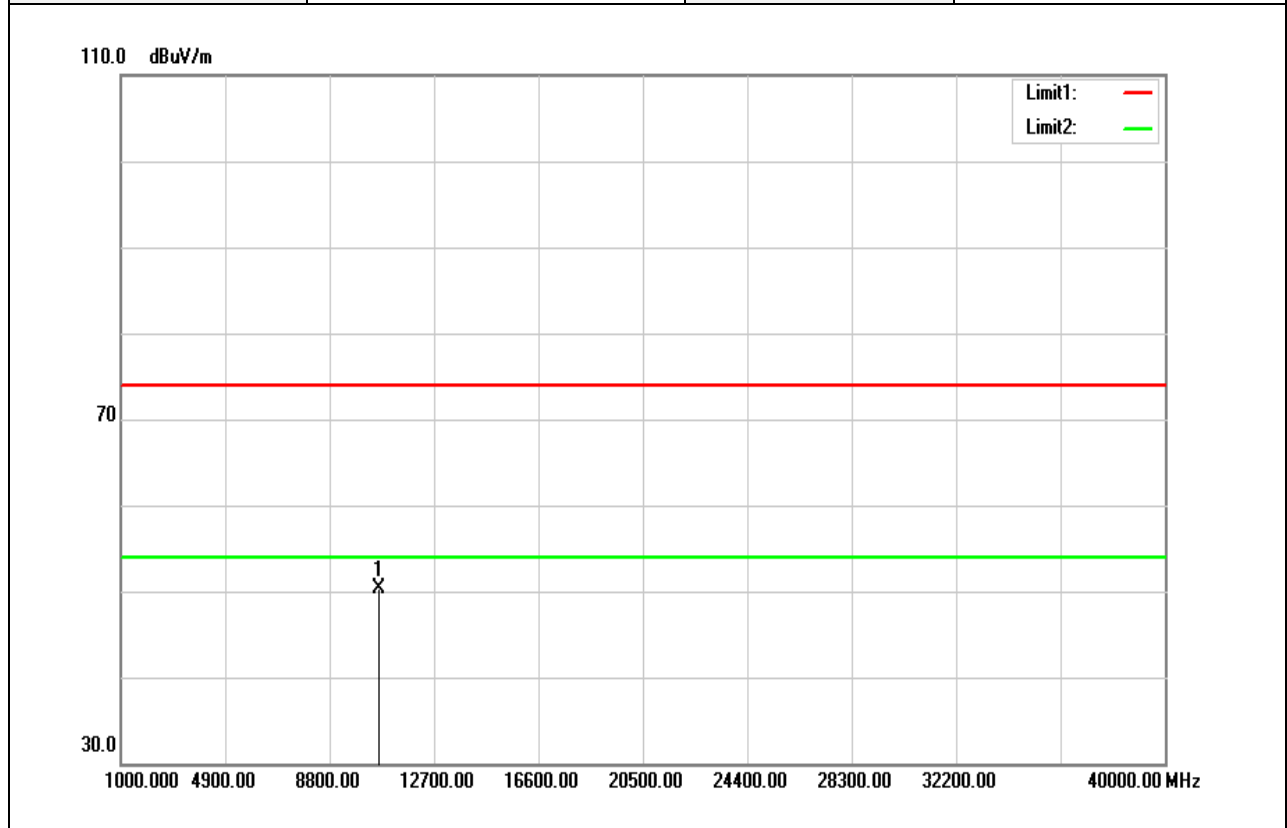

Frequency (MHz)	Reading (dBuV)	Correct Factor (dB/m)	Result (dBuV/m)	Limit (dBuV/m)	Margin (dB)	Remark
10640.000	35.07	15.22	50.29	74.00	-23.71	peak
N/A						

**Remark:**

- Measuring frequencies from 1 GHz to the 10th harmonic of highest fundamental frequency.
- For above 1GHz, the EUT peak value was under average limit, therefore the Average value compliance with the average limit

Test Mode	IEEE 802.11a / 5320 MHz	Temp/Hum	23.2(°C) / 52%RH
Test Item	Harmonic	Test Date	February 15, 2019
Polarize	Horizontal	Test Engineer	Jerry Chuang
Detector	Peak		

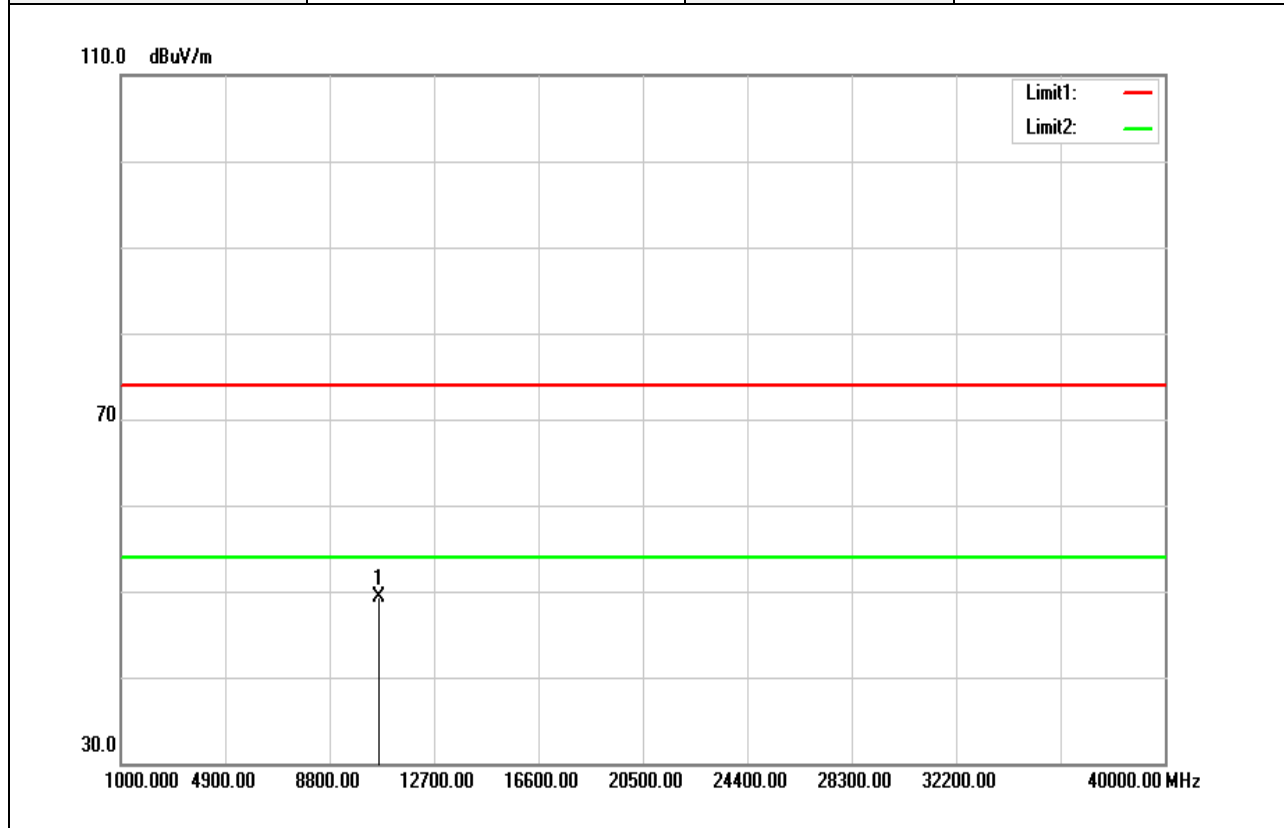

Frequency (MHz)	Reading (dBuV)	Correct Factor (dB/m)	Result (dBuV/m)	Limit (dBuV/m)	Margin (dB)	Remark
10640.000	34.02	15.22	49.24	74.00	-24.76	peak
N/A						

**Remark:**

1. Measuring frequencies from 1 GHz to the 10th harmonic of highest fundamental frequency.
2. For above 1GHz, the EUT peak value was under average limit, therefore the Average value compliance with the average limit

Test Mode	IEEE 802.11n HT20 / 5260 MHz	Temp/Hum	23.2(°C) / 52%RH
Test Item	Harmonic	Test Date	February 15, 2019
Polarize	Vertical	Test Engineer	Jerry Chuang
Detector	Peak		

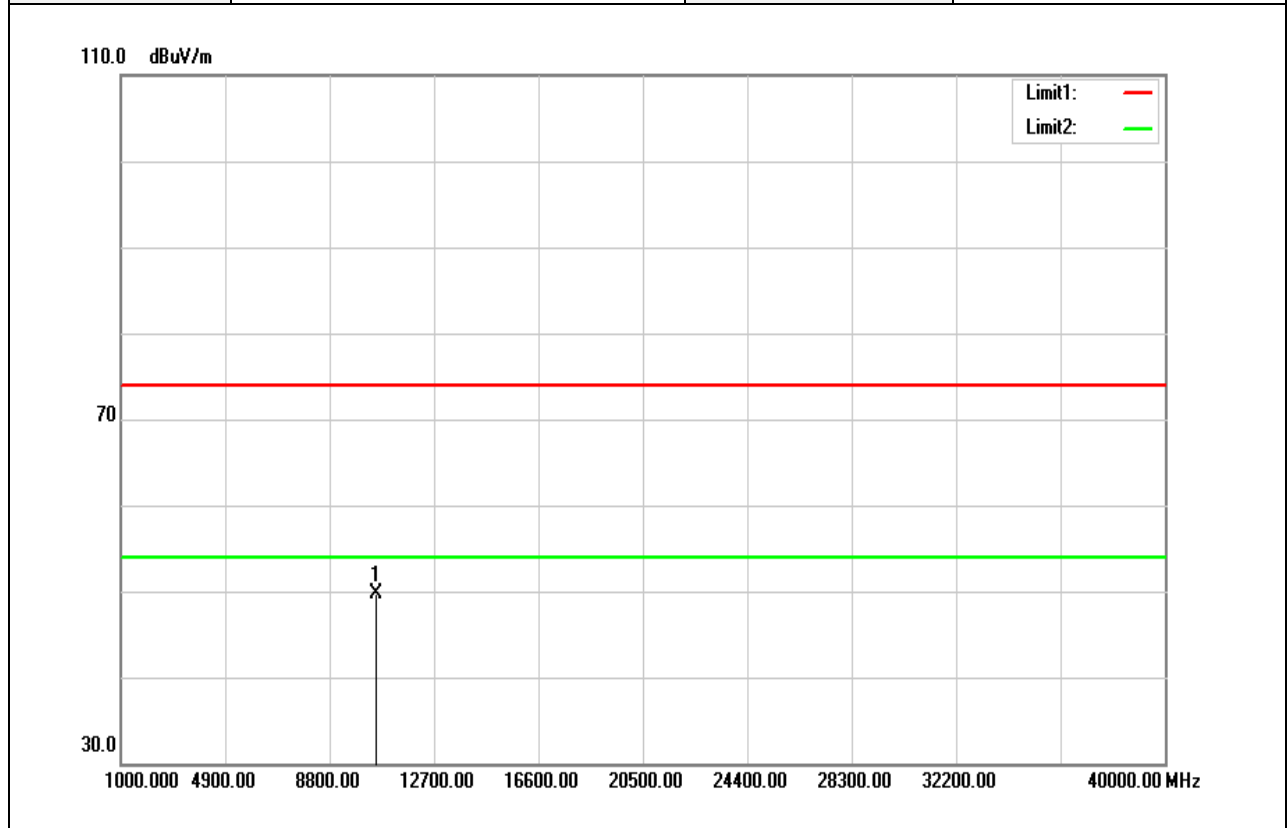

Frequency (MHz)	Reading (dBuV)	Correct Factor (dB/m)	Result (dBuV/m)	Limit (dBuV/m)	Margin (dB)	Remark
10520.000	34.67	15.11	49.78	74.00	-24.22	peak
N/A						

**Remark:**

- Measuring frequencies from 1 GHz to the 10th harmonic of highest fundamental frequency.
- For above 1GHz, the EUT peak value was under average limit, therefore the Average value compliance with the average limit

Test Mode	IEEE 802.11n HT20 / 5260 MHz	Temp/Hum	23.2(°C)/ 52%RH
Test Item	Harmonic	Test Date	February 15, 2019
Polarize	Horizontal	Test Engineer	Jerry Chuang
Detector	Peak		

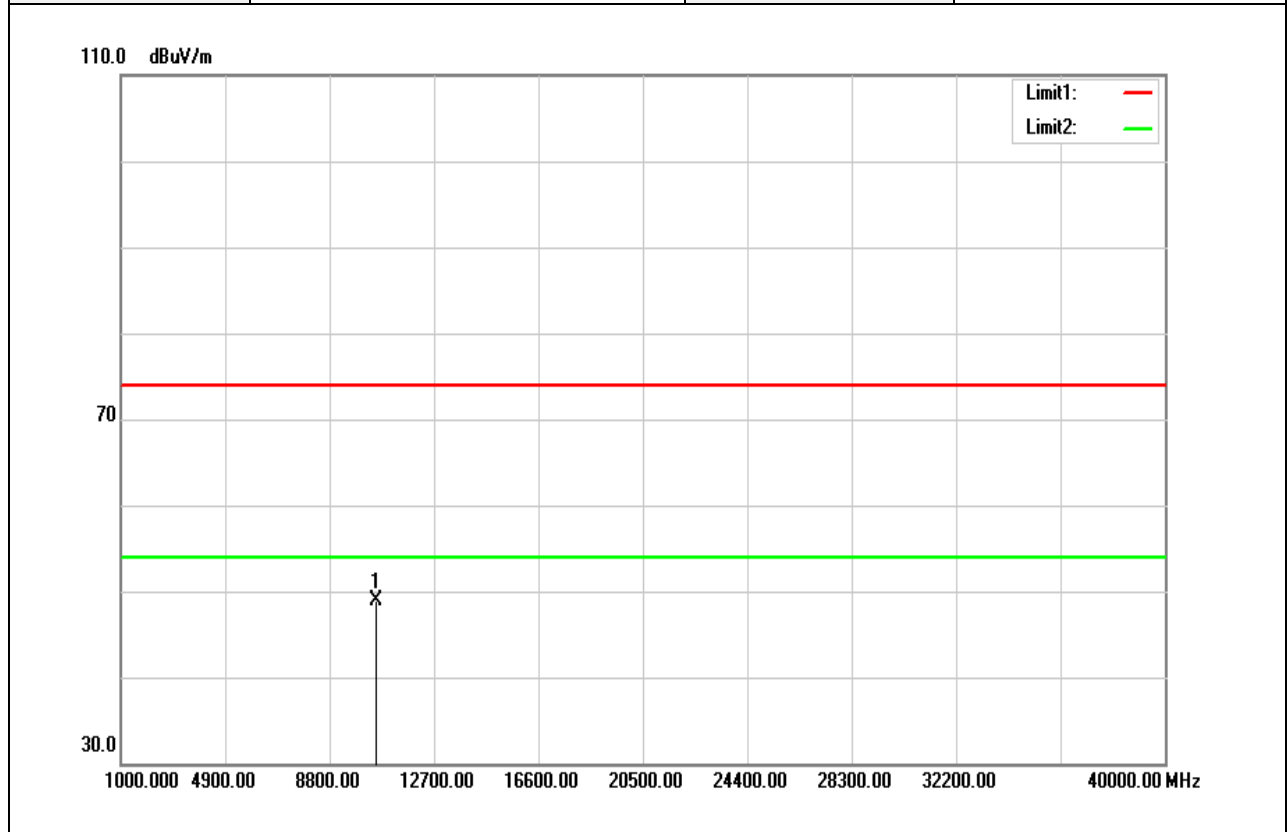

Frequency (MHz)	Reading (dBuV)	Correct Factor (dB/m)	Result (dBuV/m)	Limit (dBuV/m)	Margin (dB)	Remark
10520.000	33.73	15.11	48.84	74.00	-25.16	peak
N/A						

**Remark:**

- Measuring frequencies from 1 GHz to the 10th harmonic of highest fundamental frequency.
- For above 1GHz, the EUT peak value was under average limit, therefore the Average value compliance with the average limit

Test Mode	IEEE 802.11n HT20 / 5280 MHz	Temp/Hum	23.2(°C)/ 52%RH
Test Item	Harmonic	Test Date	February 15, 2019
Polarize	Vertical	Test Engineer	Jerry Chuang
Detector	Peak		

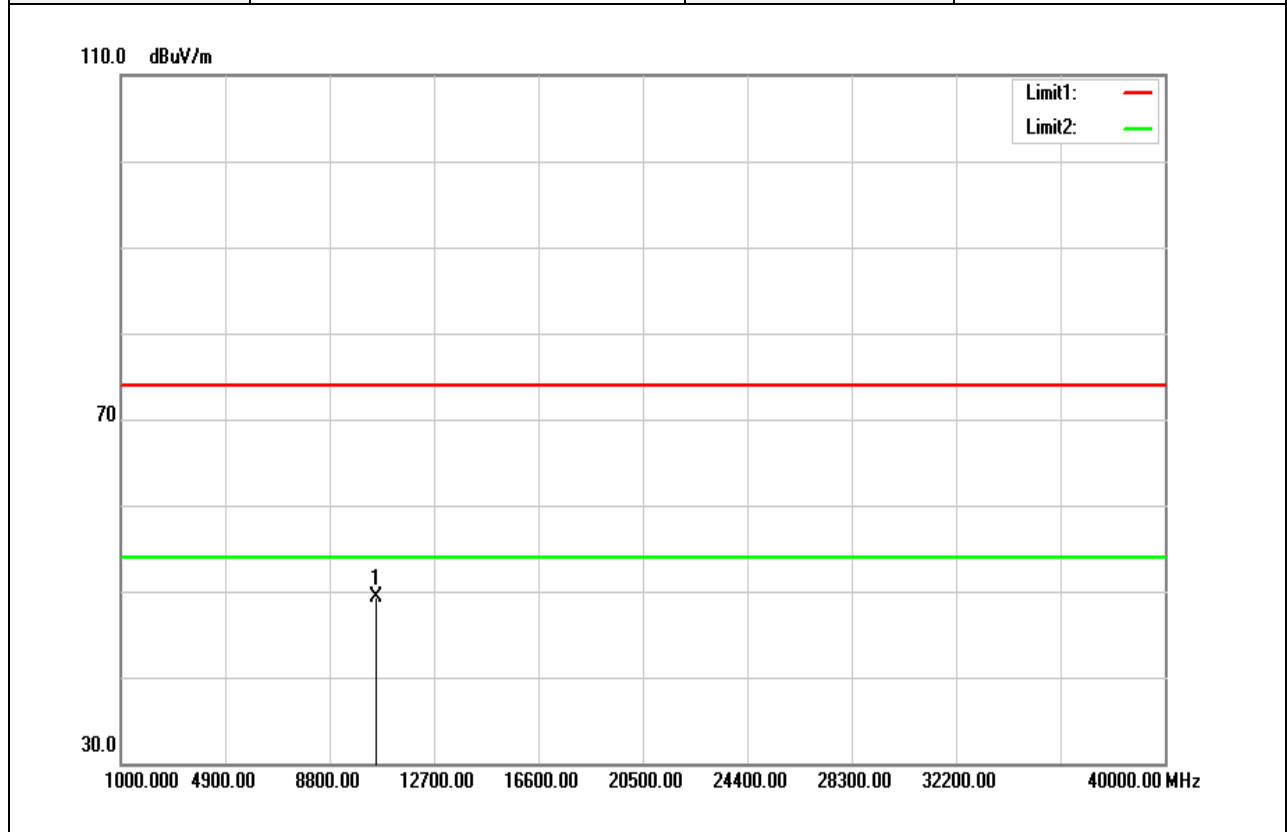

Frequency (MHz)	Reading (dBuV)	Correct Factor (dB/m)	Result (dBuV/m)	Limit (dBuV/m)	Margin (dB)	Remark
10560.000	34.19	15.13	49.32	74.00	-24.68	peak
N/A						

**Remark:**

- Measuring frequencies from 1 GHz to the 10th harmonic of highest fundamental frequency.
- For above 1GHz, the EUT peak value was under average limit, therefore the Average value compliance with the average limit

Test Mode	IEEE 802.11n HT20 / 5280 MHz	Temp/Hum	23.2(°C)/ 52%RH
Test Item	Harmonic	Test Date	February 15, 2019
Polarize	Horizontal	Test Engineer	Jerry Chuang
Detector	Peak		

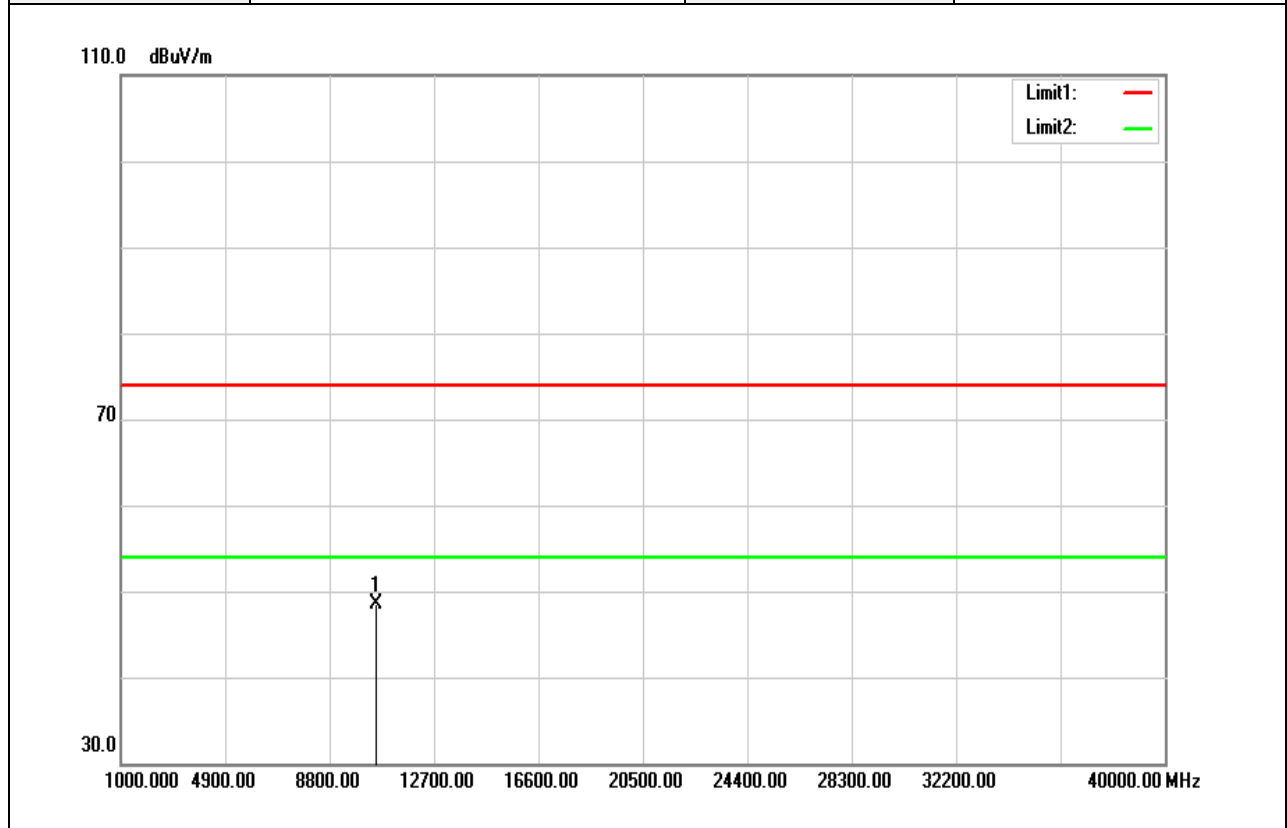

Frequency (MHz)	Reading (dBuV)	Correct Factor (dB/m)	Result (dBuV/m)	Limit (dBuV/m)	Margin (dB)	Remark
10560.000	33.39	15.13	48.52	74.00	-25.48	peak
N/A						

**Remark:**

1. Measuring frequencies from 1 GHz to the 10th harmonic of highest fundamental frequency.
2. For above 1GHz, the EUT peak value was under average limit, therefore the Average value compliance with the average limit



Test Mode	IEEE 802.11n HT20 / 5320 MHz	Temp/Hum	23.2(°C) / 52%RH
Test Item	Harmonic	Test Date	February 15, 2019
Polarize	Vertical	Test Engineer	Jerry Chuang
Detector	Peak		

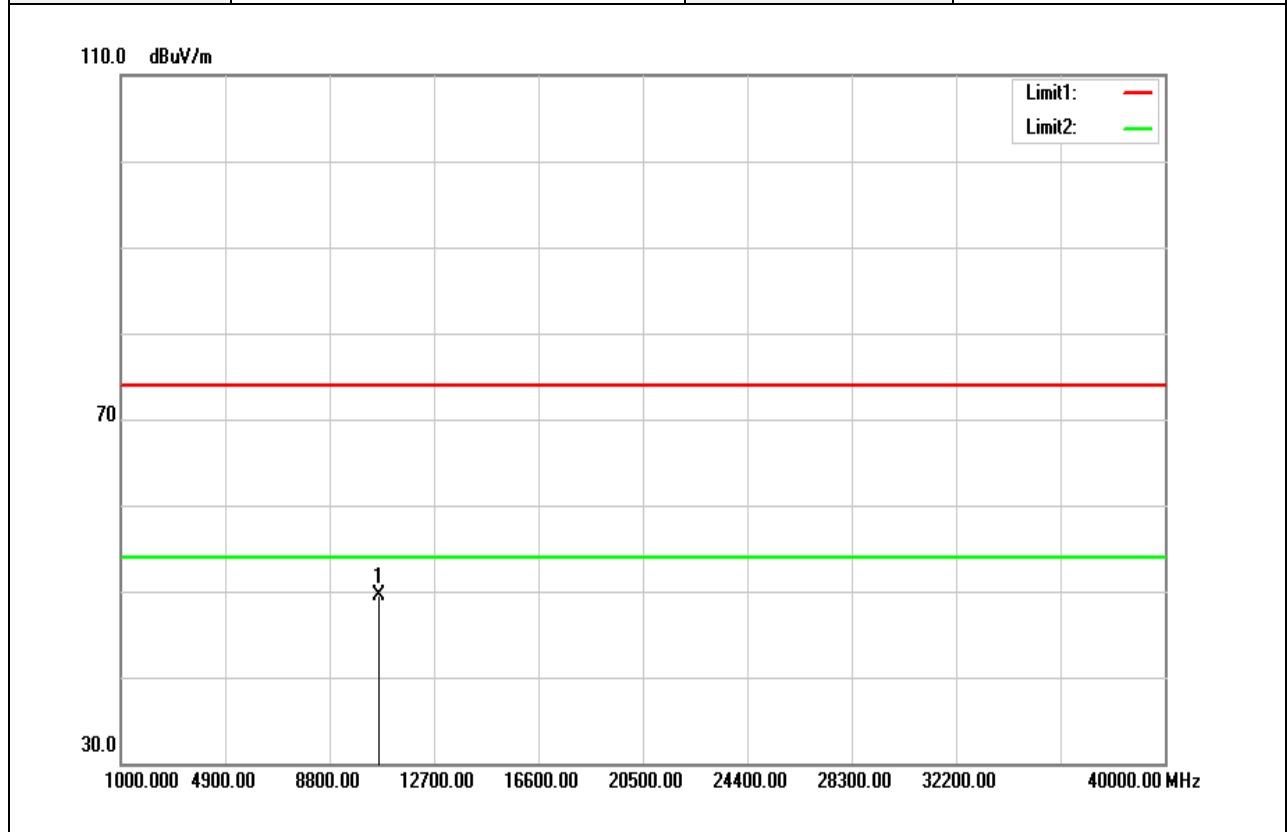

Frequency (MHz)	Reading (dBuV)	Correct Factor (dB/m)	Result (dBuV/m)	Limit (dBuV/m)	Margin (dB)	Remark
10640.000	34.26	15.22	49.48	74.00	-24.52	peak
N/A						

**Remark:**

- Measuring frequencies from 1 GHz to the 10th harmonic of highest fundamental frequency.
- For above 1GHz, the EUT peak value was under average limit, therefore the Average value compliance with the average limit

Test Mode	IEEE 802.11n HT20 / 5320 MHz	Temp/Hum	23.2(°C) / 52%RH
Test Item	Harmonic	Test Date	February 15, 2019
Polarize	Horizontal	Test Engineer	Jerry Chuang
Detector	Peak		

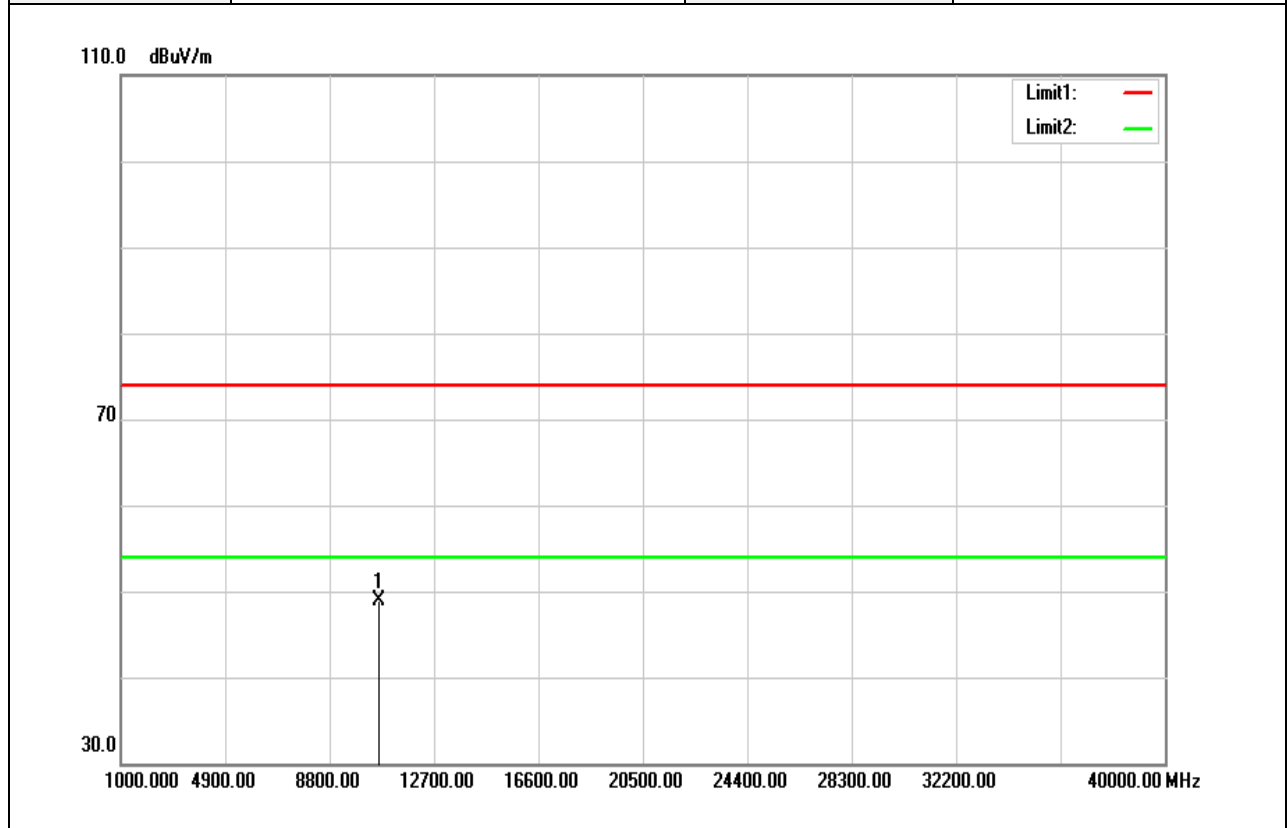

Frequency (MHz)	Reading (dBuV)	Correct Factor (dB/m)	Result (dBuV/m)	Limit (dBuV/m)	Margin (dB)	Remark
10640.000	33.77	15.22	48.99	74.00	-25.01	peak
N/A						

**Remark:**

- Measuring frequencies from 1 GHz to the 10th harmonic of highest fundamental frequency.
- For above 1GHz, the EUT peak value was under average limit, therefore the Average value compliance with the average limit

Test Mode	IEEE 802.11n HT40 / 5270 MHz	Temp/Hum	23.2(°C) / 52%RH
Test Item	Harmonic	Test Date	February 15, 2019
Polarize	Vertical	Test Engineer	Jerry Chuang
Detector	Peak		

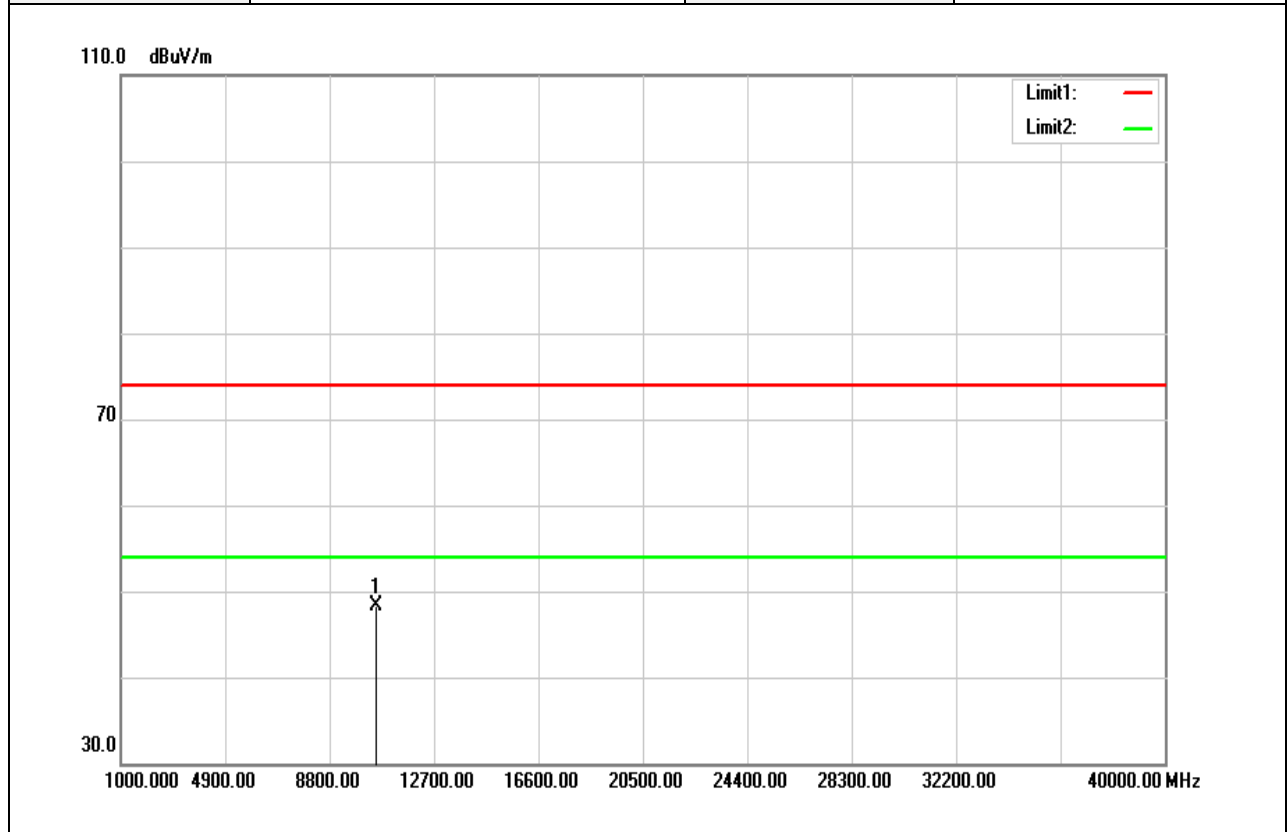

Frequency (MHz)	Reading (dBuV)	Correct Factor (dB/m)	Result (dBuV/m)	Limit (dBuV/m)	Margin (dB)	Remark
10540.000	33.18	15.12	48.30	74.00	-25.70	peak
N/A						

**Remark:**

- Measuring frequencies from 1 GHz to the 10th harmonic of highest fundamental frequency.
- For above 1GHz, the EUT peak value was under average limit, therefore the Average value compliance with the average limit

Test Mode	IEEE 802.11n HT40 / 5270 MHz	Temp/Hum	23.2(°C) / 52%RH
Test Item	Harmonic	Test Date	February 15, 2019
Polarize	Horizontal	Test Engineer	Jerry Chuang
Detector	Peak		

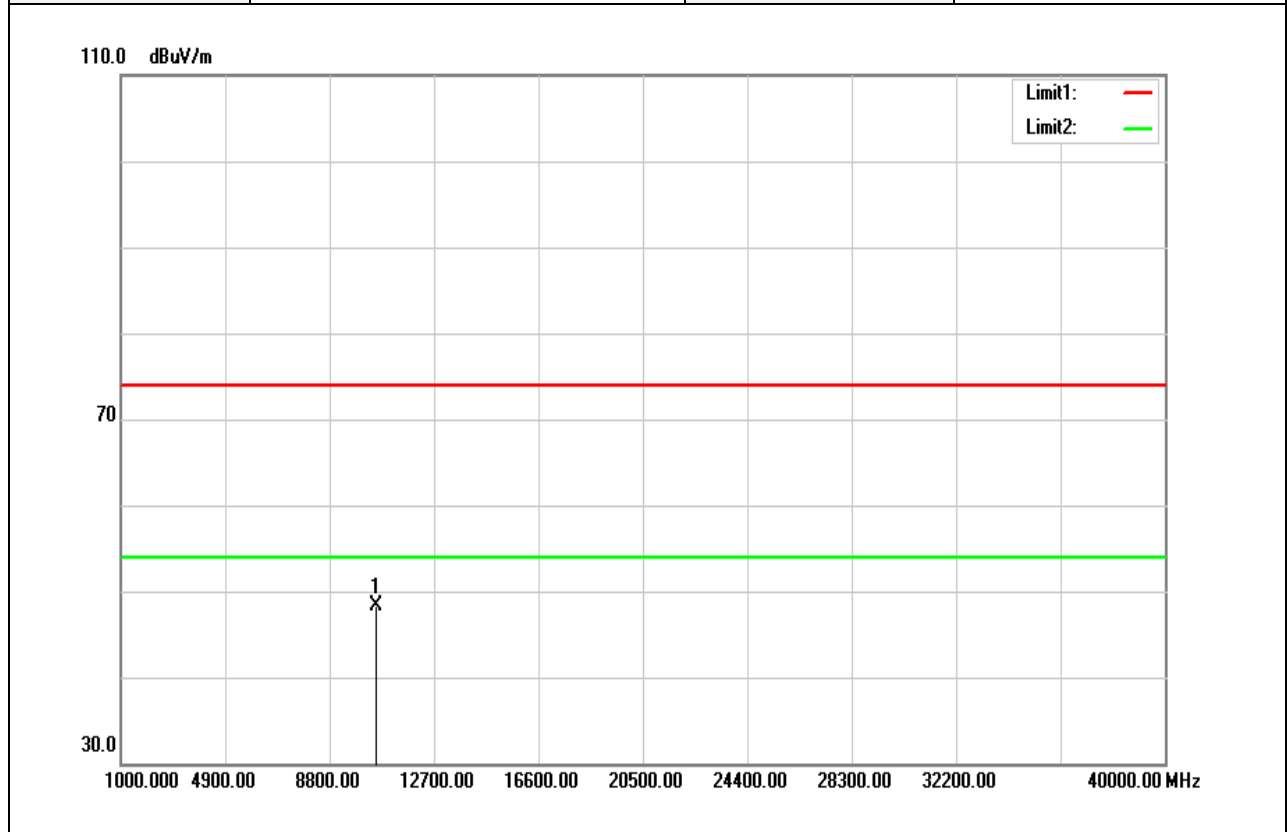

Frequency (MHz)	Reading (dBuV)	Correct Factor (dB/m)	Result (dBuV/m)	Limit (dBuV/m)	Margin (dB)	Remark
10540.000	33.19	15.12	48.31	74.00	-25.69	peak
N/A						

**Remark:**

- Measuring frequencies from 1 GHz to the 10th harmonic of highest fundamental frequency.
- For above 1GHz, the EUT peak value was under average limit, therefore the Average value compliance with the average limit

Test Mode	IEEE 802.11n HT40 / 5310 MHz	Temp/Hum	23.2(°C) / 52%RH
Test Item	Harmonic	Test Date	February 15, 2019
Polarize	Vertical	Test Engineer	Jerry Chuang
Detector	Peak		

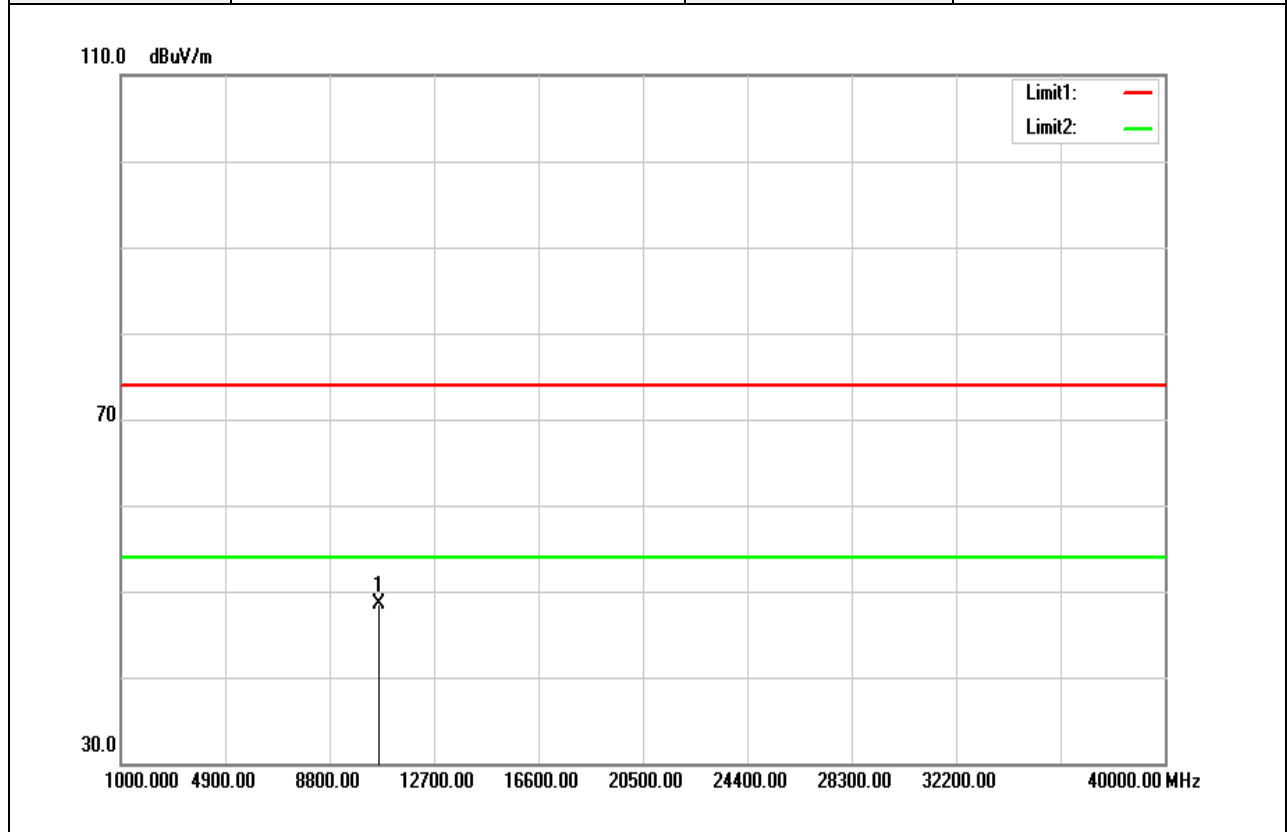

Frequency (MHz)	Reading (dBuV)	Correct Factor (dB/m)	Result (dBuV/m)	Limit (dBuV/m)	Margin (dB)	Remark
10620.000	33.29	15.19	48.48	74.00	-25.52	peak
N/A						

**Remark:**

- Measuring frequencies from 1 GHz to the 10th harmonic of highest fundamental frequency.
- For above 1GHz, the EUT peak value was under average limit, therefore the Average value compliance with the average limit

Test Mode	IEEE 802.11n HT40 / 5310 MHz	Temp/Hum	23.2(°C) / 52%RH
Test Item	Harmonic	Test Date	February 15, 2019
Polarize	Horizontal	Test Engineer	Jerry Chuang
Detector	Peak		

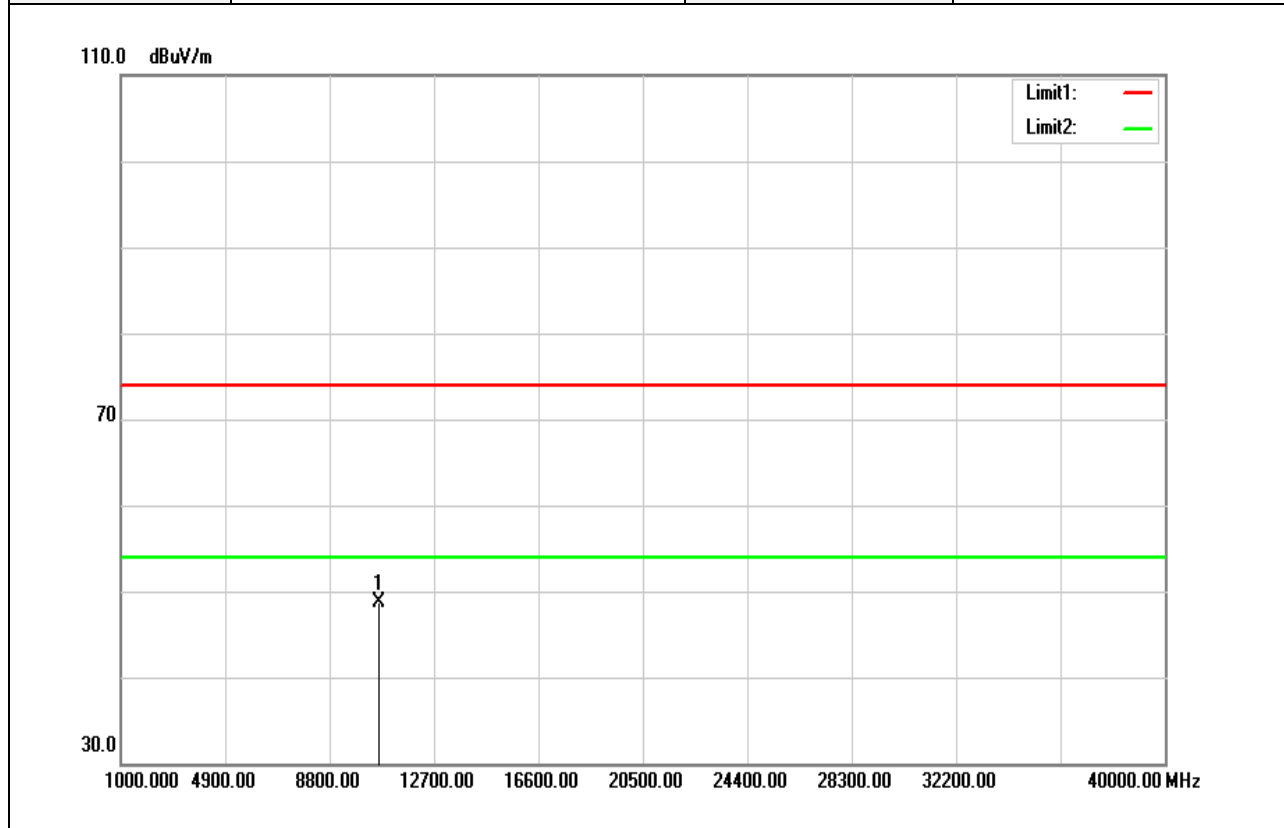

Frequency (MHz)	Reading (dBuV)	Correct Factor (dB/m)	Result (dBuV/m)	Limit (dBuV/m)	Margin (dB)	Remark
10620.000	33.58	15.19	48.77	74.00	-25.23	peak
N/A						

**Remark:**

1. Measuring frequencies from 1 GHz to the 10th harmonic of highest fundamental frequency.
2. For above 1GHz, the EUT peak value was under average limit, therefore the Average value compliance with the average limit

Test Mode	IEEE 802.11ac VHT80 / 5290 MHz	Temp/Hum	23.2(°C)/ 52%RH
Test Item	Harmonic	Test Date	February 15, 2019
Polarize	Vertical	Test Engineer	Jerry Chuang
Detector	Peak		

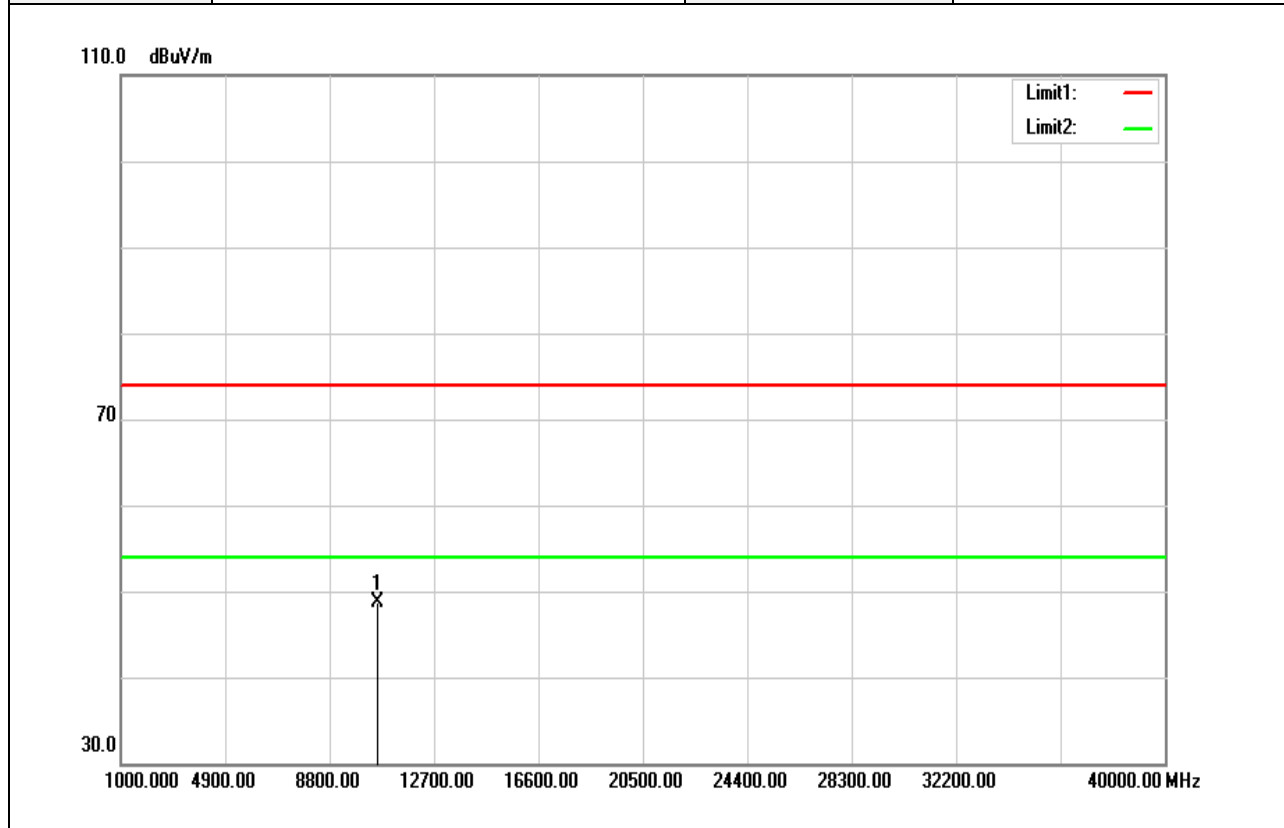

Frequency (MHz)	Reading (dBuV)	Correct Factor (dB/m)	Result (dBuV/m)	Limit (dBuV/m)	Margin (dB)	Remark
10580.000	33.65	15.14	48.79	74.00	-25.21	peak
N/A						

**Remark:**

1. Measuring frequencies from 1 GHz to the 10th harmonic of highest fundamental frequency.
2. For above 1GHz, the EUT peak value was under average limit, therefore the Average value compliance with the average limit

Test Mode	IEEE 802.11ac VHT80 / 5290 MHz	Temp/Hum	23.2(°C) / 52%RH
Test Item	Harmonic	Test Date	February 15, 2019
Polarize	Horizontal	Test Engineer	Jerry Chuang
Detector	Peak		

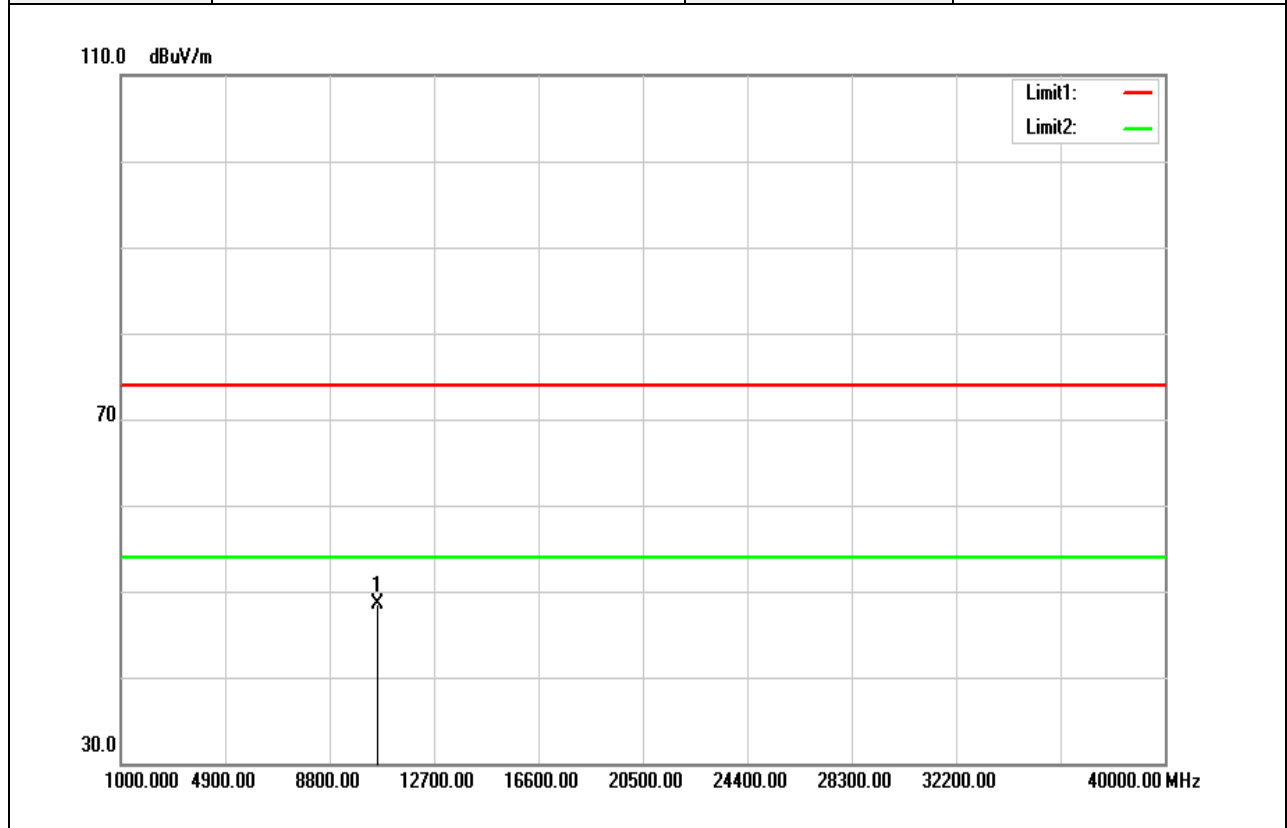

Frequency (MHz)	Reading (dBuV)	Correct Factor (dB/m)	Result (dBuV/m)	Limit (dBuV/m)	Margin (dB)	Remark
10580.000	33.32	15.14	48.46	74.00	-25.54	peak
N/A						

**Remark:**

1. Measuring frequencies from 1 GHz to the 10th harmonic of highest fundamental frequency.
2. For above 1GHz, the EUT peak value was under average limit, therefore the Average value compliance with the average limit



**Above 1G Test Data for UNII-2c**

Test Mode	IEEE 802.11a / 5500 MHz	Temp/Hum	23.2(°C) / 52%RH
Test Item	Harmonic	Test Date	February 15, 2019
Polarize	Vertical	Test Engineer	Jerry Chuang
Detector	Peak		

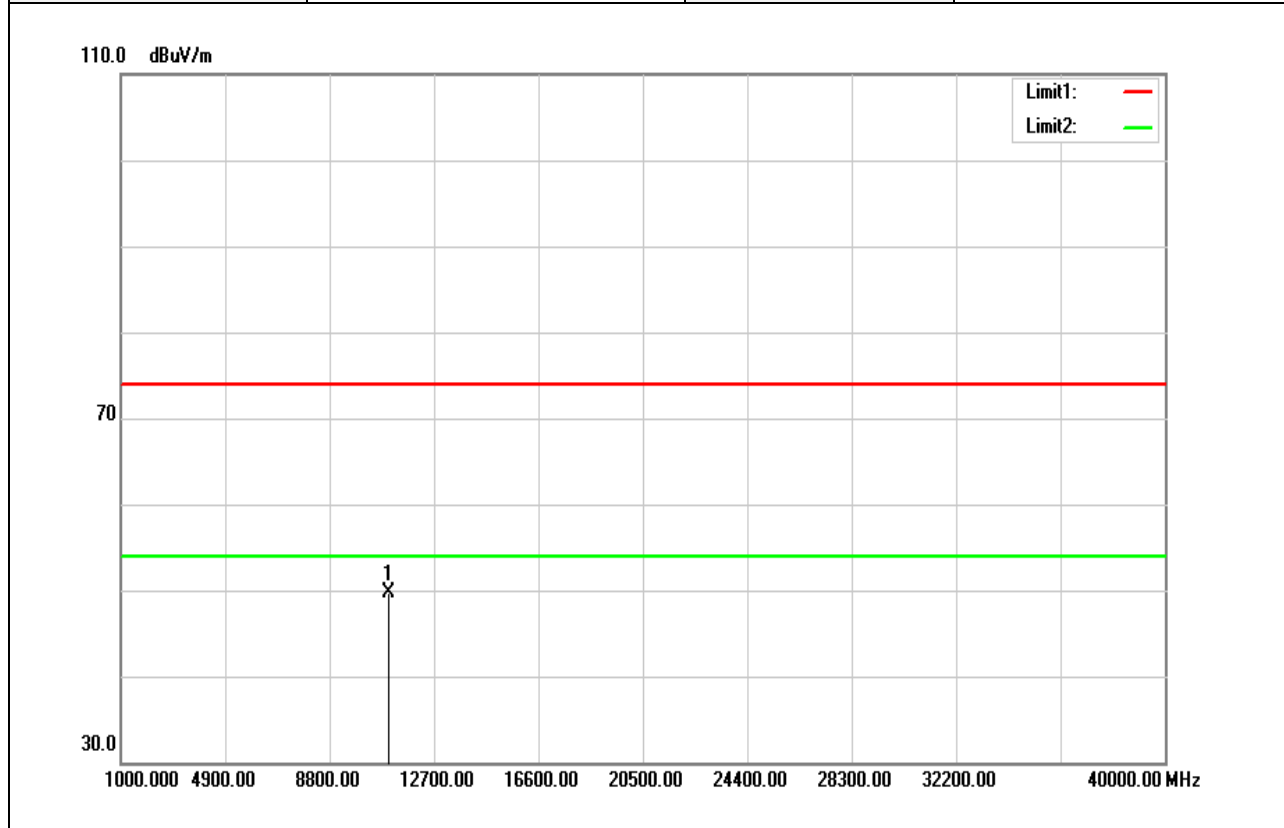

Frequency (MHz)	Reading (dBuV)	Correct Factor (dB/m)	Result (dBuV/m)	Limit (dBuV/m)	Margin (dB)	Remark
11000.000	33.96	15.68	49.64	74.00	-24.36	peak
N/A						

**Remark:**

- Measuring frequencies from 1 GHz to the 10th harmonic of highest fundamental frequency.
- For above 1GHz, the EUT peak value was under average limit, therefore the Average value compliance with the average limit

Test Mode	IEEE 802.11a / 5500 MHz	Temp/Hum	23.2(°C) / 52%RH
Test Item	Harmonic	Test Date	February 15, 2019
Polarize	Horizontal	Test Engineer	Jerry Chuang
Detector	Peak		

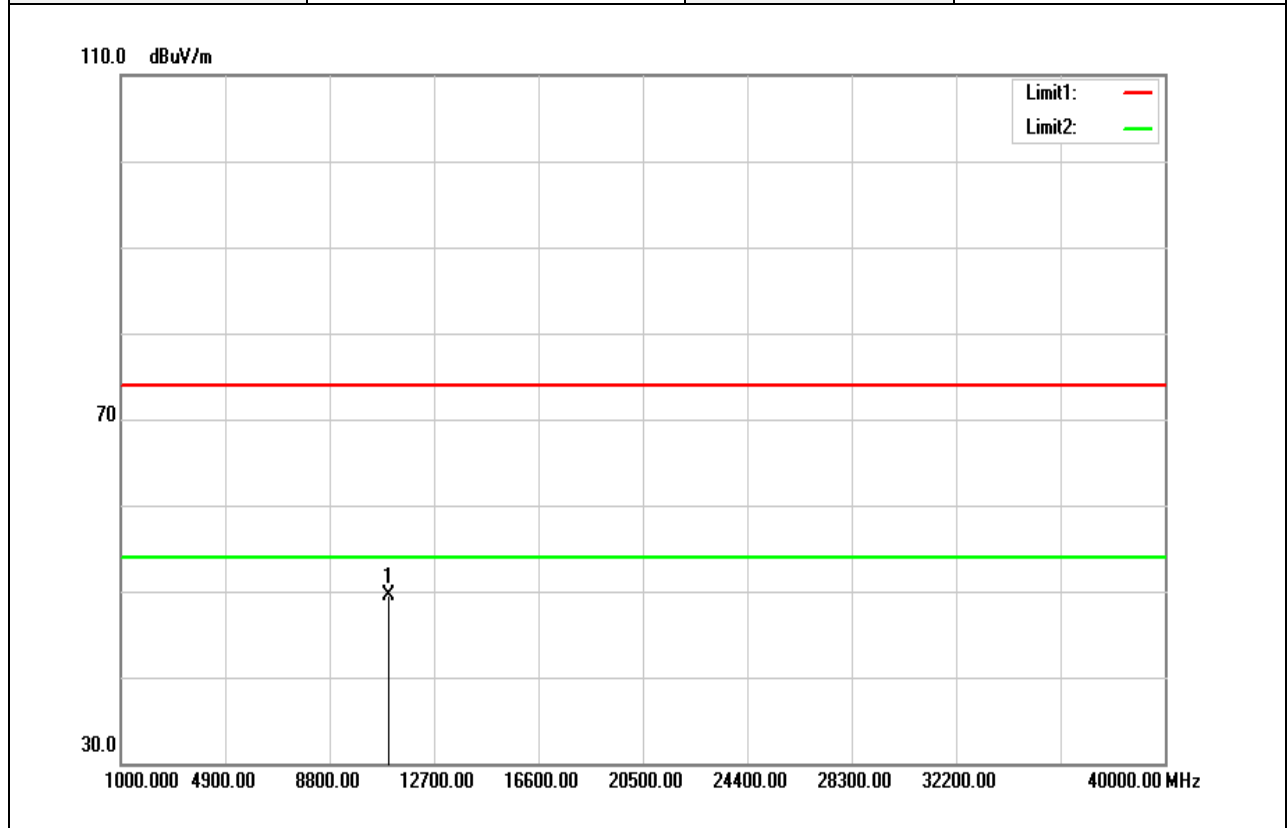

Frequency (MHz)	Reading (dBuV)	Correct Factor (dB/m)	Result (dBuV/m)	Limit (dBuV/m)	Margin (dB)	Remark
11000.000	33.92	15.68	49.60	74.00	-24.40	peak
N/A						

**Remark:**

- Measuring frequencies from 1 GHz to the 10th harmonic of highest fundamental frequency.
- For above 1GHz, the EUT peak value was under average limit, therefore the Average value compliance with the average limit

Test Mode	IEEE 802.11a / 5580 MHz	Temp/Hum	23.2(°C) / 52%RH
Test Item	Harmonic	Test Date	February 15, 2019
Polarize	Vertical	Test Engineer	Jerry Chuang
Detector	Peak		

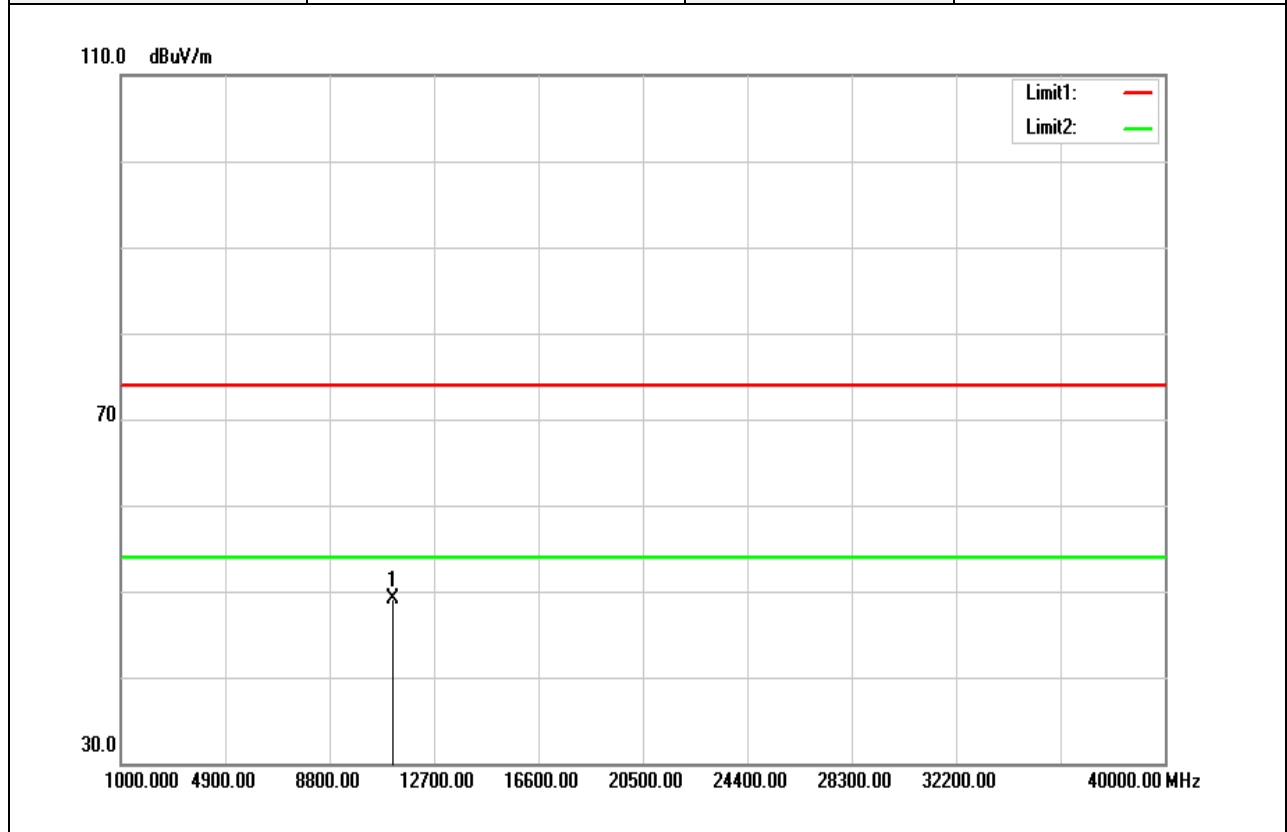

Frequency (MHz)	Reading (dBuV)	Correct Factor (dB/m)	Result (dBuV/m)	Limit (dBuV/m)	Margin (dB)	Remark
11160.000	33.42	15.77	49.19	74.00	-24.81	peak
N/A						

**Remark:**

- Measuring frequencies from 1 GHz to the 10th harmonic of highest fundamental frequency.
- For above 1GHz, the EUT peak value was under average limit, therefore the Average value compliance with the average limit

Test Mode	IEEE 802.11a / 5580 MHz	Temp/Hum	23.2(°C) / 52%RH
Test Item	Harmonic	Test Date	February 15, 2019
Polarize	Horizontal	Test Engineer	Jerry Chuang
Detector	Peak		

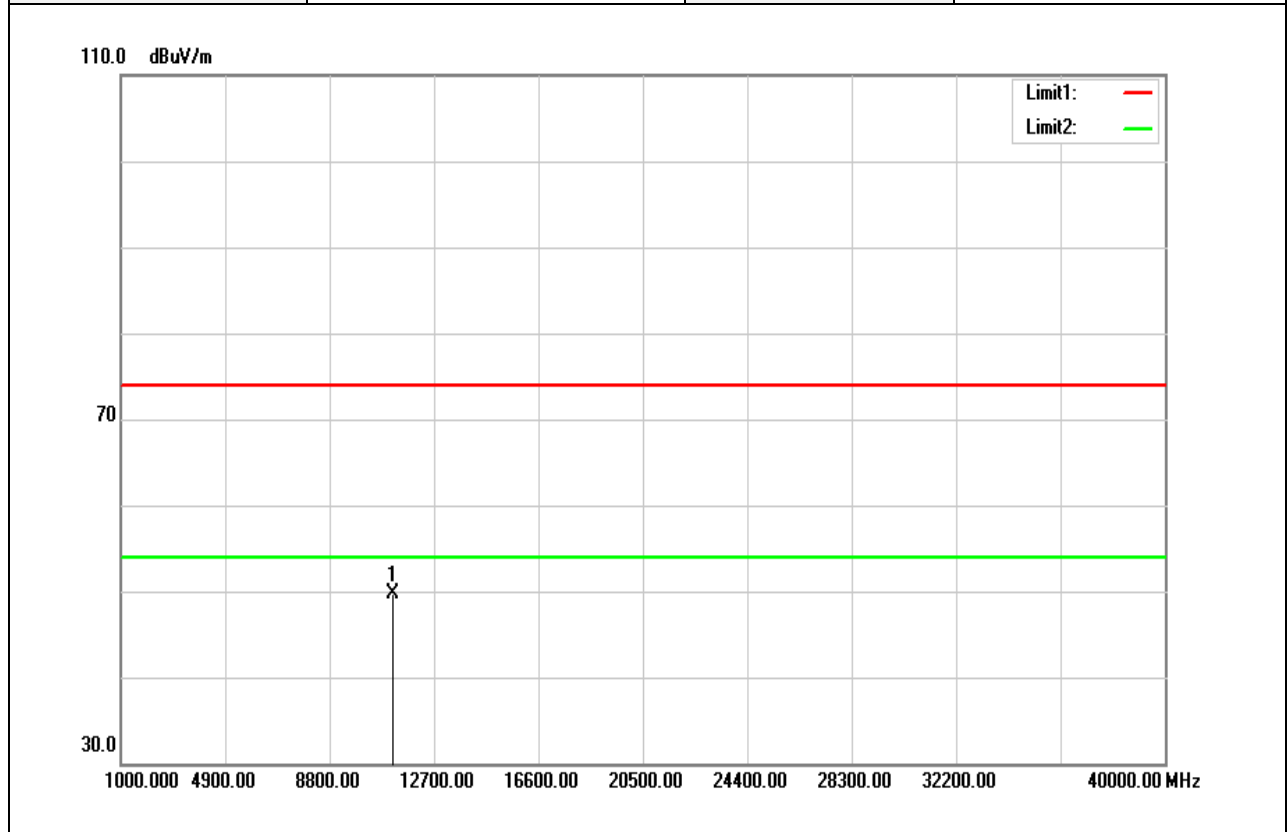

Frequency (MHz)	Reading (dBuV)	Correct Factor (dB/m)	Result (dBuV/m)	Limit (dBuV/m)	Margin (dB)	Remark
11160.000	33.94	15.77	49.71	74.00	-24.29	peak
N/A						

**Remark:**

- Measuring frequencies from 1 GHz to the 10th harmonic of highest fundamental frequency.
- For above 1GHz, the EUT peak value was under average limit, therefore the Average value compliance with the average limit

Test Mode	IEEE 802.11a / 5700 MHz	Temp/Hum	23.2(°C) / 52%RH
Test Item	Harmonic	Test Date	February 15, 2019
Polarize	Vertical	Test Engineer	Jerry Chuang
Detector	Peak		

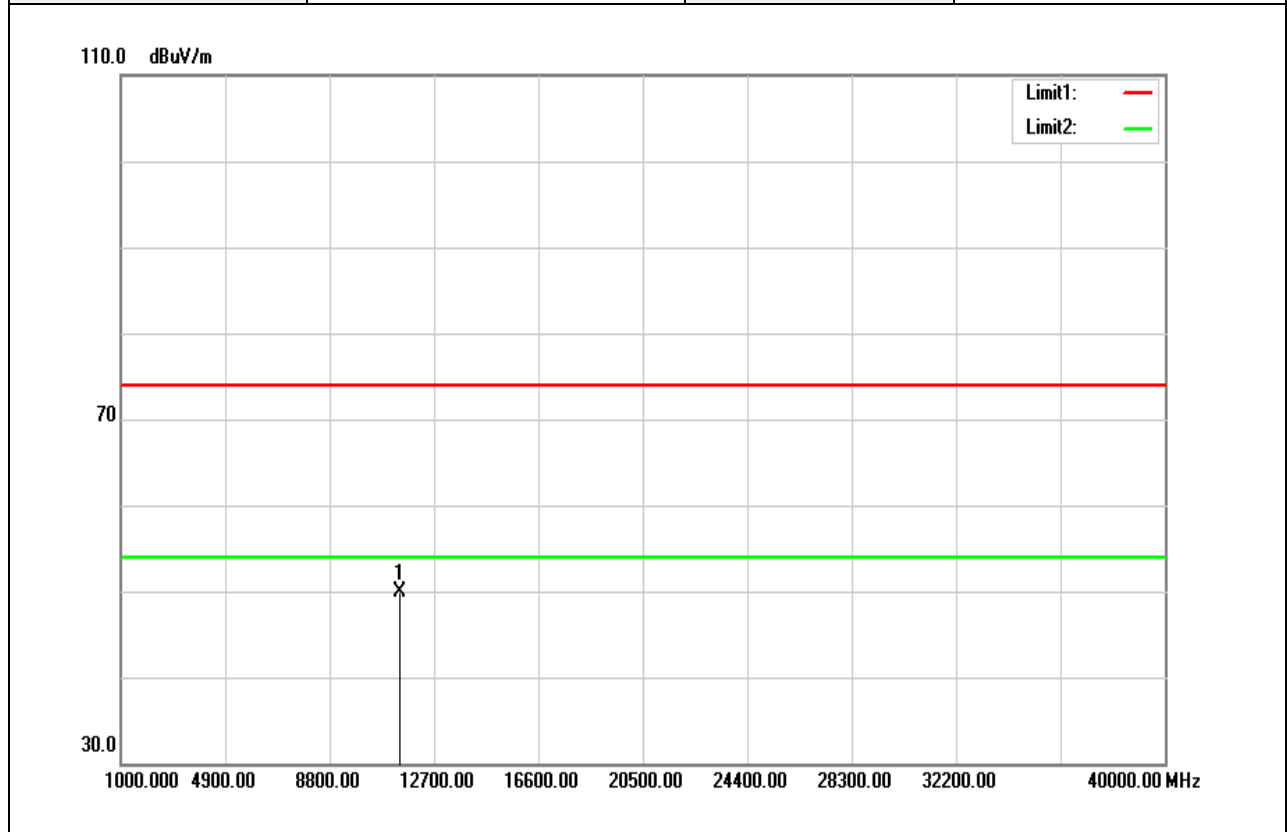

Frequency (MHz)	Reading (dBuV)	Correct Factor (dB/m)	Result (dBuV/m)	Limit (dBuV/m)	Margin (dB)	Remark
11400.000	34.31	15.62	49.93	74.00	-24.07	peak
N/A						

**Remark:**

- Measuring frequencies from 1 GHz to the 10th harmonic of highest fundamental frequency.
- For above 1GHz, the EUT peak value was under average limit, therefore the Average value compliance with the average limit

Test Mode	IEEE 802.11a / 5700 MHz	Temp/Hum	23.2(°C) / 52%RH
Test Item	Harmonic	Test Date	February 15, 2019
Polarize	Horizontal	Test Engineer	Jerry Chuang
Detector	Peak		

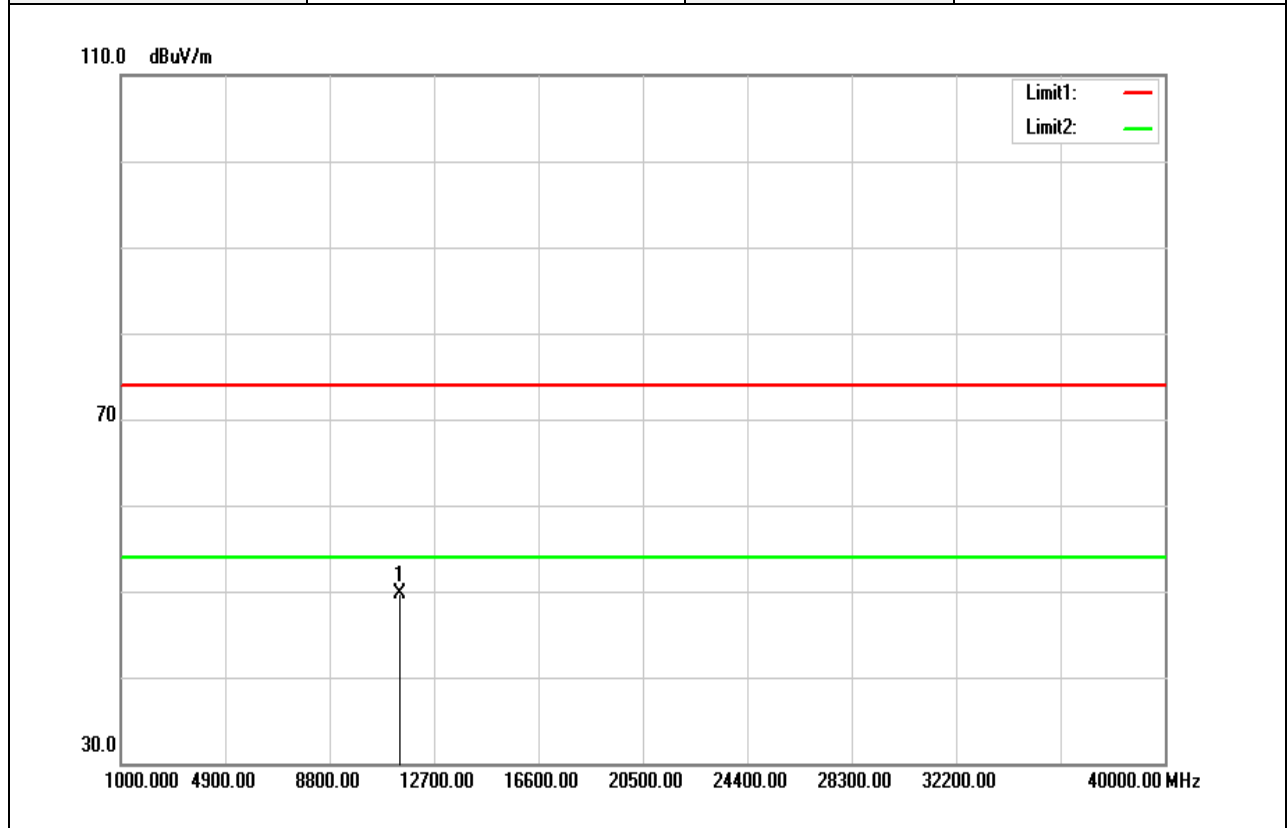

Frequency (MHz)	Reading (dBuV)	Correct Factor (dB/m)	Result (dBuV/m)	Limit (dBuV/m)	Margin (dB)	Remark
11400.000	34.09	15.62	49.71	74.00	-24.29	peak
N/A						

**Remark:**

1. Measuring frequencies from 1 GHz to the 10th harmonic of highest fundamental frequency.
2. For above 1GHz, the EUT peak value was under average limit, therefore the Average value compliance with the average limit

Test Mode	IEEE 802.11n HT20 / 5500 MHz	Temp/Hum	23.2(°C) / 52%RH
Test Item	Harmonic	Test Date	February 15, 2019
Polarize	Vertical	Test Engineer	Jerry Chuang
Detector	Peak		

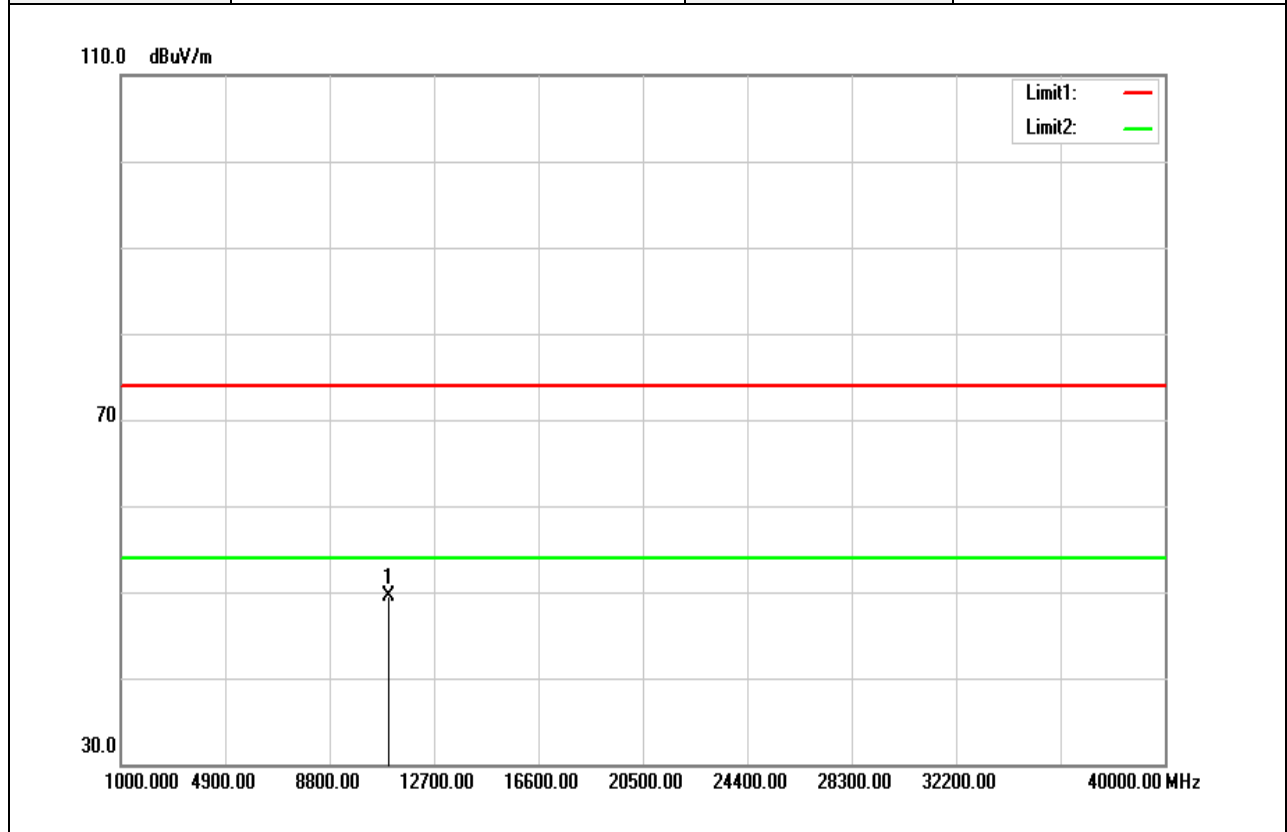

Frequency (MHz)	Reading (dBuV)	Correct Factor (dB/m)	Result (dBuV/m)	Limit (dBuV/m)	Margin (dB)	Remark
11000.000	33.92	15.68	49.60	74.00	-24.40	peak
N/A						

**Remark:**

- Measuring frequencies from 1 GHz to the 10th harmonic of highest fundamental frequency.
- For above 1GHz, the EUT peak value was under average limit, therefore the Average value compliance with the average limit

Test Mode	IEEE 802.11n HT20 / 5500 MHz	Temp/Hum	23.2(°C) / 52%RH
Test Item	Harmonic	Test Date	February 15, 2019
Polarize	Horizontal	Test Engineer	Jerry Chuang
Detector	Peak		

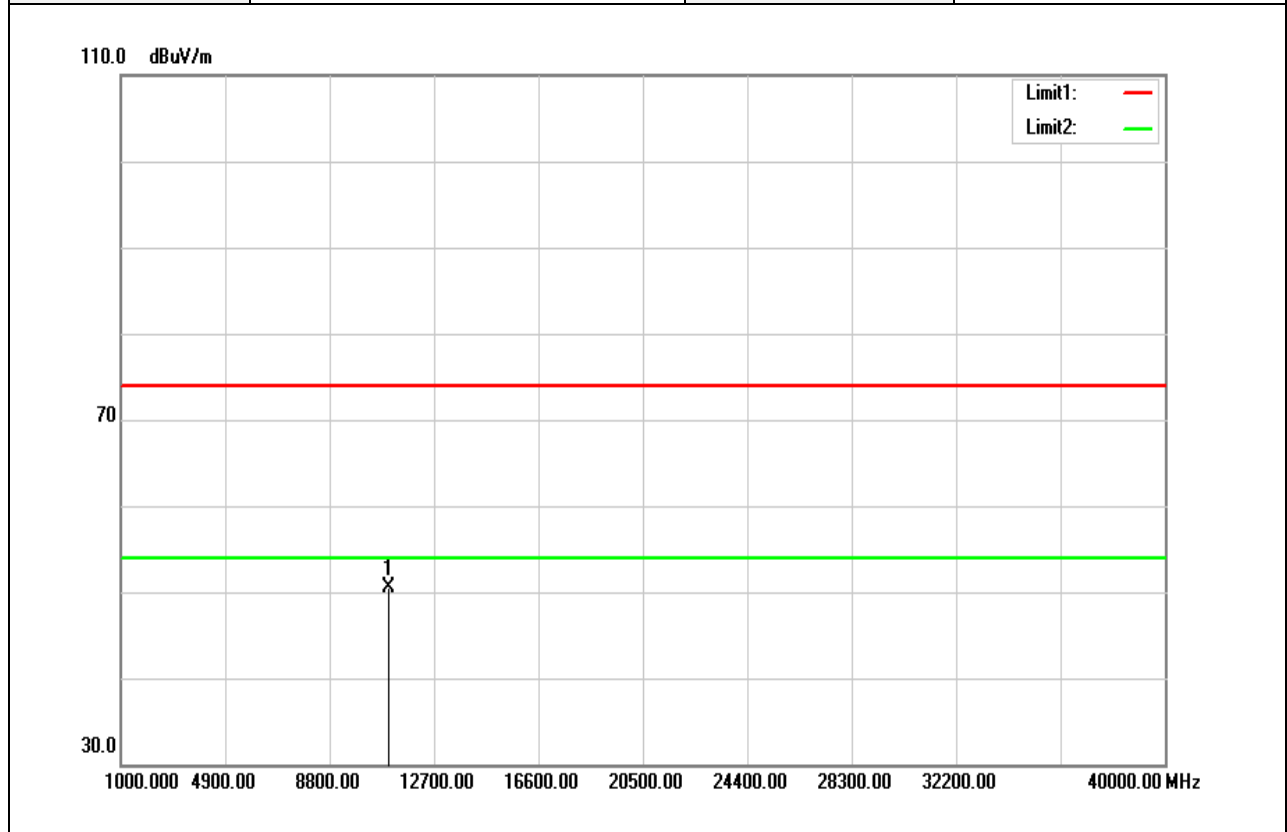

Frequency (MHz)	Reading (dBuV)	Correct Factor (dB/m)	Result (dBuV/m)	Limit (dBuV/m)	Margin (dB)	Remark
11000.000	34.73	15.68	50.41	74.00	-23.59	peak
N/A						

**Remark:**

- Measuring frequencies from 1 GHz to the 10th harmonic of highest fundamental frequency.
- For above 1GHz, the EUT peak value was under average limit, therefore the Average value compliance with the average limit



Test Mode	IEEE 802.11n HT20 / 5580 MHz	Temp/Hum	23.2(°C)/ 52%RH
Test Item	Harmonic	Test Date	February 15, 2019
Polarize	Vertical	Test Engineer	Jerry Chuang
Detector	Peak		

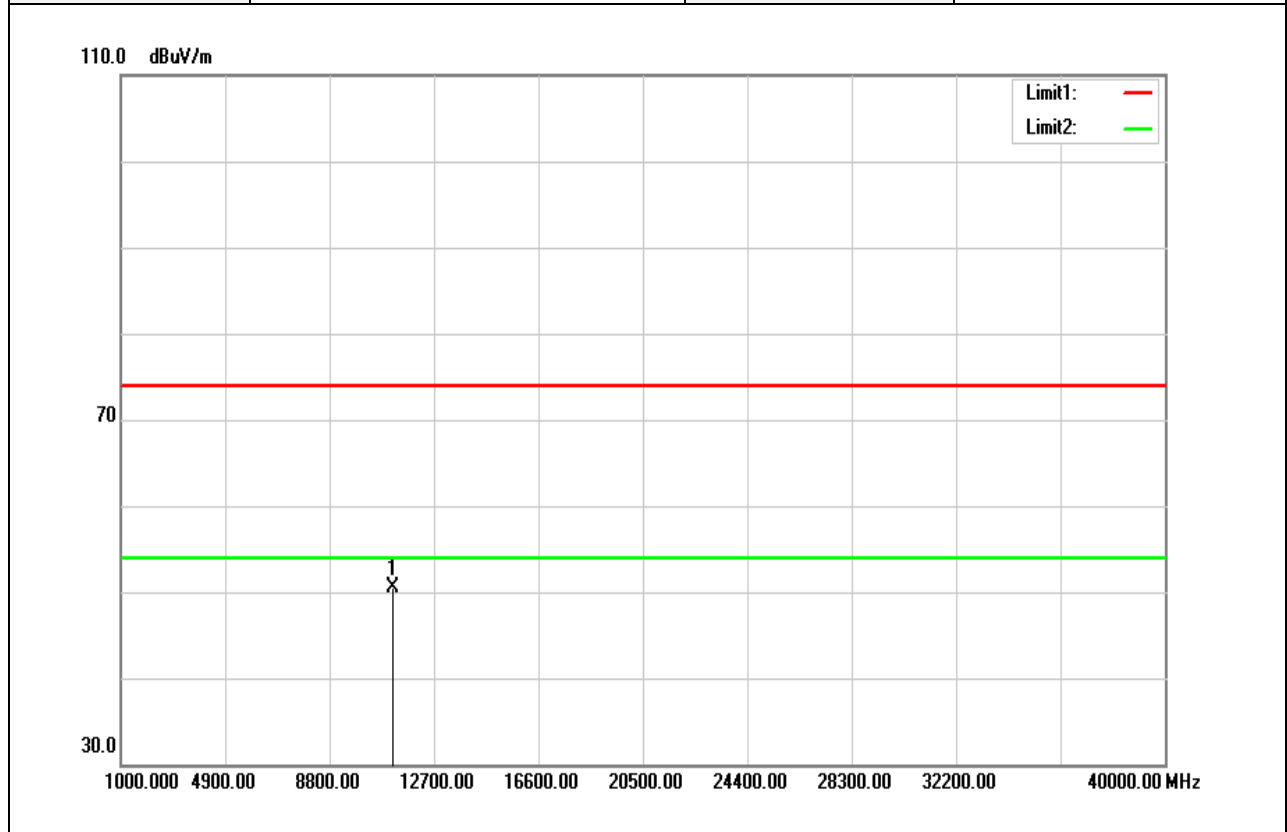

Frequency (MHz)	Reading (dBuV)	Correct Factor (dB/m)	Result (dBuV/m)	Limit (dBuV/m)	Margin (dB)	Remark
11160.000	34.66	15.77	50.43	74.00	-23.57	peak
N/A						

**Remark:**

- Measuring frequencies from 1 GHz to the 10th harmonic of highest fundamental frequency.
- For above 1GHz, the EUT peak value was under average limit, therefore the Average value compliance with the average limit

Test Mode	IEEE 802.11n HT20 / 5580 MHz	Temp/Hum	23.2(°C) / 52%RH
Test Item	Harmonic	Test Date	February 15, 2019
Polarize	Horizontal	Test Engineer	Jerry Chuang
Detector	Peak		

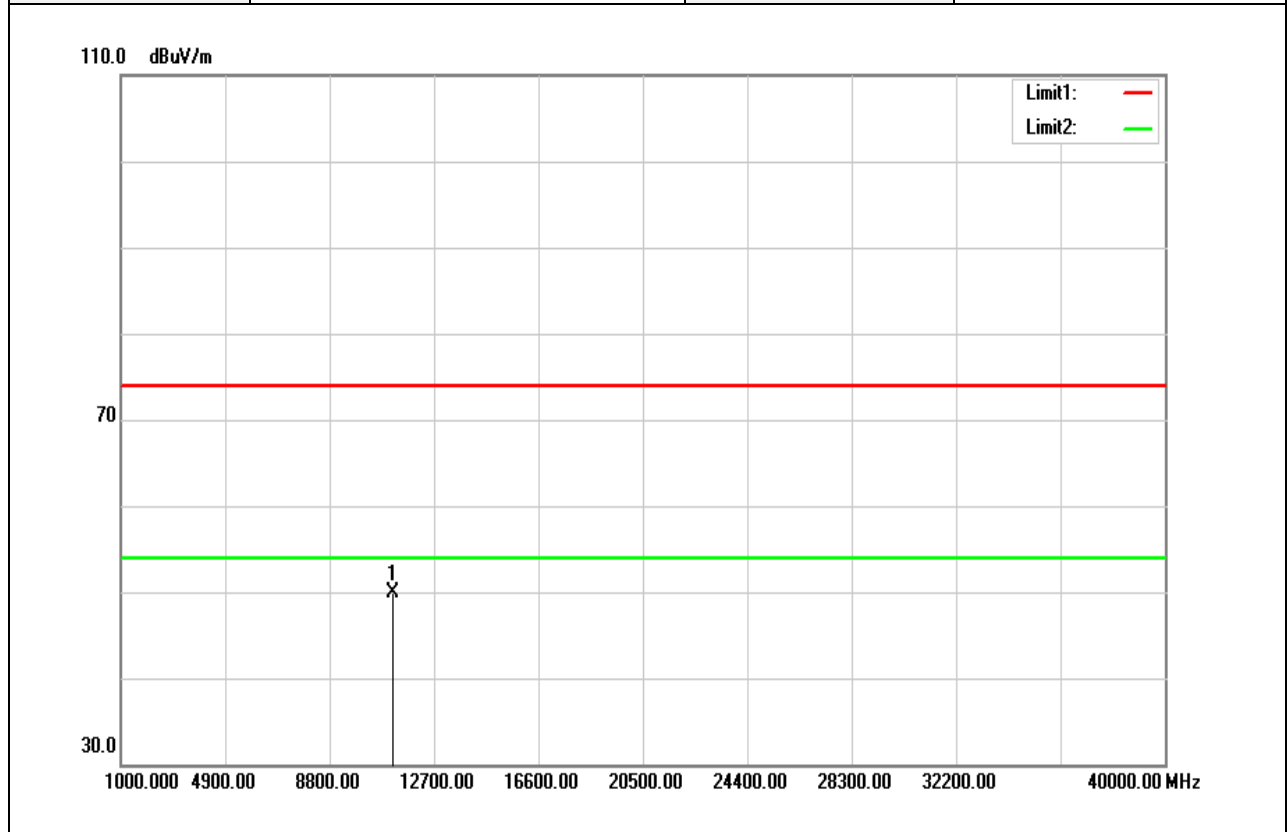

Frequency (MHz)	Reading (dBuV)	Correct Factor (dB/m)	Result (dBuV/m)	Limit (dBuV/m)	Margin (dB)	Remark
11160.000	34.14	15.77	49.91	74.00	-24.09	peak
N/A						

**Remark:**

- Measuring frequencies from 1 GHz to the 10th harmonic of highest fundamental frequency.
- For above 1GHz, the EUT peak value was under average limit, therefore the Average value compliance with the average limit

Test Mode	IEEE 802.11n HT20 / 5700 MHz	Temp/Hum	23.2(°C) / 52%RH
Test Item	Harmonic	Test Date	February 15, 2019
Polarize	Vertical	Test Engineer	Jerry Chuang
Detector	Peak		

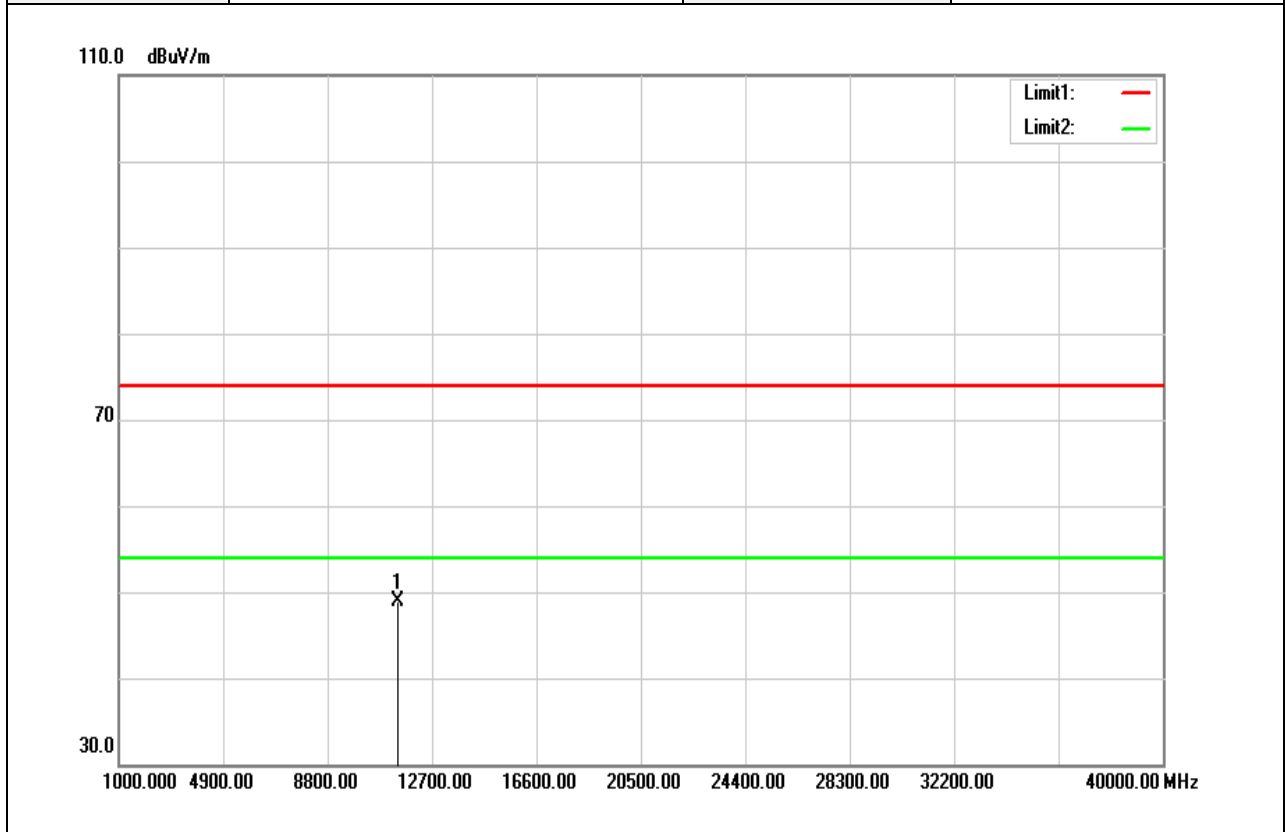

Frequency (MHz)	Reading (dBuV)	Correct Factor (dB/m)	Result (dBuV/m)	Limit (dBuV/m)	Margin (dB)	Remark
11400.000	33.24	15.62	48.86	74.00	-25.14	peak
N/A						

**Remark:**

- Measuring frequencies from 1 GHz to the 10th harmonic of highest fundamental frequency.
- For above 1GHz, the EUT peak value was under average limit, therefore the Average value compliance with the average limit

Test Mode	IEEE 802.11n HT20 / 5700 MHz	Temp/Hum	23.2(°C) / 52%RH
Test Item	Harmonic	Test Date	February 15, 2019
Polarize	Horizontal	Test Engineer	Jerry Chuang
Detector	Peak		

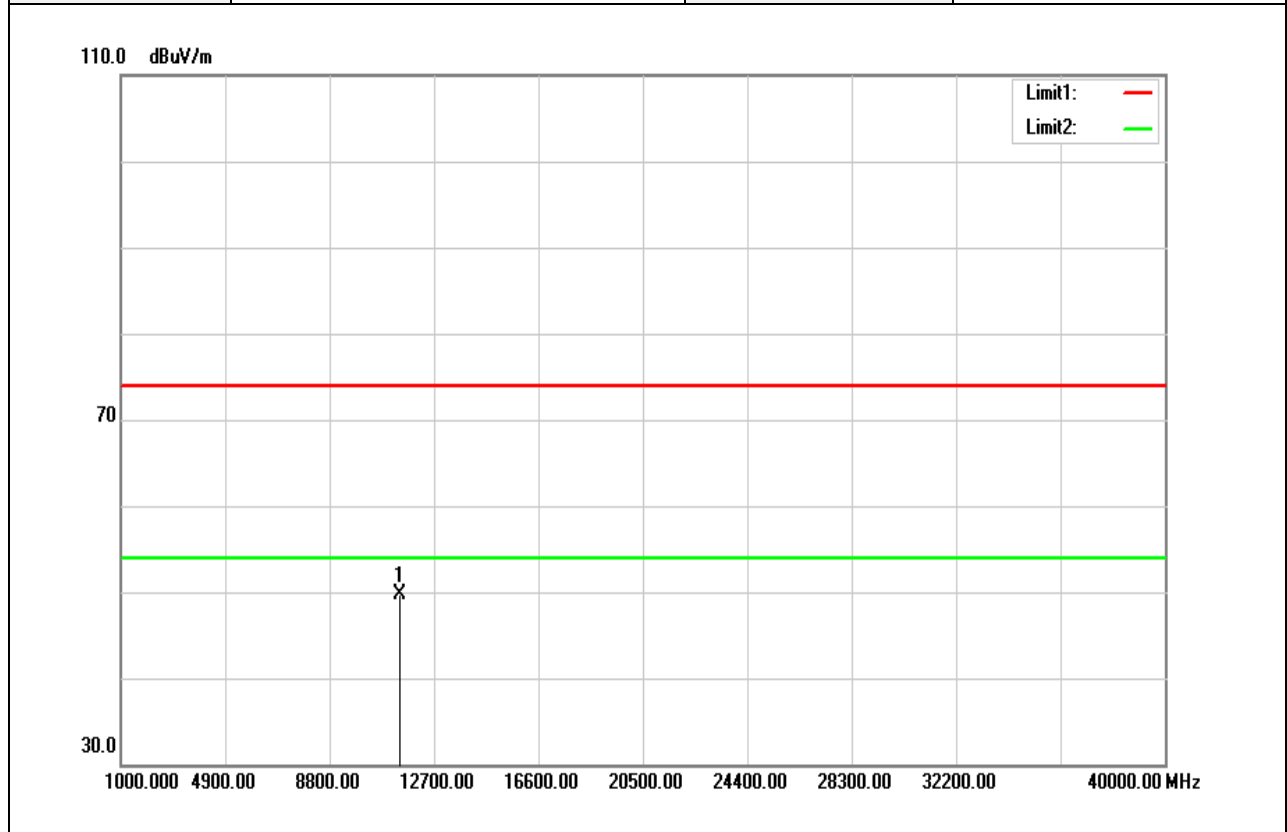

Frequency (MHz)	Reading (dBuV)	Correct Factor (dB/m)	Result (dBuV/m)	Limit (dBuV/m)	Margin (dB)	Remark
11400.000	34.18	15.62	49.80	74.00	-24.20	peak
N/A						

**Remark:**

- Measuring frequencies from 1 GHz to the 10th harmonic of highest fundamental frequency.
- For above 1GHz, the EUT peak value was under average limit, therefore the Average value compliance with the average limit

Test Mode	IEEE 802.11n HT40 / 5510 MHz	Temp/Hum	23.2(°C)/ 52%RH
Test Item	Harmonic	Test Date	February 15, 2019
Polarize	Vertical	Test Engineer	Jerry Chuang
Detector	Peak		

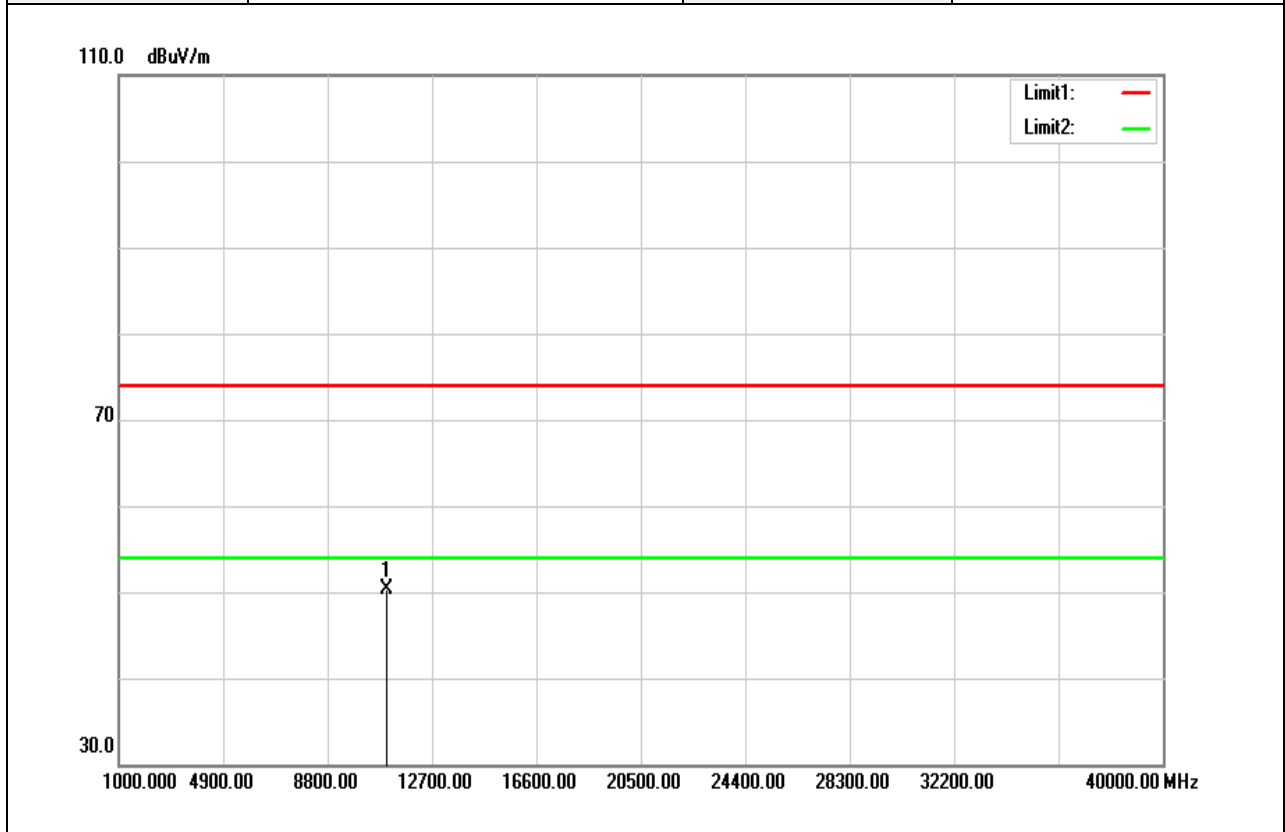

Frequency (MHz)	Reading (dBuV)	Correct Factor (dB/m)	Result (dBuV/m)	Limit (dBuV/m)	Margin (dB)	Remark
11020.000	34.55	15.70	50.25	74.00	-23.75	peak
N/A						

**Remark:**

1. Measuring frequencies from 1 GHz to the 10th harmonic of highest fundamental frequency.
2. For above 1GHz, the EUT peak value was under average limit, therefore the Average value compliance with the average limit

Test Mode	IEEE 802.11n HT40 / 5510 MHz	Temp/Hum	23.2(°C)/ 52%RH
Test Item	Harmonic	Test Date	February 15, 2019
Polarize	Horizontal	Test Engineer	Jerry Chuang
Detector	Peak		

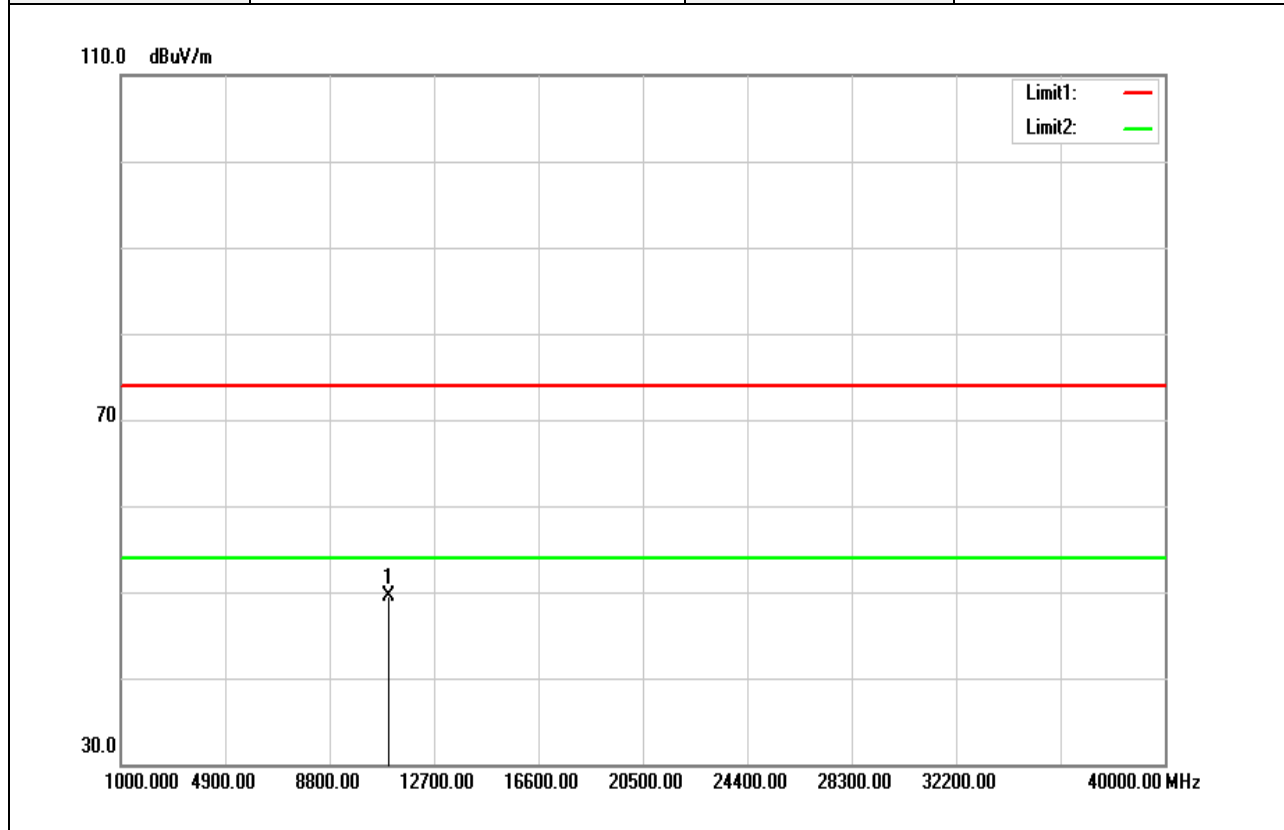

Frequency (MHz)	Reading (dBuV)	Correct Factor (dB/m)	Result (dBuV/m)	Limit (dBuV/m)	Margin (dB)	Remark
11020.000	33.75	15.70	49.45	74.00	-24.55	peak
N/A						

**Remark:**

1. Measuring frequencies from 1 GHz to the 10th harmonic of highest fundamental frequency.
2. For above 1GHz, the EUT peak value was under average limit, therefore the Average value compliance with the average limit

Test Mode	IEEE 802.11n HT40 / 5670 MHz	Temp/Hum	23.2(°C) / 52%RH
Test Item	Harmonic	Test Date	February 15, 2019
Polarize	Vertical	Test Engineer	Jerry Chuang
Detector	Peak		

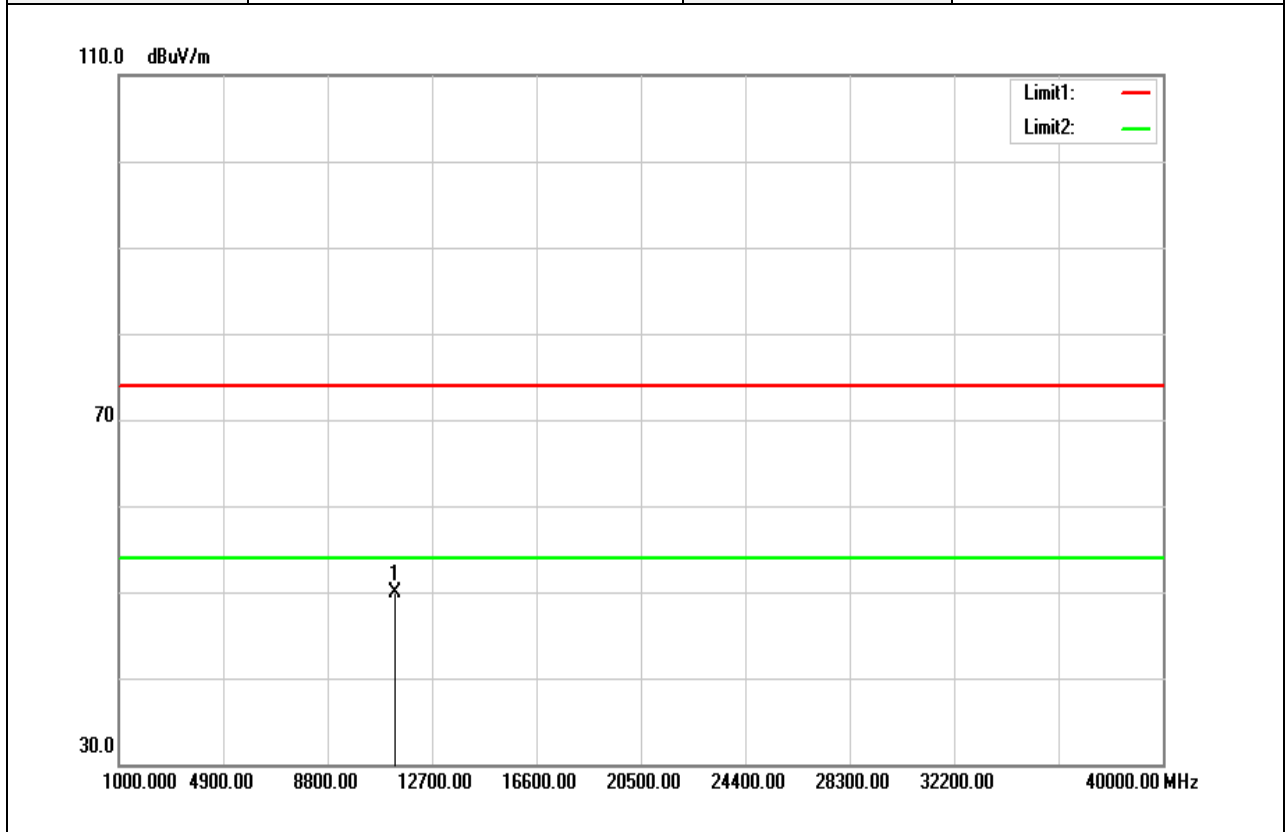

Frequency (MHz)	Reading (dBuV)	Correct Factor (dB/m)	Result (dBuV/m)	Limit (dBuV/m)	Margin (dB)	Remark
11340.000	34.19	15.68	49.87	74.00	-24.13	peak
N/A						

**Remark:**

- Measuring frequencies from 1 GHz to the 10th harmonic of highest fundamental frequency.
- For above 1GHz, the EUT peak value was under average limit, therefore the Average value compliance with the average limit

Test Mode	IEEE 802.11n HT40 / 5670 MHz	Temp/Hum	23.2(°C) / 52%RH
Test Item	Harmonic	Test Date	February 15, 2019
Polarize	Horizontal	Test Engineer	Jerry Chuang
Detector	Peak		

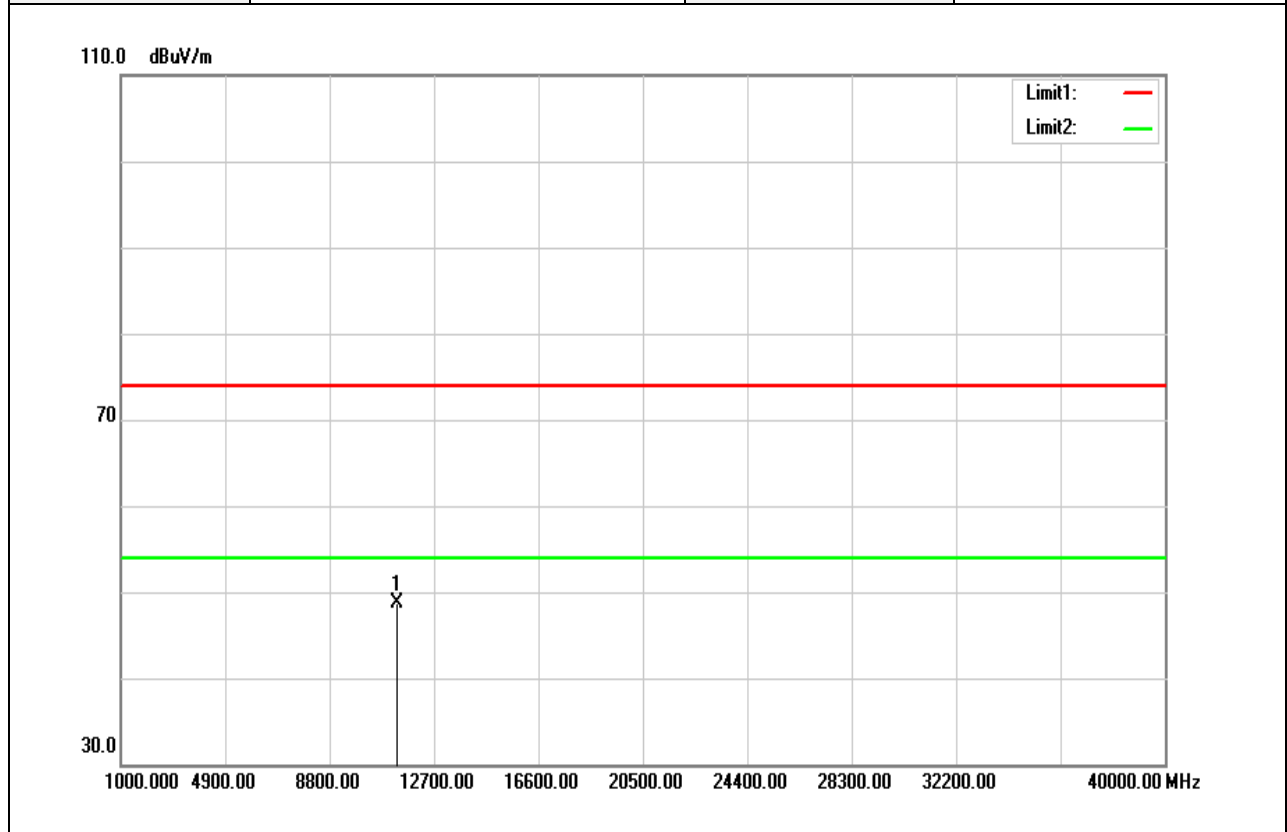

Frequency (MHz)	Reading (dBuV)	Correct Factor (dB/m)	Result (dBuV/m)	Limit (dBuV/m)	Margin (dB)	Remark
11340.000	33.03	15.68	48.71	74.00	-25.29	peak
N/A						

**Remark:**

1. Measuring frequencies from 1 GHz to the 10th harmonic of highest fundamental frequency.
2. For above 1GHz, the EUT peak value was under average limit, therefore the Average value compliance with the average limit



Test Mode	IEEE 802.11ac VHT80 / 5530 MHz	Temp/Hum	23.2(°C)/ 52%RH
Test Item	Harmonic	Test Date	February 15, 2019
Polarize	Vertical	Test Engineer	Jerry Chuang
Detector	Peak		

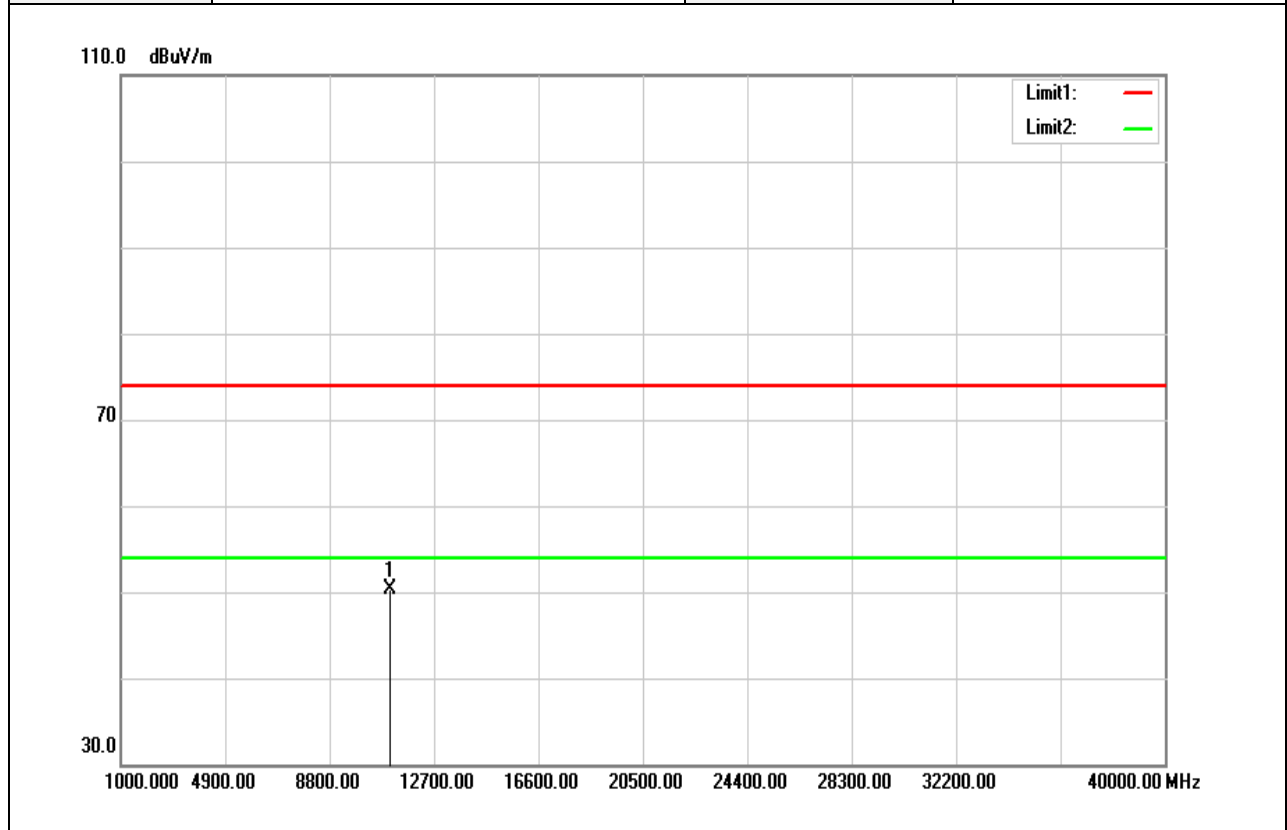

Frequency (MHz)	Reading (dBuV)	Correct Factor (dB/m)	Result (dBuV/m)	Limit (dBuV/m)	Margin (dB)	Remark
11060.000	34.50	15.72	50.22	74.00	-23.78	peak
N/A						

**Remark:**

- Measuring frequencies from 1 GHz to the 10th harmonic of highest fundamental frequency.
- For above 1GHz, the EUT peak value was under average limit, therefore the Average value compliance with the average limit

Test Mode	IEEE 802.11ac VHT80 / 5530 MHz	Temp/Hum	23.2(°C)/ 52%RH
Test Item	Harmonic	Test Date	February 15, 2019
Polarize	Horizontal	Test Engineer	Jerry Chuang
Detector	Peak		

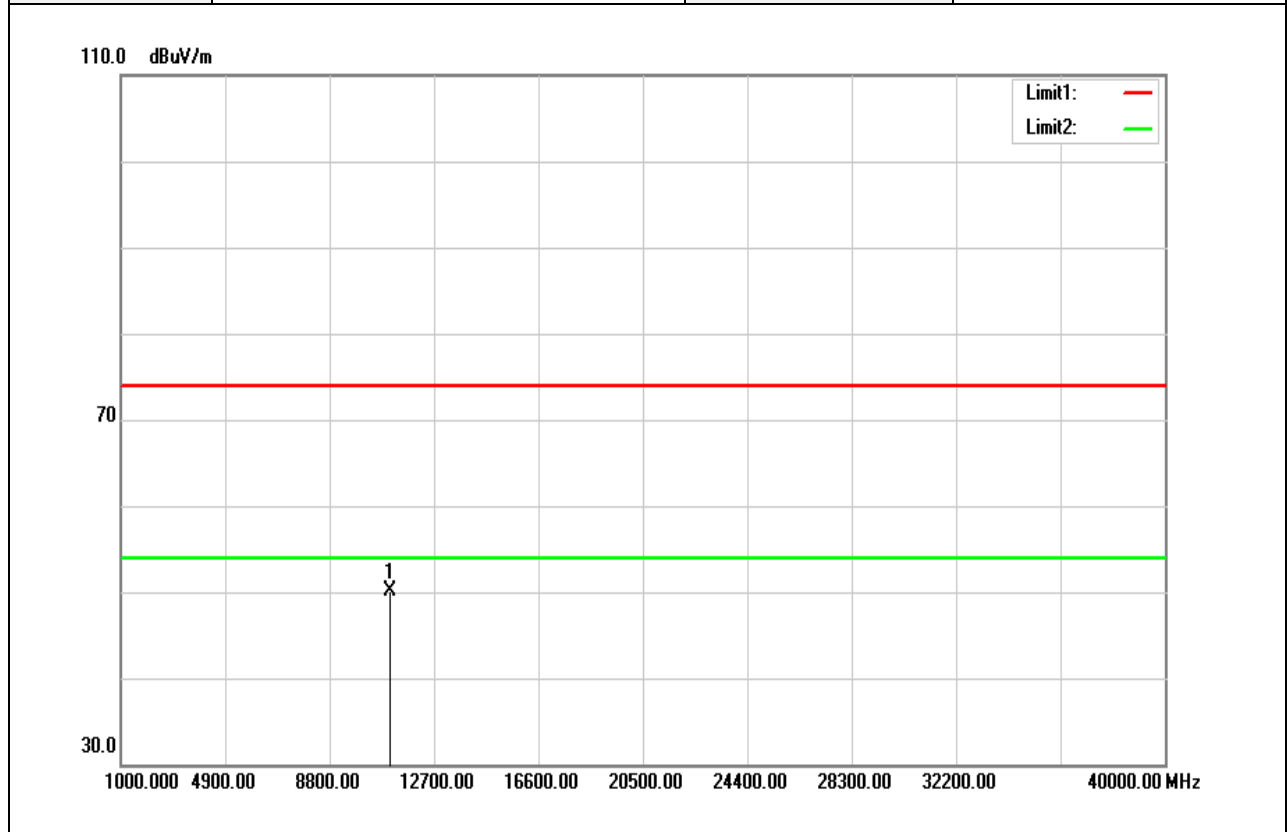

Frequency (MHz)	Reading (dBuV)	Correct Factor (dB/m)	Result (dBuV/m)	Limit (dBuV/m)	Margin (dB)	Remark
11060.000	34.36	15.72	50.08	74.00	-23.92	peak
N/A						

**Remark:**

1. Measuring frequencies from 1 GHz to the 10th harmonic of highest fundamental frequency.
2. For above 1GHz, the EUT peak value was under average limit, therefore the Average value compliance with the average limit

**Above 1G Test Data for UNII-3**

Test Mode	IEEE 802.11a / 5745 MHz	Temp/Hum	23.2(°C)/ 52%RH
Test Item	Harmonic	Test Date	February 15, 2019
Polarize	Vertical	Test Engineer	Jerry Chuang
Detector	Peak		

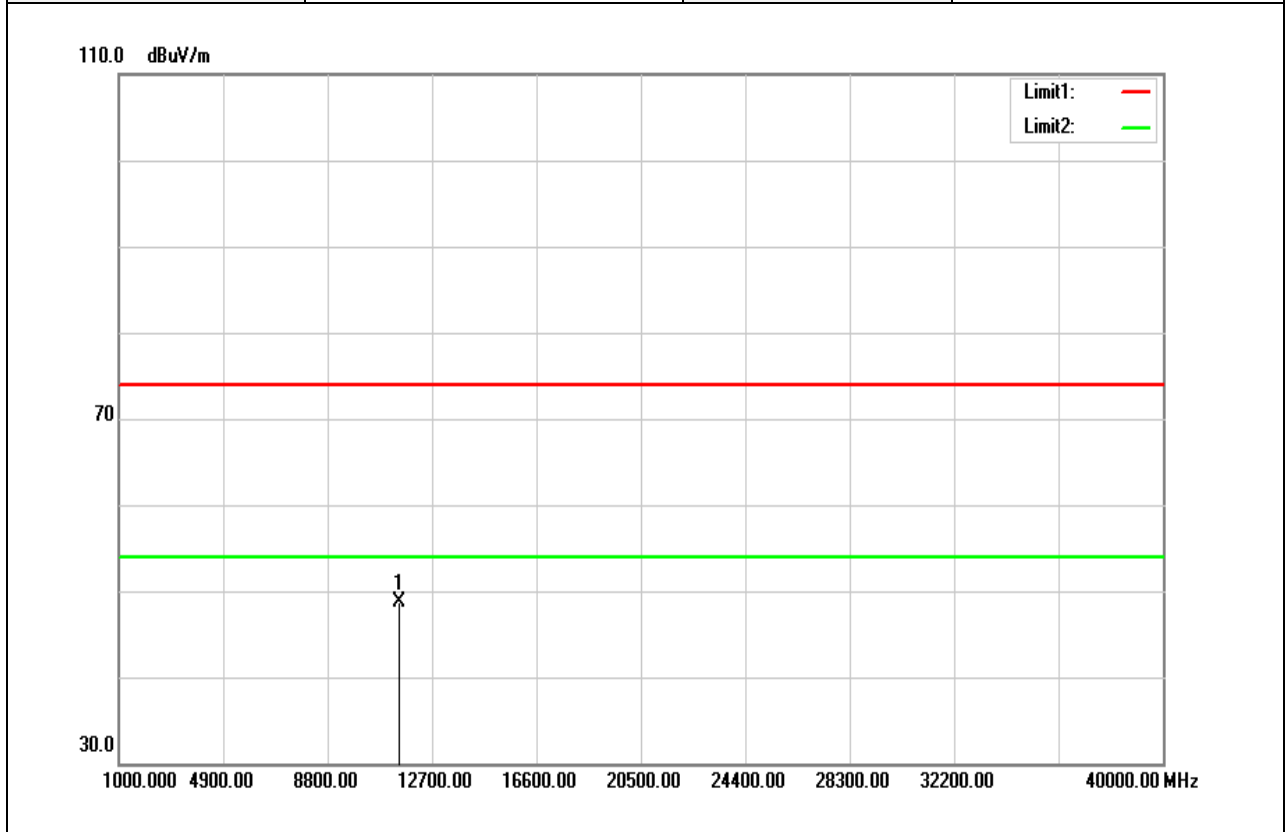

Frequency (MHz)	Reading (dBuV)	Correct Factor (dB/m)	Result (dBuV/m)	Limit (dBuV/m)	Margin (dB)	Remark
11490.000	33.04	15.62	48.66	74.00	-25.34	peak
N/A						

**Remark:**

1. Measuring frequencies from 1 GHz to the 10th harmonic of highest fundamental frequency.
2. For above 1GHz, the EUT peak value was under average limit, therefore the Average value compliance with the average limit

Test Mode	IEEE 802.11a / 5745 MHz	Temp/Hum	23.2(°C)/ 52%RH
Test Item	Harmonic	Test Date	February 15, 2019
Polarize	Horizontal	Test Engineer	Jerry Chuang
Detector	Peak		

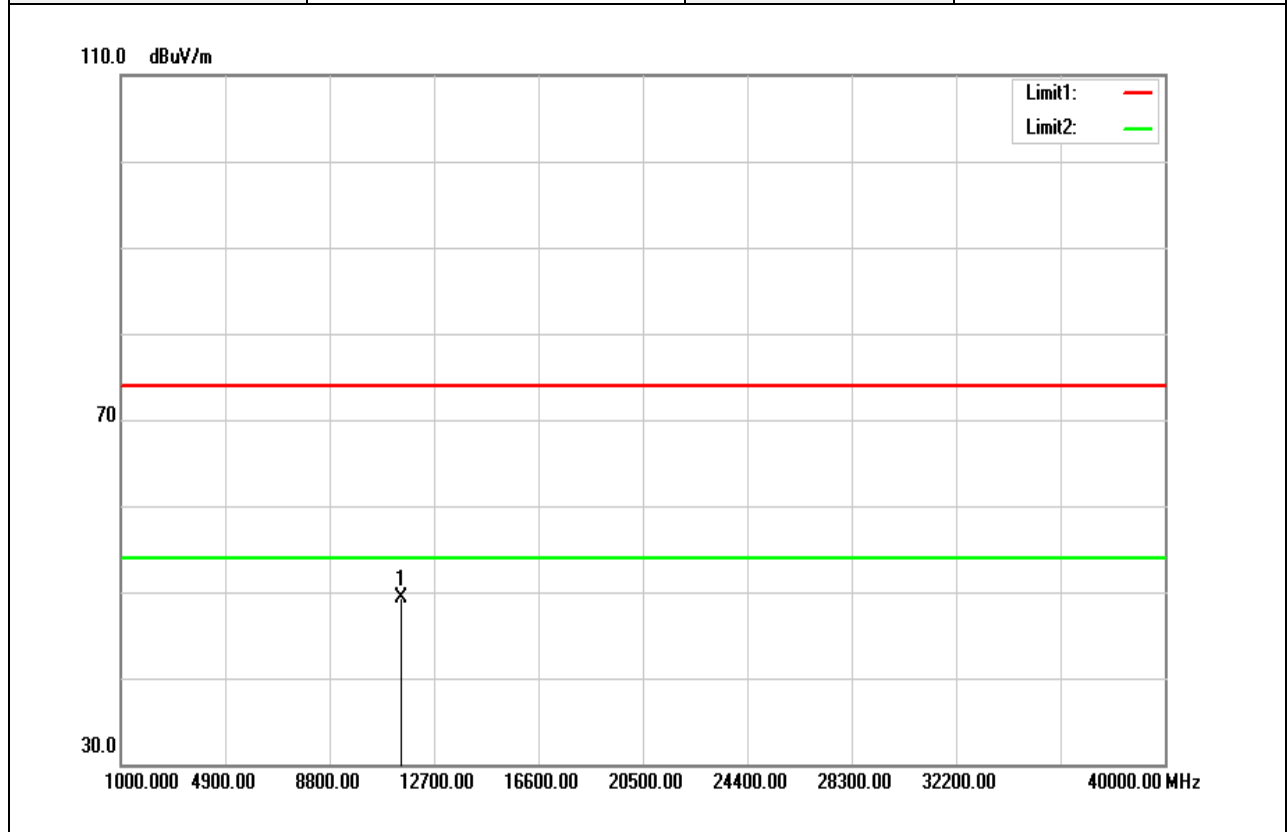

Frequency (MHz)	Reading (dBuV)	Correct Factor (dB/m)	Result (dBuV/m)	Limit (dBuV/m)	Margin (dB)	Remark
11490.000	33.61	15.62	49.23	74.00	-24.77	peak
N/A						

**Remark:**

- Measuring frequencies from 1 GHz to the 10th harmonic of highest fundamental frequency.
- For above 1GHz, the EUT peak value was under average limit, therefore the Average value compliance with the average limit

Test Mode	IEEE 802.11a / 5745 MHz	Temp/Hum	23.2(°C)/ 52%RH
Test Item	Harmonic	Test Date	February 15, 2019
Polarize	Vertical	Test Engineer	Jerry Chuang
Detector	Peak		

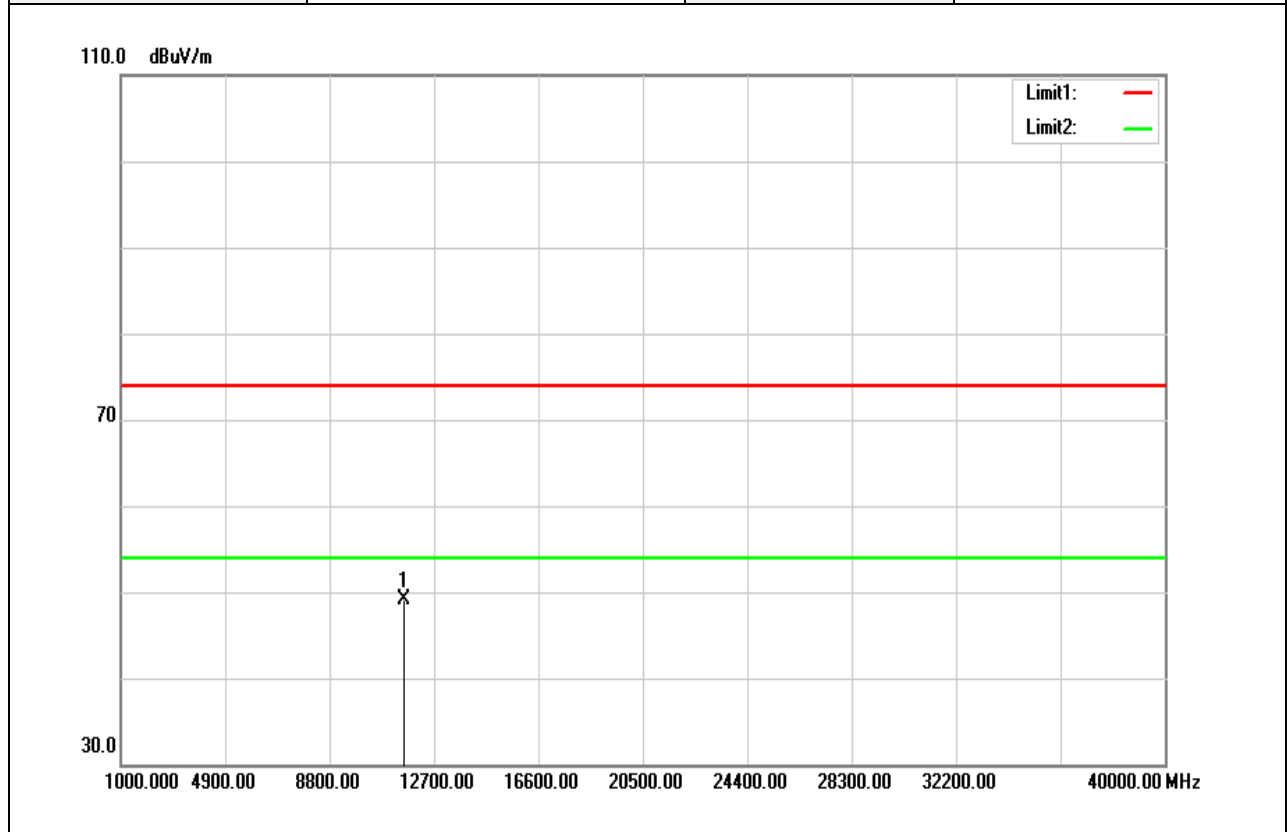

Frequency (MHz)	Reading (dBuV)	Correct Factor (dB/m)	Result (dBuV/m)	Limit (dBuV/m)	Margin (dB)	Remark
11570.000	33.48	15.61	49.09	74.00	-24.91	peak
N/A						

**Remark:**

- Measuring frequencies from 1 GHz to the 10th harmonic of highest fundamental frequency.
- For above 1GHz, the EUT peak value was under average limit, therefore the Average value compliance with the average limit

Test Mode	IEEE 802.11a / 5745 MHz	Temp/Hum	23.2(°C)/ 52%RH
Test Item	Harmonic	Test Date	February 15, 2019
Polarize	Horizontal	Test Engineer	Jerry Chuang
Detector	Peak		

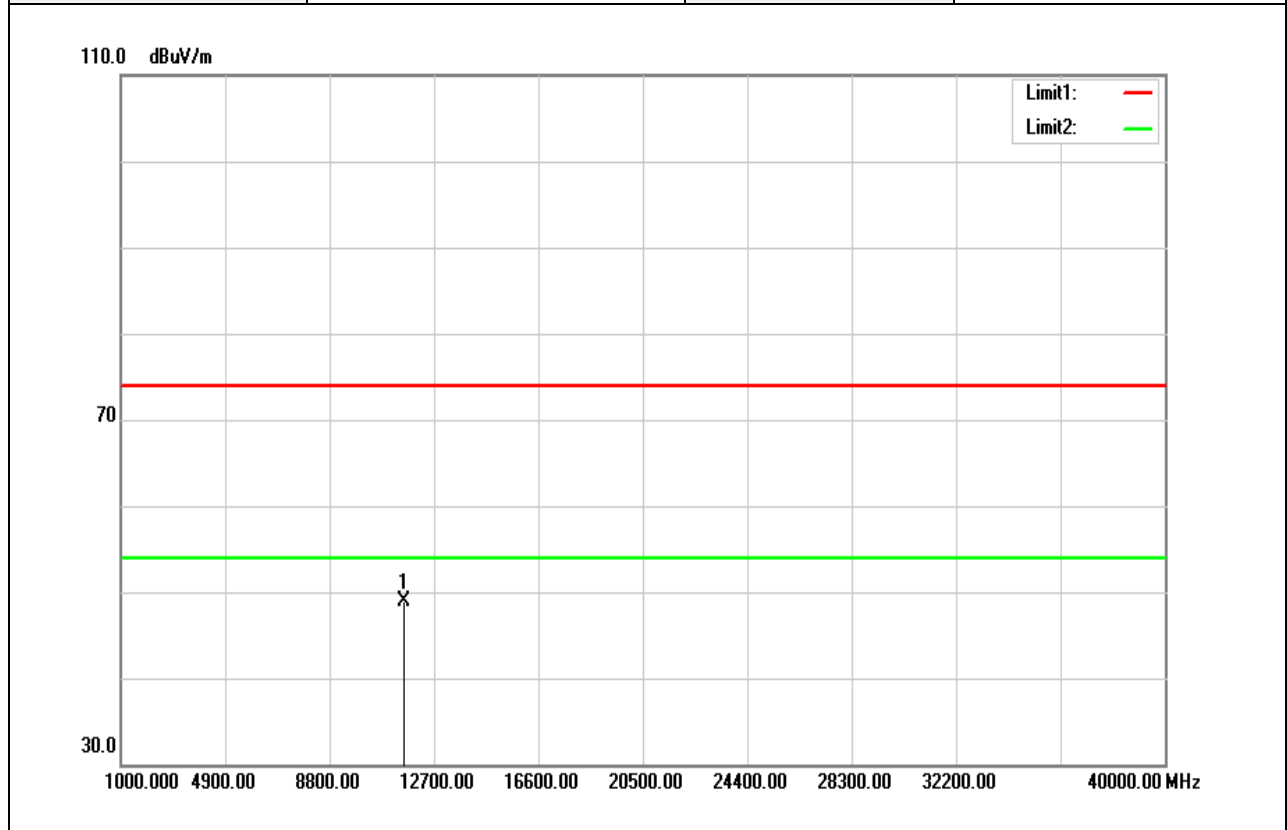

Frequency (MHz)	Reading (dBuV)	Correct Factor (dB/m)	Result (dBuV/m)	Limit (dBuV/m)	Margin (dB)	Remark
11570.000	33.33	15.61	48.94	74.00	-25.06	peak
N/A						

**Remark:**

- Measuring frequencies from 1 GHz to the 10th harmonic of highest fundamental frequency.
- For above 1GHz, the EUT peak value was under average limit, therefore the Average value compliance with the average limit

Test Mode	IEEE 802.11a / 5825 MHz	Temp/Hum	23.2(°C)/ 52%RH
Test Item	Harmonic	Test Date	February 15, 2019
Polarize	Vertical	Test Engineer	Jerry Chuang
Detector	Peak		

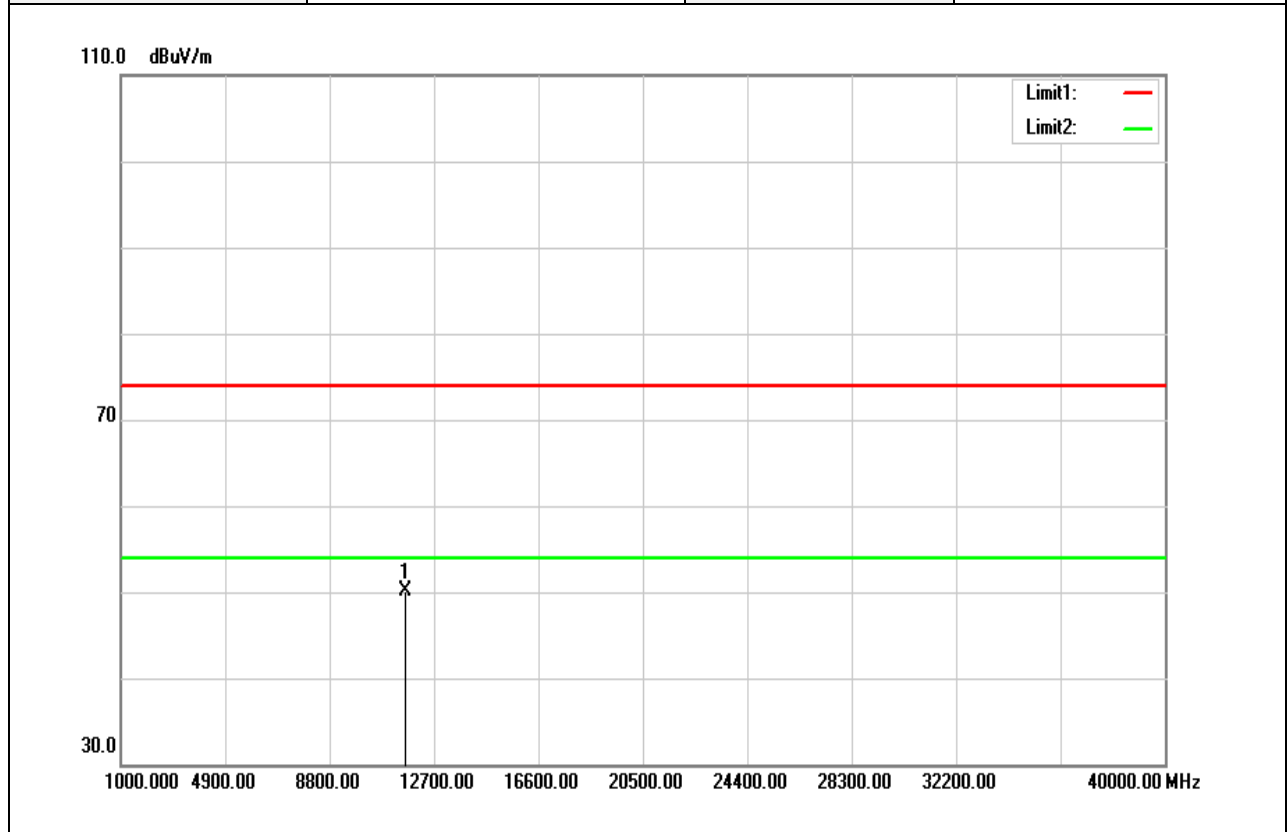

Frequency (MHz)	Reading (dBuV)	Correct Factor (dB/m)	Result (dBuV/m)	Limit (dBuV/m)	Margin (dB)	Remark
11650.000	34.45	15.58	50.03	74.00	-23.97	peak
N/A						

**Remark:**

- Measuring frequencies from 1 GHz to the 10th harmonic of highest fundamental frequency.
- For above 1GHz, the EUT peak value was under average limit, therefore the Average value compliance with the average limit

Test Mode	IEEE 802.11a / 5825 MHz	Temp/Hum	23.2(°C)/ 52%RH
Test Item	Harmonic	Test Date	February 15, 2019
Polarize	Horizontal	Test Engineer	Jerry Chuang
Detector	Peak		

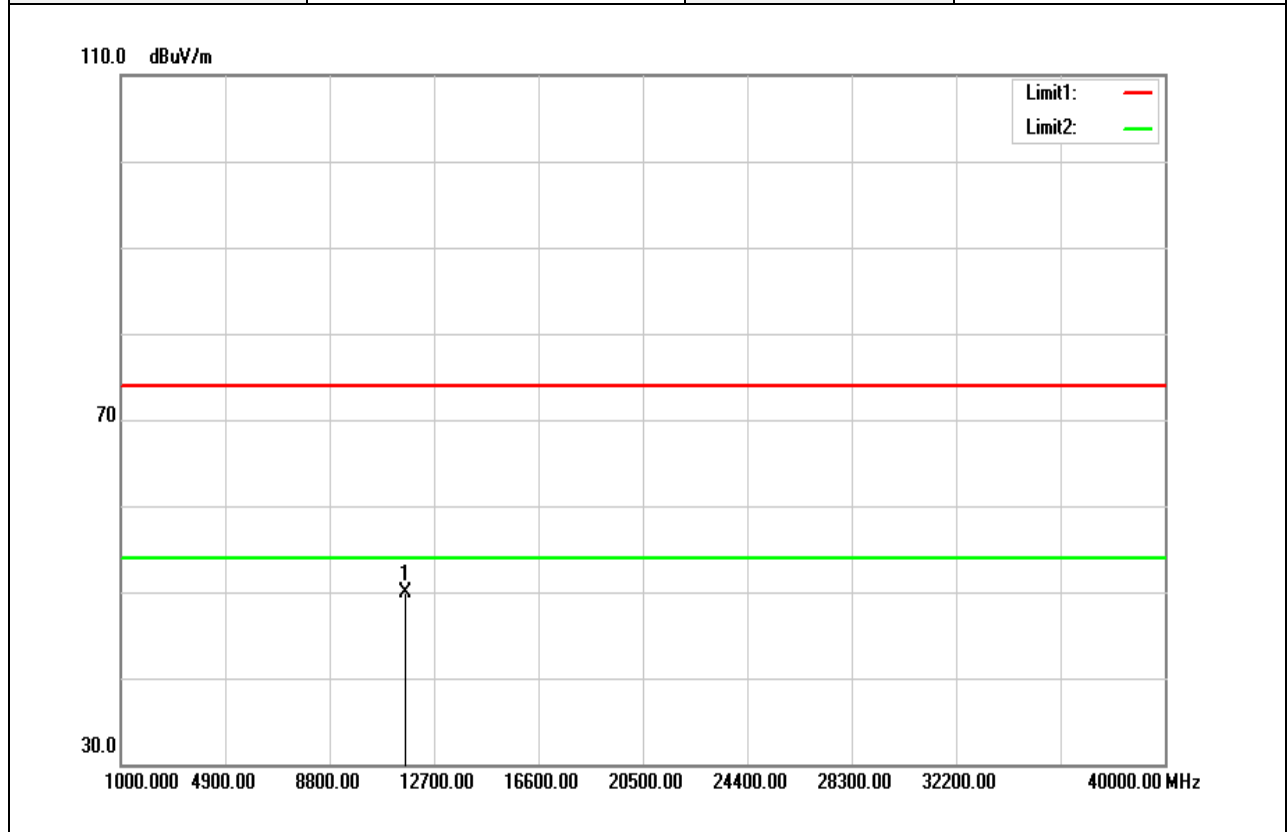

Frequency (MHz)	Reading (dBuV)	Correct Factor (dB/m)	Result (dBuV/m)	Limit (dBuV/m)	Margin (dB)	Remark
11650.000	34.37	15.58	49.95	74.00	-24.05	peak
N/A						

**Remark:**

1. Measuring frequencies from 1 GHz to the 10th harmonic of highest fundamental frequency.
2. For above 1GHz, the EUT peak value was under average limit, therefore the Average value compliance with the average limit



Test Mode	IEEE 802.11n HT20 / 5745 MHz	Temp/Hum	23.2(°C)/ 52%RH
Test Item	Harmonic	Test Date	February 15, 2019
Polarize	Vertical	Test Engineer	Jerry Chuang
Detector	Peak		

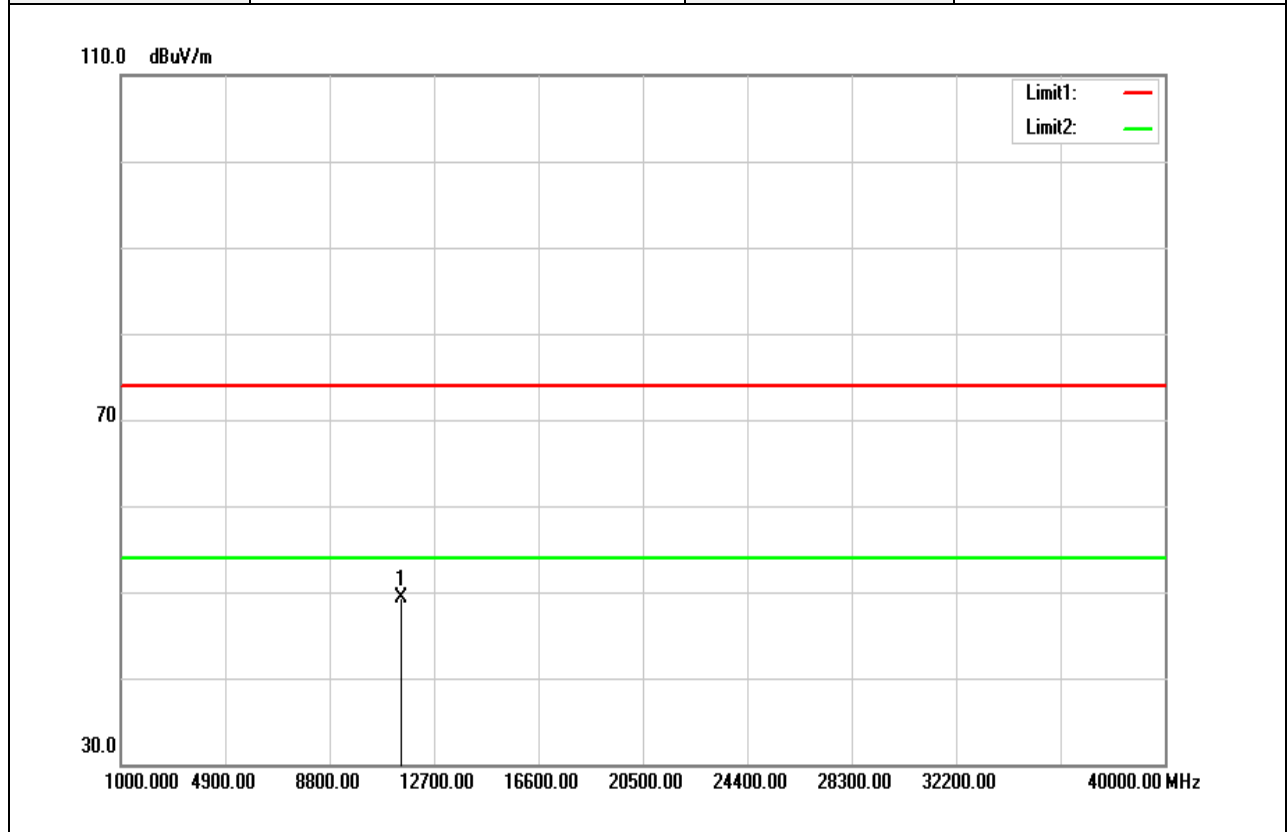

Frequency (MHz)	Reading (dBuV)	Correct Factor (dB/m)	Result (dBuV/m)	Limit (dBuV/m)	Margin (dB)	Remark
11490.000	33.60	15.62	49.22	74.00	-24.78	peak
N/A						

**Remark:**

- Measuring frequencies from 1 GHz to the 10th harmonic of highest fundamental frequency.
- For above 1GHz, the EUT peak value was under average limit, therefore the Average value compliance with the average limit

Test Mode	IEEE 802.11n HT20 / 5745 MHz	Temp/Hum	23.2(°C) / 52%RH
Test Item	Harmonic	Test Date	February 15, 2019
Polarize	Horizontal	Test Engineer	Jerry Chuang
Detector	Peak		

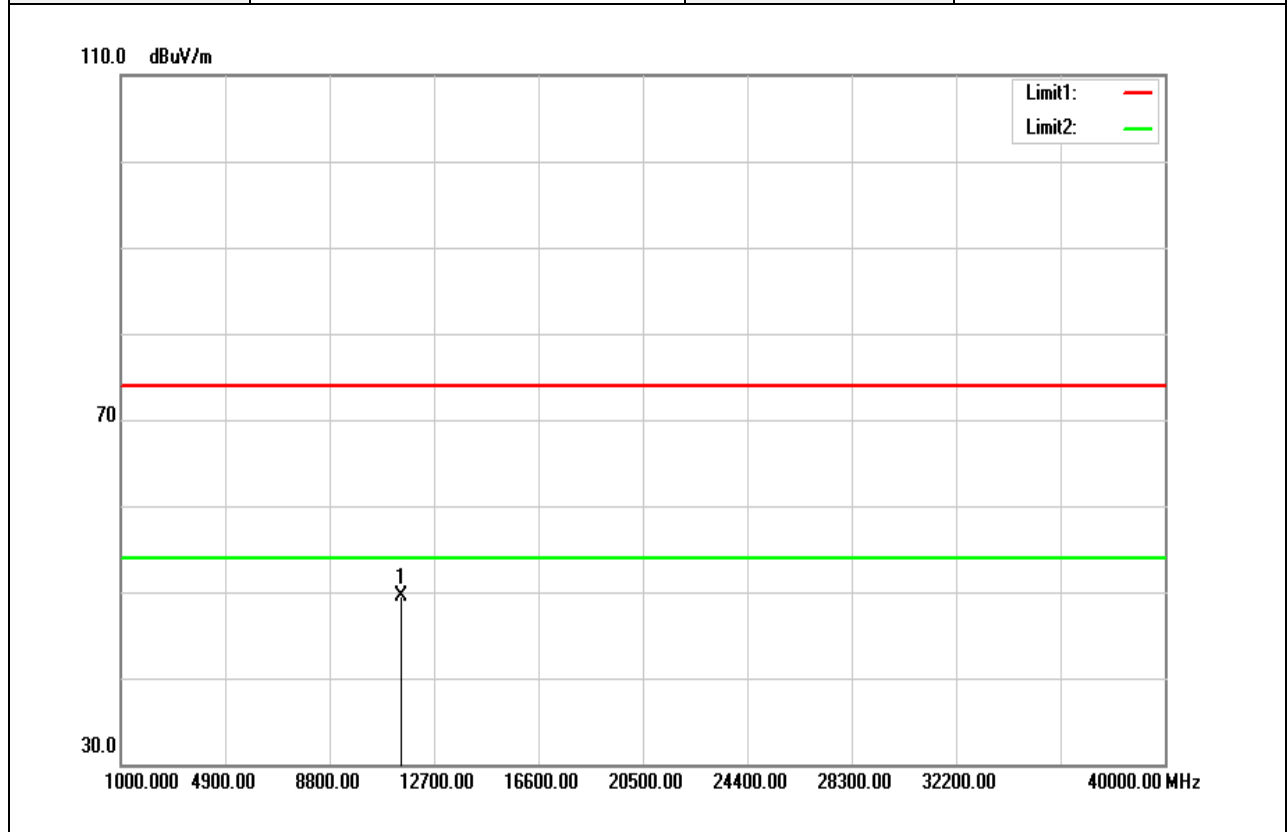

Frequency (MHz)	Reading (dBuV)	Correct Factor (dB/m)	Result (dBuV/m)	Limit (dBuV/m)	Margin (dB)	Remark
11490.000	33.98	15.62	49.60	74.00	-24.40	peak
N/A						

**Remark:**

- Measuring frequencies from 1 GHz to the 10th harmonic of highest fundamental frequency.
- For above 1GHz, the EUT peak value was under average limit, therefore the Average value compliance with the average limit

Test Mode	IEEE 802.11n HT20/ 5785 MHz	Temp/Hum	23.2(°C)/ 52%RH
Test Item	Harmonic	Test Date	February 15, 2019
Polarize	Vertical	Test Engineer	Jerry Chuang
Detector	Peak		

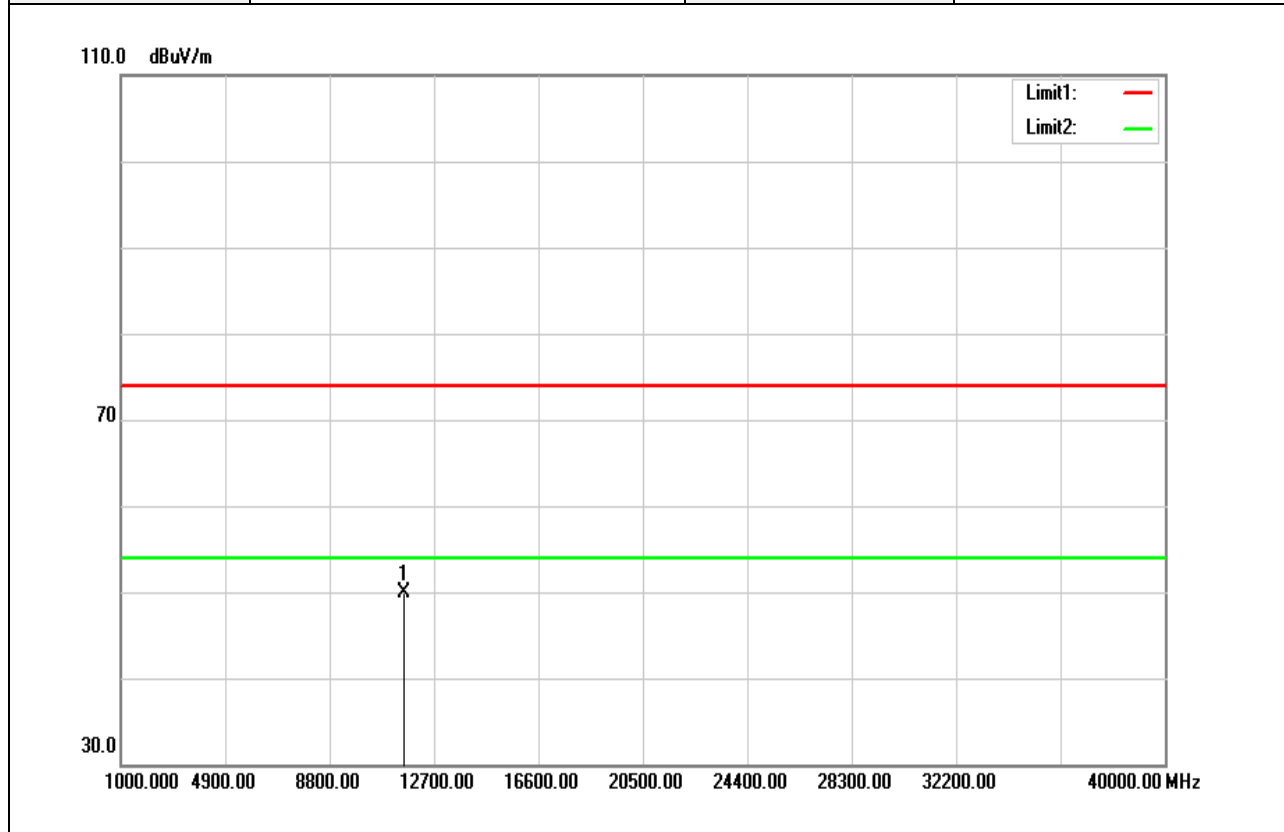

Frequency (MHz)	Reading (dBuV)	Correct Factor (dB/m)	Result (dBuV/m)	Limit (dBuV/m)	Margin (dB)	Remark
11570.000	34.28	15.61	49.89	74.00	-24.11	peak
N/A						

**Remark:**

- Measuring frequencies from 1 GHz to the 10th harmonic of highest fundamental frequency.
- For above 1GHz, the EUT peak value was under average limit, therefore the Average value compliance with the average limit

Test Mode	IEEE 802.11n HT20/ 5785 MHz	Temp/Hum	23.2(°C)/ 52%RH
Test Item	Harmonic	Test Date	February 15, 2019
Polarize	Horizontal	Test Engineer	Jerry Chuang
Detector	Peak		

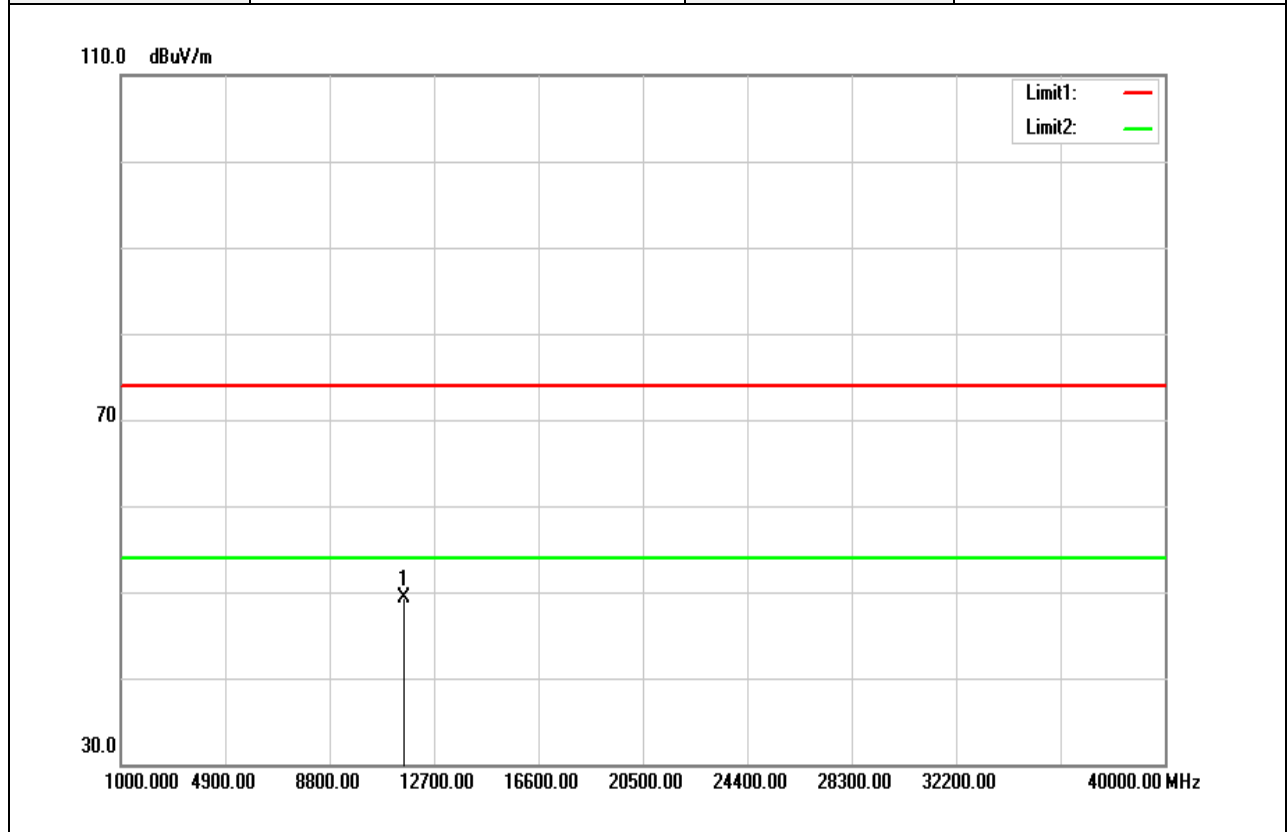

Frequency (MHz)	Reading (dBuV)	Correct Factor (dB/m)	Result (dBuV/m)	Limit (dBuV/m)	Margin (dB)	Remark
11570.000	33.66	15.61	49.27	74.00	-24.73	peak
N/A						

**Remark:**

- Measuring frequencies from 1 GHz to the 10th harmonic of highest fundamental frequency.
- For above 1GHz, the EUT peak value was under average limit, therefore the Average value compliance with the average limit

Test Mode	IEEE 802.11n HT20/ 5825 MHz	Temp/Hum	23.2(°C)/ 52%RH
Test Item	Harmonic	Test Date	February 15, 2019
Polarize	Vertical	Test Engineer	Jerry Chuang
Detector	Peak		

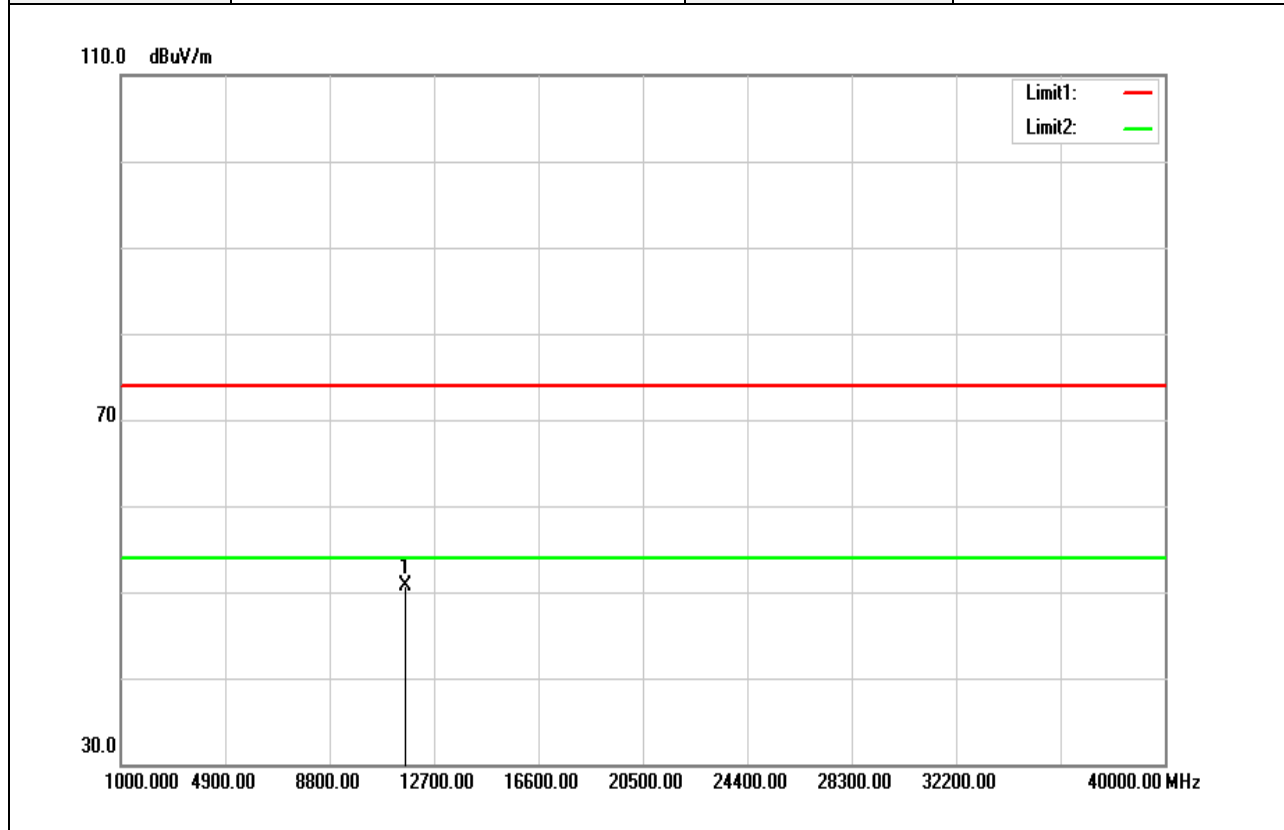

Frequency (MHz)	Reading (dBuV)	Correct Factor (dB/m)	Result (dBuV/m)	Limit (dBuV/m)	Margin (dB)	Remark
11650.000	35.09	15.58	50.67	74.00	-23.33	peak
N/A						

**Remark:**

1. Measuring frequencies from 1 GHz to the 10th harmonic of highest fundamental frequency.
2. For above 1GHz, the EUT peak value was under average limit, therefore the Average value compliance with the average limit

Test Mode	IEEE 802.11n HT20/ 5825 MHz	Temp/Hum	23.2(°C)/ 52%RH
Test Item	Harmonic	Test Date	February 15, 2019
Polarize	Horizontal	Test Engineer	Jerry Chuang
Detector	Peak		

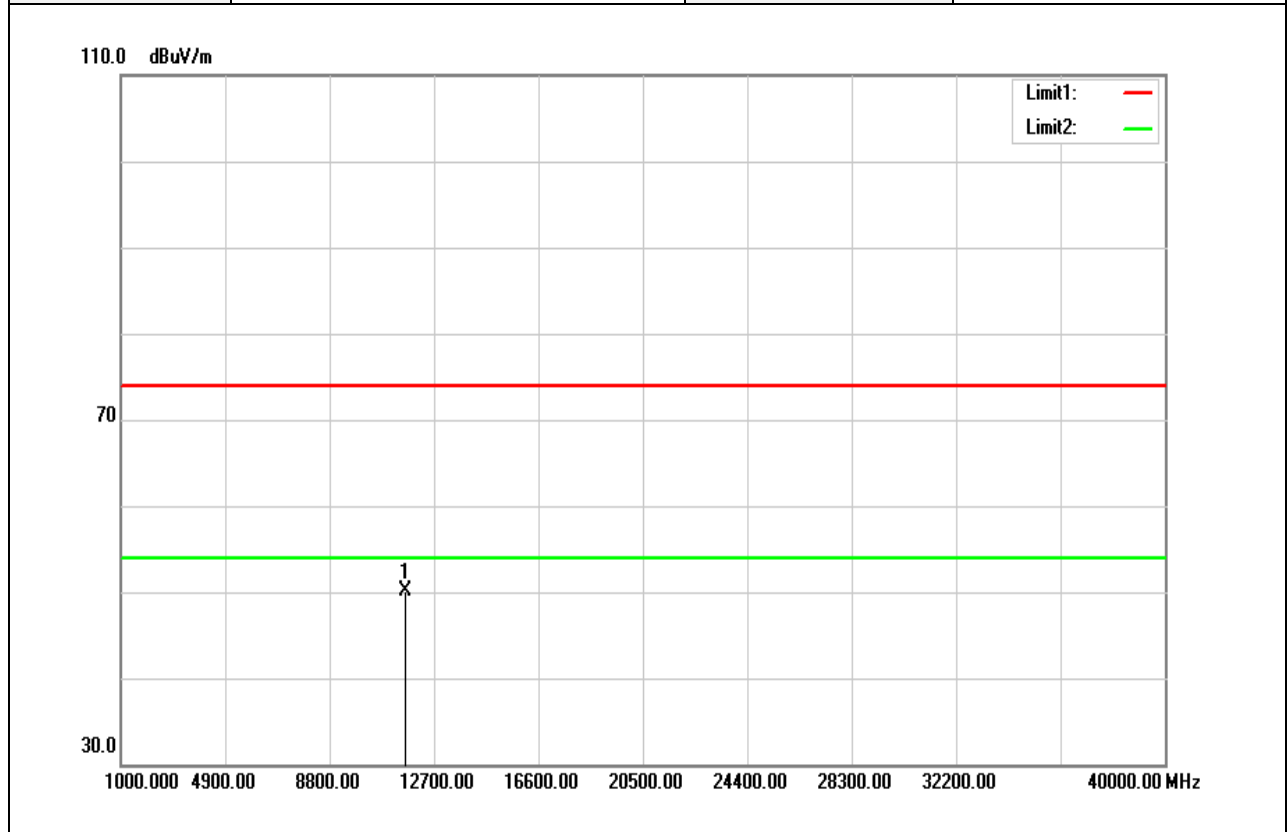

Frequency (MHz)	Reading (dBuV)	Correct Factor (dB/m)	Result (dBuV/m)	Limit (dBuV/m)	Margin (dB)	Remark
11650.000	34.49	15.58	50.07	74.00	-23.93	peak
N/A						

**Remark:**

1. Measuring frequencies from 1 GHz to the 10th harmonic of highest fundamental frequency.
2. For above 1GHz, the EUT peak value was under average limit, therefore the Average value compliance with the average limit

Test Mode	IEEE 802.11n HT40/ 5755 MHz	Temp/Hum	23.2(°C)/ 52%RH
Test Item	Harmonic	Test Date	February 15, 2019
Polarize	Vertical	Test Engineer	Jerry Chuang
Detector	Peak		

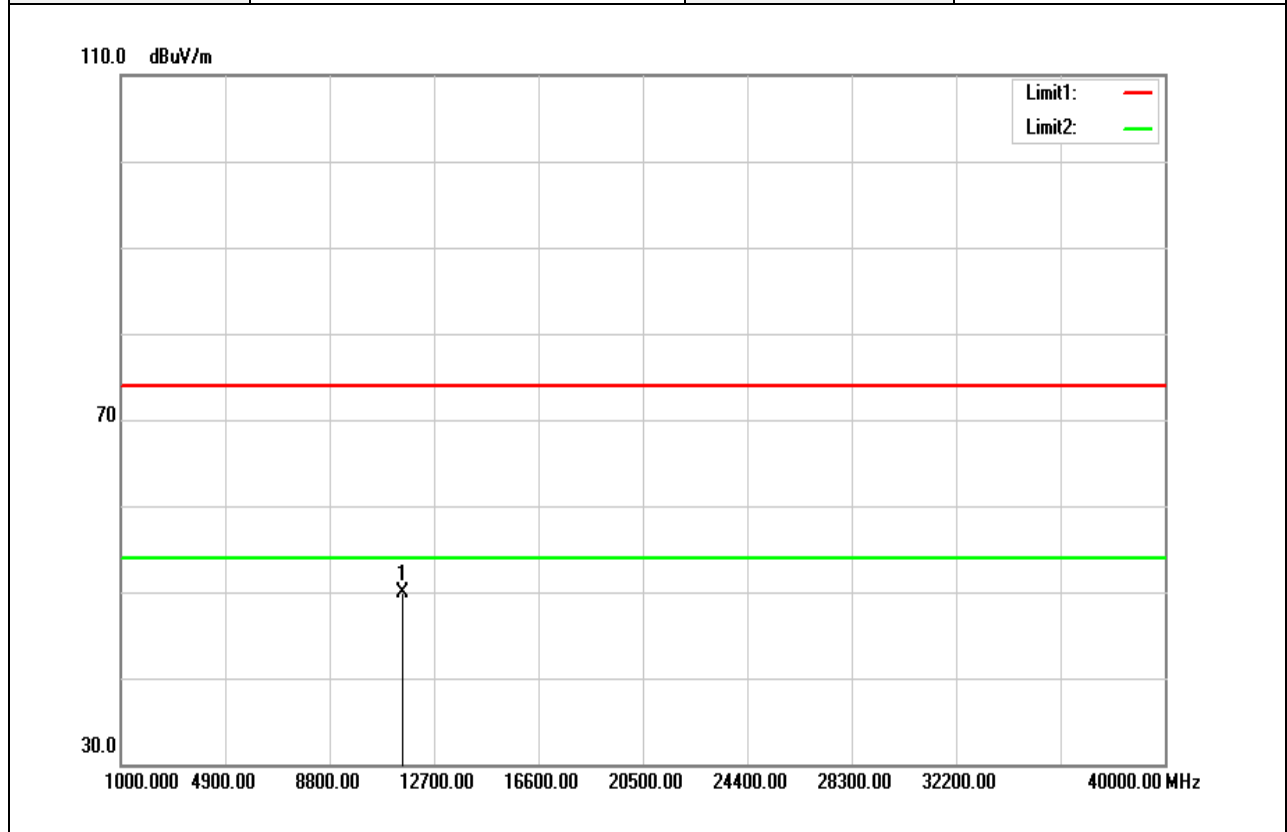

Frequency (MHz)	Reading (dBuV)	Correct Factor (dB/m)	Result (dBuV/m)	Limit (dBuV/m)	Margin (dB)	Remark
11510.000	34.31	15.62	49.93	74.00	-24.07	peak
N/A						

**Remark:**

- Measuring frequencies from 1 GHz to the 10th harmonic of highest fundamental frequency.
- For above 1GHz, the EUT peak value was under average limit, therefore the Average value compliance with the average limit

Test Mode	IEEE 802.11n HT40/ 5755 MHz	Temp/Hum	23.2(°C)/ 52%RH
Test Item	Harmonic	Test Date	February 15, 2019
Polarize	Horizontal	Test Engineer	Jerry Chuang
Detector	Peak		

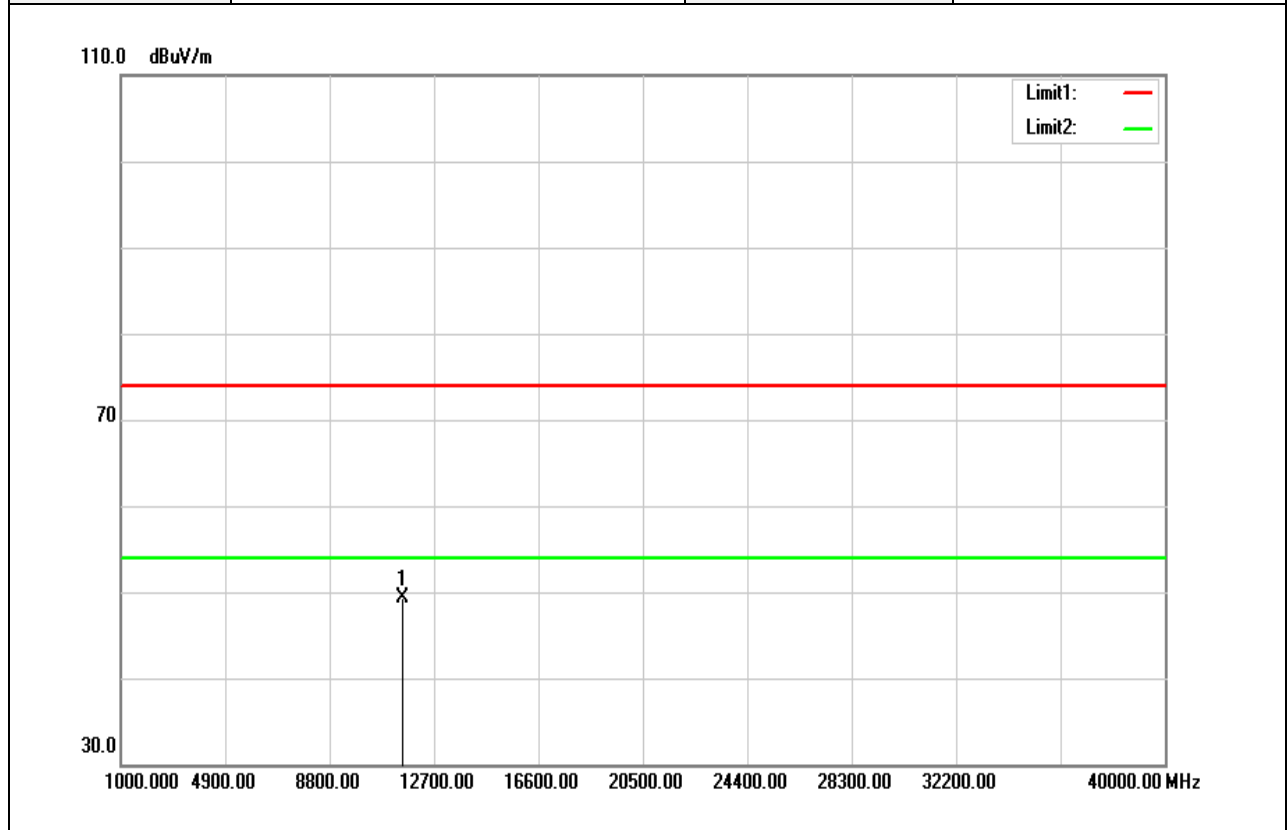

Frequency (MHz)	Reading (dBuV)	Correct Factor (dB/m)	Result (dBuV/m)	Limit (dBuV/m)	Margin (dB)	Remark
11510.000	33.78	15.62	49.40	74.00	-24.60	peak
N/A						

**Remark:**

1. Measuring frequencies from 1 GHz to the 10th harmonic of highest fundamental frequency.
2. For above 1GHz, the EUT peak value was under average limit, therefore the Average value compliance with the average limit



Test Mode	IEEE 802.11n HT40/ 5795 MHz	Temp/Hum	23.2(°C)/ 52%RH
Test Item	Harmonic	Test Date	February 15, 2019
Polarize	Vertical	Test Engineer	Jerry Chuang
Detector	Peak		

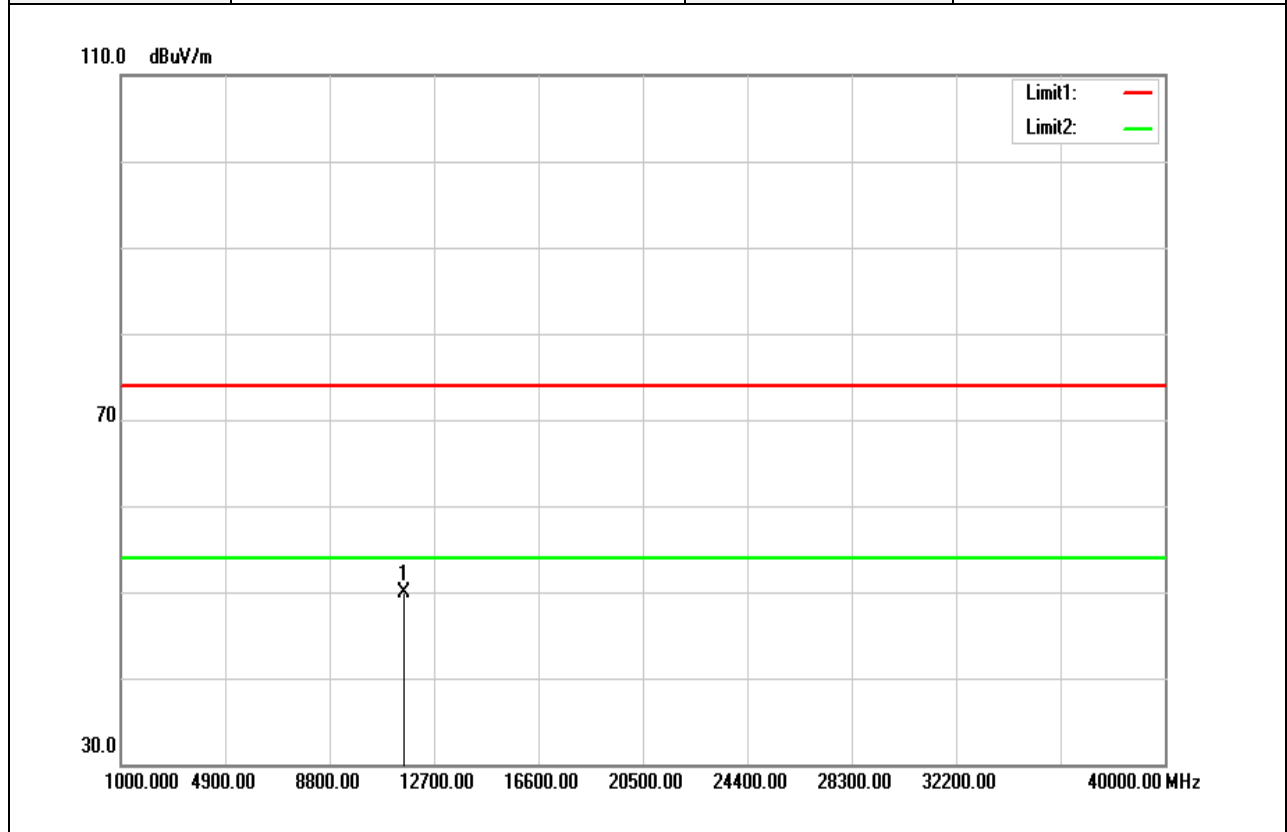

Frequency (MHz)	Reading (dBuV)	Correct Factor (dB/m)	Result (dBuV/m)	Limit (dBuV/m)	Margin (dB)	Remark
11590.000	34.24	15.61	49.85	74.00	-24.15	peak
N/A						

**Remark:**

- Measuring frequencies from 1 GHz to the 10th harmonic of highest fundamental frequency.
- For above 1GHz, the EUT peak value was under average limit, therefore the Average value compliance with the average limit

Test Mode	IEEE 802.11n HT40/ 5795 MHz	Temp/Hum	23.2(°C)/ 52%RH
Test Item	Harmonic	Test Date	February 15, 2019
Polarize	Horizontal	Test Engineer	Jerry Chuang
Detector	Peak		

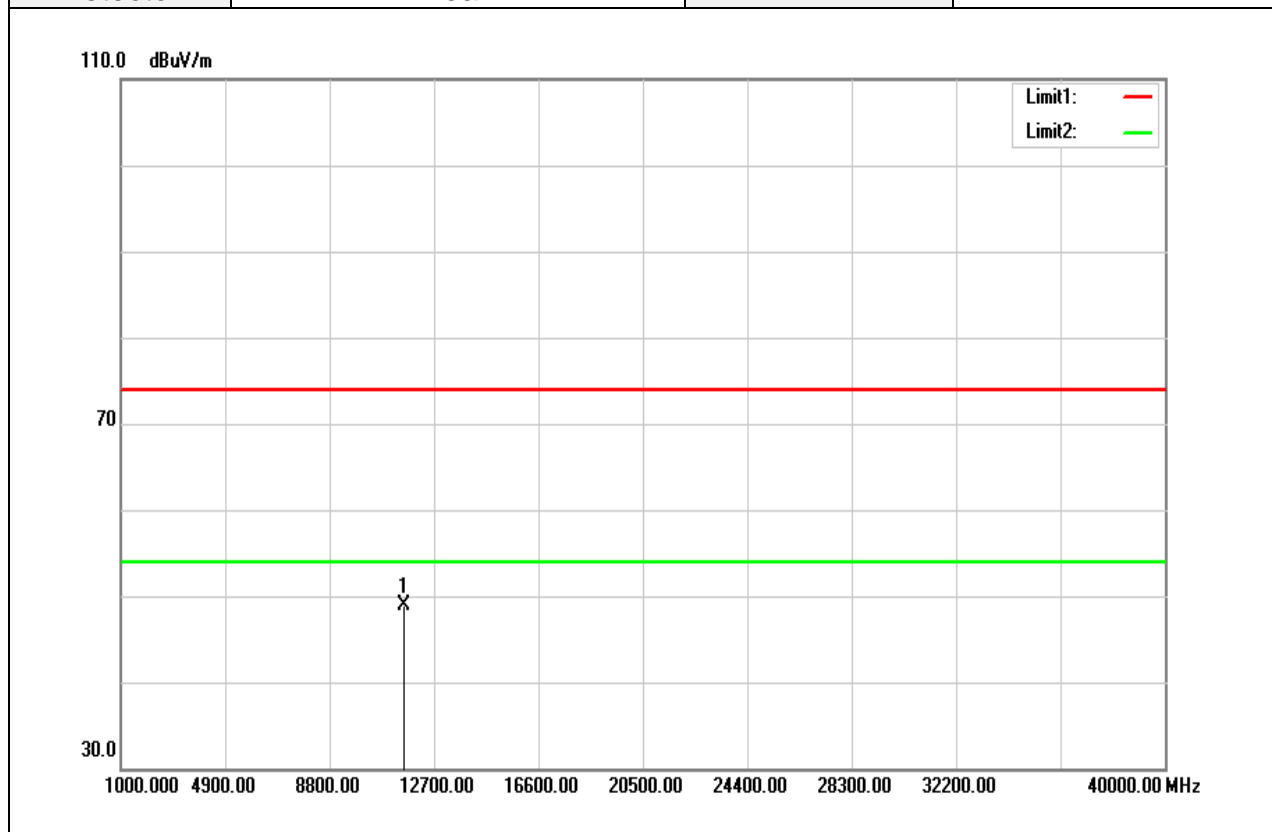

Frequency (MHz)	Reading (dBuV)	Correct Factor (dB/m)	Result (dBuV/m)	Limit (dBuV/m)	Margin (dB)	Remark
11590.000	33.37	15.61	48.98	74.00	-25.02	peak
N/A						

**Remark:**

1. Measuring frequencies from 1 GHz to the 10th harmonic of highest fundamental frequency.
2. For above 1GHz, the EUT peak value was under average limit, therefore the Average value compliance with the average limit

Test Mode	IEEE 802.11ac VHT80/ 5775 MHz	Temp/Hum	23.2(°C)/ 52%RH
Test Item	Harmonic	Test Date	February 15, 2019
Polarize	Vertical	Test Engineer	Jerry Chuang
Detector	Peak		

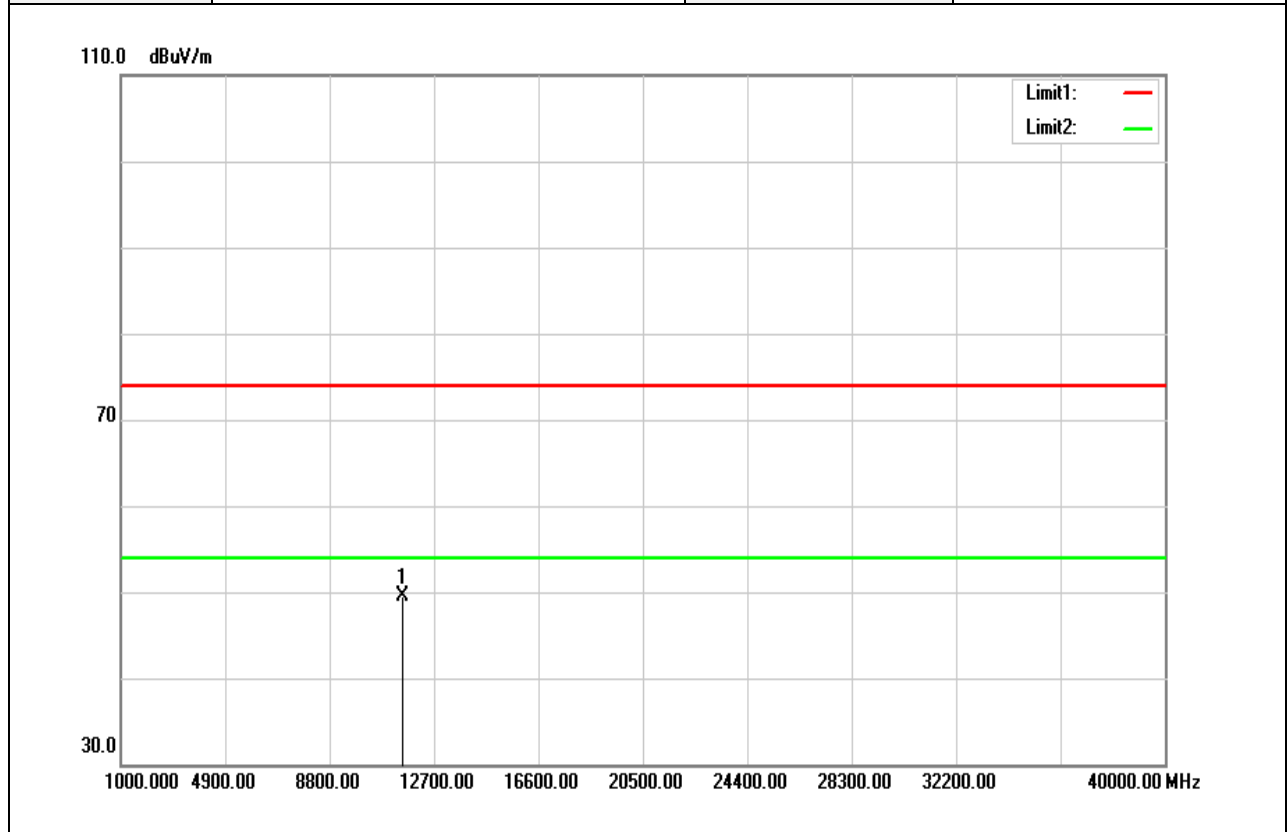

Frequency (MHz)	Reading (dBuV)	Correct Factor (dB/m)	Result (dBuV/m)	Limit (dBuV/m)	Margin (dB)	Remark
11550.000	33.94	15.61	49.55	74.00	-24.45	peak
N/A						

**Remark:**

- Measuring frequencies from 1 GHz to the 10th harmonic of highest fundamental frequency.
- For above 1GHz, the EUT peak value was under average limit, therefore the Average value compliance with the average limit

Test Mode	IEEE 802.11ac VHT80/ 5775 MHz	Temp/Hum	23.2(°C)/ 52%RH
Test Item	Harmonic	Test Date	February 15, 2019
Polarize	Horizontal	Test Engineer	Jerry Chuang
Detector	Peak		

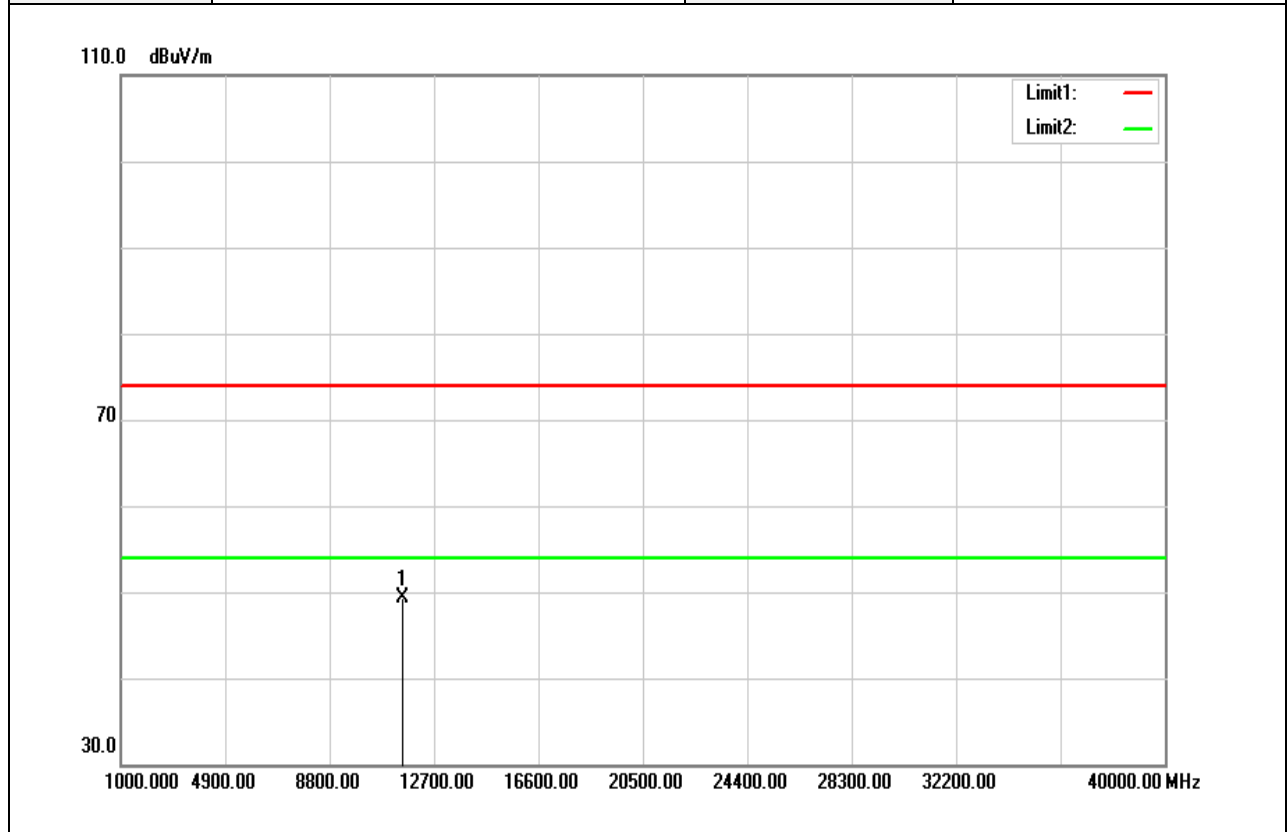

Frequency (MHz)	Reading (dBuV)	Correct Factor (dB/m)	Result (dBuV/m)	Limit (dBuV/m)	Margin (dB)	Remark
11550.000	33.70	15.61	49.31	74.00	-24.69	peak
N/A						

**Remark:**

- Measuring frequencies from 1 GHz to the 10th harmonic of highest fundamental frequency.
- For above 1GHz, the EUT peak value was under average limit, therefore the Average value compliance with the average limit

## 4.6 FREQUENCY STABILITY

### 4.6.1 Test Limit

According to §15.407(g) manufacturers of U-NII devices are responsible for ensuring frequency stability such that an emission is maintained within the band of operation under all conditions of normal operation as specified in the operational description.

### 4.6.2 Test Procedure

The equipment under test was connected to an external AC or DC power supply and input rated voltage. RF output was connected to a frequency counter or spectrum analyzer via feed through attenuators. The EUT was placed inside the temperature chamber. Set the spectrum analyzer RBW low enough to obtain the desired frequency resolution and measure EUT 20°C operating frequency as reference frequency. Turn EUT off and set the chamber temperature to -20°C. After the temperature stabilized for approximately 30 minutes recorded the frequency. Repeat step measure with 10°C increased per stage until the highest temperature of +50°C reached.

### 4.6.3 Test Setup

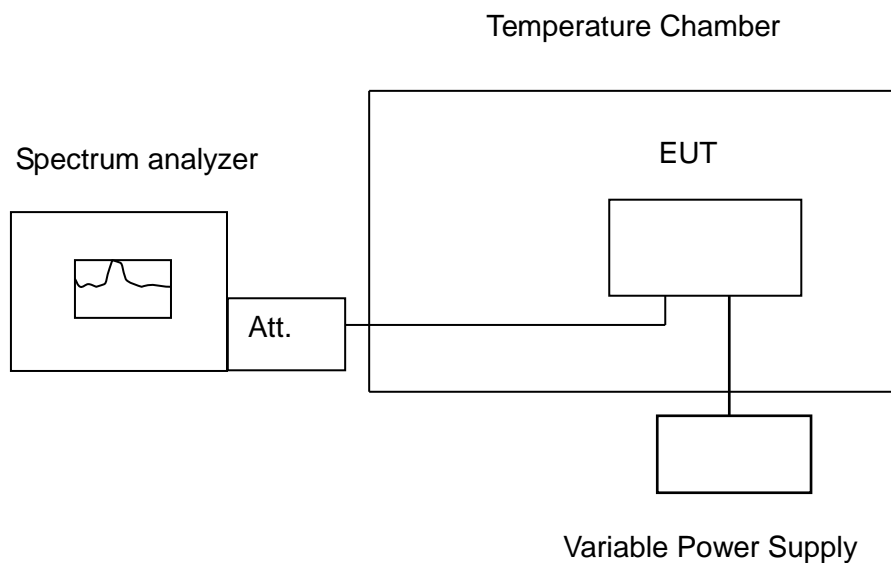

### 4.6.4 Test Result

Temp. (°C)	Voltage (V)	Measured Frequency	5180				Limit				Result
			Time (min)				20ppm				
Operating Frequency:		0 min	2 min	5 min	10 min	0 min	2 min	5 min	10 min		
50	120	5179.99820	5179.99815	5179.99798	5179.99788	-0.3475	-0.3571	-0.3900	-0.4093	Pass	
40	120	5179.99898	5179.99891	5179.99859	5179.99862	-0.1969	-0.2104	-0.2722	-0.2664	Pass	
30	120	5179.99982	5179.99975	5179.99963	5179.99980	-0.0347	-0.0483	-0.0714	-0.0386	Pass	
20	120	5180.00322	5180.00288	5180.00278	5180.00269	0.6216	0.5560	0.5367	0.5193	Pass	
10	120	5180.00325	5180.00312	5180.00301	5180.00297	0.6274	0.6023	0.5811	0.5734	Pass	
0	120	5180.00557	5180.00536	5180.00499	5180.00491	1.0753	1.0347	0.9633	0.9479	Pass	
-10	120	5180.00588	5180.00577	5180.00563	5180.00559	1.1351	1.1139	1.0869	1.0792	Pass	
-20	120	5180.00682	5180.00643	5180.00625	5180.00671	1.3166	1.2413	1.2066	1.2954	Pass	

Temp. (°C)	Voltage (V)	Measured Frequency	5180				Limit				Result
			Time (min)				20ppm				
Operating Frequency:		0 min	2 min	5 min	10 min	0 min	2 min	5 min	10 min		
20	108	5179.99315	5179.99248	5179.99233	5179.99249	-1.3224	-1.4517	-1.4807	-1.4498	Pass	
20	120	5179.99310	5179.99248	5179.99215	5179.99222	-1.3320	-1.4517	-1.5154	-1.5019	Pass	
20	132	5179.99307	5179.99229	5179.99247	5179.99355	-1.3378	-1.4884	-1.4537	-1.2452	Pass	

Temp. (°C)	Voltage (V)	Measured Frequency	5260				Limit				Result
			Time (min)				20ppm				
Operating Frequency:		0 min	2 min	5 min	10 min	0 min	2 min	5 min	10 min		
50	120	5260.05963	5260.06187	5260.06948	5260.04876	11.3365	11.7624	13.2091	9.2700	Pass	
40	120	5260.06275	5260.04654	5260.04809	5260.05605	11.9297	8.8479	9.1426	10.6559	Pass	
30	120	5260.06255	5260.04632	5260.04758	5260.05549	11.8909	8.8061	9.0456	10.5494	Pass	
20	120	5260.04922	5260.04589	5260.03244	5260.02080	9.3574	8.7243	6.1673	3.9544	Pass	
10	120	5260.01849	5260.03852	5260.02891	5260.03453	3.5152	7.3232	5.4962	6.5646	Pass	
0	120	5260.00561	5260.00188	5260.00679	5260.00470	1.0665	0.3568	1.2909	0.8932	Pass	
-10	120	5260.00557	5260.00210	5260.00599	5260.00478	1.0589	0.3992	1.1388	0.9091	Pass	
-20	120	5260.00798	5260.00473	5260.00682	5260.00328	1.5175	0.8985	1.2966	0.6236	Pass	

Temp. (°C)	Voltage (V)	Measured Frequency	5260				Limit				Result
			Time (min)				20ppm				
Operating Frequency:		0 min	2 min	5 min	10 min	0 min	2 min	5 min	10 min		
20	108	5260.04723	5260.04572	5260.03232	5260.02711	8.9791	8.6920	6.1445	5.1540	Pass	
20	120	5260.04969	5260.04522	5260.03237	5260.02909	9.4468	8.5970	6.1540	5.5304	Pass	
20	132	5260.04710	5260.04452	5260.03298	5260.02856	8.9544	8.4639	6.2700	5.4297	Pass	

Temp. (°C)	Voltage (V)	Measured Frequency	5500				Limit				Result
			Time (min)				20ppm				
Operating Frequency:		0 min	2 min	5 min	10 min	0 min	2 min	5 min	10 min		
50	120	5500.10458	5500.10470	5500.10870	5500.10485	19.0142	19.0356	19.7636	19.0635	Pass	
40	120	5500.06699	5500.07254	5500.07629	5500.07715	12.1800	13.1891	13.8715	14.0275	Pass	
30	120	5500.10062	5500.10123	5500.10169	5500.10198	18.2951	18.4055	18.4891	18.5418	Pass	
20	120	5500.10486	5500.10456	5500.10879	5500.10489	19.0663	19.0117	19.7798	19.0718	Pass	
10	120	5500.07698	5500.07134	5500.07453	5500.07965	13.9964	12.9709	13.5515	14.4820	Pass	
0	120	5500.06182	5500.06823	5500.06779	5500.06321	11.2396	12.4055	12.3254	11.4927	Pass	
-10	120	5500.05128	5500.05179	5500.05790	5500.05375	9.3233	9.4162	10.5271	9.7735	Pass	
-20	120	5500.06185	5500.06493	5500.06640	5500.12935	11.2456	11.8055	12.0722	23.5182	Pass	

Temp. (°C)	Voltage (V)	Measured Frequency	5500				Limit				Result
			Time (min)				20ppm				
Operating Frequency:		0 min	2 min	5 min	10 min	0 min	2 min	5 min	10 min		
20	108	5500.07648	5500.07169	5500.07523	5500.07810	13.9058	13.0345	13.6782	14.2000	Pass	
20	120	5500.07796	5500.07514	5500.07556	5500.07875	14.1745	13.6618	13.7387	14.3184	Pass	
20	132	5500.04826	5500.04937	5500.04922	5500.04926	8.7745	8.9764	8.9491	8.9556	Pass	

Temp. (°C)	Voltage (V)	Measured Frequency	5745				Limit				Result
			Time (min)				20ppm				
Operating Frequency:		0 min	2 min	5 min	10 min	0 min	2 min	5 min	10 min		
50	120	5745.03746	5745.03594	5745.03338	5745.03588	6.5201	6.2559	5.8103	6.2454	Pass	
40	120	5745.08059	5745.08252	5745.09452	5745.08639	14.0279	14.3631	16.4526	15.0374	Pass	
30	120	5745.08423	5745.08485	5745.08512	5745.08556	14.6621	14.7694	14.8164	14.8930	Pass	
20	120	5745.07023	5745.07319	5745.07154	5745.07945	12.2247	12.7391	12.4519	13.8296	Pass	
10	120	5745.05153	5745.05123	5745.05979	5745.05059	8.9697	8.9175	10.4071	8.8057	Pass	
0	120	5745.03486	5745.03741	5745.03312	5745.03987	6.0687	6.5117	5.7654	6.9406	Pass	
-10	120	5745.07023	5745.07319	5745.07154	5745.07945	12.2247	12.7391	12.4519	13.8296	Pass	
-20	120	5745.06250	5745.05162	5745.06292	5745.06126	10.8790	8.9844	10.9521	10.6630	Pass	

Temp. (°C)	Voltage (V)	Measured Frequency	5745				Limit				Result
			Time (min)				20ppm				
Operating Frequency:		0 min	2 min	5 min	10 min	0 min	2 min	5 min	10 min		
20	108	5745.09865	5745.09816	5745.09961	5745.09861	17.1715	17.0862	17.3386	17.1648	Pass	
20	120	5745.05168	5745.05233	5745.05368	5745.05287	8.9956	9.1088	9.3438	9.2028	Pass	
20	132	5745.03649	5745.03918	5745.03923	5745.03942	6.3511	6.8198	6.8285	6.8616	Pass	

## 4.7 DYNAMIC FREQUENCY SELECTION

### 4.7.1 Test Limit

FCC according to §15.407 (h), KDB 905462 D02 "compliance measurement procedures for unlicensed-national information infrastructure devices operating in the 5250-5350 MHz and 5470-5725 MHz bands incorporating dynamic frequency selection". and KDB 905462 D03 " U-NII client devices without radar detection capability.

IC according RSS-247 section 6.3, and it harmonized with FCC Part 15 DFS rules.

The EIRP refer section 4.3 output power measurement in this report.

**Table 1: Applicability of DFS requirements prior to use of a channel**

Requirement	Operational Mode		
	Master	Client (without radar detection)	Client (with radar detection)
Non-Occupancy Period	Yes	Not required	Yes
DFS Detection Threshold	Yes	Not required	Yes
Channel Availability Check Time	Yes	Not required	Not required
U-NII Detection Bandwidth	Yes	Not required	Yes

**Table 2: Applicability of DFS requirements during normal operation**

Requirement	Operational Mode	
	Master Device or Client with Radar Detection	Client Without Radar Detection
DFS Detection Threshold	Yes	Not required
Channel Closing Transmission Time	Yes	Yes
Channel Move Time	Yes	Yes
U-NII Detection Bandwidth	Yes	Not required

Additional requirements for devices with multiple bandwidth mods	Master Device or Client with Radar Detection	Client Without Radar Detection
U-NII Detection Bandwidth and Statistical Performance Check	All BW modes must be tested	Not required
Channel Move Time and Channel Closing Transmission Time	Test using widest BW mode available	Test using the widest BW mode available for the link
All other tests	Any single BW mode	Not required

Note: Frequencies selected for statistical performance check (Section 7.8.4) should include several frequencies within the radar detection bandwidth and frequencies near the edge of the radar detection bandwidth. For 802.11 devices it is suggested to select frequencies in each of the bonded 20 MHz channels and the channel center frequency.



**Table 3: Interference Threshold values, Master or Client incorporating In-Service**

Maximum Transmit Power	Value (See Notes 1, 2, and 3)
EIRP ≥ 200 milliwatt	-64 dBm
EIRP < 200 milliwatt and power spectral density < 10 dBm/MHz	-62 dBm
EIRP < 200 milliwatt that do not meet the power spectral density requirement	-64 dBm

**Note 1:** This is the level at the input of the receiver assuming a 0 dBi receive antenna.  
**Note 2:** Throughout these test procedures an additional 1 dB has been added to the amplitude of the test transmission waveforms to account for variations in measurement equipment. This will ensure that the test signal is at or above the detection threshold level to trigger a DFS response.  
**Note 3:** EIRP is based on the highest antenna gain. For MIMO devices refer to KDB Publication 662911 D01.

**Table 4: DFS Response requirement values**

Parameter	Value
Non-occupancy period	Minimum 30 minutes
Channel Availability Check Time	60 seconds
Channel Move Time	10 seconds See Note 1.
Channel Closing Transmission Time	200 milliseconds + an aggregate of 60 milliseconds over remaining 10 second period. See Notes 1 and 2.
U-NII Detection Bandwidth	Minimum 100% of the U-NII 99% transmission power bandwidth. See Note 3.

**Note 1:** Channel Move Time and the Channel Closing Transmission Time should be performed with Radar Type 0. The measurement timing begins at the end of the Radar Type 0 burst.  
**Note 2:** The Channel Closing Transmission Time is comprised of 200 milliseconds starting at the beginning of the Channel Move Time plus any additional intermittent control signals required to facilitate a Channel move (an aggregate of 60 milliseconds) during the remainder of the 10 second period. The aggregate duration of control signals will not count quiet periods in between transmissions.  
**Note 3:** During the U-NII Detection Bandwidth detection test, radar type 0 should be used. For each frequency step the minimum percentage of detection is 90 percent. Measurements are performed with no data traffic.

**Table 5 – Short Pulse Radar Test Waveforms**

Radar Type	Pulse Width (μsec)	PRI (μsec)	Number of Pulses	Minimum Percentage of Successful Detection	Minimum Number of Trials
0	1	1428	18	See Note 1	
1	1	Test A: 15 unique PRI values randomly selected from the list of 23 PRI values in Table 5a	$\text{Roundup} \left\{ \left( \frac{1}{360} \right) \cdot \left( \frac{19 \cdot 10^6}{\text{PRI}_{\mu\text{sec}}} \right) \right\}$	60%	30
		Test B: 15 unique PRI values randomly selected within the range of 518-3066 μsec, with a minimum increment of 1 μsec, excluding PRI values selected in Test A			
2	1-5	150-230	23-29	60%	30
3	6-10	200-500	16-18	60%	30
4	11-20	200-500	12-16	60%	30
Aggregate (Radar Types 1-4)				80%	120
<b>Note 1:</b> Short Pulse Radar Type 0 should be used for the detection bandwidth test, channel move time, and channel closing time tests.					

**Table 6 – Long Pulse Radar Test Signal**

Radar Type	Pulse Width (μsec)	Chirp Width (MHz)	PRI (μsec)	Number of Pulses per Burst	Number of Bursts	Minimum Percentage of Successful Detection	Minimum Number of Trials
5	50-100	5-20	1000-2000	1-3	8-20	80%	30

**Table 7 – Frequency Hopping Radar Test Signal**

Radar Type	Pulse Width (μsec)	PRI (μsec)	Pulses per Hop	Hopping Rate (kHz)	Hopping Sequence Length (msec)	Minimum Percentage of Successful Detection	Minimum Number of Trials
6	1	333	9	0.333	300	70%	30

## 4.7.2 Test Procedure

### Overview Of EUT With Respect To §15.407 (H) Requirements

The firmware installed in the EUT during testing was:

#### **Firmware Rev: 2.0.0.8**

The EUT operates over the 5250-5350 MHz range as a Client Device that does not have radar detection capability.

The EUT uses one transmitter connected to two 50-ohm coaxial antenna ports via a diversity switch. Only one antenna port is connected to the test system since the EUT has one antenna only.

The Slave device associated with the EUT during these tests does not have radar detection capability.

WLAN traffic is generated by streaming the video file TestFile.mp2 “6 ½ Magic Hours” from the Master to the Slave in full motion video mode using the media player with the V2.61 Codec package.

The EUT utilizes the 802.11a architecture, with a nominal channel bandwidth of 20 MHz.

The rated output power of the Master unit is  $< 23\text{dBm}$  (EIRP). Therefore the required interference threshold level is  $-62\text{ dBm}$ . After correction for antenna gain and procedural adjustments, the required conducted threshold at the antenna port is  $-62 + 5 = -57\text{dBm}$ .

The calibrated conducted DFS Detection Threshold level is set to  $-57\text{ dBm}$ . The tested level is lower than the required level hence it provides margin to the limit.

### Manufacturer’s Statement Regarding Uniform Channel Spreading

The end product implements an automatic channel selection feature at startup such that operation commences on channels distributed across the entire set of allowed 5GHz channels. This feature will ensure uniform spreading is achieved while avoiding non-allowed channels due to prior radar events.

**TEST AND MEASUREMENT SYSTEM**

**System Overview**

The measurement system is based on a conducted test method.

The short pulse and long pulse signal generating system utilizes the NTIA software. The Vector Signal Generator has been validated by the NTIA. The hopping signal generating system utilizes the CCS simulated hopping method and system, which has been validated by the DoD, FCC and NTIA. The software selects waveform parameters from within the bounds of the signal type on a random basis using uniform distribution. The short pulse types 2, 3 and 4, and the long pulse type 5 parameters are randomized at run-time.

The hopping type 6 pulse parameters are fixed while the hopping sequence is based on the August 2005 NTIA Hopping Frequency List. The initial starting point randomized at run-time and each subsequent starting point is incremented by 475. Each frequency in the 100-length segment is compared to the boundaries of the EUT Detection Bandwidth and the software creates a hopping burst pattern in accordance with Section 7.4.1.3 Method #2 Simulated Frequency Hopping Radar Waveform Generating Subsystem of FCC 06-96 APPENDIX. The frequency of the signal generator is incremented in 1 MHz steps from FL to FH for each successive trial. This incremental sequence is repeated as required to generate a minimum of 30 total trials and to maintain a uniform frequency distribution over the entire Detection Bandwidth.

The signal monitoring equipment consists of a spectrum analyzer set to display 8001 bins on the horizontal axis. The time-domain resolution is 2 msec / bin with a 16 second sweep time, meeting the 10 second short pulse reporting criteria. The aggregate ON time is calculated by multiplying the number of bins above a threshold during a particular observation period by the dwell time per bin, with the analyzer set to peak detection and max hold. The time-domain resolution is 3 msec / bin with a 24 second sweep time, meeting the 22 second long pulse reporting criteria and allowing a minimum of 10 seconds after the end of the long pulse waveform.

Should multiple RF ports be utilized for the Master and/or Slave devices (for example, for diversity or MIMO implementations), 50 ohm termination would be removed from the splitter so that connection can be established between splitter and the Master and/or Slave devices.

**Conducted Method System Block Diagram**

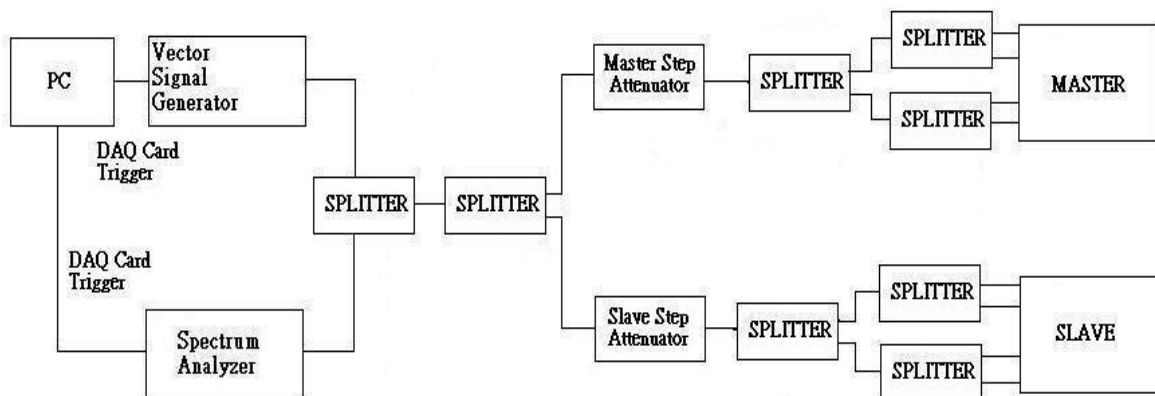

Report No.: T181222W01-RP4

### **System Calibration**

Connect the spectrum analyzer to the test system in place of the master device. Set the signal generator to CW mode. Adjust the amplitude of the signal generator to yield a measured level of  $-62$  dBm on the spectrum analyzer.

Without changing any of the instrument settings, reconnect the spectrum analyzer to the Common port of the Spectrum Analyzer Combiner/Divider and connect a 50 ohm load to the Master Device port of the test system.

Measure the amplitude and calculate the difference from  $-62$  dBm. Adjust the Reference Level Offset of the spectrum analyzer to this difference. Confirm that the signal is displayed at  $-62$  dBm. Readjust the RBW and VBW to 3 MHz, set the span to 10 MHz, and confirm that the signal is still displayed at  $-62$  dBm.

The spectrum analyzer displays the level of the signal generator as received at the antenna ports of the Master Device. The interference detection threshold may be varied from the calibrated value of  $-62$  dBm and the spectrum analyzer will still indicate the level as received by the Master Device.

Set the signal generator to produce a radar waveform, trigger a burst manually and measure the level on the spectrum analyzer. Readjust the amplitude of the signal generator as required so that the peak level of the waveform is at a displayed level equal to the required or desired interference detection threshold. Separate signal generator amplitude settings are determined as required for each radar type.

### **Adjustment Of Displayed Traffic Level**

Establish a link between the Master and Slave, adjusting the Link Step Attenuator as needed to provide a suitable received level at the Master and Slave devices. Stream the video test file to generate WLAN traffic. Confirm that the WLAN traffic level, as displayed on the spectrum analyzer, is at lower amplitude than the radar detection threshold. Confirm that the displayed traffic is from the Master Device. For Master Device testing confirm that the displayed traffic does not include Slave Device traffic. For Slave Device testing confirm that the displayed traffic does not include Master Device traffic.

If a different setting of the Master Step Attenuator is required to meet the above conditions, perform a new System Calibration for the new Master Step Attenuator setting.

### 4.7.3 Test Setup

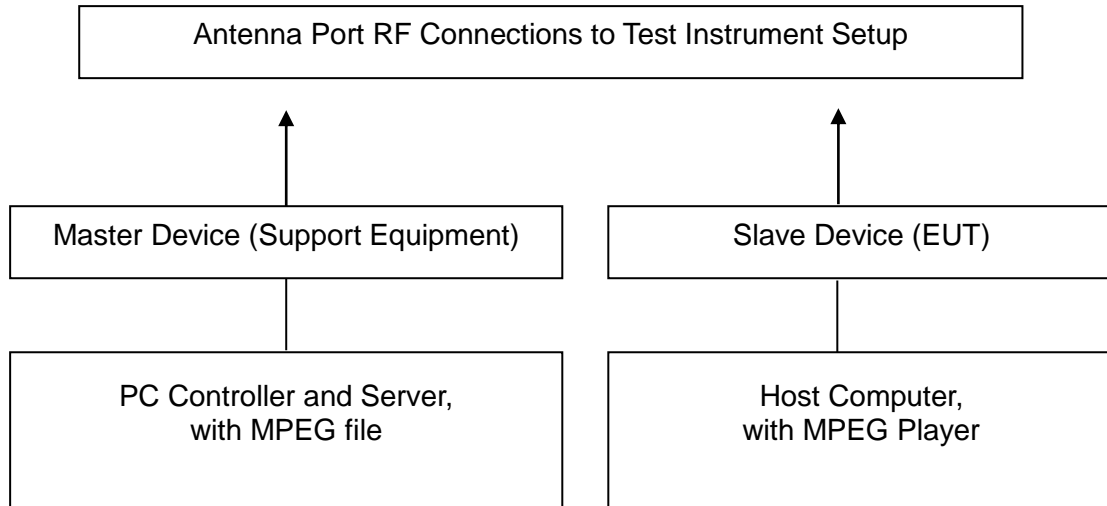

4.7.4 Test Result

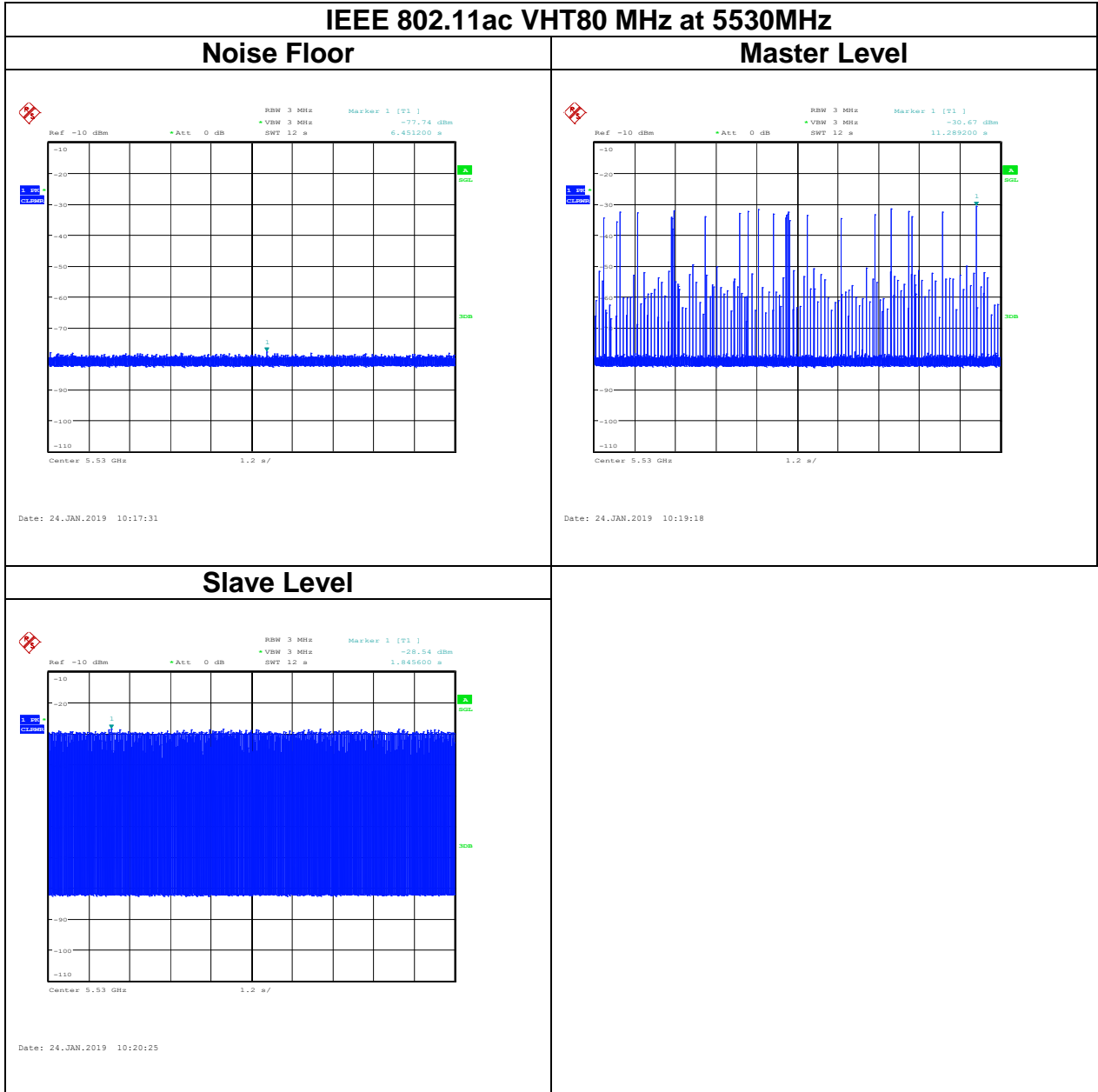



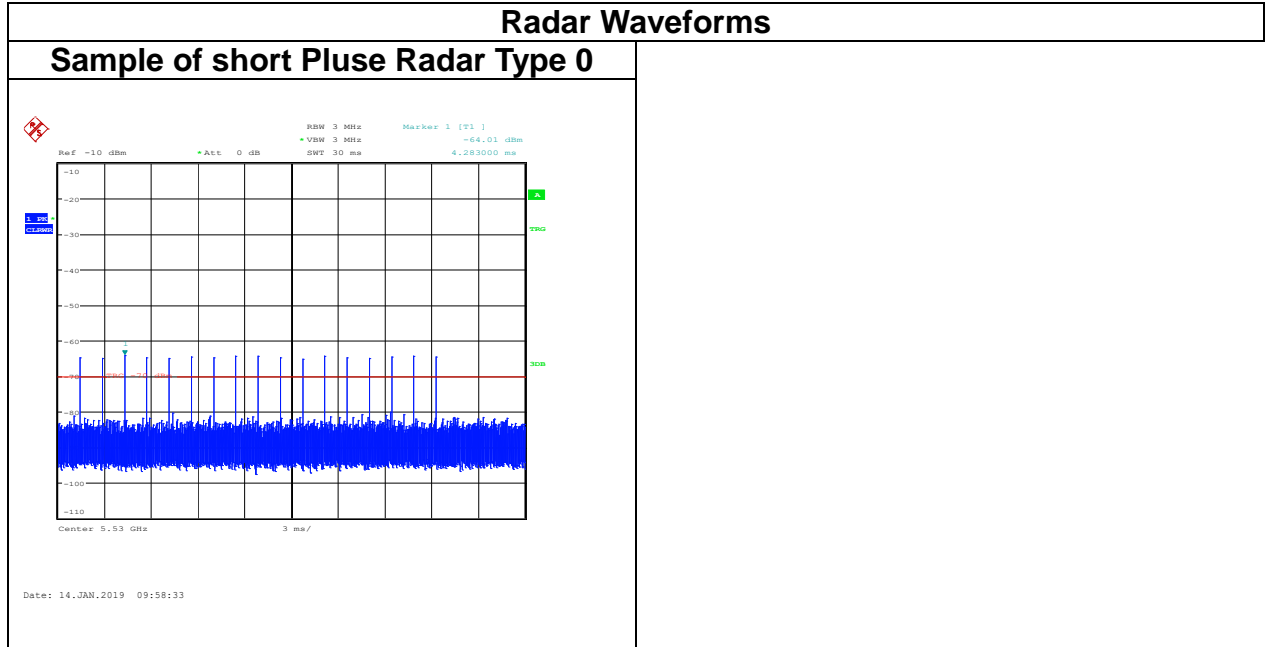



Report No.: T181222W01-RP4

Page: 232 / 234  
Rev.: 00

## **TEST CHANNEL AND METHOD**

All tests were performed at a channel center frequency of 5530 MHz utilizing a conducted test method.

## **CHANNEL MOVE TIME AND CHANNEL CLOSING TRANSMISSION TIME**

### **GENERAL REPORTING NOTES**

The reference marker is set at the end of last radar pulse.

The delta marker is set at the end of the last WLAN transmission following the radar pulse. This delta is the channel move time.

The aggregate channel closing transmission time is calculated as follows:

Aggregate Transmission Time =

(Number of analyzer bins showing transmission) \* (dwell time per bin)

The observation period over which the aggregate time is calculated

Begins at (Reference Marker + 200 msec) and

Ends no earlier than (Reference Marker + 10 sec).

Report No.: T181222W01-RP4

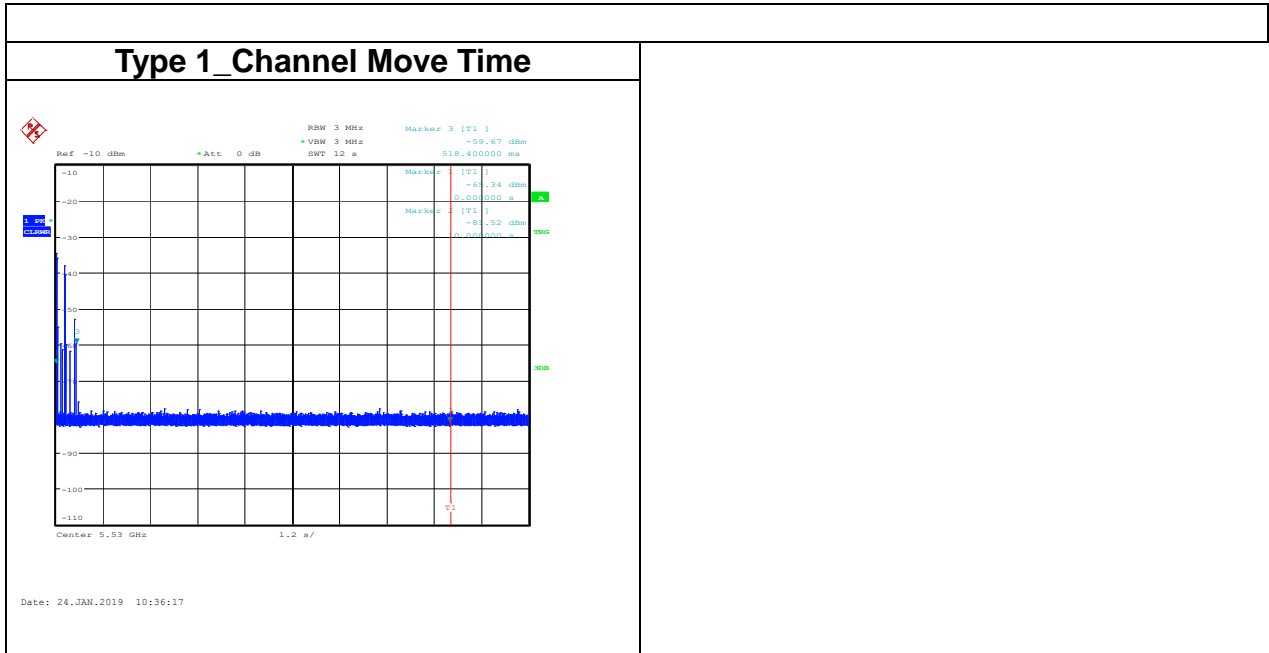

Channel Move Time (ms)	Limit (s)
518.4	10

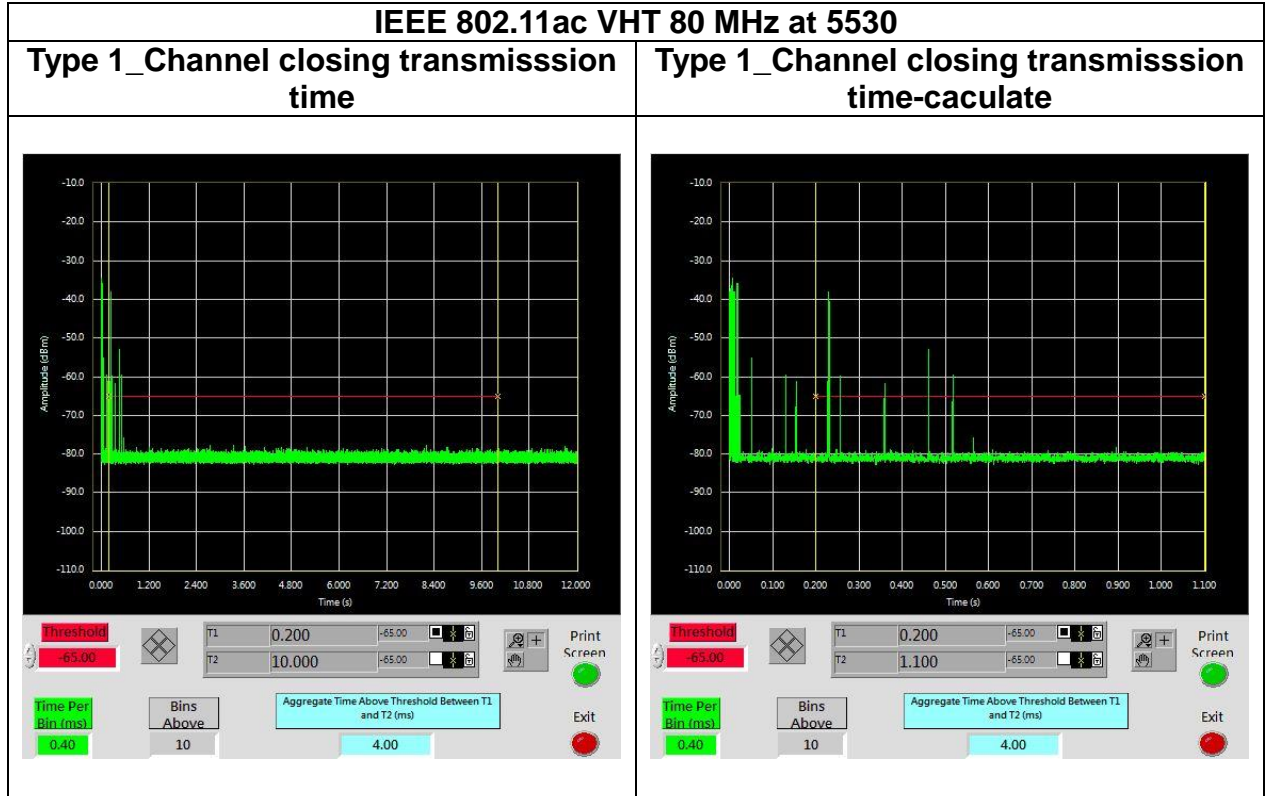

Aggregate Transmission Time (ms)	Limit (ms)	Margin (ms)
4.00	60	-56

--End Report--