

FCC RADIO TEST REPORT

according to

47 CFR FCC Part 15 Subpart C § 15.225

Equipment : RFID module
Brand Name : TI
Model No. : TRF7960
Filing Type : New Application
Applicant : **Getac Technology Corporation.**
5F., Building A, No. 209, Sec. 1, Nangang Rd., Nangang
Dist., Taipei City 11568, Taiwan, R.O.C.
FCC ID : QYLV110RFID
Manufacturer : **Getac Technology (Kunshan) Co., LTD.**
No. 269, No. 2 Avenue, Kunshan Comprehensive Free
Trade Zone, Jiangsu Province, P.R.C
Received Date : Sep. 18, 2013
Final Test Date : Oct. 31, 2013

Statement

The test result in this report refers exclusively to the presented test model / sample.

Without written approval of SPORTON International Inc., the test report shall not be reproduced except in full.

The measurements and test results shown in this test report were made in accordance with the procedures and found in compliance with the limit given in **ANSI C63.4-2003** and **47 CFR FCC Part 15 Subpart C**.

The test equipment used to perform the test is calibrated and traceable to NML/ROC.



SPORTON INTERNATIONAL INC.

No. 52, Hwa Ya 1st Rd., Hwa Ya Technology Park, Kwei-Shan Hsiang, Tao Yuan Hsien, Taiwan, R.O.C.

Table of Contents

1. SUMMARY OF THE TEST RESULT1

2. GENERAL INFORMATION.....2

 2.1 Product Details2

 2.2 Table for Test Modes3

 2.3 Table for Testing Locations3

 2.4 Table for Supporting Units.....4

 2.5 Test Configurations5

3. TEST RESULT6

 3.1 AC Power Line Conducted Emissions Measurement6

 3.2 Field Strength of Fundamental Emissions and Mask Measurement11

 3.3 20dB Spectrum Bandwidth Measurement.....15

 3.4 Radiated Emissions Measurement17

 3.5 Frequency Stability Measurement.....24

 3.6 Antenna Requirements.....27

4. LIST OF MEASURING EQUIPMENT28

5. TEST LOCATION.....29

6. TAF CERTIFICATE OF ACCREDITATION.....30

APPENDIX A. SETUP PHOTOGRAPHS

REVISION HISTORY

REPORT NO.	VERSION	DESCRIPTION	ISSUED DATE
FR391853	Rev. 01	Initial issue of report	Nov. 14, 2013

CERTIFICATE OF COMPLIANCE

according to

47 CFR FCC Part 15 Subpart C § 15.225

Equipment : RFID module
Brand Name : TI
Model No. : TRF7960
Applicant : Getac Technology Corporation.

5F., Building A, No. 209, Sec. 1, Nangang Rd., Nangang
Dist., Taipei City 11568, Taiwan, R.O.C.

Sporton International as requested by the applicant to evaluate the EMC performance of the product sample received on Sep. 18, 2013 would like to declare that the tested sample has been evaluated and found to be in compliance with the tested rule parts. The data recorded as well as the test configuration specified is true and accurate for showing the sample's EMC nature.



Reviewed by: Joseph Lin / Supervisor

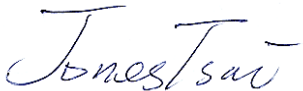

Approved by: Jones Tsai / Manager

SPORTON INTERNATIONAL INC.

No. 52, Hwa Ya 1st Rd., Hwa Ya Technology Park, Kwei-Shan Hsiang, Tao Yuan Hsien, Taiwan, R.O.C.



1. SUMMARY OF THE TEST RESULT

Applied Standard: 47 CFR FCC Part 15 Subpart C					
Part	FCC Rule	IC Rule	Description of Test	Result	Under Limit
3.1	15.207	Gen 7.2.2	AC Power Line Conducted Emissions	Complies	1.20dB at 13.558MHz
3.2	15.225(a)(b)(c)	A2.6	Field Strength of Fundamental Emissions	Complies	64.51dB at 13.56MHz
3.3	2.1049	-	20dB Spectrum Bandwidth	Complies	-
3.4	15.225(d) 15.209	A2.6	Radiated Emissions	Complies	10.57dB at 1.190MHz
3.5	15.225(e)	A2.6	Frequency Stability	Complies	-
3.6	15.203	-	Antenna Requirements	Complies	-

Test Items	Uncertainty	Remark
AC Power Line Conducted Emissions	2.26dB	Confidence levels of 95%
Radiated Emissions (30MHz~1000MHz)	4.5dB	Confidence levels of 95%



2. GENERAL INFORMATION

2.1 Product Details

For more detailed features description, please refer to the manufacturer's specifications or user's manual.

Items	Description
Power Type	19Vdc from Adapter
Modulation	ASK
Channel Number	1
Installed into Tablet	Brand Name: Getac Model Name: V110 Marketing Name: V110
Channel Band Width (99%)	2.240kHz
Max. Field Strength	59.49dB μ V/m
Test Freq. Range	13.553 ~ 13.567MHz
Carrier Frequencies	13.56 MHz (Ch. 1)
Antenna	Fixed Internal Antenna (Without any antenna connector)

2.2 Table for Test Modes

Investigation has been done on all the possible configurations for searching the worst cases. The following table is a list of the test modes shown in this test report.

Test Items	Mode	Channel
AC Power Line Conducted Emissions	CTX	-
Field Strength of Fundamental Emissions	CTX	1
20dB Spectrum Bandwidth	CTX	1
Radiated Emissions 9kHz~30MHz	CTX	1
Radiated Emissions 9kHz~10 th Harmonic Band Edge Emissions	CTX	1
Frequency Stability	Un-modulation	1

Note:

1. CTX=continuously transmitting.
2. The ancillary equipment, NFC card, is used to make the EUT (NFC) continuously transmit at 13.56MHz and is placed around 3 cm gap to the EUT.

2.3 Table for Testing Locations

Test Site No.	Site Category	Location
CO05-HY	Conduction	Hwa Ya
TH02-HY	OVEN Room	Hwa Ya
03CH07-HY	SAC	Hwa Ya

Semi Anechoic Chamber (SAC).



2.4 Table for Supporting Units

Item	Equipment	Trade Name	Model Name	FCC ID	Data Cable	Power Cord
1.	GPS Station	Pendulum	GSG-54	N/A	N/A	Unshielded, 1.8 m
2.	Bluetooth Earphone	Sony Ericsson	MW600	PY7DDA-2029	N/A	N/A
3.	WLAN AP	D-Link	DIR-628	KA2DIR628A2	N/A	Unshielded, 1.8 m
4.	Notebook	DELL	Latitude E6320	FCC DoC	Unshielded, 3.0m	AC I/P: Unshielded, 1.2 m DC O/P: Shielded, 1.8 m
5.	LCD Monitor	DELL	U2410	FCC DoC	Shielded, 1.6 m	Unshielded, 1.8 m
6.	USB HD	WD	WDBAAR320 0ABK-PESN	FCC DoC	Unshielded, 0.5 m	N/A
7.	SD Card	SanDisk	MicroSD HC	FCC DoC	N/A	N/A
8.	NFC Card	N/A	N/A	N/A	N/A	N/A
9.	MODEM	ACEEX	DM1414	IFAXDM141	D-Shielded, 1.15 m	Unshielded, 1.8 m
10.	iPod Earphone	Apple	N/A	Verification	Shielded, 1.0 m	N/A

2.5 Test Configurations

<AC Conducted Emissions>

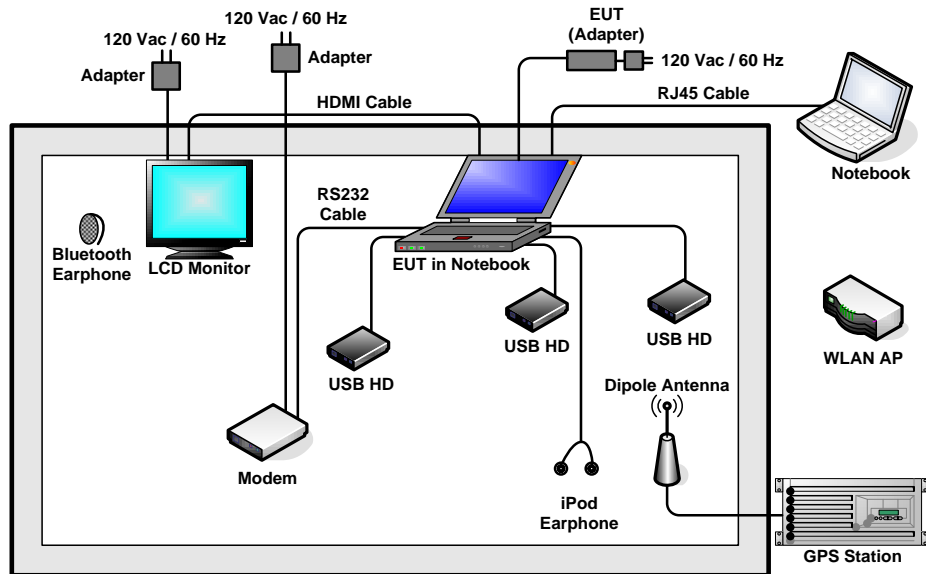

Fundamental Emissions and Mask Measurement

For radiated emissions 9kHz~30MHz

For radiated emissions 30MHz~1GHz

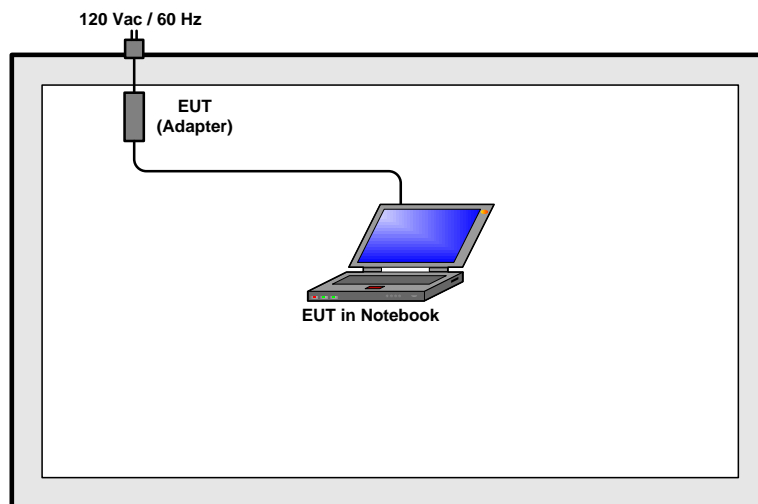

3. TEST RESULT

3.1 AC Power Line Conducted Emissions Measurement

3.1.1 Limit

For a Low-power Radio-frequency device which is designed to be connected to the AC power line, the radio frequency voltage that is conducted back onto the AC power line on any frequency or frequencies within the band 150 kHz to 30 MHz shall not exceed below limits table.

Frequency (MHz)	QP Limit (dB μ V)	AV Limit (dB μ V)
0.15~0.5	66~56	56~46
0.5~5	56	46
5~30	60	50

3.1.2 Measuring Instruments and Setting

Please refer to section 4 of equipments list in this report. The following table is the setting of the receiver.

Receiver Parameters	Setting
Attenuation	10 dB
Start Frequency	0.15 MHz
Stop Frequency	30 MHz
IF Bandwidth	9 kHz

3.1.3 Test Procedures

1. Configure the EUT according to ANSI C63.4. The EUT or host of EUT has to be placed 0.4 meter far from the conducting wall of the shielding room and at least 80 centimeters from any other grounded conducting surface.
2. Connect EUT or host of EUT to the power mains through a line impedance stabilization network (LISN).
3. All the support units are connected to the other LISNs. The LISN should provide 50uH/50ohms coupling impedance.
4. The frequency range from 150 kHz to 30 MHz was searched.
5. Set the test-receiver system to Peak Detect Function and Specified Bandwidth with Maximum Hold Mode.
6. The measurement has to be done between each power line and ground at the power terminal.

3.1.4 Test Setup Layout

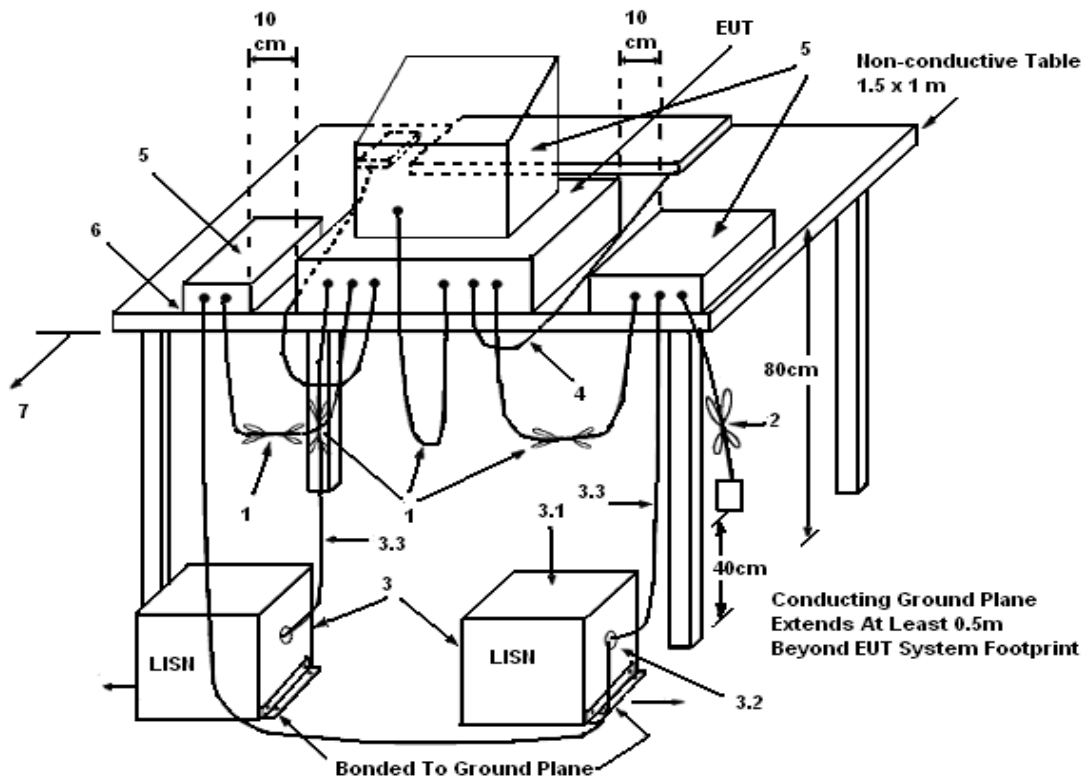

LEGEND:

- (1) Interconnecting cables that hang closer than 40 cm to the ground plane shall be folded back and forth in the center forming a bundle 30 to 40 cm long.
- (2) I/O cables that are not connected to a peripheral shall be bundled in the center. The end of the cable may be terminated, if required, using the correct terminating impedance. The overall length shall not exceed 1 m.
- (3) EUT connected to one LISN. Unused LISN measuring port connectors shall be terminated in 50 Ω. LISN can be placed on top of, or immediately beneath, reference ground plane.
 - (3.1) All other equipment powered from additional LISN(s).
 - (3.2) Multiple outlet strip can be used for multiple power cords of non-EUT equipment.
 - (3.3) LISN at least 80 cm from nearest part of EUT chassis.
- (4) Cables of hand-operated devices, such as keyboards, mice, etc., shall be placed as for normal use.
- (5) Non-EUT components of EUT system being tested.
- (6) Rear of EUT, including peripherals, shall all be aligned and flush with rear of tabletop.
- (7) Rear of tabletop shall be 40 cm removed from a vertical conducting plane that is bonded to the ground plane.



3.1.5 Test Deviation

There is no deviation with the original standard.

3.1.6 EUT Operation during Test

The EUT was placed on the test table and programmed in transmitting function.

3.1.7 Results of AC Power Line Conducted Emissions Measurement

Final Test Date	Oct. 03, 2013	Test Site No.	CO05-HY
Temperature	20~22°C	Humidity	45~47%
Test Engineer	Kai-Chun Chu	Configuration	Transmitting Mode (13.56MHz)
Mode	WLAN (2.4GHz) Link + TF + TC		
Remark			
1. TC stands for Test Configuration, and consists of Earphone, Adapter 1, USB HD, RJ-45 Link, RS232 (Load with Modem), and LCD Monitor.			
2. TF stands for Test Function, and consists of GPS Rx, Camera, MPEG4, H Pattern, NFC On, and Bluetooth Link.			

Line

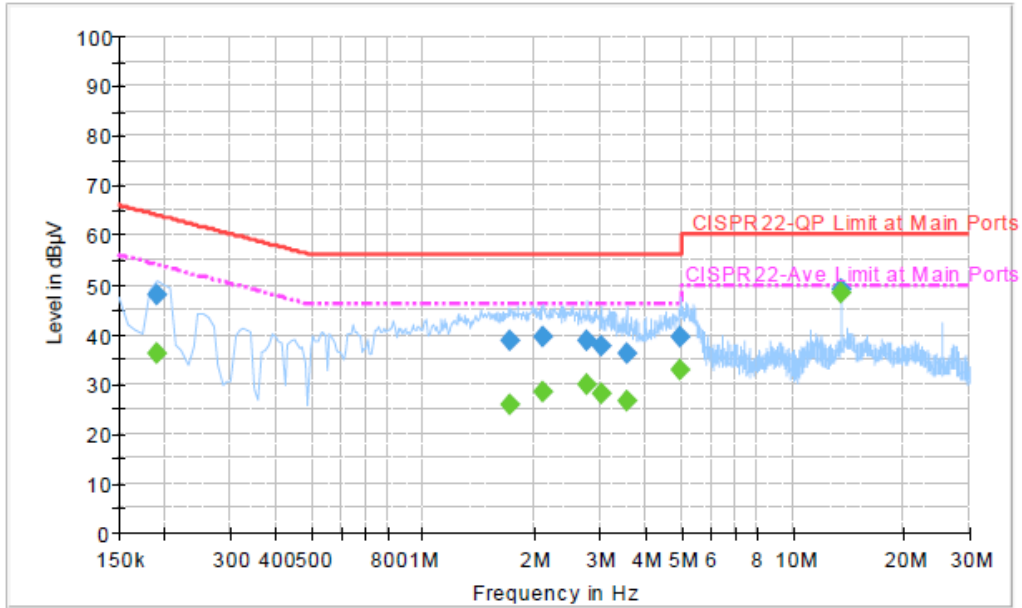

Final Result: Quasi-Peak

Frequency (MHz)	Quasi-Peak (dBµV)	Filter	Line	Corr. (dB)	Margin (dB)	Limit (dBµV)
0.190000	47.9	Off	L1	19.4	16.1	64.0
1.718000	38.8	Off	L1	19.5	17.2	56.0
2.118000	39.3	Off	L1	19.5	16.7	56.0
2.774000	38.6	Off	L1	19.6	17.4	56.0
3.022000	37.5	Off	L1	19.6	18.5	56.0
3.550000	36.1	Off	L1	19.6	19.9	56.0
4.974000	39.5	Off	L1	19.7	16.5	56.0
13.558000	49.0	Off	L1	19.8	11.0	60.0

Final Result: Average

Frequency (MHz)	Average (dBµV)	Filter	Line	Corr. (dB)	Margin (dB)	Limit (dBµV)
0.190000	36.1	Off	L1	19.4	17.9	54.0
1.718000	26.0	Off	L1	19.5	20.0	46.0
2.118000	28.5	Off	L1	19.5	17.5	46.0
2.774000	29.9	Off	L1	19.6	16.1	46.0
3.022000	28.2	Off	L1	19.6	17.8	46.0
3.550000	26.5	Off	L1	19.6	19.5	46.0
4.974000	32.7	Off	L1	19.7	13.3	46.0
13.558000	48.5	Off	L1	19.8	1.5	50.0

Neutral

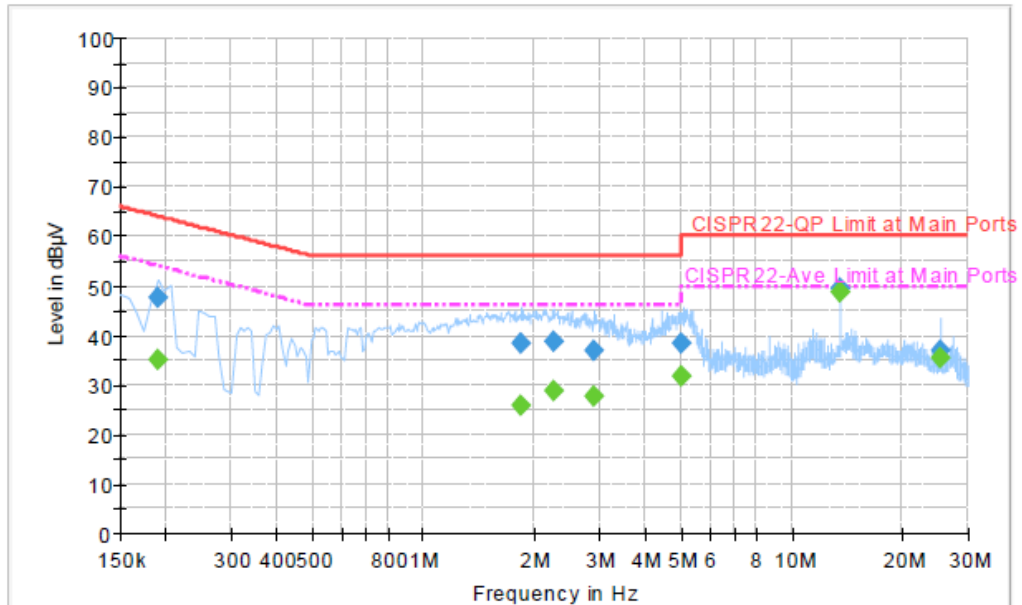

Final Result: Quasi-Peak

Frequency (MHz)	Quasi-Peak (dBµV)	Filter	Line	Corr. (dB)	Margin (dB)	Limit (dBµV)
0.190000	47.5	Off	N	19.4	16.5	64.0
1.846000	38.5	Off	N	19.5	17.5	56.0
2.246000	38.9	Off	N	19.6	17.1	56.0
2.894000	36.9	Off	N	19.7	19.1	56.0
4.998000	38.3	Off	N	19.7	17.7	56.0
13.558000	49.3	Off	N	19.9	10.7	60.0
25.230000	36.8	Off	N	20.1	23.2	60.0

Final Result: Average

Frequency (MHz)	Average (dBµV)	Filter	Line	Corr. (dB)	Margin (dB)	Limit (dBµV)
0.190000	35.1	Off	N	19.4	18.9	54.0
1.846000	25.8	Off	N	19.5	20.2	46.0
2.246000	28.8	Off	N	19.6	17.2	46.0
2.894000	27.7	Off	N	19.7	18.3	46.0
4.998000	31.6	Off	N	19.7	14.4	46.0
13.558000	48.8	Off	N	19.9	1.2	50.0
25.230000	35.6	Off	N	20.1	14.4	50.0

Note: Level = Read Level + LISN Factor + Cable Loss.

3.2 Field Strength of Fundamental Emissions and Mask Measurement

3.2.1 Limit

Field strength of fundamental emissions limit:

The field strength of fundamental emissions shall not exceed 15848 microvolts/meter at 30 meters.

The emissions limit in this paragraph is based on measurement instrumentation employing a QP detector.

Frequencies (MHz)	Field Strength (microvolts/meter)	Field Strength (dBµV/m) at 10m	Field Strength (dBµV/m) at 3m
13.553 ~ 13.567MHz	15848 at 30m	103.08 (QP)	124 (QP)

Mask limit:

Rules and specifications	CFR 47 Part 15 section 15.225(a)-(d)				
Description	Compliance with the spectrum mask is tested using a spectrum analyzer with RBW set to a 9kHz for the band 13.553~13.567MHz				
Limit	Freq. of Emission (MHz)	Field Strength (µV/m) at 30m	Field Strength (dBµV/m) at 30m	Field Strength (dBµV/m) at 10m	Field Strength (dBµV/m) at 3m
	1.705~13.110	30	29.5	48.58	69.5
	13.110~13.410	106	40.5	59.58	80.5
	13.410~13.553	334	50.5	69.58	90.5
	13.553~13.567	15848	84.0	103.08	124.0
	13.567~13.710	334	50.5	69.58	90.5
	13.710~14.010	106	40.5	59.58	80.5
	14.010~30.000	30	29.5	48.58	69.5

3.2.2 Measuring Instruments and Setting

Please refer to section 4 of equipments list in this report. The following table is the setting of the receiver.

Receiver Parameter	Setting
Attenuation	Auto
Center Frequency	Fundamental Frequency
RBW	9 kHz
Detector	QP

3.2.3 Test Procedures

1. Configure the EUT according to ANSI C63.4. The EUT was placed on the top of the turntable 0.8 meter above ground. The phase center of the loop receiving antenna mounted antenna tower was placed 3 meters far away from the turntable.
2. Power on the EUT and all the supporting units. The turntable was rotated by 360 degrees to determine the position of the highest radiation.
3. The height of the receiving antenna was fixed at one meter above ground to find the maximum emissions field strength.
4. For Fundamental emissions, use the receiver to measure QP reading.
5. When the radiated emissions limits are expressed in terms of the average value of the emissions, and pulsed operation is employed, the measurement field strength shall be determined by averaging over one complete pulse train, including blanking intervals, as long as the pulse train does not exceed 0.1 seconds. As an alternative (provided the transmitter operates for longer than 0.1 seconds) or in cases where the pulse train exceeds 0.1 seconds, the measured field strength shall be determined from the average absolute voltage during a 0.1 second interval during which the field strength is at its maximum value.
6. Compliance with the spectrum mask is tested using a spectrum analyzer with RBW set to a 1kHz for the band 13.553~13.567MHz.

3.2.4 Test Setup Layout

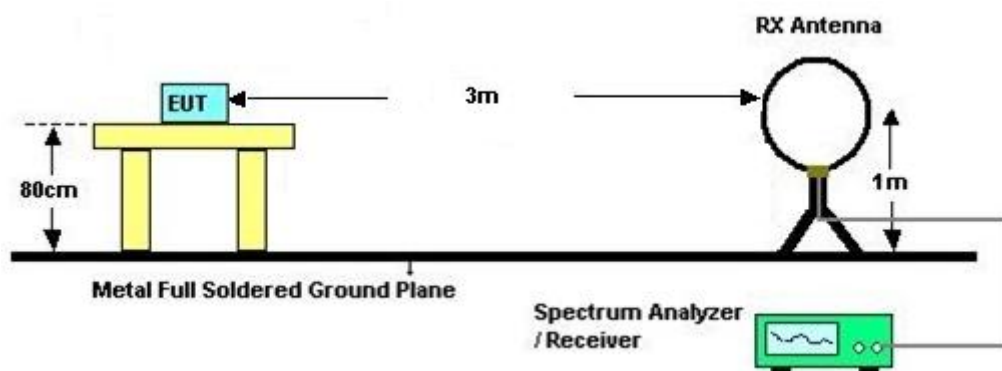

3.2.5 Test Deviation

There is no deviation with the original standard.

3.2.6 EUT Operation during Test

The EUT was programmed to be in continuously transmitting mode.



3.2.7 Test Result of Field Strength of Fundamental Emissions

Final Test Date	Oct. 28, 2013 ~ Oct. 31, 2013	Test Site No.	03CH07-HY
Temperature	22~24°C	Humidity	51% ~ 53%
Test Engineer	Eric Shih	Configurations	Ch. 1

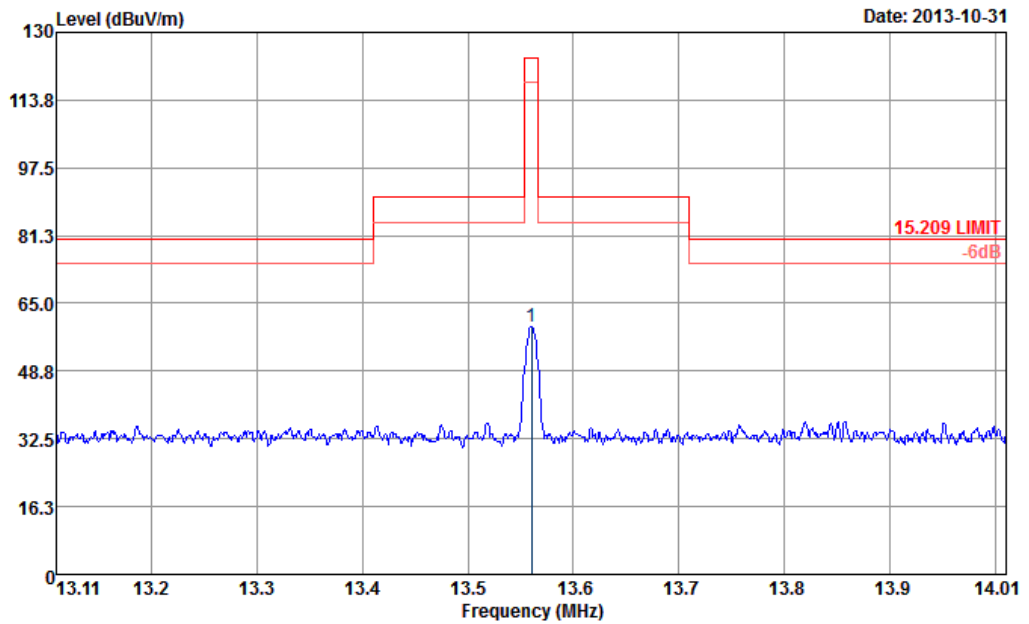

Site : 03CH07-HY
 Condition : 15.209 LIMIT 3m NFC FACTOR(120912)-H HORIZONTAL
 Project : FR 391853
 Mode : 1

Freq	Level	Over Limit	Limit Line	ReadAntenna Level	Antenna Factor	Cable Loss	Preamp Factor	A/Pos	T/Pos	Remark
MHz	dBuV/m	dB	dBuV/m	dBuV	dB/m	dB	dB	cm	deg	
1	13.56	59.49	-64.51	124.00	39.34	19.75	0.40	0.00	100	9 QP

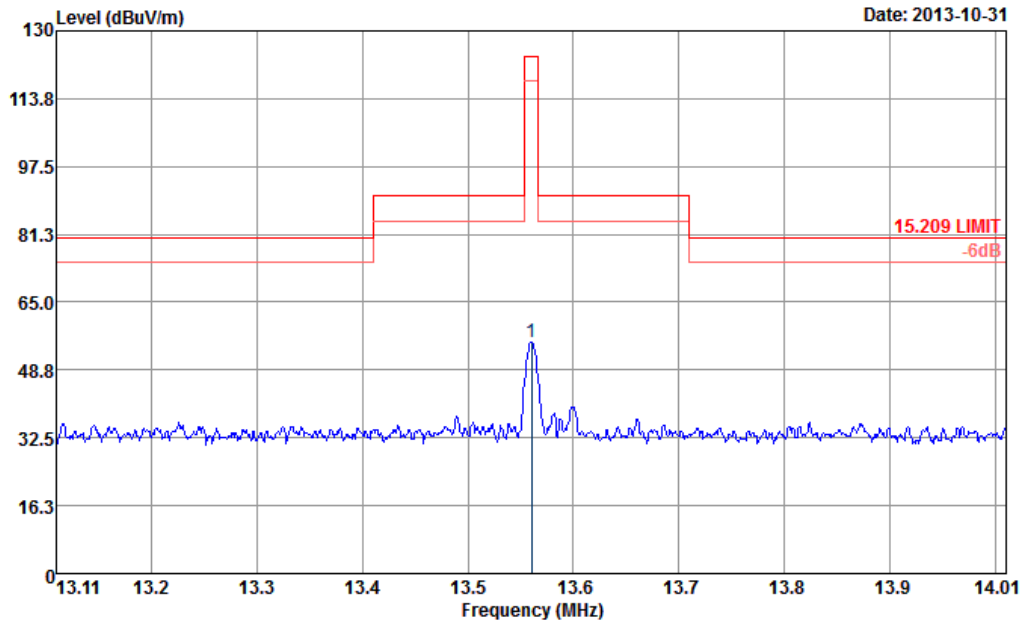

Site : 03CH07-HY
 Condition : 15.209 LIMIT 3m NFC FACTOR(120912)-V VERTICAL
 Project : FR 391853
 Mode : 1

Freq	Level	Over	Limit	ReadAntenna	Cable	Preamp	A/Pos	T/Pos	Remark
MHz	dBuV/m	dB	dBuV/m	dBuV	dB/m	dB	dB	cm	deg
1	13.56	55.43	-68.57	124.00	35.28	19.75	0.40	0.00	100 92 QP

Note:

Emission level (dBμV/m) = 20 log Emission level (μV/m).

Measured distance is 3m.

All emissions emit form non-NFC function of digital unintentional emissions. All NFC's spurious emissions are below 20dB of limits.

3.3 20dB Spectrum Bandwidth Measurement

3.3.1 Limit

Intentional radiators must be designed to ensure that the 20 dB bandwidth of the emissions in the specific band (13.553 ~ 13.567MHz).

3.3.2 Measuring Instruments and Setting

Please refer to section 4 of equipments list in this report. The following table is the setting of the spectrum analyzer.

Spectrum Parameters	Setting
Attenuation	Auto
Span Frequency	> 20dB Bandwidth
RBW	1 kHz
VBW	3 kHz
Detector	Peak
Trace	Max Hold
Sweep Time	Auto

3.3.3 Test Procedures

1. The transmitter output (antenna port) was connected to the spectrum analyzer in peak hold mode.
2. The resolution bandwidth of 1 kHz and the video bandwidth of 3 kHz were used.
3. Measured the spectrum width with power higher than 20dB below carrier.

3.3.4 Test Setup Layout

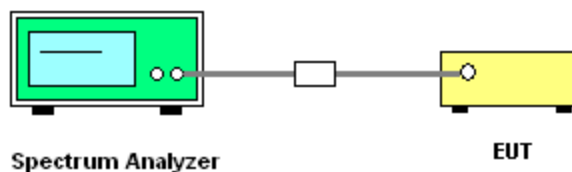

3.3.5 Test Deviation

There is no deviation with the original standard.

3.3.6 EUT Operation during Test

The EUT was programmed to be in continuously transmitting mode.

3.3.7 Test Result of 20dB Spectrum Bandwidth

Final Test Date	Oct. 30, 2013 ~ Oct. 31, 2013	Test Site No.	TH02-HY
Temperature	22~24°C	Humidity	53~55%
Test Engineer	Tommy Lee	Configurations	Ch. 1

Frequency	20dB BW (kHz)	99% OBW (kHz)	Frequency range (MHz) $f_L > 13.553\text{MHz}$	Frequency range (MHz) $f_H < 13.567\text{MHz}$	Test Result
13.56 MHz	2.640	2.240	13.55864	13.56128	Complies

20 dB / 99% Bandwidth Plot on 13.56 MHz

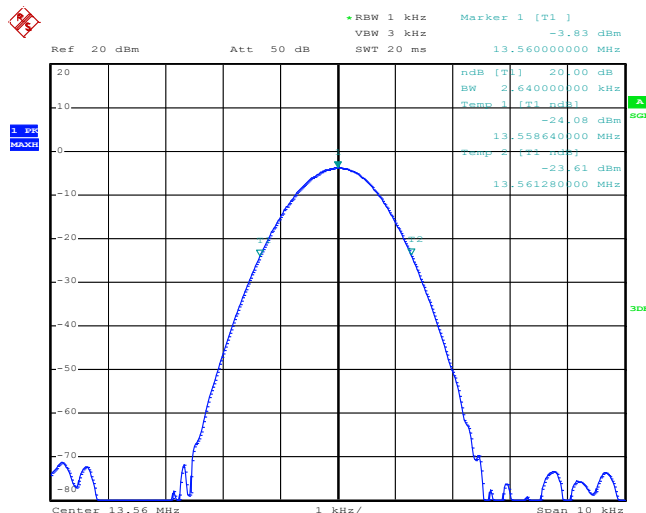

Date: 30.OCT.2013 18:13:43

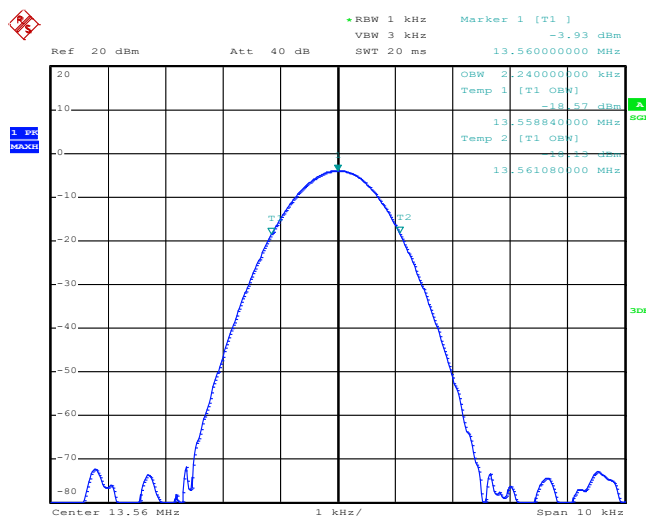

Date: 31.OCT.2013 13:52:56

3.4 Radiated Emissions Measurement

3.4.1 Limit

The field strength of any emissions which appear outside of 13.553 ~ 13.567MHz band shall not exceed the general radiated emissions limits.

Frequencies (MHz)	Field Strength (μV/m)	Measurement Distance (meters)
0.009~0.490	2400/F(kHz)	300
0.490~1.705	24000/F(kHz)	30
1.705~30.0	30	30
30~88	100	3
88~216	150	3
216~960	200	3
Above 960	500	3

3.4.2 Measuring Instruments and Setting

Please refer to section 4 of equipments list in this report. The following table is the setting of receiver.

Receiver Parameter	Setting
Attenuation	Auto
Start ~ Stop Frequency	9kHz~150kHz / RBW 200Hz for QP
Start ~ Stop Frequency	150kHz~30MHz / RBW 9kHz for QP
Start ~ Stop Frequency	30MHz~1000MHz / RBW 120kHz for Peak



3.4.3 Test Procedures

1. Configure the EUT according to ANSI C63.4. The EUT was placed on the top of the turntable 0.8 meter above ground. The phase center of the receiving antenna mounted on the top of a height-variable antenna tower was placed 3 meters far away from the turntable.
2. Power on the EUT and all the supporting units. The turntable was rotated by 360 degrees to determine the position of the highest radiation.
3. The height of the broadband receiving antenna was varied between one meter and four meters above ground to find the maximum emissions field strength of both horizontal and vertical polarization.
4. For each suspected emissions, the antenna tower was scan (from 1 M to 4 M) and then the turntable was rotated (from 0 degree to 360 degrees) to find the maximum reading.
5. Set the test-receiver system to Peak or CISPR quasi-peak Detect Function with specified bandwidth under Maximum Hold Mode.
6. When the radiated emissions limits are expressed in terms of the average value of the emissions, and pulsed operation is employed, the measurement field strength shall be determined by averaging over one complete pulse train, including blanking intervals, as long as the pulse train does not exceed 0.1 seconds. As an alternative (provided the transmitter operates for longer than 0.1 seconds) or in cases where the pulse train exceeds 0.1 seconds, the measured field strength shall be determined from the average absolute voltage during a 0.1 second interval during which the field strength is at its maximum value.
7. In case the emission is lower than 30MHz, loop antenna has to be used for measurement and the recorded data should be QP measured by receiver. High – Low scan is not required in this case.

3.4.4 Test Setup Layout

For radiated emissions below 30MHz

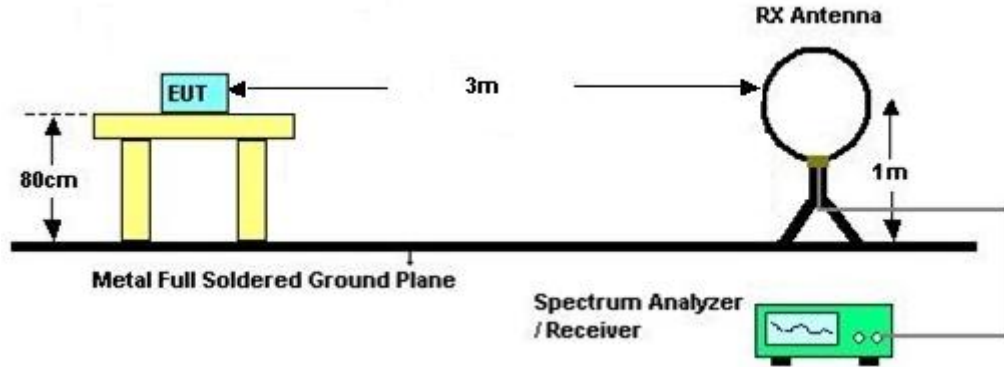

For radiated emissions above 30MHz

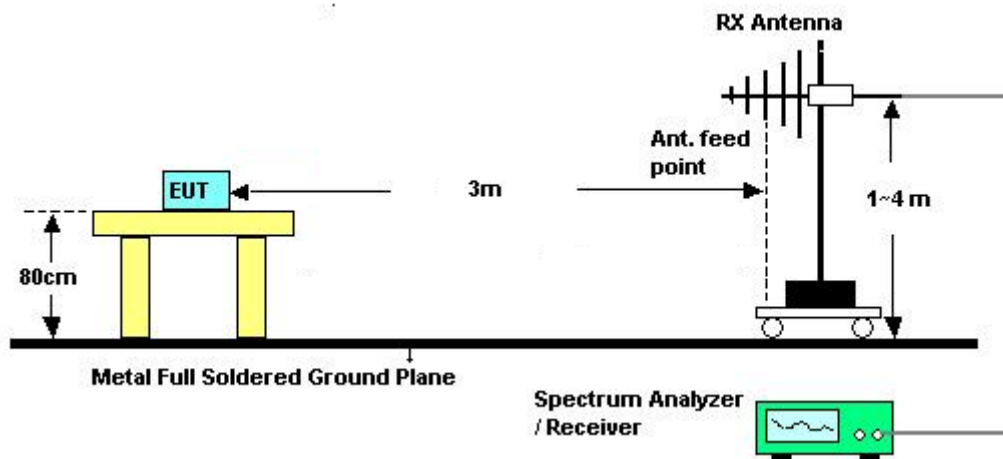

3.4.5 Test Deviation

There is no deviation with the original standard.

3.4.6 EUT Operation during Test

The EUT was programmed to be in continuously transmitting mode.



3.4.7 Results of Radiated Emissions (9 kHz~30MHz)

Final Test Date	Oct. 28, 2013 ~ Oct. 31, 2013	Test Site No.	03CH07-HY
Temperature	22~24°C	Humidity	51~53%
Test Engineer	Eric Shih	Configurations	Ch. 1

Horizontal

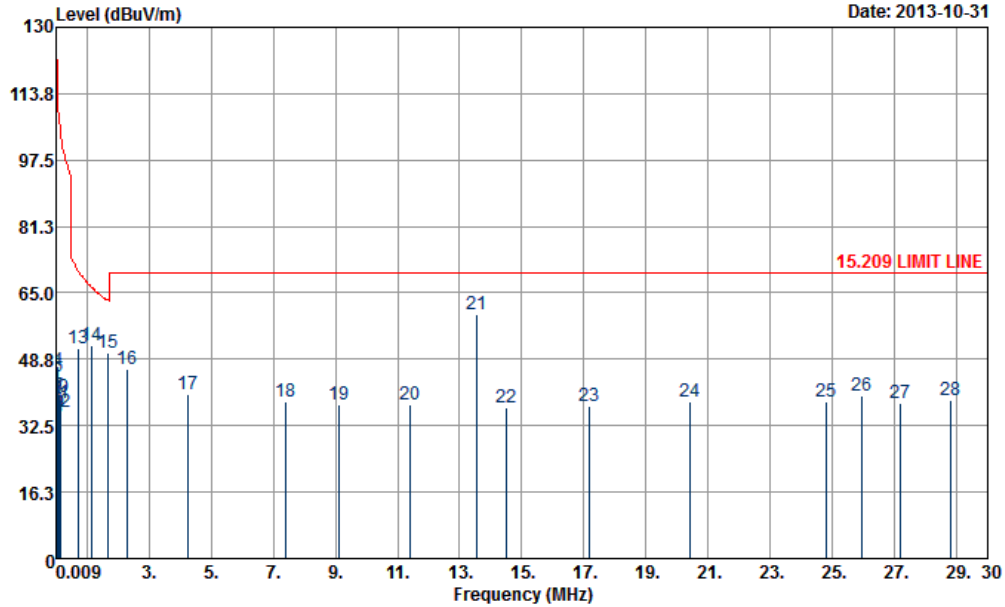

Site : 03CH07-HY
 Condition : 15.209 LIMIT LINE 3m NFC FACTOR(120912)-H HORIZONTAL
 Project : FR 391853
 Mode : 1

	Freq	Level	Over	Limit	Read	Antenna	Cable	Preamp	A/Pos	T/Pos	Remark
	MHz	dBuV/m	dB	dBuV/m	dBuV	dB/m	dB	dB	cm	deg	
1	0.02	42.30	-80.21	122.51	21.75	20.26	0.29	0.00	---	---	QP
2	0.04	39.01	-77.69	116.70	18.55	20.17	0.29	0.00	---	---	QP
3	0.05	37.94	-75.98	113.92	17.48	20.17	0.29	0.00	---	---	QP
4	0.06	45.95	-65.68	111.63	25.55	20.11	0.29	0.00	---	---	QP
5	0.07	44.65	-66.55	111.20	24.25	20.11	0.29	0.00	---	---	QP
6	0.08	36.73	-72.69	109.42	16.33	20.11	0.29	0.00	---	---	QP
7	0.10	39.94	-67.96	107.90	19.58	20.07	0.29	0.00	---	---	QP
8	0.10	34.25	-73.02	107.27	13.89	20.07	0.29	0.00	---	---	QP
9	0.11	35.51	-71.02	106.53	15.15	20.07	0.29	0.00	---	---	QP
10	0.13	39.45	-66.15	105.60	19.10	20.06	0.29	0.00	---	---	QP
11	0.13	37.99	-67.01	105.00	17.64	20.06	0.29	0.00	---	---	QP
12	0.15	35.73	-68.64	104.37	15.40	20.04	0.29	0.00	---	---	QP
13	0.73	51.37	-18.93	70.30	31.06	20.00	0.31	0.00	---	---	QP
14	1.16	52.19	-14.14	66.33	31.87	20.01	0.31	0.00	---	---	QP
15	1.66	50.17	-13.02	63.19	29.82	20.02	0.33	0.00	100	17	QP
16	2.30	46.46	-23.54	70.00	26.10	20.03	0.33	0.00	---	---	QP
17	4.24	40.20	-29.80	70.00	19.85	20.00	0.35	0.00	---	---	QP
18	7.38	38.46	-31.54	70.00	18.27	19.82	0.37	0.00	---	---	QP
19	9.12	37.53	-32.47	70.00	17.39	19.76	0.38	0.00	---	---	QP
20	11.42	37.55	-32.45	70.00	17.39	19.77	0.39	0.00	---	---	QP
21	13.57	59.82	-10.18	70.00	39.67	19.75	0.40	0.00	---	---	QP
22	14.50	36.87	-33.13	70.00	16.72	19.75	0.40	0.00	---	---	QP
23	17.16	37.45	-32.55	70.00	17.19	19.84	0.42	0.00	---	---	QP
24	20.40	38.45	-31.55	70.00	17.84	20.18	0.43	0.00	---	---	QP
25	24.79	38.20	-31.80	70.00	17.38	20.37	0.45	0.00	---	---	QP
26	25.93	39.68	-30.32	70.00	18.82	20.39	0.47	0.00	---	---	QP
27	27.19	37.88	-32.12	70.00	17.02	20.38	0.48	0.00	---	---	QP
28	28.82	38.70	-31.30	70.00	17.93	20.26	0.51	0.00	---	---	QP



Vertical

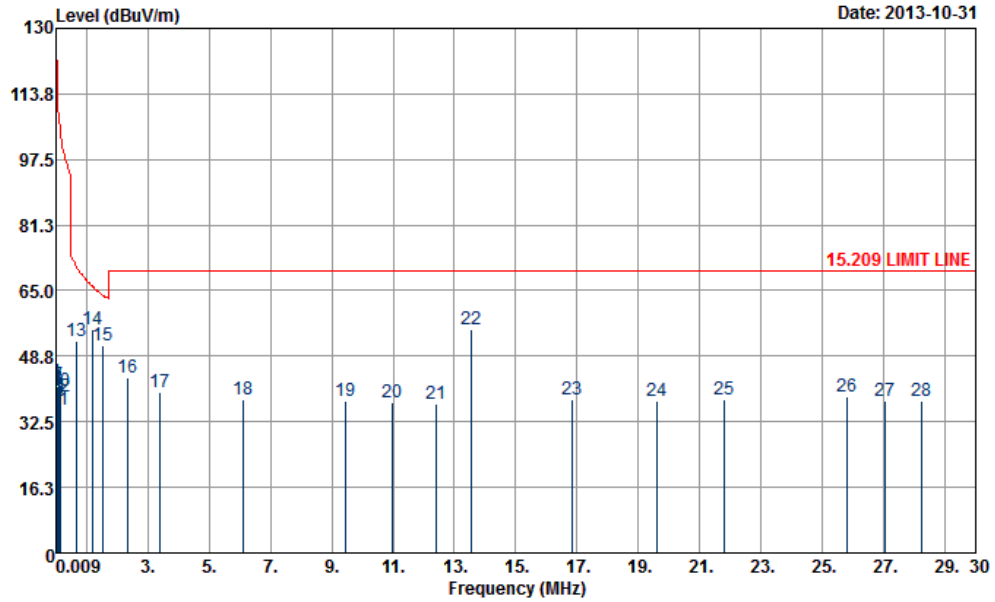

Site : 03CH07-HY
 Condition : 15.209 LIMIT LINE 3m NFC FACTOR(120912)-V VERTICAL
 Project : FR 391853
 Mode : 1

Line	Freq MHz	Level dBuV/m	Over Limit dB	Limit Line dBuV/m	Read Level dBuV	Antenna Factor dB/m	Cable Loss dB	Preamp Factor dB	A/Pos cm	T/Pos deg	Remark
1	0.02	42.51	-79.98	122.49	21.96	20.26	0.29	0.00	---	---	QP
2	0.04	39.20	-77.50	116.70	18.74	20.17	0.29	0.00	---	---	QP
3	0.05	38.87	-75.04	113.91	18.41	20.17	0.29	0.00	---	---	QP
4	0.07	40.94	-70.12	111.06	20.54	20.11	0.29	0.00	---	---	QP
5	0.08	37.55	-72.35	109.90	17.15	20.11	0.29	0.00	---	---	QP
6	0.08	38.34	-71.05	109.39	17.94	20.11	0.29	0.00	---	---	QP
7	0.10	41.78	-66.12	107.90	21.42	20.07	0.29	0.00	---	---	QP
8	0.10	41.06	-66.66	107.72	20.70	20.07	0.29	0.00	---	---	QP
9	0.11	38.06	-68.71	106.77	17.70	20.07	0.29	0.00	---	---	QP
10	0.13	40.19	-65.21	105.40	19.84	20.06	0.29	0.00	---	---	QP
11	0.14	35.50	-69.46	104.96	15.15	20.06	0.29	0.00	---	---	QP
12	0.15	38.90	-65.47	104.37	18.57	20.04	0.29	0.00	---	---	QP
13	0.69	52.36	-18.46	70.82	32.05	20.00	0.31	0.00	---	---	QP
14	1.19	55.53	-10.57	66.10	35.21	20.01	0.31	0.00	100	198	QP
15	1.54	51.44	-12.44	63.88	31.10	20.01	0.33	0.00	---	---	QP
16	2.36	43.54	-26.46	70.00	23.18	20.03	0.33	0.00	---	---	QP
17	3.39	39.99	-30.01	70.00	19.63	20.02	0.34	0.00	---	---	QP
18	6.13	38.19	-31.81	70.00	17.93	19.90	0.36	0.00	---	---	QP
19	9.47	37.79	-32.21	70.00	17.66	19.75	0.38	0.00	---	---	QP
20	10.98	37.45	-32.55	70.00	17.29	19.77	0.39	0.00	---	---	QP
21	12.41	37.10	-32.90	70.00	16.92	19.78	0.40	0.00	---	---	QP
22	13.57	55.44	-14.56	70.00	35.29	19.75	0.40	0.00	---	---	QP
23	16.83	37.98	-32.02	70.00	17.74	19.82	0.42	0.00	---	---	QP
24	19.59	37.72	-32.28	70.00	17.19	20.10	0.43	0.00	---	---	QP
25	21.79	38.12	-31.88	70.00	17.39	20.29	0.44	0.00	---	---	QP
26	25.79	38.78	-31.22	70.00	17.92	20.39	0.47	0.00	---	---	QP
27	27.03	37.70	-32.30	70.00	16.84	20.38	0.48	0.00	---	---	QP
28	28.25	37.74	-32.26	70.00	16.92	20.32	0.50	0.00	---	---	QP

Note: The amplitude of spurious emissions which are attenuated by more than 20dB below the permissible value has no need to be reported.

Distance extrapolation factor = 40 log (specific distance / test distance) (dB);

Limit line = specific limits (dBμV) + distance extrapolation factor.



Results for Radiated Emissions (30MHz~1GHz)

Final Test Date	Oct. 28, 2013 ~ Oct. 31, 2013	Test Site No.	03CH07-HY
Temperature	22~24°C	Humidity	51~53%
Test Engineer	Eric Shih	Configurations	Ch. 1

Horizontal

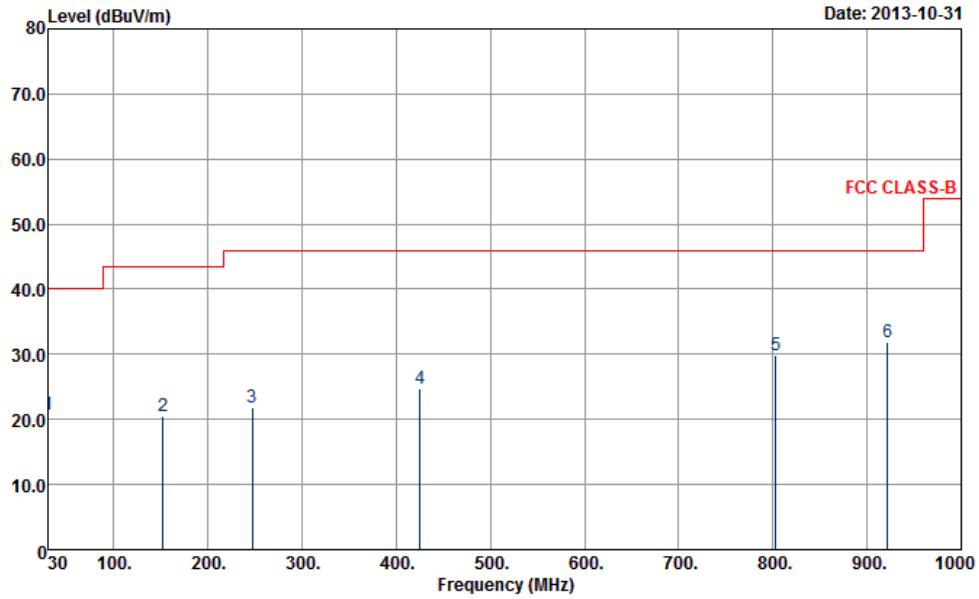

Site : 03CH07-HY
 Condition : FCC CLASS-B 3m LF-ANT(111116) HORIZONTAL
 Project : FR 391853
 Mode : 1

	Freq	Level	Over Limit	Limit Line	ReadAntenna Level	Cable Factor	Preamp Loss	A/Pos	T/Pos	Remark
	MHz	dBuV/m	dB	dBuV/m	dBuV	dB/m	dB	dB	cm	deg
1	30.54	20.70	-19.30	40.00	32.34	19.28	0.54	31.46	---	Peak
2	152.04	20.60	-22.90	43.50	39.45	11.06	1.21	31.12	---	Peak
3	247.08	21.90	-24.10	46.00	38.97	12.40	1.53	31.00	---	Peak
4	425.30	24.68	-21.32	46.00	36.67	16.55	2.23	30.77	---	Peak
5	803.30	29.77	-16.23	46.00	34.80	22.13	3.15	30.31	---	Peak
6	921.60	31.82	-14.18	46.00	35.35	23.42	3.39	30.34	137	64 Peak



Vertical

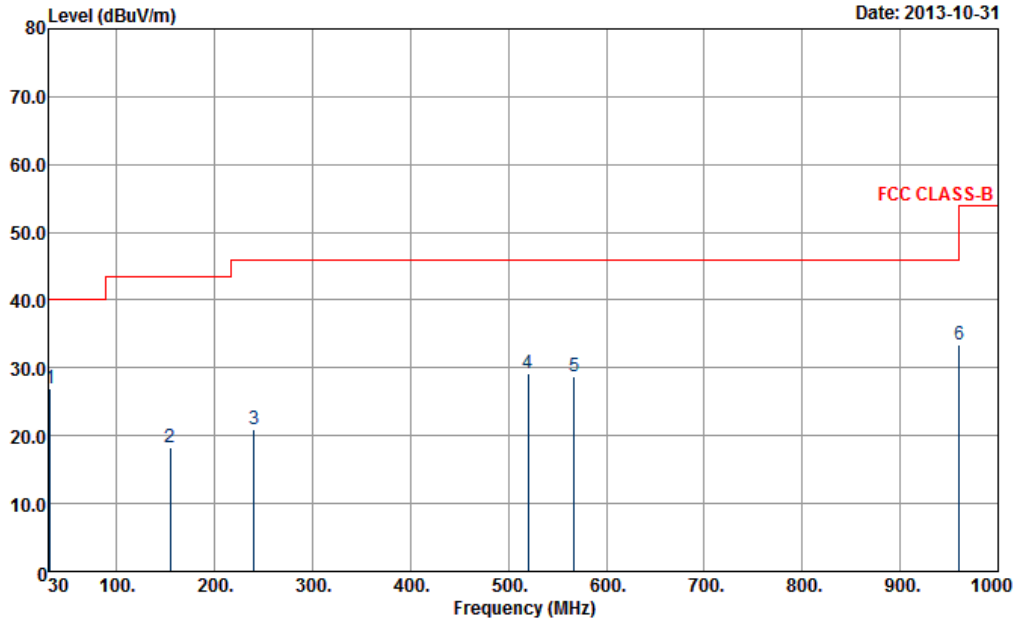

Site : 03CH07-HY
 Condition : FCC CLASS-B 3m LF-ANT(111116) VERTICAL
 Project : FR 391853
 Mode : 1

	Freq	Level	Over	Limit	ReadAntenna	Cable	Preamp	A/Pos	T/Pos	Remark
	MHz	dBuV/m	dB	dBuV/m	dBuV	dB/m	dB	dB	cm	deg
1	31.89	26.91	-13.09	40.00	39.22	18.56	0.55	31.42	111	29 Peak
2	154.74	18.18	-25.32	43.50	37.26	10.85	1.22	31.15	---	---
3	240.06	21.01	-24.99	46.00	38.55	11.93	1.53	31.00	---	---
4	519.80	29.10	-16.90	46.00	38.86	18.43	2.49	30.68	---	---
5	566.70	28.64	-17.36	46.00	37.55	19.22	2.60	30.73	---	---
6	960.10	33.46	-20.54	54.00	36.35	24.00	3.47	30.36	---	---

Note: The amplitude of spurious emissions which are attenuated by more than 20dB below the permissible value has no need to be reported.

Emission level (dBµV/m) = 20 log Emission level (µV/m).

Corrected Reading: Antenna Factor + Cable Loss + Read Level - Preamp Factor= Level.



3.5 Frequency Stability Measurement

3.5.1 Limit

The frequency tolerance of the carrier signal shall be maintained within +/- 0.01% (100ppm) of the operating frequency over a temperature variation of -20 degrees to +50 degrees C at normal supply voltage, and for a variation in the primary supply voltage from 85% to 115% of the rated supply voltage at a temperature of 20 degrees C. For battery operated equipment, the equipment tests shall be performed using a new battery.

3.5.2 Measuring Instruments and Setting

Please refer to section 4 of equipments list in this report. The following table is the setting of the spectrum analyzer.

Spectrum Parameter	Setting
Attenuation	Auto
Span Frequency	Entire absence of modulation emissions bandwidth
RBW	1 kHz
VBW	3 kHz
Sweep Time	Auto

3.5.3 Test Procedures

1. The transmitter output (antenna port) was connected to the spectrum analyzer.
2. EUT have transmitted absence of modulation signal and fixed channelize.
3. Set the spectrum analyzer span to view the entire absence of modulation emissions bandwidth.
4. Set RBW = 1 kHz, VBW = 3 kHz with peak detector and maxhold settings.
5. fc is declaring of channel frequency. Then the frequency error formula is $(f-fc)/fc \times 10^6$ ppm and the limit is less than ± 100 ppm.
6. The test extreme voltage is to change the primary supply voltage from 85 to 115 percent of the nominal value
7. Extreme temperature rule is -20°C~50°C.

3.5.4 Test Setup Layout

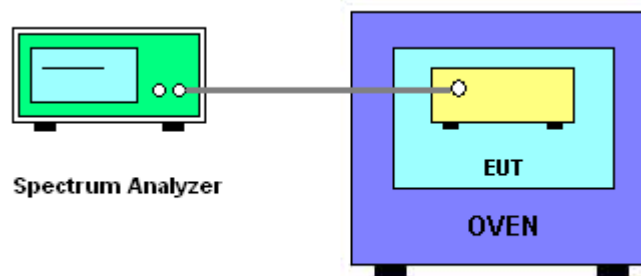

3.5.5 Test Deviation

There is no deviation with the original standard.

3.5.6 EUT Operation during Test

The EUT was programmed to be in continuously un-modulation transmitting mode.



3.5.7 Test Result of Frequency Stability

Final Test Date	Oct. 30, 2013 ~ Oct. 31, 2013	Test Site No.	TH02-HY
Temperature	22~24°C	Humidity	53~55%
Test Engineer	Tommy Lee	Configurations	Ch. 1

Voltage vs. Frequency Stability

Voltage(V)	Measurement Frequency (MHz)
120	13.559970
102	13.559980
138	13.559980
Max. Deviation (MHz)	-0.000030
Max. Deviation (ppm)	-2.2124

Temperature vs. Frequency Stability

Temperature (°C)	Measurement Frequency (MHz)
-20	13.559960
-10	13.559960
0	13.559960
10	13.559960
20	13.559960
30	13.559980
40	13.559970
50	13.560000
Max. Deviation (MHz)	-0.000040
Max. Deviation (ppm)	-2.9499



3.6 Antenna Requirements

3.6.1 Limit

Except for special regulations, the Low-power Radio-frequency Devices must not be equipped with any jacket for installing an antenna with extension cable. An intentional radiator shall be designed to ensure that no antenna other than that furnished by the responsible party shall be used with the device. The use of a permanently attached antenna or of an antenna that uses a unique coupling to the intentional radiator shall be considered sufficient to comply with the provisions of this Section. The manufacturer may design the unit so that the user can replace a broken antenna, but the use of a standard antenna jack or electrical connector is prohibited.

3.6.2 Antenna Connector Construction

Embedded in Antenna.

**4. LIST OF MEASURING EQUIPMENT**

Instrument	Manufacturer	Model No.	Serial No.	Characteristics	Calibration Date	Test Date	Due Date	Remark
Spectrum Analyzer	Rohde & Schwarz	FSP40	100055	9kHz~40GHz	Jun. 07, 2013	Oct. 30, 2013 ~ Oct. 31, 2013	Jun. 06, 2014	Conducted (TH02-HY)
Thermal Chamber	Ten Billion	TTH-D3SP	TBN-930701	N/A	Jul. 19, 2013	Oct. 30, 2013 ~ Oct. 31, 2013	Jul. 18, 2014	Conducted (TH02-HY)
EMI Test Receiver	Rohde & Schwarz	ESCS 30	100356	9kHz ~ 2.75GHz	Nov. 13, 2012	Oct. 03, 2013	Nov. 12, 2013	Conduction (CO05-HY)
Two-LISN (for auxiliary equipment)	Rohde & Schwarz	ENV216	100081	9kHz ~ 30MHz	Dec. 12, 2012	Oct. 03, 2013	Dec. 11, 2013	Conduction (CO05-HY)
Two-LISN	Rohde & Schwarz	ENV216	100080	9kHz ~ 30MHz	Dec. 06, 2012	Oct. 03, 2013	Dec. 05, 2013	Conduction (CO05-HY)
AC Power Source	APC	APC-1000W	N/A	N/A	N/A	Oct. 03, 2013	N/A	Conduction (CO05-HY)
EMI Test Receiver	Rohde & Schwarz	ESCI 7	100724	9kHz~7GHz	Sep. 06, 2013	Oct. 28, 2013 ~ Oct. 31, 2013	Sep. 05, 2014	Radiation (03CH07-HY)
Loop Antenna	Rohde & Schwarz	HFH2-Z2	860004/0001	9 kHz~30 MhZ	Jul. 03, 2012	Oct. 28, 2013 ~ Oct. 31, 2013	Jul. 02, 2014	Radiation (03CH07-HY)
Bilog Antenna	Schaffner	CBL6111C	2726	30MHz ~ 1GHz	Oct. 10, 2013	Oct. 28, 2013 ~ Oct. 31, 2013	Oct. 09, 2014	Radiation (03CH07-HY)
Preamplifier	COM-POWER	PA-103A	161241	30MHz~1GHz	Feb. 26, 2013	Oct. 28, 2013 ~ Oct. 31, 2013	Feb. 25, 2014	Radiation (03CH07-HY)
Turn Table	ChainTek	ChainTek 3000	N/A	0 ~ 360 degree	N/A	Oct. 28, 2013 ~ Oct. 31, 2013	N/A	Radiation (03CH07-HY)
Antenna Mast	ChainTek	ChainTek 3000	N/A	N/A	N/A	Oct. 28, 2013 ~ Oct. 31, 2013	N/A	Radiation (03CH07-HY)



5. TEST LOCATION

HWA YA	ADD : No. 52, Hwa Ya 1st Rd., Kwei-Shan Hsiang, Tao Yuan Hsien, Taiwan, R.O.C.
	TEL : 886-3-327-3456
	FAX : 886-3-318-0055

6. TAF CERTIFICATE OF ACCREDITATION



Certificate No. : L1190-130110

財團法人全國認證基金會
Taiwan Accreditation Foundation

Certificate of Accreditation

This is to certify that

Sporton International Inc.
EMC & Wireless Communications Laboratory
No.52, Hwa Ya 1st Rd., Hwa Ya Technology Park, Kwei-Shan Hsiang, Tao Yuan Hsien,
Taiwan, R.O.C.

is accredited in respect of laboratory

Accreditation Criteria	: ISO/IEC 17025:2005
Accreditation Number	: 1190
Originally Accredited	: December 15, 2003
Effective Period	: January 10, 2013 to January 09, 2016
Accredited Scope	: Testing Field, see described in the Appendix
Specific Accreditation Program	: Accreditation Program for Designated Testing Laboratory for Commodities Inspection Accreditation Program for Telecommunication Equipment Testing Laboratory Accreditation Program for BSMI Mutual Recognition Arrangement with Foreign Authorities



Jay-San Chen
President, Taiwan Accreditation Foundation
Date: January 10, 2013

P1, total 20 pages

The Appendix forms an integral part of this Certificate, which shall be invalid when use without the Appendix