

## FCC Test Report

**Report No.:** RF190514C08

**FCC ID:** QYLT800RFIDC

**Test Model:** M6e-TC

**Received Date:** May 14, 2019

**Test Date:** Jun. 17, 2019 ~ Jun. 29, 2019

**Issued Date:** Jul. 08, 2019

**Applicant:** Getac Technology Corporation.

**Address:** 5F., Building A, No. 209, Sec. 1, Nangang Rd., Nangang Dist, Taipei City  
11568, Taiwan, R.O.C.

**Issued By:** Bureau Veritas Consumer Products Services (H.K.) Ltd., Taoyuan Branch

**Lab Address:** No. 47-2, 14th Ling, Chia Pau Vil., Lin Kou Dist., New Taipei City, Taiwan  
( R.O.C )

**Test Location:** No.19, Hwa Ya 2nd Rd., Wen Hwa Vil., Kwei Shan Dist., Taoyuan City  
33383, Taiwan, R.O.C.

**FCC Registration /  
Designation Number:** 788550 / TW0003



This report is for your exclusive use. Any copying or replication of this report to or for any other person or entity, or use of our name or trademark, is permitted only with our prior written permission. This report sets forth our findings solely with respect to the test samples identified herein. The results set forth in this report are not indicative or representative of the quality or characteristics of the lot from which a test sample was taken or any similar or identical product unless specifically and expressly noted. Our report includes all of the tests requested by you and the results thereof based upon the information that you provided to us. You have 60 days from date of issuance of this report to notify us of any material error or omission caused by our negligence, provided, however, that such notice shall be in writing and shall specifically address the issue you wish to raise. A failure to raise such issue within the prescribed time shall constitute your unqualified acceptance of the completeness of this report, the tests conducted and the correctness of the report contents. Unless specific mention, the uncertainty of measurement has been explicitly taken into account to declare the compliance or non-compliance to the specification.

This report should not be used by the client to claim product certification, approval, or endorsement by TAF or any government agencies.

## Table of Contents

<b>Release Control Record .....</b>	<b>4</b>
<b>1 Certificate of Conformity .....</b>	<b>5</b>
<b>2 Summary of Test Results .....</b>	<b>6</b>
2.1 Measurement Uncertainty .....	7
2.2 Modification Record .....	7
<b>3 General Information .....</b>	<b>8</b>
3.1 General Description of EUT .....	8
3.2 Description of Test Modes .....	9
3.2.1 Test Mode Applicability and Tested Channel Detail .....	10
3.3 Description of Support Units .....	11
3.3.1 Configuration of System under Test .....	11
3.4 General Description of Applied Standards .....	11
<b>4 Test Types and Results .....</b>	<b>12</b>
4.1 Radiated Emission and Bandedge Measurement .....	12
4.1.1 Limits of Radiated Emission and Bandedge Measurement .....	12
4.1.2 Test Instruments .....	13
4.1.3 Test Procedures .....	14
4.1.4 Deviation from Test Standard .....	14
4.1.5 Test Set Up .....	15
4.1.6 EUT Operating Conditions .....	16
4.1.7 Test Results .....	17
4.2 Conducted Emission Measurement .....	32
4.2.1 Limits of Conducted Emission Measurement .....	32
4.2.2 Test Instruments .....	32
4.2.3 Test Procedures .....	33
4.2.4 Deviation from Test Standard .....	33
4.2.5 Test Setup .....	33
4.2.6 EUT Operating Condition .....	33
4.2.7 Test Results .....	34
4.3 Number of Hopping Frequency Used .....	36
4.3.1 Limits of Hopping Frequency Used Measurement .....	36
4.3.2 Test Setup .....	36
4.3.3 Test Instruments .....	36
4.3.4 Test Procedure .....	36
4.3.5 Deviation from Test Standard .....	36
4.3.6 Test Results .....	36
4.4 Dwell Time on Each Channel .....	37
4.4.1 Limits of Dwell Time on Each Channel Measurement .....	37
4.4.2 Test Setup .....	37
4.4.3 Test Instruments .....	37
4.4.4 Test Procedures .....	37
4.4.5 Deviation from Test Standard .....	37
4.4.6 Test Results .....	38
4.5 Channel Bandwidth .....	39
4.5.1 Limits of Channel Bandwidth Measurement .....	39
4.5.2 Test Setup .....	39
4.5.3 Test Instruments .....	39
4.5.4 Test Procedure .....	39
4.5.5 Deviation from Test Standard .....	39
4.5.6 EUT Operating Condition .....	39
4.5.7 Test Results .....	40
4.6 Occupied Bandwidth Measurement .....	41
4.6.1 Test Setup .....	41

4.6.2	Test Instruments .....	41
4.6.3	Test Procedure .....	41
4.6.4	Deviation from Test Standard .....	41
4.6.5	EUT Operating Conditions .....	41
4.6.6	Test Results.....	42
4.7	Hopping Channel Separation.....	43
4.7.1	Limits of Hopping Channel Separation Measurement .....	43
4.7.2	Test Setup .....	43
4.7.3	Test Instruments .....	43
4.7.4	Test Procedure .....	43
4.7.5	Deviation from Test Standard.....	43
4.7.6	Test Results.....	44
4.8	Maximum Output Power.....	45
4.8.1	Limits of Maximum Output Power Measurement .....	45
4.8.2	Test Setup .....	45
4.8.3	Test Instruments .....	45
4.8.4	Test Procedure .....	45
4.8.5	Deviation from Test Standard.....	45
4.8.6	EUT Operating Condition.....	45
4.8.7	Test Results.....	45
4.9	Conducted Out of Band Emission Measurement.....	46
4.9.1	Limits Of Conducted Out of Band Emission Measurement .....	46
4.9.2	Test Instruments .....	46
4.9.3	Test Procedure .....	46
4.9.4	Deviation from Test Standard.....	46
4.9.5	EUT Operating Condition.....	46
4.9.6	Test Results.....	46
<b>5</b>	<b>Pictures of Test Arrangements.....</b>	<b>48</b>
	<b>Appendix – Information on the Testing Laboratories .....</b>	<b>49</b>

### Release Control Record

Issue No.	Description	Date Issued
RF190514C08	Original Release	Jul. 08, 2019

## 1 Certificate of Conformity

**Product:** UHF RFID Module

**Brand:** Transcore

**Test Model:** M6e-TC

**Sample Status:** Identical Prototype

**Applicant:** Getac Technology Corporation.

**Test Date:** Jun. 17, 2019 ~ Jun. 29, 2019

**Standards:** 47 CFR FCC Part 15, Subpart C (Section 15.247)  
ANSI C63.10:2013

The above equipment has been tested by **Bureau Veritas Consumer Products Services (H.K.) Ltd., Taoyuan Branch**, and found compliance with the requirement of the above standards. The test record, data evaluation & Equipment Under Test (EUT) configurations represented herein are true and accurate accounts of the measurements of the sample's RF characteristics under the conditions specified in this report.

**Prepared by :** Rona Chen, **Date:** Jul. 08, 2019  
Rona Chen / Specialist

**Approved by :** Dylan Chiou, **Date:** Jul. 08, 2019  
Dylan Chiou / Project Engineer

## 2 Summary of Test Results

47 CFR FCC Part 15, Subpart C (Section 15.247)			
FCC Clause	Test Item	Result	Remarks
15.207	AC Power Conducted Emission	Pass	Meet the requirement of limit. Minimum passing margin is -13.79 dB at 0.15391 MHz.
15.247(a)(1)(i)	Number of Hopping Frequency Used	Pass	Meet the requirement of limit.
15.247(a)(1)(i)	Dwell Time on Each Channel	Pass	Meet the requirement of limit.
15.247(a)(1)(i)	1. Hopping Channel Separation 2. Spectrum Bandwidth of a Frequency Hopping Sequence Spread Spectrum System	Pass	Meet the requirement of limit.
15.247(b)(2)	Maximum Peak Output Power	Pass	Meet the requirement of limit.
---	Occupied Bandwidth Measurement	Pass	Reference only
15.205 & 209	Radiated Emissions	Pass	Meet the requirement of limit. Minimum passing margin is -1.05 dB at 800.18 MHz.
15.247(d)	Band Edge Measurement	Pass	Meet the requirement of limit. Minimum passing margin is -10.95 dB at 928 MHz.
15.247(d)	Antenna Port Emission	Pass	Meet the requirement of limit.
15.203	Antenna Requirement	Pass	Meet the requirement of limit.

**Note:**

1. If the 20 dB bandwidth of the hopping channel is less than 250 kHz, the system shall use at least 50 hopping frequencies and the average time of occupancy on any frequency shall not be greater than 0.4 seconds within a 20 second period.
2. Determining compliance based on the results of the compliance measurement, not taking into account measurement instrumentation uncertainty.

## 2.1 Measurement Uncertainty

Where relevant, the following measurement uncertainty levels have been estimated for tests performed on the EUT as specified in CISPR 16-4-2:

Measurement	Frequency	Expanded Uncertainty (k=2) ( $\pm$ )
Conducted Emissions at mains ports	150 kHz ~ 30 MHz	2.44 dB
Radiated Emissions up to 1 GHz	9 kHz ~ 30 MHz	3.04 dB
	30 MHz ~ 200 MHz	2.93 dB
	200 MHz ~ 1000 MHz	2.95 dB
Radiated Emissions above 1 GHz	1 GHz ~ 18 GHz	2.26 dB
	18 GHz ~ 40 GHz	1.94 dB

## 2.2 Modification Record

There were no modifications required for compliance.

### 3 General Information

#### 3.1 General Description of EUT

<b>Product</b>	UHF RFID Module
<b>Brand</b>	Transcore
<b>Test Model</b>	M6e-TC
<b>Status of EUT</b>	Identical Prototype
<b>Power Supply Rating</b>	5 Vdc (Host equipment)
<b>Modulation Type</b>	ASK
<b>Operating Frequency</b>	902.75 ~ 927.25 MHz
<b>Number of Channel</b>	50
<b>Output Power</b>	939.723 mW
<b>Antenna Type</b>	PCB antenna with -1.77 dBi gain
<b>Antenna Connector</b>	N/A
<b>Accessory Device</b>	N/A
<b>Data Cable Supplied</b>	N/A

Note:

1. The above EUT information is declared by manufacturer and for more detailed features description, please refers to the manufacturer's specifications or User's Manual.



### 3.2 Description of Test Modes

50 channels are provided to this EUT:

Channel	Freq. (MHz)	Channel	Freq. (MHz)	Channel	Freq. (MHz)
0	902.75	17	911.25	34	919.75
1	903.25	18	911.75	35	920.25
2	903.75	19	912.25	36	920.75
3	904.25	20	912.75	37	921.25
4	904.75	21	913.25	38	921.75
5	905.25	22	913.75	39	922.25
6	905.75	23	914.25	40	922.75
7	906.25	24	914.75	41	923.25
8	906.75	25	915.25	42	923.75
9	907.25	26	915.75	43	924.25
10	907.75	27	916.25	44	924.75
11	908.25	28	916.75	45	925.25
12	908.75	29	917.25	46	925.75
13	909.25	30	917.75	47	926.25
14	909.75	31	918.25	48	926.75
15	910.25	32	918.75	49	927.25
16	910.75	33	919.25		

### 3.2.1 Test Mode Applicability and Tested Channel Detail

EUT Configure Mode	Applicable To				Description
	RE $\geq$ 1G	RE $<$ 1G	PLC	APCM	
-	√	√	√	√	-

Where **RE $\geq$ 1G**: Radiated Emission above 1 GHz      **RE $<$ 1G**: Radiated Emission below 1 GHz  
**PLC**: Power Line Conducted Emission      **APCM**: Antenna Port Conducted Measurement

**Note:** The EUT had been pre-tested on the positioned of each 3 axis. The worst case was found when positioned on **Z-plane**.

#### **Radiated Emission Test (Above 1 GHz):**

- Pre-Scan has been conducted to determine the worst-case mode from all possible combinations between available modulations, data rates and antenna ports (if EUT with antenna diversity architecture).
- Following channel(s) was (were) selected for the final test as listed below.

EUT Configure Mode	Available Channel	Tested Channel	Modulation Type
-	0 to 49	0, 25, 49	ASK

#### **Radiated Emission Test (Below 1 GHz):**

- Pre-Scan has been conducted to determine the worst-case mode from all possible combinations between available modulations, data rates and antenna ports (if EUT with antenna diversity architecture).
- Following channel(s) was (were) selected for the final test as listed below.

EUT Configure Mode	Available Channel	Tested Channel	Modulation Type
-	0 to 49	0, 25, 49	ASK

#### **Power Line Conducted Emission Test:**

- Pre-Scan has been conducted to determine the worst-case mode from all possible combinations between available modulations, data rates and antenna ports (if EUT with antenna diversity architecture).
- Following channel(s) was (were) selected for the final test as listed below.

EUT Configure Mode	Available Channel	Tested Channel	Modulation Type
-	0 to 49	25	ASK

#### **Antenna Port Conducted Measurement:**

- This item includes all test value of each mode, but only includes spectrum plot of worst value of each mode.
- Pre-Scan has been conducted to determine the worst-case mode from all possible combinations between available modulations, data rates and antenna ports (if EUT with antenna diversity architecture).
- Following channel(s) was (were) selected for the final test as listed below.

EUT Configure Mode	Available Channel	Tested Channel	Modulation Type
-	0 to 49	0, 25, 49	ASK

**Test Condition:**

Applicable To	Environmental Conditions	Input Power (System)	Tested by
RE≥1G	25 deg. C, 65 % RH	120 Vac, 60 Hz	Tim Chen
RE<1G	25 deg. C, 65 % RH	120 Vac, 60 Hz	Tim Chen
PLC	25 deg. C, 65 % RH	120 Vac, 60 Hz	Thomas Wei
APCM	25 deg. C, 65 % RH	5 Vdc	Vincent Huang

**3.3 Description of Support Units**

The EUT has been tested as an independent unit together with other necessary accessories or support units. The following support units or accessories were used to form a representative test configuration during the tests.

No.	Product	Brand	Model No.	Serial No.	FCC ID
A.	Tablet PC	Getac	T800	N/A	N/A

No.	Signal Cable Description Of The Above Support Units
1.	1.75m shielded DC cable with 1 core

**3.3.1 Configuration of System under Test**

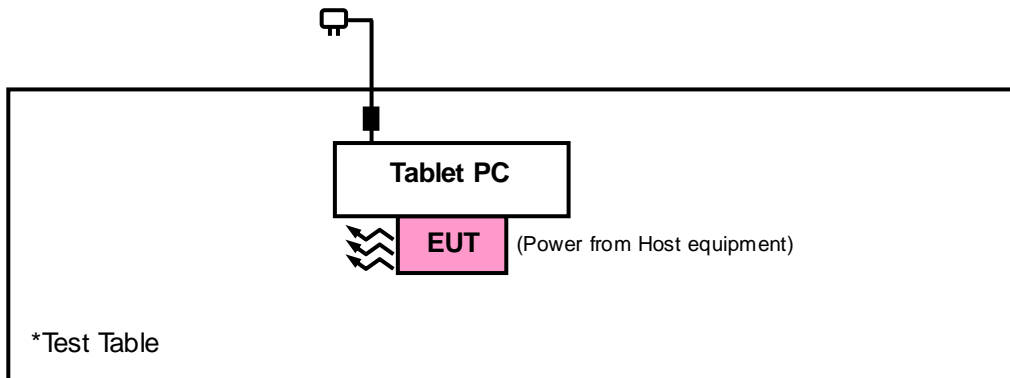

**3.4 General Description of Applied Standards**

The EUT is a RF Product. According to the specifications of the manufacturer, it must comply with the requirements of the following standards:

**FCC Part 15, Subpart C (15.247)**

ANSI C63.10-2013

All test items have been performed and recorded as per the above standards.

## 4 Test Types and Results

### 4.1 Radiated Emission and Bandedge Measurement

#### 4.1.1 Limits of Radiated Emission and Bandedge Measurement

Radiated emissions which fall in the restricted bands must comply with the radiated emission limits specified as below table. Other emissions shall be at least 20 dB below the highest level of the desired power:

Frequencies (MHz)	Field Strength (microvolts/meter)	Measurement Distance (meters)
0.009 ~ 0.490	2400/F(kHz)	300
0.490 ~ 1.705	24000/F(kHz)	30
1.705 ~ 30.0	30	30
30 ~ 88	100	3
88 ~ 216	150	3
216 ~ 960	200	3
Above 960	500	3

**Note:**

- a. The lower limit shall apply at the transition frequencies.
- b. Emission level (dBuV/m) = 20 log Emission level (uV/m).
- c. For frequencies above 1000 MHz, the field strength limits are based on average detector, however, the peak field strength of any emission shall not exceed the maximum permitted average limits, specified above by more than 30 dB under any condition of modulation.

#### 4.1.2 Test Instruments

Description & Manufacturer	Model No.	Serial No.	Date Of Calibration	Due Date Of Calibration
Test Receiver Agilent	N9038A	MY51210203	Mar. 18, 2019	Mar. 17, 2020
Spectrum Analyzer Agilent	N9010A	MY52220314	Dec. 13, 2018	Dec. 12, 2019
Spectrum Analyzer ROHDE & SCHWARZ	FSU43	101261	Apr. 15, 2019	Apr. 14, 2020
Horn Antenna SCHWARZBECK	BBHA 9120D	9120D-969	Nov. 25, 2018	Nov. 24, 2019
BILOG Antenna SCHWARZBECK	VULB 9168	9168-472	Nov. 23, 2018	Nov. 22, 2019
Fixed Attenuator WORKEN	MDCS18N-10	MDCS18N-10-01	Apr. 15, 2019	Apr. 14, 2020
Loop Antenna	EM-6879	269	Sep. 07, 2018	Sep. 06, 2019
Preamplifier EMCI	EMC001340	980201	Oct. 12, 2018	Oct. 11, 2019
Preamplifier EMCI	EMC 012645	980115	Oct. 12, 2018	Oct. 11, 2019
Preamplifier EMCI	EMC 184045	980116	Oct. 12, 2018	Oct. 11, 2019
Preamplifier EMCI	EMC 330H	980112	Oct. 12, 2018	Oct. 11, 2019
Power Meter Anritsu	ML2495A	1012010	Sep. 05, 2018	Sep. 04, 2019
Power Sensor Anritsu	MA2411B	1315050	Sep. 04, 2018	Sep. 03, 2019
RF Coaxial Cable HUBER+SUHNNER	EMC104-SM-SM-8000&3000	140811+170717	Oct. 12, 2018	Oct. 11, 2019
RF Coaxial Cable HUBER+SUHNNER	SUCOFLEX 104	EMC104-SM-SM-1000(140807)	Oct. 12, 2018	Oct. 11, 2019
RF Coaxial Cable WOKEN	8D-FB	Cable-Ch10-01	Oct. 12, 2018	Oct. 11, 2019
Software BV ADT	E3 6.120103	NA	NA	NA
Antenna Tower MF	MFA-440H	NA	NA	NA
Turn Table MF	MFT-201SS	NA	NA	NA
Antenna Tower & Turn Table Controller MF	MF-7802	NA	NA	NA

- Note: 1. The calibration interval of the above test instruments is 12 months and the calibrations are traceable to NML/ROC and NIST/USA.  
2. The test was performed in HwaYa Chamber 10.

#### 4.1.3 Test Procedures

##### **For Radiated Emission below 30 MHz**

- a. The EUT was placed on the top of a rotating table 0.8 meters above the ground at a 3 meter chamber room. The table was rotated 360 degrees to determine the position of the highest radiation.
- b. The EUT was set 3 meters away from the interference-receiving antenna, which was mounted on the top of a variable-height antenna tower.
- c. Both Parallel, perpendicular, and ground-parallel orientations of the antenna are set to make the measurement.
- d. For each suspected emission, the EUT was arranged to its worst case and the rotatable table was turned from 0 degrees to 360 degrees to find the maximum reading.
- e. The test-receiver system was set to Quasi-Peak Detect Function and Specified Bandwidth with Maximum Hold Mode.

##### **Note:**

1. The resolution bandwidth and video bandwidth of test receiver/spectrum analyzer is 9 kHz at frequency below 30 MHz.

##### **For Radiated Emission above 30 MHz**

- a. The EUT was placed on the top of a rotating table 0.8 meters (for 30 MHz ~ 1 GHz) / 1.5 meters (for above 1 GHz) above the ground at 3 meter chamber room for test. The table was rotated 360 degrees to determine the position of the highest radiation.
- b. The EUT was set 3 meters away from the interference-receiving antenna, which was mounted on the top of a variable-height antenna tower.
- c. The height of antenna is varied from one meter to four meters above the ground to determine the maximum value of the field strength. Both horizontal and vertical polarizations of the antenna are set to make the measurement.
- d. For each suspected emission, the EUT was arranged to its worst case and then the antenna was tuned to heights from 1 meter to 4 meters and the rotatable table was turned from 0 degrees to 360 degrees to find the maximum reading.
- e. The test-receiver system was set to quasi-peak detect function and specified bandwidth with maximum hold mode when the test frequency is below 1 GHz.
- f. The test-receiver system was set to peak and average detected function and specified bandwidth with maximum hold mode when the test frequency is above 1 GHz. If the peak reading value also meets average limit, measurement with the average detector is unnecessary.

##### **Note:**

1. The resolution bandwidth and video bandwidth of test receiver/spectrum analyzer is 120 kHz for Quasi-peak detection (QP) or Peak detection (PK) at frequency below 1 GHz.
2. The resolution bandwidth of test receiver/spectrum analyzer is 1 MHz and the video bandwidth is 3 MHz for Peak detection (PK) at frequency above 1 GHz.
3. The resolution bandwidth of test receiver/spectrum analyzer is 1 MHz and the video bandwidth is  $\geq 1/T$  (Duty cycle < 98 %) or 10 Hz (Duty cycle  $\geq 98$  %) for Average detection (AV) at frequency above 1 GHz. (RBW = 1 MHz, VBW = 1 kHz)
4. All modes of operation were investigated and the worst-case emissions are reported.

#### 4.1.4 Deviation from Test Standard

No deviation.

#### 4.1.5 Test Set Up

##### <Radiated Emission below 30 MHz>

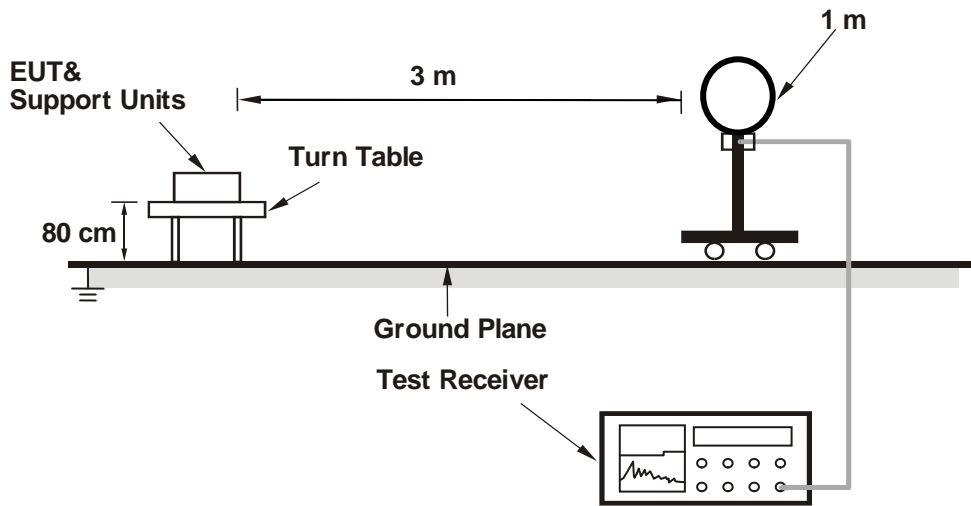

##### <Radiated Emission 30 MHz to 1 GHz>

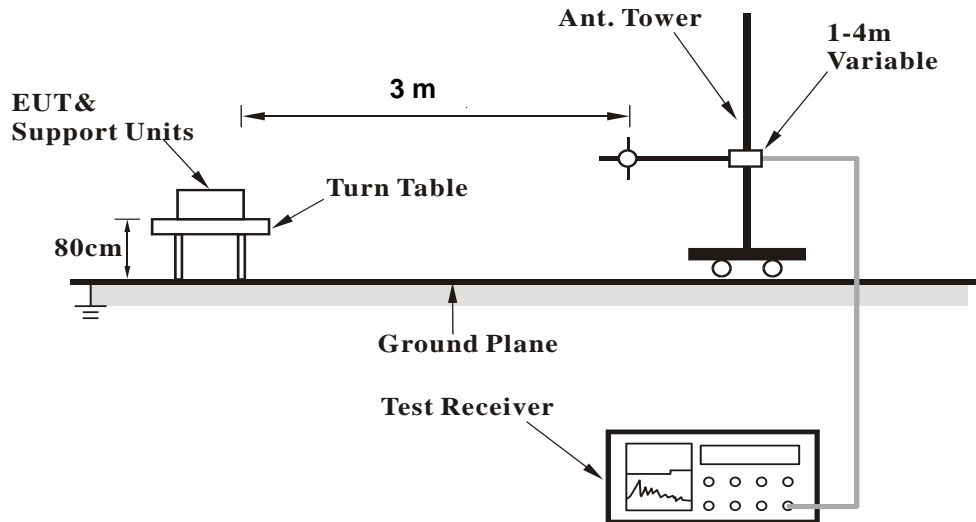

<Radiated Emission above 1 GHz>

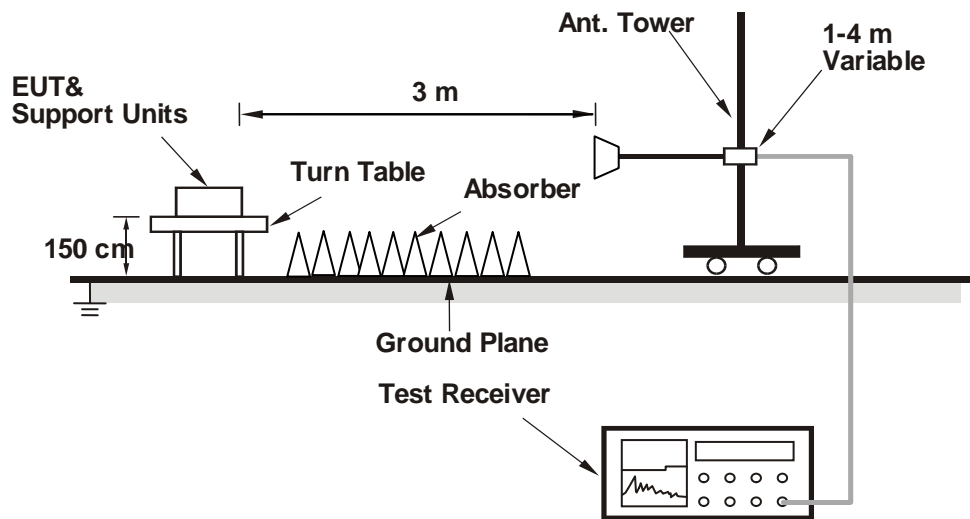

For the actual test configuration, please refer to the attached file (Test Setup Photo).

#### 4.1.6 EUT Operating Conditions

Set the EUT under transmission condition continuously at specific channel frequency.



4.1.7 Test Results

Above 1 GHz Data:

EUT Test Condition		Measurement Detail	
Channel	Channel 0	Frequency Range	1 GHz ~ 10 GHz
Input Power	120 Vac, 60 Hz	Detector Function	Peak (PK) Average (AV)
Environmental Conditions	25 deg. C, 65 % RH	Tested By	Tim Chen

Antenna Polarity & Test Distance: Horizontal at 3 m								
Frequency (MHz)	Emission Level (dBuV/m)	Read Level (dBuV)	Factor (dB/m)	Limit (dBuV/m)	Margin (dB)	Antenna Height (cm)	Table Angle (Degree)	Remark
*1805.5	32.29	55.94	-23.65	96.02	-63.73	150	334	Average
*1805.5	34.66	58.31	-23.65	97.52	-62.86	150	334	Peak
Antenna Polarity & Test Distance: Vertical at 3 m								
Frequency (MHz)	Emission Level (dBuV/m)	Read Level (dBuV)	Factor (dB/m)	Limit (dBuV/m)	Margin (dB)	Antenna Height (cm)	Table Angle (Degree)	Remark
*1805.5	30.47	54.12	-23.65	95.71	-65.24	123	154	Average
*1805.5	34.38	58.03	-23.65	97.19	-62.81	123	154	Peak

Remarks:

- Emission Level = Read Level + Factor  
Margin value = Emission level – Limit value
- 902.75 MHz: Fundamental frequency.
- \*: Out of Restricted Band
- The emission levels of other frequencies were very low against the limit.

EUT Test Condition		Measurement Detail	
Channel	Channel 25	Frequency Range	1 GHz ~ 10 GHz
Input Power	120 Vac, 60 Hz	Detector Function	Peak (PK) Average (AV)
Environmental Conditions	25 deg. C, 65 % RH	Tested By	Tim Chen

Antenna Polarity & Test Distance: Horizontal at 3 m								
Frequency (MHz)	Emission Level (dBuV/m)	Read Level (dBuV)	Factor (dB/m)	Limit (dBuV/m)	Margin (dB)	Antenna Height (cm)	Table Angle (Degree)	Remark
*1830.5	38.62	62.13	-23.51	95.84	-57.22	112	154	Average
*1830.5	40.62	64.13	-23.51	97.35	-56.73	112	154	Peak
Antenna Polarity & Test Distance: Vertical at 3 m								
Frequency (MHz)	Emission Level (dBuV/m)	Read Level (dBuV)	Factor (dB/m)	Limit (dBuV/m)	Margin (dB)	Antenna Height (cm)	Table Angle (Degree)	Remark
*1830.5	36.85	60.36	-23.51	95.85	-59	124	159	Average
*1830.5	39.81	63.32	-23.51	97.75	-57.94	124	159	Peak

Remarks:

- Emission Level = Read Level + Factor  
Margin value = Emission level – Limit value
- 915.25 MHz: Fundamental frequency.
- \*: Out of Restricted Band
- The emission levels of other frequencies were very low against the limit.

EUT Test Condition		Measurement Detail	
Channel	Channel 49	Frequency Range	1 GHz ~ 10 GHz
Input Power	120 Vac, 60 Hz	Detector Function	Peak (PK) Average (AV)
Environmental Conditions	25 deg. C, 65 % RH	Tested By	Tim Chen

Antenna Polarity & Test Distance: Horizontal at 3 m								
Frequency (MHz)	Emission Level (dBuV/m)	Read Level (dBuV)	Factor (dB/m)	Limit (dBuV/m)	Margin (dB)	Antenna Height (cm)	Table Angle (Degree)	Remark
*1854.5	36.35	59.77	-23.42	95.47	-59.12	139	151	Average
*1854.5	38.03	61.45	-23.42	96.81	-58.78	139	151	Peak
Antenna Polarity & Test Distance: Vertical at 3 m								
Frequency (MHz)	Emission Level (dBuV/m)	Read Level (dBuV)	Factor (dB/m)	Limit (dBuV/m)	Margin (dB)	Antenna Height (cm)	Table Angle (Degree)	Remark
*1854.5	36.1	59.52	-23.42	95.83	-59.73	128	94	Average
*1854.5	39.28	62.7	-23.42	96.94	-57.66	128	94	Peak

Remarks:

- Emission Level = Read Level + Factor  
Margin value = Emission level – Limit value
- 927.25 MHz: Fundamental frequency.
- \*: Out of Restricted Band
- The emission levels of other frequencies were very low against the limit.

**9 kHz ~ 30 MHz Data:**

The amplitude of spurious emissions attenuated more than 20 dB below the permissible value is not required to be report.

**30 MHz ~ 1 GHz Data:**

**<Spurious Emissions Measurement>**

EUT Test Condition		Measurement Detail	
Channel	Channel 0	Frequency Range	30 MHz ~ 1 GHz
Input Power	120 Vac, 60 Hz	Detector Function	Peak (PK) Quasi-peak (QP)
Environmental Conditions	25 deg. C, 65 % RH	Tested By	Tim Chen

**Horizontal**

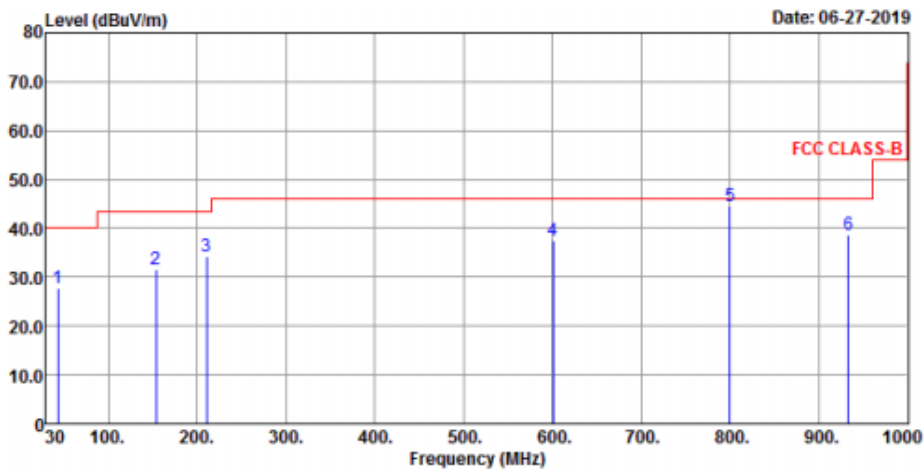

**Vertical**

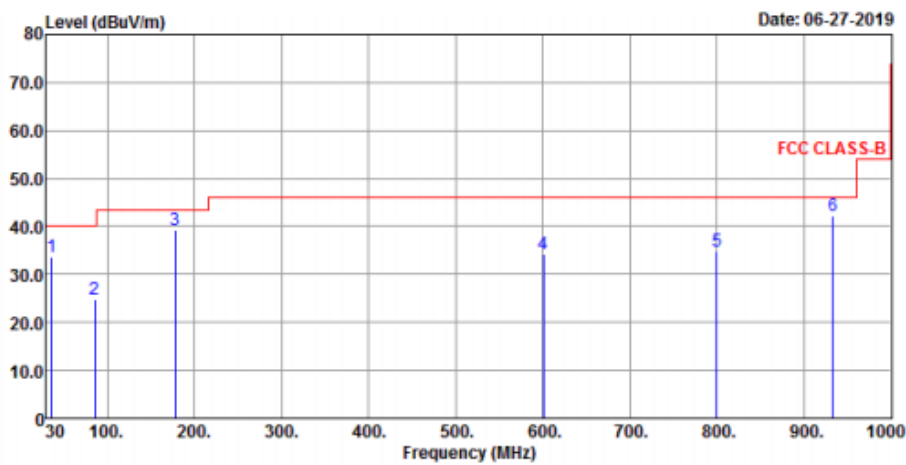

**Antenna Polarity & Test Distance: Horizontal at 3 m**

Frequency (MHz)	Emission Level (dBuV/m)	Read Level (dBuV)	Factor (dB/m)	Limit (dBuV/m)	Margin (dB)	Antenna Height (cm)	Table Angle (Degree)	Remark
43.58	27.75	44.7	-16.95	40	-12.25	131	157	Peak
154.16	31.67	48.64	-16.97	43.5	-11.83	164	179	Peak
210.42	34.29	54.12	-19.83	43.5	-9.21	186	193	Peak
600.36	37.36	45.65	-8.29	46	-8.64	223	241	Peak
800.18	44.67	49.94	-5.27	46	-1.33	256	279	Peak
933.07	38.78	41.6	-2.82	46	-7.22	289	301	Peak

**Antenna Polarity & Test Distance: Vertical at 3 m**

Frequency (MHz)	Emission Level (dBuV/m)	Read Level (dBuV)	Factor (dB/m)	Limit (dBuV/m)	Margin (dB)	Antenna Height (cm)	Table Angle (Degree)	Remark
35.82	33.77	50.94	-17.17	40	-6.23	126	142	Peak
85.29	24.81	46.97	-22.16	40	-15.19	154	167	Peak
178.41	39.23	57.49	-18.26	43.5	-4.27	189	203	Peak
600.36	34.32	42.61	-8.29	46	-11.68	215	236	Peak
800.18	34.7	39.97	-5.27	46	-11.3	256	284	Peak
933.07	42.12	44.94	-2.82	46	-3.88	294	327	Peak

Remarks:

- Emission Level = Read Level + Factor  
Margin value = Emission level – Limit value
- The emission levels of other frequencies were very low against the limit.

EUT Test Condition		Measurement Detail	
Channel	Channel 25	Frequency Range	30 MHz ~ 1 GHz
Input Power	120 Vac, 60 Hz	Detector Function	Peak (PK) Quasi-peak (QP)
Environmental Conditions	25 deg. C, 65 % RH	Tested By	Tim Chen

### Horizontal

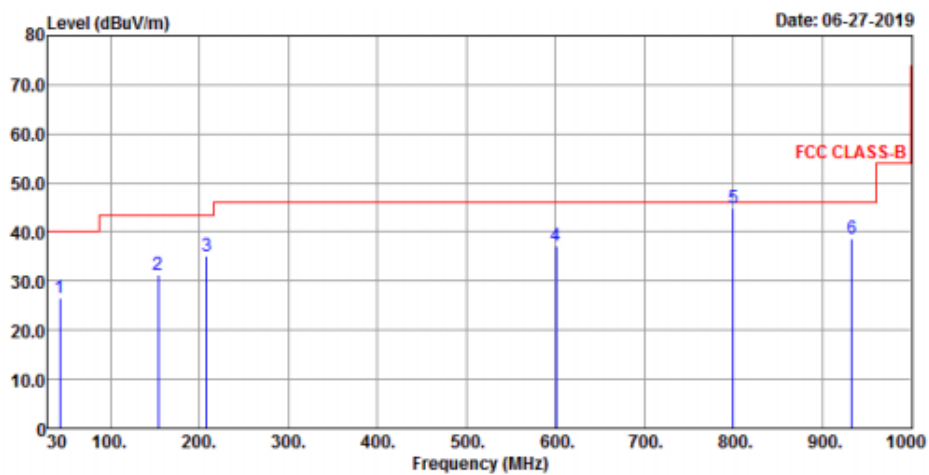

### Vertical

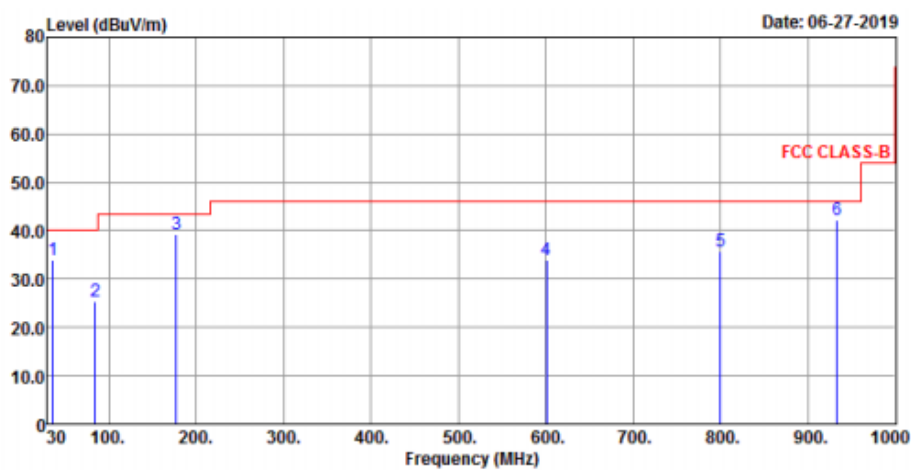

**Antenna Polarity & Test Distance: Horizontal at 3 m**

Frequency (MHz)	Emission Level (dBuV/m)	Read Level (dBuV)	Factor (dB/m)	Limit (dBuV/m)	Margin (dB)	Antenna Height (cm)	Table Angle (Degree)	Remark
43.58	26.53	43.48	-16.95	40	-13.47	137	149	Peak
154.16	31.23	48.2	-16.97	43.5	-12.27	164	172	Peak
208.48	35.1	54.93	-19.83	43.5	-8.4	189	203	Peak
600.36	37.19	45.48	-8.29	46	-8.81	234	261	Peak
<b>800.18</b>	<b>44.95</b>	<b>50.22</b>	<b>-5.27</b>	<b>46</b>	<b>-1.05</b>	<b>281</b>	<b>298</b>	<b>Peak</b>
933.07	38.59	41.41	-2.82	46	-7.41	315	332	Peak

**Antenna Polarity & Test Distance: Vertical at 3 m**

Frequency (MHz)	Emission Level (dBuV/m)	Read Level (dBuV)	Factor (dB/m)	Limit (dBuV/m)	Margin (dB)	Antenna Height (cm)	Table Angle (Degree)	Remark
35.82	33.97	51.14	-17.17	40	-6.03	128	136	Peak
84.32	25.31	47.33	-22.02	40	-14.69	149	155	Peak
177.44	39.36	57.58	-18.22	43.5	-4.14	185	193	Peak
600.36	33.99	42.28	-8.29	46	-12.01	234	256	Peak
800.18	35.6	40.87	-5.27	46	-10.4	278	291	Peak
933.07	42.32	45.14	-2.82	46	-3.68	306	325	Peak

Remarks:

- Emission Level = Read Level + Factor  
Margin value = Emission level – Limit value
- The emission levels of other frequencies were very low against the limit.

EUT Test Condition		Measurement Detail	
Channel	Channel 49	Frequency Range	30 MHz ~ 1 GHz
Input Power	120 Vac, 60 Hz	Detector Function	Peak (PK) Quasi-peak (QP)
Environmental Conditions	25 deg. C, 65 % RH	Tested By	Tim Chen

**Horizontal**

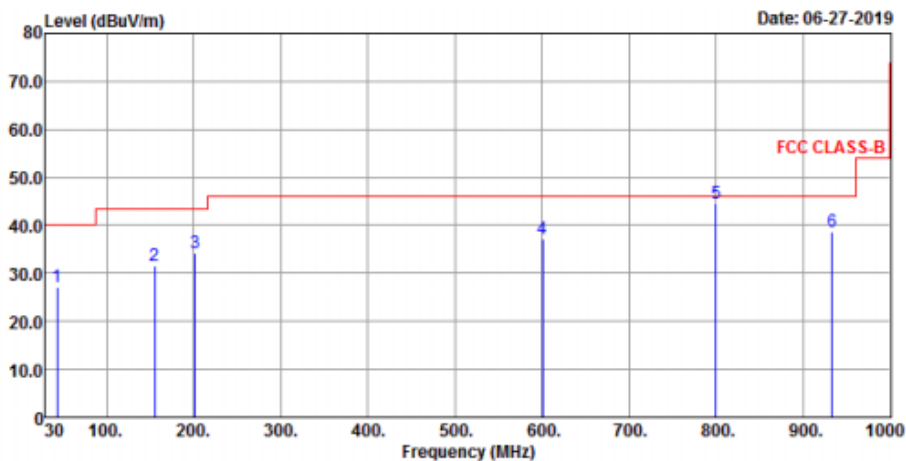

**Vertical**

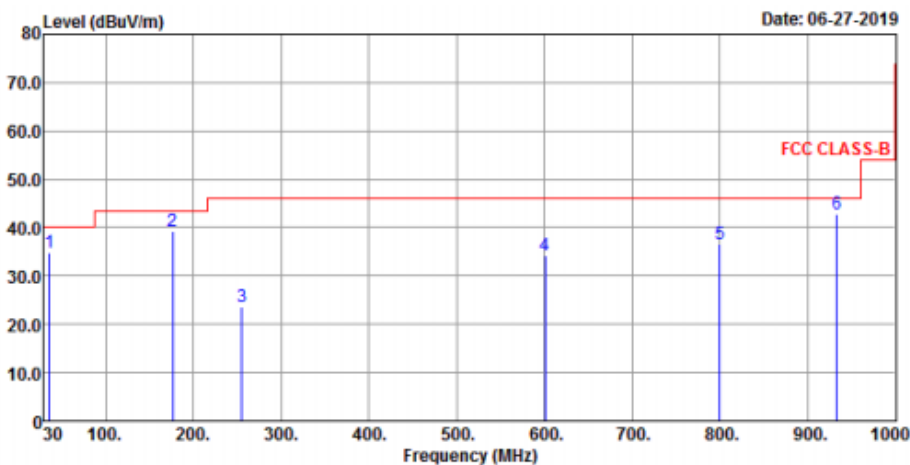



**Antenna Polarity & Test Distance: Horizontal at 3 m**

Frequency (MHz)	Emission Level (dBuV/m)	Read Level (dBuV)	Factor (dB/m)	Limit (dBuV/m)	Margin (dB)	Antenna Height (cm)	Table Angle (Degree)	Remark
43.58	27.27	44.22	-16.95	40	-12.73	137	146	Peak
155.13	31.47	48.71	-17.24	43.5	-12.03	159	167	Peak
201.69	34.24	54.03	-19.79	43.5	-9.26	199	214	Peak
600.36	37.34	45.63	-8.29	46	-8.66	245	251	Peak
800.18	44.53	49.8	-5.27	46	-1.47	279	288	Peak
933.07	38.69	41.51	-2.82	46	-7.31	304	318	Peak

**Antenna Polarity & Test Distance: Vertical at 3 m**

Frequency (MHz)	Emission Level (dBuV/m)	Read Level (dBuV)	Factor (dB/m)	Limit (dBuV/m)	Margin (dB)	Antenna Height (cm)	Table Angle (Degree)	Remark
35.82	34.8	51.97	-17.17	40	-5.2	136	149	Peak
176.47	39.2	57.29	-18.09	43.5	-4.3	158	167	Peak
255.04	23.62	41.14	-17.52	46	-22.38	184	195	Peak
600.36	34.26	42.55	-8.29	46	-11.74	233	251	Peak
800.18	36.62	41.89	-5.27	46	-9.38	279	284	Peak
933.07	42.86	45.68	-2.82	46	-3.14	322	337	Peak

Remarks:

- Emission Level = Read Level + Factor  
Margin value = Emission level – Limit value
- The emission levels of other frequencies were very low against the limit.

<Band Edge Measurement>

EUT Test Condition		Measurement Detail	
Channel	Channel 0	Frequency Range	30 MHz ~ 1 GHz
Input Power	120 Vac, 60 Hz	Detector Function	Average (AV) Peak (PK) or Quasi-peak (QP)
Environmental Conditions	25 deg. C, 65 % RH	Tested By	Tim Chen

Horizontal

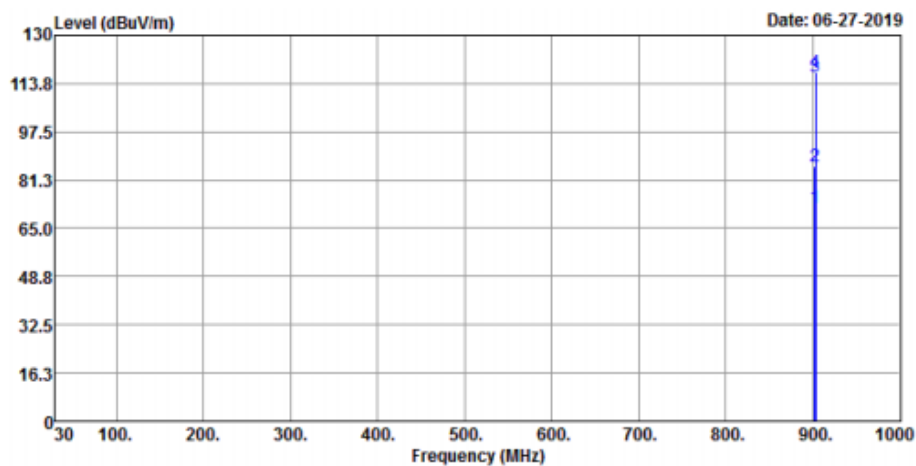

Vertical

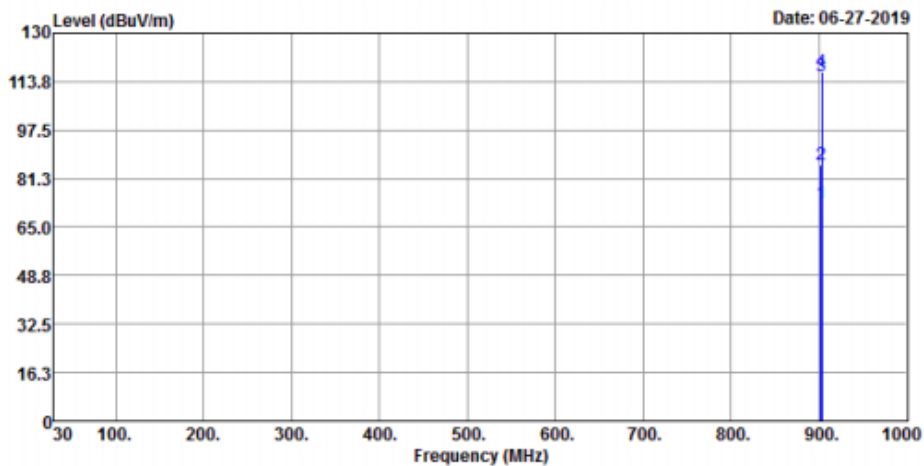

**Antenna Polarity & Test Distance: Horizontal at 3 m**

Frequency (MHz)	Emission Level (dBuV/m)	Read Level (dBuV)	Factor (dB/m)	Limit (dBuV/m)	Margin (dB)	Antenna Height (cm)	Table Angle (Degree)	Remark
*902	71.80	76.25	-4.45	96.02	-24.22	154	224	Average
*902	85.71	90.16	-4.45	97.52	-11.81	154	224	QP
902.75	116.02	120.46	-4.44	-----	-----	154	224	Average
902.75	117.52	121.96	-4.44	-----	-----	154	224	QP

**Antenna Polarity & Test Distance: Vertical at 3 m**

Frequency (MHz)	Emission Level (dBuV/m)	Read Level (dBuV)	Factor (dB/m)	Limit (dBuV/m)	Margin (dB)	Antenna Height (cm)	Table Angle (Degree)	Remark
*902	72.71	77.16	-4.45	95.71	-23.00	110	204	Average
*902	85.91	90.36	-4.45	97.19	-11.28	110	204	QP
902.75	115.71	120.15	-4.44	-----	-----	110	204	Average
902.75	117.19	121.63	-4.44	-----	-----	110	204	QP

Remarks:

- Emission Level = Read Level + Factor  
Margin value = Emission level – Limit value
- The emission levels of other frequencies were very low against the limit.

EUT Test Condition		Measurement Detail	
Channel	Channel 25	Frequency Range	30 MHz ~ 1 GHz
Input Power	120 Vac, 60 Hz	Detector Function	Average (AV) Peak (PK) or Quasi-peak (QP)
Environmental Conditions	25 deg. C, 65 % RH	Tested By	Tim Chen

### Horizontal

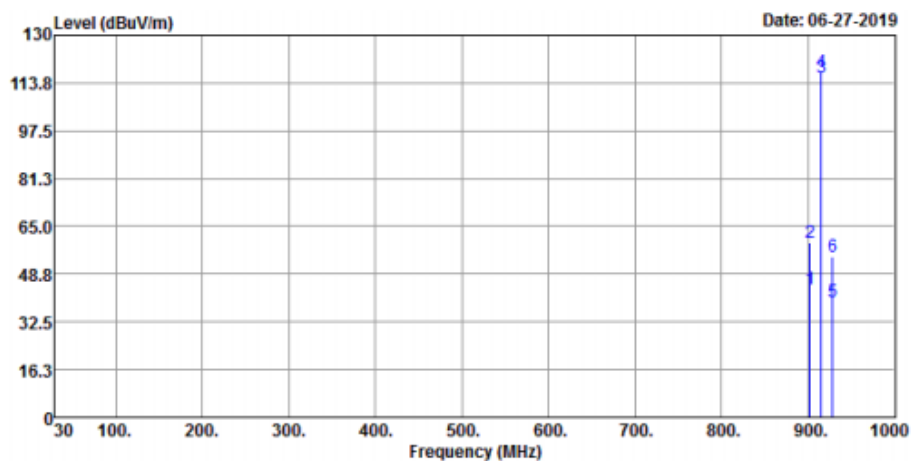

### Vertical

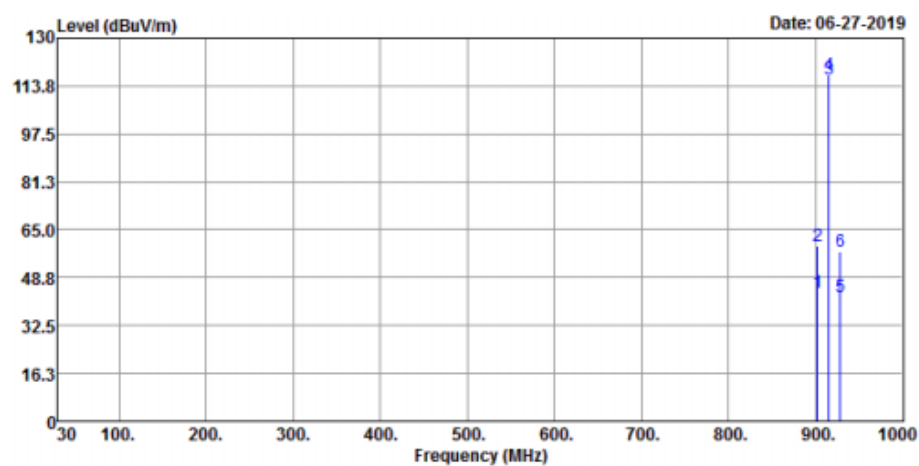

**Antenna Polarity & Test Distance: Horizontal at 3 m**

Frequency (MHz)	Emission Level (dBuV/m)	Read Level (dBuV)	Factor (dB/m)	Limit (dBuV/m)	Margin (dB)	Antenna Height (cm)	Table Angle (Degree)	Remark
*902	43.88	48.33	-4.45	95.84	-51.96	147	200	Average
*902	59.67	64.12	-4.45	97.35	-37.68	147	200	QP
915.25	115.84	120.15	-4.31	-----	-----	147	200	Average
915.25	117.35	121.66	-4.31	-----	-----	147	200	QP
*928	39.18	43.34	-4.16	95.84	-56.66	147	200	Average
*928	54.58	58.74	-4.16	97.35	-42.77	147	200	QP

**Antenna Polarity & Test Distance: Vertical at 3 m**

Frequency (MHz)	Emission Level (dBuV/m)	Read Level (dBuV)	Factor (dB/m)	Limit (dBuV/m)	Margin (dB)	Antenna Height (cm)	Table Angle (Degree)	Remark
*902	43.86	48.31	-4.45	95.85	-51.99	113	180	Average
*902	59.33	63.78	-4.45	97.75	-38.42	113	180	QP
915.25	115.85	120.16	-4.31	-----	-----	113	180	Average
915.25	117.75	122.06	-4.31	-----	-----	113	180	QP
*928.22	42.32	46.48	-4.16	95.85	-53.53	113	180	Average
*928.22	57.77	61.93	-4.16	97.75	-39.98	113	180	QP

Remarks:

- Emission Level = Read Level + Factor  
Margin value = Emission level – Limit value
- The emission levels of other frequencies were very low against the limit.

EUT Test Condition		Measurement Detail	
Channel	Channel 49	Frequency Range	30 MHz ~ 1 GHz
Input Power	120 Vac, 60 Hz	Detector Function	Average (AV) Peak (PK) or Quasi-peak (QP)
Environmental Conditions	25 deg. C, 65 % RH	Tested By	Tim Chen

### Horizontal

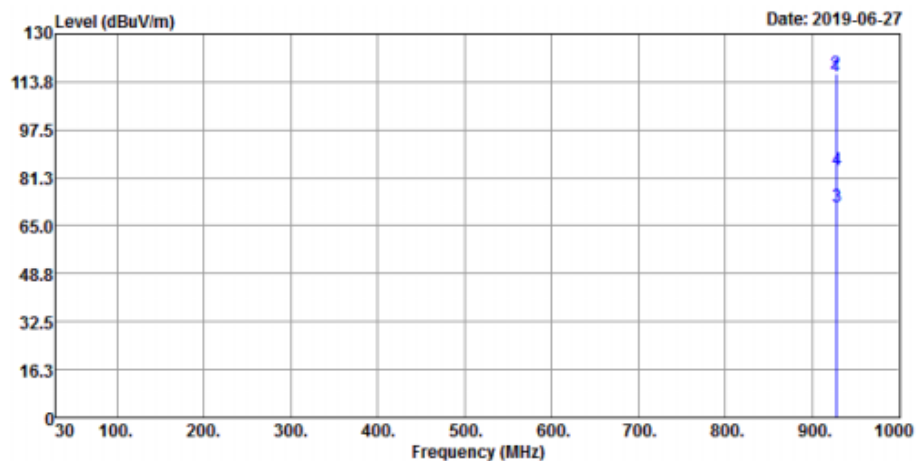

### Vertical

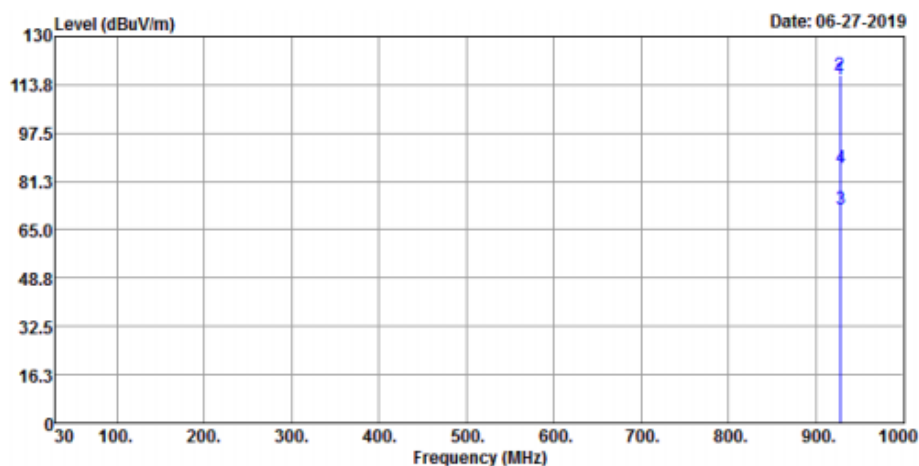

**Antenna Polarity & Test Distance: Horizontal at 3 m**

Frequency (MHz)	Emission Level (dBuV/m)	Read Level (dBuV)	Factor (dB/m)	Limit (dBuV/m)	Margin (dB)	Antenna Height (cm)	Table Angle (Degree)	Remark
927.25	115.47	119.65	-4.18	-----	-----	142	199	Average
927.25	116.81	120.99	-4.18	-----	-----	142	199	QP
*928	71.47	75.63	-4.16	95.47	-24	142	199	Average
*928	84.05	88.21	-4.16	96.81	-12.76	142	199	QP

**Antenna Polarity & Test Distance: Vertical at 3 m**

Frequency (MHz)	Emission Level (dBuV/m)	Read Level (dBuV)	Factor (dB/m)	Limit (dBuV/m)	Margin (dB)	Antenna Height (cm)	Table Angle (Degree)	Remark
927.25	115.83	120.01	-4.18	-----	-----	110	204	Average
927.25	116.94	121.12	-4.18	-----	-----	110	204	QP
*928	72.09	76.25	-4.16	95.83	-23.74	110	204	Average
<b>*928</b>	<b>85.99</b>	<b>90.15</b>	<b>-4.16</b>	<b>96.94</b>	<b>-10.95</b>	<b>110</b>	<b>204</b>	<b>QP</b>

Remarks:

- Emission Level = Read Level + Factor  
Margin value = Emission level – Limit value
- The emission levels of other frequencies were very low against the limit.

## 4.2 Conducted Emission Measurement

### 4.2.1 Limits of Conducted Emission Measurement

Frequency (MHz)	Conducted Limit (dBuV)	
	Quasi-Peak	Average
0.15 - 0.5	66 - 56	56 - 46
0.50 - 5.0	56	46
5.0 - 30.0	60	50

- Note: 1. The lower limit shall apply at the transition frequencies.  
 2. The limit decreases in line with the logarithm of the frequency in the range of 0.15 to 0.50 MHz.

### 4.2.2 Test Instruments

Description & Manufacturer	Model No.	Serial No.	Date of Calibration	Due Date of Calibration
Test Receiver ROHDE & SCHWARZ	ESCI	100613	Dec. 10, 2018	Dec. 09, 2019
RF signal cable (with 10dB PAD) Woken	5D-FB	Cable-cond1-01	Sep. 05, 2018	Sep. 04, 2019
LISN ROHDE & SCHWARZ (EUT)	ENV216	101826	Feb. 21, 2019	Feb. 20, 2020
LISN ROHDE & SCHWARZ (Peripheral)	ESH3-Z5	100311	Aug. 19, 2018	Aug. 18, 2019
Software ADT	BV ADT_Cond_ V7.3.7.4	NA	NA	NA

- Note: 1. The calibration interval of the above test instruments is 12 months and the calibrations are traceable to NML/ROC and NIST/USA.  
 2. The test was performed in HwaYa Shielded Room 1.  
 3. The VCCI Site Registration No. is C-12040.



#### 4.2.3 Test Procedures

- The EUT was placed 0.4 meters from the conducting wall of the shielded room with EUT being connected to the power mains through a line impedance stabilization network (LISN). Other support units were connected to the power mains through another LISN. The two LISNs provide 50 ohm/ 50 uH of coupling impedance for the measuring instrument.
- Both lines of the power mains connected to the EUT were checked for maximum conducted interference.
- The frequency range from 150 kHz to 30 MHz was searched. Emission levels under (Limit – 20 dB) was not recorded.

**Note:** The resolution bandwidth and video bandwidth of test receiver is 9 kHz for quasi-peak detection (QP) and average detection (AV) at frequency 0.15 MHz - 30 MHz.

#### 4.2.4 Deviation from Test Standard

No deviation.

#### 4.2.5 Test Setup

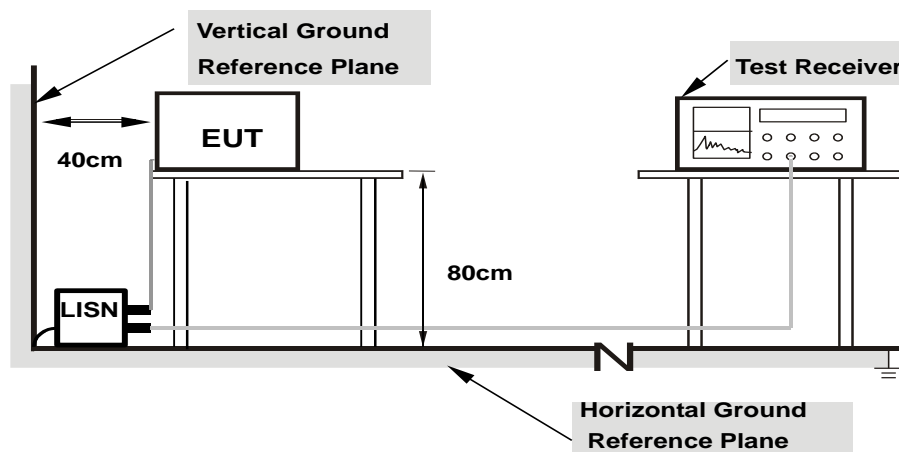

- Note:**
- Support units were connected to second LISN.
  - Both of LISNs (AMN) are 80 cm from EUT and at least 80 cm from other units and other metal planes

For the actual test configuration, please refer to the attached file (Test Setup Photo).

#### 4.2.6 EUT Operating Condition

Set the EUT under transmission condition continuously at specific channel frequency.

#### 4.2.7 Test Results

#### CONDUCTED WORST-CASE DATA : CH 25

Frequency Range	150kHz ~ 30MHz	Detector Function & Resolution Bandwidth	Quasi-Peak (QP) / Average (AV), 9kHz
Input Power	120Vac, 60Hz	Environmental Conditions	25°C, 65%RH
Tested by	Thomas Wei	Test Date	2019/6/29

Phase Of Power : Line (L)										
No	Frequency (MHz)	Correction Factor (dB)	Reading Value (dBuV)		Emission Level (dBuV)		Limit (dBuV)		Margin (dB)	
			Q.P.	AV.	Q.P.	AV.	Q.P.	AV.	Q.P.	AV.
1	0.15391	9.84	42.16	28.08	52.00	37.92	65.79	55.79	-13.79	-17.87
2	0.18508	9.85	37.37	23.33	47.22	33.18	64.25	54.25	-17.03	-21.07
3	0.23586	9.86	30.64	16.11	40.50	25.97	62.24	52.24	-21.74	-26.27
4	0.29506	9.86	21.41	9.11	31.27	18.97	60.38	50.38	-29.11	-31.41
5	0.39242	9.88	14.43	2.73	24.31	12.61	58.01	48.01	-33.70	-35.40
6	15.56322	10.21	19.62	6.66	29.83	16.87	60.00	50.00	-30.17	-33.13

#### Remarks:

1. Q.P. and AV. are abbreviations of quasi-peak and average individually.
2. The emission levels of other frequencies were very low against the limit.
3. Margin value = Emission level – Limit value
4. Correction factor = Insertion loss + Cable loss
5. Emission Level = Correction Factor + Reading Value

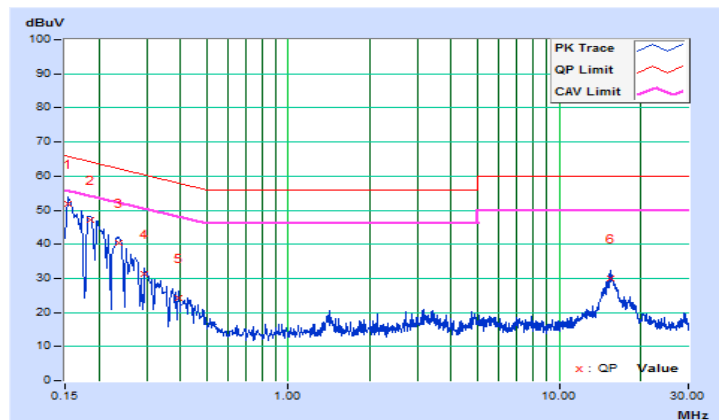

Frequency Range	150kHz ~ 30MHz	Detector Function & Resolution Bandwidth	Quasi-Peak (QP) / Average (AV), 9kHz
Input Power	120Vac, 60Hz	Environmental Conditions	25°C, 65%RH
Tested by	Thomas Wei	Test Date	2019/6/29

Phase Of Power : Neutral (N)										
No	Frequency (MHz)	Correction Factor (dB)	Reading Value (dBuV)		Emission Level (dBuV)		Limit (dBuV)		Margin (dB)	
			Q.P.	AV.	Q.P.	AV.	Q.P.	AV.	Q.P.	AV.
1	0.16173	9.82	38.78	24.58	48.60	34.40	65.37	55.37	-16.77	-20.97
2	0.18910	9.84	34.33	21.80	44.17	31.64	64.08	54.08	-19.91	-22.44
3	0.21282	9.84	31.91	17.57	41.75	27.41	63.09	53.09	-21.34	-25.68
4	0.24472	9.85	27.14	14.09	36.99	23.94	61.93	51.93	-24.94	-27.99
5	0.28685	9.85	21.76	7.07	31.61	16.92	60.62	50.62	-29.01	-33.70
6	15.85647	10.25	17.07	2.71	27.32	12.96	60.00	50.00	-32.68	-37.04

Remarks:

1. Q.P. and AV. are abbreviations of quasi-peak and average individually.
2. The emission levels of other frequencies were very low against the limit.
3. Margin value = Emission level – Limit value
4. Correction factor = Insertion loss + Cable loss
5. Emission Level = Correction Factor + Reading Value

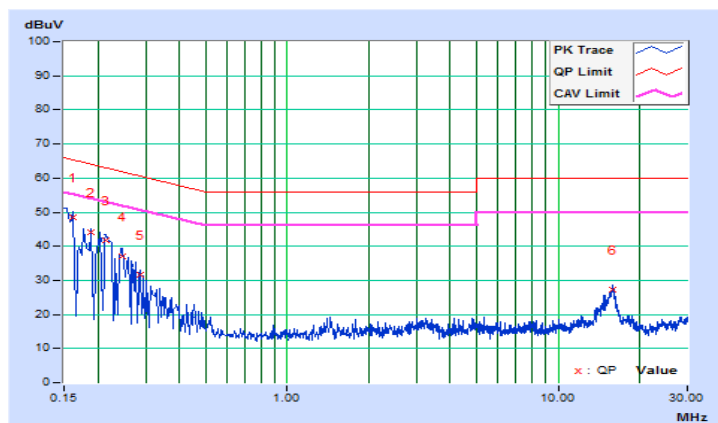

### 4.3 Number of Hopping Frequency Used

#### 4.3.1 Limits of Hopping Frequency Used Measurement

The 20 dB bandwidth of the hopping channel is less than 250 kHz, at least 50 channels frequencies, and should be equally spaced.

#### 4.3.2 Test Setup

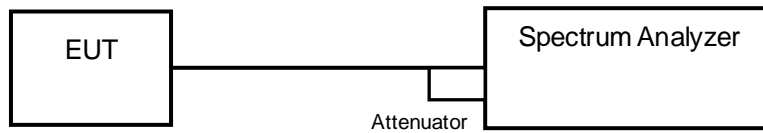

#### 4.3.3 Test Instruments

Refer to section 4.1.2 to get information of above instrument.

#### 4.3.4 Test Procedure

- Check the calibration of the measuring instrument (SA) using either an internal calibrator or a known signal from an external generator.
- Turn on the EUT and connect its antenna terminal to measurement via a low loss cable. Then set it to any one measured frequency within its operating range and make sure the instrument is operated in its linear range.
- Set the SA on MaxHold Mode, and then keep the EUT in hopping mode. Record all the signals from each channel until each one has been recorded.
- Set the SA on View mode and then plot the result on SA screen.
- Repeat above procedures until all frequencies measured were complete.

#### 4.3.5 Deviation from Test Standard

No deviation.

#### 4.3.6 Test Results

There are 50 hopping frequencies in the hopping mode. Please refer to the following test result. On the plots, it shows that the hopping frequencies are equally spaced.

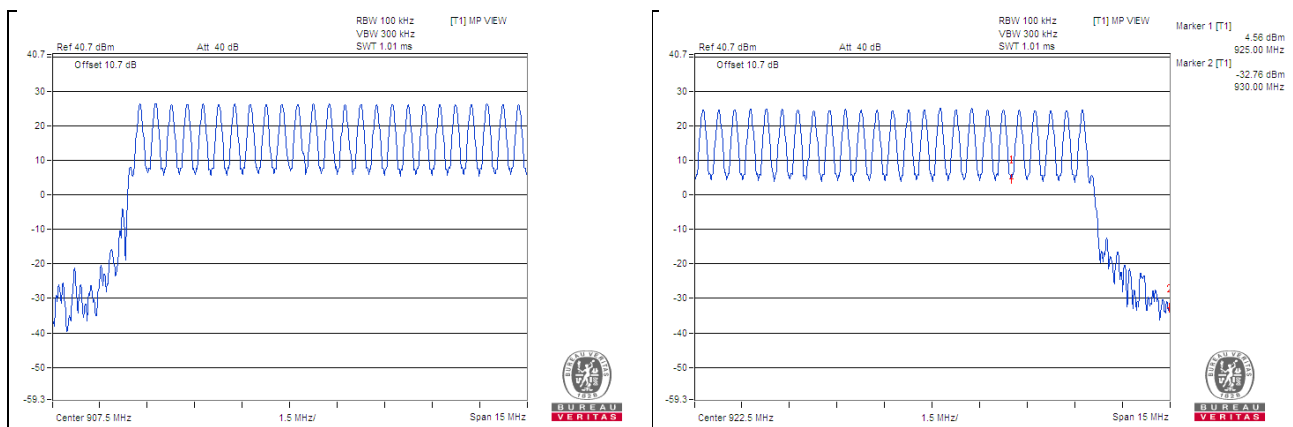

#### 4.4 Dwell Time on Each Channel

##### 4.4.1 Limits of Dwell Time on Each Channel Measurement

The average time of occupancy on any frequency shall not be greater than 0.4 seconds within a 20 second period. (If the 20 dB bandwidth of the hopping channel is less than 250 kHz)

##### 4.4.2 Test Setup

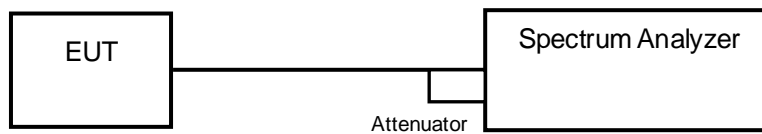

##### 4.4.3 Test Instruments

Refer to section 4.1.2 to get information of above instrument.

##### 4.4.4 Test Procedures

- a. Check the calibration of the measuring instrument (SA) using either an internal calibrator or a known signal from an external generator.
- b. Turn on the EUT and connect its antenna terminal to measurement via a low loss cable. Then set it to any one measured frequency within its operating range and make sure the instrument is operated in its linear range.
- c. Adjust the center frequency of SA on any frequency be measured and set SA to zero span mode. And then, set RBW and VBW of spectrum analyzer to proper value.
- d. Measure the time duration of one transmission on the measured frequency. And then plot the result with time difference of this time duration.
- e. Repeat above procedures until all different time-slot modes have been completed.

##### 4.4.5 Deviation from Test Standard

No deviation.

#### 4.4.6 Test Results

Number of Transmission in a 20 (50 Hopping*0.4)	Length of Transmission Time (msec)	Result (msec)	Limit (sec)
5 (times / 20 sec) * 1 = 5 times	78	390	0.4

**Note:** Test plots of the transmitting time slot are shown as below.

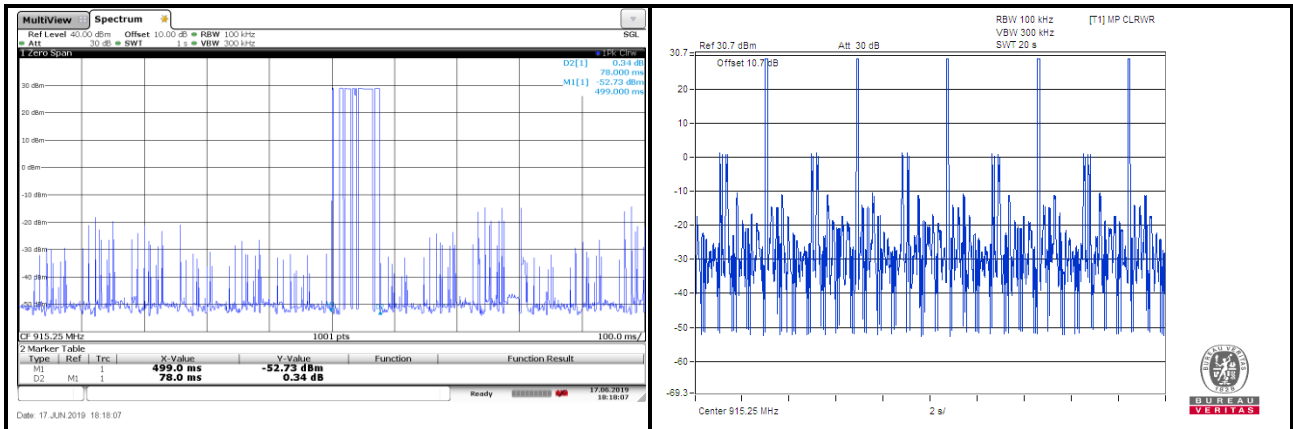

## 4.5 Channel Bandwidth

### 4.5.1 Limits of Channel Bandwidth Measurement

The maximum allowed 20 dB bandwidth of the hopping channel is 500 kHz.

### 4.5.2 Test Setup

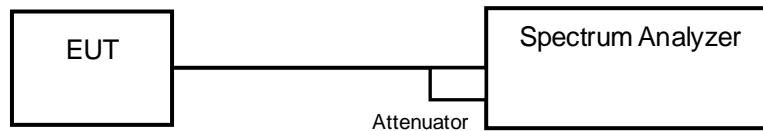

### 4.5.3 Test Instruments

Refer to section 4.1.2 to get information of above instrument.

### 4.5.4 Test Procedure

- Check the calibration of the measuring instrument using either an internal calibrator or a known signal from an external generator.
- Turn on the EUT and connect it to measurement instrument. Then set it to any one convenient frequency within its operating range. Set a reference level on the measuring instrument equal to the highest peak value.
- Measure the frequency difference of two frequencies that were attenuated 20 dB from the reference level. Record the frequency difference as the emission bandwidth.
- Repeat above procedures until all frequencies measured were complete.

### 4.5.5 Deviation from Test Standard

No deviation.

### 4.5.6 EUT Operating Condition

The software provided by client enabled the EUT to transmit and receive data at lowest, middle and highest channel frequencies individually.

#### 4.5.7 Test Results

Channel	Frequency (MHz)	20 dB Bandwidth (MHz)	Limit (MHz)
0	902.75	0.17	<0.5
25	915.25	0.17	<0.5
49	927.25	0.17	<0.5

Note: 20 dB bandwidth of the hopping channel is less than 250 kHz, the system shall use at least 50 hopping frequencies and the average time of occupancy on any frequency shall not be greater than 0.4 seconds within a 20 second period.

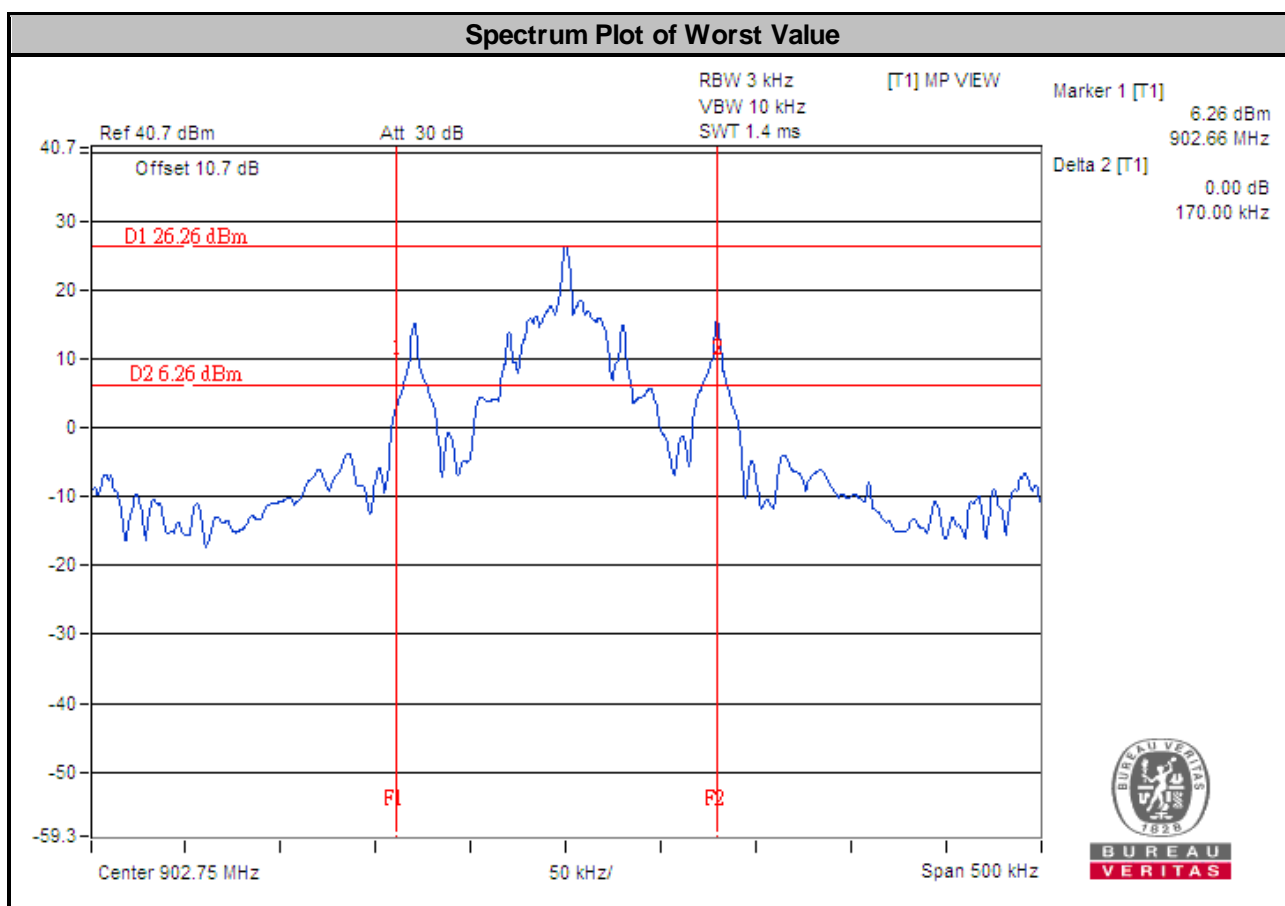



## 4.6 Occupied Bandwidth Measurement

### 4.6.1 Test Setup

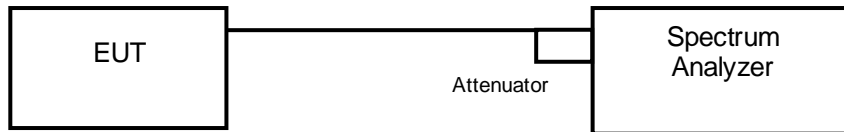

### 4.6.2 Test Instruments

Refer to section 4.1.2 to get information of above instrument

### 4.6.3 Test Procedure

The transmitter output was connected to the spectrum analyzer through an attenuator. The bandwidth of the fundamental frequency was measured by spectrum analyzer with resolution bandwidth in the range of 1 % to 5 % of the anticipated emission bandwidth, and a video bandwidth at least 3x the resolution bandwidth and set the detector to PEAK. The width of a frequency band such that, below the lower and above the upper frequency limits, the mean powers emitted are each equal to a specified percentage 0.5 % of the total mean power of a given emission.

### 4.6.4 Deviation from Test Standard

No deviation.

### 4.6.5 EUT Operating Conditions

The software provided by client to enable the EUT under transmission condition continuously at lowest, middle and highest channel frequencies individually.

#### 4.6.6 Test Results

Channel	Frequency (MHz)	Occupied Bandwidth (MHz)
0	902.75	0.18
25	915.25	0.18
49	927.25	0.18

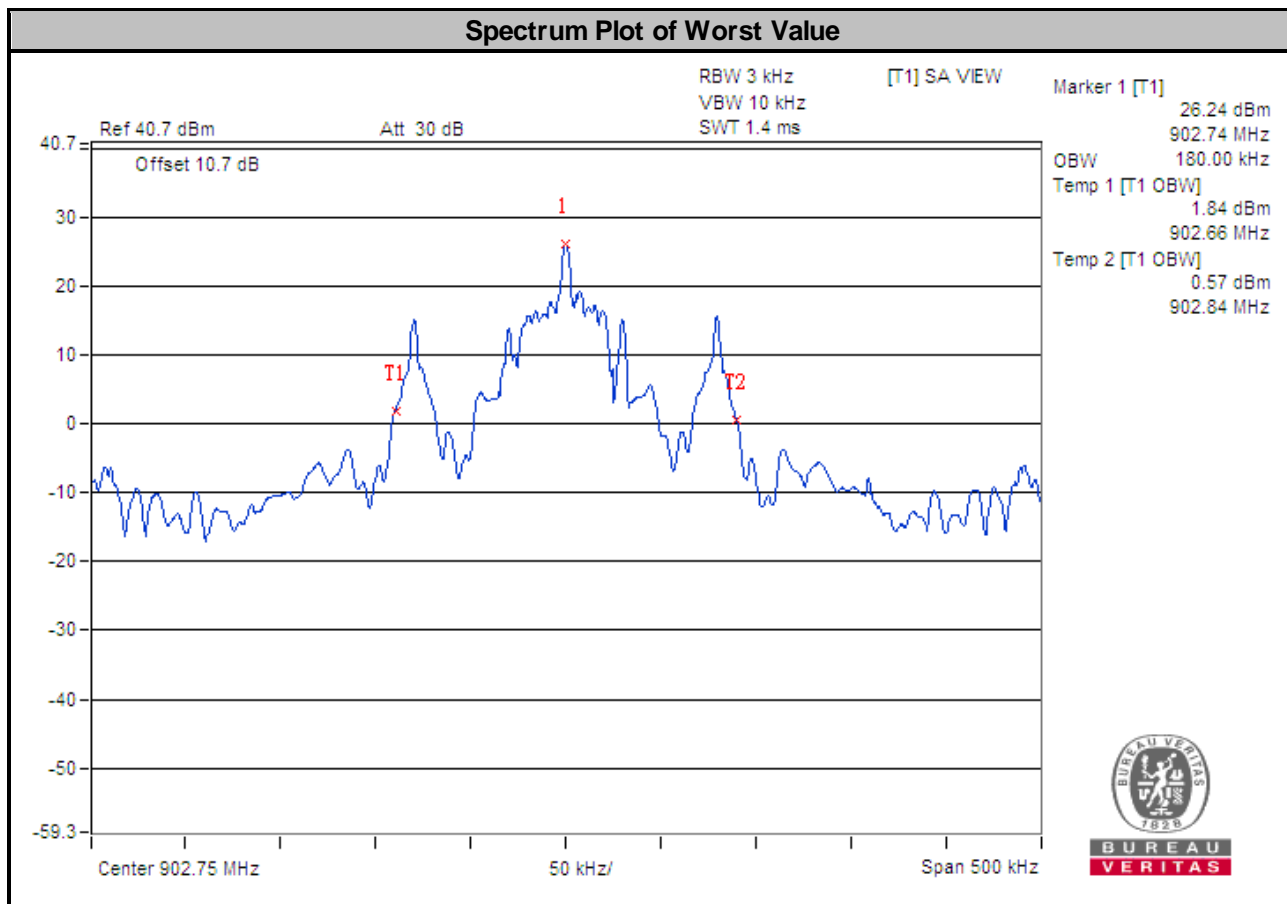

## 4.7 Hopping Channel Separation

### 4.7.1 Limits of Hopping Channel Separation Measurement

At least 25 kHz or 20dB hopping channel bandwidth (whichever is greater).

### 4.7.2 Test Setup

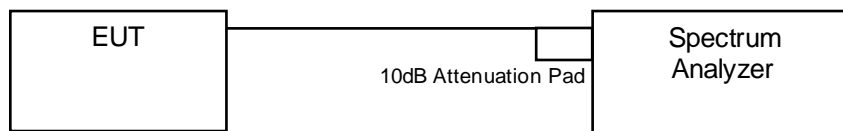

### 4.7.3 Test Instruments

Refer to section 4.1.2 to get information of above instrument.

### 4.7.4 Test Procedure

- Check the calibration of the measuring instrument using either an internal calibrator or a known signal from an external generator.
- Turn on the EUT and connect it to measurement instrument. Then set it to any one convenient frequency within its operating range.
- By using the MaxHold function record the separation of two adjacent channels.
- Measure the frequency difference of these two adjacent channels by SA MARK function. And then plot the result on SA screen.
- Repeat above procedures until all frequencies measured were complete.

### 4.7.5 Deviation from Test Standard

No deviation.

#### 4.7.6 Test Results

Channel	Frequency (MHz)	Adjacent Channel Separation (MHz)	Minimum Limit (MHz)	Pass / Fail
0	902.75	0.505	0.17	Pass
25	915.25	0.503	0.17	Pass
49	927.25	0.502	0.17	Pass

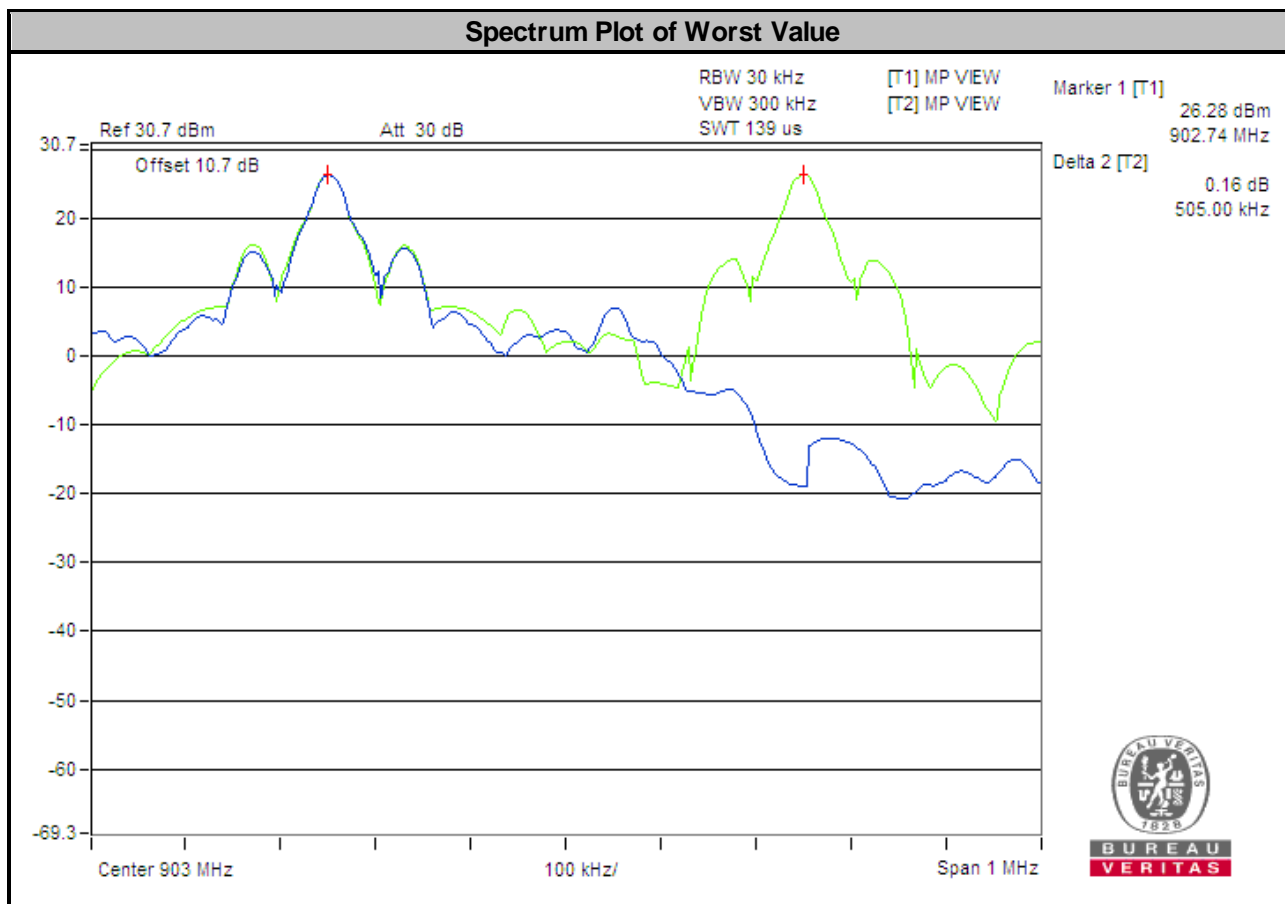

## 4.8 Maximum Output Power

### 4.8.1 Limits of Maximum Output Power Measurement

The Maximum Output Power Measurement is 30dBm.

### 4.8.2 Test Setup

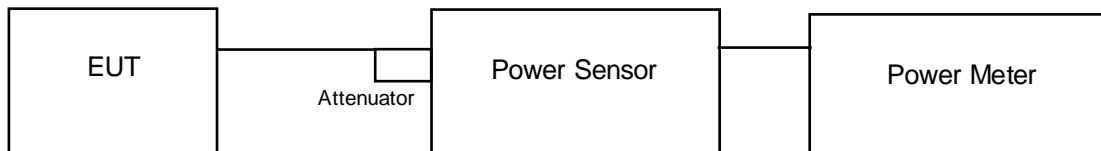

### 4.8.3 Test Instruments

Refer to section 4.1.2 to get information of above instrument.

### 4.8.4 Test Procedure

A peak power sensor was used on the output port of the EUT. A power meter was used to read the response of the peak power sensor. Record the power level.

### 4.8.5 Deviation from Test Standard

No deviation.

### 4.8.6 EUT Operating Condition

The software provided by client enabled the EUT to transmit and receive data at lowest, middle and highest channel frequencies individually.

### 4.8.7 Test Results

Channel	Freq. (MHz)	Output Power (mW)	Output Power (dBm)	Power Limit (dBm)	Pass / Fail
0	902.75	<b>939.723</b>	29.73	30.00	Pass
25	915.25	820.352	29.14	30.00	Pass
49	927.25	632.412	28.01	30.00	Pass

## 4.9 Conducted Out of Band Emission Measurement

### 4.9.1 Limits Of Conducted Out of Band Emission Measurement

Below  $-20$  dB of the highest emission level of operating band (in 100 kHz RBW).

### 4.9.2 Test Instruments

Refer to section 4.1.2 to get information of above instrument.

### 4.9.3 Test Procedure

The transmitter output was connected to the spectrum analyzer via a low lose cable. Set both RBW and VBW of spectrum analyzer to 100 kHz and 300 kHz with suitable frequency span including 100 MHz bandwidth from band edge. The band edges was measured and recorded.

### 4.9.4 Deviation from Test Standard

No deviation.

### 4.9.5 EUT Operating Condition

The software provided by client enabled the EUT to transmit and receive data at lowest, middle and highest channel frequencies individually.

### 4.9.6 Test Results

The spectrum plots are attached on the following images. D1 line indicates the highest level, D2 line indicates the 20 dB offset below D1. It shows compliance with the requirement.

### Hopping Disabled\_Low Channel

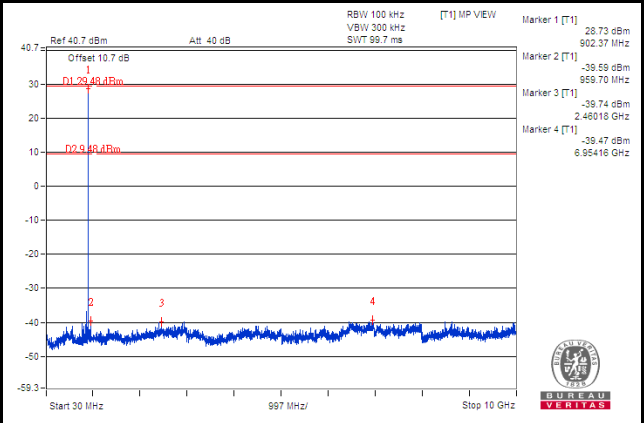
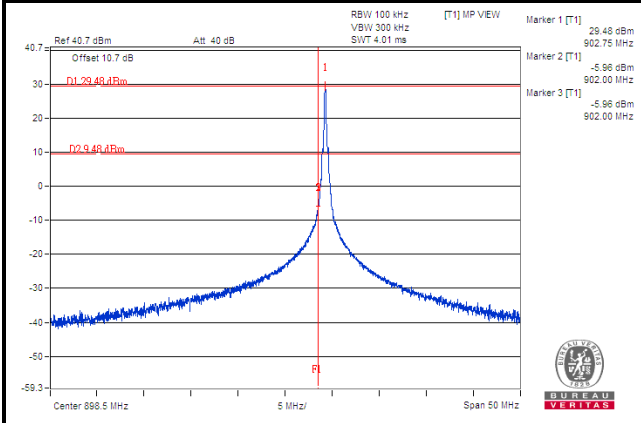

### Hopping Disabled\_High Channel

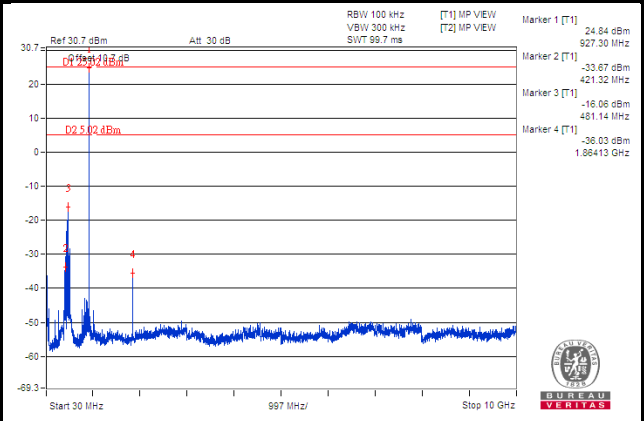
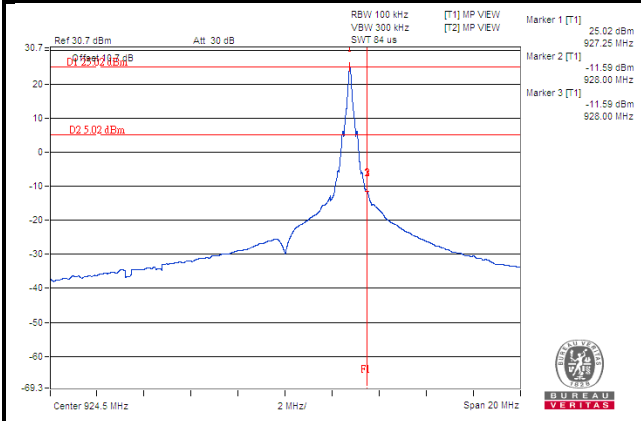

### Hopping Enabled

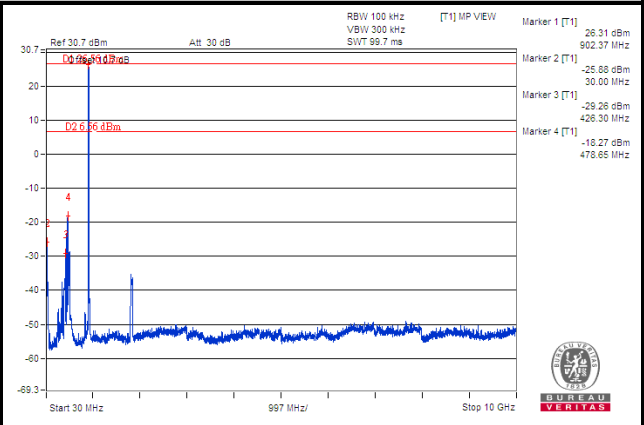
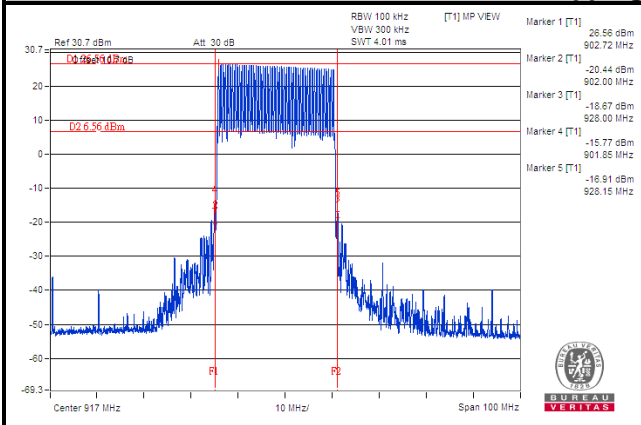

## 5 Pictures of Test Arrangements

Please refer to the attached file (Test Setup Photo).



## Appendix – Information of the Testing Laboratories

We, Bureau Veritas Consumer Products Services (H.K.) Ltd., Taoyuan Branch, were founded in 1988 to provide our best service in EMC, Radio, Telecom and Safety consultation. Our laboratories are FCC recognized accredited test firms and accredited according to ISO/IEC 17025.

If you have any comments, please feel free to contact us at the following:

### Lin kou EMC/RF Lab

Tel: 886-2-26052180

Fax: 886-2-26051924

### Hsin Chu EMC/RF/Telecom Lab

Tel: 886-3-6668565

Fax: 886-3-6668323

### Hwa Ya EMC/RF/Safety

Tel: 886-3-3183232

Fax: 886-3-3270892

**Email:** [service.adt@tw.bureauveritas.com](mailto:service.adt@tw.bureauveritas.com)

**Web Site:** [www.bureauveritas-adt.com](http://www.bureauveritas-adt.com)

The address and road map of all our labs can be found in our web site also.

--- END ---