



Modular Approval  
Test Report  
And Application for Grant of Equipment Authorization

*TEST REPORT PERTAINING TO:*

Equipment Under Test	Model Number(s)
Intel® Centrino® Ultimate-N 6200	622ANHMW

CONFIGURATION
IEEE 802.11a / 802.11b / 802.11g / 802.11n with a set of Shanghai Universe Communication Electron Co.,Ltd. Antennas

*MEASUREMENTS PERFORMED IN ACCORDANCE WITH THE FOLLOWING STANDARD (S)*

Regulatory Standard(s)
47 CFR Part 15, Subpart E Section 15.407 (UNII Devices)
Test Method: ANSI C63.4: 2003 American National Standard for Methods of Measurement of Radio-Noise Emissions from Low-Voltage Electrical and Electronic Equipment in the Range of 9 kHz to 40 GHz



Certificate Number: 1111.01

**PREPARED FOR:**

Intel Corporation  
2111 NE 25<sup>th</sup> Avenue  
Hillsboro, Oregon 97124  
Contact(s): Mr. Steve Hackett

**PREPARED BY:**

Aegis Labs, Inc.  
8 Rancho Circle  
Lake Forest, CA 92630  
Agent(s): Mr. Rick Candelas  
Mr. Johnny Candelas



Test Report #: INTEL-090602F

Test Report Revision: NONE

	REPORT BODY	APPENDICES		TOTAL PAGES
		A	B	
PAGES	22	321	1	344

The contents of this report shall not be reproduced except in full, without the written approval of Aegis Labs, Inc.  
The Intel logo is used for identification purposes only and is a registered trademark of Intel Corporation



## TABLE OF CONTENTS

SECTION	TITLE	PAGE
	<b>COVER SHEET.....</b>	<b>01</b>
	<b>TABLE OF CONTENTS.....</b>	<b>02</b>
<b>1.0</b>	<b>REGULATORY COMPLIANCE GUIDELINES.....</b>	<b>03</b>
1.1	Guidelines For Testing To Emissions Standards.....	03
<b>2.0</b>	<b>SUMMARY OF REGULATORY LIMITS.....</b>	<b>04</b>
<b>3.0</b>	<b>ADMINISTRATIVE DATA AND TEST DESCRIPTION.....</b>	<b>16</b>
<b>4.0</b>	<b>DESCRIPTION OF EUT CONFIGURATION.....</b>	<b>17</b>
4.1	EUT Description .....	17
4.2	EUT Configuration.....	18
4.3	List of EUT Sub-Assemblies and Host Equipment.....	18
4.4	I/O Cabling Diagram and Description .....	19
4.5	EMC Test Hardware and Software Measurement Equipment.....	20
<b>5.0</b>	<b>CONDITIONS DURING EMISSIONS MEASUREMENTS.....</b>	<b>21</b>
5.1	General.....	21
5.2	Conducted Emissions Test Setup.....	21
5.3	Radiated Emissions Test Setup.....	22

### APPENDICES

<b>A</b>	Test Data
<b>B</b>	Modifications And Recommendations



## 1.0 REGULATORY COMPLIANCE GUIDELINES

Aegis Labs, Inc. operates as both a Nevada and California Corporation with no organizational or financial relationship with any company, institution, or private individual. Testing and engineering functions provided by Aegis Labs were furnished by RF technicians and engineers with accredited qualifications and training credentials to carry out their duties.

The object of this report was to publish verifiable test results of an EUT subjected to the tests outlined in the standard listed on the cover page of this report.

### 1.1 Guidelines For Testing To Emissions Standards

This standard for EMC emission requirements apply to electrical equipment for Information Technology Equipment (ITE). Compliance to these standards and in combination with the other standards listed in this test report can be used to demonstrate presumption of compliance with the protection requirements of the appropriate agency standard.

The purpose of this standard is to specify minimum requirements for emissions regarding electromagnetic compatibility (EMC) and protect the radio frequency spectrum 9 kHz. – 400 GHz. from unwanted interference generated from electrical/digital systems that intentionally or unintentionally generated RF energy. The emissions standards, normative documents and/or publications were used to conduct all tests performed on the equipment herein referred to as “Equipment Under Test”.



**2.0 SUMMARY OF TEST RESULTS**

**802.11a Mode (5150-5350 MHz) Chain A**

<b>EMISSIONS STANDARD</b>			
<b>FCC Part 15 Section</b>	<b>Description</b>	<b>Results</b>	<b>Comments</b>
<b>Operation in the 5.15-5.25 GHz Band</b>			
15.407(d)	Any UNII device shall use a transmitting antenna that is an integral part of the device.	PASSED	The antenna will be integral when installed in a notebook computer
15.407(e)	UNII devices will be restricted to indoor operations.	PASSED	Refer to "User's Manual" Exhibit
15.407(a)(1)	26dB emissions bandwidth in MHz.	N/A	5.18 GHz = 25.58 MHz 5.20 GHz = 28.50 MHz 5.24 GHz = 23.50 MHz
15.407(a)(1)	Maximum Conducted Output Power shall not exceed the lesser of 50mW or 4dBm+10logB (where B = 26dB emissions bandwidth).	PASSED	5.18 GHz = 16.64dBm (46.17mW) 5.20 GHz = 16.84dBm (48.35mW) 5.24 GHz = 16.44dBm (44.09mW)
15.407(a)(1)	The peak power spectral density shall not exceed 4dBm in any 1MHz band.	PASSED	5.18 GHz = 1.240dBm 5.20 GHz = 1.851dBm 5.24 GHz = 2.120dBm
15.407(a)(1)	Maximum Conducted Output Power and the peak power spectral density shall be reduced by the amount in dB that the transmitting antenna exceeds 6dBi.	N/A	All antennas tested have less than 6dBi antenna gain (Please see the antenna data sheets)
15.407(b)(6) 15.209	Unwanted emissions below 1 GHz must comply with the general field strength limits set forth in Section 15.209.	PASSED	See FCC 15.247 report (INTEL-090601F)
15.407(b)(1)	All emissions outside of the 5.15-5.35 GHz band shall not exceed an EIRP of -27dBm/MHz.	PASSED	See Data Sheets
<b>Operation in the 5.25-5.35 GHz Band</b>			
15.407(a)(2)	26dB emissions bandwidth in MHz.	N/A	5.26 GHz = 27.08 MHz 5.28 GHz = 25.58 MHz 5.32 GHz = 23.33 MHz
15.407(a)(2)	Maximum Conducted Output Power shall not exceed the lesser of 250mW or 11dBm+10logB (where B = 26dB emissions bandwidth).	PASSED	5.26 GHz = 16.64dBm (46.17mW) 5.28 GHz = 16.64dBm (46.17mW) 5.32 GHz = 16.74dBm (47.25mW)
15.407(a)(2)	The peak power spectral density shall not exceed 11dBm in any 1MHz band.	PASSED	5.26 GHz = 1.900dBm 5.28 GHz = 2.188dBm 5.32 GHz = 2.376dBm
15.407(a)(2)	Maximum Conducted Output Power and the peak power spectral density shall be reduced by the amount in dB that the transmitting antenna exceeds 6dBi.	N/A	All antennas tested have less than 6dBi antenna gain (Please see the antenna data sheets)
15.407(b)(6) 15.209	Unwanted emissions below 1 GHz must comply with the general field strength limits set forth in Section 15.209.	PASSED	See FCC 15.247 report (INTEL-090601F)
15.407(b)(2)	All emissions outside of the 5.15-5.35 GHz band shall not exceed an EIRP of -27dBm/MHz. Must meet all applicable technical requirements for operating in the 5.15-5.25 GHz band.	PASSED	See Data Sheets
<b>General Requirements For All Bands</b>			
15.407(a)(6)	The ratio of the peak excursion of the modulation envelope to the peak transmit power shall not exceed 13dB across any 1 MHz bandwidth or the emissions bandwidth whichever is less.	PASSED	5.18 GHz = 5.50 dB 5.20 GHz = 5.33 dB 5.24 GHz = 6.00 dB 5.26 GHz = 5.84 dB 5.28 GHz = 5.50 dB 5.32 GHz = 5.67 dB
15.407(f)	Radio frequency radiation exposure requirement.	PASSED	Refer to MPE Calculations
15.407(b)(6) 15.207	UNII devices using AC power line are required to comply with the conducted limits set forth in Section 15.207.	PASSED	See FCC 15.247 report (INTEL-090601F)



2.0 Summary Of Test Results (Continued)

**802.11a Mode (5150-5350 MHz) Chain B**

<b>EMISSIONS STANDARD</b>			
<b>FCC Part 15 Section</b>	<b>Description</b>	<b>Results</b>	<b>Comments</b>
<b>Operation in the 5.15-5.25 GHz Band</b>			
15.407(d)	Any UNII device shall use a transmitting antenna that is an integral part of the device.	PASSED	The antenna will be integral when installed in a notebook computer
15.407(e)	UNII devices will be restricted to indoor operations.	PASSED	Refer to "User's Manual" Exhibit
15.407(a)(1)	26dB emissions bandwidth in MHz.	N/A	5.18 GHz = 25.33 MHz 5.20 GHz = 30.08 MHz 5.24 GHz = 32.17 MHz
15.407(a)(1)	Maximum Conducted Output Power shall not exceed the lesser of 50mW or 4dBm+10logB (where B = 26dB emissions bandwidth).	PASSED	5.18 GHz = 16.64dBm (46.17mW) 5.20 GHz = 16.74dBm (47.25mW) 5.24 GHz = 16.84dBm (48.35mW)
15.407(a)(1)	The peak power spectral density shall not exceed 4dBm in any 1MHz band.	PASSED	5.18 GHz = 1.786dBm 5.20 GHz = 1.965dBm 5.24 GHz = 1.975dBm
15.407(a)(1)	Maximum Conducted Output Power and the peak power spectral density shall be reduced by the amount in dB that the transmitting antenna exceeds 6dBi.	N/A	All antennas tested have less than 6dBi antenna gain (Please see the antenna data sheets)
15.407(b)(6) 15.209	Unwanted emissions below 1 GHz must comply with the general field strength limits set forth in Section 15.209.	PASSED	See FCC 15.247 report (INTEL-090601F)
15.407(b)(1)	All emissions outside of the 5.15-5.35 GHz band shall not exceed an EIRP of -27dBm/MHz.	PASSED	See Data Sheets
<b>Operation in the 5.25-5.35 GHz Band</b>			
15.407(a)(2)	26dB emissions bandwidth in MHz.	N/A	5.26 GHz = 33.17 MHz 5.28 GHz = 32.58 MHz 5.32 GHz = 31.75 MHz
15.407(a)(2)	Maximum Conducted Output Power shall not exceed the lesser of 250mW or 11dBm+10logB (where B = 26dB emissions bandwidth).	PASSED	5.26 GHz = 16.64dBm (46.17mW) 5.28 GHz = 16.54dBm (45.12mW) 5.32 GHz = 16.54dBm (45.12mW)
15.407(a)(2)	The peak power spectral density shall not exceed 11dBm in any 1MHz band.	PASSED	5.26 GHz = 2.165dBm 5.28 GHz = 2.105dBm 5.32 GHz = 1.870dBm
15.407(a)(2)	Maximum Conducted Output Power and the peak power spectral density shall be reduced by the amount in dB that the transmitting antenna exceeds 6dBi.	N/A	All antennas tested have less than 6dBi antenna gain (Please see the antenna data sheets)
15.407(b)(6) 15.209	Unwanted emissions below 1 GHz must comply with the general field strength limits set forth in Section 15.209.	PASSED	See FCC 15.247 report (INTEL-090601F)
15.407(b)(2)	All emissions outside of the 5.15-5.35 GHz band shall not exceed an EIRP of -27dBm/MHz. Must meet all applicable technical requirements for operating in the 5.15-5.25 GHz band.	PASSED	See Data Sheets
<b>General Requirements For All Bands</b>			
15.407(a)(6)	The ratio of the peak excursion of the modulation envelope to the peak transmit power shall not exceed 13dB across any 1 MHz bandwidth or the emissions bandwidth whichever is less.	PASSED	5.18 GHz = 5.16 dB 5.20 GHz = 6.00 dB 5.24 GHz = 5.33 dB 5.26 GHz = 6.34 dB 5.28 GHz = 5.50 dB 5.32 GHz = 6.33 dB
15.407(f)	Radio frequency radiation exposure requirement.	PASSED	Refer to MPE Calculations
15.407(b)(6) 15.207	UNII devices using AC power line are required to comply with the conducted limits set forth in Section 15.207.	PASSED	See FCC 15.247 report (INTEL-090601F)



2.0 Summary Of Test Results (Continued)

**802.11n Mode 20MHz Wide (5150-5350 MHz) Chain A**

<b>EMISSIONS STANDARD</b>			
<b>FCC Part 15 Section</b>	<b>Description</b>	<b>Results</b>	<b>Comments</b>
<b>Operation in the 5.15-5.25 GHz Band</b>			
15.407(d)	Any UNII device shall use a transmitting antenna that is an integral part of the device.	PASSED	The antenna will be integral when installed in a notebook computer
15.407(e)	UNII devices will be restricted to indoor operations.	PASSED	Refer to "User's Manual" Exhibit
15.407(a)(1)	26dB emissions bandwidth in MHz.	N/A	5.18 GHz = 27.25 MHz 5.20 GHz = 30.08 MHz 5.24 GHz = 29.00 MHz
15.407(a)(1)	Maximum Conducted Output Power shall not exceed the lesser of 50mW or 4dBm+10logB (where B = 26dB emissions bandwidth).	PASSED	5.18 GHz = 16.74dBm (47.25mW) 5.20 GHz = 16.74dBm (47.25mW) 5.24 GHz = 16.84dBm (48.35mW)
15.407(a)(1)	The peak power spectral density shall not exceed 4dBm in any 1MHz band.	PASSED	5.18 GHz = 2.101dBm 5.20 GHz = 1.396dBm 5.24 GHz = 1.188dBm
15.407(a)(1)	Maximum Conducted Output Power and the peak power spectral density shall be reduced by the amount in dB that the transmitting antenna exceeds 6dBi.	N/A	All antennas tested have less than 6dBi antenna gain (Please see the antenna data sheets)
15.407(b)(6) 15.209	Unwanted emissions below 1 GHz must comply with the general field strength limits set forth in Section 15.209.	PASSED	See FCC 15.247 report (INTEL-090601F)
15.407(b)(1)	All emissions outside of the 5.15-5.35 GHz band shall not exceed an EIRP of -27dBm/MHz.	PASSED	See Data Sheets
<b>Operation in the 5.25-5.35 GHz Band</b>			
15.407(a)(2)	26dB emissions bandwidth in MHz.	N/A	5.26 GHz = 27.83 MHz 5.28 GHz = 27.58 MHz 5.32 GHz = 28.50 MHz
15.407(a)(2)	Maximum Conducted Output Power shall not exceed the lesser of 250mW or 11dBm+10logB (where B = 26dB emissions bandwidth).	PASSED	5.26 GHz = 16.84dBm (48.35mW) 5.28 GHz = 16.54dBm (45.12mW) 5.32 GHz = 16.64dBm (46.17mW)
15.407(a)(2)	The peak power spectral density shall not exceed 11dBm in any 1MHz band.	PASSED	5.26 GHz = 1.475dBm 5.28 GHz = 1.447dBm 5.32 GHz = 1.788dBm
15.407(a)(2)	Maximum Conducted Output Power and the peak power spectral density shall be reduced by the amount in dB that the transmitting antenna exceeds 6dBi.	N/A	All antennas tested have less than 6dBi antenna gain (Please see the antenna data sheets)
15.407(b)(6) 15.209	Unwanted emissions below 1 GHz must comply with the general field strength limits set forth in Section 15.209.	PASSED	See FCC 15.247 report (INTEL-090601F)
15.407(b)(2)	All emissions outside of the 5.15-5.35 GHz band shall not exceed an EIRP of -27dBm/MHz. Must meet all applicable technical requirements for operating in the 5.15-5.25 GHz band.	PASSED	See Data Sheets
<b>General Requirements For All Bands</b>			
15.407(a)(6)	The ratio of the peak excursion of the modulation envelope to the peak transmit power shall not exceed 13dB across any 1 MHz bandwidth or the emissions bandwidth whichever is less.	PASSED	5.18 GHz = 5.50 dB 5.20 GHz = 5.34 dB 5.24 GHz = 5.50 dB 5.26 GHz = 5.50 dB 5.28 GHz = 6.16 dB 5.32 GHz = 5.34 dB
15.407(f)	Radio frequency radiation exposure requirement.	PASSED	Refer to MPE Calculations
15.407(b)(6) 15.207	UNII devices using AC power line are required to comply with the conducted limits set forth in Section 15.207.	PASSED	See FCC 15.247 report (INTEL-090601F)



2.0 Summary Of Test Results (Continued)

**802.11n Mode 20MHz Wide (5150-5350 MHz) Chain B**

<b>EMISSIONS STANDARD</b>			
<b>FCC Part 15 Section</b>	<b>Description</b>	<b>Results</b>	<b>Comments</b>
<b>Operation in the 5.15-5.25 GHz Band</b>			
15.407(d)	Any UNII device shall use a transmitting antenna that is an integral part of the device.	PASSED	The antenna will be integral when installed in a notebook computer
15.407(e)	UNII devices will be restricted to indoor operations.	PASSED	Refer to "User's Manual" Exhibit
15.407(a)(1)	26dB emissions bandwidth in MHz.	N/A	5.18 GHz = 29.58 MHz 5.20 GHz = 28.00 MHz 5.24 GHz = 26.83 MHz
15.407(a)(1)	Maximum Conducted Output Power shall not exceed the lesser of 50mW or 4dBm+10logB (where B = 26dB emissions bandwidth).	PASSED	5.18 GHz = 16.64dBm (46.17mW) 5.20 GHz = 16.54dBm (45.12mW) 5.24 GHz = 16.84dBm (48.35mW)
15.407(a)(1)	The peak power spectral density shall not exceed 4dBm in any 1MHz band.	PASSED	5.18 GHz = 2.522dBm 5.20 GHz = 1.702dBm 5.24 GHz = 1.928dBm
15.407(a)(1)	Maximum Conducted Output Power and the peak power spectral density shall be reduced by the amount in dB that the transmitting antenna exceeds 6dBi.	N/A	All antennas tested have less than 6dBi antenna gain (Please see the antenna data sheets)
15.407(b)(6) 15.209	Unwanted emissions below 1 GHz must comply with the general field strength limits set forth in Section 15.209.	PASSED	See FCC 15.247 report (INTEL-090601F)
15.407(b)(1)	All emissions outside of the 5.15-5.35 GHz band shall not exceed an EIRP of -27dBm/MHz.	PASSED	See Data Sheets
<b>Operation in the 5.25-5.35 GHz Band</b>			
15.407(a)(2)	26dB emissions bandwidth in MHz.	N/A	5.26 GHz = 28.33 MHz 5.28 GHz = 29.58 MHz 5.32 GHz = 30.42 MHz
15.407(a)(2)	Maximum Conducted Output Power shall not exceed the lesser of 250mW or 11dBm+10logB (where B = 26dB emissions bandwidth).	PASSED	5.26 GHz = 16.54dBm (45.12mW) 5.28 GHz = 16.84dBm (48.35mW) 5.32 GHz = 16.84dBm (48.35mW)
15.407(a)(2)	The peak power spectral density shall not exceed 11dBm in any 1MHz band.	PASSED	5.26 GHz = 1.335dBm 5.28 GHz = 2.038dBm 5.32 GHz = 1.957dBm
15.407(a)(2)	Maximum Conducted Output Power and the peak power spectral density shall be reduced by the amount in dB that the transmitting antenna exceeds 6dBi.	N/A	All antennas tested have less than 6dBi antenna gain (Please see the antenna data sheets)
15.407(b)(6) 15.209	Unwanted emissions below 1 GHz must comply with the general field strength limits set forth in Section 15.209.	PASSED	See FCC 15.247 report (INTEL-090601F)
15.407(b)(2)	All emissions outside of the 5.15-5.35 GHz band shall not exceed an EIRP of -27dBm/MHz. Must meet all applicable technical requirements for operating in the 5.15-5.25 GHz band.	PASSED	See Data Sheets
<b>General Requirements For All Bands</b>			
15.407(a)(6)	The ratio of the peak excursion of the modulation envelope to the peak transmit power shall not exceed 13dB across any 1 MHz bandwidth or the emissions bandwidth whichever is less.	PASSED	5.18 GHz = 6.00 dB 5.20 GHz = 5.34 dB 5.24 GHz = 6.33 dB 5.26 GHz = 5.34 dB 5.28 GHz = 5.50 dB 5.32 GHz = 5.66 dB
15.407(f)	Radio frequency radiation exposure requirement.	PASSED	Refer to MPE Calculations
15.407(b)(6) 15.207	UNII devices using AC power line are required to comply with the conducted limits set forth in Section 15.207.	PASSED	See FCC 15.247 report (INTEL-090601F)



2.0 Summary Of Test Results (Continued)

**802.11n Mode 40MHz Wide (5150-5350 MHz) Chain A**

<b>EMISSIONS STANDARD</b>			
<b>FCC Part 15 Section</b>	<b>Description</b>	<b>Results</b>	<b>Comments</b>
<b>Operation in the 5.15-5.25 GHz Band</b>			
15.407(d)	Any UNII device shall use a transmitting antenna that is an integral part of the device.	PASSED	The antenna will be integral when installed in a notebook computer
15.407(e)	UNII devices will be restricted to indoor operations.	PASSED	Refer to "User's Manual" Exhibit
15.407(a)(1)	26dB emissions bandwidth in MHz.	N/A	5.19 GHz = 41.00 MHz 5.23 GHz = 43.00 MHz
15.407(a)(1)	Maximum Conducted Output Power shall not exceed the lesser of 50mW or 4dBm+10logB (where B = 26dB emissions bandwidth).	PASSED	5.19 GHz = 16.89dBm (48.84mW) 5.23 GHz = 16.69dBm (46.64mW)
15.407(a)(1)	The peak power spectral density shall not exceed 4dBm in any 1MHz band.	PASSED	5.19 GHz = -1.037dBm 5.23 GHz = -1.325dBm
15.407(a)(1)	Maximum Conducted Output Power and the peak power spectral density shall be reduced by the amount in dB that the transmitting antenna exceeds 6dBi.	N/A	All antennas tested have less than 6dBi antenna gain (Please see the antenna data sheets)
15.407(b)(6) 15.209	Unwanted emissions below 1 GHz must comply with the general field strength limits set forth in Section 15.209.	PASSED	See FCC 15.247 report (INTEL-090601F)
15.407(b)(1)	All emissions outside of the 5.15-5.35 GHz band shall not exceed an EIRP of -27dBm/MHz.	PASSED	See Data Sheets
<b>Operation in the 5.25-5.35 GHz Band</b>			
15.407(a)(2)	26dB emissions bandwidth in MHz.	N/A	5.27 GHz = 41.00 MHz 5.31 GHz = 40.33 MHz
15.407(a)(2)	Maximum Conducted Output Power shall not exceed the lesser of 250mW or 11dBm+10logB (where B = 26dB emissions bandwidth).	PASSED	5.27 GHz = 16.69dBm (46.64mW) 5.31 GHz = 16.79dBm (47.73mW)
15.407(a)(2)	The peak power spectral density shall not exceed 11dBm in any 1MHz band.	PASSED	5.27 GHz = -1.207dBm 5.31 GHz = -1.032dBm
15.407(a)(2)	Maximum Conducted Output Power and the peak power spectral density shall be reduced by the amount in dB that the transmitting antenna exceeds 6dBi.	N/A	All antennas tested have less than 6dBi antenna gain (Please see the antenna data sheets)
15.407(b)(6) 15.209	Unwanted emissions below 1 GHz must comply with the general field strength limits set forth in Section 15.209.	PASSED	See FCC 15.247 report (INTEL-090601F)
15.407(b)(2)	All emissions outside of the 5.15-5.35 GHz band shall not exceed an EIRP of -27dBm/MHz. Must meet all applicable technical requirements for operating in the 5.15-5.25 GHz band.	PASSED	See Data Sheets
<b>General Requirements For All Bands</b>			
15.407(a)(6)	The ratio of the peak excursion of the modulation envelope to the peak transmit power shall not exceed 13dB across any 1 MHz bandwidth or the emissions bandwidth whichever is less.	PASSED	5.19 GHz = 5.66 dB 5.23 GHz = 5.17 dB 5.27 GHz = 5.33 dB 5.31 GHz = 5.67 dB
15.407(f)	Radio frequency radiation exposure requirement.	PASSED	Refer to MPE Calculations
15.407(b)(6) 15.207	UNII devices using AC power line are required to comply with the conducted limits set forth in Section 15.207.	PASSED	See FCC 15.247 report (INTEL-090601F)





2.0 Summary Of Test Results (Continued)

**802.11n Mode 40MHz Wide (5150-5350 MHz) Chain B**

<b>EMISSIONS STANDARD</b>			
<b>FCC Part 15 Section</b>	<b>Description</b>	<b>Results</b>	<b>Comments</b>
<b>Operation in the 5.15-5.25 GHz Band</b>			
15.407(d)	Any UNII device shall use a transmitting antenna that is an integral part of the device.	PASSED	The antenna will be integral when installed in a notebook computer
15.407(e)	UNII devices will be restricted to indoor operations.	PASSED	Refer to "User's Manual" Exhibit
15.407(a)(1)	26dB emissions bandwidth in MHz.	N/A	5.19 GHz = 37.50 MHz 5.23 GHz = 38.42 MHz
15.407(a)(1)	Maximum Conducted Output Power shall not exceed the lesser of 50mW or 4dBm+10logB (where B = 26dB emissions bandwidth).	PASSED	5.19 GHz = 16.79dBm (47.73mW) 5.23 GHz = 16.89dBm (48.84mW)
15.407(a)(1)	The peak power spectral density shall not exceed 4dBm in any 1MHz band.	PASSED	5.19 GHz = -2.065dBm 5.23 GHz = -2.320dBm
15.407(a)(1)	Maximum Conducted Output Power and the peak power spectral density shall be reduced by the amount in dB that the transmitting antenna exceeds 6dBi.	N/A	All antennas tested have less than 6dBi antenna gain (Please see the antenna data sheets)
15.407(b)(6) 15.209	Unwanted emissions below 1 GHz must comply with the general field strength limits set forth in Section 15.209.	PASSED	See FCC 15.247 report (INTEL-090601F)
15.407(b)(1)	All emissions outside of the 5.15-5.35 GHz band shall not exceed an EIRP of -27dBm/MHz.	PASSED	See Data Sheets
<b>Operation in the 5.25-5.35 GHz Band</b>			
15.407(a)(2)	26dB emissions bandwidth in MHz.	N/A	5.27 GHz = 38.50 MHz 5.31 GHz = 39.58 MHz
15.407(a)(2)	Maximum Conducted Output Power shall not exceed the lesser of 250mW or 11dBm+10logB (where B = 26dB emissions bandwidth).	PASSED	5.27 GHz = 16.89dBm (48.84mW) 5.31 GHz = 16.89dBm (48.84mW)
15.407(a)(2)	The peak power spectral density shall not exceed 11dBm in any 1MHz band.	PASSED	5.27 GHz = -1.322dBm 5.31 GHz = -1.276dBm
15.407(a)(2)	Maximum Conducted Output Power and the peak power spectral density shall be reduced by the amount in dB that the transmitting antenna exceeds 6dBi.	N/A	All antennas tested have less than 6dBi antenna gain (Please see the antenna data sheets)
15.407(b)(6) 15.209	Unwanted emissions below 1 GHz must comply with the general field strength limits set forth in Section 15.209.	PASSED	See FCC 15.247 report (INTEL-090601F)
15.407(b)(2)	All emissions outside of the 5.15-5.35 GHz band shall not exceed an EIRP of -27dBm/MHz. Must meet all applicable technical requirements for operating in the 5.15-5.25 GHz band.	PASSED	See Data Sheets
<b>General Requirements For All Bands</b>			
15.407(a)(6)	The ratio of the peak excursion of the modulation envelope to the peak transmit power shall not exceed 13dB across any 1 MHz bandwidth or the emissions bandwidth whichever is less.	PASSED	5.19 GHz = 5.33 dB 5.23 GHz = 5.50 dB 5.27 GHz = 5.67 dB 5.31 GHz = 5.50 dB
15.407(f)	Radio frequency radiation exposure requirement.	PASSED	Refer to MPE Calculations
15.407(b)(6) 15.207	UNII devices using AC power line are required to comply with the conducted limits set forth in Section 15.207.	PASSED	See FCC 15.247 report (INTEL-090601F)



2.0 Summary Of Test Results (Continued)

**802.11a Mode (5470-5725 MHz) Chain A**

<b>EMISSIONS STANDARD</b>			
<b>FCC Part 15 Section</b>	<b>Description</b>	<b>Results</b>	<b>Comments</b>
15.407(a)(2)	26dB emissions bandwidth in MHz.	N/A	5.50 GHz = 25.33 MHz 5.60 GHz = 29.75 MHz 5.70 GHz = 27.42 MHz
15.407(a)(2)	Maximum Conducted Output Power shall not exceed the lesser of 250mW or 11dBm+10logB (where B = 26dB emissions bandwidth).	PASSED	5.50 GHz = 16.54dBm (45.12mW) 5.60 GHz = 16.84dBm (48.35mW) 5.70 GHz = 16.64dBm (46.17mW)
15.407(a)(2)	The peak power spectral density shall not exceed 11dBm in any 1MHz band.	PASSED	5.50 GHz = 2.223dBm 5.60 GHz = 2.170dBm 5.70 GHz = 2.045dBm
15.407(a)(2)	Maximum Conducted Output Power and the peak power spectral density shall be reduced by the amount in dB that the transmitting antenna exceeds 6dBi.	N/A	All antennas tested have less than 6dBi antenna gain (Please see the antenna data sheets)
15.407(b)(6) 15.209	Unwanted emissions below 1 GHz must comply with the general field strength limits set forth in Section 15.209.	PASSED	See FCC 15.247 report (INTEL-090601F)
15.407(b)(3)	For transmitters operating in the 5.47-5.725 GHz band: all emissions outside of the 5.47-5.725 GHz band shall not exceed an EIRP of -27dBm/MHz.	PASSED	See Data Sheets
<b>General Requirements For All Bands</b>			
15.407(a)(6)	The ratio of the peak excursion of the modulation envelope to the peak transmit power shall not exceed 13dB across any 1 MHz bandwidth or the emissions bandwidth whichever is less.	PASSED	5.50 GHz = 5.83 dB 5.60 GHz = 5.50 dB 5.70 GHz = 5.33 dB
15.407(f)	Radio frequency radiation exposure requirement.	PASSED	Refer to MPE Calculations
15.407(b)(6) 15.207	UNII devices using AC power line are required to comply with the conducted limits set forth in Section 15.207.	PASSED	See FCC 15.247 report (INTEL-090601F)



2.0 Summary Of Test Results (Continued)

**802.11a Mode (5470-5725 MHz) Chain B**

<b>EMISSIONS STANDARD</b>			
<b>FCC Part 15 Section</b>	<b>Description</b>	<b>Results</b>	<b>Comments</b>
15.407(a)(2)	26dB emissions bandwidth in MHz.	N/A	5.50 GHz = 33.50 MHz 5.60 GHz = 34.00 MHz 5.70 GHz = 34.42 MHz
15.407(a)(2)	Maximum Conducted Output Power shall not exceed the lesser of 250mW or 11dBm+10logB (where B = 26dB emissions bandwidth).	PASSED	5.50 GHz = 16.74dBm (47.25mW) 5.60 GHz = 16.74dBm (47.25mW) 5.70 GHz = 16.84dBm (48.35mW)
15.407(a)(2)	The peak power spectral density shall not exceed 11dBm in any 1MHz band.	PASSED	5.50 GHz = 2.331dBm 5.60 GHz = 2.676dBm 5.70 GHz = 2.234dBm
15.407(a)(2)	Maximum Conducted Output Power and the peak power spectral density shall be reduced by the amount in dB that the transmitting antenna exceeds 6dBi.	N/A	All antennas tested have less than 6dBi antenna gain (Please see the antenna data sheets)
15.407(b)(6) 15.209	Unwanted emissions below 1 GHz must comply with the general field strength limits set forth in Section 15.209.	PASSED	See FCC 15.247 report (INTEL-090601F)
15.407(b)(3)	For transmitters operating in the 5.47-5.725 GHz band: all emissions outside of the 5.47-5.725 GHz band shall not exceed an EIRP of -27dBm/MHz.	PASSED	See Data Sheets
<b>General Requirements For All Bands</b>			
15.407(a)(6)	The ratio of the peak excursion of the modulation envelope to the peak transmit power shall not exceed 13dB across any 1 MHz bandwidth or the emissions bandwidth whichever is less.	PASSED	5.50 GHz = 5.50 dB 5.60 GHz = 5.16 dB 5.70 GHz = 5.33 dB
15.407(f)	Radio frequency radiation exposure requirement.	PASSED	Refer to MPE Calculations
15.407(b)(6) 15.207	UNII devices using AC power line are required to comply with the conducted limits set forth in Section 15.207.	PASSED	See FCC 15.247 report (INTEL-090601F)



2.0 Summary Of Test Results (Continued)

**802.11n Mode 20MHz Wide (5470-5725 MHz) Chain A**

<b>EMISSIONS STANDARD</b>			
<b>FCC Part 15 Section</b>	<b>Description</b>	<b>Results</b>	<b>Comments</b>
15.407(a)(2)	26dB emissions bandwidth in MHz.	N/A	5.50 GHz = 29.92 MHz 5.60 GHz = 27.08 MHz 5.70 GHz = 29.08 MHz
15.407(a)(2)	Maximum Conducted Output Power shall not exceed the lesser of 250mW or 11dBm+10logB (where B = 26dB emissions bandwidth).	PASSED	5.50 GHz = 16.84dBm (48.35mW) 5.60 GHz = 16.54dBm (45.12mW) 5.70 GHz = 16.74dBm (47.25mW)
15.407(a)(2)	The peak power spectral density shall not exceed 11dBm in any 1MHz band.	PASSED	5.50 GHz = 2.159dBm 5.60 GHz = 1.085dBm 5.70 GHz = 1.149dBm
15.407(a)(2)	Maximum Conducted Output Power and the peak power spectral density shall be reduced by the amount in dB that the transmitting antenna exceeds 6dBi.	N/A	All antennas tested have less than 6dBi antenna gain (Please see the antenna data sheets)
15.407(b)(6) 15.209	Unwanted emissions below 1 GHz must comply with the general field strength limits set forth in Section 15.209.	PASSED	See FCC 15.247 report (INTEL-090601F)
15.407(b)(3)	For transmitters operating in the 5.47-5.725 GHz band: all emissions outside of the 5.47-5.725 GHz band shall not exceed an EIRP of -27dBm/MHz.	PASSED	See Data Sheets
<b>General Requirements For All Bands</b>			
15.407(a)(6)	The ratio of the peak excursion of the modulation envelope to the peak transmit power shall not exceed 13dB across any 1 MHz bandwidth or the emissions bandwidth whichever is less.	PASSED	5.50 GHz = 6.00 dB 5.60 GHz = 5.66 dB 5.70 GHz = 5.17 dB
15.407(f)	Radio frequency radiation exposure requirement.	PASSED	Refer to MPE Calculations
15.407(b)(6) 15.207	UNII devices using AC power line are required to comply with the conducted limits set forth in Section 15.207.	PASSED	See FCC 15.247 report (INTEL-090601F)



2.0 Summary Of Test Results (Continued)

**802.11n Mode 20MHz Wide (5470-5725 MHz) Chain B**

<b>EMISSIONS STANDARD</b>			
<b>FCC Part 15 Section</b>	<b>Description</b>	<b>Results</b>	<b>Comments</b>
15.407(a)(2)	26dB emissions bandwidth in MHz.	N/A	5.50 GHz = 32.08 MHz 5.60 GHz = 36.42 MHz 5.70 GHz = 35.42 MHz
15.407(a)(2)	Maximum Conducted Output Power shall not exceed the lesser of 250mW or 11dBm+10logB (where B = 26dB emissions bandwidth).	PASSED	5.50 GHz = 16.94dBm (49.47mW) 5.60 GHz = 16.74dBm (47.25mW) 5.70 GHz = 16.74dBm (47.25mW)
15.407(a)(2)	The peak power spectral density shall not exceed 11dBm in any 1MHz band.	PASSED	5.50 GHz = 2.201dBm 5.60 GHz = 1.827dBm 5.70 GHz = 2.001dBm
15.407(a)(2)	Maximum Conducted Output Power and the peak power spectral density shall be reduced by the amount in dB that the transmitting antenna exceeds 6dBi.	N/A	All antennas tested have less than 6dBi antenna gain (Please see the antenna data sheets)
15.407(b)(6) 15.209	Unwanted emissions below 1 GHz must comply with the general field strength limits set forth in Section 15.209.	PASSED	See FCC 15.247 report (INTEL-090601F)
15.407(b)(3)	For transmitters operating in the 5.47-5.725 GHz band: all emissions outside of the 5.47-5.725 GHz band shall not exceed an EIRP of -27dBm/MHz.	PASSED	See Data Sheets
<b>General Requirements For All Bands</b>			
15.407(a)(6)	The ratio of the peak excursion of the modulation envelope to the peak transmit power shall not exceed 13dB across any 1 MHz bandwidth or the emissions bandwidth whichever is less.	PASSED	5.50 GHz = 5.50 dB 5.60 GHz = 5.83 dB 5.70 GHz = 5.50 dB
15.407(f)	Radio frequency radiation exposure requirement.	PASSED	Refer to MPE Calculations
15.407(b)(6) 15.207	UNII devices using AC power line are required to comply with the conducted limits set forth in Section 15.207.	PASSED	See FCC 15.247 report (INTEL-090601F)



2.0 Summary Of Test Results (Continued)

**802.11n Mode 40MHz Wide (5470-5725 MHz) Chain A**

<b>EMISSIONS STANDARD</b>			
<b>FCC Part 15 Section</b>	<b>Description</b>	<b>Results</b>	<b>Comments</b>
15.407(a)(2)	26dB emissions bandwidth in MHz.	N/A	5.51 GHz = 44.75 MHz 5.59 GHz = 42.83 MHz 5.67 GHz = 44.50 MHz
15.407(a)(2)	Maximum Conducted Output Power shall not exceed the lesser of 250mW or 11dBm+10logB (where B = 26dB emissions bandwidth).	PASSED	5.51 GHz = 16.79dBm (47.73mW) 5.59 GHz = 16.69dBm (46.64mW) 5.67 GHz = 16.59dBm (45.58mW)
15.407(a)(2)	The peak power spectral density shall not exceed 11dBm in any 1MHz band.	PASSED	5.51 GHz = -0.729dBm 5.59 GHz = -1.329dBm 5.67 GHz = -1.175dBm
15.407(a)(2)	Maximum Conducted Output Power and the peak power spectral density shall be reduced by the amount in dB that the transmitting antenna exceeds 6dBi.	N/A	All antennas tested have less than 6dBi antenna gain (Please see the antenna data sheets)
15.407(b)(6) 15.209	Unwanted emissions below 1 GHz must comply with the general field strength limits set forth in Section 15.209.	PASSED	See FCC 15.247 report (INTEL-090601F)
15.407(b)(3)	For transmitters operating in the 5.47-5.725 GHz band: all emissions outside of the 5.47-5.725 GHz band shall not exceed an EIRP of -27dBm/MHz.	PASSED	See Data Sheets
<b>General Requirements For All Bands</b>			
15.407(a)(6)	The ratio of the peak excursion of the modulation envelope to the peak transmit power shall not exceed 13dB across any 1 MHz bandwidth or the emissions bandwidth whichever is less.	PASSED	5.51 GHz = 5.67 dB 5.59 GHz = 5.83 dB 5.67 GHz = 5.50 dB
15.407(f)	Radio frequency radiation exposure requirement.	PASSED	Refer to MPE Calculations
15.407(b)(6) 15.207	UNII devices using AC power line are required to comply with the conducted limits set forth in Section 15.207.	PASSED	See FCC 15.247 report (INTEL-090601F)



## 2.0 Summary Of Test Results (Continued)

**802.11n Mode 40MHz Wide (5470-5725 MHz) Chain B**

<b>EMISSIONS STANDARD</b>			
<b>FCC Part 15 Section</b>	<b>Description</b>	<b>Results</b>	<b>Comments</b>
15.407(a)(2)	26dB emissions bandwidth in MHz.	N/A	5.51 GHz = 42.83 MHz 5.59 GHz = 43.42 MHz 5.67 GHz = 43.50 MHz
15.407(a)(2)	Maximum Conducted Output Power shall not exceed the lesser of 250mW or 11dBm+10logB (where B = 26dB emissions bandwidth).	PASSED	5.51 GHz = 16.89dBm (48.84mW) 5.59 GHz = 16.59dBm (45.58mW) 5.67 GHz = 16.69dBm (46.64mW)
15.407(a)(2)	The peak power spectral density shall not exceed 11dBm in any 1MHz band.	PASSED	5.51 GHz = -1.457dBm 5.59 GHz = -0.866dBm 5.67 GHz = -1.191dBm
15.407(a)(2)	Maximum Conducted Output Power and the peak power spectral density shall be reduced by the amount in dB that the transmitting antenna exceeds 6dBi.	N/A	All antennas tested have less than 6dBi antenna gain (Please see the antenna data sheets)
15.407(b)(6) 15.209	Unwanted emissions below 1 GHz must comply with the general field strength limits set forth in Section 15.209.	PASSED	See FCC 15.247 report (INTEL-090601F)
15.407(b)(3)	For transmitters operating in the 5.47-5.725 GHz band: all emissions outside of the 5.47-5.725 GHz band shall not exceed an EIRP of -27dBm/MHz.	PASSED	See Data Sheets
<b>General Requirements For All Bands</b>			
15.407(a)(6)	The ratio of the peak excursion of the modulation envelope to the peak transmit power shall not exceed 13dB across any 1 MHz bandwidth or the emissions bandwidth whichever is less.	PASSED	5.51 GHz = 5.67 dB 5.59 GHz = 5.50 dB 5.67 GHz = 5.83 dB
15.407(f)	Radio frequency radiation exposure requirement.	PASSED	Refer to MPE Calculations
15.407(b)(6) 15.207	UNII devices using AC power line are required to comply with the conducted limits set forth in Section 15.207.	PASSED	See FCC 15.247 report (INTEL-090601F)

**ANALYSIS AND CONCLUSIONS**

Based upon the measurement results we find that this equipment is within the limits of the global standards listed on the cover page of this test report. All results are based on a test of one sample. If any significant changes are made to the unit, the changes shall be evaluated and a retest may be required.

## Approval Signatories

**Report Completed By:**

**Johnny Candelas** 9/10/2009  
Senior Test Engineer  
Aegis Labs, Inc.

**Report Approved By:**

**Rick Candelas** 9/10/2009  
Quality Assurance  
Aegis Labs, Inc.



### 3.0 ADMINISTRATIVE DATA AND TEST DESCRIPTION

<b>DEVICE TESTED:</b>	ITE Type: Intel® Centrino® Ultimate-N 6200 Model Number(s): 622ANHMW Serial Number: 0015005A3C7C FCC ID: PD9622ANH
<b>DATE EUT RECEIVED:</b>	June 18 <sup>th</sup> , 2009
<b>TEST DATE(S):</b>	July 21 <sup>st</sup> – Sept 4 <sup>th</sup> , 2009
<b>ORIGIN OF TEST SAMPLE(S):</b>	Production
<b>EQUIPMENT CLASS:</b>	EUT tested as CLASS B device
<b>RESPONSIBLE PARTY:</b>	Intel Corporation 2111 NE 25 <sup>th</sup> Avenue Hillsboro, Oregon 97124
<b>CLIENT CONTACT:</b>	Mr. Steve Hackett
<b>MANUFACTURER:</b>	Intel Corporation
<b>TEST LOCATION:</b>	Aegis Labs, Inc. 32231 Trabuco Creek Road Trabuco Canyon, CA 92678 Open Area Test Site #1 & #2
<b>ACCREDITATION CERTIFICATE(S):</b>	A2LA Certificate Number: 1111.01, Valid through February 10, 2010
<b>PURPOSE OF TEST:</b>	To demonstrate compliance with the standards as described in Sections 1.0 & 2.0 of this report.
<b>UNCERTAINTY BUDGET:</b>	Proficiency Testing and Uncertainty Calculations for all tests indicated in this report have been conducted in accordance with ISO 17025: 2005 requirements Section 5.4.6, and 5.9. Uncertainty Budgets and Proficiency Test results available upon request.
<b>STATEMENT OF CALIBRATION:</b>	All accredited equipment calibrations were performed by Liberty Labs, Inc. and World Cal. with typical calibration uncertainty estimates derived from ISO Guide to the determination of uncertainties with a Coverage Factor of k=2 for 95% level of confidence.



## 4.0 DESCRIPTION OF EUT CONFIGURATION

### 4.1 EUT Description

<b>Equipment Under Test (EUT)</b>	
<b>Trade Name:</b>	Intel® Centrino® Ultimate-N 6200
<b>Model Number:</b>	622ANHMW
<b>Frequency Range:</b>	802.11a = 5.15 – 5.35 GHz & 5.47 – 5.725 802.11n = 5.15 – 5.35 GHz & 5.47 – 5.725
<b>Enclosure:</b>	The EUT contains its own shield made of aluminum approximately 2.5cm wide by 2cm deep by 2mm high.
<b>Transfer Rate:</b>	6/36/54 Mbps for 802.11a mode Up to 450 Mbps for 802.11n mode
<b>Antenna Type:</b>	<u>Shanghai Universe Communication Electron Co., Ltd Antennas:</u> PIFA
<b>Antenna Gain (See Note 2):</b>	3.73dBi @ 5 GHz
<b>Transmit Output Power:</b>	Please see Appendix A (Data Sheets) for actual output power.
<b>Power Supply:</b>	3.3VDC from external source
<b>Number of External Test Ports Exercised:</b>	2 Antenna Ports (Chain A & B)

The Intel® Centrino® Ultimate-N 6200 is an embedded IEEE 802.11a/b/g/n wireless network adapter that operates in the 2.4 GHz and 5.0 GHz spectrum. The adapter is capable of delivering up to 450 Mbps Tx/Rx.

**NOTE 1:** For a more detailed description, please refer to the manufacture’s specifications or User’s Manual.

**NOTE 2:** The EUT was tested with a set of Shanghai Universe Communication Electron Co., Ltd Antennas. (Refer to the antenna information exhibits).

#### 4.2 EUT Configuration

The EUT was tested installed in the Mini PCI-E slot of an extender board which is then connected to the host computer. The EUT was then connected to a set of antennas via its Chain A & B antenna ports. Data for a set of Shanghai Universe Communication Electron Co., Ltd Antennas can be found in Appendix A (Data Sheets)

The low, middle, and high channels were tested in 802.11a, b, g, & n modes. Also, the EUT was tested once transmitting from each chain individually (Chain A & B) and then tested with all chains transmitting simultaneously (Chain AB). The EUT was placed in continuous transmit mode by a program provided by the manufacturer (*CRTU Version 5.15.36.0*).

#### 4.3 List of EUT, Sub-Assemblies and Host Equipment

<b>Equipment Under Test</b>			
<b>Manufacturer</b>	<b>Equipment Name</b>	<b>Model or Part Number</b>	<b>Serial Number</b>
Intel Corporation	Intel® Centrino® Ultimate-N 6200	622ANHMW	0015005A3C7C

<b>EUT Sub Assemblies</b>			
<b>Manufacturer</b>	<b>Equipment Name</b>	<b>Model or Part Number</b>	<b>Serial Number</b>
Shanghai Universe Communication Electron Co.,Ltd	Chain A Antenna	SUC ANT S11	N/A
	Chain B Antenna	SUC ANT S11	N/A

<b>HOST EQUIPMENT LIST</b>			
<b>Manufacturer</b>	<b>Equipment Name</b>	<b>Model or Part Number</b>	<b>Serial Number</b>
Generic	Host Laptop	ENG001	None
Protek	DC Power Source	3006B	AC2018
Logitech	Keyboard	Y-BF37	MCT25200581
Logitech	Mouse	M-BJ58	LNA22802012

NOTE: All the power cords of the above support equipment are standard and non-shielded.

#### 4.4 I/O Cabling Diagram and Description

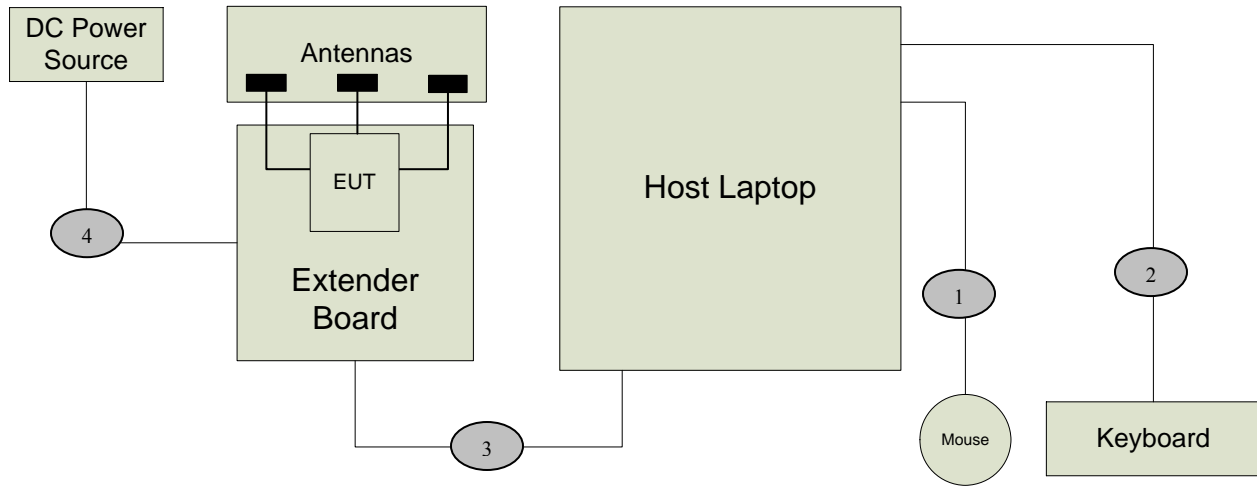

**Signal Line Cable Description**

Cable	Length	Construction	Source Connector	Destination Connector	Bundled Length	Ferrite Attached	Note
1	1.5m	Round, Braid & Foil Shielded	Host Computer: USB Port	Keyboard: Hardwired	N/A	N/A	N/A
2	1.5m	Round, Braid & Foil Shielded	Host Computer: USB Port	Mouse: Hardwired	N/A	N/A	N/A
3	0.5m	Flat, Braid & Foil Shielded	Extender Board: Mini PCIe slot	Host Laptop: Mini PCIe slot	N/A	N/A	N/A
4	0.5m	Round Un-shielded	Extender Board: Power Input	DC Power Source: Power Output	N/A	N/A	N/A



4.5 EMC Test Hardware and Software Measurement Equipment

TEST EQUIPMENT LIST - Emissions					
Equipment Name	Manufacturer	Model Number	Serial Number	Calibration Due Date	Maintenance Calibration Cycle
Spectrum Analyzer	Agilent	8565EC	3946A00245	07/24/10	1 Year
PSA Spectrum Analyzer	Agilent	E4440A	MY46186811	07/02/11	2 Years
Antenna – Horn	ETS	3117	00057423	12/23/09	1 Year
Preamp	Miteq	JS42-01001800-25-10P	815980	12/23/09	1 Year
30 Foot Coax	Semflex	S130SFBS10360	0619	07/26/10	1 Year
5.15-5.35 GHz Notch Filter	Microwave Circuits	N0452502	3173-01	NCR	NCR
Antenna - 18-26.5 GHz Pre-amplified Horn	Aegis Labs, Inc.	H042	SLK-35-3W	02/08/10	1 Year
Antenna - 26.5-40 GHz Pre-amplified Horn	Aegis Labs, Inc.	H028	GM1260-10	02/08/10	1 Year
EMI Receiver - RF Section	Hewlett Packard	8546A	3325A00137	04/26/10	1 Year
EMI Receiver - RF Filter Section	Hewlett Packard	85460A	3330A00138	04/26/10	1 Year
10 dB Attenuator	Pasternack	PE7014-10	N/A	09/05/09	1 Year
LISN (EUT)	Fisher Custom Communications	FCC-LISN-50-25-2	9931	06/03/10	1 Year
LISN (Access)	EMCO	3825/2	9108-1848	06/03/10	1 Year
Antenna - Biconical	EMCO	3110B	3383	06/05/10	1 Year
Antenna - Log Periodic	EMCO	3148	47943	06/12/10	1 Year
Power Meter	Anritsu	ML2487A	6K00001785	05/29/10	1 Year
Wide Bandwidth Sensor	Anritsu	MA2491A	31193	05/29/10	1 Year
12dB Attenuator	Narda	4779-12	203	06/09/10	1 Year
Temperature/Humidity Monitor	Dickson	TH550	7255185	04/13/10	1 Year

NCR – No Calibration Required.

## 5.0 CONDITIONS DURING EMISSIONS MEASUREMENTS

### 5.1 General

All measurements were made according to the procedures defined in or referred to by the standard listed on the cover page of this report. The measurements were made in the operating mode producing the largest emissions consistent with normal operation and connected to the minimum configuration of auxiliary devices.

### 5.2 Conducted Emissions Test Setup

The following was the test configuration.

EUT signal cables that hung closer than 40 cm to the horizontal metal ground plane were folded back and forth forming a bundle 30 cm to 40 cm long. The power cord of the EUT was also bundled in the center and plugged into one of the artificial mains network (AMN). All peripheral equipment was powered from a second AMN via a multiple outlet strip placed at a distance on 10cm from each other. The AMN and ISN were positioned 80cm from the EUT. Signal cables that were not connected to an AE were terminated using the correct termination. If applicable, the current probe was placed at 0.1 m from the ISN.

Peak, quasi-peak and/or average detectors were used for testing performed between 150 kHz and 30 MHz. A swept frequency scan was performed for both Line 1 and Line 2. The six highest readings were compared against the limit and recorded in the data sheet along with a snapshot image of the sweep scan. The graphical scans in Appendix A only reflect peak readings while the tabulated data sheets reflect peak, average, and/or quasi-peak measurements.

#### Climatic Conditions:

The EUT was tested within its intended operating and climatic conditions.

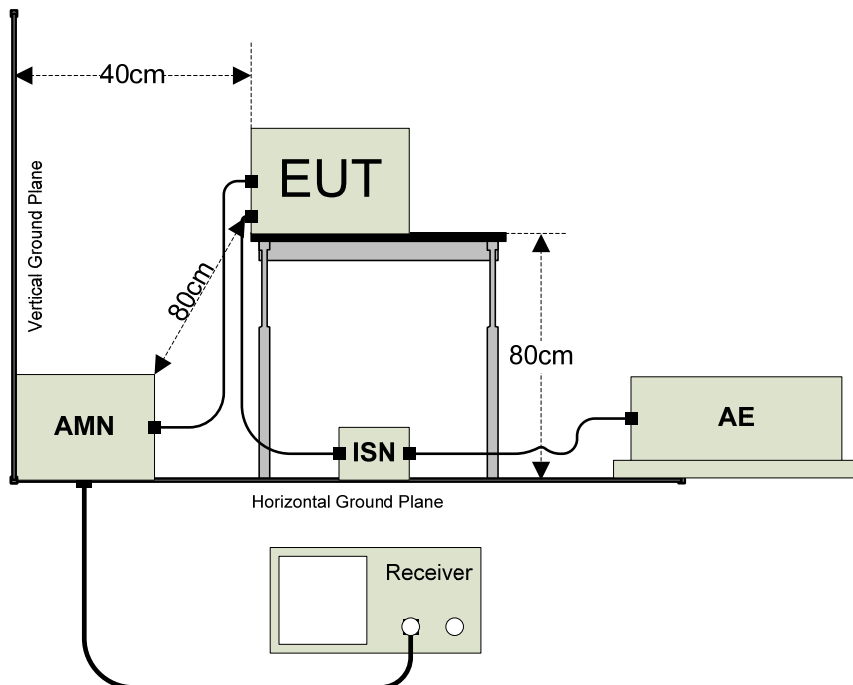

AMN = Artificial mains network  
 AE = Associated equipment  
 EUT = Equipment under test  
 ISN = Impedance stabilization network

### 5.3 Radiated Emissions Test Setup

The Open Area Test Site (OATS) was used for radiated emission testing. The receiving (Rx) antenna(s) was placed 10m from the nearest side of the EUT facing the Rx antenna. The EUT (if floor-standing) was placed directly on the flush-mounted 360 degree rotating turntable. The EUT (if table-top) was placed directly on an 80cm high non-metallic table, and the table was placed on the rotating turntable. During the initial EMI scan, all the suspect frequencies, i.e.; harmonics, broadband signals were checked with the Rx broadband antennas in both vertical and horizontal polarities. The biconical Rx, log periodic Rx, and horn Rx antennas were used from 30MHz – 299.99MHz, 300MHz – 1000MHz, and 1GHz – 18GHz respectively.

Upon completion of all harmonic and broadband measurements, the balance of any remaining frequencies was checked between 30MHz – 18GHz. Any signals appearing within 20 dB of the classification limit was measured. Each signal was maximized by first rotating the turntable at least 360 degrees and recording the azimuth in the data sheet. Lastly, the Rx antenna was raised and/or lowered to maximize the signal elevation. If the measured signal was obtained using the peak detector and that signal appeared within 3 dB of the regulatory limit line, then the same signal was re-measured using the quasi-peak detector on the EMI receiver. Both meter readings if necessary were recorded on the data sheet.

#### Climatic Conditions:

The EUT was tested within its intended operating and climatic conditions.

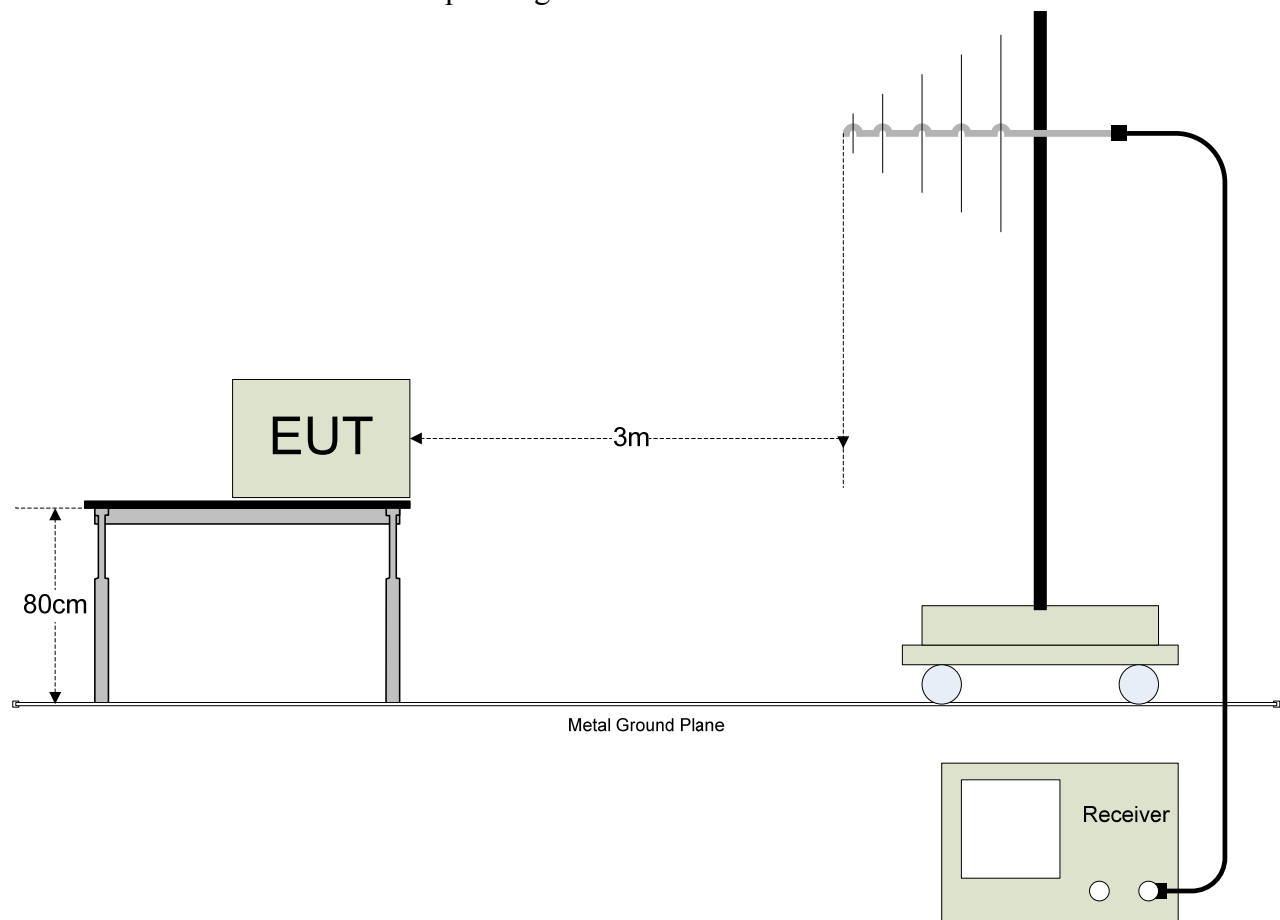



## **APPENDIX A**

### ***TEST DATA***

**RADIATED EMISSIONS TEST RESULTS**

<b>CLIENT:</b>	Intel Corporation	<b>DATE:</b>	08/17/09
<b>EUT:</b>	Intel® Centrino® Ultimate-N 6200	<b>PROJECT NUMBER:</b>	INTEL-090601
<b>MODEL NUMBER:</b>	622ANHMW	<b>TEST ENGINEER:</b>	JC
<b>SERIAL NUMBER:</b>	0015005A3C7C	<b>SITE #:</b>	2
<b>CONFIGURATION:</b>	Tested installed in an extender board connected to the host laptop's mini PCI slot in <b>802.11a (5150-5350 MHz) mode.</b>	<b>TEMPERATURE:</b>	24° C
		<b>HUMIDITY:</b>	46% RH
		<b>TIME:</b>	9:30 AM

<b>Description:</b>	Radiated RF Emissions (1 GHz – 18 GHz)
<b>Results:</b>	<b>PASSED</b> Horizontal and Vertical Antenna Polarizations Class B Limits
<b>Note:</b>	Radiated Emissions Measurements were performed on the EUT with power supply set at the following voltage and frequency. <ul style="list-style-type: none"> <li>• 120VAC / 60 Hz.</li> </ul>

<b>Unwanted Spurious Emissions Limits</b>			
<b>Frequency (MHz)</b>	<b>Field Strength (uV/m)</b>	<b>Field Strength (dBuV/m) (Emissions in the restricted bands)</b>	<b>Field Strength (dBm/MHz) (Emissions outside the restricted bands)</b>
Above 960	500	54.00 (Average) 74.00 (Peak)	< -20 dBc

## Radiated Emissions Sample Calculations

$$\text{Corrected Meter Reading} = \text{Meter Reading} + F + C - D$$

Where, F = Antenna Factor

C = Cable Factor

G = Amplifier Gain

D = Distance Factor (if applicable)

Therefore, the equation for determining the Corrected Meter Reading Limit (CML) is:

$$\text{CML} = \text{Specification Limit} - F - C + D$$





Radiated Emissions Test Results (Continued)

*Fundamental Measurements in 802.11a mode (5150-5350 MHz)*  
*Channels 36, 40, 48, 52, 56, & 64*  
*Continuous TX at Chain A Antenna port with Shanghai Universe Antennas*  
*Aegis Labs, Inc. File #: INTEL-090601-02*

<b>RADIATED EMISSIONS - Horizontal Antenna Polarization</b>											
Freq. (MHz)	Meter Reading (dBuV)	Antenna Height (cm)	Azimuth (degrees)	Quasi pk or AVG (dBuV)		Cable Factor (dB)	Ant. Factor (dB)	Corrected Reading (dBuV)	Limits (dBuV)	Diff (dB) +=FAIL	Comments
5180.00	60.43	100	45			3.77	34.28	98.48			<b>Ch. 36</b>
5180.00				53.40	A	3.77	34.28	91.45			
5200.00	62.00	100	0			3.78	34.30	100.08			<b>Ch. 40</b>
5200.00				55.14	A	3.78	34.30	93.22			
5240.00	61.11	100	45			3.80	34.34	99.25			<b>Ch. 48</b>
5240.00				54.19	A	3.80	34.34	92.33			
5260.00	59.18	100	45			3.80	34.36	97.34			<b>Ch. 52</b>
5260.00				52.60	A	3.80	34.36	90.76			
5280.00	60.08	100	180			3.81	34.38	98.27			<b>Ch. 56</b>
5280.00				53.37	A	3.81	34.38	91.56			
5320.00	61.32	100	45			3.83	34.42	99.57			<b>Ch. 64</b>
5320.00				54.51	A	3.83	34.42	92.76			

<b>RADIATED EMISSIONS - Vertical Antenna Polarization</b>											
Freq. (MHz)	Meter Reading (dBuV)	Antenna Height (cm)	Azimuth (degrees)	Quasi pk or AVG (dBuV)		Cable Factor (dB)	Ant. Factor (dB)	Corrected Reading (dBuV)	Limits (dBuV)	Diff (dB) +=FAIL	Comments
5180.00	62.61	100	45			3.77	34.48	100.86			<b>Ch. 36</b>
5180.00				53.13	A	3.77	34.48	91.38			
5200.00	63.35	100	45			3.78	34.50	101.63			<b>Ch. 40</b>
5200.00				53.76	A	3.78	34.50	92.04			
5240.00	63.74	100	0			3.80	34.54	102.08			<b>Ch. 48</b>
5240.00				53.98	A	3.80	34.54	92.32			
5260.00	64.52	100	45			3.80	34.56	102.88			<b>Ch. 52</b>
5260.00				55.06	A	3.80	34.56	93.42			
5280.00	63.90	100	0			3.81	34.58	102.29			<b>Ch. 56</b>
5280.00				54.29	A	3.81	34.58	92.68			
5320.00	65.14	100	315			3.83	34.62	103.59			<b>Ch. 64</b>
5320.00				55.25	A	3.83	34.62	93.70			

NOTE: Fundamental signals measured to calculate the band edge field strengths using the “Marker Delta Method”.



Radiated Emissions Test Results (Continued)

*Band Edge Field Strength Measurements in 802.11a mode (5150-5350 MHz)  
Channels 36 & 64  
Continuous TX at Chain A Antenna port with Shanghai Universe Antennas  
Aegis Labs, Inc. File #: INTEL-090601-02*

<b>RADIATED EMISSIONS - Horizontal Antenna Polarization</b>										
Freq. (MHz)	Meter Reading (dBuV)	Antenna Height (cm)	Azimuth (degrees)	Quasi pk or AVG (dBuV)	Cable Factor (dB)	Ant. Factor (dB)	Corrected Reading (dBuV)	Limits (dBuV)	Diff (dB) +=FAIL	Comments
5150.00							55.82	74.00	-18.18	<b>Ch. 36</b>
5150.00						49.48	74.00	-24.52		
5150.00				A		40.62	54.00	-13.38		
5150.00				A		42.45	54.00	-11.55		
5350.00							50.40	74.00	-23.60	<b>Ch. 64</b>
5350.00						47.40	74.00	-26.60		
5350.00				A		39.60	54.00	-14.40		
5350.00				A		40.59	54.00	-13.41		

<b>RADIATED EMISSIONS - Vertical Antenna Polarization</b>										
Freq. (MHz)	Meter Reading (dBuV)	Antenna Height (cm)	Azimuth (degrees)	Quasi pk or AVG (dBuV)	Cable Factor (dB)	Ant. Factor (dB)	Corrected Reading (dBuV)	Limits (dBuV)	Diff (dB) +=FAIL	Comments
5150.00							58.20	74.00	-15.80	<b>Ch. 36</b>
5150.00						51.86	74.00	-22.14		
5150.00				A		40.55	54.00	-13.45		
5150.00				A		42.38	54.00	-11.62		
5350.00							54.42	74.00	-19.58	<b>Ch. 64</b>
5350.00						51.42	74.00	-22.58		
5350.00				A		40.54	54.00	-13.46		
5350.00				A		41.53	54.00	-12.47		

NOTE: The “Band Edge Field Strength” was calculated using the “Fundamental” and “Conducted Band Edge” measurements per the “Marker-Delta Method” with the following formula:

$$BE = F_m - \Delta m$$

Where

BE = Band Edge Field Strength

F<sub>m</sub> = Measured Fundamental (Peak or Average)

Δ<sub>m</sub> = Measured Conducted Band Edge Delta (Peak or Average)

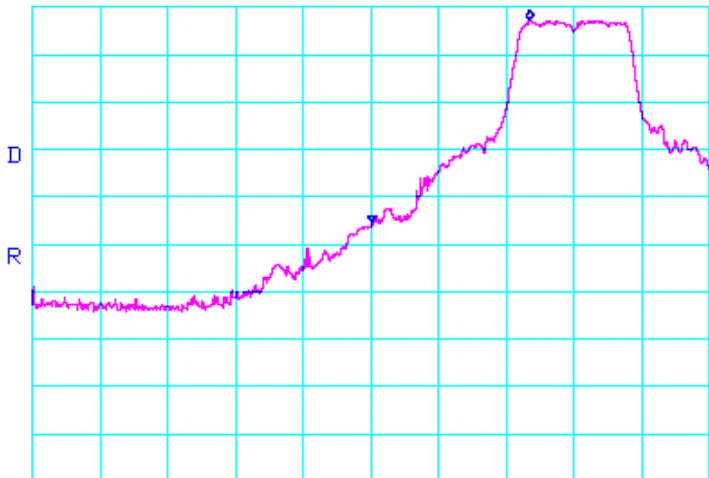
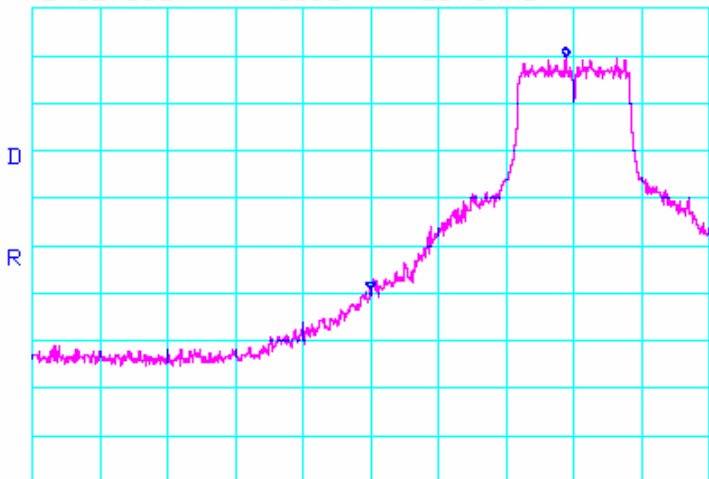

Band-Edge Plots (Continued)

<i>Plot File Name</i>	<i>Description (RBW/VBW)</i>	<i>Test Eng.</i>
INTEL-090601-05a	Cond BE, Ch. 36, PK (1MHz/1MHz)	JC
<p>*ATTEN 10dB                          ΔMKR 42.66dB            RL 12.0dBm                         10dB/                         23.3MHz</p>  <p>CENTER 5.1500GHz                         SPAN 100.0MHz            *RBW 1.0MHz                         *VBW 1.0MHz                         SWP 50.0ms</p>		
<i>Plot File Name</i>	<i>Description (RBW/VBW)</i>	<i>Test Eng.</i>
INTEL-090601-05b	Cond BE, Ch. 36, PK (100kHz/100kHz)	JC
<p>*ATTEN 10dB                          ΔMKR 49.00dB            RL 12.0dBm                         10dB/                         28.8MHz</p>  <p>CENTER 5.1500GHz                         SPAN 100.0MHz            *RBW 100kHz                         *VBW 100kHz                         SWP 55.0ms</p>		



## Band-Edge Plots (Continued)

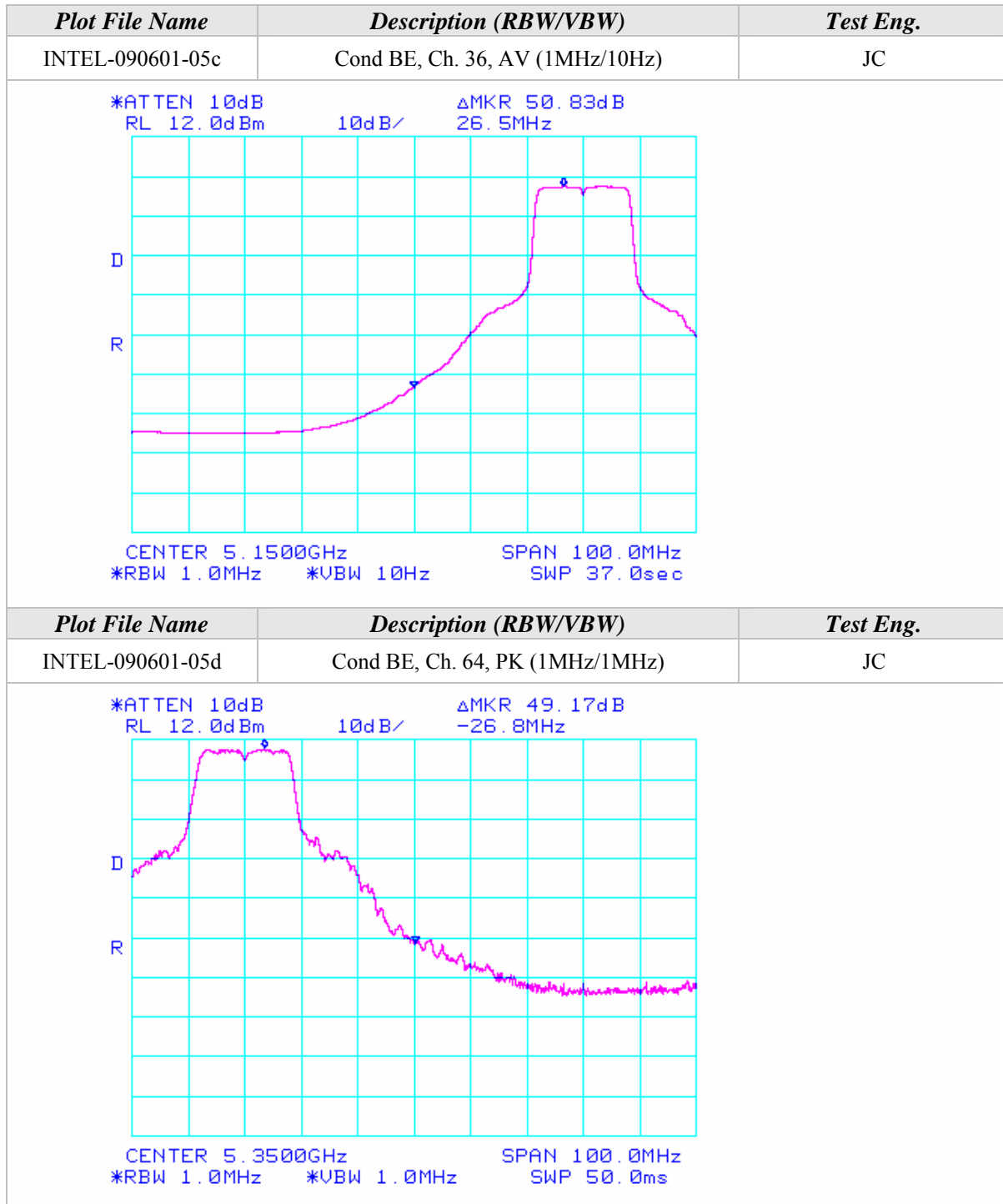



Band-Edge Plots (Continued)

<i>Plot File Name</i>	<i>Description (RBW/VBW)</i>	<i>Test Eng.</i>
INTEL-090601-05e	Cond BE, Ch. 64, PK (100kHz/100kHz)	JC
<p>*ATTEN 10dB      ΔMKR 52.17dB RL 12.0dBm      10dB/      -31.7MHz</p> <p>CENTER 5.3500GHz      SPAN 100.0MHz *RBW 100kHz      *VBW 100kHz      SWP 55.0ms</p>		
<i>Plot File Name</i>	<i>Description (RBW/VBW)</i>	<i>Test Eng.</i>
INTEL-090601-05f	Cond BE, Ch. 64, AV (1MHz/10Hz)	JC
<p>*ATTEN 10dB      ΔMKR 53.16dB RL 12.0dBm      10dB/      -35.2MHz</p> <p>CENTER 5.3500GHz      SPAN 100.0MHz *RBW 1.0MHz      *VBW 10Hz      SWP 37.0sec</p>		



Radiated Emissions Test Results (Continued)

*Fundamental Measurements in 802.11a mode (5150-5350 MHz)  
 Channels 36, 40, 48, 52, 56, & 64  
 Continuous TX at Chain B Antenna port with Shanghai Universe Antennas  
 Aegis Labs, Inc. File #: INTEL-090601-04*

<b>RADIATED EMISSIONS - Horizontal Antenna Polarization</b>											
Freq. (MHz)	Meter Reading (dBuV)	Antenna Height (cm)	Azimuth (degrees)	Quasi pk or AVG (dBuV)		Cable Factor (dB)	Ant. Factor (dB)	Corrected Reading (dBuV)	Limits (dBuV)	Diff (dB) +=FAIL	Comments
5180.00	62.67	100	315			3.77	34.28	100.72			<b>Ch. 36</b>
5180.00				53.33	A	3.77	34.28	91.38			
5200.00	63.50	100	315			3.78	34.30	101.58			<b>Ch. 40</b>
5200.00				54.00	A	3.78	34.30	92.08			
5240.00	62.33	100	0			3.80	34.34	100.47			<b>Ch. 48</b>
5240.00				53.17	A	3.80	34.34	91.31			
5260.00	63.83	100	315			3.80	34.36	101.99			<b>Ch. 52</b>
5260.00				55.50	A	3.80	34.36	93.66			
5280.00	64.33	100	315			3.81	34.38	102.52			<b>Ch. 56</b>
5280.00				55.83	A	3.81	34.38	94.02			
5320.00	63.67	100	315			3.83	34.42	101.92			<b>Ch. 64</b>
5320.00				54.50	A	3.83	34.42	92.75			

<b>RADIATED EMISSIONS - Vertical Antenna Polarization</b>											
Freq. (MHz)	Meter Reading (dBuV)	Antenna Height (cm)	Azimuth (degrees)	Quasi pk or AVG (dBuV)		Cable Factor (dB)	Ant. Factor (dB)	Corrected Reading (dBuV)	Limits (dBuV)	Diff (dB) +=FAIL	Comments
5180.00	62.67	100	315			3.77	34.48	100.92			<b>Ch. 36</b>
5180.00				53.33	A	3.77	34.48	91.58			
5200.00	63.17	100	315			3.78	34.50	101.45			<b>Ch. 40</b>
5200.00				53.83	A	3.78	34.50	92.11			
5240.00	63.67	100	315			3.80	34.54	102.01			<b>Ch. 48</b>
5240.00				54.50	A	3.80	34.54	92.84			
5260.00	64.33	100	315			3.80	34.56	102.69			<b>Ch. 52</b>
5260.00				55.00	A	3.80	34.56	93.36			
5280.00	63.83	100	0			3.81	34.58	102.22			<b>Ch. 56</b>
5280.00				54.17	A	3.81	34.58	92.56			
5320.00	65.33	100	315			3.83	34.62	103.78			<b>Ch. 64</b>
5320.00				55.33	A	3.83	34.62	93.78			

NOTE: Fundamental signals measured to calculate the band edge field strengths using the “Marker Delta Method”.



Radiated Emissions Test Results (Continued)

*Band Edge Field Strength Measurements in 802.11a mode (5150-5350 MHz)  
Channels 36 & 64  
Continuous TX at Chain B Antenna port with Shanghai Universe Antennas  
Aegis Labs, Inc. File #: INTEL-090601-04*

<b>RADIATED EMISSIONS - Horizontal Antenna Polarization</b>										
Freq. (MHz)	Meter Reading (dBuV)	Antenna Height (cm)	Azimuth (degrees)	Quasi pk or AVG (dBuV)	Cable Factor (dB)	Ant. Factor (dB)	Corrected Reading (dBuV)	Limits (dBuV)	Diff (dB) +=FAIL	Comments
5150.00							56.72	74.00	-17.28	<b>Ch. 36</b>
5150.00							53.56	74.00	-20.44	
5150.00					A		42.55	54.00	-11.45	
5150.00					A		44.22	54.00	-9.78	
5350.00							54.42	74.00	-19.58	<b>Ch. 64</b>
5350.00							50.59	74.00	-23.41	
5350.00					A		40.91	54.00	-13.09	
5350.00					A		41.42	54.00	-12.58	

<b>RADIATED EMISSIONS - Vertical Antenna Polarization</b>										
Freq. (MHz)	Meter Reading (dBuV)	Antenna Height (cm)	Azimuth (degrees)	Quasi pk or AVG (dBuV)	Cable Factor (dB)	Ant. Factor (dB)	Corrected Reading (dBuV)	Limits (dBuV)	Diff (dB) +=FAIL	Comments
5150.00							56.92	74.00	-17.08	<b>Ch. 36</b>
5150.00							53.76	74.00	-20.24	
5150.00					A		42.75	54.00	-11.25	
5150.00					A		44.42	54.00	-9.58	
5350.00							56.28	74.00	-17.72	<b>Ch. 64</b>
5350.00							52.45	74.00	-21.55	
5350.00					A		41.94	54.00	-12.06	
5350.00					A		42.45	54.00	-11.55	

NOTE: The “Band Edge Field Strength” was calculated using the “Fundamental” and “Conducted Band Edge” measurements per the “Marker-Delta Method” with the following formula:

$$BE = F_m - \Delta m$$

Where

BE = Band Edge Field Strength

F<sub>m</sub> = Measured Fundamental (Peak or Average)

Δ<sub>m</sub> = Measured Conducted Band Edge Delta (Peak or Average)



Band-Edge Plots (Continued)

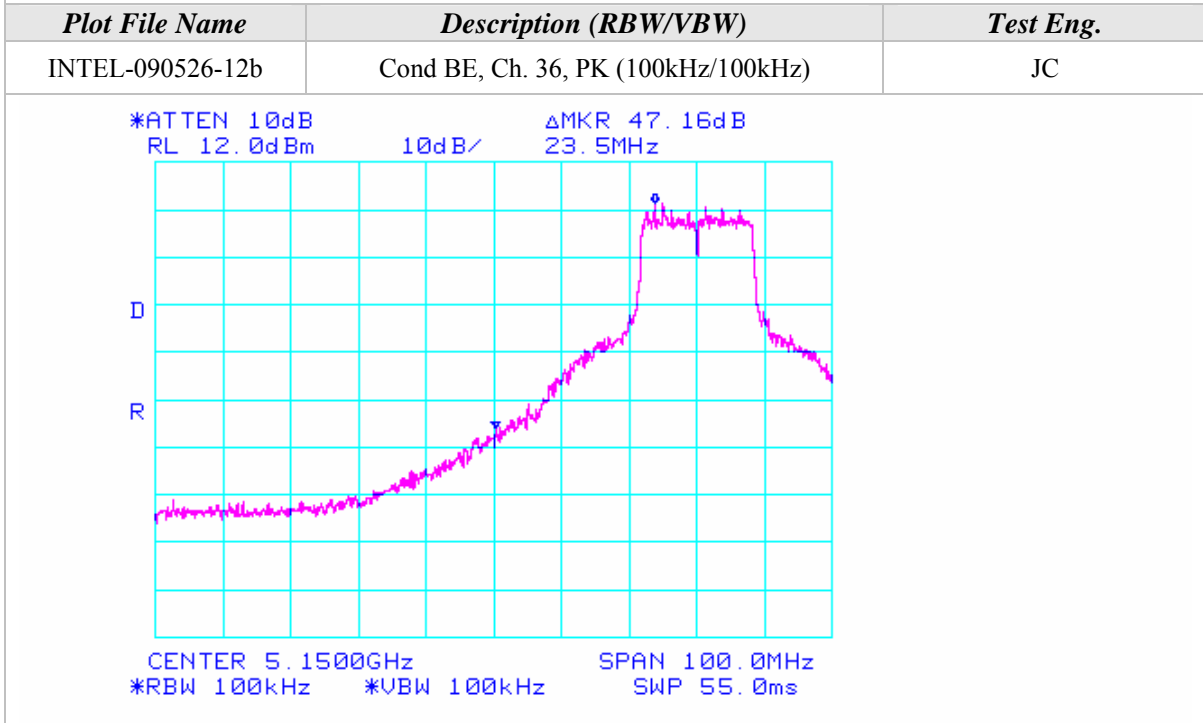
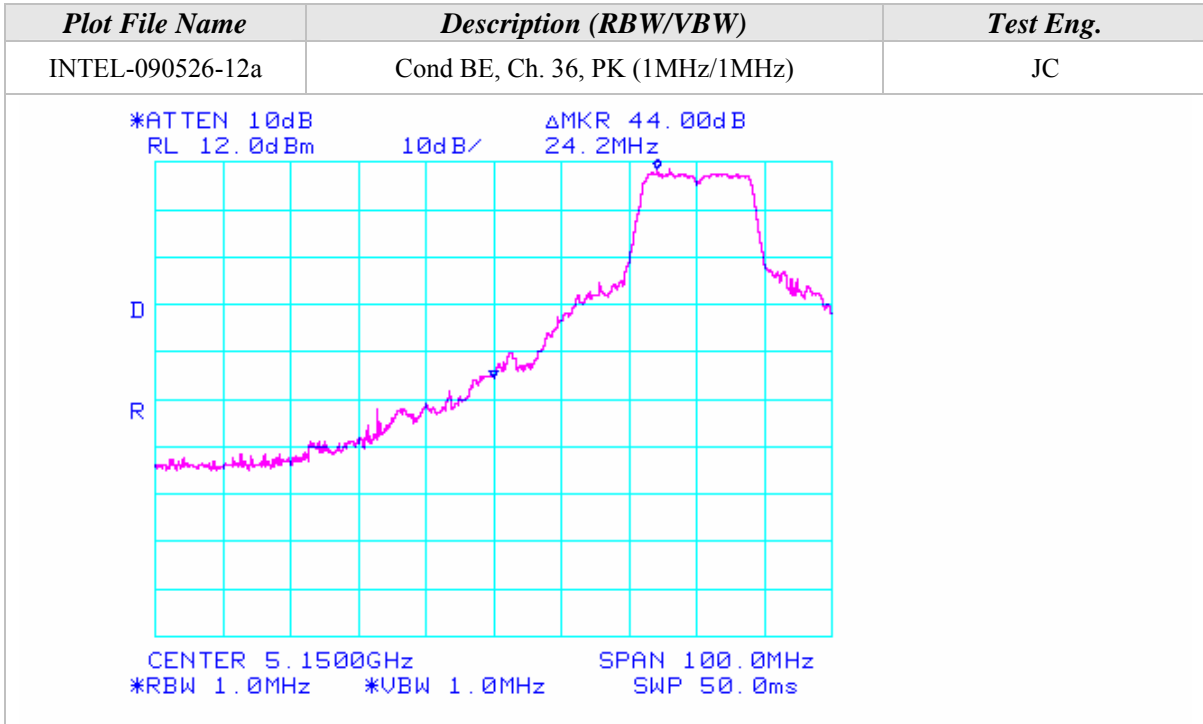



Band-Edge Plots (Continued)

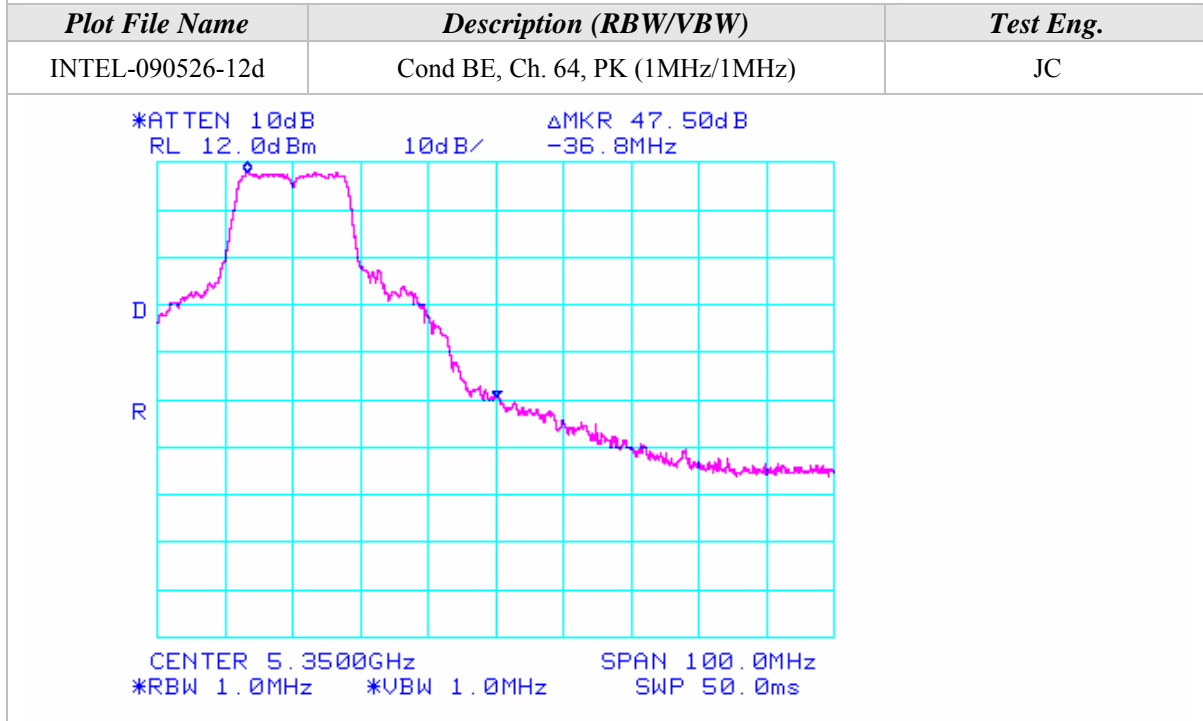
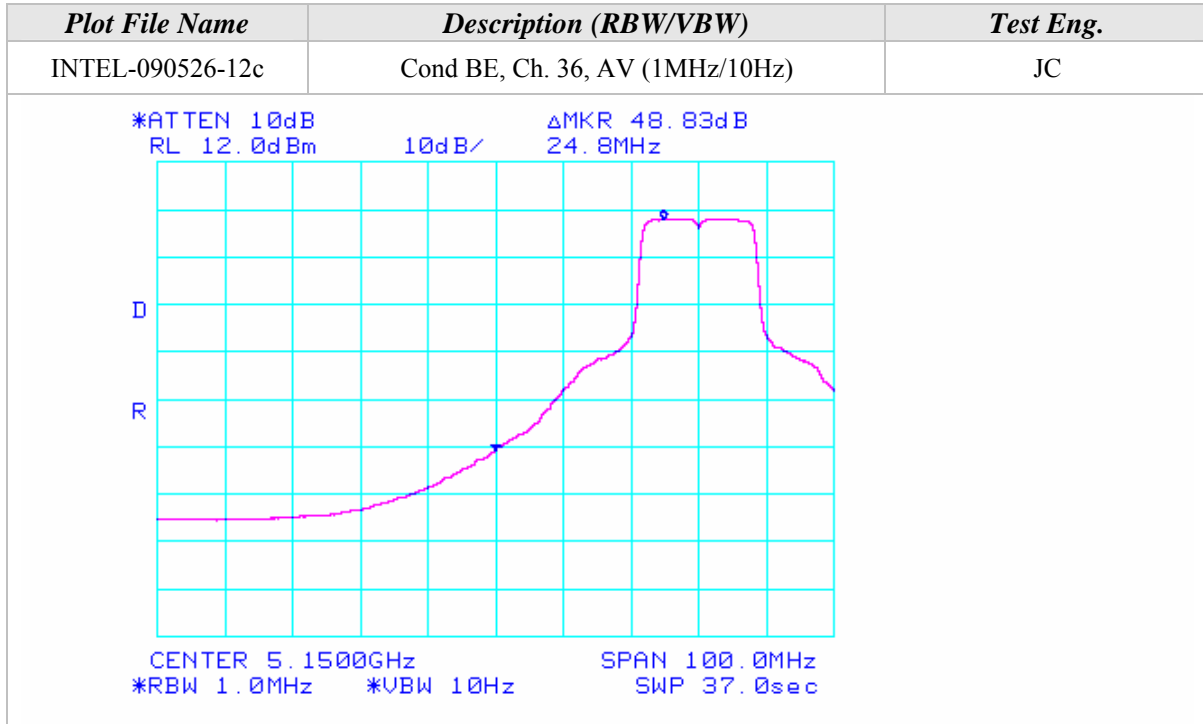

Band-Edge Plots (Continued)

Plot File Name	Description (RBW/VBW)	Test Eng.
INTEL-090526-12e	Cond BE, Ch. 64, PK (100kHz/100kHz)	JC
<p>*ATTEN 10dB                          ΔMKR 51.33dB            RL 12.0dBm                      10dB/                      -31.5MHz</p> <p>CENTER 5.3500GHz                      SPAN 100.0MHz            *RBW 100kHz                      *VBW 100kHz                      SWP 55.0ms</p>		
Plot File Name	Description (RBW/VBW)	Test Eng.
INTEL-090526-12f	Cond BE, Ch. 64, AV (1MHz/10Hz)	JC
<p>*ATTEN 10dB                          ΔMKR 51.84dB            RL 12.0dBm                      10dB/                      -33.7MHz</p> <p>CENTER 5.3500GHz                      SPAN 100.0MHz            *RBW 1.0MHz                      *VBW 10Hz                      SWP 37.0sec</p>		



Radiated Emissions Test Results (Continued)

*Spurious Emissions Measurements in 802.11a mode (5150-5350 MHz)  
Channels 36, 40, & 48  
Continuous TX at Chain A & B Antenna ports with Shanghai Universe Antennas  
Aegis Labs, Inc. File #: INTEL-090601-06*

**RADIATED EMISSIONS - Horizontal Antenna Polarization**

Freq. (MHz)	Meter Reading (dBuV)	Antenna Height (cm)	Azimuth (degrees)	Quasi pk or AVG (dBuV)	Preamp Factor (dB)	Cable Factor (dB)	Ant. Factor (dB)	Corrected Reading (dBuV)	Limits (dBuV)	Diff (dB) +=FAIL	Channel/ Chain Tested
3466.66	52.83	100	315		47.64	3.06	32.79	41.05	68.00	-26.95	<b>Ch. 40/</b>
6933.33	51.83	100	315		46.25	4.40	35.79	45.77	68.00	-22.23	<b>A</b>
3466.66	52.83	100	315		47.64	3.06	32.79	41.05	68.00	-26.95	<b>Ch. 40/</b>
6933.33	51.67	100	0		46.25	4.40	35.79	45.61	68.00	-22.39	<b>B</b>
3453.33	53.33	100	0		47.64	3.06	32.79	41.54	68.00	-26.46	<b>Ch. 36/</b>
6906.66	53.83	100	0		46.29	4.39	35.78	47.71	68.00	-20.29	<b>A</b>
3493.33	53.17	100	0		47.62	3.06	32.80	41.41	68.00	-26.59	<b>Ch. 48/</b>
6986.66	52.33	100	45		46.16	4.42	35.80	46.39	68.00	-21.61	<b>A</b>

**RADIATED EMISSIONS - Vertical Antenna Polarization**

Freq. (MHz)	Meter Reading (dBuV)	Antenna Height (cm)	Azimuth (degrees)	Quasi pk or AVG (dBuV)	Preamp Factor (dB)	Cable Factor (dB)	Ant. Factor (dB)	Corrected Reading (dBuV)	Limits (dBuV)	Diff (dB) +=FAIL	Comments
3466.66	53.83	100	315		47.64	3.06	32.59	41.85	68.00	-26.15	<b>Ch. 40/</b>
6933.33	52.83	100	315		46.25	4.40	35.59	46.57	68.00	-21.43	<b>A</b>
3466.66	54.00	100	315		47.64	3.06	32.59	42.02	68.00	-25.98	<b>Ch. 40/</b>
6933.33	52.17	100	315		46.25	4.40	35.59	45.91	68.00	-22.09	<b>B</b>
3453.33	53.67	100	0		47.64	3.06	32.59	41.68	68.00	-26.32	<b>Ch. 36/</b>
6906.66	55.00	100	0		46.29	4.39	35.58	48.68	68.00	-19.32	<b>B</b>
3493.33	51.67	100	0		47.62	3.06	32.60	39.71	68.00	-28.29	<b>Ch. 48/</b>
6986.66	51.67	100	0		0.00	0.00	0.00	51.67	68.00	-16.33	<b>B</b>



Radiated Emissions Test Results (Continued)

*Spurious Emissions Measurements in 802.11a mode (5150-5350 MHz)  
Channels 52, 56, & 64  
Continuous TX at Chain A & B Antenna ports with Shanghai Universe Antennas  
Aegis Labs, Inc. File #: INTEL-090601-06*

**RADIATED EMISSIONS - Horizontal Antenna Polarization**

Freq. (MHz)	Meter Reading (dBuV)	Antenna Height (cm)	Azimuth (degrees)	Quasi pk or AVG (dBuV)	Preamp Factor (dB)	Cable Factor (dB)	Ant. Factor (dB)	Corrected Reading (dBuV)	Limits (dBuV)	Diff (dB) +/-FAIL	Channel/Chain Tested
3520.00	52.17	100	0		47.62	3.08	32.82	40.46	68.00	-27.54	<b>Ch. 56/A</b>
3520.00	52.67	100	0		47.62	3.08	32.82	40.96	68.00	-27.04	<b>Ch. 56/B</b>
3506.66	52.83	100	0		47.62	3.07	32.81	41.09	68.00	-26.91	<b>Ch. 52/</b>
7013.33	51.17	100	0		46.13	4.43	35.80	45.28	68.00	-22.72	<b>B</b>
3546.66	53.50	100	0		47.62	3.12	32.86	41.85	68.00	-26.15	<b>Ch. 64/</b>
7093.33	52.50	100	45		46.05	4.46	35.78	46.70	68.00	-21.30	<b>B</b>

**RADIATED EMISSIONS - Vertical Antenna Polarization**

Freq. (MHz)	Meter Reading (dBuV)	Antenna Height (cm)	Azimuth (degrees)	Quasi pk or AVG (dBuV)	Preamp Factor (dB)	Cable Factor (dB)	Ant. Factor (dB)	Corrected Reading (dBuV)	Limits (dBuV)	Diff (dB) +/-FAIL	Comments
3520.00	52.50	100	0		47.62	3.08	32.63	40.60	68.00	-27.40	<b>Ch. 56/</b>
7040.00	51.83	100	0		46.10	4.44	35.61	45.78	68.00	-22.22	<b>A</b>
3520.00	52.67	100	0		47.62	3.08	32.63	40.77	68.00	-27.23	<b>Ch. 56/</b>
7040.00	52.50	100	0		46.10	4.44	35.61	46.45	68.00	-21.55	<b>B</b>
3506.66	53.50	100	0		47.62	3.07	32.61	41.56	68.00	-26.44	<b>Ch. 52/</b>
7013.33	52.67	100	0		46.13	4.43	35.60	46.58	68.00	-21.42	<b>A</b>
3546.66	53.33	100	0		47.62	3.12	32.67	41.50	68.00	-26.50	<b>Ch. 64/</b>
7093.33	52.00	100	0		46.05	4.46	35.62	46.03	68.00	-21.97	<b>A</b>

**RADIATED EMISSIONS TEST RESULTS**

<b>CLIENT:</b>	Intel Corporation	<b>DATE:</b>	08/17/09
<b>EUT:</b>	Intel® Centrino® Ultimate-N 6200	<b>PROJECT NUMBER:</b>	INTEL-090601
<b>MODEL NUMBER:</b>	622ANHMW	<b>TEST ENGINEER:</b>	JC
<b>SERIAL NUMBER:</b>	0015005A3C7C	<b>SITE #:</b>	2
<b>CONFIGURATION:</b>	Tested installed in an extender board connected to the host laptop's mini PCI slot in <b>802.11n (5150-5350 MHz) mode 20MHz Wide.</b>	<b>TEMPERATURE:</b>	24° C
		<b>HUMIDITY:</b>	46% RH
		<b>TIME:</b>	9:30 AM

<b>Description:</b>	Radiated RF Emissions (1 GHz – 18 GHz)
<b>Results:</b>	<b>PASSED</b> Horizontal and Vertical Antenna Polarizations Class B Limits
<b>Note:</b>	Radiated Emissions Measurements were performed on the EUT with power supply set at the following voltage and frequency. <ul style="list-style-type: none"> <li>• 120VAC / 60 Hz.</li> </ul>

<b>Unwanted Spurious Emissions Limits</b>			
<b>Frequency (MHz)</b>	<b>Field Strength (uV/m)</b>	<b>Field Strength (dBuV/m) (Emissions in the restricted bands)</b>	<b>Field Strength (dBm/MHz) (Emissions outside the restricted bands)</b>
Above 960	500	54.00 (Average) 74.00 (Peak)	< -20 dBc

## Radiated Emissions Sample Calculations

$$\text{Corrected Meter Reading} = \text{Meter Reading} + F + C - D$$

Where, F = Antenna Factor

C = Cable Factor

G = Amplifier Gain

D = Distance Factor (if applicable)

Therefore, the equation for determining the Corrected Meter Reading Limit (CML) is:

$$\text{CML} = \text{Specification Limit} - F - C + D$$



Radiated Emissions Test Results (Continued)

*Fundamental Measurements in 802.11n mode 20MHz Wide (5150-5350 MHz)  
 Channels 36, 40, 48, 52, 56, & 64  
 Continuous TX at Chain A Antenna port with Shanghai Universe Antennas  
 Aegis Labs, Inc. File #: INTEL-090601-02*

<b>RADIATED EMISSIONS - Horizontal Antenna Polarization</b>											
Freq. (MHz)	Meter Reading (dBuV)	Antenna Height (cm)	Azimuth (degrees)	Quasi pk or AVG (dBuV)		Cable Factor (dB)	Ant. Factor (dB)	Corrected Reading (dBuV)	Limits (dBuV)	Diff (dB) +=FAIL	Comments
5180.00	60.75	100	45			3.77	34.28	98.80			<b>Ch. 36</b>
5180.00				53.61	A	3.77	34.28	91.66			
5200.00	61.28	100	45			3.78	34.30	99.36			<b>Ch. 40</b>
5200.00				54.76	A	3.78	34.30	92.84			
5240.00	61.16	100	45			3.80	34.34	99.30			<b>Ch. 48</b>
5240.00				53.78	A	3.80	34.34	91.92			
5260.00	62.53	100	45			3.80	34.36	100.69			<b>Ch. 52</b>
5260.00				54.81	A	3.80	34.36	92.97			
5280.00	61.89	100	0			3.81	34.38	100.08			<b>Ch. 56</b>
5280.00				54.20	A	3.81	34.38	92.39			
5320.00	61.65	100	45			3.83	34.42	99.90			<b>Ch. 64</b>
5320.00				53.42	A	3.83	34.42	91.67			

<b>RADIATED EMISSIONS - Vertical Antenna Polarization</b>											
Freq. (MHz)	Meter Reading (dBuV)	Antenna Height (cm)	Azimuth (degrees)	Quasi pk or AVG (dBuV)		Cable Factor (dB)	Ant. Factor (dB)	Corrected Reading (dBuV)	Limits (dBuV)	Diff (dB) +=FAIL	Comments
5180.00	62.76	100	270			3.77	34.48	101.01			<b>Ch. 36</b>
5180.00				52.95	A	3.77	34.48	91.20			
5200.00	63.51	100	315			3.78	34.50	101.79			<b>Ch. 40</b>
5200.00				54.38	A	3.78	34.50	92.66			
5240.00	64.15	100	315			3.80	34.54	102.49			<b>Ch. 48</b>
5240.00				54.77	A	3.80	34.54	93.11			
5260.00	65.38	100	0			3.80	34.56	103.74			<b>Ch. 52</b>
5260.00				55.58	A	3.80	34.56	93.94			
5280.00	64.26	100	315			3.81	34.58	102.65			<b>Ch. 56</b>
5280.00				54.32	A	3.81	34.58	92.71			
5320.00	65.65	100	315			3.83	34.62	104.10			<b>Ch. 64</b>
5320.00				56.13	A	3.83	34.62	94.58			

NOTE: Fundamental signals measured to calculate the band edge field strengths using the “Marker Delta Method”.



Radiated Emissions Test Results (Continued)

**Band Edge Field Strength Measurements in 802.11n mode 20MHz Wide (5150-5350 MHz)**  
**Channels 36 & 64**  
**Continuous TX at Chain A Antenna port with Shanghai Universe Antennas**  
**Aegis Labs, Inc. File #: INTEL-090601-02**

<b>RADIATED EMISSIONS - Horizontal Antenna Polarization</b>										
Freq. (MHz)	Meter Reading (dBuV)	Antenna Height (cm)	Azimuth (degrees)	Quasi pk or AVG (dBuV)	Cable Factor (dB)	Ant. Factor (dB)	Corrected Reading (dBuV)	Limits (dBuV)	Diff (dB) +=FAIL	Comments
5150.00							55.97	74.00	-18.03	<b>Ch. 36</b>
5150.00							49.64	74.00	-24.36	
5150.00					A		42.49	54.00	-11.51	
5150.00					A		42.50	54.00	-11.50	
5350.00							53.23	74.00	-20.77	<b>Ch. 64</b>
5350.00							48.23	74.00	-25.77	
5350.00					A		39.00	54.00	-15.00	
5350.00					A		40.00	54.00	-14.00	

<b>RADIATED EMISSIONS - Vertical Antenna Polarization</b>										
Freq. (MHz)	Meter Reading (dBuV)	Antenna Height (cm)	Azimuth (degrees)	Quasi pk or AVG (dBuV)	Cable Factor (dB)	Ant. Factor (dB)	Corrected Reading (dBuV)	Limits (dBuV)	Diff (dB) +=FAIL	Comments
5150.00							58.18	74.00	-15.82	<b>Ch. 36</b>
5150.00							51.85	74.00	-22.15	
5150.00					A		42.03	54.00	-11.97	
5150.00					A		42.04	54.00	-11.96	
5350.00							57.43	74.00	-16.57	<b>Ch. 64</b>
5350.00							52.43	74.00	-21.57	
5350.00					A		41.91	54.00	-12.09	
5350.00					A		42.91	54.00	-11.09	

NOTE: The “Band Edge Field Strength” was calculated using the “Fundamental” and “Conducted Band Edge” measurements per the “Marker-Delta Method” with the following formula:

$$BE = Fm - \Delta m$$

Where

BE = Band Edge Field Strength

Fm = Measured Fundamental (Peak or Average)

Δm = Measured Conducted Band Edge Delta (Peak or Average)



Band-Edge Plots (Continued)

Plot File Name	Description (RBW/VBW)	Test Eng.
INTEL-090601-06a	Cond BE, Ch. 36, PK (1MHz/1MHz)	JC

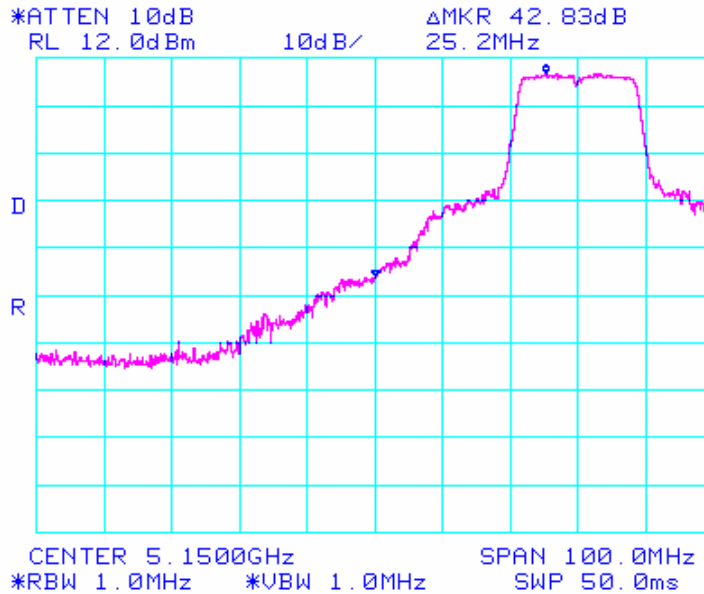

Plot File Name	Description (RBW/VBW)	Test Eng.
INTEL-090601-06b	Cond BE, Ch. 36, PK (100kHz/100kHz)	JC

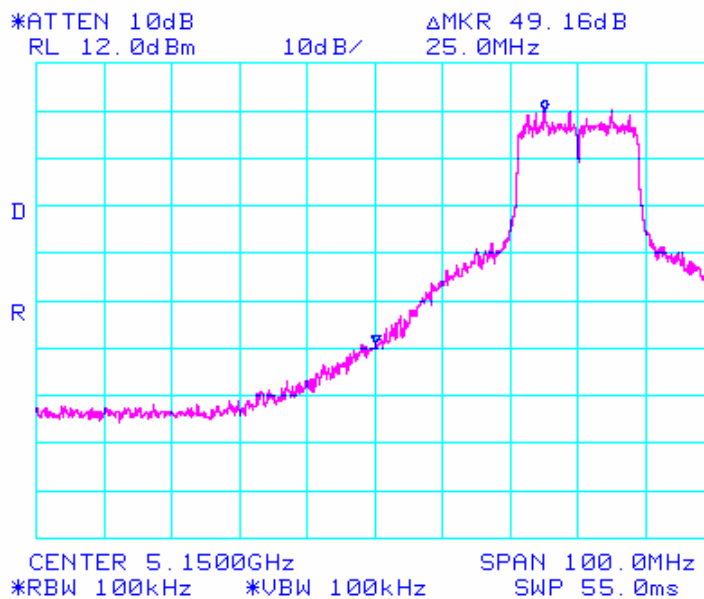





Band-Edge Plots (Continued)

<i>Plot File Name</i>	<i>Description (RBW/VBW)</i>	<i>Test Eng.</i>
INTEL-090601-06c	Cond BE, Ch. 36, AV (1MHz/10Hz)	JC
<p>*ATTEN 10dB RL 12.0dBm 10dB/ ΔMKR 49.17dB 26.7MHz</p> <p>CENTER 5.1500GHz SPAN 100.0MHz *RBW 1.0MHz *VBW 10Hz SWP 37.0sec</p>		
<i>Plot File Name</i>	<i>Description (RBW/VBW)</i>	<i>Test Eng.</i>
INTEL-090601-06d	Cond BE, Ch. 64, PK (1MHz/1MHz)	JC
<p>*ATTEN 10dB RL 12.0dBm 10dB/ ΔMKR 46.67dB -34.8MHz</p> <p>CENTER 5.3500GHz SPAN 100.0MHz *RBW 1.0MHz *VBW 1.0MHz SWP 50.0ms</p>		



Band-Edge Plots (Continued)

<i>Plot File Name</i>	<i>Description (RBW/VBW)</i>	<i>Test Eng.</i>
INTEL-090601-06e	Cond BE, Ch. 64, PK (100kHz/100kHz)	JC
<p>*ATTEN 10dB    ΔMKR 51.67dB RL 12.0dBm    10dB/    -25.3MHz</p> <p>CENTER 5.3500GHz    SPAN 100.0MHz *RBW 100kHz    *VBW 100kHz    SWP 55.0ms</p>		
<i>Plot File Name</i>	<i>Description (RBW/VBW)</i>	<i>Test Eng.</i>
INTEL-090601-06f	Cond BE, Ch. 64, AV (1MHz/10Hz)	JC
<p>*ATTEN 10dB    ΔMKR 52.67dB RL 12.0dBm    10dB/    -27.3MHz</p> <p>CENTER 5.3500GHz    SPAN 100.0MHz *RBW 1.0MHz    *VBW 10Hz    SWP 37.0sec</p>		



Radiated Emissions Test Results (Continued)

*Fundamental Measurements in 802.11n mode 20MHz Wide (5150-5350 MHz)  
Channels 36, 40, 48, 52, 56, & 64  
Continuous TX at Chain B Antenna port with Shanghai Universe Antennas  
Aegis Labs, Inc. File #: INTEL-090601-04*

<b>RADIATED EMISSIONS - Horizontal Antenna Polarization</b>											
<i>Freq. (MHz)</i>	<i>Meter Reading (dBuV)</i>	<i>Antenna Height (cm)</i>	<i>Azimuth (degrees)</i>	<i>Quasi pk or AVG (dBuV)</i>		<i>Cable Factor (dB)</i>	<i>Ant. Factor (dB)</i>	<i>Corrected Reading (dBuV)</i>	<i>Limits (dBuV)</i>	<i>Diff (dB) +=FAIL</i>	<i>Comments</i>
5180.00	63.67	100	315			3.77	34.28	101.72			<b>Ch. 36</b>
5180.00				53.83	A	3.77	34.28	91.88			
5200.00	64.33	100	315			3.78	34.30	102.41			<b>Ch. 40</b>
5200.00				54.67	A	3.78	34.30	92.75			
5240.00	63.17	100	0			3.80	34.34	101.31			<b>Ch. 48</b>
5240.00				54.00	A	3.80	34.34	92.14			
5260.00	65.00	100	315			3.80	34.36	103.16			<b>Ch. 52</b>
5260.00				55.83	A	3.80	34.36	93.99			
5280.00	64.33	100	315			3.81	34.38	102.52			<b>Ch. 64</b>
5280.00				55.00	A	3.81	34.38	93.19			

<b>RADIATED EMISSIONS - Vertical Antenna Polarization</b>											
<i>Freq. (MHz)</i>	<i>Meter Reading (dBuV)</i>	<i>Antenna Height (cm)</i>	<i>Azimuth (degrees)</i>	<i>Quasi pk or AVG (dBuV)</i>		<i>Cable Factor (dB)</i>	<i>Ant. Factor (dB)</i>	<i>Corrected Reading (dBuV)</i>	<i>Limits (dBuV)</i>	<i>Diff (dB) +=FAIL</i>	<i>Comments</i>
5180.00	63.00	100	315			3.77	34.48	101.25			<b>Ch. 36</b>
5180.00				53.17	A	3.77	34.48	91.42			
5200.00	63.67	100	315			3.78	34.50	101.95			<b>Ch. 40</b>
5200.00				54.67	A	3.78	34.50	92.95			
5240.00	64.33	100	0			3.80	34.54	102.67			<b>Ch. 48</b>
5240.00				55.00	A	3.80	34.54	93.34			
5260.00	65.50	100	315			3.80	34.56	103.86			<b>Ch. 52</b>
5260.00				55.83	A	3.80	34.56	94.19			
5280.00	64.67	100	315			3.81	34.58	103.06			<b>Ch. 64</b>
5280.00				54.50	A	3.81	34.58	92.89			

NOTE: Fundamental signals measured to calculate the band edge field strengths using the “Marker Delta Method”.



Radiated Emissions Test Results (Continued)

**Band Edge Field Strength Measurements in 802.11n mode 20MHz Wide (5150-5350 MHz)**  
**Channels 36 & 64**  
**Continuous TX at Chain B Antenna port with Shanghai Universe Antennas**  
**Aegis Labs, Inc. File #: INTEL-090601-04**

<b>RADIATED EMISSIONS - Horizontal Antenna Polarization</b>										
Freq. (MHz)	Meter Reading (dBuV)	Antenna Height (cm)	Azimuth (degrees)	Quasi pk or AVG (dBuV)	Cable Factor (dB)	Ant. Factor (dB)	Corrected Reading (dBuV)	Limits (dBuV)	Diff (dB) +=FAIL	Comments
5150.00							58.55	74.00	-15.45	<b>Ch. 36</b>
5150.00							53.06	74.00	-20.94	
5150.00					A		43.71	54.00	-10.29	
5150.00					A		43.22	54.00	-10.78	
5350.00							56.42	74.00	-17.58	<b>Ch. 64</b>
5350.00							50.08	74.00	-23.92	
5350.00					A		41.75	54.00	-12.25	
5350.00					A		40.58	54.00	-13.42	

<b>RADIATED EMISSIONS - Vertical Antenna Polarization</b>										
Freq. (MHz)	Meter Reading (dBuV)	Antenna Height (cm)	Azimuth (degrees)	Quasi pk or AVG (dBuV)	Cable Factor (dB)	Ant. Factor (dB)	Corrected Reading (dBuV)	Limits (dBuV)	Diff (dB) +=FAIL	Comments
5150.00							58.08	74.00	-15.92	<b>Ch. 36</b>
5150.00							52.59	74.00	-21.41	
5150.00					A		43.25	54.00	-10.75	
5150.00					A		42.76	54.00	-11.24	
5350.00							58.28	74.00	-15.72	<b>Ch. 64</b>
5350.00							51.94	74.00	-22.06	
5350.00					A		43.61	54.00	-10.39	
5350.00					A		42.44	54.00	-11.56	

NOTE: The “Band Edge Field Strength” was calculated using the “Fundamental” and “Conducted Band Edge” measurements per the “Marker-Delta Method” with the following formula:

$$BE = F_m - \Delta m$$

Where

BE = Band Edge Field Strength

F<sub>m</sub> = Measured Fundamental (Peak or Average)

Δ<sub>m</sub> = Measured Conducted Band Edge Delta (Peak or Average)

Band-Edge Plots (Continued)

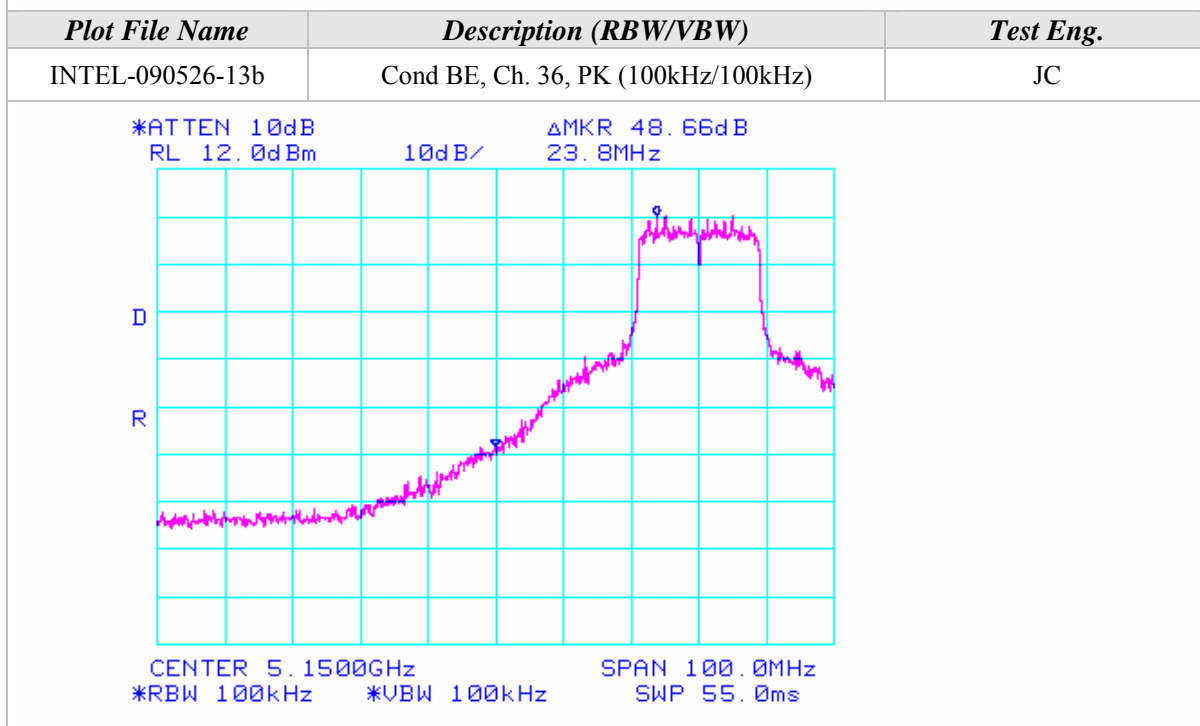
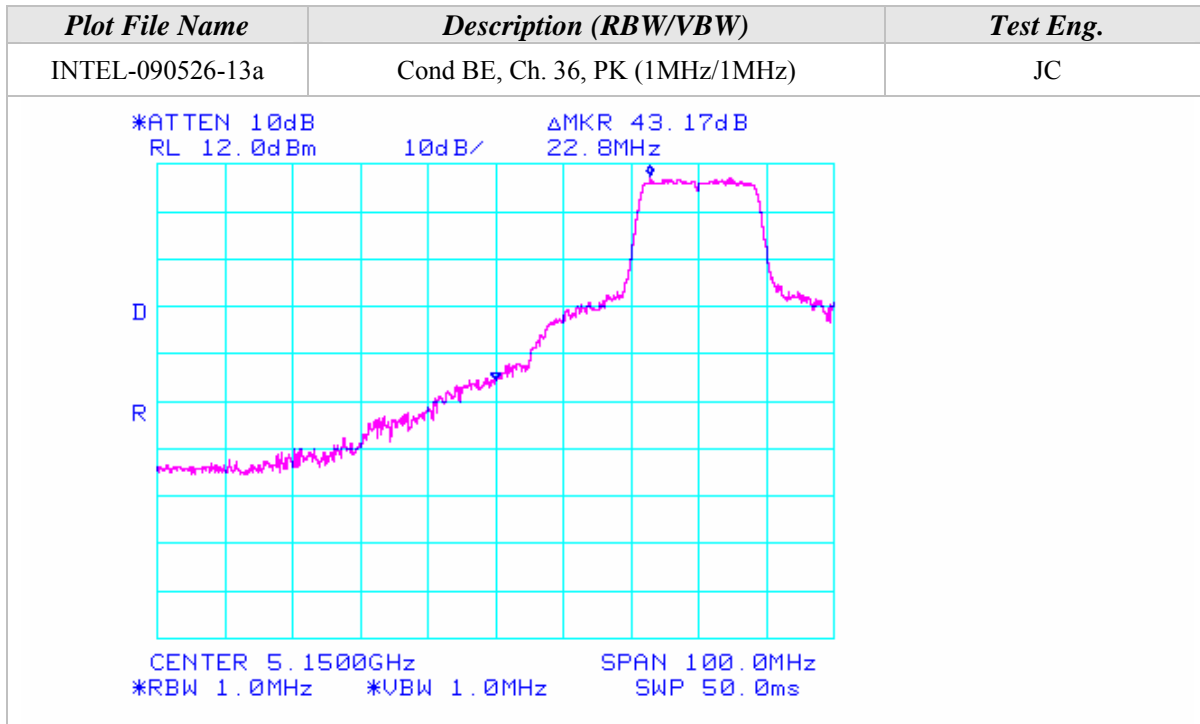



Band-Edge Plots (Continued)

<b>Plot File Name</b>	<b>Description (RBW/VBW)</b>	<b>Test Eng.</b>
INTEL-090526-13c	Cond BE, Ch. 36, AV (1MHz/10Hz)	JC
<p>*ATTEN 10dB                  ΔMKR 48.17dB            RL 12.0dBm                10dB/            24.7MHz</p> <p>CENTER 5.1500GHz                  SPAN 100.0MHz            *RBW 1.0MHz              *VBW 10Hz                  SWP 37.0sec</p>		
<b>Plot File Name</b>	<b>Description (RBW/VBW)</b>	<b>Test Eng.</b>
INTEL-090526-13d	Cond BE, Ch. 64, PK (1MHz/1MHz)	JC
<p>*ATTEN 10dB                  ΔMKR 46.00dB            RL 12.0dBm                10dB/            -35.0MHz</p> <p>CENTER 5.3500GHz                  SPAN 100.0MHz            *RBW 1.0MHz              *VBW 1.0MHz                  SWP 50.0ms</p>		

Band-Edge Plots (Continued)

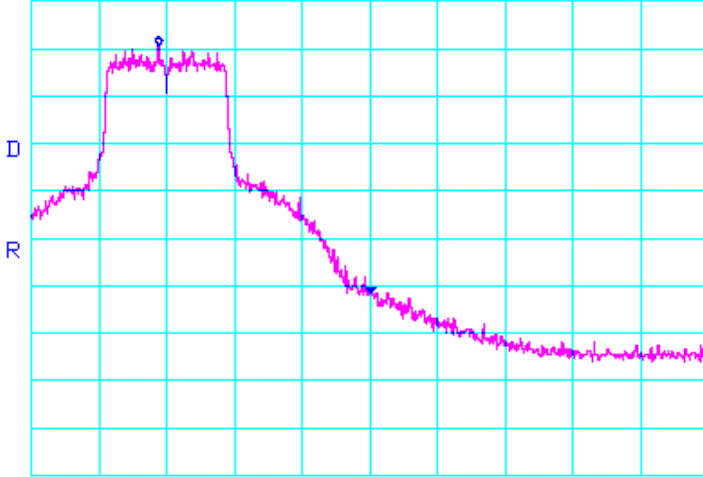
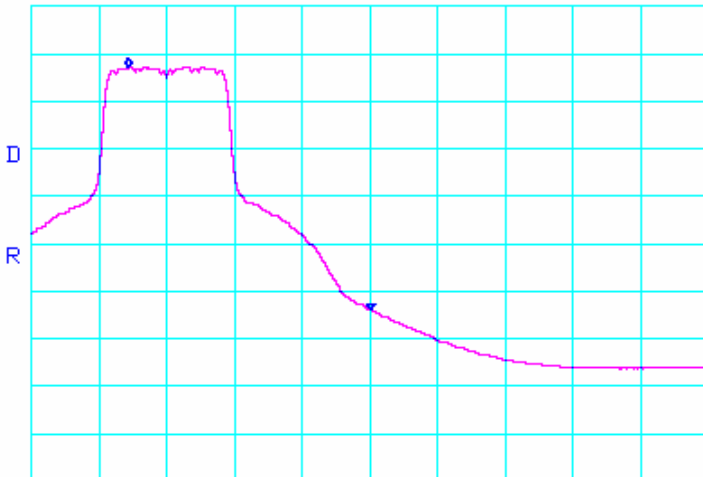
<i>Plot File Name</i>	<i>Description (RBW/VBW)</i>	<i>Test Eng.</i>
INTEL-090526-13e	Cond BE, Ch. 64, PK (100kHz/100kHz)	JC
<p>*ATTEN 10dB                                  ΔMKR 52.34dB RL 12.0dBm                                  10dB/                                  -31.3MHz</p>  <p>CENTER 5.3500GHz                                  SPAN 100.0MHz *RBW 100kHz                                  *VBW 100kHz                                  SWP 55.0ms</p>		
<i>Plot File Name</i>	<i>Description (RBW/VBW)</i>	<i>Test Eng.</i>
INTEL-090526-13f	Cond BE, Ch. 64, AV (1MHz/10Hz)	JC
<p>*ATTEN 10dB                                  ΔMKR 51.17dB RL 12.0dBm                                  10dB/                                  -35.8MHz</p>  <p>CENTER 5.3500GHz                                  SPAN 100.0MHz *RBW 1.0MHz                                  *VBW 10Hz                                  SWP 37.0sec</p>		



Radiated Emissions Test Results (Continued)

*Spurious Emissions Measurements in 802.11n mode 20MHz Wide (5150-5350 MHz)  
Channels 36, 40, & 48  
Continuous TX at Chain A & B Antenna ports with Shanghai Universe Antennas  
Aegis Labs, Inc. File #: INTEL-090601-07*

**RADIATED EMISSIONS - Horizontal Antenna Polarization**

Freq. (MHz)	Meter Reading (dBuV)	Antenna Height (cm)	Azimuth (degrees)	Quasi pk or AVG (dBuV)	Preamp Factor (dB)	Cable Factor (dB)	Ant. Factor (dB)	Corrected Reading (dBuV)	Limits (dBuV)	Diff (dB) +=FAIL	Channel/ Chain Tested
3466.66	52.33	100	315		47.64	3.06	32.79	40.55	68.00	-27.45	<b>Ch. 40/A</b>
3466.66	51.00	100	270		47.64	3.06	32.79	39.22	68.00	-28.78	<b>Ch. 40/</b>
6933.33	52.33	100	0		46.25	4.40	35.79	46.27	68.00	-21.73	<b>B</b>
3453.33	52.17	100	315		47.64	3.06	32.79	40.38	68.00	-27.62	<b>Ch. 36/</b>
6906.66	54.33	100	0		46.29	4.39	35.78	48.21	68.00	-19.79	<b>B</b>
3493.33	52.83	100	315		47.62	3.06	32.80	41.07	68.00	-26.93	<b>Ch. 48/</b>
6986.66	51.67	100	0		46.16	4.42	35.80	45.73	68.00	-22.27	<b>B</b>

**RADIATED EMISSIONS - Vertical Antenna Polarization**

Freq. (MHz)	Meter Reading (dBuV)	Antenna Height (cm)	Azimuth (degrees)	Quasi pk or AVG (dBuV)	Preamp Factor (dB)	Cable Factor (dB)	Ant. Factor (dB)	Corrected Reading (dBuV)	Limits (dBuV)	Diff (dB) +=FAIL	Comments
3466.66	53.83	100	0		47.64	3.06	32.59	41.85	68.00	-26.15	<b>Ch. 40/</b>
6933.33	53.17	100	45		46.25	4.40	35.59	46.91	68.00	-21.09	<b>A</b>
3466.66	54.00	100	0		47.64	3.06	32.59	42.02	68.00	-25.98	<b>Ch. 40/</b>
6933.33	54.17	100	45		46.25	4.40	35.59	47.91	68.00	-20.09	<b>B</b>
3453.33	54.50	100	0		47.64	3.06	32.59	42.51	68.00	-25.49	<b>Ch. 36/</b>
6906.66	54.33	100	45		46.29	4.39	35.58	48.01	68.00	-19.99	<b>B</b>
3493.33	54.17	100	0		47.62	3.06	32.60	42.21	68.00	-25.79	<b>Ch. 48/</b>
6986.66	52.67	100	45		46.16	4.42	35.60	46.53	68.00	-21.47	<b>B</b>





Radiated Emissions Test Results (Continued)

*Spurious Emissions Measurements in 802.11n mode 20MHz Wide (5150-5350 MHz)  
Channels 52, 56, & 64  
Continuous TX at Chain A & B Antenna ports with Shanghai Universe Antennas  
Aegis Labs, Inc. File #: INTEL-090601-07*

**RADIATED EMISSIONS - Horizontal Antenna Polarization**

Freq. (MHz)	Meter Reading (dBuV)	Antenna Height (cm)	Azimuth (degrees)	Quasi pk or AVG (dBuV)	Preamp Factor (dB)	Cable Factor (dB)	Ant. Factor (dB)	Corrected Reading (dBuV)	Limits (dBuV)	Diff (dB) +=FAIL	Channel/Chain Tested
3520.00	52.67	100	0		47.62	3.08	32.82	40.96	68.00	-27.04	<b>Ch. 56/A</b>
7040.00	51.17	100	45		46.10	4.44	35.79	45.31	68.00	-22.69	<b>Ch. 56/B</b>
3506.66	53.67	100	0		47.62	3.07	32.81	41.93	68.00	-26.07	<b>Ch. 52/</b>
7013.33	52.17	100	0		46.13	4.43	35.80	46.28	68.00	-21.72	<b>B</b>
3546.66	53.50	100	0		47.62	3.12	32.86	41.85	68.00	-26.15	<b>Ch. 64/</b>
7093.33	52.33	100	0		46.05	4.46	35.78	46.53	68.00	-21.47	<b>B</b>

**RADIATED EMISSIONS - Vertical Antenna Polarization**

Freq. (MHz)	Meter Reading (dBuV)	Antenna Height (cm)	Azimuth (degrees)	Quasi pk or AVG (dBuV)	Preamp Factor (dB)	Cable Factor (dB)	Ant. Factor (dB)	Corrected Reading (dBuV)	Limits (dBuV)	Diff (dB) +=FAIL	Comments
3520.00	53.67	100	0		47.62	3.08	32.63	41.77	68.00	-26.23	<b>Ch. 56/</b>
7040.00	52.67	100	90		46.10	4.44	35.61	46.62	68.00	-21.38	<b>A</b>
3520.00	53.67	100	0		47.62	3.08	32.63	41.77	68.00	-26.23	<b>Ch. 56/</b>
7040.00	52.50	100	90		46.10	4.44	35.61	46.45	68.00	-21.55	<b>B</b>
3506.66	53.83	100	0		47.62	3.07	32.61	41.89	68.00	-26.11	<b>Ch. 52/</b>
7013.33	53.67	100	45		46.13	4.43	35.60	47.58	68.00	-20.42	<b>A</b>
10519.98	50.17	100	45		45.29	5.56	37.52	47.97	68.00	-20.03	
3546.66	53.33	100	45		47.62	3.12	32.67	41.50	68.00	-26.50	<b>Ch. 64/</b>
7093.33	54.83	100	90		46.05	4.46	35.62	48.86	68.00	-19.14	<b>A</b>
10639.98	51.00	100	0		45.28	5.59	37.67	48.97	68.00	-19.03	



Radiated Emissions Test Results (Continued)

*Spurious Emissions Measurements in 802.11n mode 20MHz Wide (5150-5350 MHz)  
Channels 36, 40, & 48  
Continuous TX at Dual Chain AB Antenna ports with Shanghai Universe Antennas  
Aegis Labs, Inc. File #: INTEL-090601-07*

**RADIATED EMISSIONS - Horizontal Antenna Polarization**

Freq. (MHz)	Meter Reading (dBuV)	Antenna Height (cm)	Azimuth (degrees)	Quasi pk or AVG (dBuV)	Preamp Factor (dB)	Cable Factor (dB)	Ant. Factor (dB)	Corrected Reading (dBuV)	Limits (dBuV)	Diff (dB) +=FAIL	Channel/ Chain Tested	
3453.33	53.33	100	225			50.71	3.06	32.78	38.47	68.00	-29.53	<b>Ch. 36/</b>
6906.66	58.00	100	180			50.50	4.39	35.68	47.57	68.00	-20.43	<b>AB</b>
10359.99	58.33	100	180			50.39	5.52	37.42	50.88	68.00	-17.12	
3466.66	52.17	100	45			50.72	3.06	32.79	37.30	68.00	-30.70	<b>Ch. 40/</b>
6933.33	55.50	100	135			50.48	4.40	35.69	45.11	68.00	-22.89	<b>AB</b>
10399.98	52.67	100	135			50.40	5.53	37.44	45.24	68.00	-22.76	
3493.33	55.17	100	225			50.75	3.06	32.80	40.28	68.00	-27.72	<b>Ch. 48/</b>
6986.66	57.83	100	180			50.44	4.42	35.70	47.51	68.00	-20.49	<b>AB</b>
10480.00	50.50	100	180			50.42	5.55	37.49	43.12	68.00	-24.88	

**RADIATED EMISSIONS - Vertical Antenna Polarization**

Freq. (MHz)	Meter Reading (dBuV)	Antenna Height (cm)	Azimuth (degrees)	Quasi pk or AVG (dBuV)	Preamp Factor (dB)	Cable Factor (dB)	Ant. Factor (dB)	Corrected Reading (dBuV)	Limits (dBuV)	Diff (dB) +=FAIL	Comments	
3453.33	53.67	100	135			50.71	3.06	32.87	38.90	68.00	-29.10	<b>Ch. 36/</b>
6906.66	56.67	100	225			50.50	4.39	35.60	46.16	68.00	-21.84	<b>AB</b>
3466.66	53.83	100	0			50.72	3.06	32.88	39.05	68.00	-28.95	<b>Ch. 40/</b>
6933.33	54.67	100	180			50.48	4.40	35.60	44.19	68.00	-23.81	<b>AB</b>
10399.99	53.33	100	135			50.40	5.53	37.44	45.90	68.00	-22.10	
3493.33	55.17	100	135			50.75	3.06	32.90	40.37	68.00	-27.63	<b>Ch. 48/</b>
6986.66	53.50	100	180			50.44	4.42	35.60	43.08	68.00	-24.92	<b>AB</b>



Radiated Emissions Test Results (Continued)

*Spurious Emissions Measurements in 802.11n mode 20MHz Wide (5150-5350 MHz)  
Channels 52, 56, & 64  
Continuous TX at Dual Chain AB Antenna ports with Shanghai Universe Antennas  
Aegis Labs, Inc. File #: INTEL-090601-07*

**RADIATED EMISSIONS - Horizontal Antenna Polarization**

Freq. (MHz)	Meter Reading (dBuV)	Antenna Height (cm)	Azimuth (degrees)	Quasi pk or AVG (dBuV)	Preamp Factor (dB)	Cable Factor (dB)	Ant. Factor (dB)	Corrected Reading (dBuV)	Limits (dBuV)	Diff (dB) +=FAIL	Channel/ Chain Tested	
3506.66	53.17	100	315			50.75	3.07	32.81	38.29	68.00	-29.71	<b>Ch. 52/</b>
7013.32	57.83	100	135			50.42	4.43	35.71	47.55	68.00	-20.45	<b>AB</b>
3520.00	52.50	100	270			50.74	3.08	32.82	37.67	68.00	-30.33	<b>Ch. 56/</b>
7040.00	52.33	100	225			50.41	4.44	35.72	42.09	68.00	-25.91	<b>AB</b>
3546.66	54.33	100	270			50.71	3.12	32.86	39.59	68.00	-28.41	<b>Ch. 64/</b>
7093.32	54.17	100	135			50.38	4.46	35.76	44.01	68.00	-23.99	<b>AB</b>

**RADIATED EMISSIONS - Vertical Antenna Polarization**

Freq. (MHz)	Meter Reading (dBuV)	Antenna Height (cm)	Azimuth (degrees)	Quasi pk or AVG (dBuV)	Preamp Factor (dB)	Cable Factor (dB)	Ant. Factor (dB)	Corrected Reading (dBuV)	Limits (dBuV)	Diff (dB) +=FAIL	Comments	
3506.66	54.17	100	135			50.75	3.07	32.91	39.39	68.00	-28.61	<b>Ch. 52/</b>
7013.32	54.50	100	135			50.42	4.43	35.61	44.12	68.00	-23.88	<b>AB</b>
10520.00	51.33	100	135			50.43	5.56	37.52	43.98	68.00	-24.02	
3520.00	53.50	100	0			50.74	3.08	32.92	38.76	68.00	-29.24	<b>Ch. 56/</b>
7040.00	54.33	100	135			50.41	4.44	35.64	44.00	68.00	-24.00	<b>AB</b>
10560.00	53.67	100	135			50.43	5.57	37.55	46.36	68.00	-21.64	
3546.66	53.83	100	135			50.71	3.12	32.95	39.18	68.00	-28.82	<b>Ch. 64/</b>
7093.32	53.33	100	135			50.38	4.46	35.69	43.10	68.00	-24.90	<b>AB</b>

**RADIATED EMISSIONS TEST RESULTS**

<b>CLIENT:</b>	Intel Corporation	<b>DATE:</b>	08/17/09
<b>EUT:</b>	Intel® Centrino® Ultimate-N 6200	<b>PROJECT NUMBER:</b>	INTEL-090601
<b>MODEL NUMBER:</b>	622ANHMW	<b>TEST ENGINEER:</b>	JC
<b>SERIAL NUMBER:</b>	0015005A3C7C	<b>SITE #:</b>	2
<b>CONFIGURATION:</b>	Tested installed in an extender board connected to the host laptop's mini PCI slot in <b>802.11n (5150-5350 MHz) mode 40MHz Wide.</b>	<b>TEMPERATURE:</b>	24° C
		<b>HUMIDITY:</b>	46% RH
		<b>TIME:</b>	9:30 AM

<b>Description:</b>	Radiated RF Emissions (1 GHz – 18 GHz)
<b>Results:</b>	<b>PASSED</b> Horizontal and Vertical Antenna Polarizations Class B Limits
<b>Note:</b>	Radiated Emissions Measurements were performed on the EUT with power supply set at the following voltage and frequency. <ul style="list-style-type: none"> <li>• 120VAC / 60 Hz.</li> </ul>

<b>Unwanted Spurious Emissions Limits</b>			
<b>Frequency (MHz)</b>	<b>Field Strength (uV/m)</b>	<b>Field Strength (dBuV/m) (Emissions in the restricted bands)</b>	<b>Field Strength (dBm/MHz) (Emissions outside the restricted bands)</b>
Above 960	500	54.00 (Average) 74.00 (Peak)	< -20 dBc

## Radiated Emissions Sample Calculations

$$\text{Corrected Meter Reading} = \text{Meter Reading} + F + C - D$$

Where, F = Antenna Factor

C = Cable Factor

G = Amplifier Gain

D = Distance Factor (if applicable)

Therefore, the equation for determining the Corrected Meter Reading Limit (CML) is:

$$\text{CML} = \text{Specification Limit} - F - C + D$$



Radiated Emissions Test Results (Continued)

*Fundamental Measurements in 802.11n mode 40MHz Wide (5150-5350 MHz)  
 Channels 38, 46, 54, & 62  
 Continuous TX at Chain A Antenna port with Shanghai Universe Antennas  
 Aegis Labs, Inc. File #: INTEL-090601-02*

<b>RADIATED EMISSIONS - Horizontal Antenna Polarization</b>											
<i>Freq. (MHz)</i>	<i>Meter Reading (dBuV)</i>	<i>Antenna Height (cm)</i>	<i>Azimuth (degrees)</i>	<i>Quasi pk or AVG (dBuV)</i>		<i>Cable Factor (dB)</i>	<i>Ant. Factor (dB)</i>	<i>Corrected Reading (dBuV)</i>	<i>Limits (dBuV)</i>	<i>Diff (dB) +=FAIL</i>	<i>Comments</i>
5190.00	59.11	100	45			3.78	34.29	97.18			<b>Ch. 38</b>
5190.00				49.59	A	3.78	34.29	87.66			
5230.00	60.54	100	0			3.79	34.33	98.66			<b>Ch. 46</b>
5230.00				50.76	A	3.79	34.33	88.88			
5270.00	61.20	100	0			3.81	34.37	99.38			<b>Ch. 54</b>
5270.00				51.84	A	3.81	34.37	90.02			
5310.00	60.79	100	45			3.82	34.41	99.02			<b>Ch. 62</b>
5310.00				51.16	A	3.82	34.41	89.39			

<b>RADIATED EMISSIONS - Vertical Antenna Polarization</b>											
<i>Freq. (MHz)</i>	<i>Meter Reading (dBuV)</i>	<i>Antenna Height (cm)</i>	<i>Azimuth (degrees)</i>	<i>Quasi pk or AVG (dBuV)</i>		<i>Cable Factor (dB)</i>	<i>Ant. Factor (dB)</i>	<i>Corrected Reading (dBuV)</i>	<i>Limits (dBuV)</i>	<i>Diff (dB) +=FAIL</i>	<i>Comments</i>
5190.00	60.08	100	315			3.78	34.49	98.35			<b>Ch. 38</b>
5190.00				49.41	A	3.78	34.49	87.68			
5230.00	61.57	100	315			3.79	34.53	99.89			<b>Ch. 46</b>
5230.00				51.63	A	3.79	34.53	89.95			
5270.00	62.69	100	45			3.81	34.57	101.07			<b>Ch. 54</b>
5270.00				52.49	A	3.81	34.57	90.87			
5310.00	61.24	100	45			3.82	34.61	99.67			<b>Ch. 62</b>
5310.00				50.96	A	3.82	34.61	89.39			

NOTE: Fundamental signals measured to calculate the band edge field strengths using the “Marker Delta Method”.



Radiated Emissions Test Results (Continued)

**Band Edge Field Strength Measurements in 802.11n mode 40MHz Wide (5150-5350 MHz)**  
**Channels 38 & 62**  
**Continuous TX at Chain A Antenna port with Shanghai Universe Antennas**  
**Aegis Labs, Inc. File #: INTEL-090601-02**

<b>RADIATED EMISSIONS - Horizontal Antenna Polarization</b>										
Freq. (MHz)	Meter Reading (dBuV)	Antenna Height (cm)	Azimuth (degrees)	Quasi pk or AVG (dBuV)	Cable Factor (dB)	Ant. Factor (dB)	Corrected Reading (dBuV)	Limits (dBuV)	Diff (dB) +=FAIL	Comments
5150.00							63.02	74.00	-10.98	<b>Ch. 38</b>
5150.00							58.35	74.00	-15.65	
5150.00					A		50.83	54.00	-3.17	
5150.00					A		48.83	54.00	-5.17	
5350.00							63.02	74.00	-10.98	<b>Ch. 62</b>
5350.00							60.02	74.00	-13.98	
5350.00					A		50.56	54.00	-3.44	
5350.00					A		50.39	54.00	-3.61	

<b>RADIATED EMISSIONS - Vertical Antenna Polarization</b>										
Freq. (MHz)	Meter Reading (dBuV)	Antenna Height (cm)	Azimuth (degrees)	Quasi pk or AVG (dBuV)	Cable Factor (dB)	Ant. Factor (dB)	Corrected Reading (dBuV)	Limits (dBuV)	Diff (dB) +=FAIL	Comments
5150.00							64.19	74.00	-9.81	<b>Ch. 38</b>
5150.00							59.52	74.00	-14.48	
5150.00					A		50.85	54.00	-3.15	
5150.00					A		48.85	54.00	-5.15	
5350.00							63.67	74.00	-10.33	<b>Ch. 62</b>
5350.00							60.67	74.00	-13.33	
5350.00					A		50.56	54.00	-3.44	
5350.00					A		50.39	54.00	-3.61	

NOTE: The “Band Edge Field Strength” was calculated using the “Fundamental” and “Conducted Band Edge” measurements per the “Marker-Delta Method” with the following formula:

$$BE = F_m - \Delta m$$

Where

BE = Band Edge Field Strength

F<sub>m</sub> = Measured Fundamental (Peak or Average)

Δ<sub>m</sub> = Measured Conducted Band Edge Delta (Peak or Average)



Band-Edge Plots (Continued)

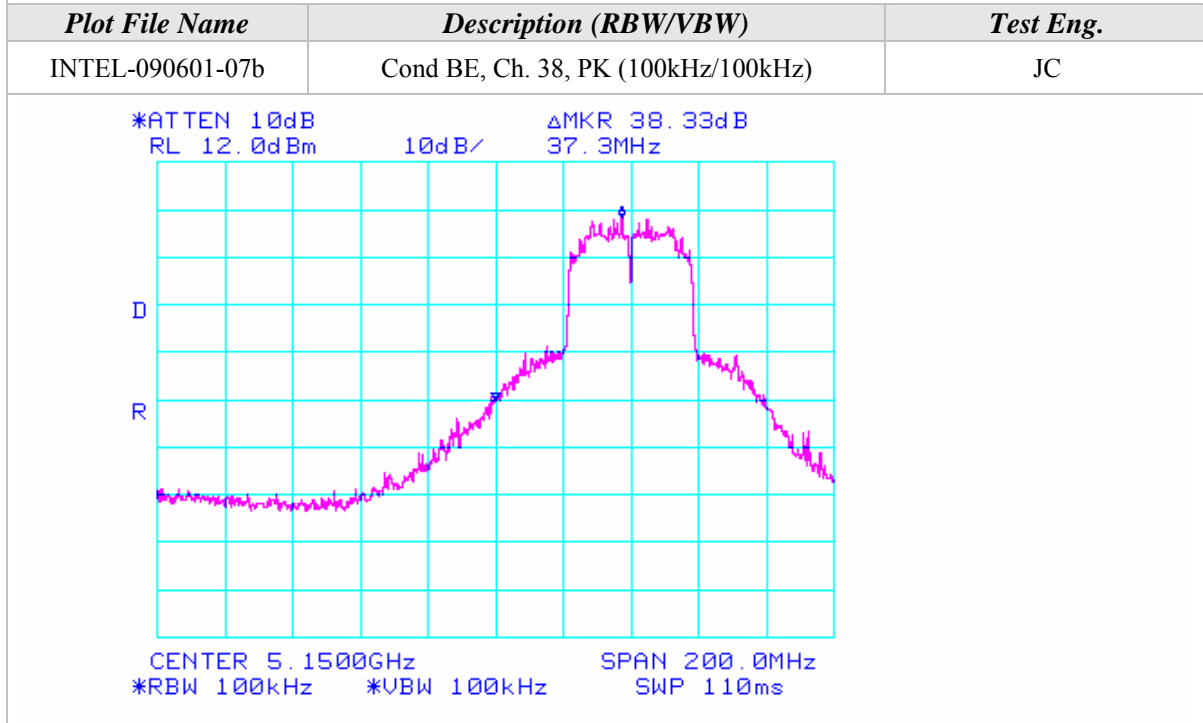
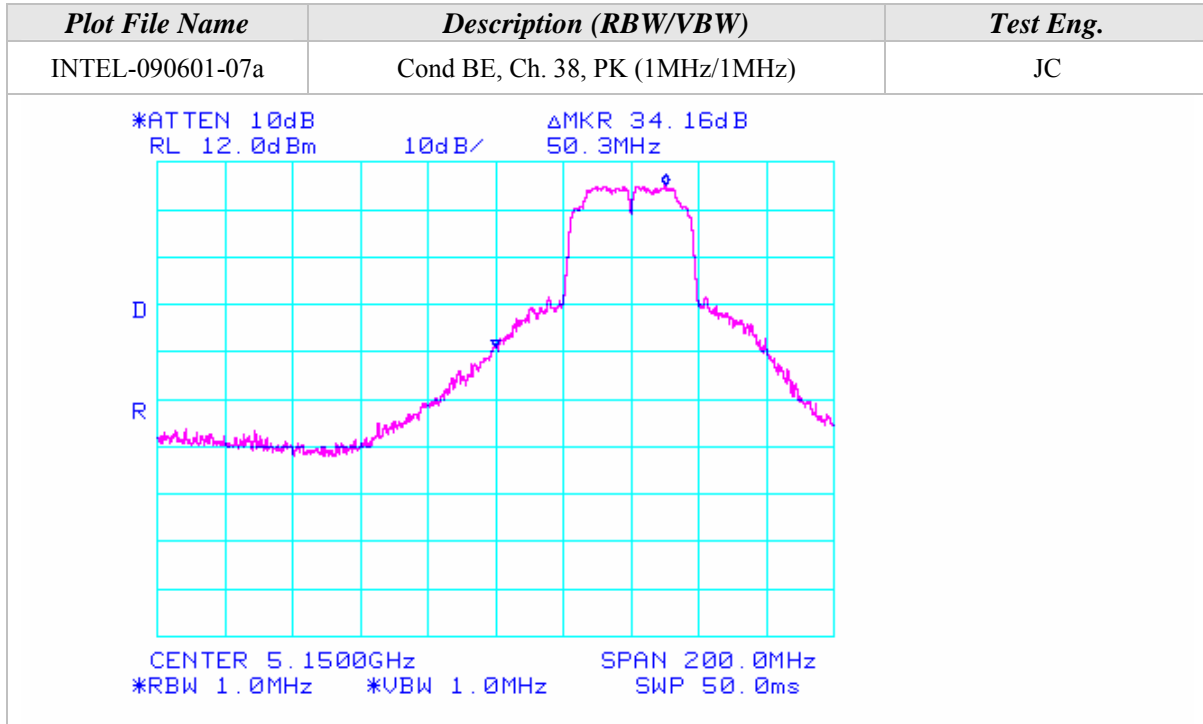

Band-Edge Plots (Continued)

Plot File Name	Description (RBW/VBW)	Test Eng.
INTEL-090601-07c	Cond BE, Ch. 38, AV (1MHz/10Hz)	JC
<p>*ATTEN 10dB                      ΔMKR 36.83dB RL 12.0dBm                      10dB/                      28.7MHz</p> <p>CENTER 5.1500GHz                      SPAN 200.0MHz *RBW 1.0MHz                      *VBW 10Hz                      SWP 74.0sec</p>		
Plot File Name	Description (RBW/VBW)	Test Eng.
INTEL-090601-07d	Cond BE, Ch. 62, PK (1MHz/1MHz)	JC
<p>*ATTEN 10dB                      ΔMKR 36.00dB RL 12.0dBm                      10dB/                      -30.0MHz</p> <p>CENTER 5.3500GHz                      SPAN 200.0MHz *RBW 1.0MHz                      *VBW 1.0MHz                      SWP 50.0ms</p>		





## Band-Edge Plots (Continued)

<b>Plot File Name</b>	<b>Description (RBW/VBW)</b>	<b>Test Eng.</b>
INTEL-090601-07e	Cond BE, Ch. 62, PK (100kHz/100kHz)	JC
<p>*ATTEN 10dB      ΔMKR 39.00dB RL 12.0dBm      10dB/      -35.7MHz</p> <p>CENTER 5.3500GHz      SPAN 200.0MHz *RBW 100kHz      *VBW 100kHz      SWP 110ms</p>		
<b>Plot File Name</b>	<b>Description (RBW/VBW)</b>	<b>Test Eng.</b>
INTEL-090601-07f	Cond BE, Ch. 62, AV (1MHz/10Hz)	JC
<p>*ATTEN 10dB      ΔMKR 38.83dB RL 12.0dBm      10dB/      -51.3MHz</p> <p>CENTER 5.3500GHz      SPAN 200.0MHz *RBW 1.0MHz      *VBW 10Hz      SWP 74.0sec</p>		



Radiated Emissions Test Results (Continued)

*Fundamental Measurements in 802.11n mode 40MHz Wide (5150-5350 MHz)  
Channels 38, 46, 54, & 62  
Continuous TX at Chain B Antenna port with Shanghai Universe Antennas  
Aegis Labs, Inc. File #: INTEL-090601-04*

<b>RADIATED EMISSIONS - Horizontal Antenna Polarization</b>											
<i>Freq. (MHz)</i>	<i>Meter Reading (dBuV)</i>	<i>Antenna Height (cm)</i>	<i>Azimuth (degrees)</i>	<i>Quasi pk or AVG (dBuV)</i>		<i>Cable Factor (dB)</i>	<i>Ant. Factor (dB)</i>	<i>Corrected Reading (dBuV)</i>	<i>Limits (dBuV)</i>	<i>Diff (dB) +=FAIL</i>	<i>Comments</i>
5190.00	59.33	100	180			3.78	34.29	97.40			<b>Ch. 38</b>
5190.00				48.76	A	3.78	34.29	86.83			
5230.00	60.67	100	180			3.79	34.33	98.79			<b>Ch. 46</b>
5230.00				50.49	A	3.79	34.33	88.61			
5270.00	62.00	100	315			3.81	34.37	100.18			<b>Ch. 54</b>
5270.00				52.85	A	3.81	34.37	91.03			
5310.00	61.00	100	315			3.82	34.41	99.23			<b>Ch. 62</b>
5310.00				51.02	A	3.82	34.41	89.25			

<b>RADIATED EMISSIONS - Vertical Antenna Polarization</b>											
<i>Freq. (MHz)</i>	<i>Meter Reading (dBuV)</i>	<i>Antenna Height (cm)</i>	<i>Azimuth (degrees)</i>	<i>Quasi pk or AVG (dBuV)</i>		<i>Cable Factor (dB)</i>	<i>Ant. Factor (dB)</i>	<i>Corrected Reading (dBuV)</i>	<i>Limits (dBuV)</i>	<i>Diff (dB) +=FAIL</i>	<i>Comments</i>
5190.00	59.50	100	90			3.78	34.49	97.77			<b>Ch. 38</b>
5190.00				48.67	A	3.78	34.49	86.94			
5230.00	61.00	100	90			3.79	34.53	99.32			<b>Ch. 46</b>
5230.00				50.33	A	3.79	34.53	88.65			
5270.00	62.17	100	45			3.81	34.57	100.55			<b>Ch. 54</b>
5270.00				51.67	A	3.81	34.57	90.05			
5310.00	61.17	100	45			3.82	34.61	99.60			<b>Ch. 62</b>
5310.00				50.50	A	3.82	34.61	88.93			

NOTE: Fundamental signals measured to calculate the band edge field strengths using the “Marker Delta Method”.



Radiated Emissions Test Results (Continued)

*Band Edge Field Strength Measurements in 802.11n mode 40MHz Wide (5150-5350 MHz)  
Channels 38 & 62  
Continuous TX at Chain B Antenna port with Shanghai Universe Antennas  
Aegis Labs, Inc. File #: INTEL-090601-04*

**RADIATED EMISSIONS - Horizontal Antenna Polarization**

Freq. (MHz)	Meter Reading (dBuV)	Antenna Height (cm)	Azimuth (degrees)	Quasi pk or AVG (dBuV)	Cable Factor (dB)	Ant. Factor (dB)	Corrected Reading (dBuV)	Limits (dBuV)	Diff (dB) +=FAIL	Comments
5150.00							63.90	74.00	-10.10	<b>Ch. 38</b>
5150.00							60.24	74.00	-13.76	
5150.00				A			50.83	54.00	-3.17	
5150.00				A			49.67	54.00	-4.33	
5350.00							63.23	74.00	-10.77	<b>Ch. 62</b>
5350.00							59.90	74.00	-14.10	
5350.00				A			50.91	54.00	-3.09	
5350.00				A			49.92	54.00	-4.08	

**RADIATED EMISSIONS - Vertical Antenna Polarization**

Freq. (MHz)	Meter Reading (dBuV)	Antenna Height (cm)	Azimuth (degrees)	Quasi pk or AVG (dBuV)	Cable Factor (dB)	Ant. Factor (dB)	Corrected Reading (dBuV)	Limits (dBuV)	Diff (dB) +=FAIL	Comments
5150.00							64.27	74.00	-9.73	<b>Ch. 38</b>
5150.00							60.61	74.00	-13.39	
5150.00				A			50.94	54.00	-3.06	
5150.00				A			49.78	54.00	-4.22	
5350.00							63.60	74.00	-10.40	<b>Ch. 62</b>
5350.00							60.27	74.00	-13.73	
5350.00				A			50.59	54.00	-3.41	
5350.00				A			49.60	54.00	-4.40	

NOTE: The “Band Edge Field Strength” was calculated using the “Fundamental” and “Conducted Band Edge” measurements per the “Marker-Delta Method” with the following formula:

$$BE = Fm - \Delta m$$

Where

BE = Band Edge Field Strength

Fm = Measured Fundamental (Peak or Average)

Δm = Measured Conducted Band Edge Delta (Peak or Average)

### Band-Edge Plots (Continued)

<i>Plot File Name</i>	<i>Description (RBW/VBW)</i>	<i>Test Eng.</i>
INTEL-090526-14a	Cond BE, Ch. 38, PK (1MHz/1MHz)	JC
<p>*ATTEN 10dB RL 12.0dBm      10dB/      ΔMKR 33.50dB 50.3MHz</p> <p>CENTER 5.1500GHz      SPAN 200.0MHz *RBW 1.0MHz      *VBW 1.0MHz      SWP 50.0ms</p>		
<i>Plot File Name</i>	<i>Description (RBW/VBW)</i>	<i>Test Eng.</i>
INTEL-090526-14b	Cond BE, Ch. 38, PK (100kHz/100kHz)	JC
<p>*ATTEN 10dB RL 12.0dBm      10dB/      ΔMKR 37.16dB 37.3MHz</p> <p>CENTER 5.1500GHz      SPAN 200.0MHz *RBW 100kHz      *VBW 100kHz      SWP 110ms</p>		



Band-Edge Plots (Continued)

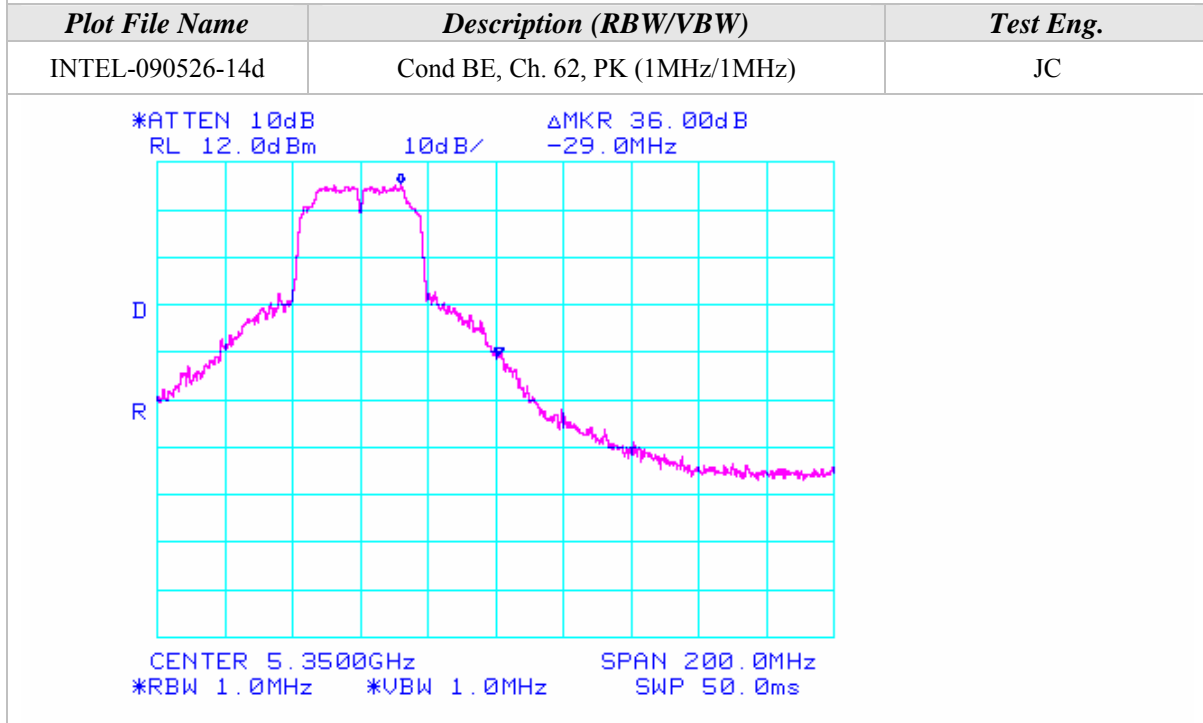
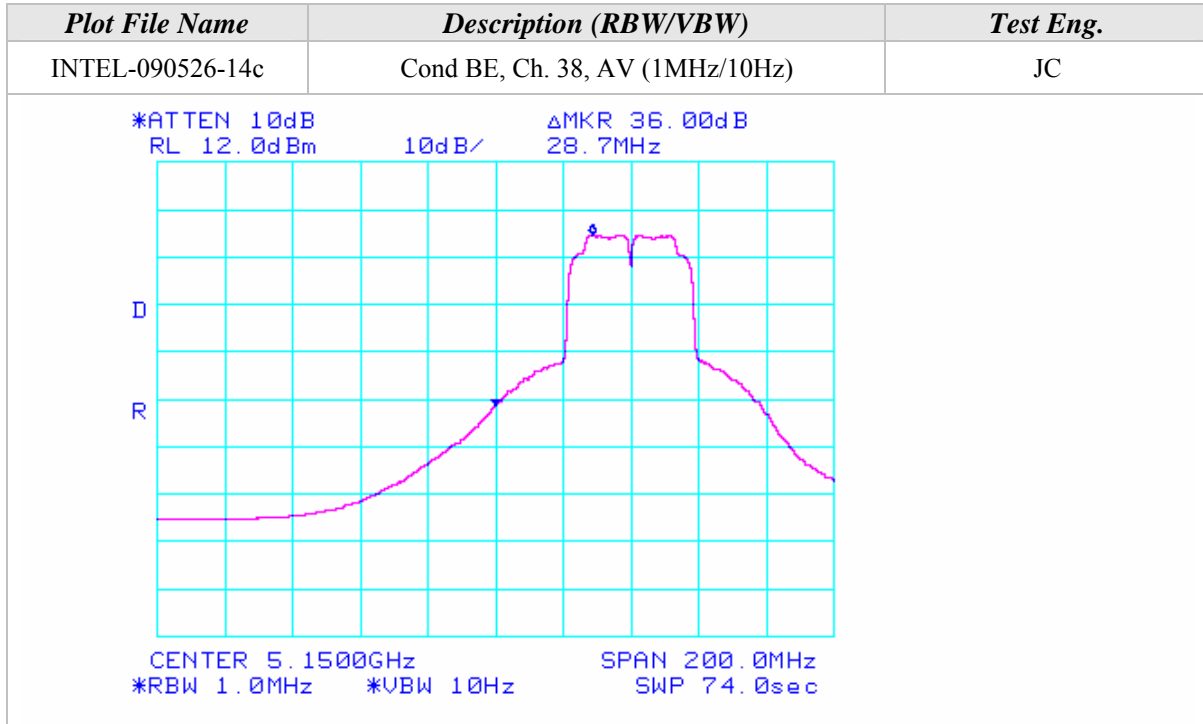

## Band-Edge Plots (Continued)

<i>Plot File Name</i>	<i>Description (RBW/VBW)</i>	<i>Test Eng.</i>
INTEL-090526-14e	Cond BE, Ch. 62, PK (100kHz/100kHz)	JC
<p>*ATTEN 10dB RL 12.0dBm 10dB/ ΔMKR 39.33dB -43.3MHz</p> <p>CENTER 5.3500GHz SPAN 200.0MHz *RBW 100kHz *VBW 100kHz SWP 110ms</p>		
<i>Plot File Name</i>	<i>Description (RBW/VBW)</i>	<i>Test Eng.</i>
INTEL-090526-14f	Cond BE, Ch. 62, AV (1MHz/10Hz)	JC
<p>*ATTEN 10dB RL 12.0dBm 10dB/ ΔMKR 38.34dB -51.0MHz</p> <p>CENTER 5.3500GHz SPAN 200.0MHz *RBW 1.0MHz *VBW 10Hz SWP 74.0sec</p>		



## RADIATED EMISSIONS TEST RESULTS

<b>CLIENT:</b>	Intel Corporation	<b>DATE:</b>	08/17/09
<b>EUT:</b>	Intel® Centrino® Ultimate-N 6200	<b>PROJECT NUMBER:</b>	INTEL-090601
<b>MODEL NUMBER:</b>	622ANHMW	<b>TEST ENGINEER:</b>	JC
<b>SERIAL NUMBER:</b>	0015005A3C7C	<b>SITE #:</b>	2
<b>CONFIGURATION:</b>	Tested installed in an extender board connected to the host laptop's mini PCI slot in <b>802.11a (5470-5725 MHz) mode.</b>	<b>TEMPERATURE:</b>	24° C
		<b>HUMIDITY:</b>	46% RH
		<b>TIME:</b>	9:30 AM

<b>Description:</b>	Radiated RF Emissions (1 GHz – 18 GHz)
<b>Results:</b>	<b>PASSED</b> Horizontal and Vertical Antenna Polarizations Class B Limits
<b>Note:</b>	Radiated Emissions Measurements were performed on the EUT with power supply set at the following voltage and frequency. <ul style="list-style-type: none"> <li>• 120VAC / 60 Hz.</li> </ul>

Unwanted Spurious Emissions Limits			
Frequency (MHz)	Field Strength (uV/m)	Field Strength (dBuV/m) (Emissions in the restricted bands)	Field Strength (dBm/MHz) (Emissions outside the restricted bands)
Above 960	500	54.00 (Average) 74.00 (Peak)	< -20 dBc

### Radiated Emissions Sample Calculations

$$\text{Corrected Meter Reading} = \text{Meter Reading} + F + C - D$$

Where, F = Antenna Factor

C = Cable Factor

G = Amplifier Gain

D = Distance Factor (if applicable)

Therefore, the equation for determining the Corrected Meter Reading Limit (CML) is:

$$\text{CML} = \text{Specification Limit} - F - C + D$$

Radiated Emissions Test Results (Continued)

*Fundamental Measurements in 802.11a mode (5470-5725 MHz)  
Channels 100, 120, & 140  
Continuous TX at Chain A Antenna port with Shanghai Universe Antennas  
Aegis Labs, Inc. File #: INTEL-090601-02*

<b>RADIATED EMISSIONS - Horizontal Antenna Polarization</b>											
Freq. (MHz)	Meter Reading (dBuV)	Antenna Height (cm)	Azimuth (degrees)	Quasi pk or AVG (dBuV)		Cable Factor (dB)	Ant. Factor (dB)	Corrected Reading (dBuV)	Limits (dBuV)	Diff (dB) +=FAIL	Comments
5500.00	60.90	100	45			3.89	34.60	99.39			<b>Ch. 100</b>
5500.00				54.07	A	3.89	34.60	92.56			
5600.00	61.45	100	45			3.93	34.72	100.10			<b>Ch. 120</b>
5600.00				54.60	A	3.93	34.72	93.25			
5700.00	58.84	100	45			3.97	34.84	97.65			<b>Ch. 140</b>
5700.00				52.07	A	3.97	34.84	90.88			

<b>RADIATED EMISSIONS - Vertical Antenna Polarization</b>											
Freq. (MHz)	Meter Reading (dBuV)	Antenna Height (cm)	Azimuth (degrees)	Quasi pk or AVG (dBuV)		Cable Factor (dB)	Ant. Factor (dB)	Corrected Reading (dBuV)	Limits (dBuV)	Diff (dB) +=FAIL	Comments
5500.00	65.96	100	315			3.89	34.80	104.65			<b>Ch. 100</b>
5500.00				56.41	A	3.89	34.80	95.10			
5600.00	66.42	100	315			3.93	34.90	105.25			<b>Ch. 120</b>
5600.00				56.89	A	3.93	34.90	95.72			
5700.00	65.39	100	315			3.97	35.00	104.36			<b>Ch. 140</b>
5700.00				55.80	A	3.97	35.00	94.77			

NOTE: Fundamental signals measured to calculate the band edge field strengths using the “Marker Delta Method”.





Radiated Emissions Test Results (Continued)

*Band Edge Field Strength Measurements in 802.11a mode (5470-5725 MHz)  
Channels 100 & 140  
Continuous TX at Chain A Antenna port with Shanghai Universe Antennas  
Aegis Labs, Inc. File #: INTEL-090601-02*

RADIATED EMISSIONS - Horizontal Antenna Polarization										
Freq. (MHz)	Meter Reading (dBuV)	Antenna Height (cm)	Azimuth (degrees)	Quasi pk or AVG (dBuV)	Cable Factor (dB)	Ant. Factor (dB)	Corrected Reading (dBuV)	Limits (dBuV)	Diff (dB) +=FAIL	Comments
5460.00							46.73	74.00	-27.27	<b>Ch. 100</b>
5460.00							41.89	74.00	-32.11	
5460.00					A		34.06	54.00	-19.94	
5460.00					A		35.06	54.00	-18.94	
5725.00	27.33	100	45		3.98	34.87	66.18	77.65	-11.47	<b>Ch. 140</b>

RADIATED EMISSIONS - Vertical Antenna Polarization										
Freq. (MHz)	Meter Reading (dBuV)	Antenna Height (cm)	Azimuth (degrees)	Quasi pk or AVG (dBuV)	Cable Factor (dB)	Ant. Factor (dB)	Corrected Reading (dBuV)	Limits (dBuV)	Diff (dB) +=FAIL	Comments
5460.00							51.99	74.00	-22.01	<b>Ch. 100</b>
5460.00							47.15	74.00	-26.85	
5460.00					A		36.60	54.00	-17.40	
5460.00					A		37.60	54.00	-16.40	
5725.00	30.28	100	315		3.98	35.03	69.28	84.36	-15.08	<b>Ch. 140</b>

NOTE: The “Band Edge Field Strength” was calculated using the “Fundamental” and “Conducted Band Edge” measurements per the “Marker-Delta Method” with the following formula:

$$BE = Fm - \Delta m$$

Where

BE = Band Edge Field Strength

Fm = Measured Fundamental (Peak or Average)

Δm = Measured Conducted Band Edge Delta (Peak or Average)



Band-Edge Plots (Continued)

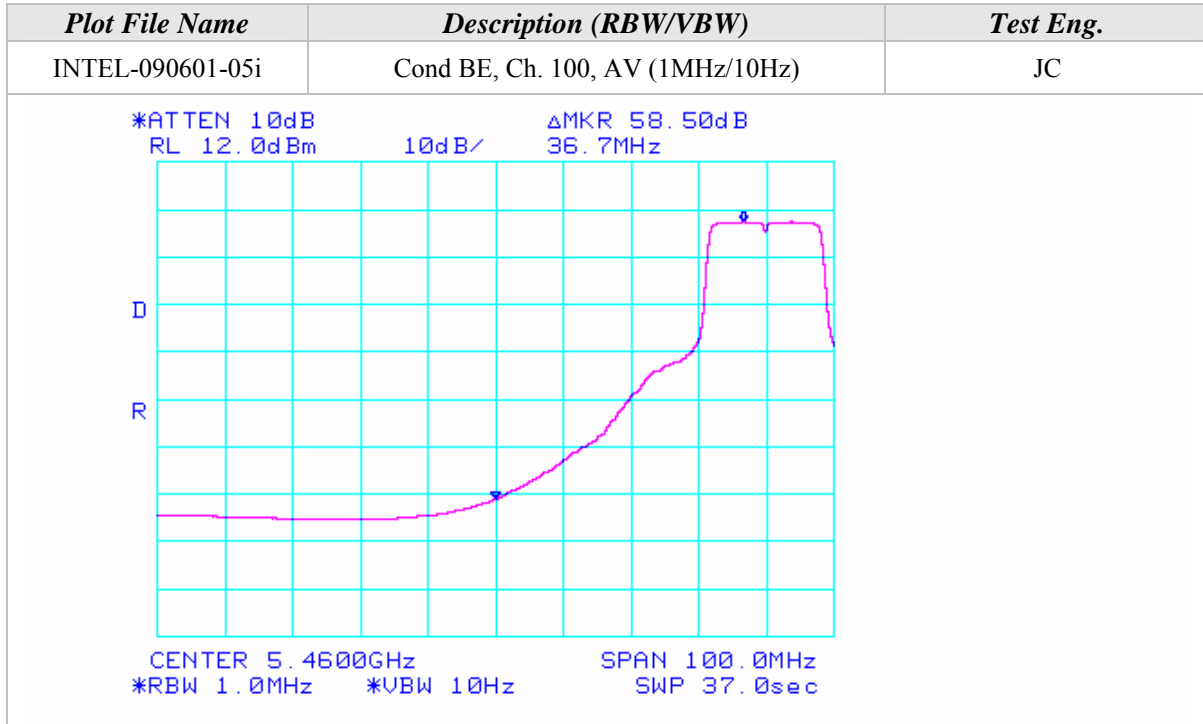



Radiated Emissions Test Results (Continued)

*Fundamental Measurements in 802.11a mode (5470-5725 MHz)  
Channels 100, 120, & 140  
Continuous TX at Chain B Antenna port with Shanghai Universe Antennas  
Aegis Labs, Inc. File #: INTEL-090601-04*

<b>RADIATED EMISSIONS - Horizontal Antenna Polarization</b>											
Freq. (MHz)	Meter Reading (dBuV)	Antenna Height (cm)	Azimuth (degrees)	Quasi pk or AVG (dBuV)		Cable Factor (dB)	Ant. Factor (dB)	Corrected Reading (dBuV)	Limits (dBuV)	Diff (dB) +=FAIL	Comments
5500.00	65.17	100	0			3.89	34.60	103.66			<b>Ch. 100</b>
5500.00				56.33	A	3.89	34.60	94.82			
5600.00	65.50	100	315			3.93	34.72	104.15			<b>Ch. 120</b>
5600.00				55.33	A	3.93	34.72	93.98			
5700.00	64.67	100	315			3.97	34.84	103.48			<b>Ch. 140</b>
5700.00				55.00	A	3.97	34.84	93.81			

<b>RADIATED EMISSIONS - Vertical Antenna Polarization</b>											
Freq. (MHz)	Meter Reading (dBuV)	Antenna Height (cm)	Azimuth (degrees)	Quasi pk or AVG (dBuV)		Cable Factor (dB)	Ant. Factor (dB)	Corrected Reading (dBuV)	Limits (dBuV)	Diff (dB) +=FAIL	Comments
5500.00	66.17	100	315			3.89	34.80	104.86			<b>Ch. 100</b>
5500.00				56.00	A	3.89	34.80	94.69			
5600.00	66.67	100	0			3.93	34.90	105.50			<b>Ch. 120</b>
5600.00				56.67	A	3.93	34.90	95.50			
5700.00	65.33	100	315			3.97	35.00	104.30			<b>Ch. 140</b>
5700.00				55.17	A	3.97	35.00	94.14			

NOTE: Fundamental signals measured to calculate the band edge field strengths using the “Marker Delta Method”.



Radiated Emissions Test Results (Continued)

*Band Edge Field Strength Measurements in 802.11a mode (5470-5725 MHz)  
Channels 100 & 140  
Continuous TX at Chain B Antenna port with Shanghai Universe Antennas  
Aegis Labs, Inc. File #: INTEL-090601-04*

RADIATED EMISSIONS - Horizontal Antenna Polarization										
Freq. (MHz)	Meter Reading (dBuV)	Antenna Height (cm)	Azimuth (degrees)	Quasi pk or AVG (dBuV)	Cable Factor (dB)	Ant. Factor (dB)	Corrected Reading (dBuV)	Limits (dBuV)	Diff (dB) +=FAIL	Comments
5460.00							55.83	74.00	-18.17	<b>Ch. 100</b>
5460.00							50.16	74.00	-23.84	
5460.00					A		39.82	54.00	-14.18	
5460.00					A		41.32	54.00	-12.68	
5725.00	31.33	100	315		3.98	34.87	70.18	83.48	-13.30	<b>Ch. 140</b>

RADIATED EMISSIONS - Vertical Antenna Polarization										
Freq. (MHz)	Meter Reading (dBuV)	Antenna Height (cm)	Azimuth (degrees)	Quasi pk or AVG (dBuV)	Cable Factor (dB)	Ant. Factor (dB)	Corrected Reading (dBuV)	Limits (dBuV)	Diff (dB) +=FAIL	Comments
5460.00							57.03	74.00	-16.97	<b>Ch. 100</b>
5460.00							51.36	74.00	-22.64	
5460.00					A		39.69	54.00	-14.31	
5460.00					A		41.19	54.00	-12.81	
5725.00	31.33	100	315		3.98	35.03	70.33	84.30	-13.97	<b>Ch. 140</b>

NOTE: The “Band Edge Field Strength” was calculated using the “Fundamental” and “Conducted Band Edge” measurements per the “Marker-Delta Method” with the following formula:

$$BE = F_m - \Delta_m$$

Where

BE = Band Edge Field Strength

F<sub>m</sub> = Measured Fundamental (Peak or Average)

Δ<sub>m</sub> = Measured Conducted Band Edge Delta (Peak or Average)



Band-Edge Plots (Continued)

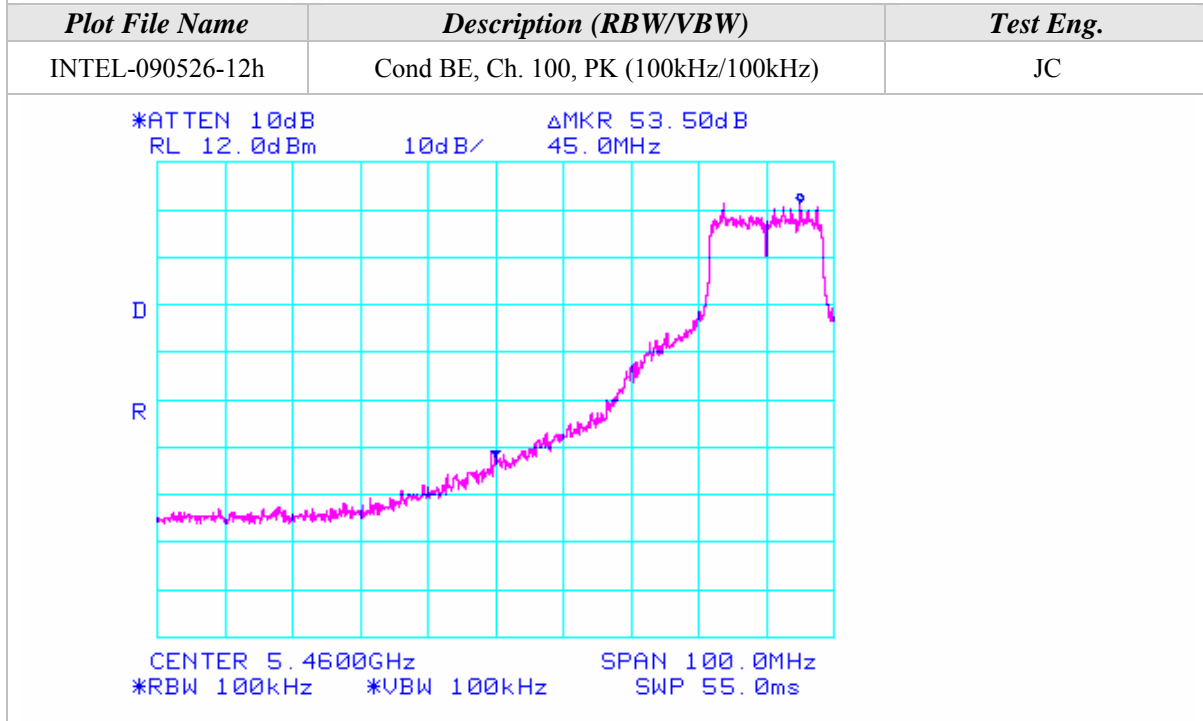
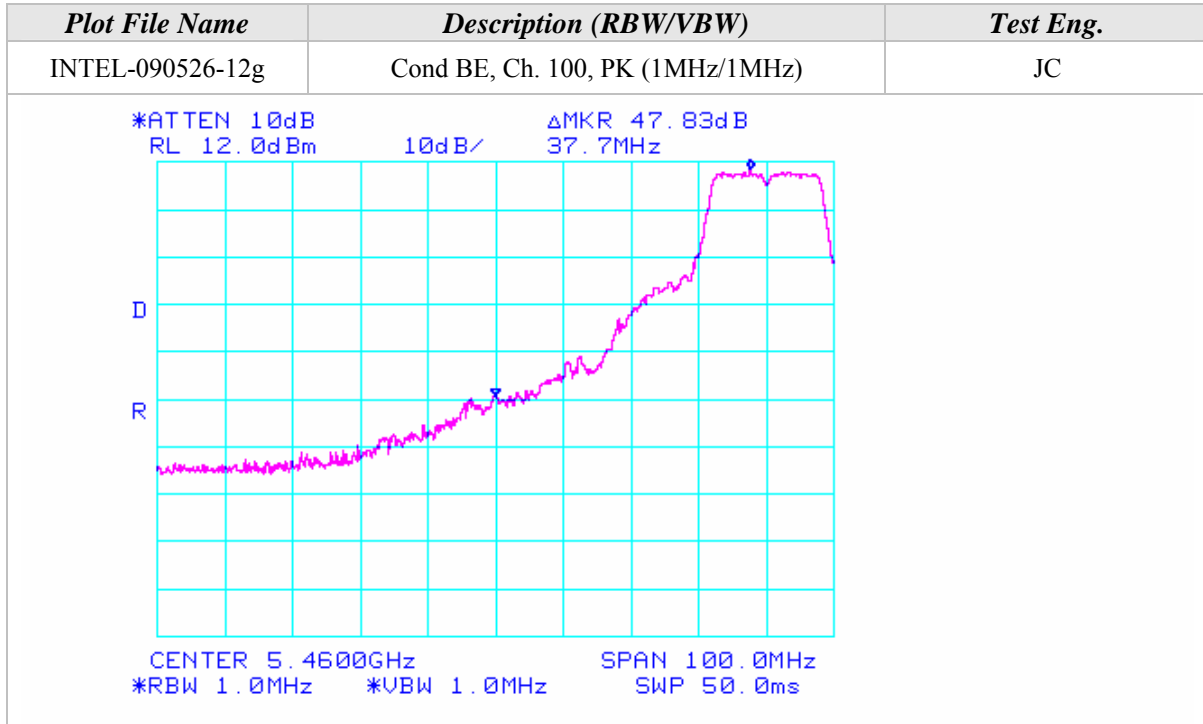

## Band-Edge Plots (Continued)

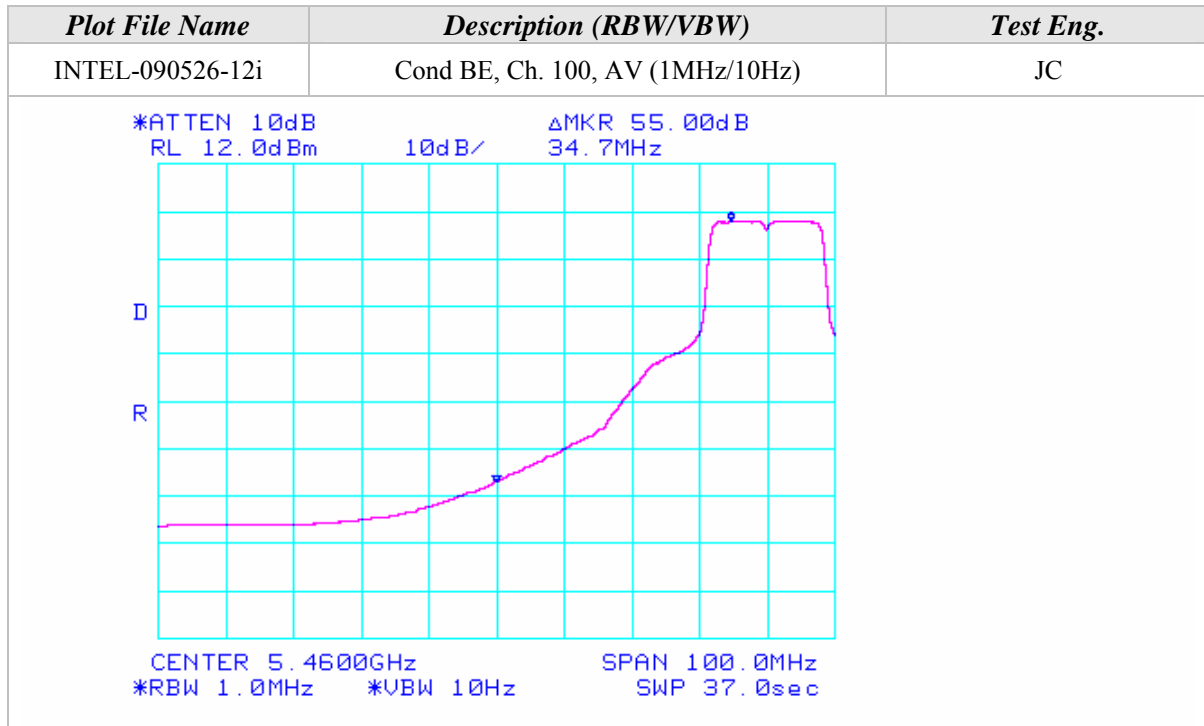



Radiated Emissions Test Results (Continued)

*Spurious Emissions Measurements in 802.11a mode (5470-5725 MHz)  
Channels 100, 120, & 140  
Continuous TX at Chain A & B Antenna ports with Shanghai Universe Antennas  
Aegis Labs, Inc. File #: INTEL-090601-06*

**RADIATED EMISSIONS - Horizontal Antenna Polarization**

Freq. (MHz)	Meter Reading (dBuV)	Antenna Height (cm)	Azimuth (degrees)	Quasi pk or AVG (dBuV)		Preamp Factor (dB)	Cable Factor (dB)	Ant. Factor (dB)	Corrected Reading (dBuV)	Limits (dBuV)	Diff (dB) +/-FAIL	Channel/Chain Tested
3733.33	53.17	100	0			47.55	3.19	33.08	41.89	74.00	-32.11	Ch. 120/A
3733.33	53.67	100	0			47.55	3.19	33.08	42.39	74.00	-31.61	Ch. 120/B
3666.66	53.17	100	315			47.58	3.17	33.00	41.76	54.00	-12.24	Ch. 100/B
3800.00	53.50	100	270			47.54	3.24	33.16	42.36	74.00	-31.64	Ch. 140/
7600.00	51.67	100	315			45.60	4.64	35.76	46.46	74.00	-27.54	B
7600.00		100	315	40.62	A	45.60	4.64	35.76	35.41	54.00	-18.59	

**RADIATED EMISSIONS - Vertical Antenna Polarization**

Freq. (MHz)	Meter Reading (dBuV)	Antenna Height (cm)	Azimuth (degrees)	Quasi pk or AVG (dBuV)		Preamp Factor (dB)	Cable Factor (dB)	Ant. Factor (dB)	Corrected Reading (dBuV)	Limits (dBuV)	Diff (dB) +/-FAIL	Comments
3733.33	53.33	100	0			47.55	3.19	32.97	41.94	74.00	-32.06	Ch. 120/
7466.66	51.67	100	0			45.68	4.60	35.69	46.28	74.00	-27.72	A
7466.66		100	0	38.78	A	45.68	4.60	35.69	33.39	54.00	-20.61	
3733.33	53.33	100	0			47.55	3.19	32.97	41.94	74.00	-32.06	Ch. 120/
7466.66	52.17	100	315			45.68	4.60	35.69	46.78	74.00	-27.22	B
7466.66		100	315	39.05	A	45.68	4.60	35.69	33.66	54.00	-20.34	
3666.66	53.17	100	0			47.58	3.17	32.87	41.63	74.00	-32.37	Ch. 100/
7333.33	51.17	100	0			45.81	4.55	35.67	45.57	74.00	-28.43	B
7333.33		100	0	38.70	A	45.81	4.55	35.67	33.10	54.00	-20.90	
3800.00	53.67	100	0			47.54	3.24	33.08	42.45	74.00	-31.55	Ch. 140/B



**RADIATED EMISSIONS TEST RESULTS**

<b>CLIENT:</b>	Intel Corporation	<b>DATE:</b>	08/17/09
<b>EUT:</b>	Intel® Centrino® Ultimate-N 6200	<b>PROJECT NUMBER:</b>	INTEL-090601
<b>MODEL NUMBER:</b>	622ANHMW	<b>TEST ENGINEER:</b>	JC
<b>SERIAL NUMBER:</b>	0015005A3C7C	<b>SITE #:</b>	2
<b>CONFIGURATION:</b>	Tested installed in an extender board connected to the host laptop's mini PCI slot in <b>802.11n (5740-5745 MHz) mode 20MHz Wide.</b>	<b>TEMPERATURE:</b>	24° C
		<b>HUMIDITY:</b>	46% RH
		<b>TIME:</b>	9:30 AM

<b>Description:</b>	Radiated RF Emissions (1 GHz – 18 GHz)
<b>Results:</b>	<b>PASSED</b> Horizontal and Vertical Antenna Polarizations Class B Limits
<b>Note:</b>	Radiated Emissions Measurements were performed on the EUT with power supply set at the following voltage and frequency. <ul style="list-style-type: none"> <li>• 120VAC / 60 Hz.</li> </ul>

<b>Unwanted Spurious Emissions Limits</b>			
<b>Frequency (MHz)</b>	<b>Field Strength (uV/m)</b>	<b>Field Strength (dBuV/m) (Emissions in the restricted bands)</b>	<b>Field Strength (dBm/MHz) (Emissions outside the restricted bands)</b>
Above 960	500	54.00 (Average) 74.00 (Peak)	< -20 dBc

## Radiated Emissions Sample Calculations

$$\text{Corrected Meter Reading} = \text{Meter Reading} + F + C - D$$

Where, F = Antenna Factor

C = Cable Factor

G = Amplifier Gain

D = Distance Factor (if applicable)

Therefore, the equation for determining the Corrected Meter Reading Limit (CML) is:

$$\text{CML} = \text{Specification Limit} - F - C + D$$



Radiated Emissions Test Results (Continued)

*Fundamental Measurements in 802.11n mode 20MHz Wide (5470-5725 MHz)  
Channels 100, 120, & 140  
Continuous TX at Chain A Antenna port with Shanghai Universe Antennas  
Aegis Labs, Inc. File #: INTEL-090601-02*

<b>RADIATED EMISSIONS - Horizontal Antenna Polarization</b>											
Freq. (MHz)	Meter Reading (dBuV)	Antenna Height (cm)	Azimuth (degrees)	Quasi pk or AVG (dBuV)		Cable Factor (dB)	Ant. Factor (dB)	Corrected Reading (dBuV)	Limits (dBuV)	Diff (dB) +=FAIL	Comments
5500.00	62.43	100	45			3.89	34.60	100.92			<b>Ch. 100</b>
5500.00				53.95	A	3.89	34.60	92.44			
5600.00	63.28	100	45			3.93	34.72	101.93			<b>Ch. 120</b>
5600.00				54.84	A	3.93	34.72	93.49			
5700.00	62.50	100	45			3.97	34.84	101.31			<b>Ch. 140</b>
5700.00				53.91	A	3.97	34.84	92.72			

<b>RADIATED EMISSIONS - Vertical Antenna Polarization</b>											
Freq. (MHz)	Meter Reading (dBuV)	Antenna Height (cm)	Azimuth (degrees)	Quasi pk or AVG (dBuV)		Cable Factor (dB)	Ant. Factor (dB)	Corrected Reading (dBuV)	Limits (dBuV)	Diff (dB) +=FAIL	Comments
5500.00	67.40	100	270			3.89	34.80	106.09			<b>Ch. 100</b>
5500.00				57.19	A	3.89	34.80	95.88			
5600.00	66.22	100	315			3.93	34.90	105.05			<b>Ch. 120</b>
5600.00				56.96	A	3.93	34.90	95.79			
5700.00	65.73	100	315			3.97	35.00	104.70			<b>Ch. 140</b>
5700.00				56.37	A	3.97	35.00	95.34			

NOTE: Fundamental signals measured to calculate the band edge field strengths using the “Marker Delta Method”.



Radiated Emissions Test Results (Continued)

*Band Edge Field Strength Measurements in 802.11n mode 20MHz Wide (5470-5725 MHz)  
Channels 100 & 140  
Continuous TX at Chain A Antenna port with Shanghai Universe Antennas  
Aegis Labs, Inc. File #: INTEL-090601-02*

<b>RADIATED EMISSIONS - Horizontal Antenna Polarization</b>										
<i>Freq. (MHz)</i>	<i>Meter Reading (dBuV)</i>	<i>Antenna Height (cm)</i>	<i>Azimuth (degrees)</i>	<i>Quasi pk or AVG (dBuV)</i>	<i>Cable Factor (dB)</i>	<i>Ant. Factor (dB)</i>	<i>Corrected Reading (dBuV)</i>	<i>Limits (dBuV)</i>	<i>Diff (dB) +=FAIL</i>	<i>Comments</i>
5460.00							52.25	74.00	-21.75	<b>Ch. 100</b>
5460.00							44.59	74.00	-29.41	
5460.00					A		35.28	54.00	-18.72	
5460.00					A		36.11	54.00	-17.89	
5725.00	29.82	100	45			3.98 34.87	68.67	81.31	-12.64	<b>Ch. 140</b>

<b>RADIATED EMISSIONS - Vertical Antenna Polarization</b>										
<i>Freq. (MHz)</i>	<i>Meter Reading (dBuV)</i>	<i>Antenna Height (cm)</i>	<i>Azimuth (degrees)</i>	<i>Quasi pk or AVG (dBuV)</i>	<i>Cable Factor (dB)</i>	<i>Ant. Factor (dB)</i>	<i>Corrected Reading (dBuV)</i>	<i>Limits (dBuV)</i>	<i>Diff (dB) +=FAIL</i>	<i>Comments</i>
5460.00							57.42	74.00	-16.58	<b>Ch. 100</b>
5460.00							49.76	74.00	-24.24	
5460.00					A		38.72	54.00	-15.28	
5460.00					A		39.55	54.00	-14.45	
5725.00	30.27	100	315			3.98 35.03	69.27	84.70	-15.43	<b>Ch. 140</b>

NOTE: The “Band Edge Field Strength” was calculated using the “Fundamental” and “Conducted Band Edge” measurements per the “Marker-Delta Method” with the following formula:

$$BE = Fm - \Delta m$$

Where

BE = Band Edge Field Strength

Fm = Measured Fundamental (Peak or Average)

Δm = Measured Conducted Band Edge Delta (Peak or Average)

Band-Edge Plots (Continued)

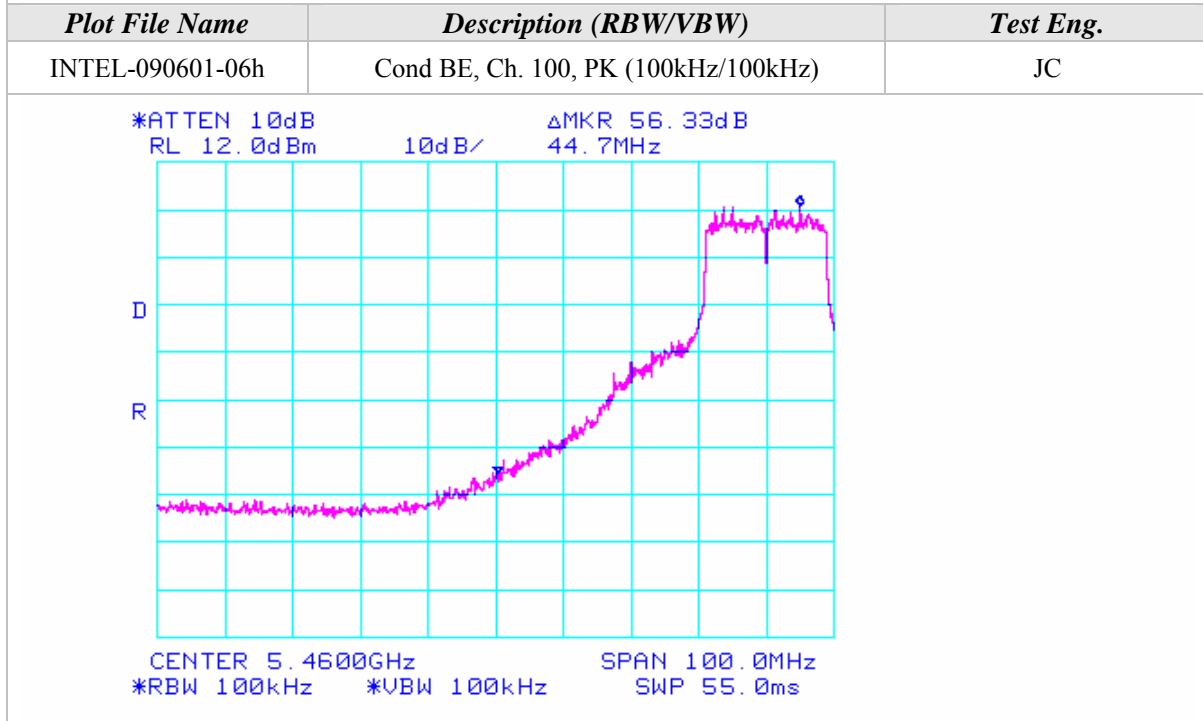
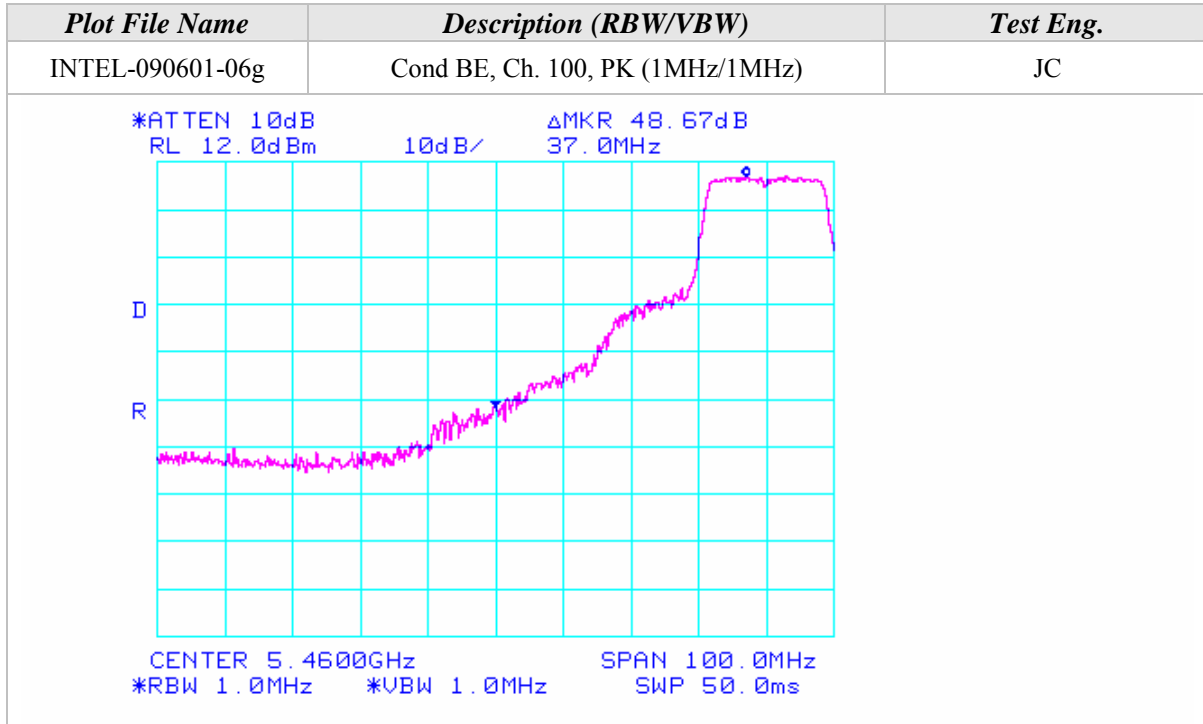

Band-Edge Plots (Continued)

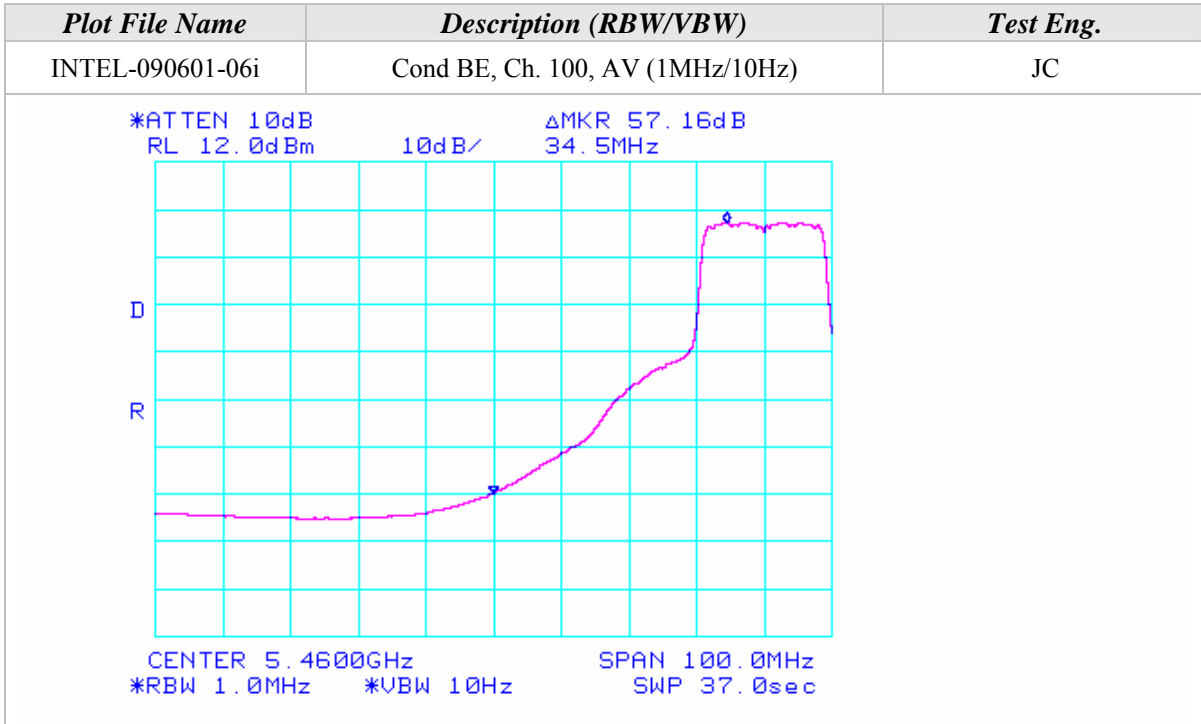



Radiated Emissions Test Results (Continued)

*Fundamental Measurements in 802.11n mode 20MHz Wide (5470-5725 MHz)  
Channels 100, 120, & 140  
Continuous TX at Chain B Antenna port with Shanghai Universe Antennas  
Aegis Labs, Inc. File #: INTEL-090601-04*

<b>RADIATED EMISSIONS - Horizontal Antenna Polarization</b>											
<i>Freq. (MHz)</i>	<i>Meter Reading (dBuV)</i>	<i>Antenna Height (cm)</i>	<i>Azimuth (degrees)</i>	<i>Quasi pk or AVG (dBuV)</i>		<i>Cable Factor (dB)</i>	<i>Ant. Factor (dB)</i>	<i>Corrected Reading (dBuV)</i>	<i>Limits (dBuV)</i>	<i>Diff (dB) +=FAIL</i>	<i>Comments</i>
5500.00	65.50	100	315			3.89	34.60	103.99			<b>Ch. 100</b>
5500.00				55.50	A	3.89	34.60	93.99			
5600.00	66.00	100	315			3.93	34.72	104.65			<b>Ch. 120</b>
5600.00				56.17	A	3.93	34.72	94.82			
5700.00	65.17	100	315			3.97	34.84	103.98			<b>Ch. 140</b>
5700.00				55.33	A	3.97	34.84	94.14			

<b>RADIATED EMISSIONS - Vertical Antenna Polarization</b>											
<i>Freq. (MHz)</i>	<i>Meter Reading (dBuV)</i>	<i>Antenna Height (cm)</i>	<i>Azimuth (degrees)</i>	<i>Quasi pk or AVG (dBuV)</i>		<i>Cable Factor (dB)</i>	<i>Ant. Factor (dB)</i>	<i>Corrected Reading (dBuV)</i>	<i>Limits (dBuV)</i>	<i>Diff (dB) +=FAIL</i>	<i>Comments</i>
5500.00	67.50	100	0			3.89	34.80	106.19			<b>Ch. 100</b>
5500.00				57.67	A	3.89	34.80	96.36			
5600.00	66.33	100	315			3.93	34.90	105.16			<b>Ch. 120</b>
5600.00				57.17	A	3.93	34.90	96.00			
5700.00	65.83	100	315			3.97	35.00	104.80			<b>Ch. 140</b>
5700.00				56.67	A	3.97	35.00	95.64			

NOTE: Fundamental signals measured to calculate the band edge field strengths using the “Marker Delta Method”.



Radiated Emissions Test Results (Continued)

*Band Edge Field Strength Measurements in 802.11n mode 20MHz Wide (5470-5725 MHz)  
Channels 100 & 140  
Continuous TX at Chain B Antenna port with Shanghai Universe Antennas  
Aegis Labs, Inc. File #: INTEL-090601-04*

<b>RADIATED EMISSIONS - Horizontal Antenna Polarization</b>										
<i>Freq. (MHz)</i>	<i>Meter Reading (dBuV)</i>	<i>Antenna Height (cm)</i>	<i>Azimuth (degrees)</i>	<i>Quasi pk or AVG (dBuV)</i>	<i>Cable Factor (dB)</i>	<i>Ant. Factor (dB)</i>	<i>Corrected Reading (dBuV)</i>	<i>Limits (dBuV)</i>	<i>Diff (dB) +=FAIL</i>	<i>Comments</i>
5460.00							57.99	74.00	-16.01	<b>Ch. 100</b>
5460.00							50.32	74.00	-23.68	
5460.00					A		39.83	54.00	-14.17	
5460.00					A		40.32	54.00	-13.68	
5725.00	31.33	100	90			3.98 34.87	70.18	83.98	-13.80	<b>Ch. 140</b>

<b>RADIATED EMISSIONS - Vertical Antenna Polarization</b>										
<i>Freq. (MHz)</i>	<i>Meter Reading (dBuV)</i>	<i>Antenna Height (cm)</i>	<i>Azimuth (degrees)</i>	<i>Quasi pk or AVG (dBuV)</i>	<i>Cable Factor (dB)</i>	<i>Ant. Factor (dB)</i>	<i>Corrected Reading (dBuV)</i>	<i>Limits (dBuV)</i>	<i>Diff (dB) +=FAIL</i>	<i>Comments</i>
5460.00							60.19	74.00	-13.81	<b>Ch. 100</b>
5460.00							52.52	74.00	-21.48	
5460.00					A		42.20	54.00	-11.80	
5460.00					A		42.69	54.00	-11.31	
5725.00	32.17	100	315			3.98 35.03	71.17	84.80	-13.63	<b>Ch. 140</b>

NOTE: The “Band Edge Field Strength” was calculated using the “Fundamental” and “Conducted Band Edge” measurements per the “Marker-Delta Method” with the following formula:

$$BE = Fm - \Delta m$$

Where

BE = Band Edge Field Strength

Fm = Measured Fundamental (Peak or Average)

Δm = Measured Conducted Band Edge Delta (Peak or Average)

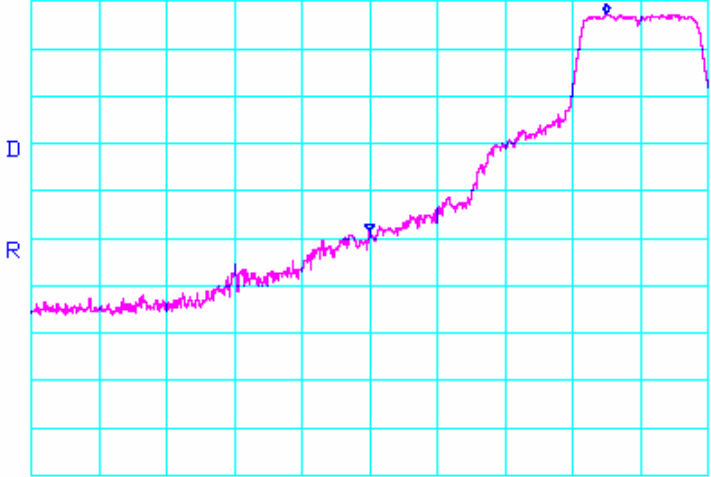

Band-Edge Plots (Continued)

Plot File Name	Description (RBW/VBW)	Test Eng.
INTEL-090526-13g	Cond BE, Ch. 100, PK (1MHz/1MHz)	JC
<p>*ATTEN 10dB                              ΔMKR 46.00dB RL 12.0dBm                      10dB/                      35.0MHz</p>  <p>CENTER 5.4600GHz                      SPAN 100.0MHz *RBW 1.0MHz                      *VBW 1.0MHz                      SWP 50.0ms</p>		

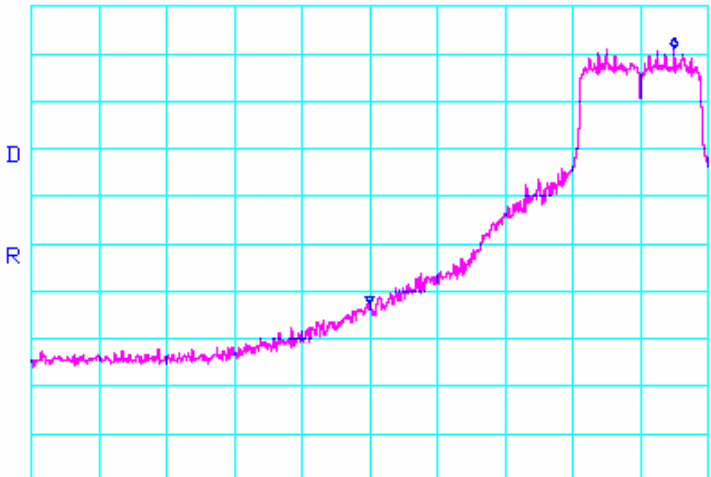
Plot File Name	Description (RBW/VBW)	Test Eng.
INTEL-090526-13h	Cond BE, Ch. 100, PK (100kHz/100kHz)	JC
<p>*ATTEN 10dB                              ΔMKR 53.67dB RL 12.0dBm                      10dB/                      45.0MHz</p>  <p>CENTER 5.4600GHz                      SPAN 100.0MHz *RBW 100kHz                      *VBW 100kHz                      SWP 55.0ms</p>		





Band-Edge Plots (Continued)

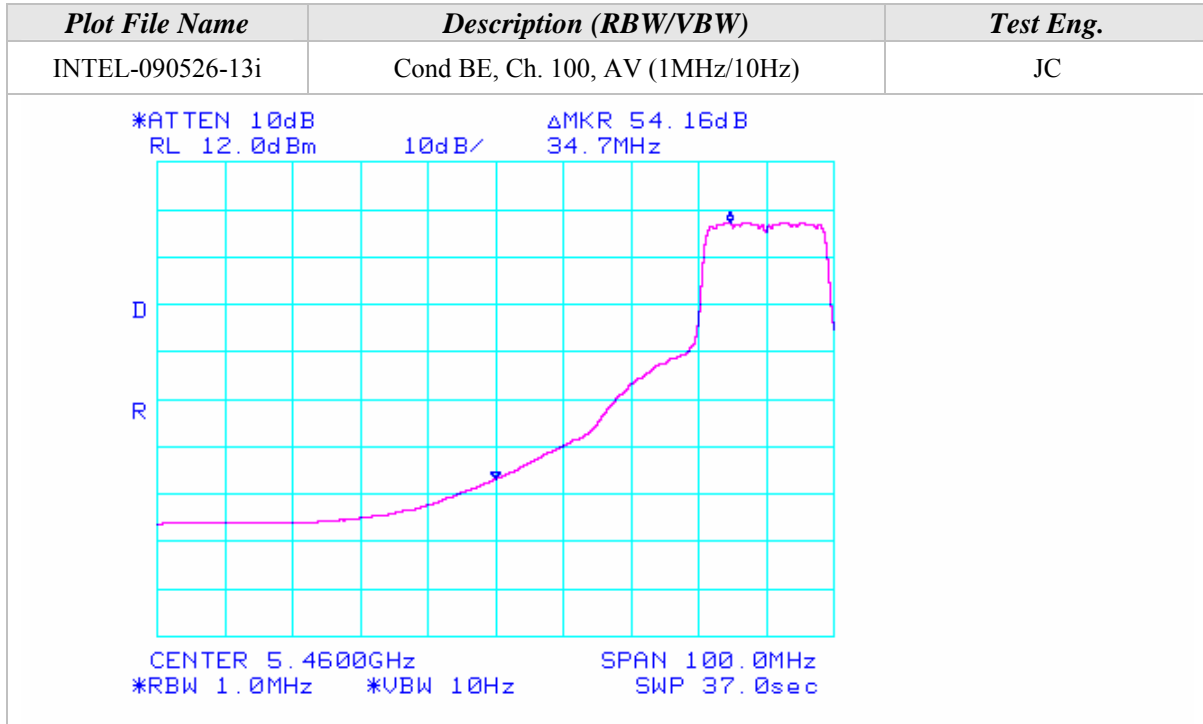



Radiated Emissions Test Results (Continued)

*Spurious Emissions Measurements in 802.11n mode 20MHz Wide (5470-5725 MHz)  
Channels 100, 120, & 140  
Continuous TX at Chain A & B Antenna ports with Shanghai Universe Antennas  
Aegis Labs, Inc. File #: INTEL-090601-07*

**RADIATED EMISSIONS - Horizontal Antenna Polarization**

Freq. (MHz)	Meter Reading (dBuV)	Antenna Height (cm)	Azimuth (degrees)	Quasi pk or AVG (dBuV)		Preamp Factor (dB)	Cable Factor (dB)	Ant. Factor (dB)	Corrected Reading (dBuV)	Limits (dBuV)	Diff (dB) +/-FAIL	Channel/Chain Tested
3733.33	53.50	100	315			47.55	3.19	33.08	42.22	74.00	-31.78	<b>Ch. 120/</b>
3733.33		100	315	42.73	A	47.55	3.19	33.08	31.45	54.00	-22.55	<b>A</b>
7466.66	54.17	100	0			45.68	4.60	35.71	48.79	74.00	-25.21	
7466.66		100	0	46.73	A	45.68	4.60	35.71	41.35	54.00	-12.65	
3733.33	53.67	100	315			47.55	3.19	33.08	42.39	74.00	-31.61	<b>Ch. 120/</b>
3733.33		100	315	43.30	A	47.55	3.19	33.08	32.02	54.00	-21.98	<b>B</b>
7466.66	54.00	100	0			45.68	4.60	35.71	48.62	74.00	-25.38	
7466.66		100	0	45.79	A	45.68	4.60	35.71	40.41	54.00	-13.59	
3666.66	54.00	100	315			47.58	3.17	33.00	42.59	74.00	-31.41	<b>Ch. 100/</b>
3666.66		100	315	42.50	A	47.58	3.17	33.00	31.09	54.00	-22.91	<b>A</b>
7333.32	52.17	100	0			45.81	4.55	35.73	46.64	74.00	-27.36	
7333.32		100	0	41.08	A	45.81	4.55	35.73	35.55	54.00	-18.45	
3800.00	53.50	100	0			47.54	3.24	33.16	42.36	74.00	-31.64	<b>Ch. 140/</b>
3800.00		100	0	41.08	A	47.54	3.24	33.16	29.94	54.00	-24.06	<b>A</b>
7600.00	53.67	100	0			45.60	4.64	35.76	48.46	74.00	-25.54	
7600.00		100	0	45.68	A	45.60	4.64	35.76	40.47	54.00	-13.53	

**RADIATED EMISSIONS - Vertical Antenna Polarization**

Freq. (MHz)	Meter Reading (dBuV)	Antenna Height (cm)	Azimuth (degrees)	Quasi pk or AVG (dBuV)		Preamp Factor (dB)	Cable Factor (dB)	Ant. Factor (dB)	Corrected Reading (dBuV)	Limits (dBuV)	Diff (dB) +/-FAIL	Comments
3733.33	53.50	100	315			47.55	3.19	32.97	42.11	74.00	-31.89	<b>Ch. 120/</b>
3733.33		100	315	42.65	A	47.55	3.19	32.97	31.26	54.00	-22.74	<b>A</b>
7466.66	55.17	100	0			45.68	4.60	35.69	49.78	74.00	-24.22	
7466.66		100	0	46.20	A	45.68	4.60	35.69	40.81	54.00	-13.19	
3733.33	53.83	100	315			47.55	3.19	32.97	42.44	74.00	-31.56	<b>Ch. 120/</b>
3733.33		100	315	43.51	A	47.55	3.19	32.97	32.12	54.00	-21.88	<b>B</b>
7466.66	55.00	100	0			45.68	4.60	35.69	49.61	74.00	-24.39	
7466.66		100	0	46.73	A	45.68	4.60	35.69	41.34	54.00	-12.66	
3666.66	53.50	100	315			47.58	3.17	32.87	41.96	74.00	-32.04	<b>Ch. 100/</b>
3666.66		100	315	43.23	A	47.58	3.17	32.87	31.69	54.00	-22.31	<b>B</b>
7333.32	51.83	100	0			45.81	4.55	35.67	46.23	74.00	-27.77	
7333.32		100	0	41.35	A	45.81	4.55	35.67	35.75	54.00	-18.25	
3800.00	53.83	100	45			47.54	3.24	33.08	42.61	74.00	-31.39	<b>Ch. 140/</b>
3800.00		100	45	43.16	A	47.54	3.24	33.08	31.94	54.00	-22.06	<b>B</b>
7600.00	54.67	100	0			45.60	4.64	35.74	49.44	74.00	-24.56	
7600.00		100	0	46.40	A	45.60	4.64	35.74	41.17	54.00	-12.83	



Radiated Emissions Test Results (Continued)

*Spurious Emissions Measurements in 802.11n mode 20MHz Wide (5470-5725 MHz)  
Channels 100, 120, & 140  
Continuous TX at Dual Chain AB Antenna ports with Shanghai Universe Antennas  
Aegis Labs, Inc. File #: INTEL-090601-07*

<b>RADIATED EMISSIONS - Horizontal Antenna Polarization</b>												
Freq. (MHz)	Meter Reading (dBuV)	Antenna Height (cm)	Azimuth (degrees)	Quasi pk or AVG (dBuV)		Preamp Factor (dB)	Cable Factor (dB)	Ant. Factor (dB)	Corrected Reading (dBuV)	Limits (dBuV)	Diff (dB) +/-FAIL	Channel/Chain Tested
3666.66	54.83	100	225			50.75	3.17	33.00	40.25	74.00	-33.75	<b>Ch. 100/</b>
3666.66				42.24	A	50.75	3.17	33.00	27.66	54.00	-26.34	<b>AB</b>
7333.33	53.00	100	225			50.26	4.55	35.90	43.19	74.00	-30.81	
7333.33				42.19	A	50.26	4.55	35.90	32.38	54.00	-21.62	
3733.33	51.00	100	135			50.76	3.19	33.08	36.51	74.00	-37.49	<b>Ch. 120/</b>
3733.33				40.95	A	50.76	3.19	33.08	26.46	54.00	-27.54	<b>AB</b>
7466.66	52.17	100	225			50.20	4.60	35.98	42.55	74.00	-31.45	
7466.66				43.30	A	50.20	4.60	35.98	33.68	54.00	-20.32	
11199.99	52.50	100	270			50.48	5.75	38.22	45.99	74.00	-28.01	
11199.99				40.00	A	50.48	5.75	38.22	33.49	54.00	-20.51	
3800.00	54.00	100	225			50.68	3.24	33.16	39.72	74.00	-34.28	<b>Ch. 140/</b>
3800.00				43.55	A	50.68	3.24	33.16	29.27	54.00	-24.73	<b>AB</b>
7600.00	52.00	100	225			50.16	4.64	36.02	42.49	74.00	-31.51	
7600.00				40.89	A	50.16	4.64	36.02	31.38	54.00	-22.62	

<b>RADIATED EMISSIONS - Vertical Antenna Polarization</b>												
Freq. (MHz)	Meter Reading (dBuV)	Antenna Height (cm)	Azimuth (degrees)	Quasi pk or AVG (dBuV)		Preamp Factor (dB)	Cable Factor (dB)	Ant. Factor (dB)	Corrected Reading (dBuV)	Limits (dBuV)	Diff (dB) +/-FAIL	Comments
3666.66	57.33	100	180			50.75	3.17	33.07	42.82	74.00	-31.18	<b>Ch. 100/</b>
3666.66				48.75	A	50.75	3.17	33.07	34.24	54.00	-19.76	<b>AB</b>
7333.33	51.50	100	225			50.26	4.55	35.93	41.72	74.00	-32.28	
7333.33				42.78	A	50.26	4.55	35.93	33.00	54.00	-21.00	
3733.33	52.17	100	90			50.76	3.19	33.13	37.74	74.00	-36.26	<b>Ch. 120/</b>
3733.33				43.26	A	50.76	3.19	33.13	28.83	54.00	-25.17	<b>AB</b>
7466.66	53.67	100	135			50.20	4.60	36.07	44.14	74.00	-29.86	
7466.66				46.61	A	50.20	4.60	36.07	37.08	54.00	-16.92	
11200.00	53.33	100	225			50.48	5.75	38.10	46.70	74.00	-27.30	
11200.00				41.99	A	50.48	5.75	38.10	35.36	54.00	-18.64	
3800.00	54.50	100	180			50.68	3.24	33.20	40.26	74.00	-33.74	<b>Ch. 140/</b>
3800.00				46.59	A	50.68	3.24	33.20	32.35	54.00	-21.65	<b>AB</b>
7600.00	55.00	100	180			50.16	4.64	36.12	45.59	74.00	-28.41	
7600.00				48.17	A	50.16	4.64	36.12	38.76	54.00	-15.24	
11400.00	50.83	100	135	53.67		50.51	5.86	38.30	47.31	74.00	-26.69	
11400.00				40.10	A	50.51	5.86	38.30	33.74	54.00	-20.26	

**RADIATED EMISSIONS TEST RESULTS**

<b>CLIENT:</b>	Intel Corporation	<b>DATE:</b>	08/17/09
<b>EUT:</b>	Intel® Centrino® Ultimate-N 6200	<b>PROJECT NUMBER:</b>	INTEL-090601
<b>MODEL NUMBER:</b>	622ANHMW	<b>TEST ENGINEER:</b>	JC
<b>SERIAL NUMBER:</b>	0015005A3C7C	<b>SITE #:</b>	2
<b>CONFIGURATION:</b>	Tested installed in an extender board connected to the host laptop's mini PCI slot in <b>802.11n (5740-5745 MHz) mode 40MHz Wide.</b>	<b>TEMPERATURE:</b>	24° C
		<b>HUMIDITY:</b>	46% RH
		<b>TIME:</b>	9:30 AM

<b>Description:</b>	Radiated RF Emissions (1 GHz – 18 GHz)
<b>Results:</b>	<b>PASSED</b> Horizontal and Vertical Antenna Polarizations Class B Limits
<b>Note:</b>	Radiated Emissions Measurements were performed on the EUT with power supply set at the following voltage and frequency. <ul style="list-style-type: none"> <li>• 120VAC / 60 Hz.</li> </ul>

<b>Unwanted Spurious Emissions Limits</b>			
<b>Frequency (MHz)</b>	<b>Field Strength (uV/m)</b>	<b>Field Strength (dBuV/m) (Emissions in the restricted bands)</b>	<b>Field Strength (dBm/MHz) (Emissions outside the restricted bands)</b>
Above 960	500	54.00 (Average) 74.00 (Peak)	< -20 dBc

## Radiated Emissions Sample Calculations

$$\text{Corrected Meter Reading} = \text{Meter Reading} + F + C - D$$

Where, F = Antenna Factor

C = Cable Factor

G = Amplifier Gain

D = Distance Factor (if applicable)

Therefore, the equation for determining the Corrected Meter Reading Limit (CML) is:

$$\text{CML} = \text{Specification Limit} - F - C + D$$



Radiated Emissions Test Results (Continued)

*Fundamental Measurements in 802.11n mode 40MHz Wide (5470-5725 MHz)  
Channels 102, 118, & 134  
Continuous TX at Chain A Antenna port with Shanghai Universe Antennas  
Aegis Labs, Inc. File #: INTEL-090601-02*

<b>RADIATED EMISSIONS - Horizontal Antenna Polarization</b>											
Freq. (MHz)	Meter Reading (dBuV)	Antenna Height (cm)	Azimuth (degrees)	Quasi pk or AVG (dBuV)		Cable Factor (dB)	Ant. Factor (dB)	Corrected Reading (dBuV)	Limits (dBuV)	Diff (dB) +=FAIL	Comments
5510.00	62.72	100	45			3.89	34.61	101.23			<b>Ch. 102</b>
5510.00				53.93	A	3.89	34.61	92.44			
5590.00	61.69	100	45			3.92	34.71	100.32			<b>Ch. 118</b>
5590.00				52.57	A	3.92	34.71	91.20			
5670.00	61.15	100	45			3.95	34.80	99.91			<b>Ch. 134</b>
5670.00				52.10	A	3.95	34.80	90.86			

<b>RADIATED EMISSIONS - Vertical Antenna Polarization</b>											
Freq. (MHz)	Meter Reading (dBuV)	Antenna Height (cm)	Azimuth (degrees)	Quasi pk or AVG (dBuV)		Cable Factor (dB)	Ant. Factor (dB)	Corrected Reading (dBuV)	Limits (dBuV)	Diff (dB) +=FAIL	Comments
5510.00	62.13	100	315			3.89	34.81	100.83			<b>Ch. 102</b>
5510.00				52.12	A	3.89	34.81	90.82			
5590.00	62.48	100	315			3.92	34.89	101.29			<b>Ch. 118</b>
5590.00				52.39	A	3.92	34.89	91.20			
5670.00	60.54	100	315			3.95	34.97	99.46			<b>Ch. 134</b>
5670.00				50.69	A	3.95	34.97	89.61			

NOTE: Fundamental signals measured to calculate the band edge field strengths using the “Marker Delta Method”.



Radiated Emissions Test Results (Continued)

*Band Edge Field Strength Measurements in 802.11n mode 40MHz Wide (5470-5725 MHz)  
Channels 102 & 134  
Continuous TX at Chain A Antenna port with Shanghai Universe Antennas  
Aegis Labs, Inc. File #: INTEL-090601-02*

RADIATED EMISSIONS - Horizontal Antenna Polarization										
Freq. (MHz)	Meter Reading (dBuV)	Antenna Height (cm)	Azimuth (degrees)	Quasi pk or AVG (dBuV)	Cable Factor (dB)	Ant. Factor (dB)	Corrected Reading (dBuV)	Limits (dBuV)	Diff (dB) +=FAIL	Comments
5460.00							61.73	74.00	-12.27	<b>Ch. 102</b>
5460.00							57.73	74.00	-16.27	
5460.00					A		48.60	54.00	-5.40	
5460.00					A		48.94	54.00	-5.06	
5725.00	31.49	100	45		3.98	34.87	70.34	79.91	-9.57	<b>Ch. 134</b>

RADIATED EMISSIONS - Vertical Antenna Polarization										
Freq. (MHz)	Meter Reading (dBuV)	Antenna Height (cm)	Azimuth (degrees)	Quasi pk or AVG (dBuV)	Cable Factor (dB)	Ant. Factor (dB)	Corrected Reading (dBuV)	Limits (dBuV)	Diff (dB) +=FAIL	Comments
5460.00							61.33	74.00	-12.67	<b>Ch. 102</b>
5460.00							57.33	74.00	-16.67	
5460.00					A		46.98	54.00	-7.02	
5460.00					A		47.32	54.00	-6.68	
5725.00	30.89	100	315		3.98	35.03	69.89	79.46	-9.57	<b>Ch. 134</b>

NOTE: The “Band Edge Field Strength” was calculated using the “Fundamental” and “Conducted Band Edge” measurements per the “Marker-Delta Method” with the following formula:

$$BE = Fm - \Delta m$$

Where

BE = Band Edge Field Strength

Fm = Measured Fundamental (Peak or Average)

Δm = Measured Conducted Band Edge Delta (Peak or Average)

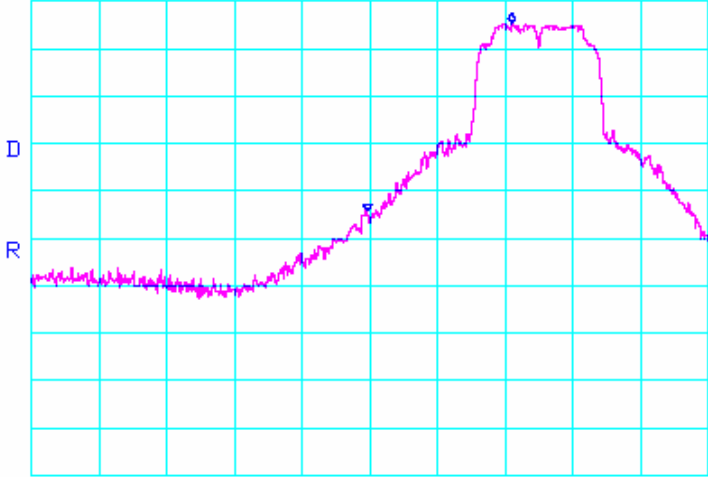
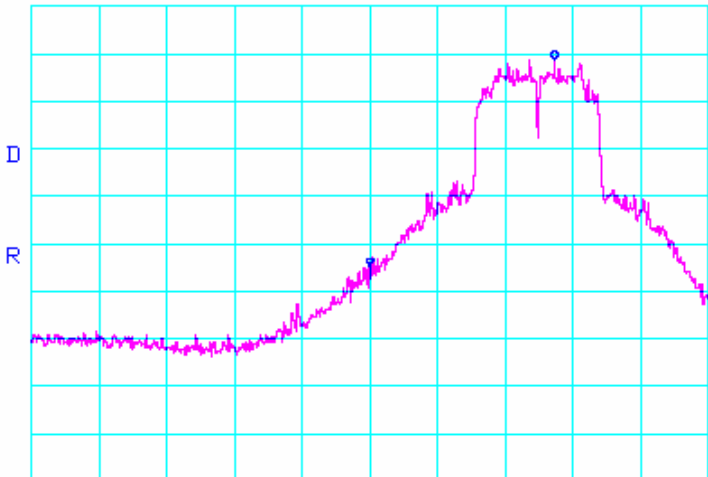

Band-Edge Plots (Continued)

<i>Plot File Name</i>	<i>Description (RBW/VBW)</i>	<i>Test Eng.</i>
INTEL-090601-07g	Cond BE, Ch. 102, PK (1MHz/1MHz)	JC
<p>*ATTEN 10dB                                  ΔMKR 39.50dB            RL 12.0dBm                              10dB/                              42.7MHz</p>  <p>CENTER 5.4600GHz                              SPAN 200.0MHz            *RBW 1.0MHz                              *VBW 1.0MHz                              SWP 50.0ms</p>		
<i>Plot File Name</i>	<i>Description (RBW/VBW)</i>	<i>Test Eng.</i>
INTEL-090601-07h	Cond BE, Ch. 102, PK (100kHz/100kHz)	JC
<p>*ATTEN 10dB                                  ΔMKR 43.50dB            RL 12.0dBm                              10dB/                              54.7MHz</p>  <p>CENTER 5.4600GHz                              SPAN 200.0MHz            *RBW 100kHz                              *VBW 100kHz                              SWP 110ms</p>		

Band-Edge Plots (Continued)

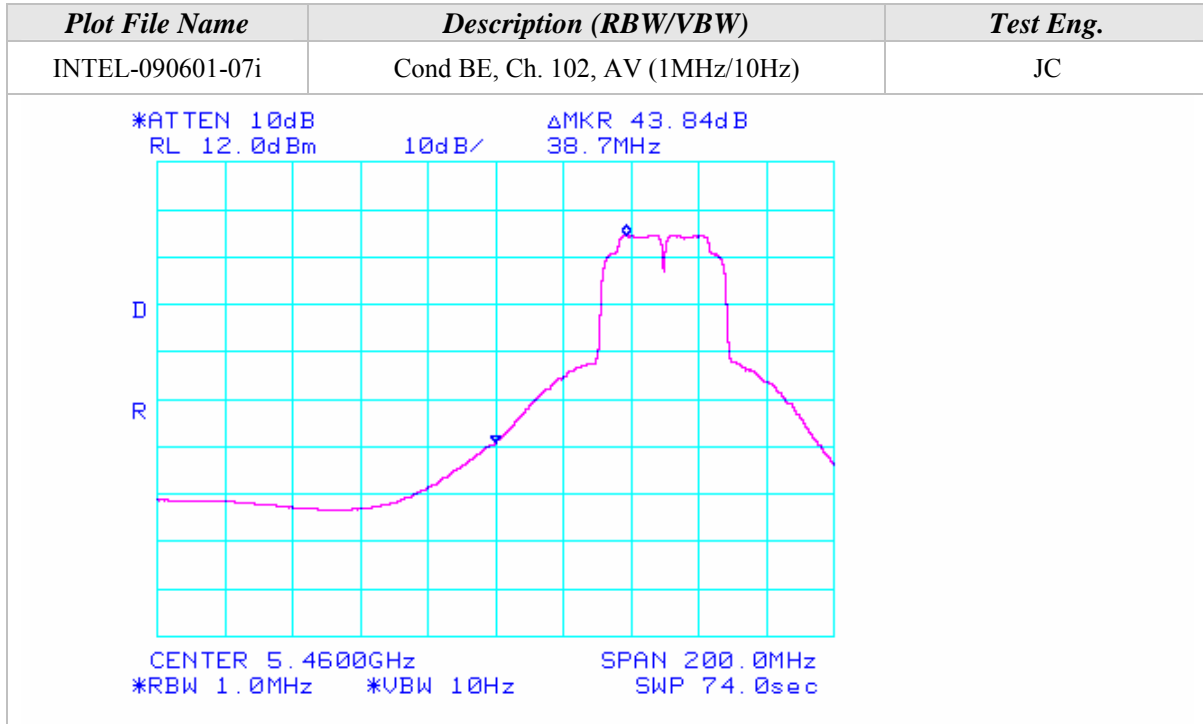



Radiated Emissions Test Results (Continued)

*Fundamental Measurements in 802.11n mode 40MHz Wide (5470-5725 MHz)  
Channels 102, 118, & 134  
Continuous TX at Chain B Antenna port with Shanghai Universe Antennas  
Aegis Labs, Inc. File #: INTEL-090601-04*

<b>RADIATED EMISSIONS - Horizontal Antenna Polarization</b>											
Freq. (MHz)	Meter Reading (dBuV)	Antenna Height (cm)	Azimuth (degrees)	Quasi pk or AVG (dBuV)		Cable Factor (dB)	Ant. Factor (dB)	Corrected Reading (dBuV)	Limits (dBuV)	Diff (dB) +/-FAIL	Comments
5510.00	61.83	100	315			3.89	34.61	100.34			<b>Ch. 102</b>
5510.00				52.33	A	3.89	34.61	90.84			
5590.00	63.00	100	0			3.92	34.71	101.63			<b>Ch. 118</b>
5590.00				53.50	A	3.92	34.71	92.13			
5670.00	61.67	100	315			3.95	34.80	100.43			<b>Ch. 134</b>
5670.00				52.33	A	3.95	34.80	91.09			

<b>RADIATED EMISSIONS - Vertical Antenna Polarization</b>											
Freq. (MHz)	Meter Reading (dBuV)	Antenna Height (cm)	Azimuth (degrees)	Quasi pk or AVG (dBuV)		Cable Factor (dB)	Ant. Factor (dB)	Corrected Reading (dBuV)	Limits (dBuV)	Diff (dB) +/-FAIL	Comments
5510.00	62.00	100	90			3.89	34.81	100.70			<b>Ch. 102</b>
5510.00				51.67	A	3.89	34.81	90.37			
5590.00	62.17	100	90			3.92	34.89	100.98			<b>Ch. 118</b>
5590.00				52.00	A	3.92	34.89	90.81			
5670.00	58.33	100	315			3.95	34.97	97.25			<b>Ch. 134</b>
5670.00				48.67	A	3.95	34.97	87.59			

NOTE: Fundamental signals measured to calculate the band edge field strengths using the “Marker Delta Method”.



Radiated Emissions Test Results (Continued)

*Band Edge Field Strength Measurements in 802.11n mode 40MHz Wide (5470-5725 MHz)  
Channels 102 & 134  
Continuous TX at Chain B Antenna port with Shanghai Universe Antennas  
Aegis Labs, Inc. File #: INTEL-090601-04*

<b>RADIATED EMISSIONS - Horizontal Antenna Polarization</b>											
<i>Freq. (MHz)</i>	<i>Meter Reading (dBuV)</i>	<i>Antenna Height (cm)</i>	<i>Azimuth (degrees)</i>	<i>Quasi pk or AVG (dBuV)</i>	<i>Cable Factor (dB)</i>	<i>Ant. Factor (dB)</i>	<i>Corrected Reading (dBuV)</i>	<i>Limits (dBuV)</i>	<i>Diff (dB) +=FAIL</i>	<i>Comments</i>	
5460.00							60.84	74.00	-13.16	<b>Ch. 102</b>	
5460.00							55.67	74.00	-18.33		
5460.00					A		48.01	54.00	-5.99		
5460.00					A		46.17	54.00	-7.83		
5725.00	31.33	100	315			3.98	34.87	70.18	80.43	-10.25	<b>Ch. 134</b>

<b>RADIATED EMISSIONS - Vertical Antenna Polarization</b>											
<i>Freq. (MHz)</i>	<i>Meter Reading (dBuV)</i>	<i>Antenna Height (cm)</i>	<i>Azimuth (degrees)</i>	<i>Quasi pk or AVG (dBuV)</i>	<i>Cable Factor (dB)</i>	<i>Ant. Factor (dB)</i>	<i>Corrected Reading (dBuV)</i>	<i>Limits (dBuV)</i>	<i>Diff (dB) +=FAIL</i>	<i>Comments</i>	
5460.00							61.20	74.00	-12.80	<b>Ch. 102</b>	
5460.00							56.03	74.00	-17.97		
5460.00					A		47.54	54.00	-6.46		
5460.00					A		45.70	54.00	-8.30		
5725.00	30.33	100	315			3.98	35.03	69.33	77.25	-7.92	<b>Ch. 134</b>

NOTE: The “Band Edge Field Strength” was calculated using the “Fundamental” and “Conducted Band Edge” measurements per the “Marker-Delta Method” with the following formula:

$$BE = Fm - \Delta m$$

Where

BE = Band Edge Field Strength

Fm = Measured Fundamental (Peak or Average)

Δm = Measured Conducted Band Edge Delta (Peak or Average)

Band-Edge Plots (Continued)

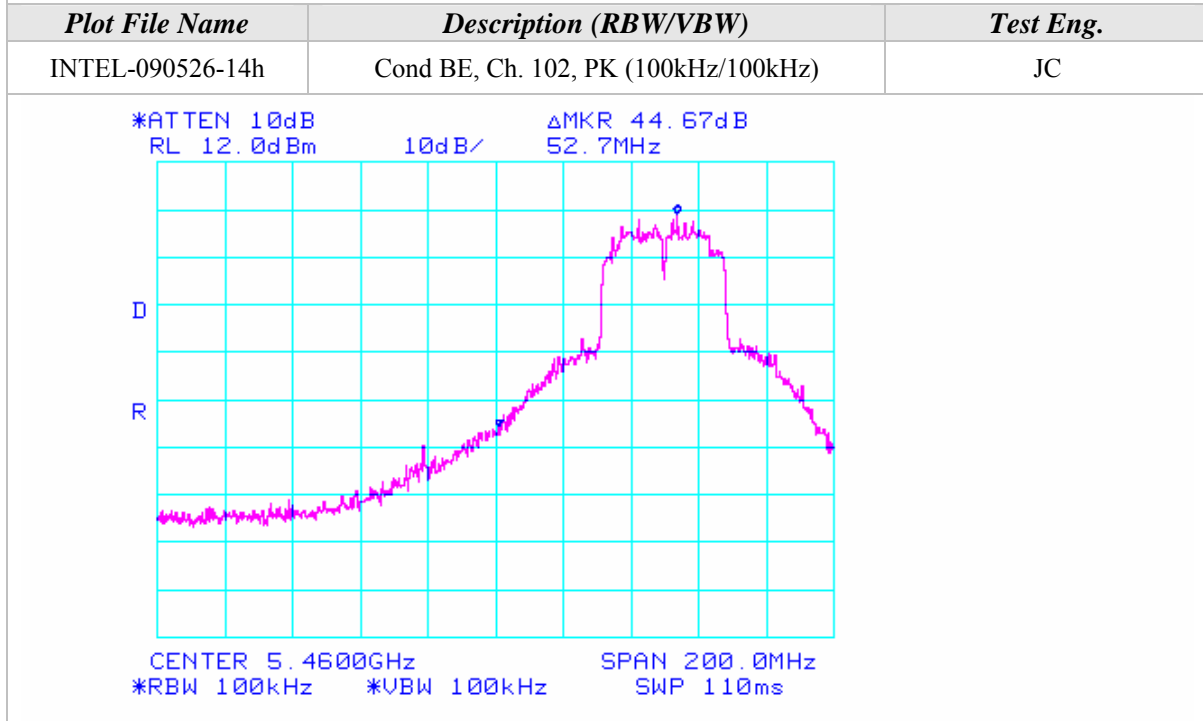
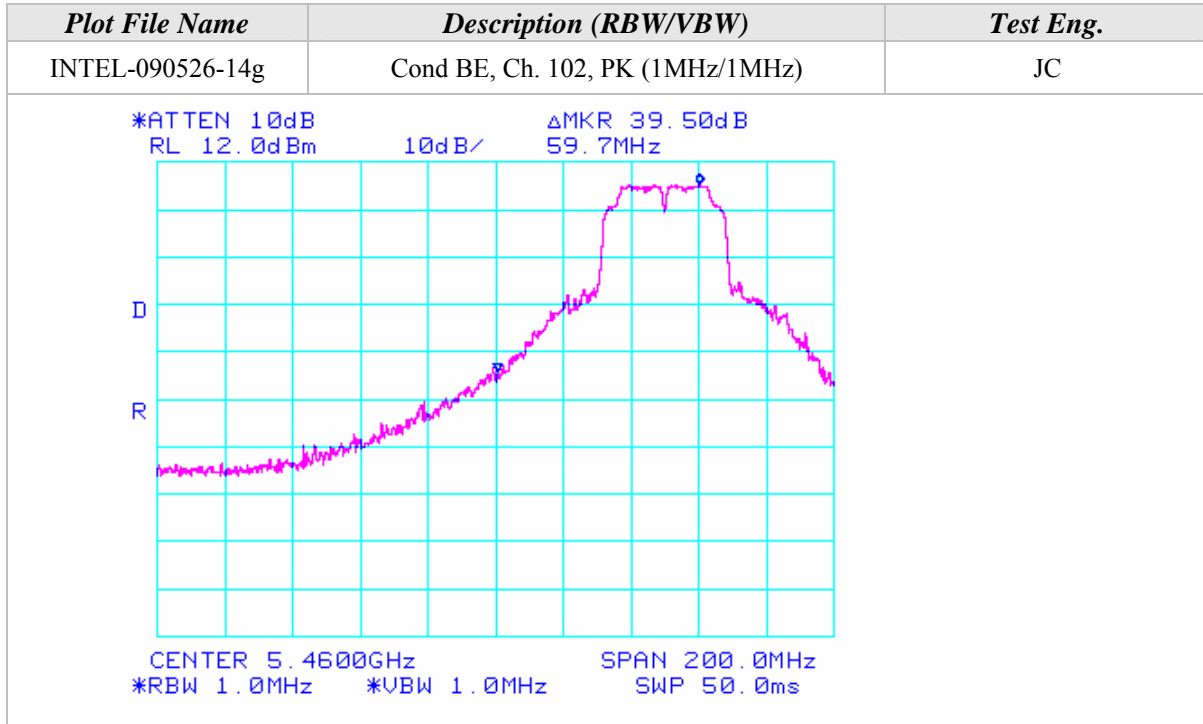



Band-Edge Plots (Continued)

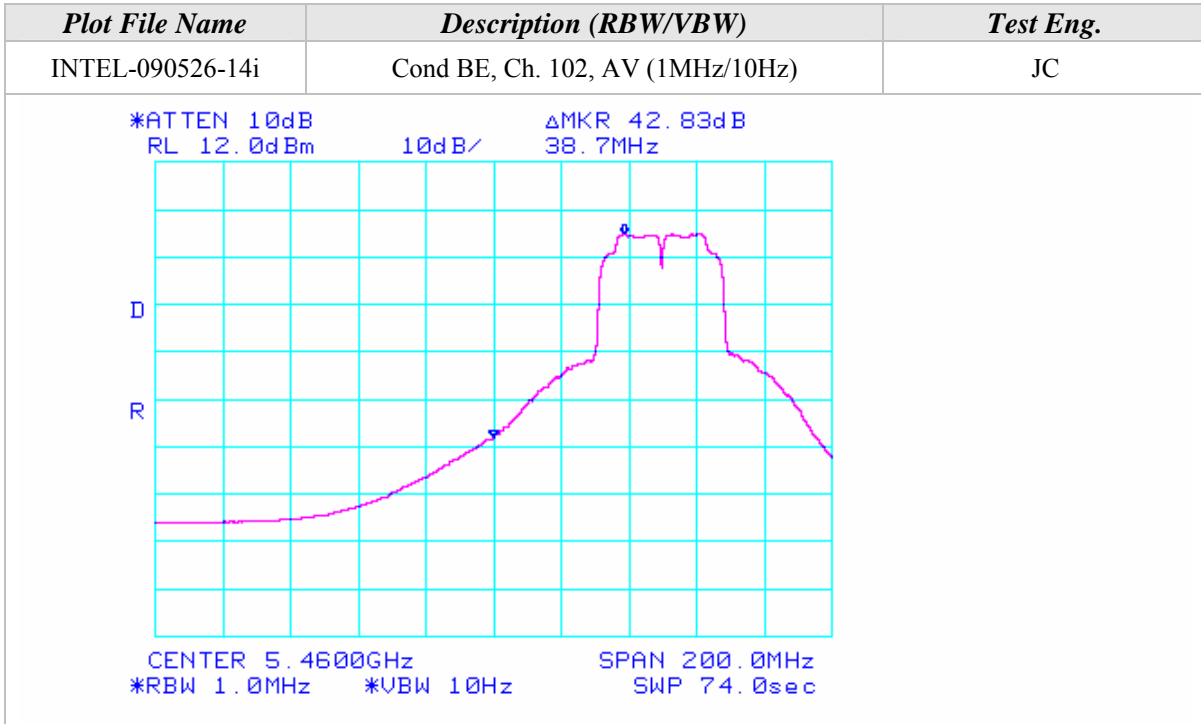



Radiated Emissions Test Results (Continued)

*Spurious Emissions Measurements in 802.11n mode 40MHz Wide (5470-5725 MHz)  
Channels 102, 118, & 134  
Continuous TX at Chain A & B Antenna ports with Shanghai Universe Antennas  
Aegis Labs, Inc. File #: INTEL-090601-07*

**RADIATED EMISSIONS - Horizontal Antenna Polarization**

Freq. (MHz)	Meter Reading (dBuV)	Antenna Height (cm)	Azimuth (degrees)	Quasi pk or AVG (dBuV)		Preamp Factor (dB)	Cable Factor (dB)	Ant. Factor (dB)	Corrected Reading (dBuV)	Limits (dBuV)	Diff (dB) +/-FAIL	Channel/Chain Tested
3733.33	52.83	100	225			46.55	2.53	32.91	41.72	74.00	-32.28	<b>Ch. 118/</b>
3733.33				42.17	A	46.55	2.53	32.91	31.06	54.00	-22.94	<b>A</b>
7466.66	52.83	100	225			44.88	3.63	37.21	48.80	74.00	-25.20	
7466.66				42.82	A	44.88	3.63	37.21	38.79	54.00	-15.21	
3733.33	54.83	100	180			46.55	2.53	32.91	43.72	74.00	-30.28	<b>Ch. 118/</b>
3733.33				46.87	A	46.55	2.53	32.91	35.76	54.00	-18.24	<b>B</b>
7466.66	54.67	100	225			44.88	3.63	37.21	50.64	74.00	-23.36	
7466.66				42.46	A	44.88	3.63	37.21	38.43	54.00	-15.57	
3666.66	54.83	100	225			46.56	2.50	32.77	43.53	74.00	-30.47	<b>Ch. 102/</b>
3666.66				42.24	A	46.56	2.50	32.77	30.94	54.00	-23.06	<b>A</b>
7333.33	53.00	100	225			44.92	3.60	36.87	48.54	74.00	-25.46	
7333.33				42.19	A	44.92	3.60	36.87	37.73	54.00	-16.27	
3800.00	54.00	100	225			46.54	2.55	33.06	43.08	74.00	-30.92	<b>Ch. 134/</b>
3800.00				43.55	A	46.54	2.55	33.06	32.63	54.00	-21.37	<b>A</b>
7600.00	52.00	100	225			44.86	3.67	37.36	48.17	74.00	-25.83	
7600.00				40.89	A	44.86	3.67	37.36	37.06	54.00	-16.94	

**RADIATED EMISSIONS - Vertical Antenna Polarization**

Freq. (MHz)	Meter Reading (dBuV)	Antenna Height (cm)	Azimuth (degrees)	Quasi pk or AVG (dBuV)		Preamp Factor (dB)	Cable Factor (dB)	Ant. Factor (dB)	Corrected Reading (dBuV)	Limits (dBuV)	Diff (dB) +/-FAIL	Comments
3733.33	53.83	100	270			46.55	2.53	32.51	42.31	74.00	-31.69	<b>Ch. 118/</b>
3733.33				42.63	A	46.55	2.53	32.51	31.11	54.00	-22.89	<b>A</b>
7466.66	52.50	100	225			44.88	3.63	37.11	48.37	74.00	-25.63	
7466.66				41.32	A	44.88	3.63	37.11	37.19	54.00	-16.81	
3733.33	56.33	100	225			46.55	2.53	32.51	44.81	74.00	-29.19	<b>Ch. 118/</b>
3733.33				49.15	A	46.55	2.53	32.51	37.63	54.00	-16.37	<b>B</b>
7466.66	55.00	100	180			44.88	3.63	37.11	50.87	74.00	-23.13	
7466.66				48.44	A	44.88	3.63	37.11	44.31	54.00	-9.69	
11200.00	49.17	100	135			45.09	4.55	38.96	47.60	74.00	-26.40	
11200.00				39.08	A	45.09	4.55	38.96	37.51	54.00	-16.49	
3666.66	57.33	100	180			46.56	2.50	32.33	45.60	74.00	-28.40	<b>Ch. 102/</b>
3666.66				48.75	A	46.56	2.50	32.33	37.02	54.00	-16.98	<b>B</b>
7333.33	51.50	100	225			44.92	3.60	36.77	46.94	74.00	-27.06	
7333.33				42.78	A	44.92	3.60	36.77	38.22	54.00	-15.78	
3800.00	54.50	100	180			46.54	2.55	32.68	43.20	74.00	-30.80	<b>Ch. 134/</b>
3800.00				46.59	A	46.54	2.55	32.68	35.29	54.00	-18.71	<b>B</b>
7600.00	55.00	100	180			44.86	3.67	37.24	51.05	74.00	-22.95	
7600.00				48.17	A	44.86	3.67	37.24	44.22	54.00	-9.78	
11400.00	50.83	100	135	53.67		45.04	4.61	39.12	52.36	74.00	-21.64	
11400.00				40.10	A	45.04	4.61	39.12	38.79	54.00	-15.21	



Radiated Emissions Test Results (Continued)

*Spurious Emissions Measurements in 802.11n mode 40MHz Wide (5470-5725 MHz)  
Channels 102, 118, & 134  
Continuous TX at Dual Chain AB Antenna ports with Shanghai Universe Antennas  
Aegis Labs, Inc. File #: INTEL-090601-07*

<b>RADIATED EMISSIONS - Horizontal Antenna Polarization</b>												
Freq. (MHz)	Meter Reading (dBuV)	Antenna Height (cm)	Azimuth (degrees)	Quasi pk or AVG (dBuV)		Preamp Factor (dB)	Cable Factor (dB)	Ant. Factor (dB)	Corrected Reading (dBuV)	Limits (dBuV)	Diff (dB) +=FAIL	Channel/Chain Tested
3673.33	52.67	100	45			47.58	3.17	33.01	41.27	68.00	-26.73	<b>Ch. 102/</b>
3673.33		100	45	40.62		47.58	3.17	33.01	29.22	74.00	-44.78	<b>AB</b>
7346.66	52.50	100	315			45.80	4.55	35.73	46.99	74.00	-27.01	
7346.66		100	315	42.26	A	45.80	4.55	35.73	36.75	54.00	-17.25	
3726.66	52.83	100	45			47.55	3.19	33.07	41.54	74.00	-32.46	<b>Ch. 118/</b>
3726.66		100	45	41.44	A	47.55	3.19	33.07	30.15	54.00	-23.85	<b>AB</b>
7453.33	53.53	100	315			45.70	4.59	35.71	48.14	74.00	-25.86	
7453.33		100	315	44.60	A	45.70	4.59	35.71	39.21	54.00	-14.79	
3780.00	51.67	100	0			47.54	3.23	33.14	40.49	74.00	-33.51	<b>Ch. 134/</b>
3780.00		100	0	40.71	A	47.54	3.23	33.14	29.53	54.00	-24.47	<b>AB</b>
7560.00	52.33	100	0			45.62	4.63	35.74	47.07	74.00	-26.93	
7560.00		100	0	41.35	A	45.62	4.63	35.74	36.09	54.00	-17.91	

<b>RADIATED EMISSIONS - Vertical Antenna Polarization</b>												
Freq. (MHz)	Meter Reading (dBuV)	Antenna Height (cm)	Azimuth (degrees)	Quasi pk or AVG (dBuV)		Preamp Factor (dB)	Cable Factor (dB)	Ant. Factor (dB)	Corrected Reading (dBuV)	Limits (dBuV)	Diff (dB) +=FAIL	Comments
3673.33	52.67	100	315			47.58	3.17	32.88	41.14	74.00	-32.86	<b>Ch. 102/</b>
3673.33		100	315	40.71	A	47.58	3.17	32.88	29.18	54.00	-24.82	<b>AB</b>
7346.66	56.83	100	90			45.80	4.55	35.67	51.25	74.00	-22.75	
7346.66		100	90	51.26	A	45.80	4.55	35.67	45.68	54.00	-8.32	
3726.66	55.33	100	315			47.55	3.19	32.96	43.93	74.00	-30.07	<b>Ch. 118/</b>
3726.66		100	315	43.51	A	47.55	3.19	32.96	32.11	54.00	-21.89	<b>AB</b>
7453.33	56.00	100	90			45.70	4.59	35.69	50.59	74.00	-23.41	
7453.33		100	90	48.46	A	45.70	4.59	35.69	43.05	54.00	-10.95	
3780.00	52.33	100	0			47.54	3.23	33.05	41.06	74.00	-32.94	<b>Ch. 134/</b>
3780.00		100	0	40.99	A	47.54	3.23	33.05	29.72	54.00	-24.28	<b>AB</b>
7560.00	56.50	100	0			45.62	4.63	35.72	51.23	74.00	-22.77	
7560.00		100	0	51.08	A	45.62	4.63	35.72	45.81	54.00	-8.19	
11340.00	51.83	100	0			45.30	5.83	38.24	50.60	74.00	-23.40	
11340.00		100	0	39.50	A	45.30	5.83	38.24	38.27	54.00	-15.73	

**MAXIMUM CONDUCTED OUTPUT POWER**

<b>CLIENT:</b>	Intel Corporation	<b>DATE:</b>	07/30/09
<b>EUT:</b>	Intel® Centrino® Ultimate-N 6200	<b>PROJECT NUMBER:</b>	INTEL-090601
<b>MODEL NUMBER:</b>	622ANHMW	<b>TEST ENGINEER:</b>	JC
<b>SERIAL NUMBER:</b>	0015005A3C7C	<b>SITE #:</b>	2
<b>CONFIGURATION:</b>	Tested installed in an extender board connected to the host laptop's mini PCI slot	<b>TEMPERATURE:</b>	22 deg. C
		<b>HUMIDITY:</b>	54% RH
		<b>TIME:</b>	8:00 AM

<b>Description:</b>	<p>For the band 5.15-5.25 GHz, the Maximum Conducted Output Power over the frequency band of operation shall not exceed the lesser of 50 mW or <math>4 \text{ dBm} + 10\log B</math>, where B is the 26-dB emission bandwidth in MHz.</p> <p>For the band 5.25-5.35 GHz, the Maximum Conducted Output Power over the frequency band of operation shall not exceed the lesser of 250 mW or <math>11 \text{ dBm} + 10\log B</math>, where B is the 26-dB emission bandwidth in MHz.</p>
<b>Results:</b>	Passed (See Data Sheet)
<b>Note:</b>	<p>Conducted Emissions Measurements were performed on the EUT with power supply set at the following voltage and frequency.</p> <ul style="list-style-type: none"><li>• 120VAC / 60 Hz.</li></ul>



Maximum Conducted Output Power (Continued)

Mode	Channel	Frequency (MHz)	Chain	Data Rate (Mbps)	Average Power* (dBm)	Average Power* (mW)	Output Power** (dBm)	Output Power** (mW)
802.11a	36	5180	A	6	16.52	44.91	16.64	46.17
802.11a	40	5200	A	6	16.69	46.71	16.84	48.35
802.11a	48	5240	A	6	16.29	42.60	16.44	44.09
802.11a	52	5260	A	6	16.52	44.91	16.64	46.17
802.11a	56	5280	A	6	16.52	44.91	16.64	46.17
802.11a	64	5320	A	6	16.53	45.02	16.74	47.25
802.11a	36	5180	B	6	16.36	43.29	16.64	46.17
802.11a	40	5200	B	6	16.53	45.02	16.74	47.25
802.11a	48	5240	B	6	16.63	46.06	16.84	48.35
802.11a	52	5260	B	6	16.44	44.09	16.64	46.17
802.11a	56	5280	B	6	16.34	43.09	16.54	45.12
802.11a	64	5320	B	6	16.32	42.89	16.54	45.12
802.11n	36	5180	A	HT0	16.51	44.81	16.74	47.25
802.11n	40	5200	A	HT0	16.55	45.22	16.74	47.25
802.11n	48	5240	A	HT0	16.58	45.54	16.84	48.35
802.11n	52	5260	A	HT0	16.59	45.64	16.84	48.35
802.11n	56	5280	A	HT0	16.37	43.39	16.54	45.12
802.11n	64	5320	A	HT0	16.43	43.99	16.64	46.17
802.11n	36	5180	B	HT0	16.45	44.19	16.64	46.17
802.11n	40	5200	B	HT0	16.39	43.59	16.54	45.12
802.11n	48	5240	B	HT0	16.53	45.02	16.84	48.35
802.11n	52	5260	B	HT0	16.39	43.59	16.54	45.12
802.11n	56	5280	B	HT0	16.59	45.64	16.84	48.35
802.11n	64	5320	B	HT0	16.56	45.33	16.84	48.35
802.11a	100	5500	A	6	16.35	43.19	16.54	45.12
802.11a	120	5600	A	6	16.69	46.71	16.84	48.35
802.11a	140	5700	A	6	16.43	43.99	16.64	46.17
802.11a	100	5500	B	6	16.55	45.22	16.74	47.25
802.11a	120	5600	B	6	16.56	45.33	16.74	47.25
802.11a	140	5700	B	6	16.63	46.06	16.84	48.35
802.11n	100	5500	A	HT0	16.63	46.06	16.84	48.35
802.11n	120	5600	A	HT0	16.35	43.19	16.54	45.12
802.11n	140	5700	A	HT0	16.63	46.06	16.74	47.25
802.11n	100	5500	B	HT0	16.63	46.06	16.94	49.47
802.11n	120	5600	B	HT0	16.52	44.91	16.74	47.25
802.11n	140	5700	B	HT0	16.51	44.81	16.74	47.25

\*NOTE: The Average power is measured conducted, using power meter with average power sensor.

\*\*NOTE: The output power is measured conducted, using spectrum analyzer.





Maximum Conducted Output Power (Continued)

Mode	Channel	Frequency (MHz)	Chain	Data Rate (Mbps)	Average Power* (dBm)	Average Power* (mW)	Output Power** (dBm)	Output Power** (mW)
802.11n (40MHz)	38(F)	5190	A	HT0	16.66	<b>46.32</b>	16.89	<b>48.84</b>
802.11n (40MHz)	46(F)	5230	A	HT0	16.40	<b>43.63</b>	16.69	<b>46.64</b>
802.11n (40MHz)	54(F)	5270	A	HT0	16.42	<b>43.83</b>	16.69	<b>46.64</b>
802.11n (40MHz)	62(F)	5310	A	HT0	16.55	<b>45.16</b>	16.79	<b>47.73</b>
802.11n (40MHz)	38(F)	5190	B	HT0	16.39	<b>43.53</b>	16.79	<b>47.73</b>
802.11n (40MHz)	46(F)	5230	B	HT0	16.51	<b>44.75</b>	16.89	<b>48.84</b>
802.11n (40MHz)	54(F)	5270	B	HT0	16.58	<b>45.48</b>	16.89	<b>48.84</b>
802.11n (40MHz)	62(F)	5310	B	HT0	16.64	<b>46.11</b>	16.89	<b>48.84</b>
802.11n (40MHz)	102(F)	5510	A	HT0	16.60	<b>45.69</b>	16.79	<b>47.73</b>
802.11n (40MHz)	118(F)	5590	A	HT0	16.50	<b>44.65</b>	16.69	<b>46.64</b>
802.11n (40MHz)	134(F)	5670	A	HT0	16.34	<b>43.03</b>	16.59	<b>45.58</b>
802.11n (40MHz)	102(F)	5510	B	HT0	16.63	<b>46.00</b>	16.89	<b>48.84</b>
802.11n (40MHz)	118(F)	5590	B	HT0	16.35	<b>43.13</b>	16.59	<b>45.58</b>
802.11n (40MHz)	134(F)	5670	B	HT0	16.44	<b>44.03</b>	16.69	<b>46.64</b>

**Dual Chain AB Aggregate Power**

Mode	Channel	Frequency (MHz)	Chain	Data Rate (Mbps)	Average Power* (dBm)	Average Power* (mW)	Output Power** (dBm)	Output Power** (mW)
802.11n (20MHz)	36	5180	ABC	HT16	16.57	<b>45.40</b>	16.66	<b>46.29</b>
802.11n (20MHz)	40	5200	ABC	HT16	16.72	<b>46.95</b>	16.86	<b>48.51</b>
802.11n (20MHz)	48	5240	ABC	HT16	16.92	<b>49.19</b>	17.06	<b>50.76</b>
802.11n (20MHz)	52	5260	ABC	HT16	16.77	<b>47.52</b>	16.85	<b>48.46</b>
802.11n (20MHz)	56	5280	ABC	HT16	16.77	<b>47.52</b>	16.85	<b>48.46</b>
802.11n (20MHz)	64	5320	ABC	HT16	16.66	<b>46.36</b>	16.81	<b>47.94</b>
802.11n (40MHz)	38(F)	5190	ABC	HT16	16.56	<b>45.33</b>	16.75	<b>47.30</b>
802.11n (40MHz)	46(F)	5230	ABC	HT16	16.61	<b>45.84</b>	16.75	<b>47.32</b>
802.11n (40MHz)	54(F)	5270	ABC	HT16	16.78	<b>47.64</b>	16.90	<b>48.97</b>
802.11n (40MHz)	62(F)	5310	ABC	HT16	16.85	<b>48.42</b>	16.90	<b>48.97</b>
802.11n (20MHz)	100	5500	ABC	HT16	16.74	<b>47.19</b>	16.85	<b>48.46</b>
802.11n (20MHz)	120	5600	ABC	HT16	16.58	<b>45.46</b>	16.71	<b>46.84</b>
802.11n (20MHz)	140	5700	ABC	HT16	16.67	<b>46.50</b>	16.81	<b>47.94</b>
802.11n (40MHz)	102(F)	5510	ABC	HT16	16.56	<b>45.32</b>	16.70	<b>46.75</b>
802.11n (40MHz)	118(F)	5590	ABC	HT16	16.59	<b>45.64</b>	16.75	<b>47.30</b>
802.11n (40MHz)	134(F)	5670	ABC	HT16	16.50	<b>44.70</b>	16.70	<b>46.75</b>

\*NOTE: The Average power is measured conducted, using power meter with average power sensor.

\*\*NOTE: The output power is measured conducted, using spectrum analyzer.

(F) = Fat Channel

**CONDCUTED BAND EDGE EMISSIONS TEST RESULTS**

<b>CLIENT:</b>	Intel Corporation	<b>DATE:</b>	07/22/09
<b>EUT:</b>	Intel® Centrino® Ultimate-N 6200	<b>PROJECT NUMBER:</b>	INTEL-090601
<b>MODEL NUMBER:</b>	622ANHMW	<b>TEST ENGINEER:</b>	JC
<b>SERIAL NUMBER:</b>	0015005A3C7C	<b>SITE #:</b>	2
<b>CONFIGURATION:</b>	Tested installed in an extender board connected to the host laptop's mini PCI slot	<b>TEMPERATURE:</b>	23 deg. C
		<b>HUMIDITY:</b>	51% RH
		<b>TIME:</b>	10:00 AM

<b>Description:</b>	For transmitters operating in the 5.25-5.35 GHz band: all emissions outside of the 5.15-5.35 GHz band shall not exceed an EIRP of -27 dBm/MHz. Devices operating in the 5.25-5.35 GHz band that generate emissions in the 5.15-5.25 GHz band must meet all applicable technical requirements for operation in the 5.15-5.25 GHz band (including indoor use) or alternatively meet an out-of-band emission EIRP limit of -27 dBm/MHz in the 5.15-5.25 GHz band.
<b>Results:</b>	See Data Sheet
<b>Note:</b>	Conducted Emissions Measurements were performed on the EUT with power supply set at the following voltage and frequency. <ul style="list-style-type: none"><li>• 120VAC / 60 Hz.</li></ul>

<b>Unwanted Spurious Emissions Limits</b>	
<b>Frequency (MHz)</b>	<b>Field Strength (dBm/Hz) (Emissions outside the restricted bands)</b>
5250-5350	EIRP < -27dBm/Hz (68.3dBuV/m)



Conducted Band Edge Emissions Test Results (Continued)

<b>CONDCUTED BAND EDGE EMISSIONS TEST RESULTS</b>							
<i>Freq.(MHz)</i>	<i>TX Chain</i>	<i>Power Spec Den. Reading (dBm/MHz)</i>	<i>Antenna Gain (dBi)</i>	<i>Corrected Reading (dBm/MHz)</i>	<i>Limits (dBm/MHz)</i>	<i>Diff (dB) +=FAIL</i>	<i>Comments</i>
<b>802.11a</b>							
5250.00	A	-34.72	2.57	-32.15	-27.00	-5.15	Tx @ 5240 MHz
5250.00	A	-33.73	2.57	-31.16	-27.00	-4.16	Tx @ 5260 MHz
5250.00	B	-33.06	2.57	-30.49	-27.00	-3.49	Tx @ 5240 MHz
5250.00	B	-35.17	2.57	-32.60	-27.00	-5.60	Tx @ 5260 MHz
<b>802.11n (20MHz Wide)</b>							
5250.00	A	-32.51	2.57	-29.94	-27.00	-2.94	Tx @ 5240 MHz
5250.00	A	-33.67	2.57	-31.10	-27.00	-4.10	Tx @ 5260 MHz
5250.00	B	-33.73	2.57	-31.16	-27.00	-4.16	Tx @ 5240 MHz
5250.00	B	-33.25	2.57	-30.68	-27.00	-3.68	Tx @ 5260 MHz
<b>802.11n (40MHz Wide)</b>							
5250.00	A	-42.99	2.57	-40.42	-27.00	-13.42	Tx @ 5240 MHz
5250.00	A	-41.29	2.57	-38.72	-27.00	-11.72	Tx @ 5260 MHz
5250.00	B	-41.99	2.57	-39.42	-27.00	-12.42	Tx @ 5240 MHz
5250.00	B	-42.75	2.57	-40.18	-27.00	-13.18	Tx @ 5260 MHz

Conducted Band Edge Emissions Test Results (Continued)

802.11a Mode – Chain A

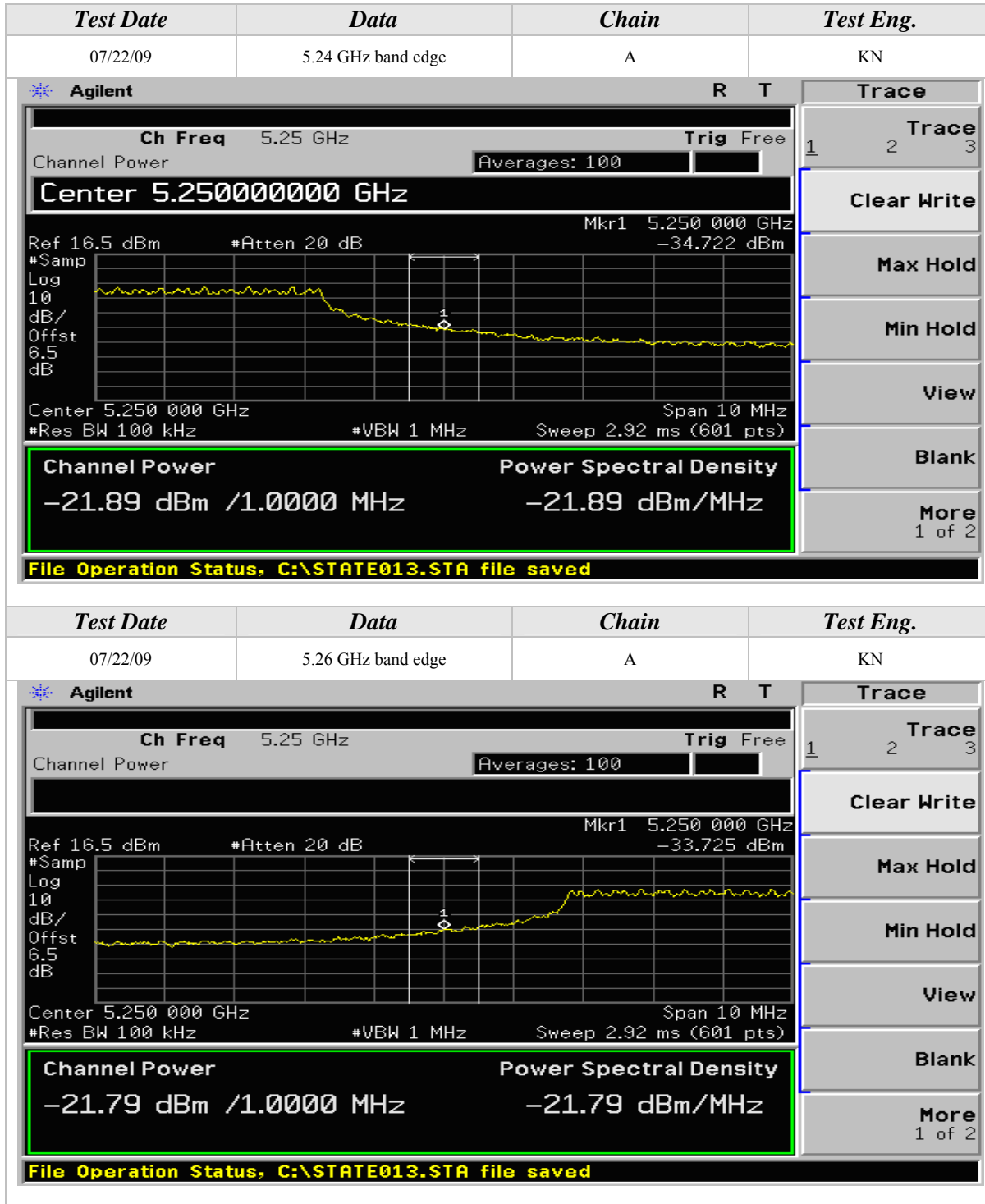

Conducted Band Edge Emissions Test Results (Continued)

802.11a Mode – Chain B

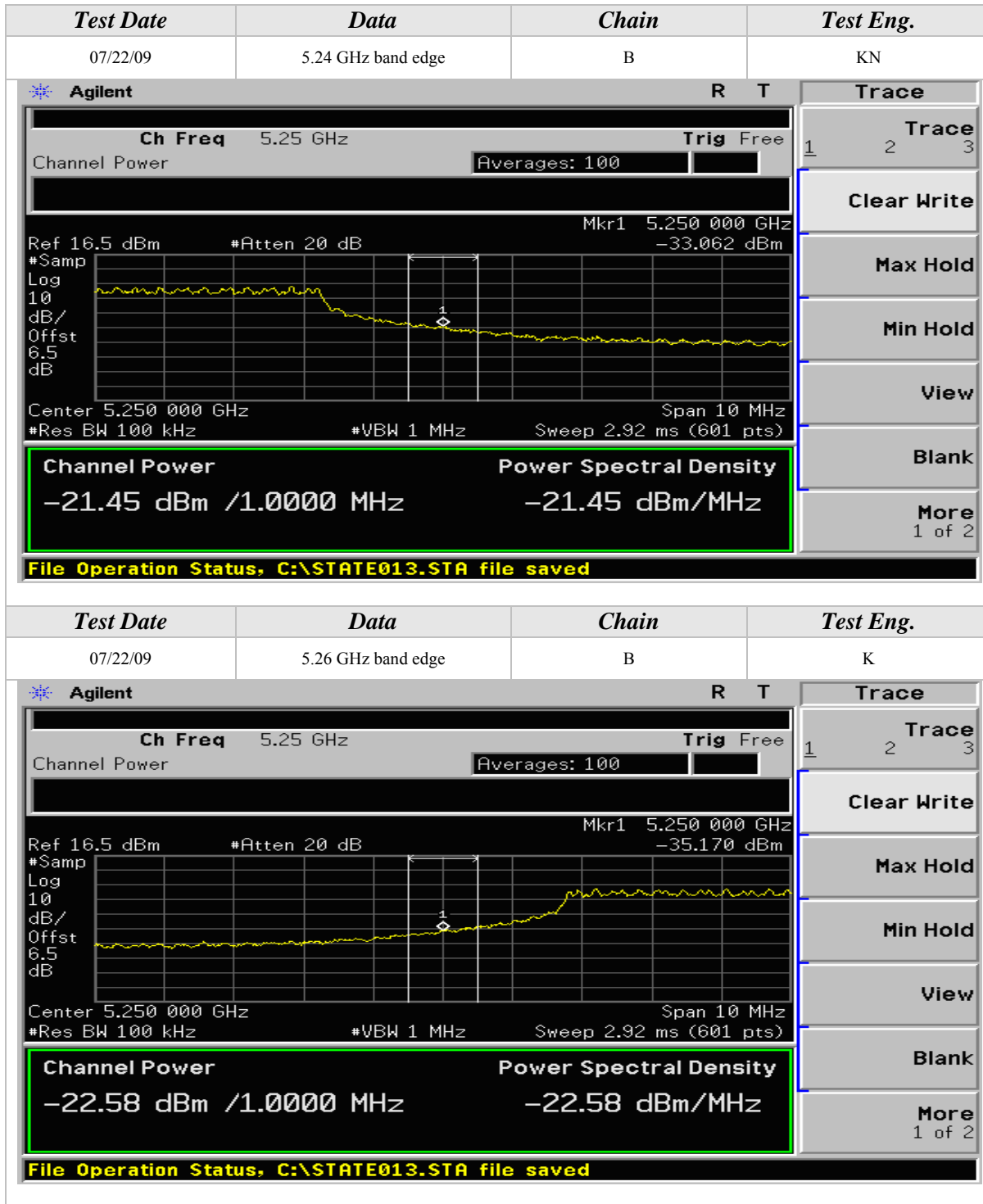

Conducted Band Edge Emissions Test Results (Continued)

802.11n Mode (20 MHz Wide)



Conducted Band Edge Emissions Test Results (Continued)

802.11n Mode (20 MHz Wide)

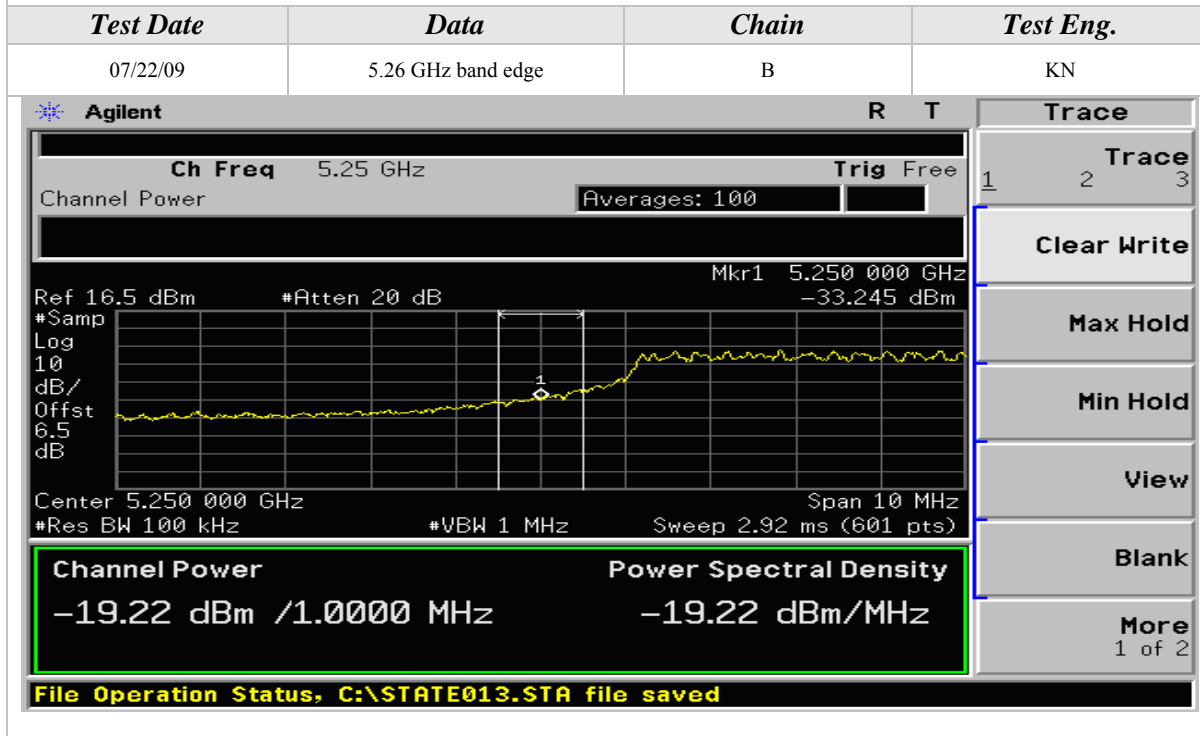
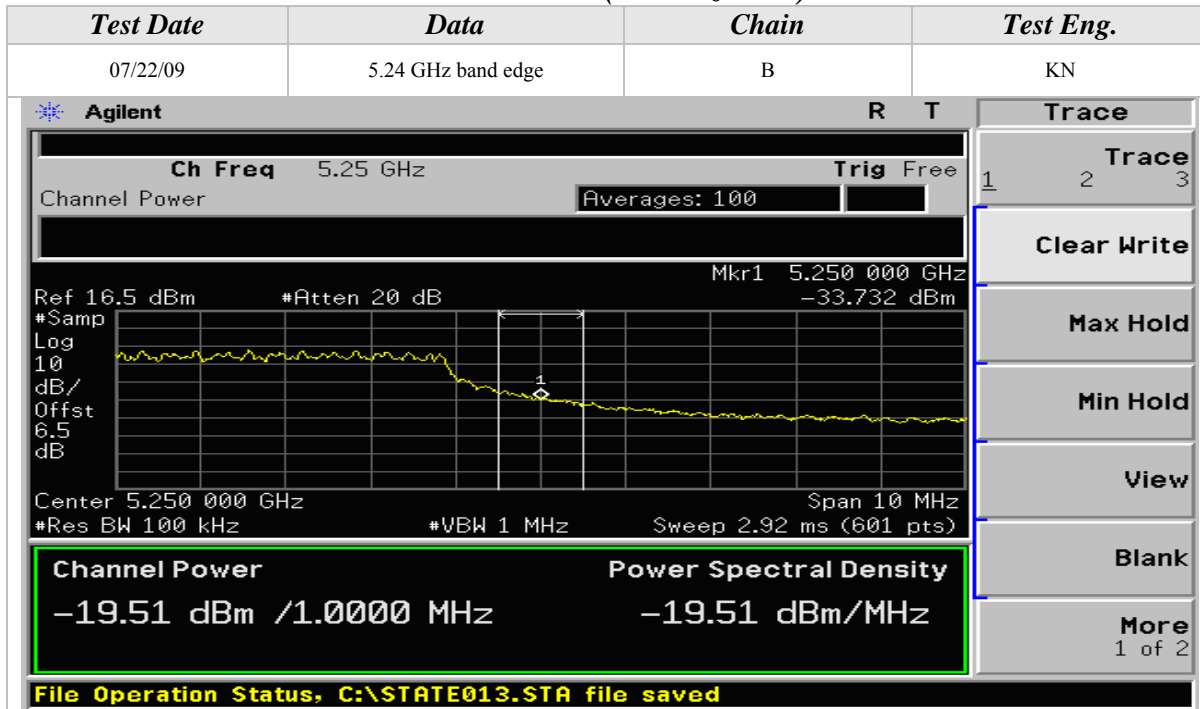

Conducted Band Edge Emissions Test Results (Continued)

802.11n Mode (40 MHz Wide)

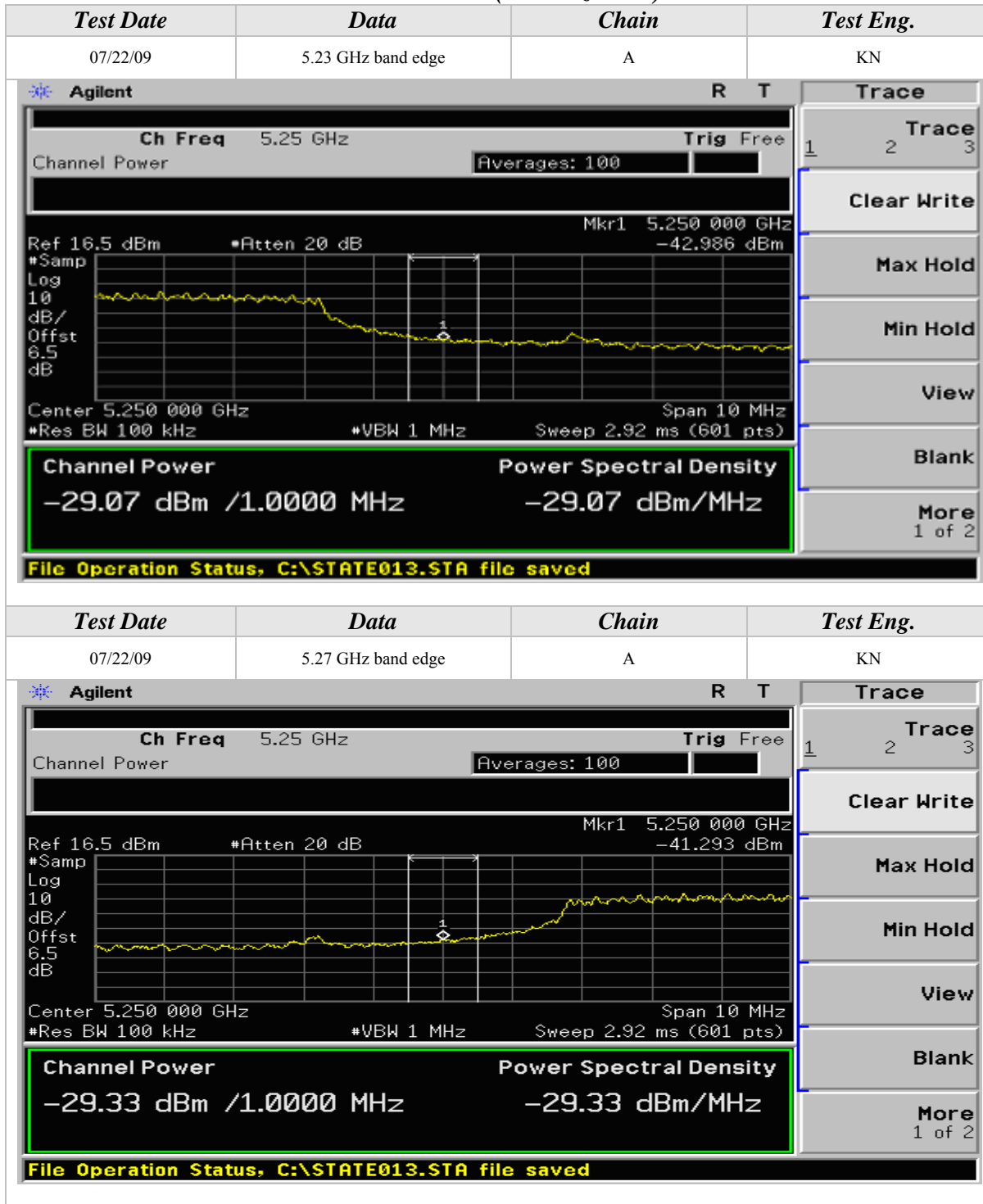



Conducted Band Edge Emissions Test Results (Continued)

802.11n Mode (40 MHz Wide)



**26dB EMISSIONS BANDWIDTH**

<b>CLIENT:</b>	Intel Corporation	<b>DATE:</b>	08/10/09
<b>EUT:</b>	Intel WiFi Link 6200	<b>PROJECT NUMBER:</b>	INTEL-090601
<b>MODEL NUMBER:</b>	622ANHMW	<b>TEST ENGINEER:</b>	JC
<b>SERIAL NUMBER:</b>	0015005A70A4	<b>SITE #:</b>	2
<b>CONFIGURATION:</b>	Tested installed in an extender board connected to the host laptop's mini PCI slot	<b>TEMPERATURE:</b>	25 deg. C
		<b>HUMIDITY:</b>	36% RH
		<b>TIME:</b>	1:50 PM

<b>Description:</b>	26dB emissions bandwidth in MHz.
<b>Results:</b>	See Data Sheet
<b>Note:</b>	Conducted Emissions Measurements were performed on the EUT with power supply set at the following voltage and frequency. <ul style="list-style-type: none"><li>• 120VAC / 60 Hz.</li></ul>

26dB Emissions Bandwidth (Continued)

802.11a Mode

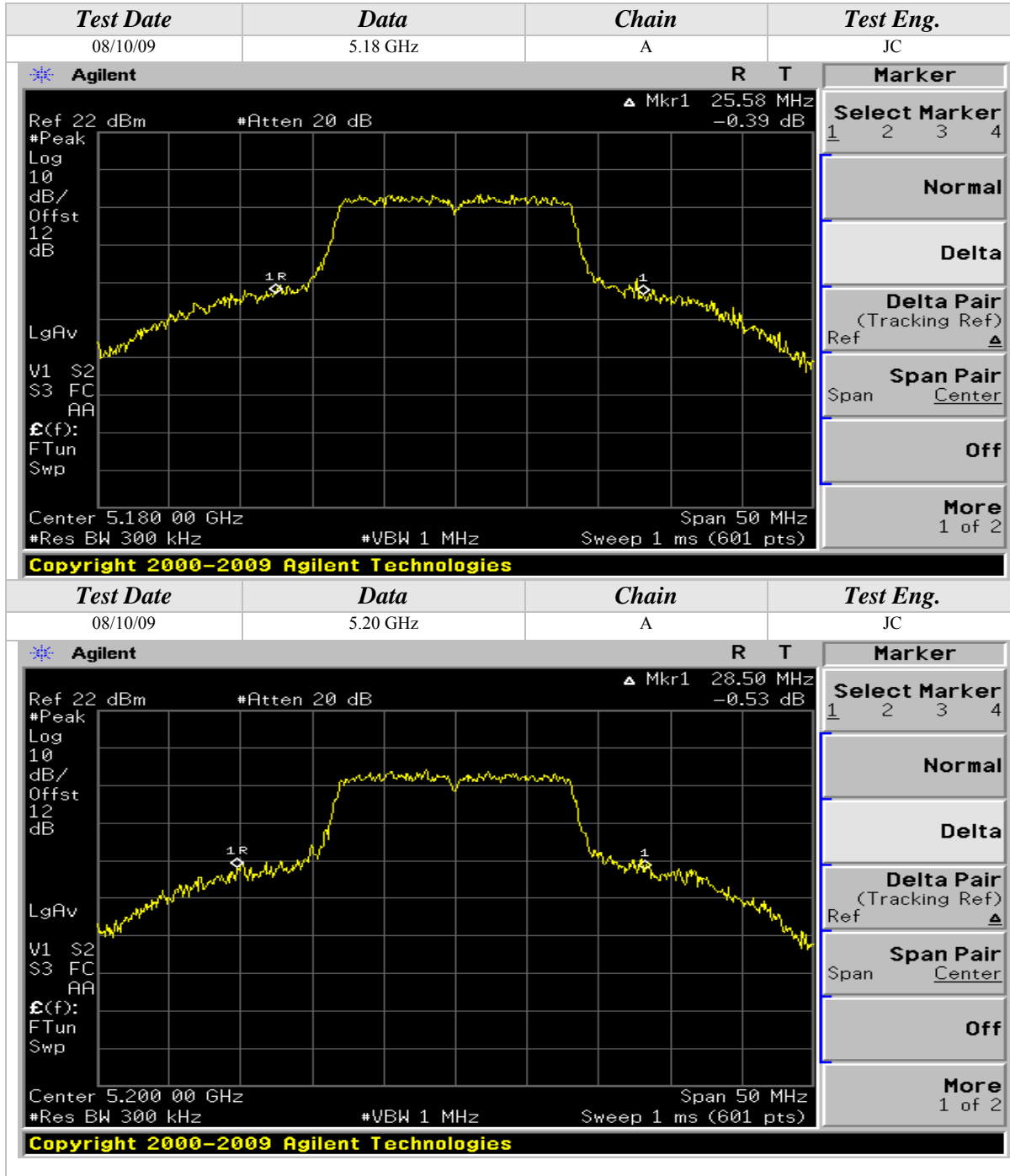

26dB Emissions Bandwidth (Continued)

802.11a Mode

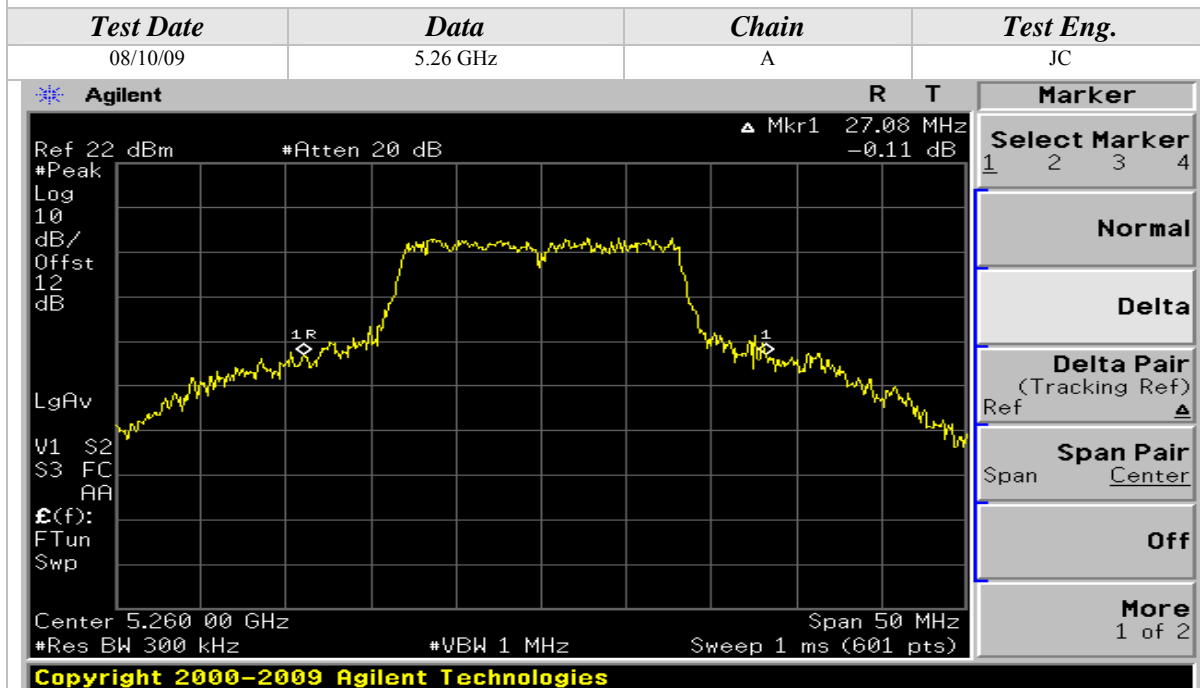
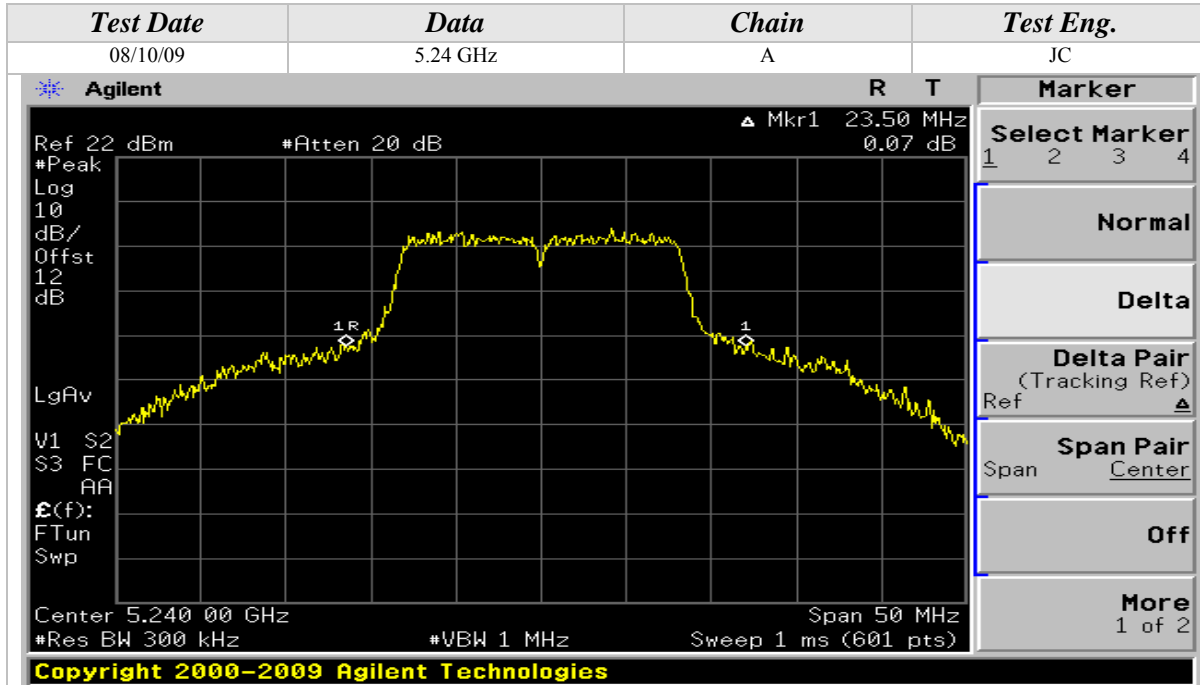

26dB Emissions Bandwidth (Continued)

802.11a Mode

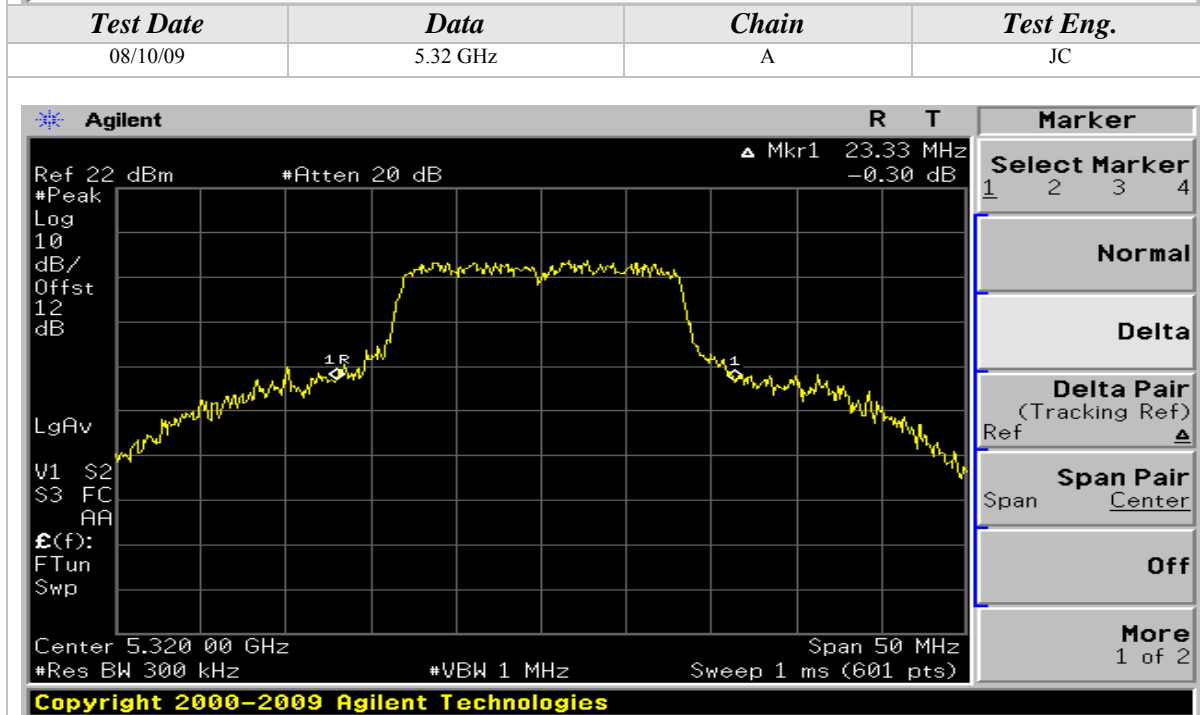
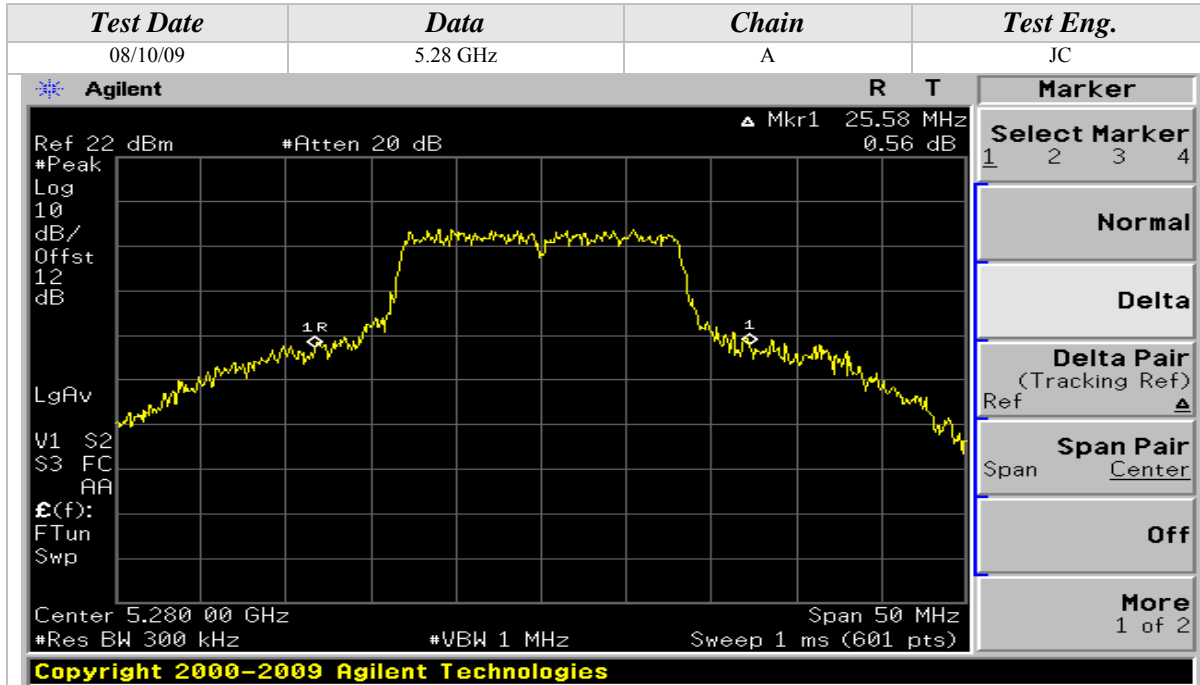

26dB Emissions Bandwidth (Continued)

802.11a Mode

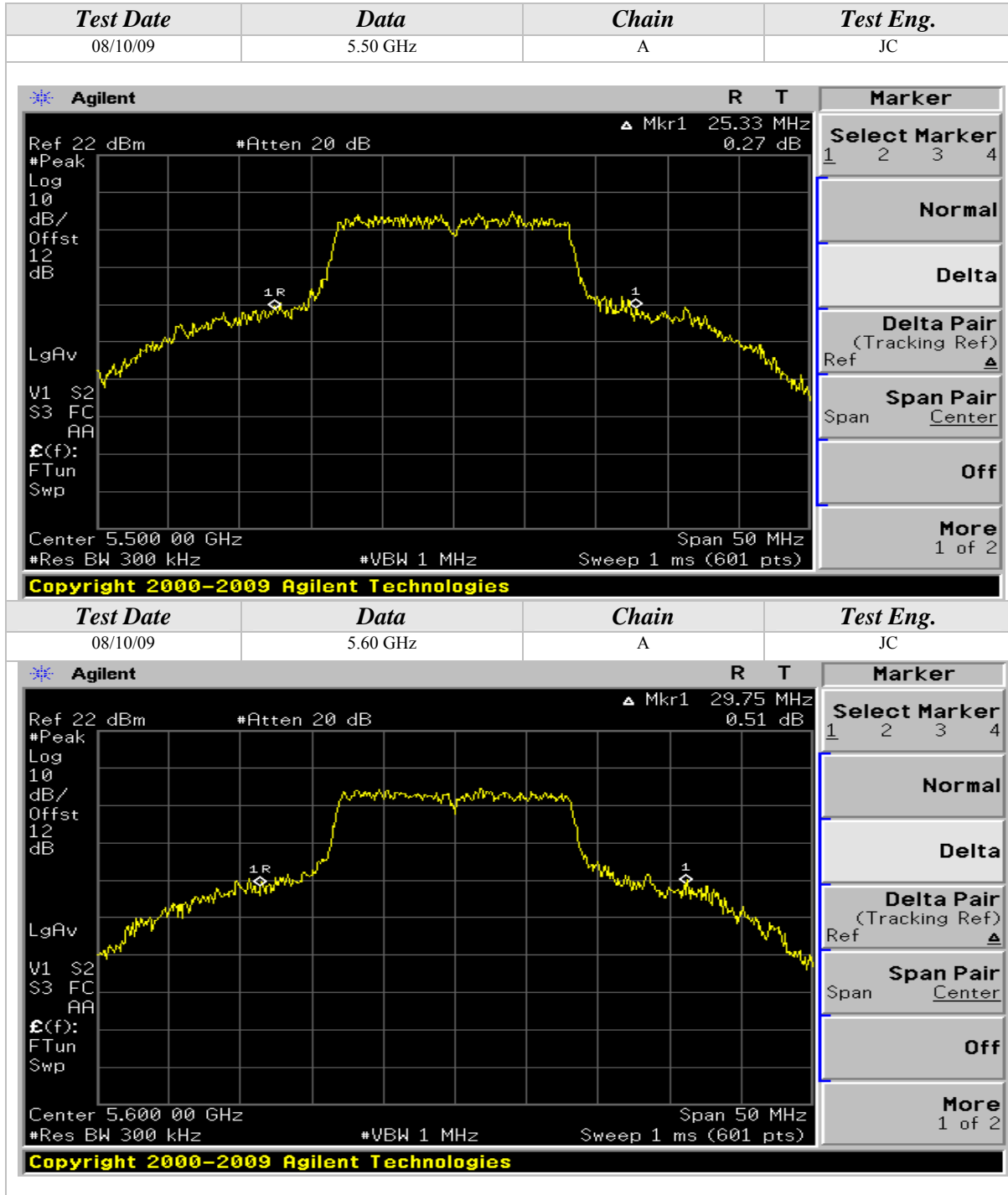

26dB Emissions Bandwidth (Continued)

802.11a Mode

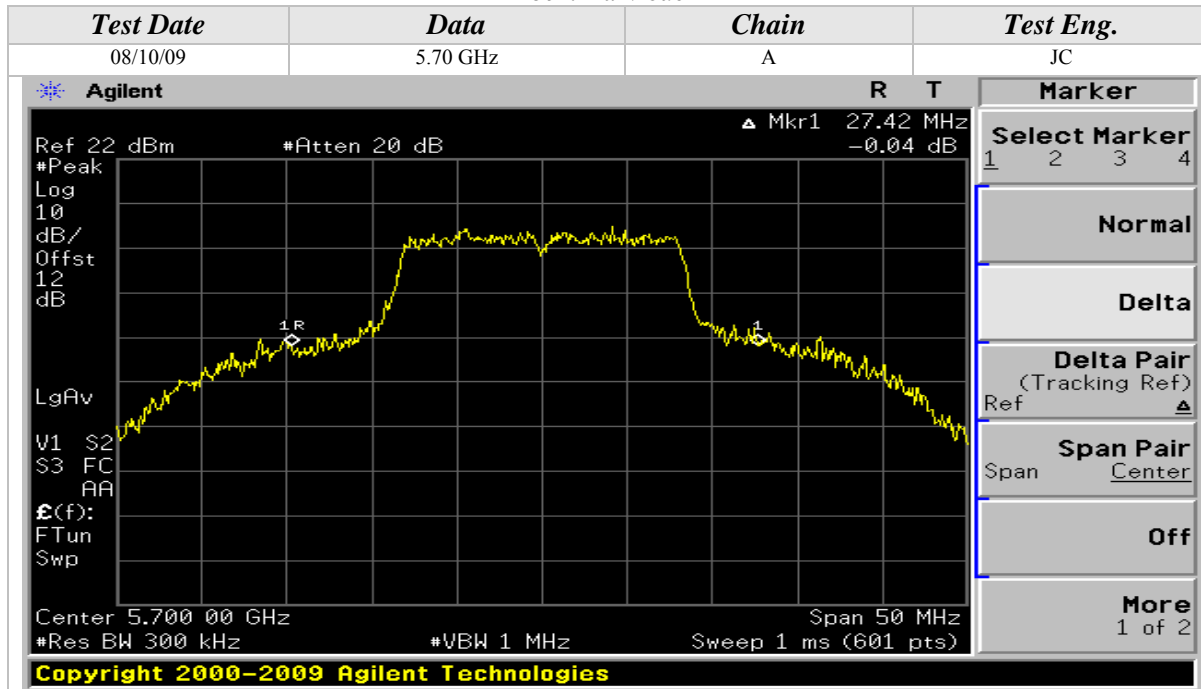

26dB Emissions Bandwidth (Continued)

802.11n Mode, 5GHz, 20MHz Wide

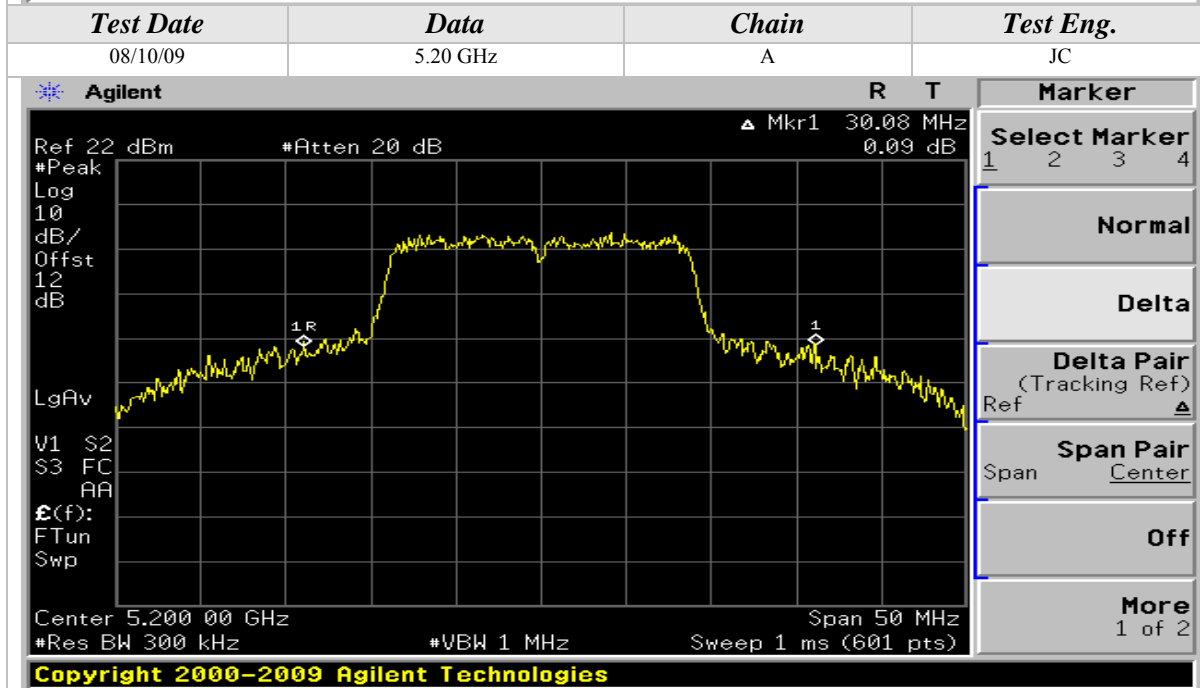
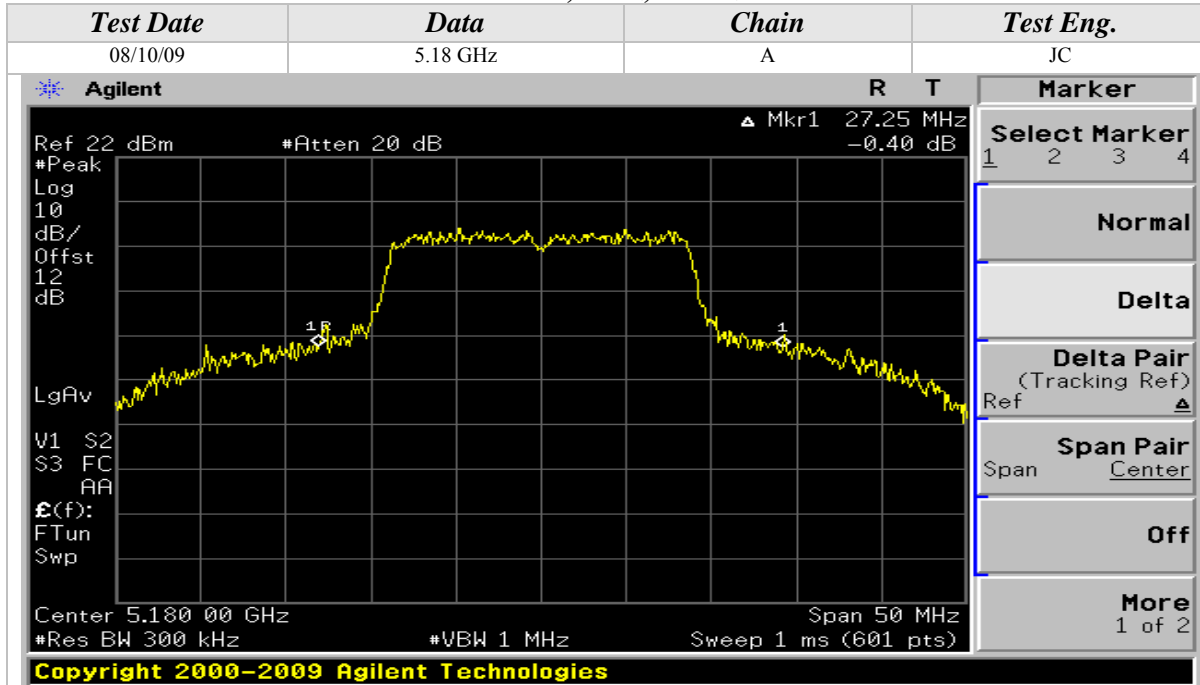



26dB Emissions Bandwidth (Continued)

802.11n Mode, 5GHz, 20MHz Wide

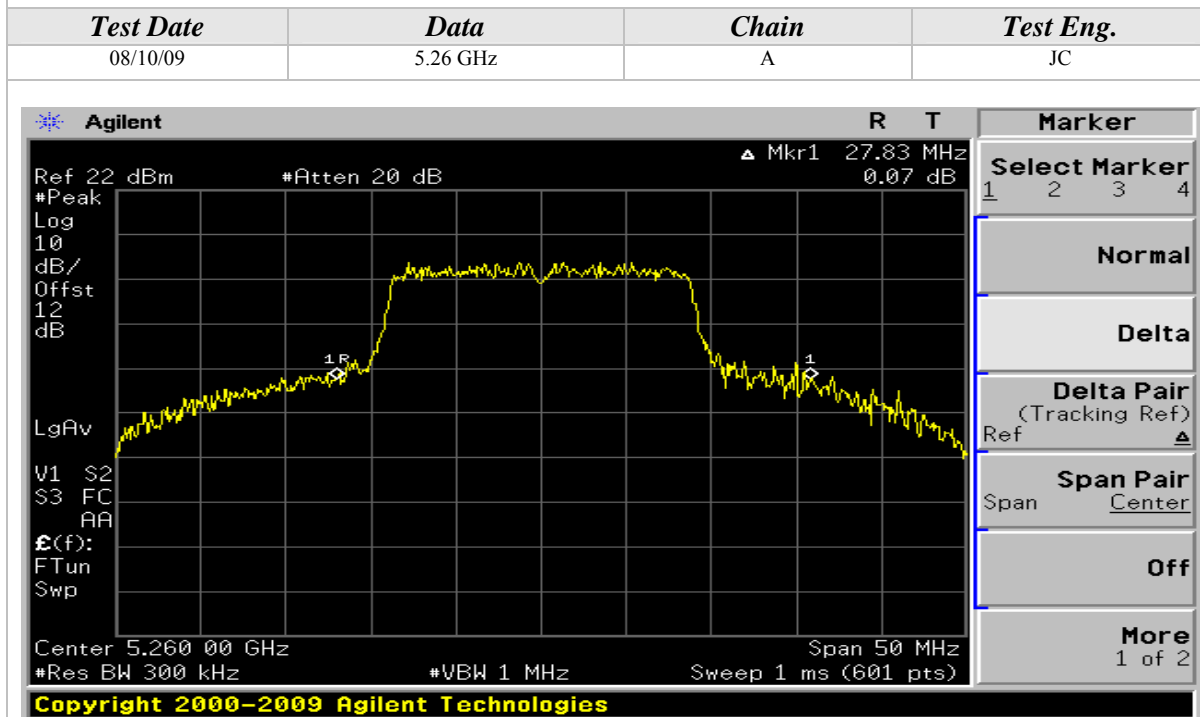
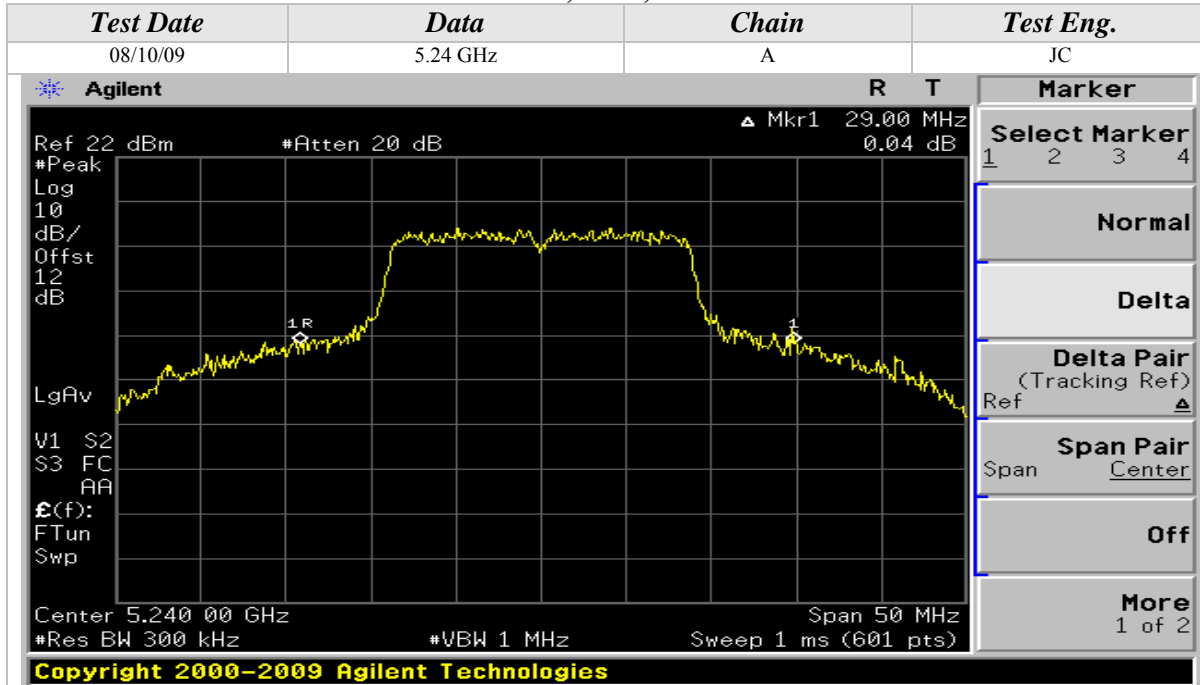

26dB Emissions Bandwidth (Continued)

802.11n Mode, 5GHz, 20MHz Wide

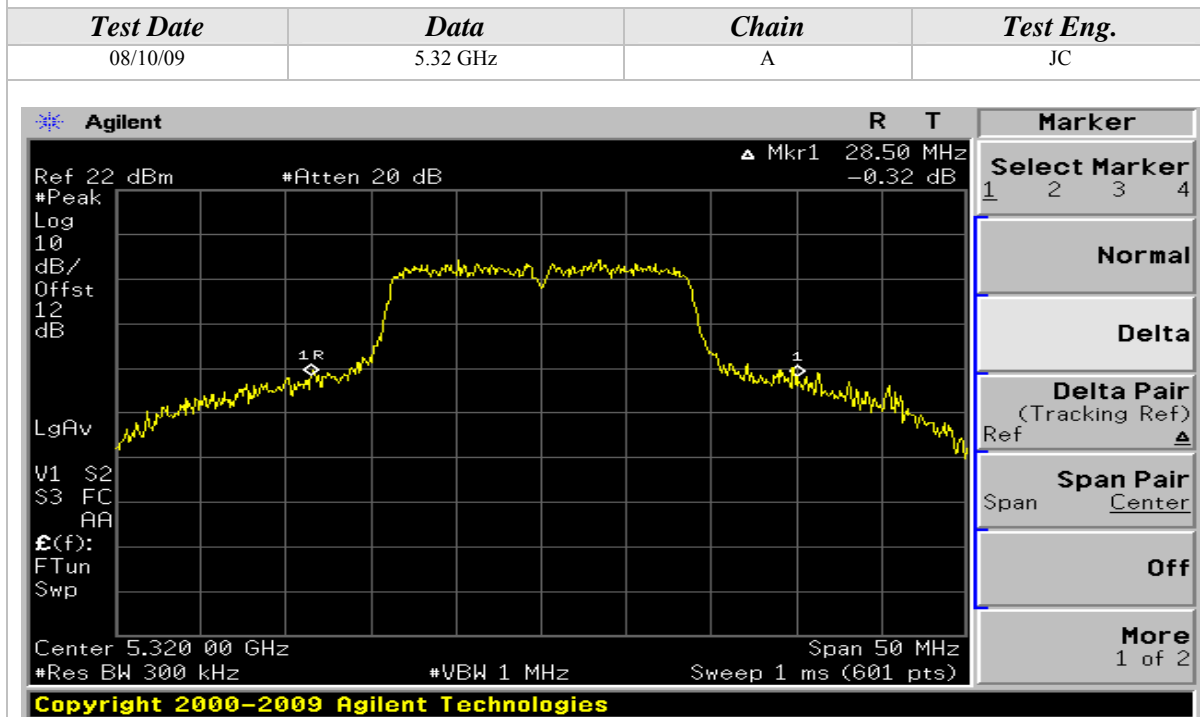
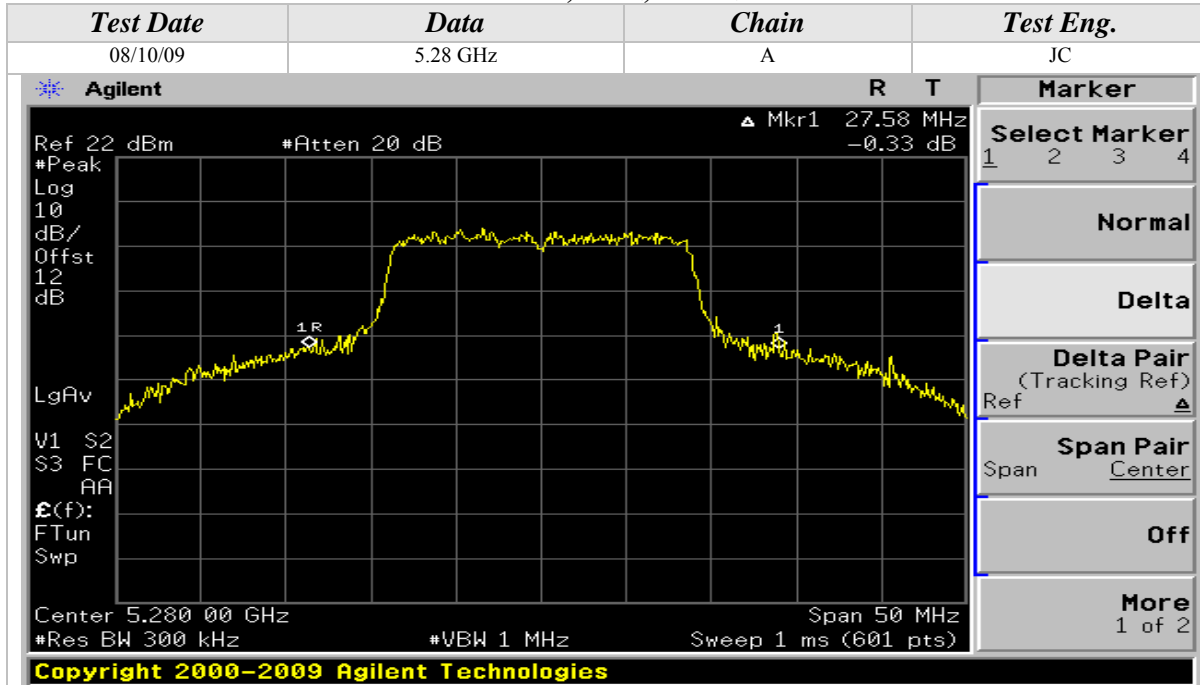

26dB Emissions Bandwidth (Continued)

802.11n Mode, 5GHz, 20MHz Wide

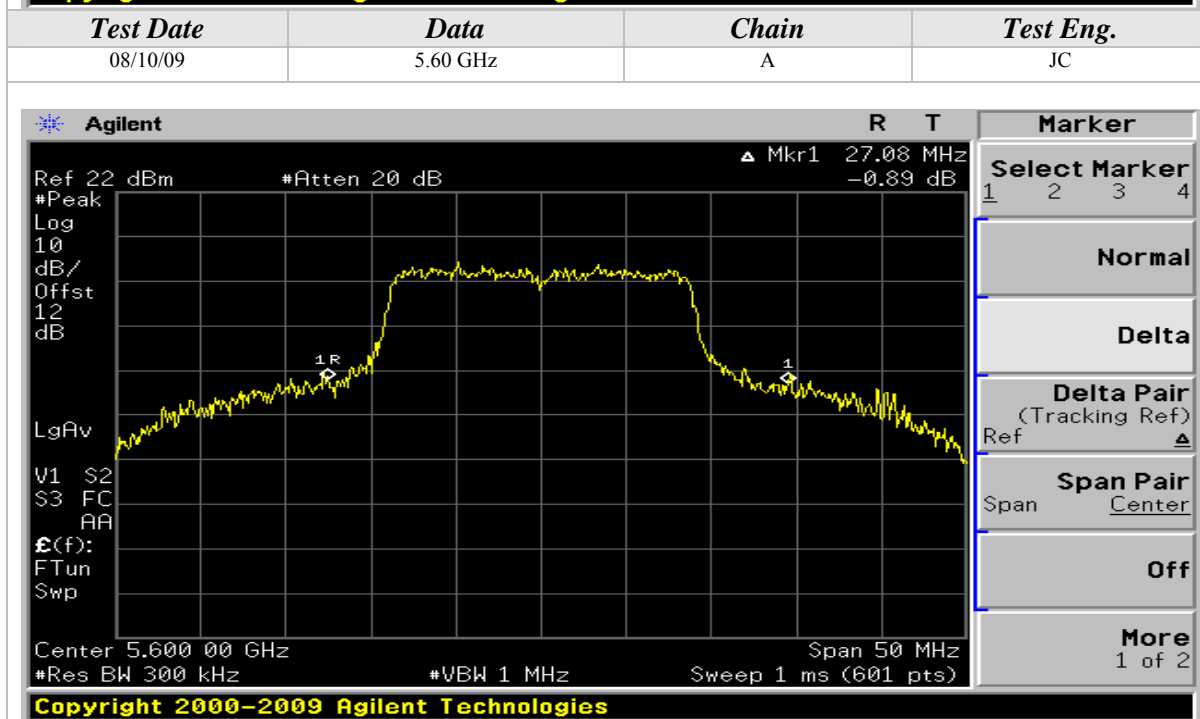

26dB Emissions Bandwidth (Continued)

802.11n Mode, 5GHz, 20MHz Wide

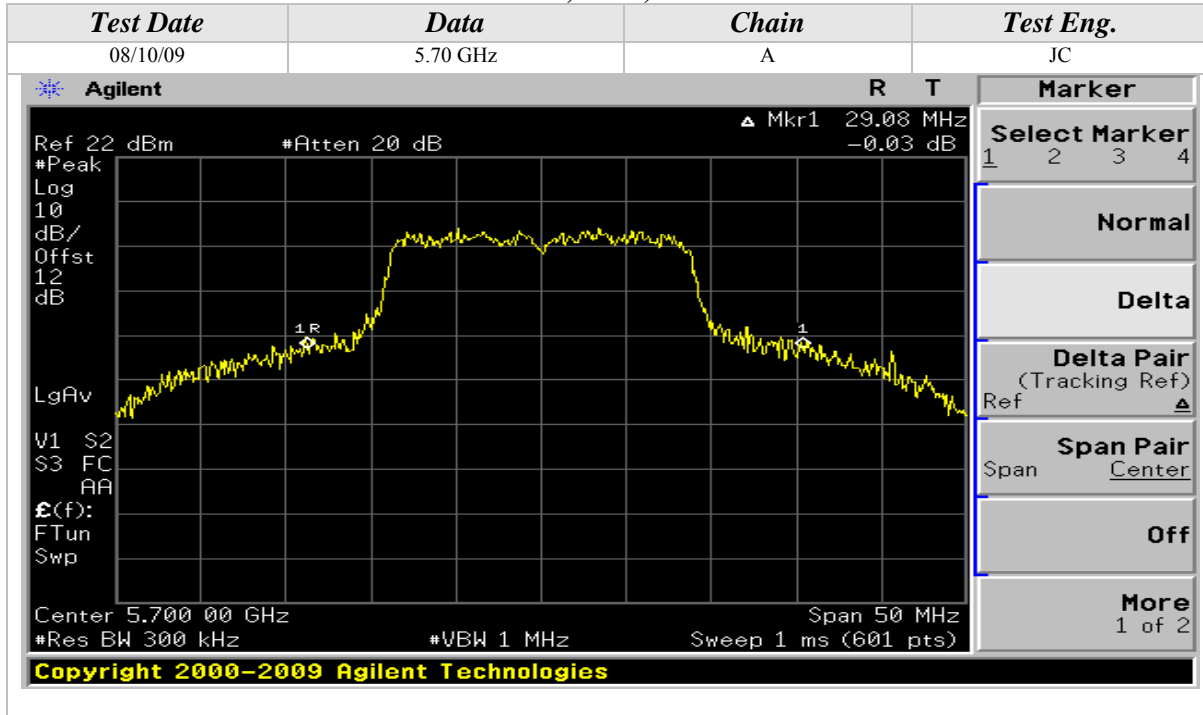

26dB Emissions Bandwidth (Continued)

802.11n Mode, 5GHz, 40MHz Wide

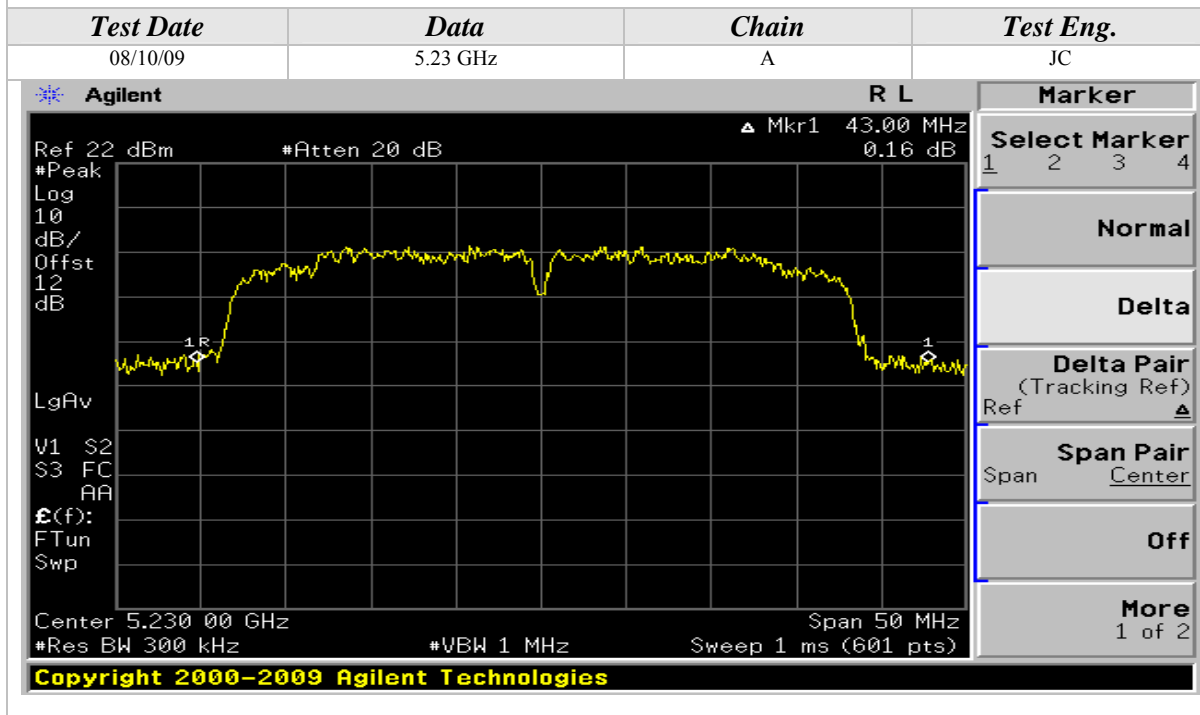
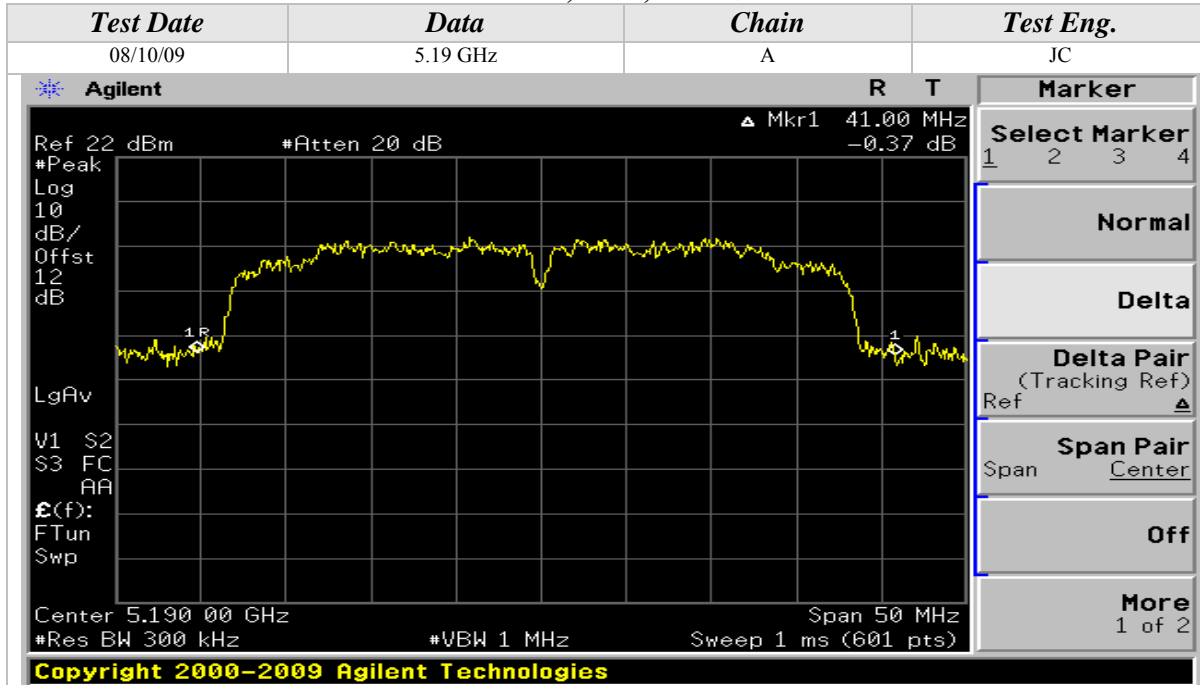

26dB Emissions Bandwidth (Continued)

802.11n Mode, 5GHz, 40MHz Wide

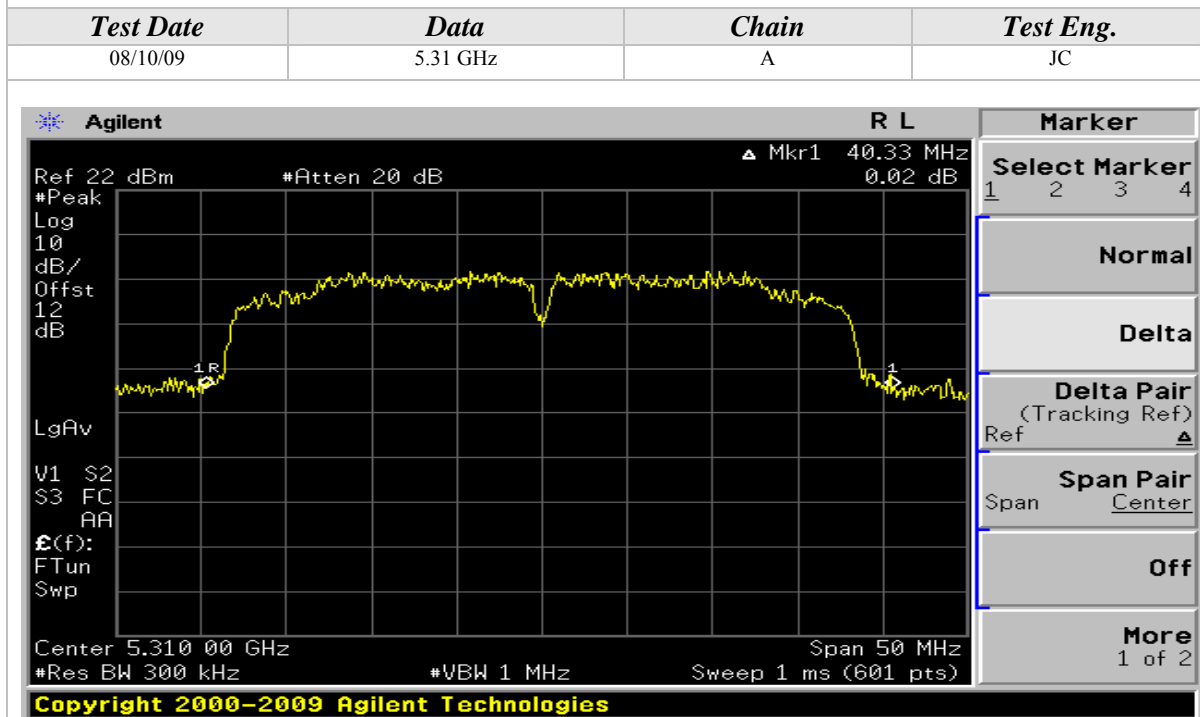
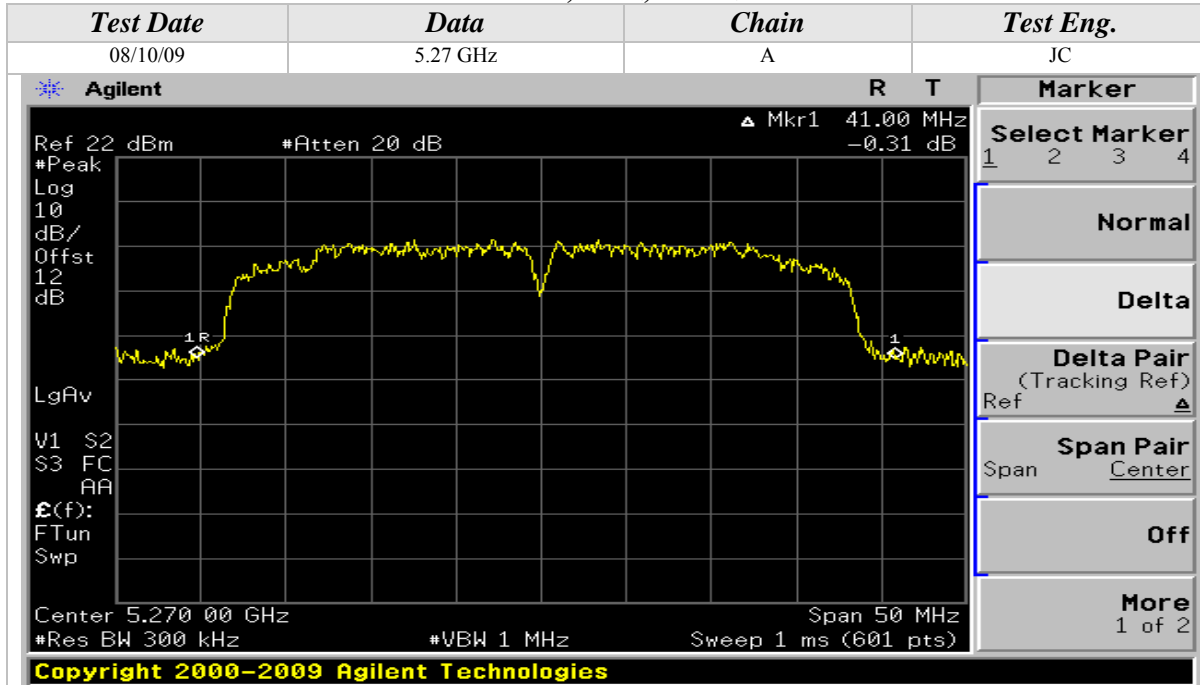

26dB Emissions Bandwidth (Continued)

802.11n Mode, 5GHz, 40MHz Wide

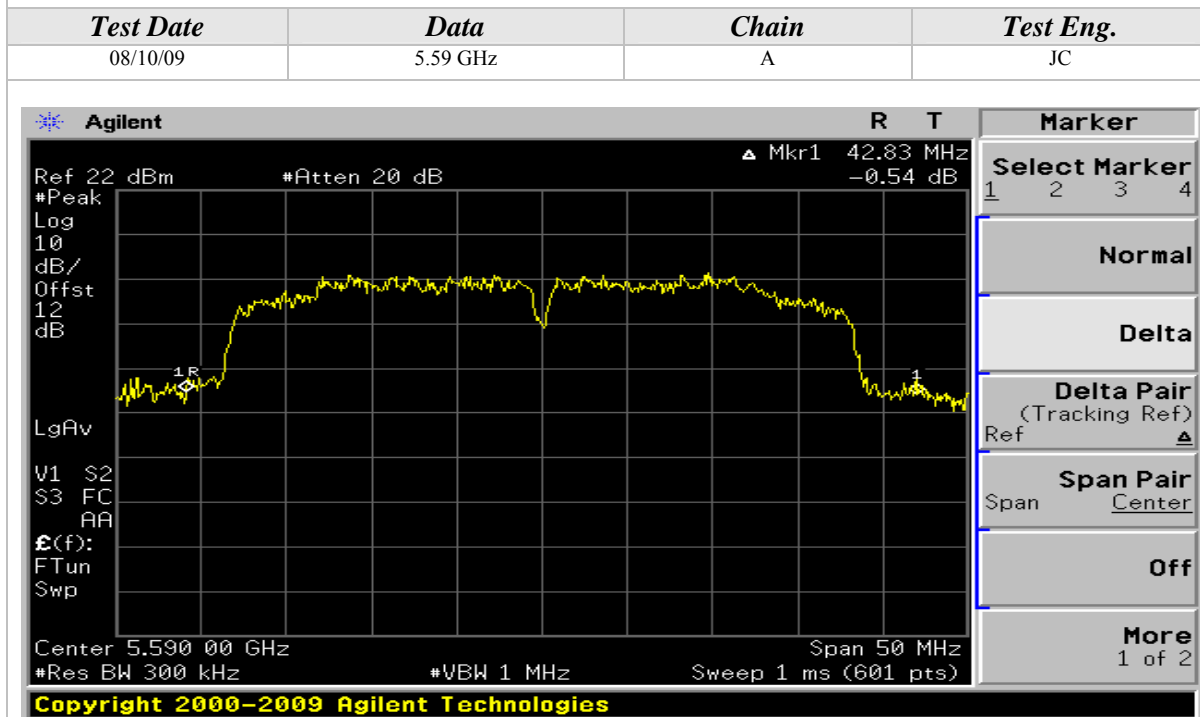
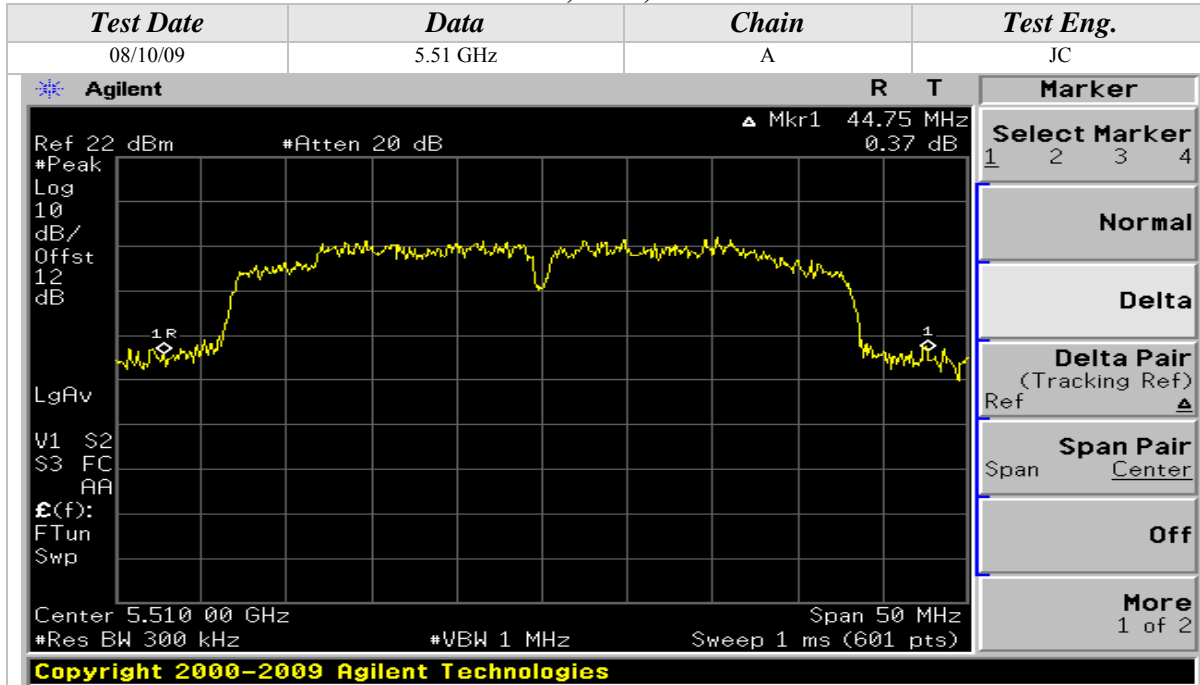

26dB Emissions Bandwidth (Continued)

802.11n Mode, 5GHz, 40MHz Wide

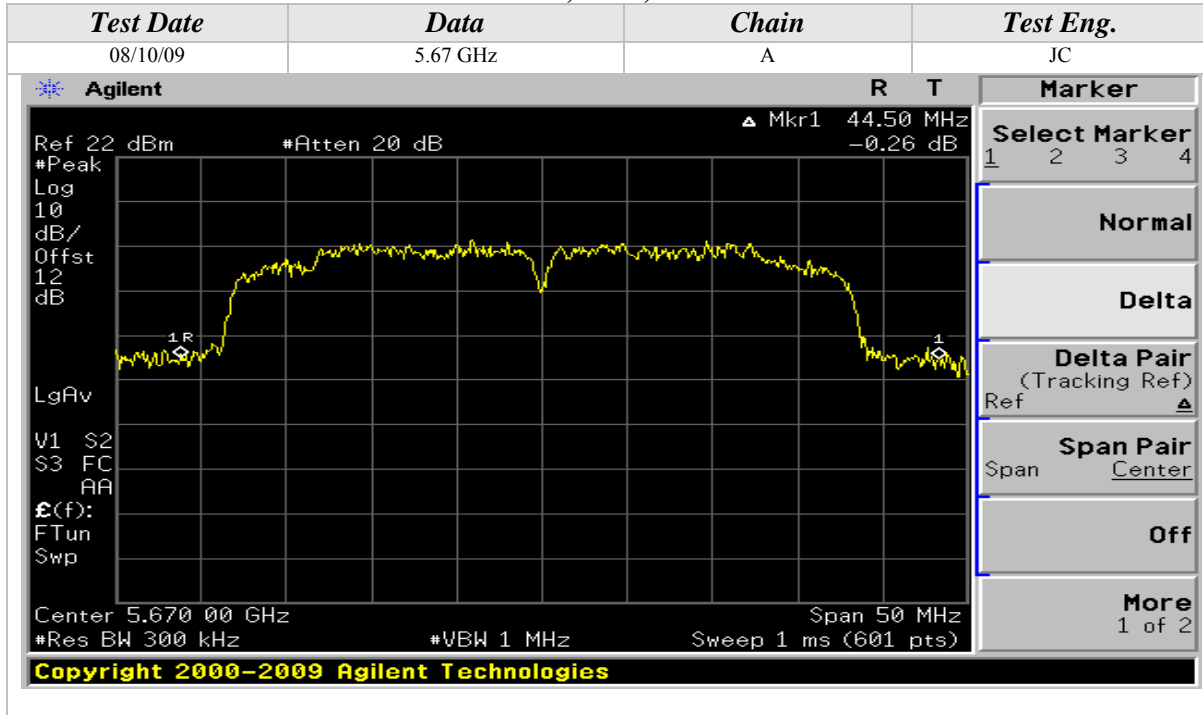



26dB Emissions Bandwidth (Continued)

802.11a Mode

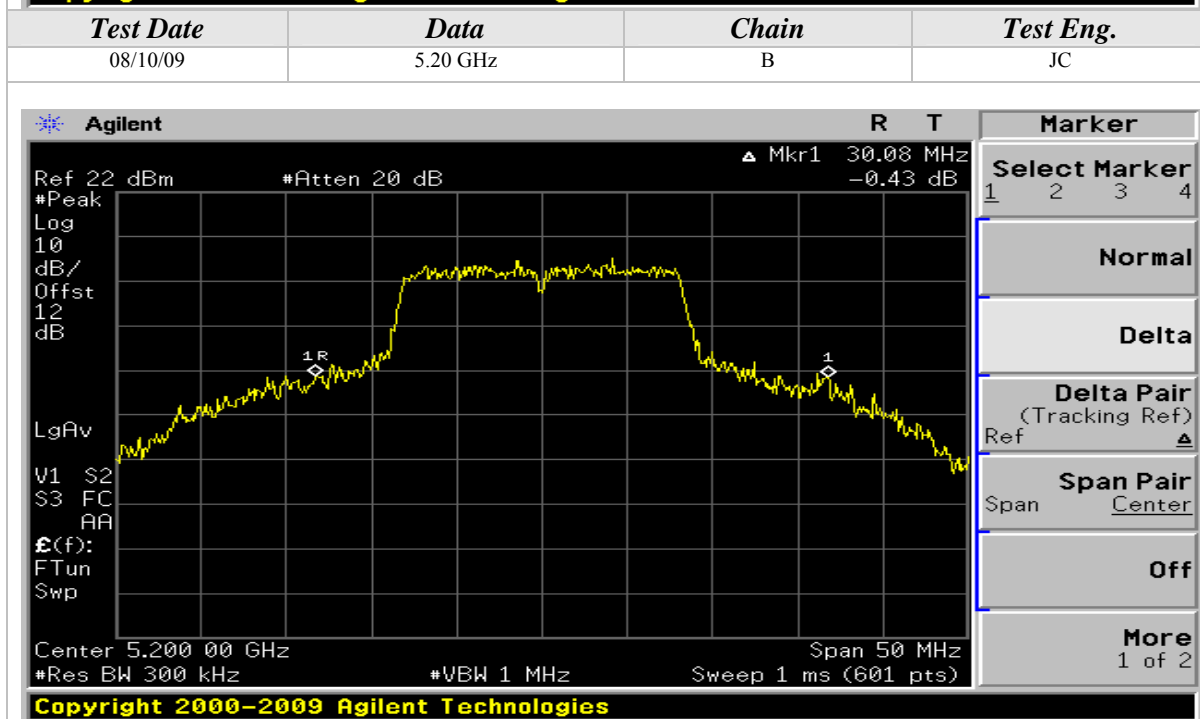
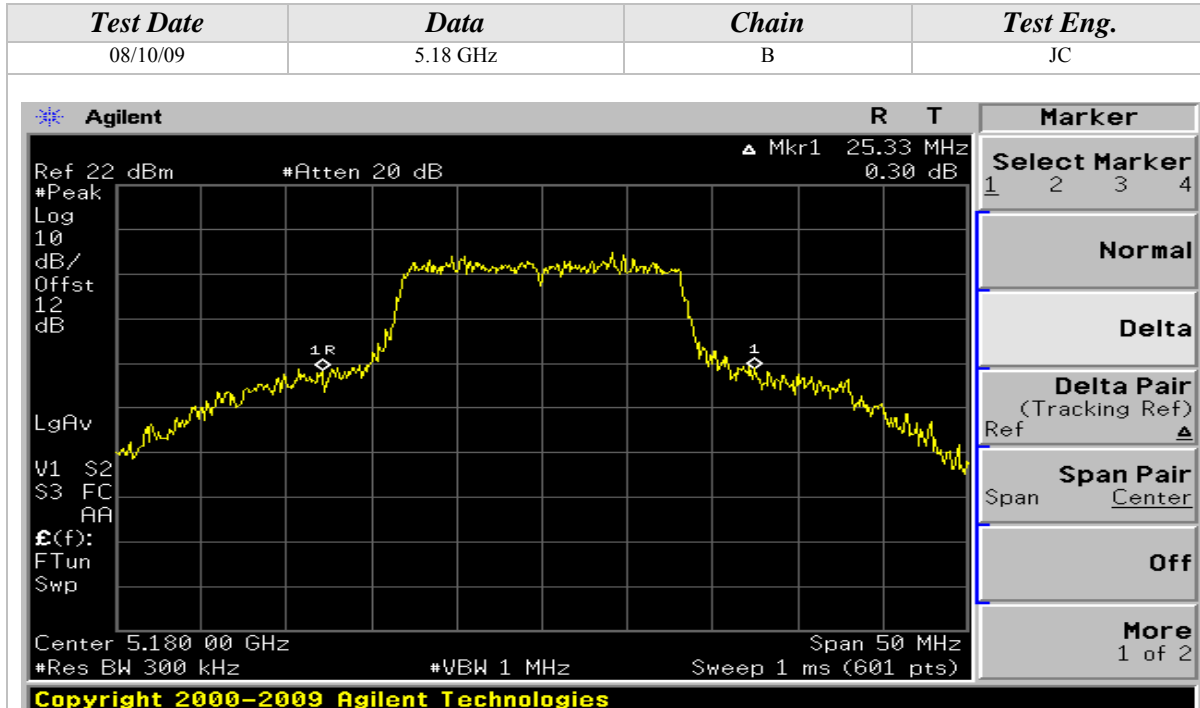

26dB Emissions Bandwidth (Continued)

802.11a Mode

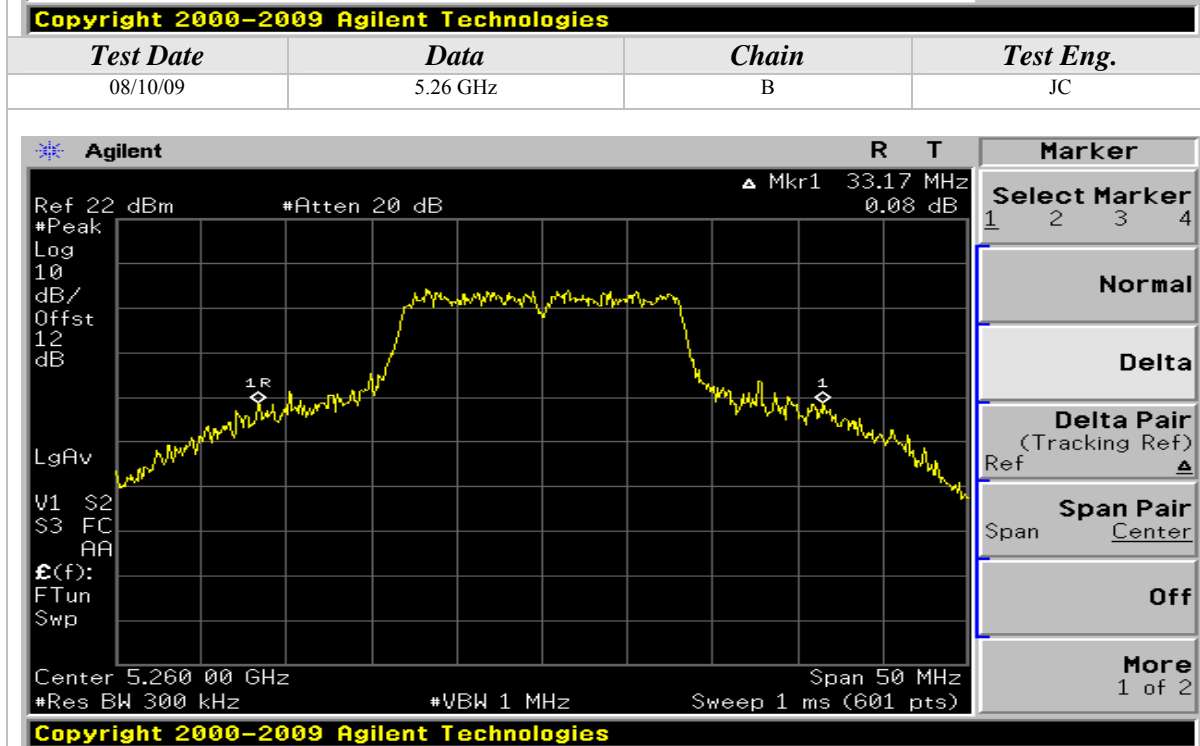
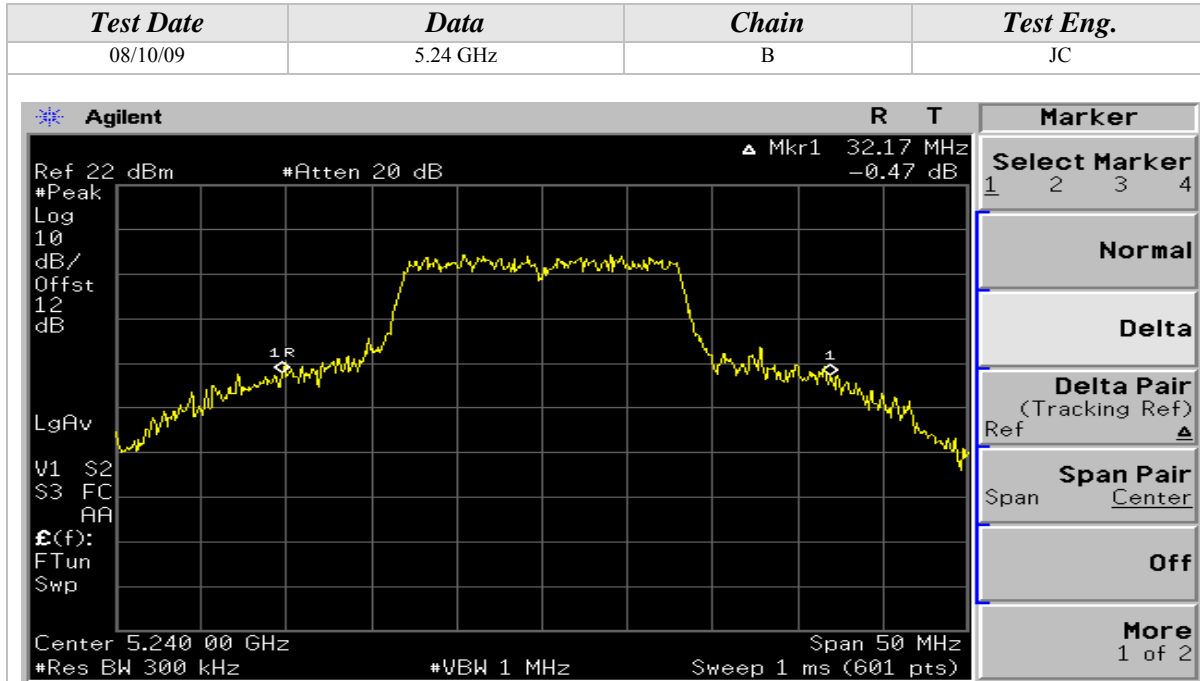

26dB Emissions Bandwidth (Continued)

802.11a Mode

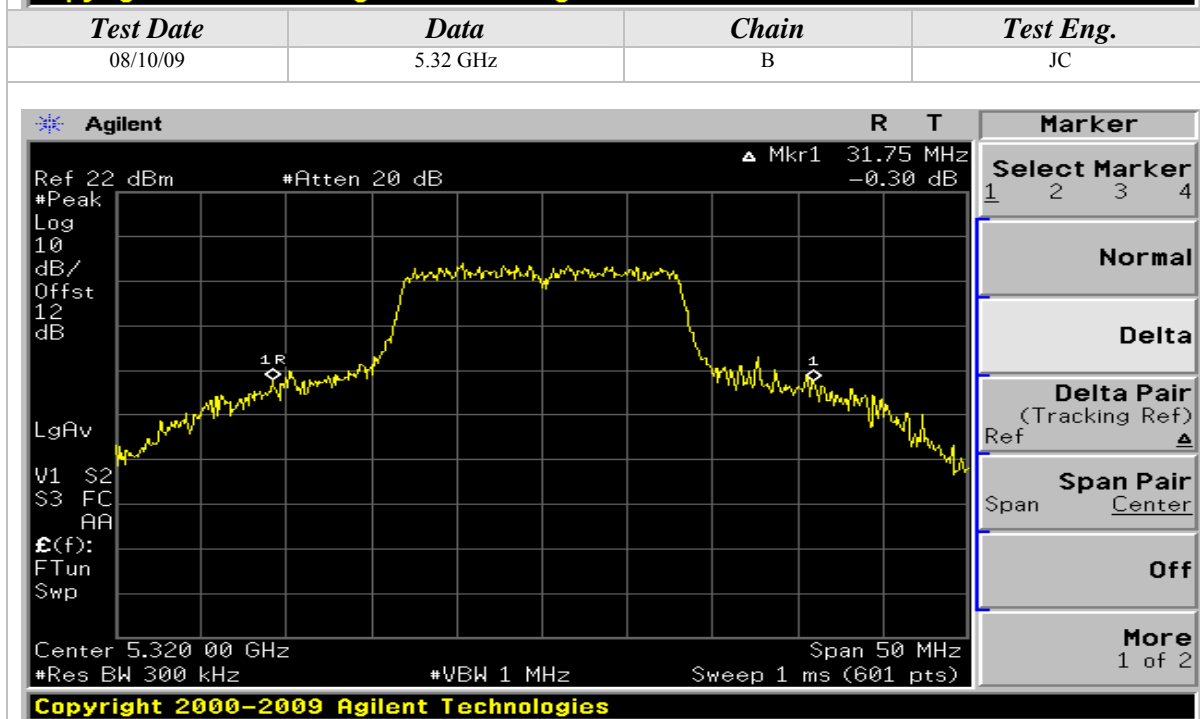
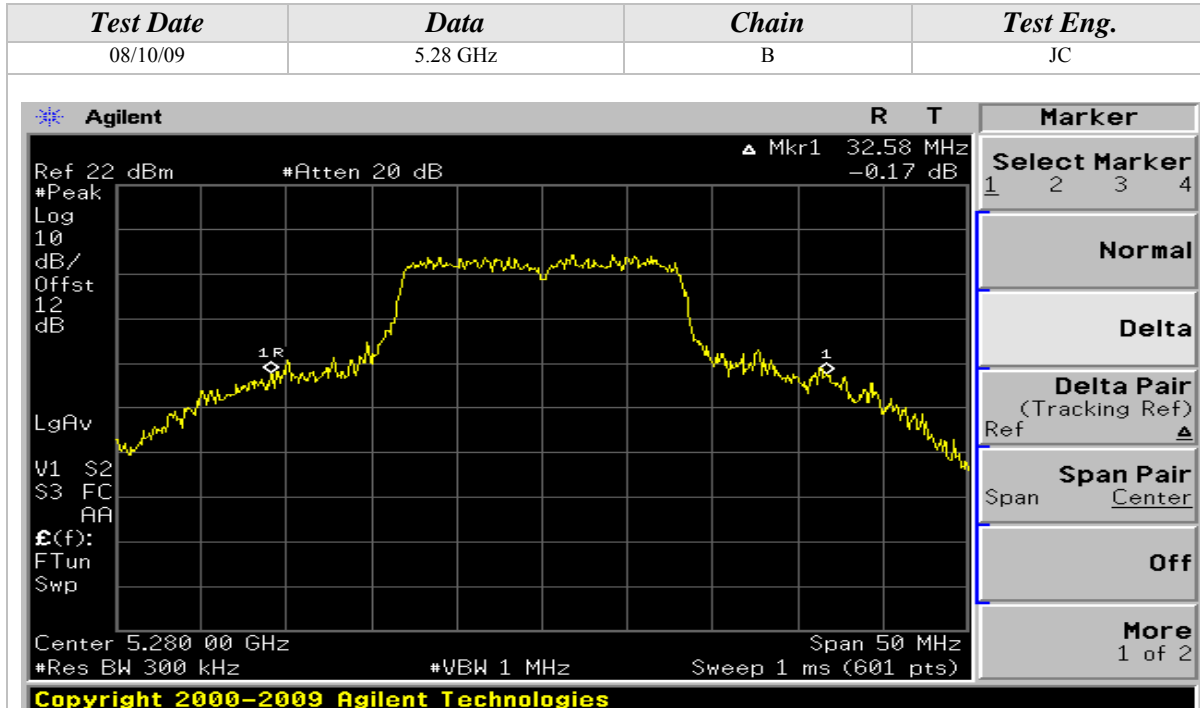

26dB Emissions Bandwidth (Continued)

802.11a Mode

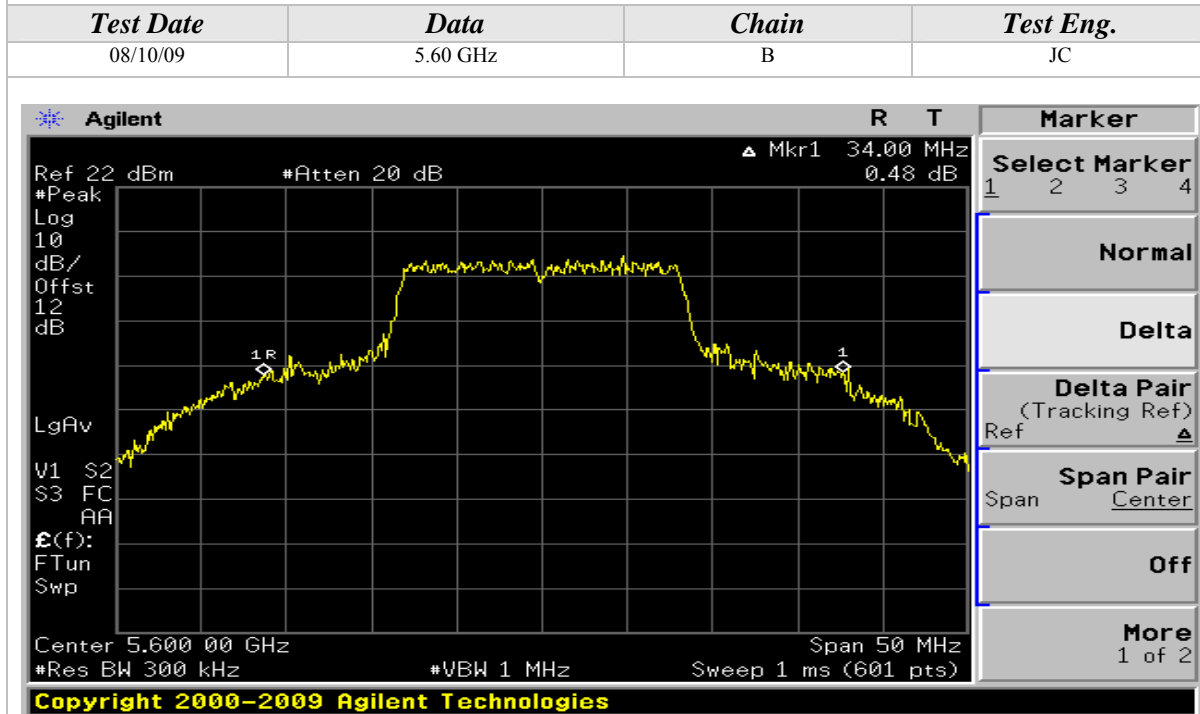
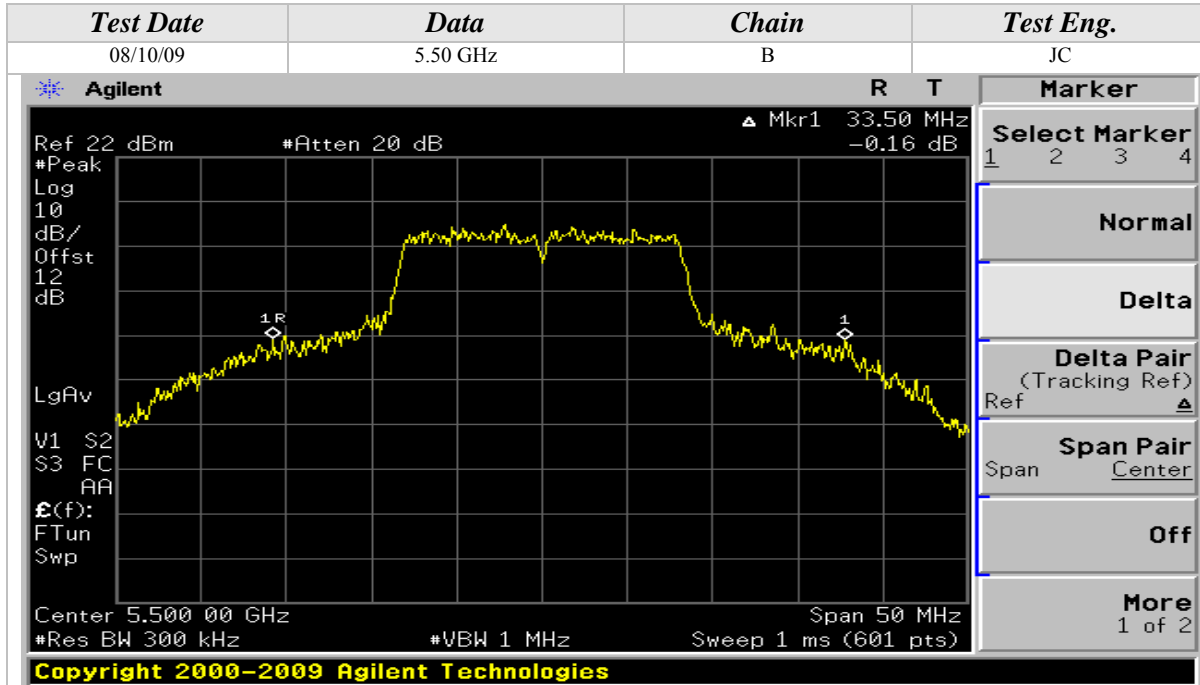

26dB Emissions Bandwidth (Continued)

802.11a Mode



26dB Emissions Bandwidth (Continued)

802.11n Mode, 5GHz, 20MHz Wide

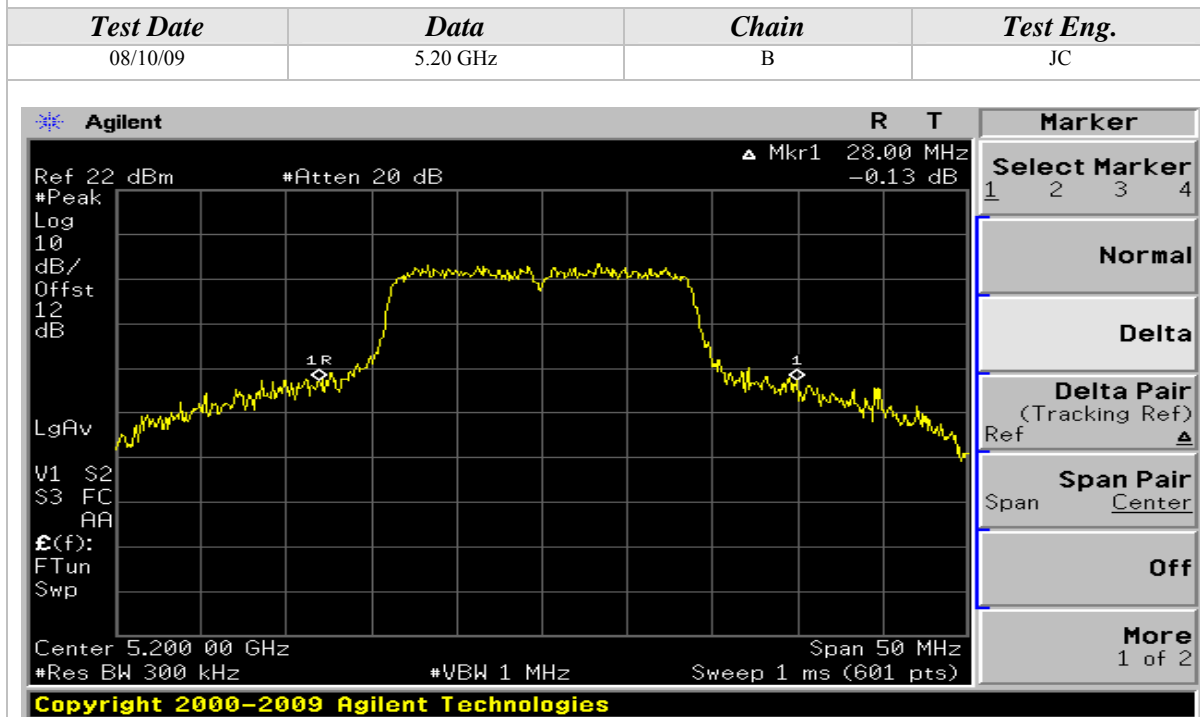
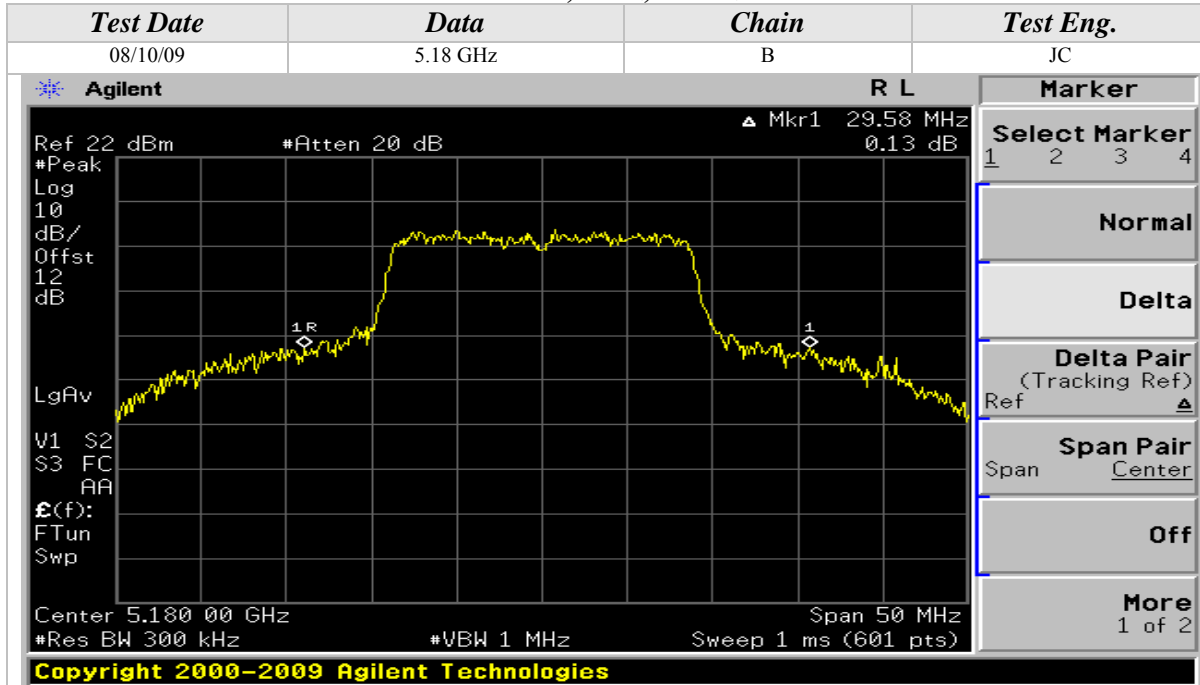

26dB Emissions Bandwidth (Continued)

802.11n Mode, 5GHz, 20MHz Wide

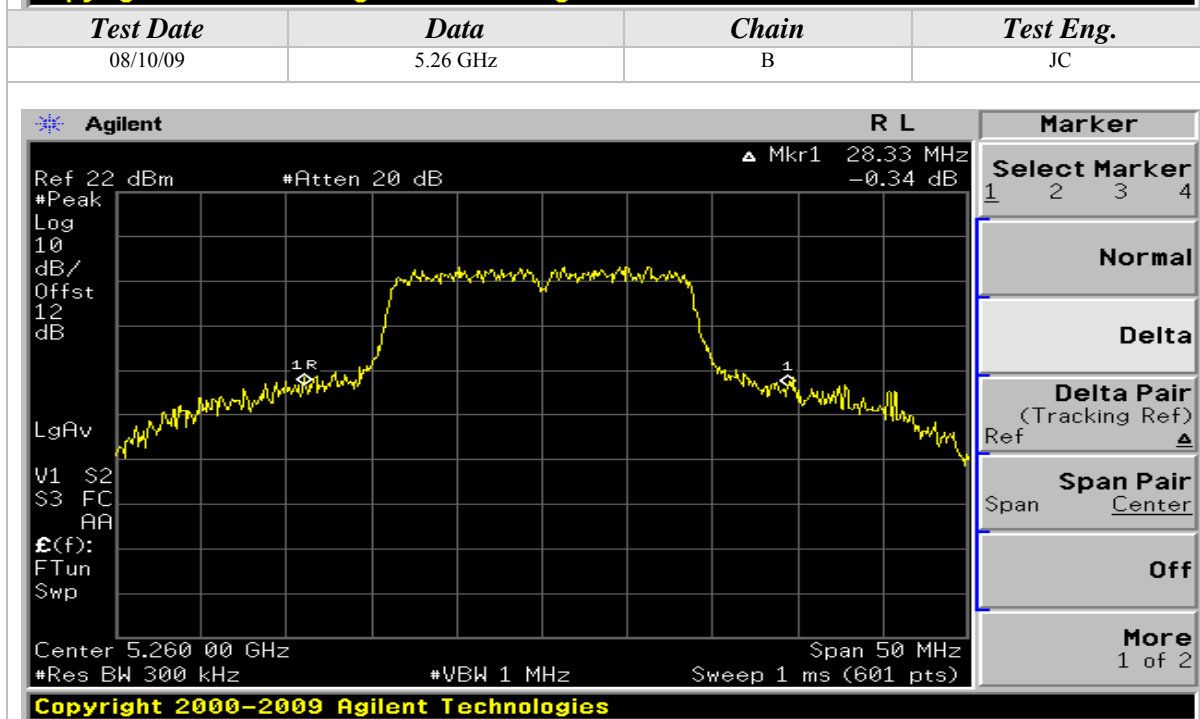
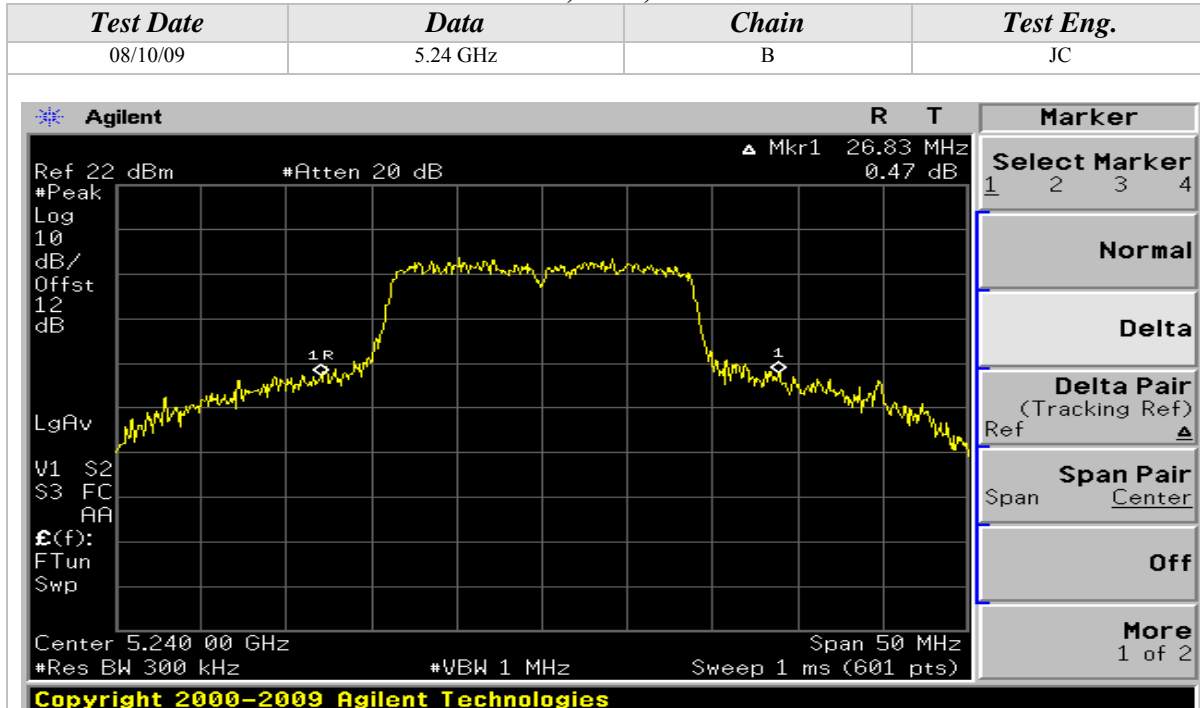

26dB Emissions Bandwidth (Continued)

802.11n Mode, 5GHz, 20MHz Wide

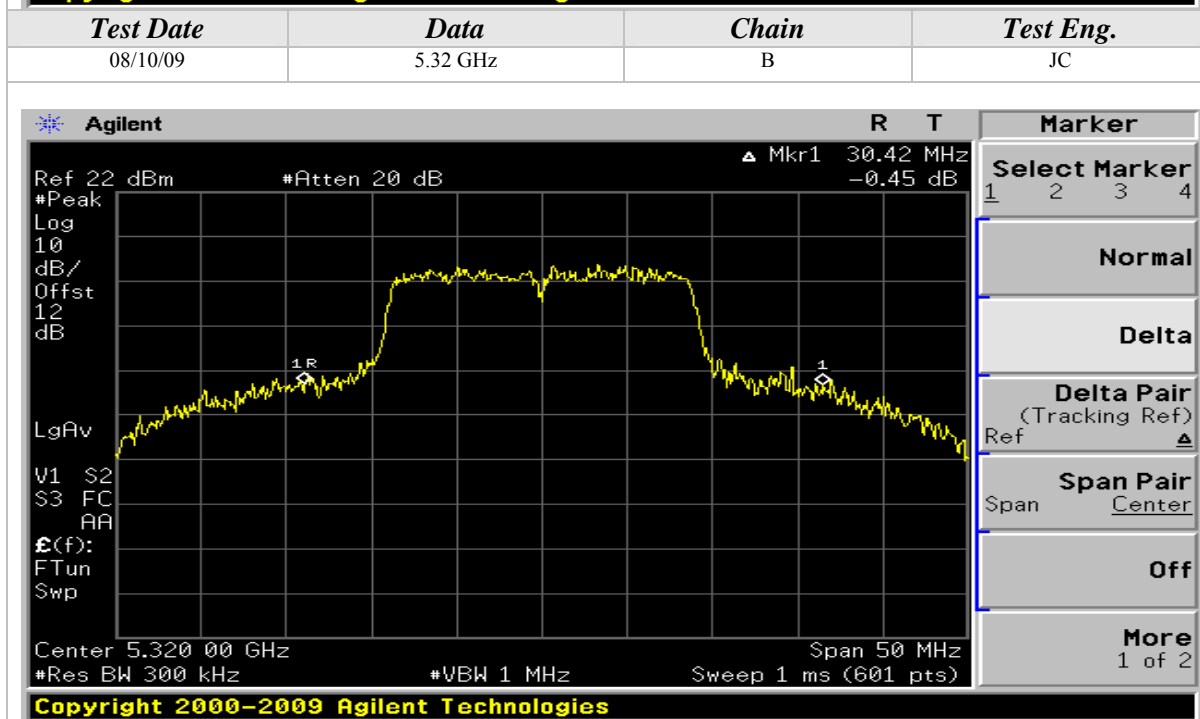
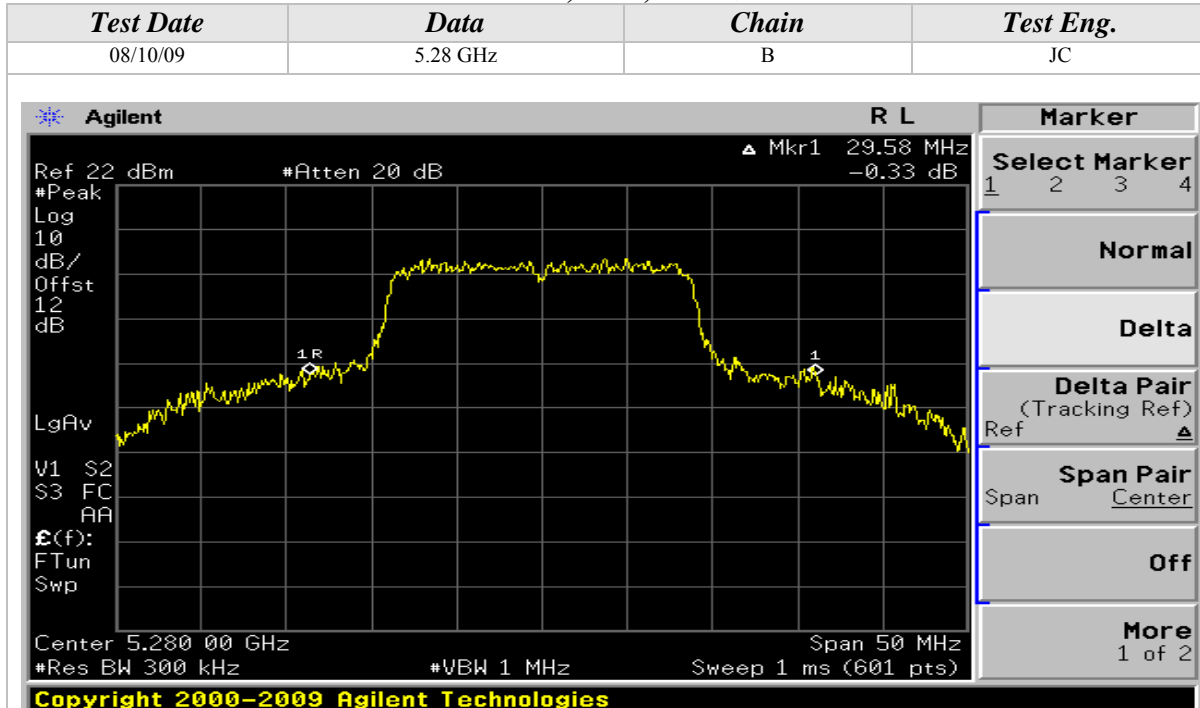



26dB Emissions Bandwidth (Continued)

802.11n Mode, 5GHz, 20MHz Wide

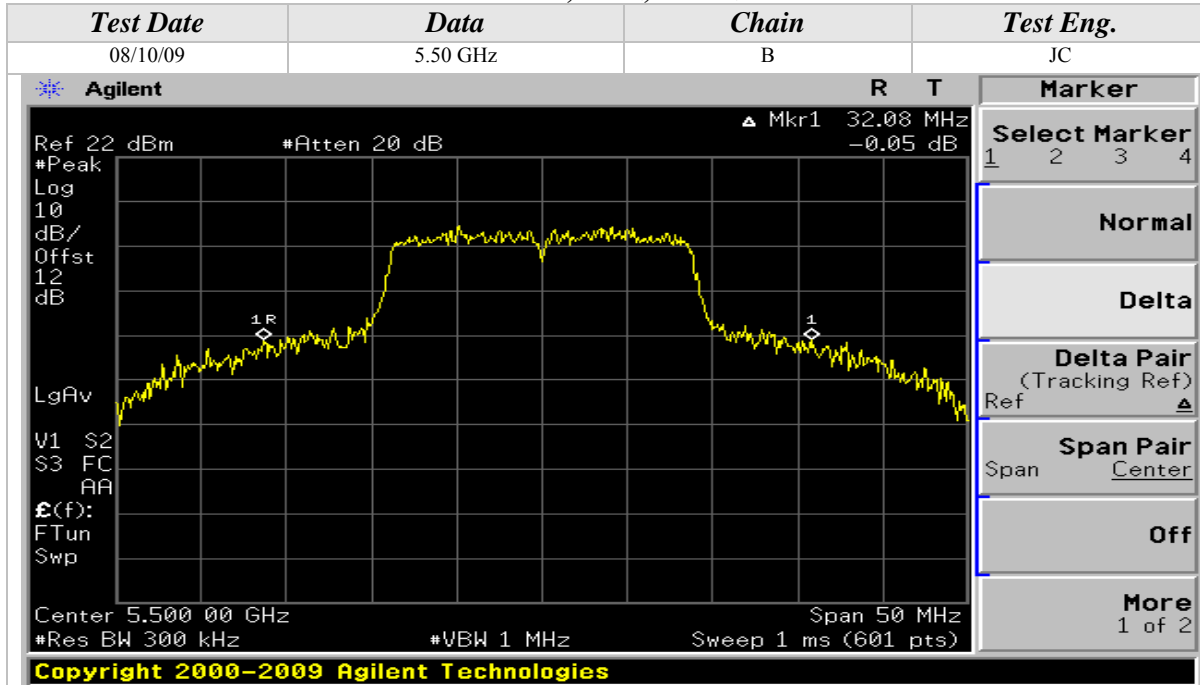

26dB Emissions Bandwidth (Continued)

802.11n Mode, 5GHz, 20MHz Wide

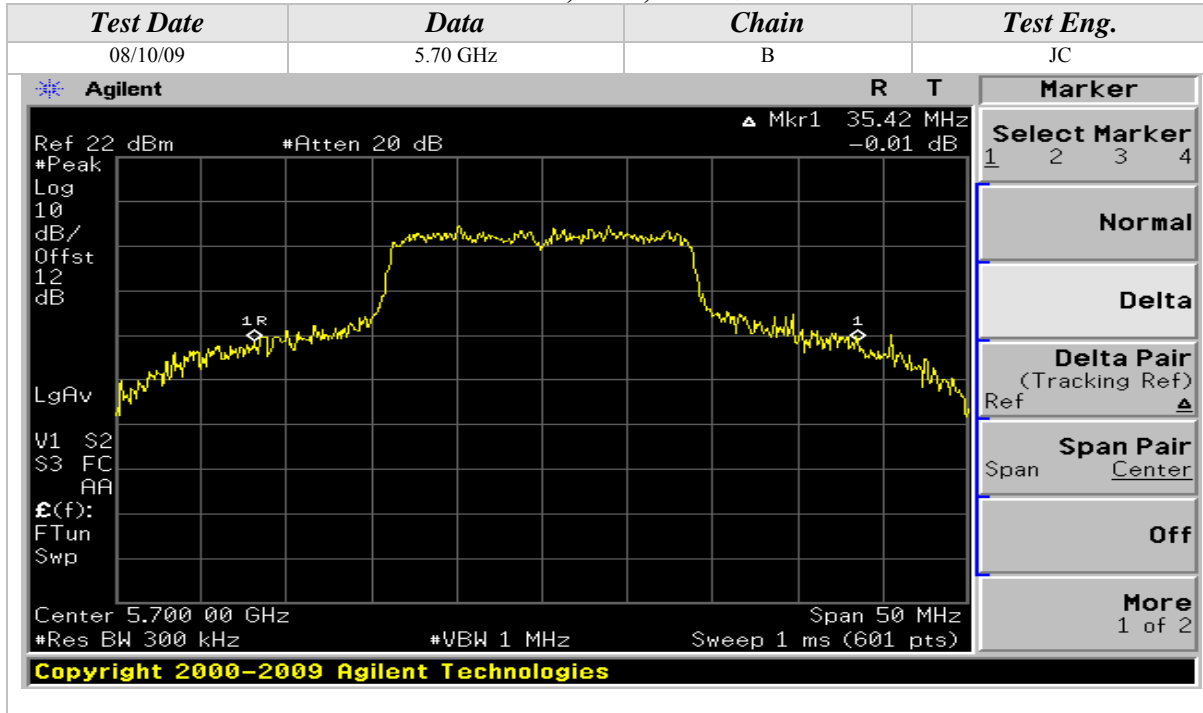



26dB Emissions Bandwidth (Continued)

802.11n Mode, 5GHz, 40MHz Wide

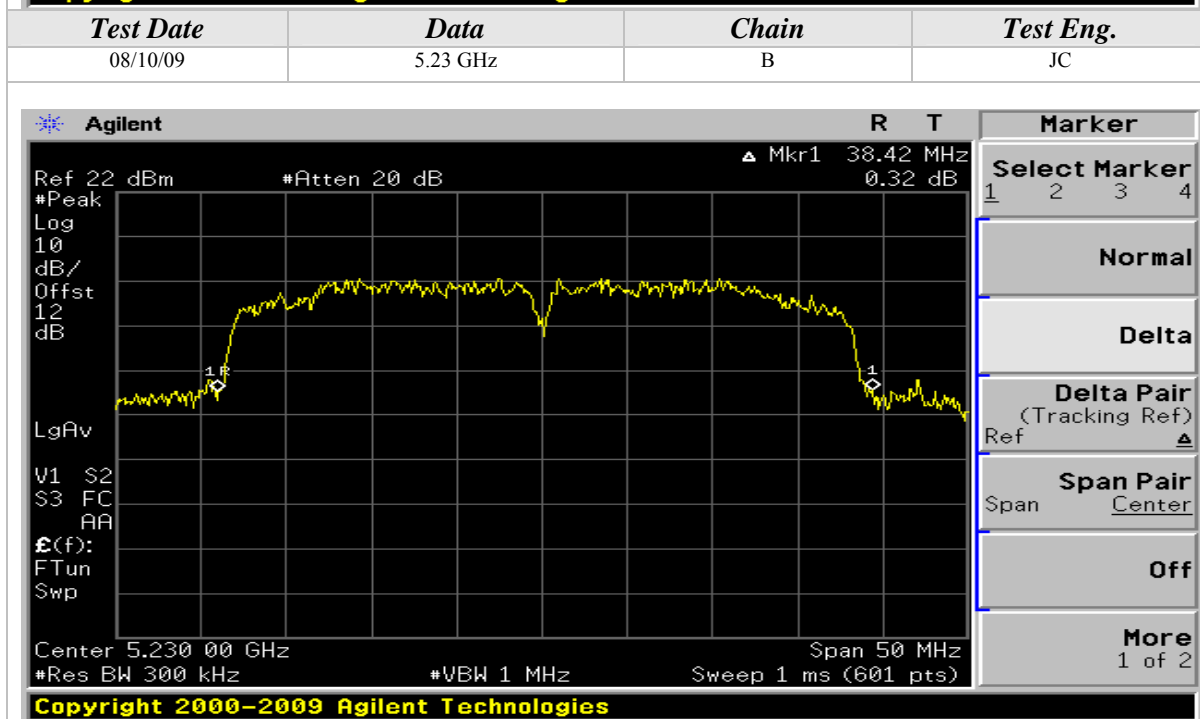

26dB Emissions Bandwidth (Continued)

802.11n Mode, 5GHz, 40MHz Wide

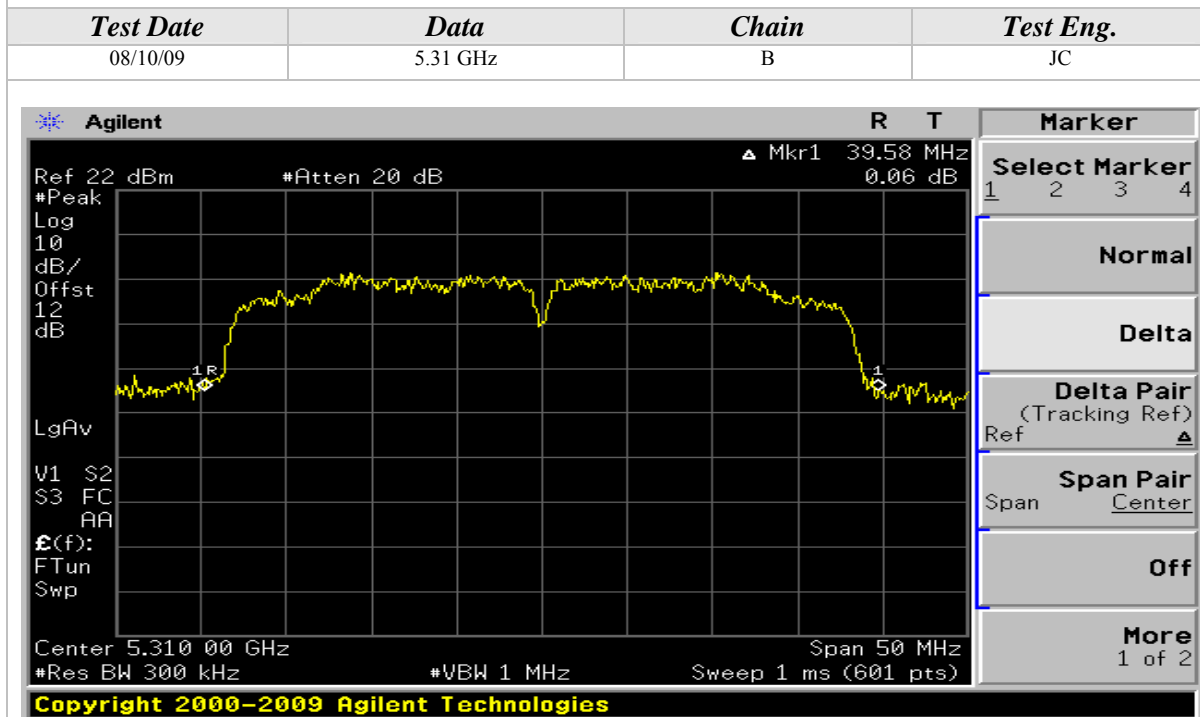
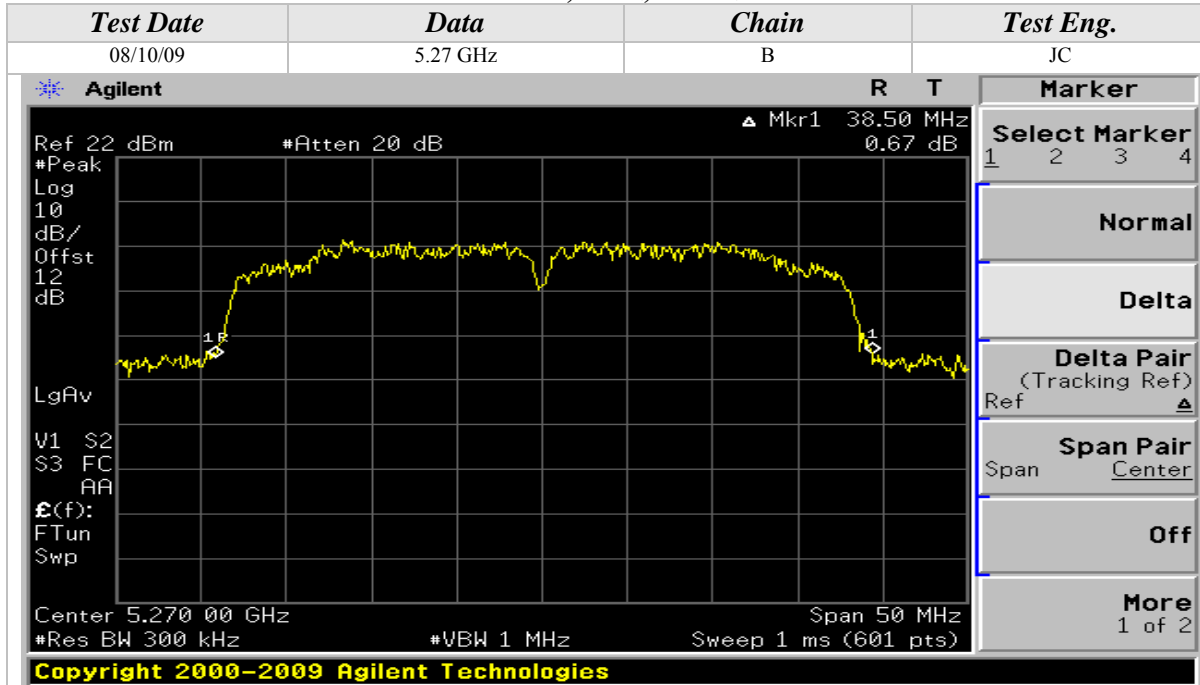

26dB Emissions Bandwidth (Continued)

802.11n Mode, 5GHz, 40MHz Wide

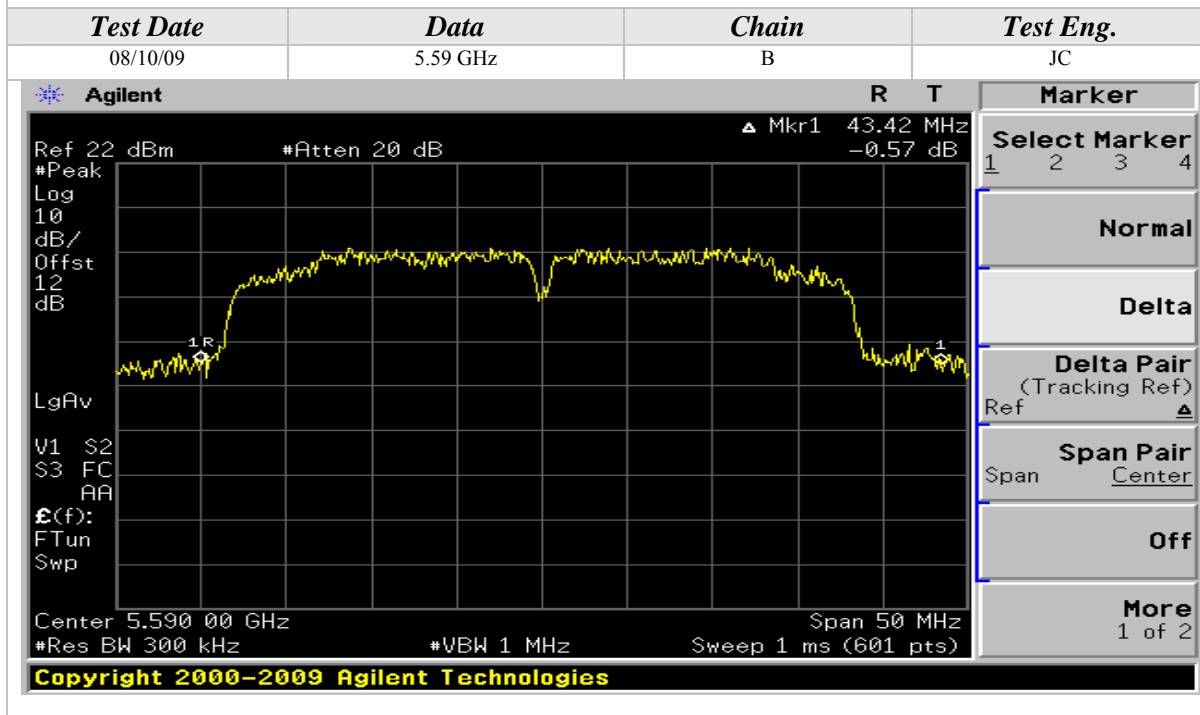
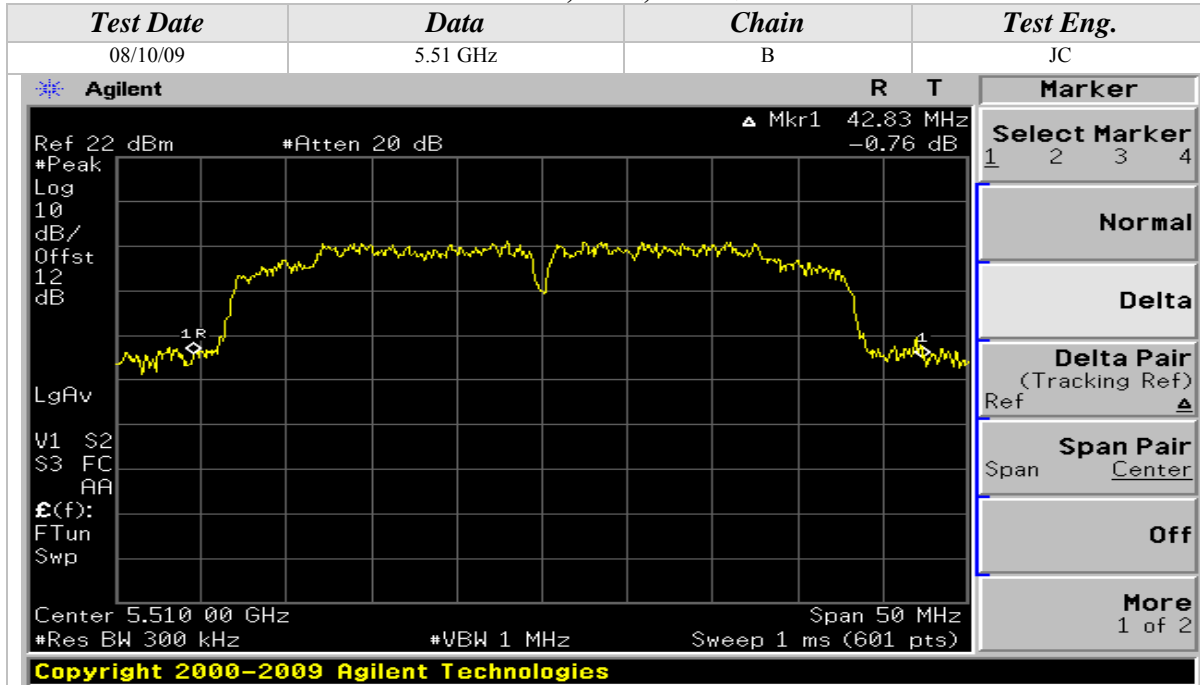

26dB Emissions Bandwidth (Continued)

802.11n Mode, 5GHz, 40MHz Wide

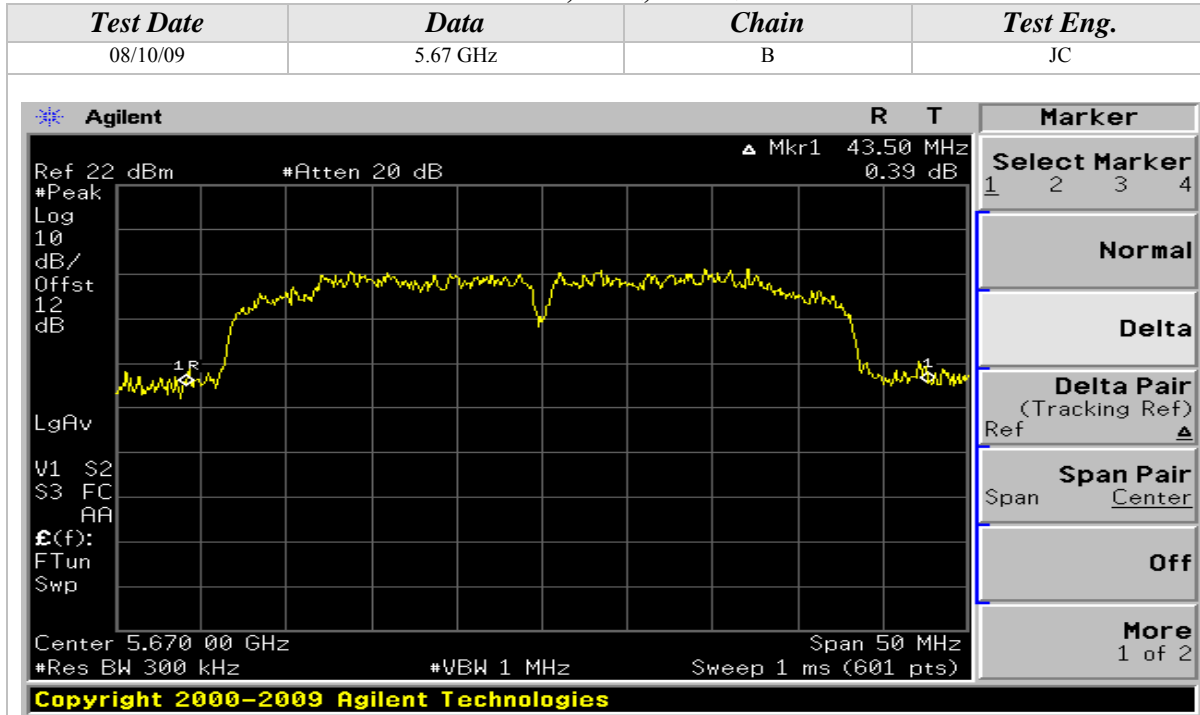

**PEAK POWER SPECTRAL DENSITY**

<b>CLIENT:</b>	Intel Corporation	<b>DATE:</b>	08/11/09
<b>EUT:</b>	Intel WiFi Link 6200	<b>PROJECT NUMBER:</b>	INTEL-090601
<b>MODEL NUMBER:</b>	622ANHMW	<b>TEST ENGINEER:</b>	JC
<b>SERIAL NUMBER:</b>	0015005A70A4	<b>SITE #:</b>	2
<b>CONFIGURATION:</b>	Tested installed in an extender board connected to the host laptop's mini PCI slot	<b>TEMPERATURE:</b>	21 deg. C
		<b>HUMIDITY:</b>	49% RH
		<b>TIME:</b>	8:30 AM

<b>Description:</b>	For the band 5.15-5.25 GHz, the peak power spectral density shall not exceed 4 dBm in any 1-MHz band  For the band 5.2 5-5.35 GHz & 5.47-5.725, the peak power spectral density shall not exceed 11 dBm in any 1-MHz band
<b>Results:</b>	See Data Sheet
<b>Note:</b>	Conducted Emissions Measurements were performed on the EUT with power supply set at the following voltage and frequency. <ul style="list-style-type: none"> <li>• 120VAC / 60 Hz.</li> </ul>

<b>Peak Power Spectral Density Limits</b>	
<b>Frequency (MHz)</b>	<b>Limit (dBm)</b>
5150-5250	4
5250-5350	11
5470-5725	11

Using "Method 2" of the FCC Public Notice (DA 02-2138) for all frequency bands



Peak Power Spectral Density (Continued)

802.11a Mode

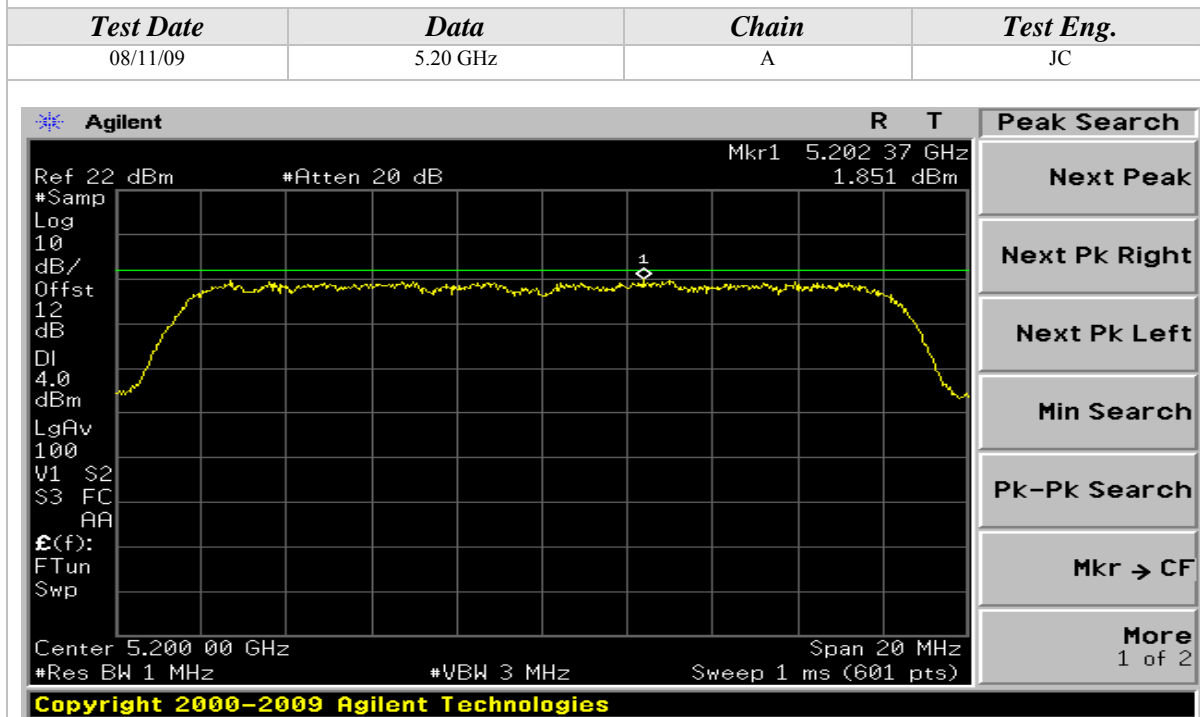
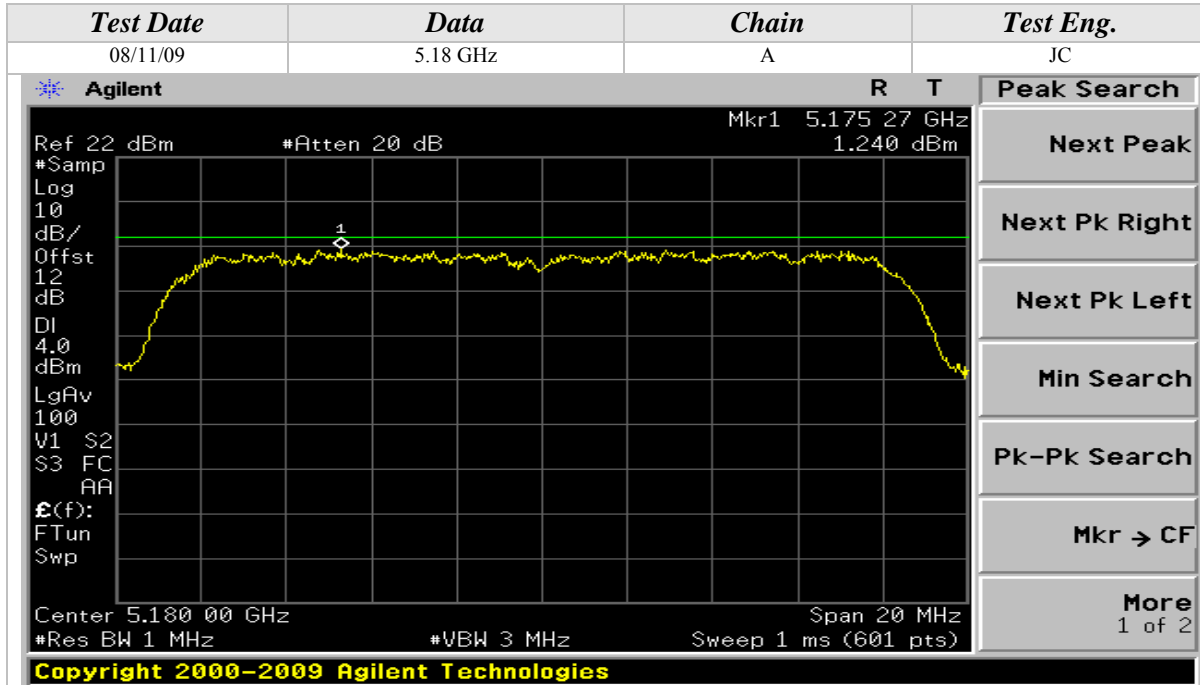



Peak Power Spectral Density (Continued)

802.11a Mode

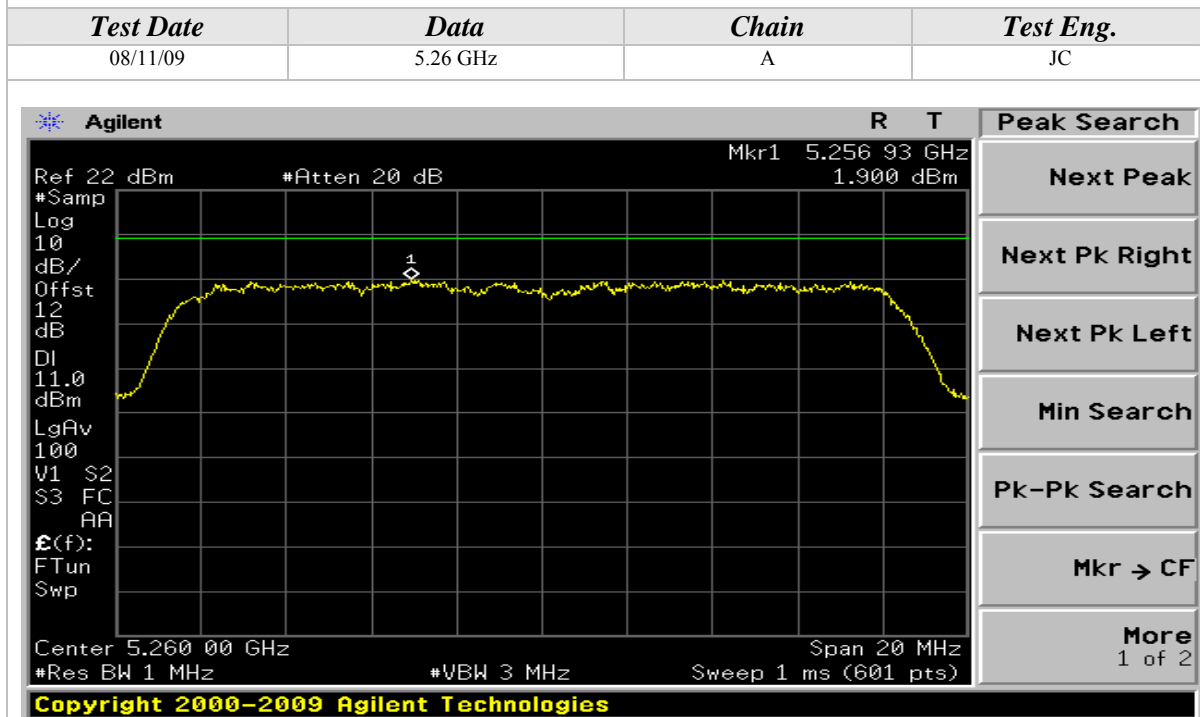
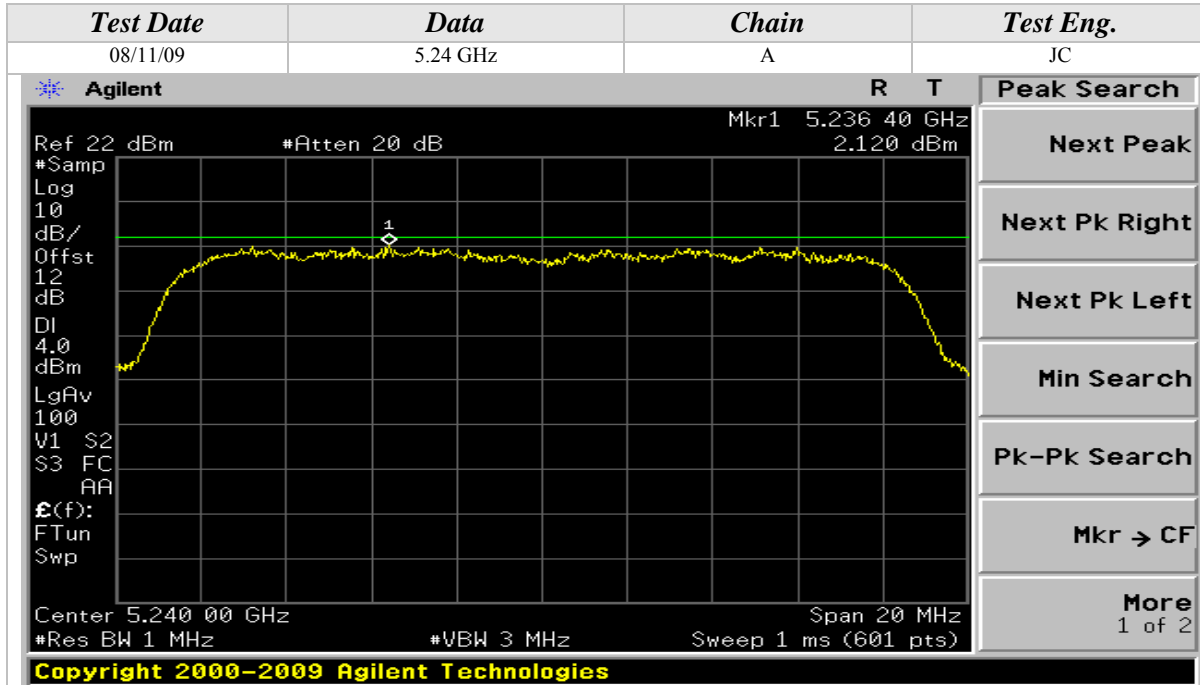



Peak Power Spectral Density (Continued)

802.11a Mode





Peak Power Spectral Density (Continued)

802.11a Mode

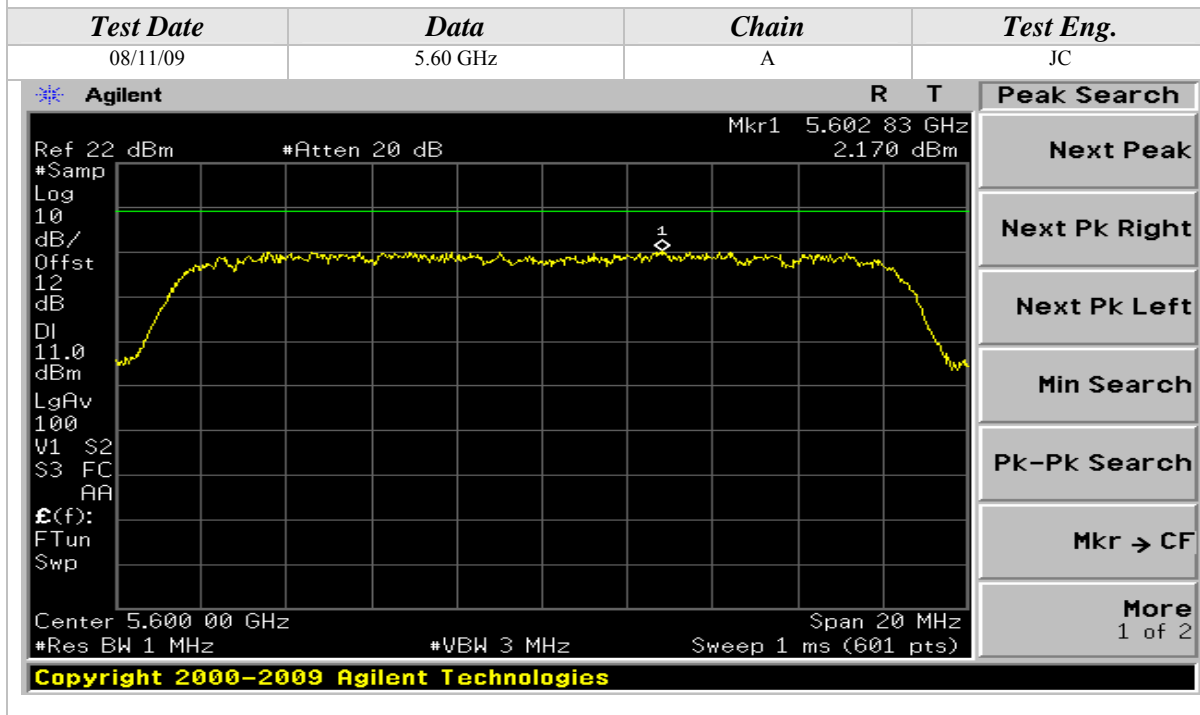
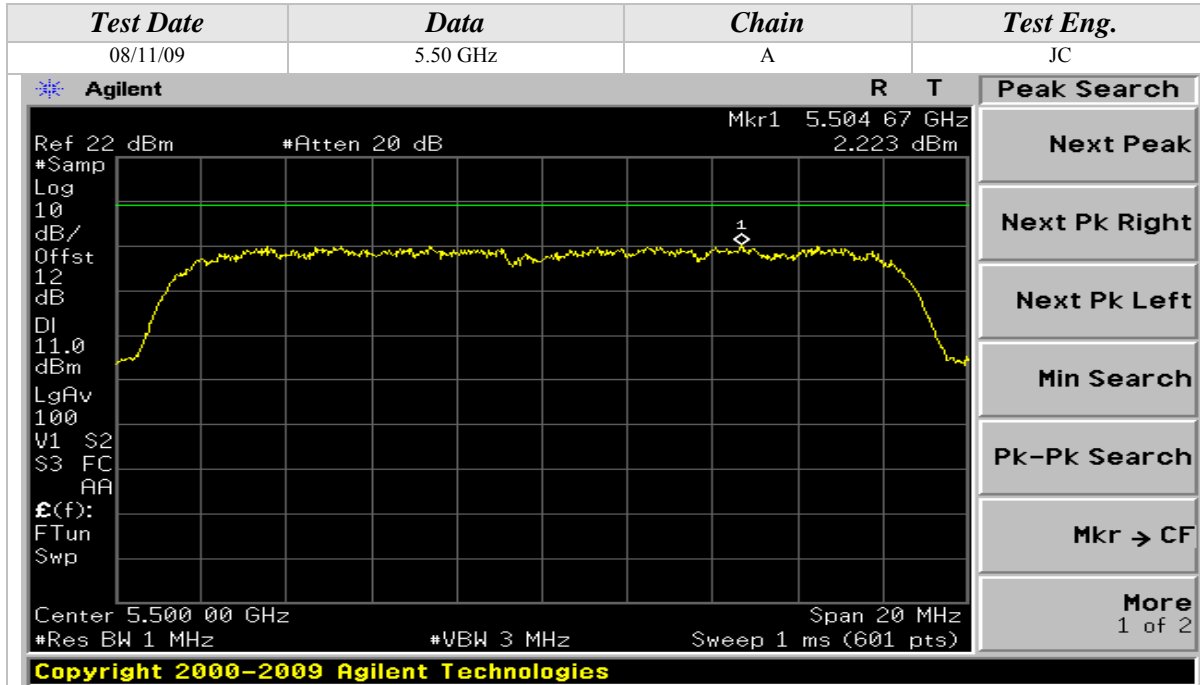

Peak Power Spectral Density (Continued)

802.11a Mode

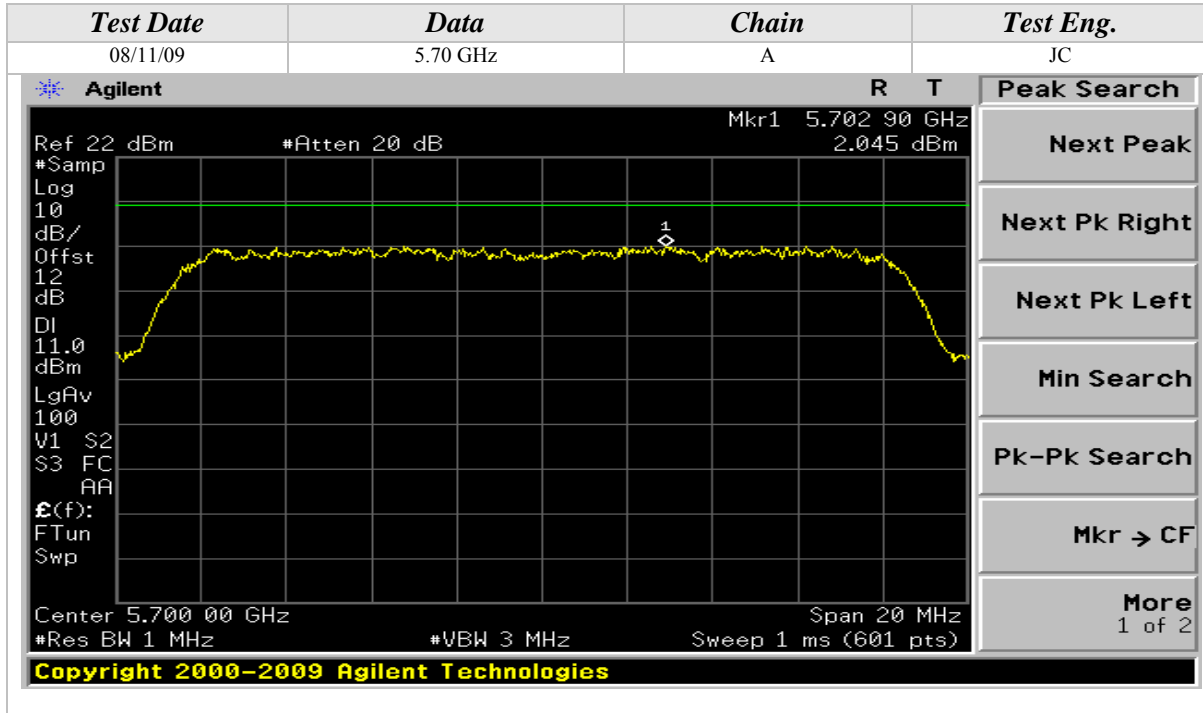



Peak Power Spectral Density (Continued)

802.11n Mode, 5GHz, 20MHz Wide

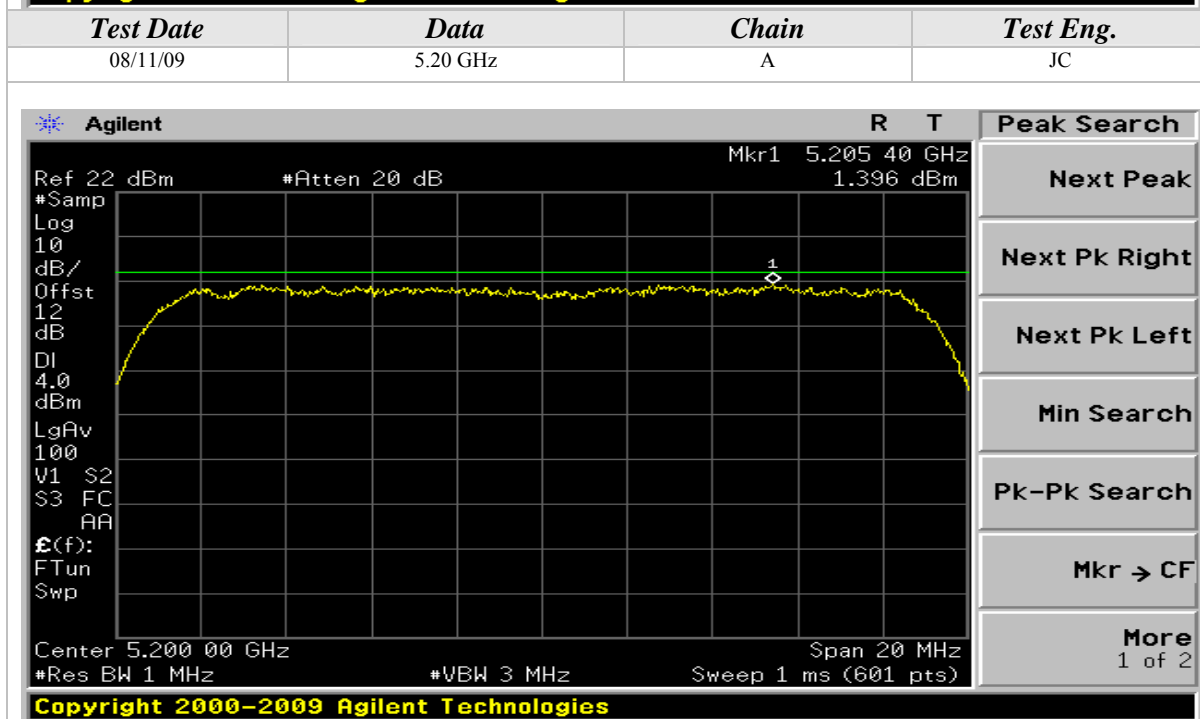
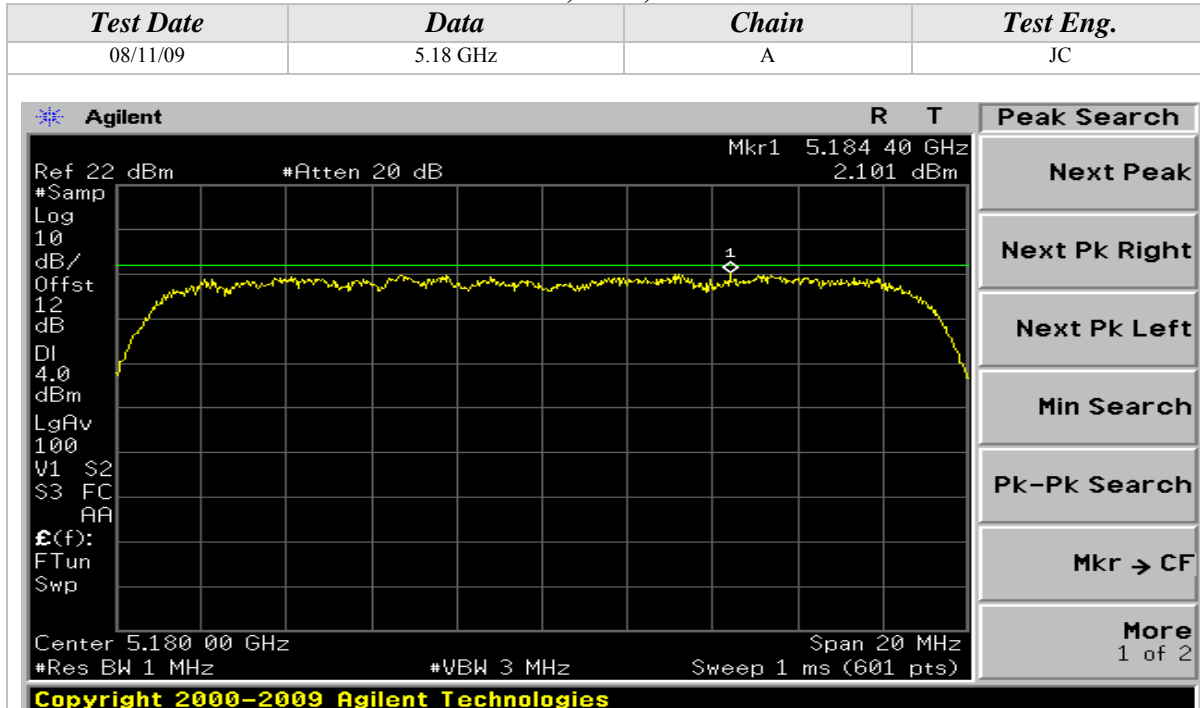

Peak Power Spectral Density (Continued)

802.11n Mode, 5GHz, 20MHz Wide





Peak Power Spectral Density (Continued)

802.11n Mode, 5GHz, 20MHz Wide

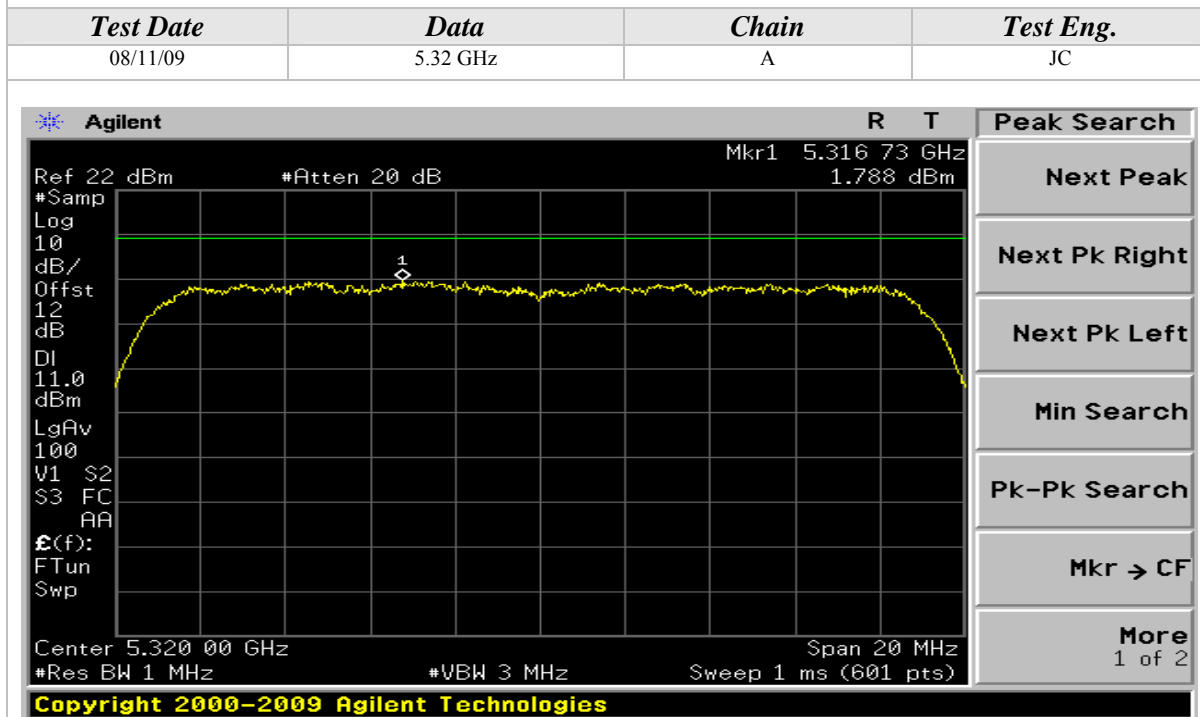
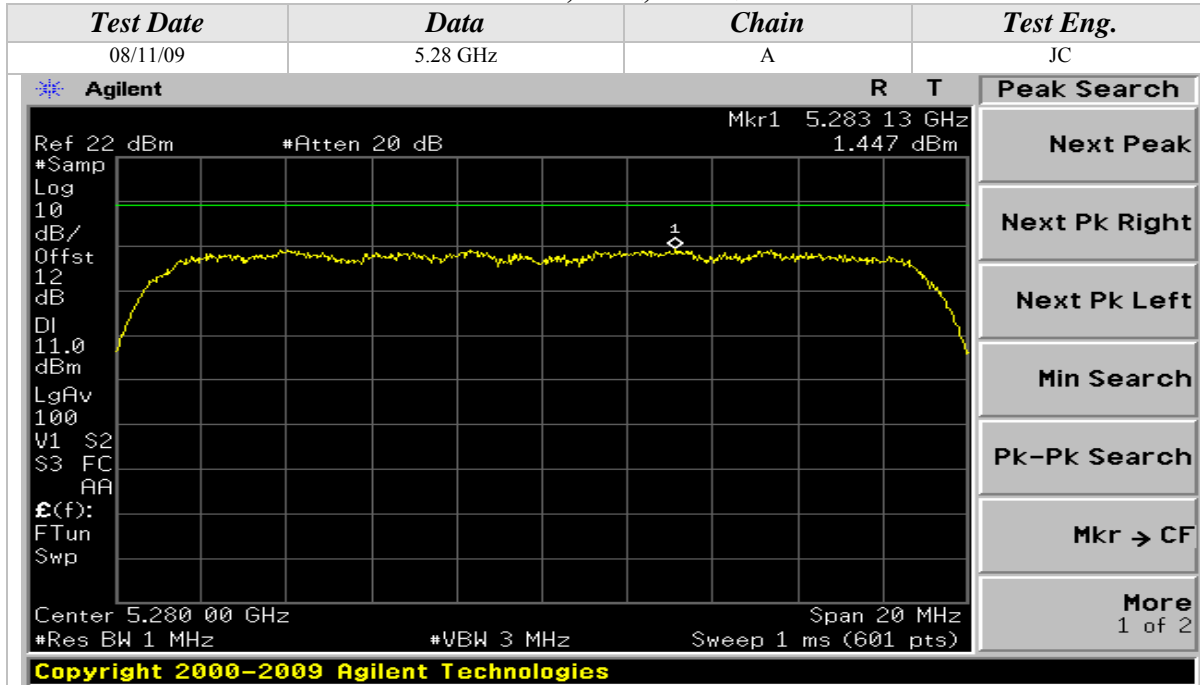



Peak Power Spectral Density (Continued)

802.11n Mode, 5GHz, 20MHz Wide

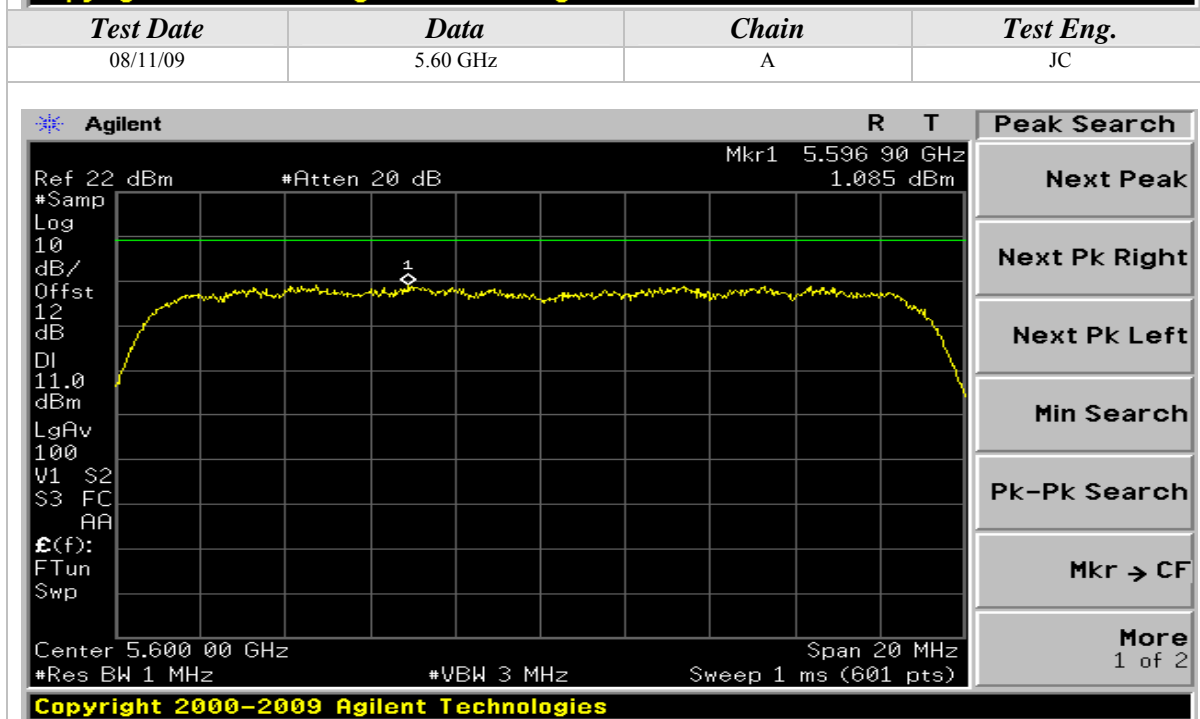
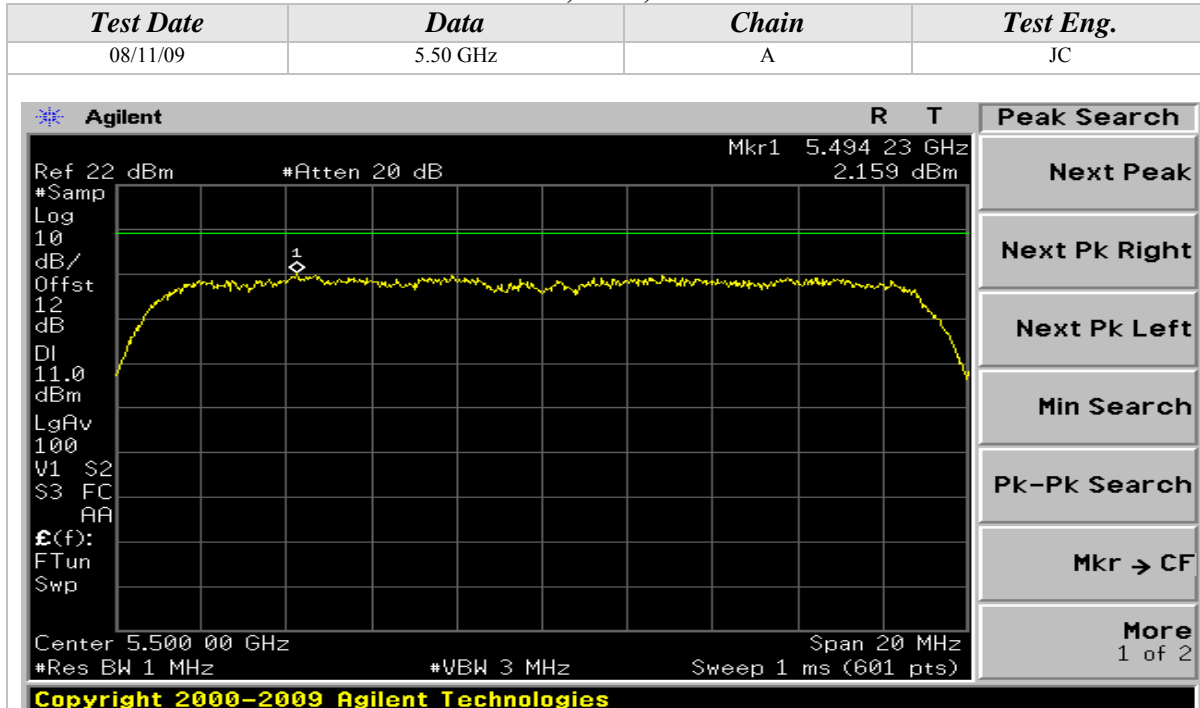



Peak Power Spectral Density (Continued)

802.11n Mode, 5GHz, 20MHz Wide

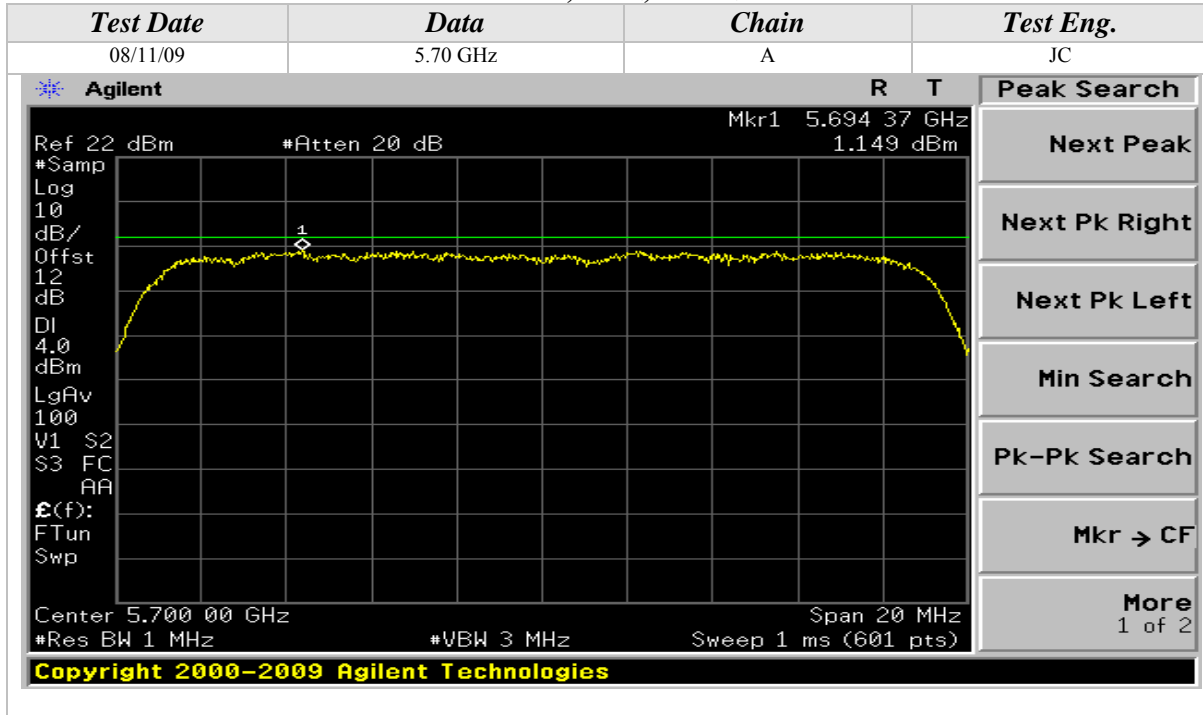



Peak Power Spectral Density (Continued)

802.11n Mode, 5GHz, 40MHz Wide



Peak Power Spectral Density (Continued)

802.11n Mode, 5GHz, 40MHz Wide

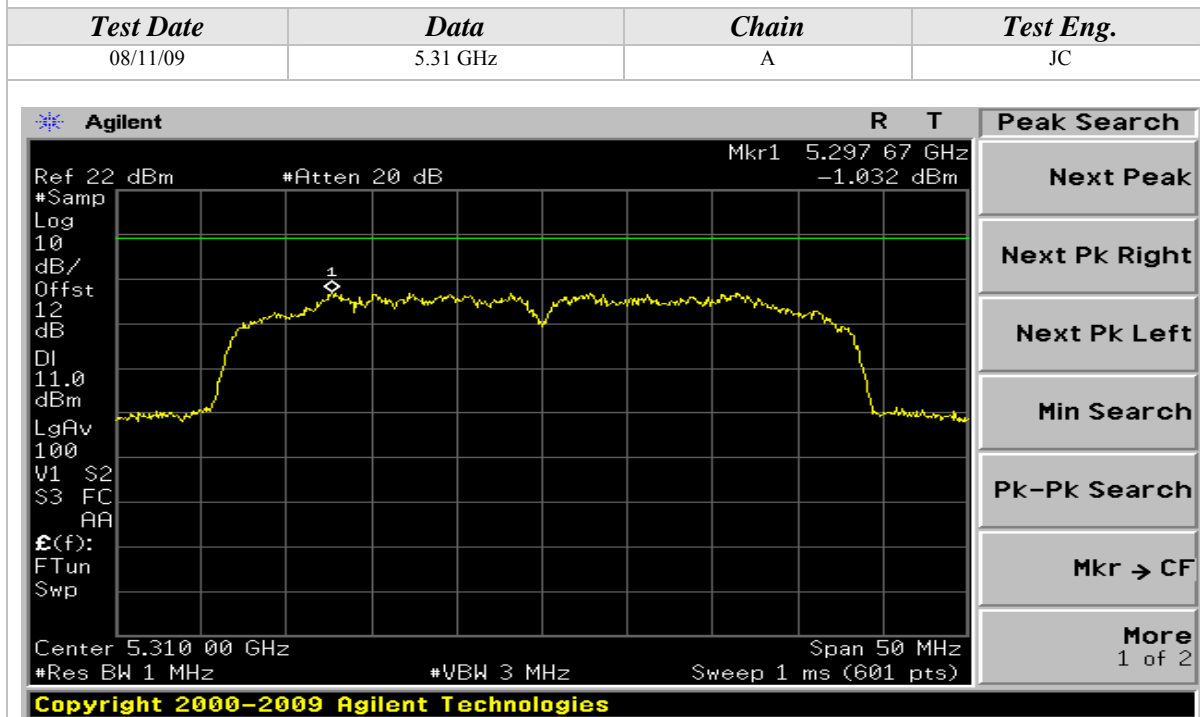
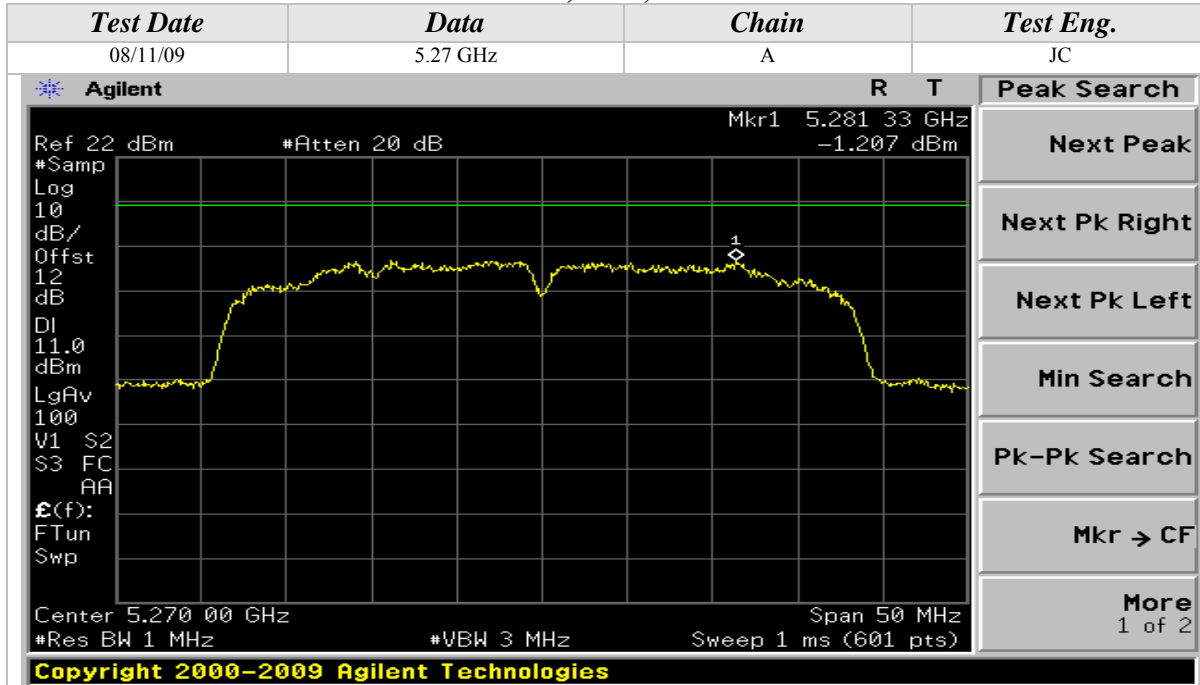



Peak Power Spectral Density (Continued)

802.11n Mode, 5GHz, 40MHz Wide

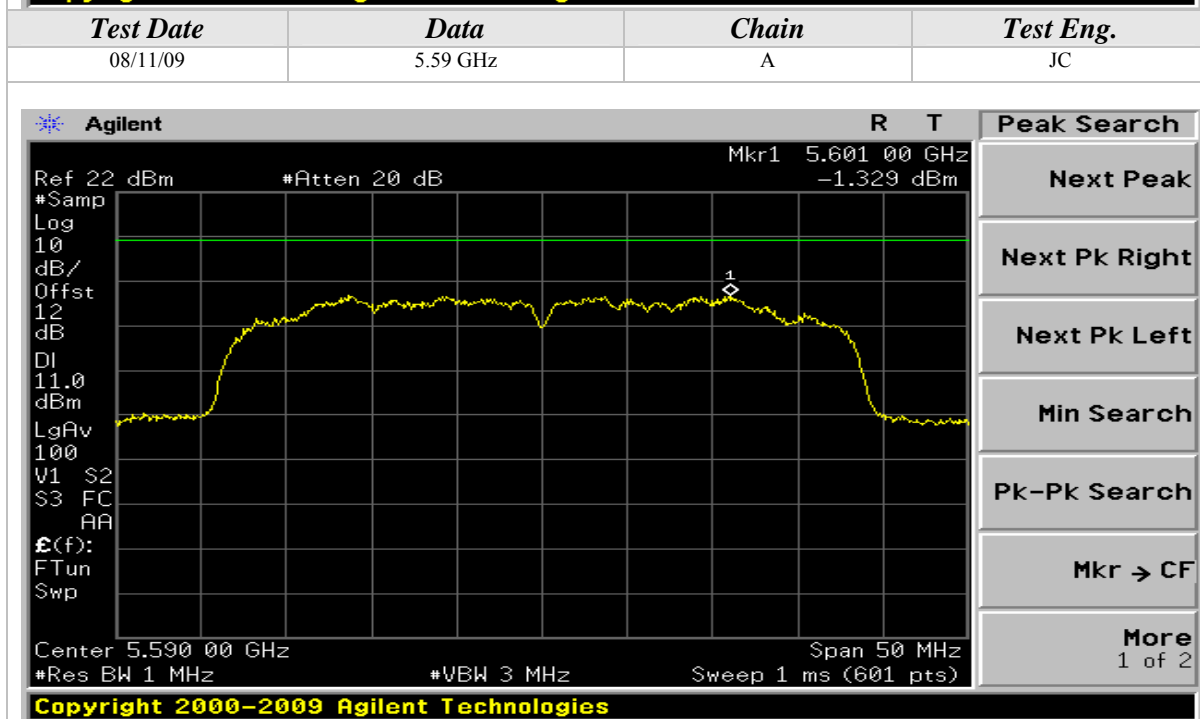
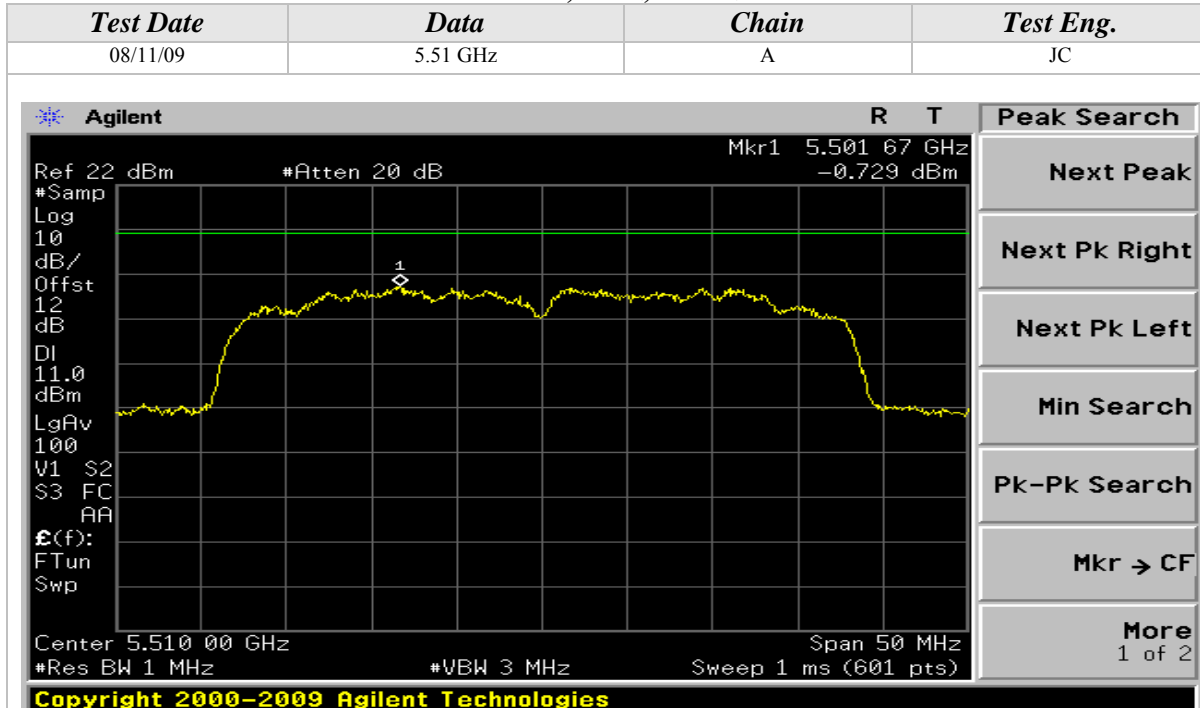

Peak Power Spectral Density (Continued)

802.11n Mode, 5GHz, 40MHz Wide

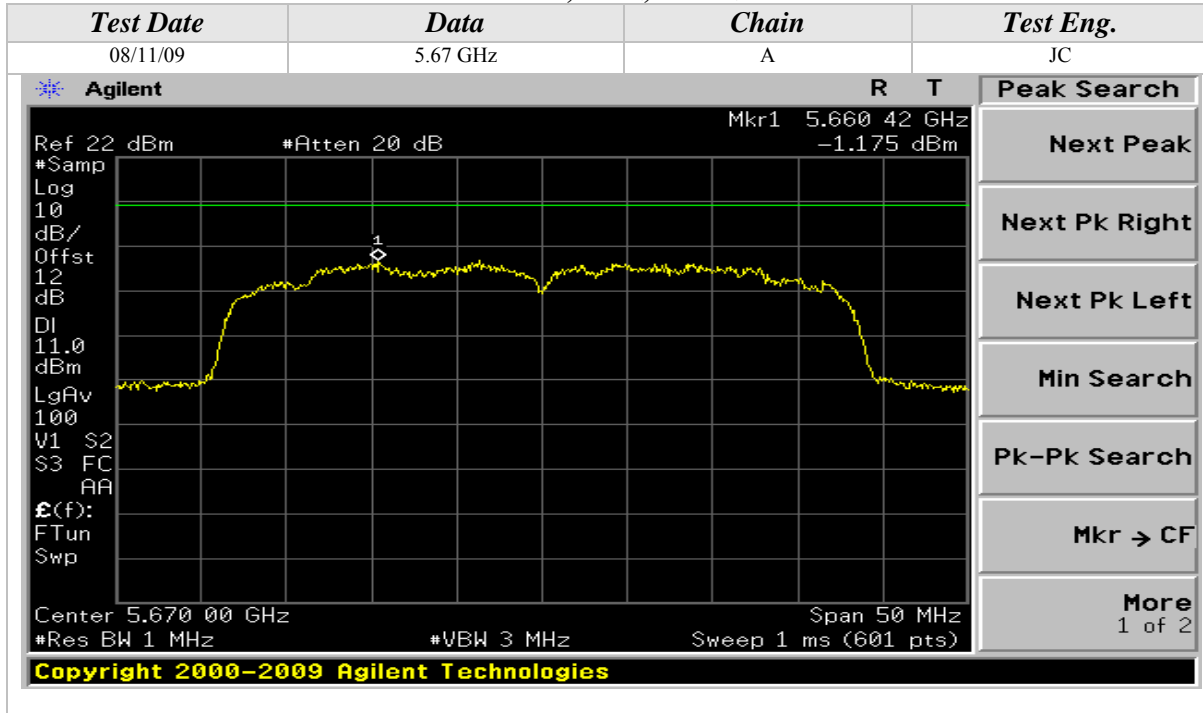

Peak Power Spectral Density (Continued)

802.11a Mode



Peak Power Spectral Density (Continued)

802.11a Mode

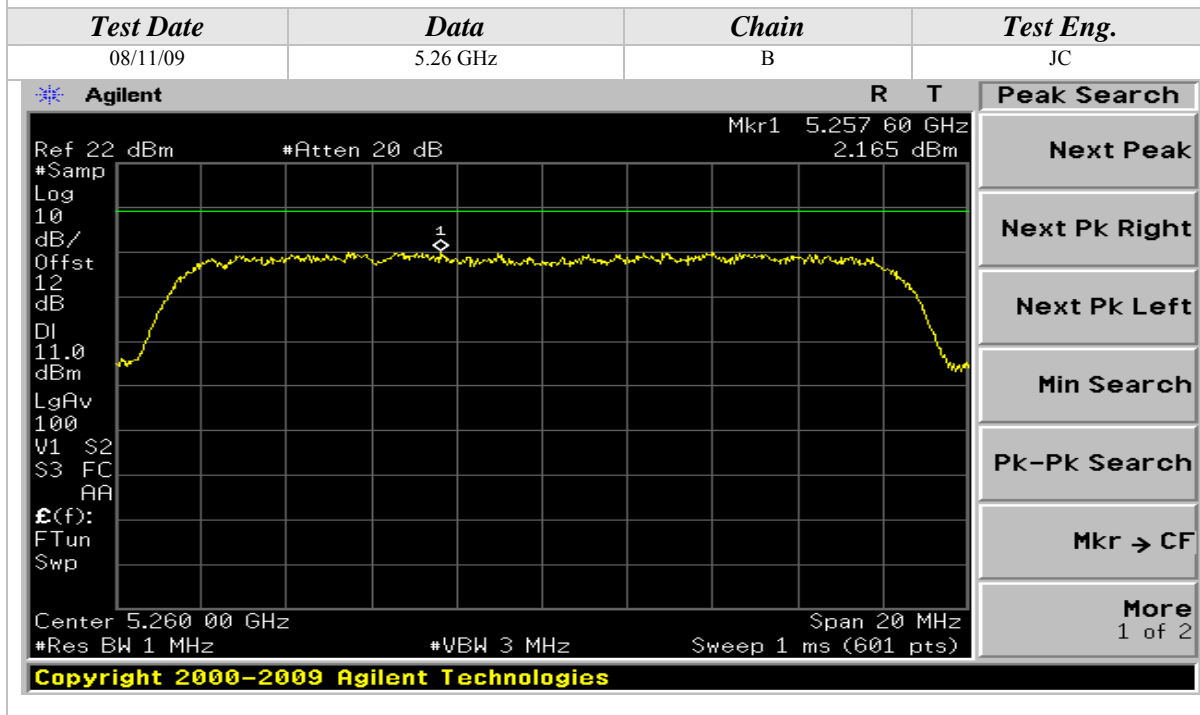
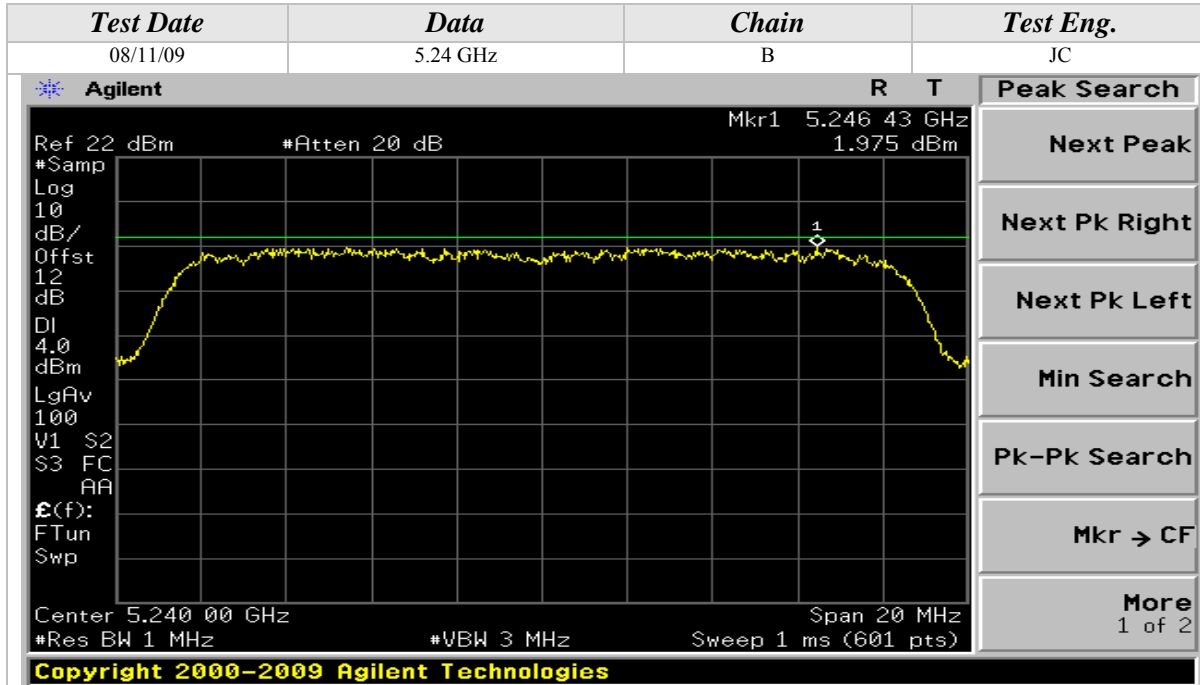



Peak Power Spectral Density (Continued)

802.11a Mode







### Peak Power Spectral Density (Continued)

#### 802.11a Mode

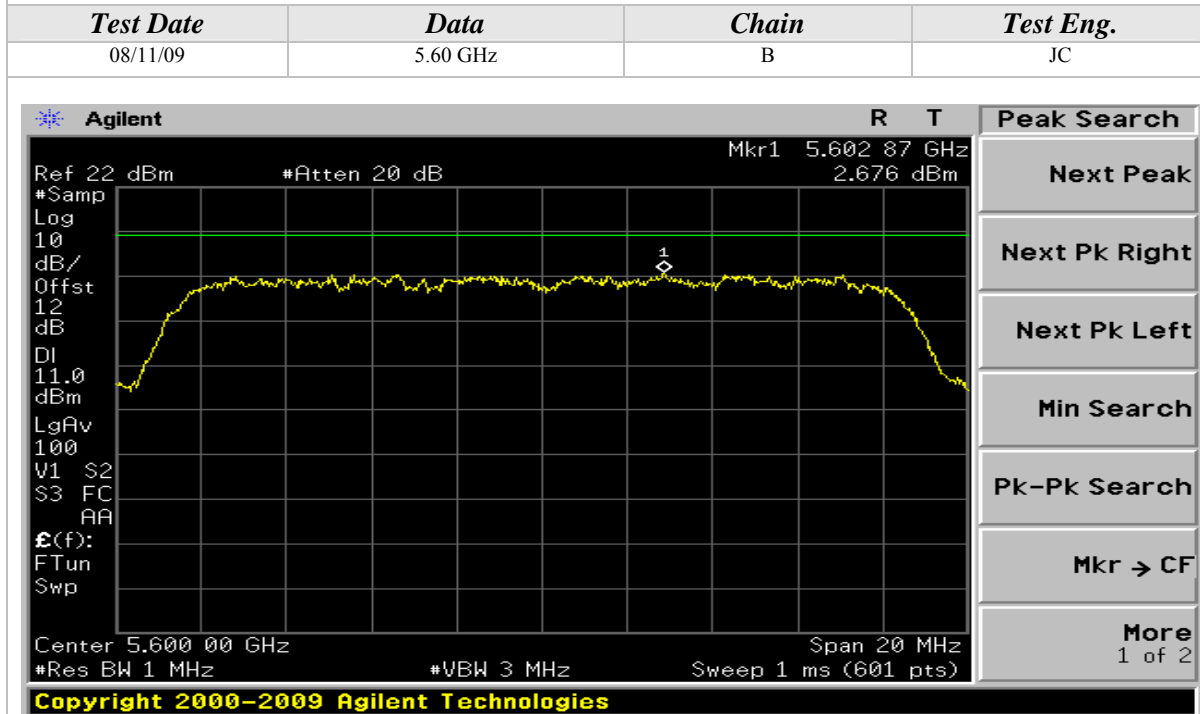
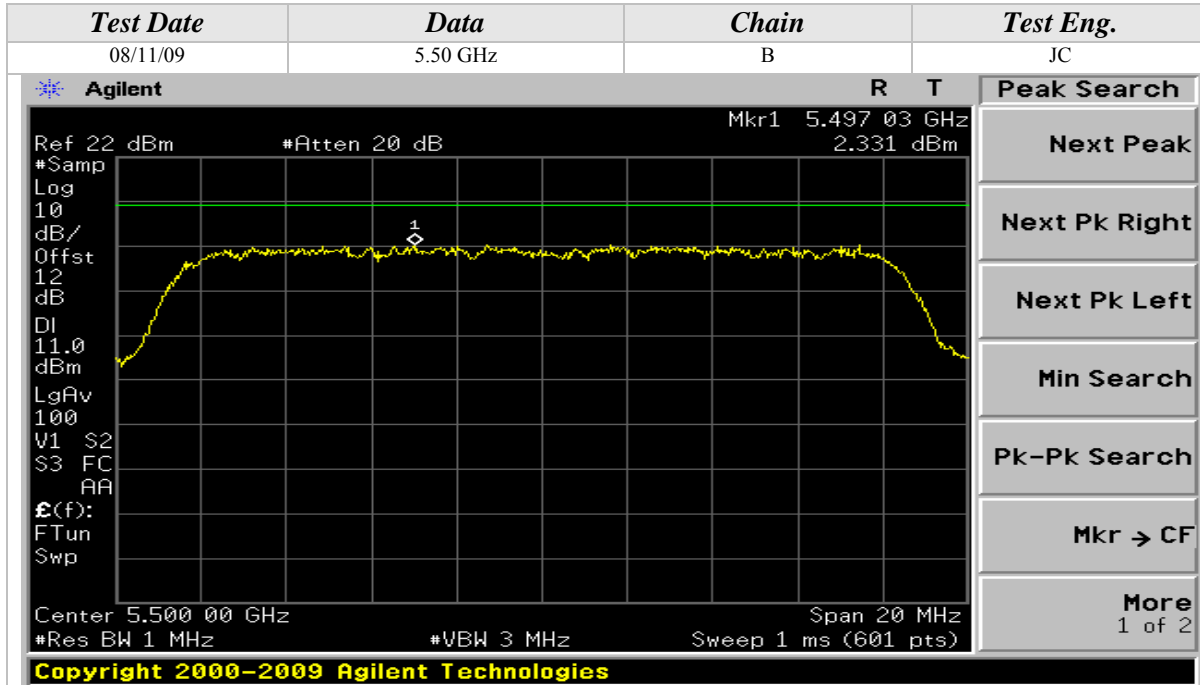

Peak Power Spectral Density (Continued)

802.11a Mode

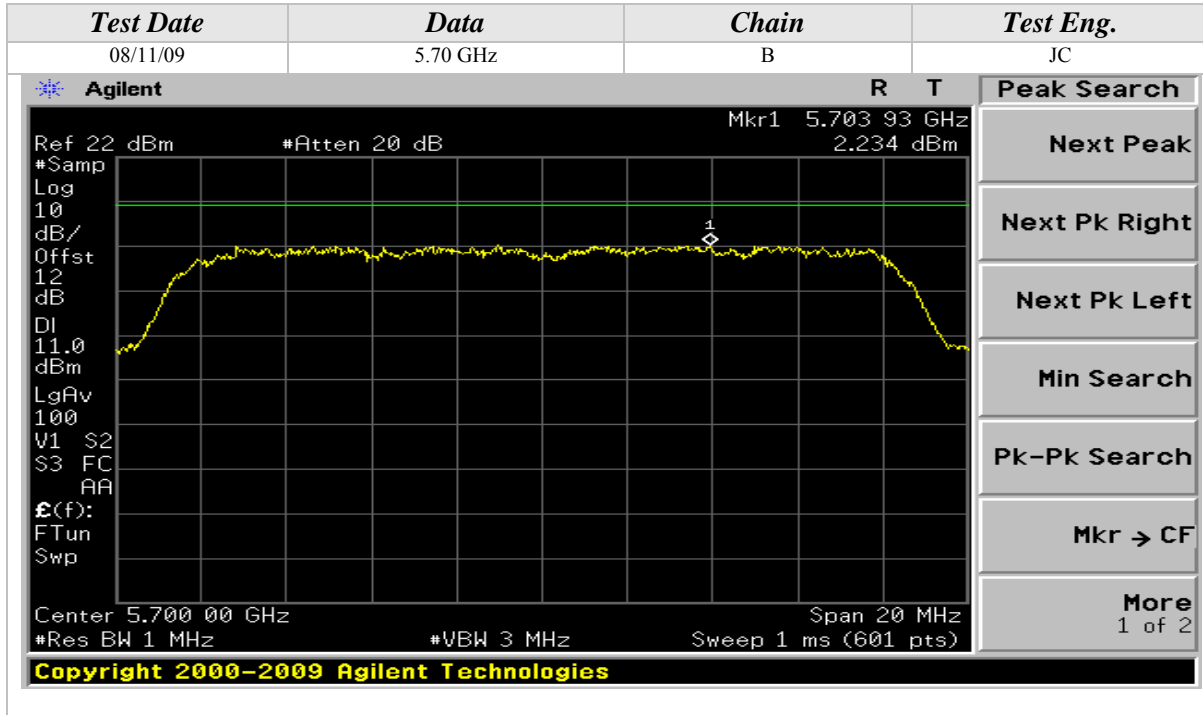

Peak Power Spectral Density (Continued)

802.11n Mode, 5GHz, 20MHz Wide

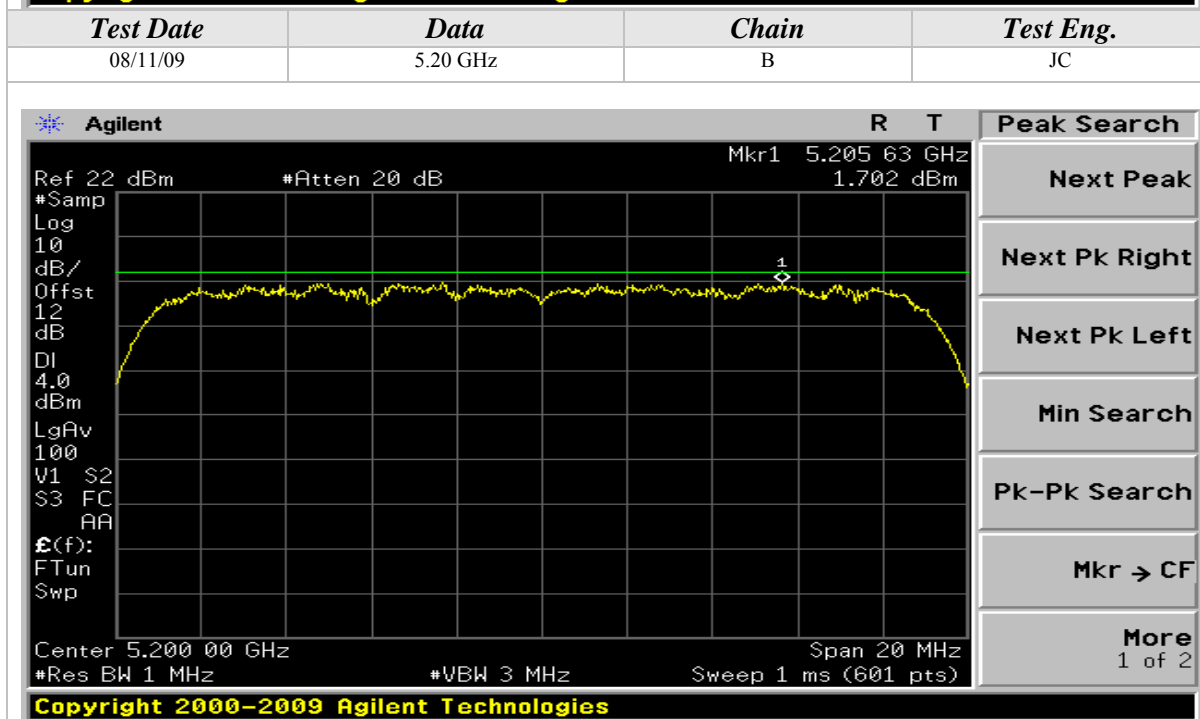
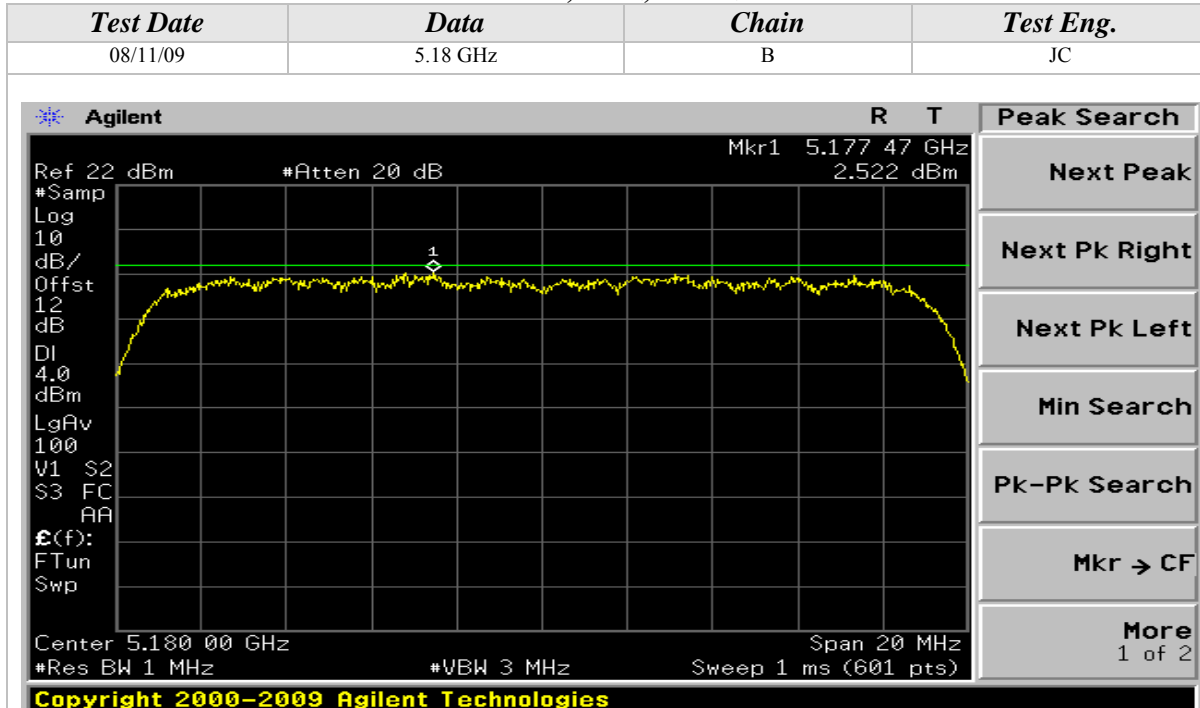

Peak Power Spectral Density (Continued)

802.11n Mode, 5GHz, 20MHz Wide





### Peak Power Spectral Density (Continued)

802.11n Mode, 5GHz, 20MHz Wide

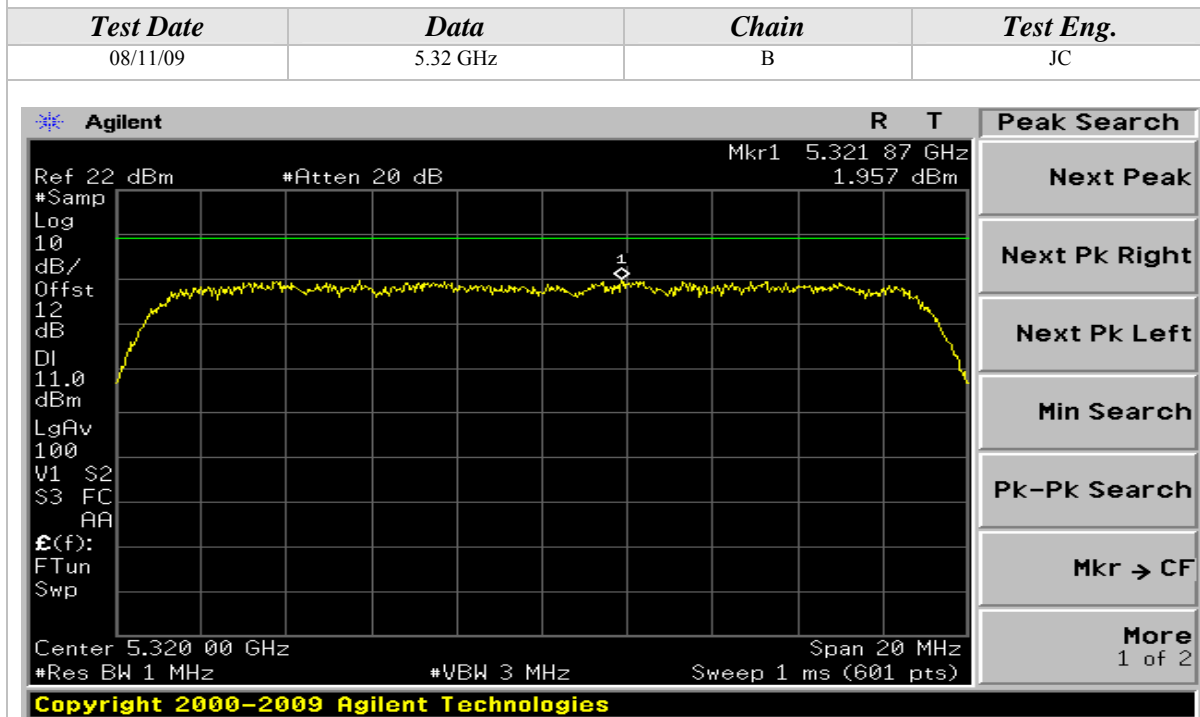
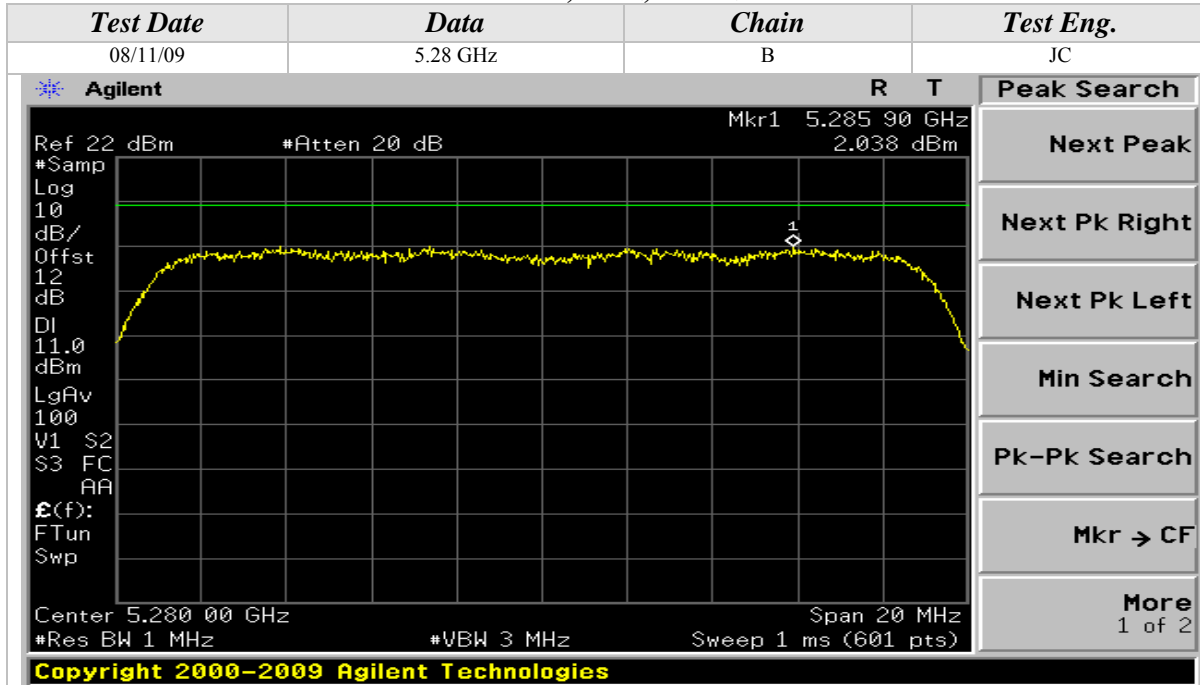



Peak Power Spectral Density (Continued)

802.11n Mode, 5GHz, 20MHz Wide

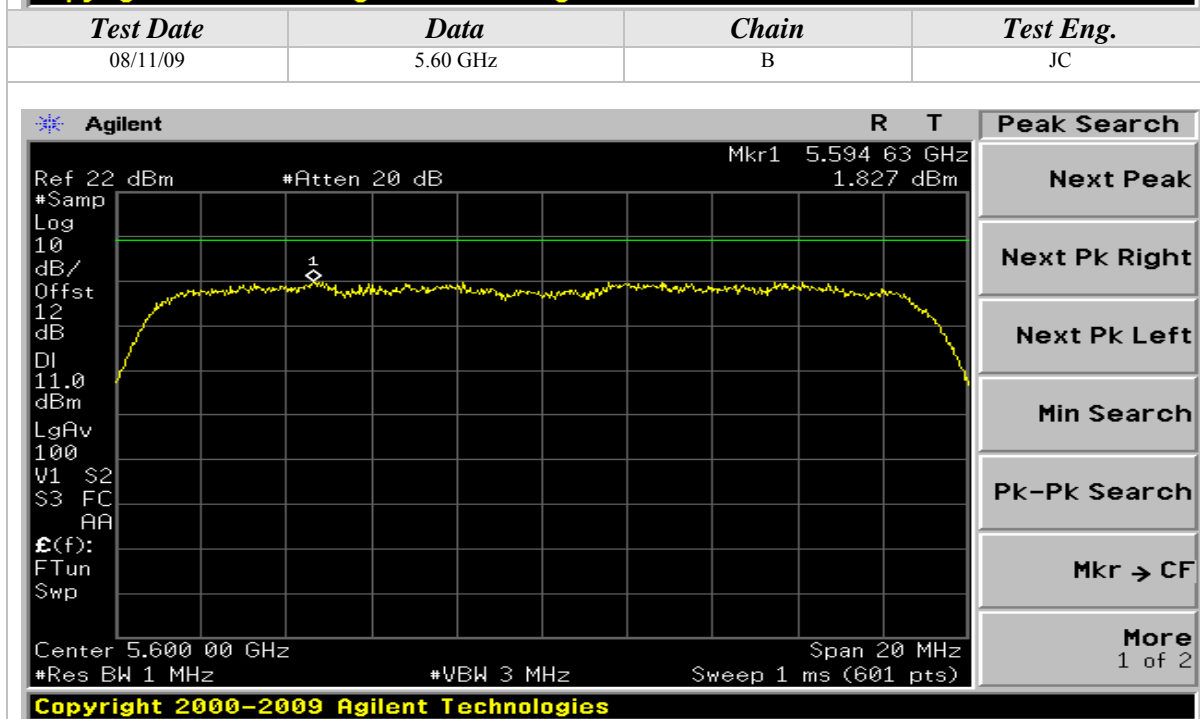
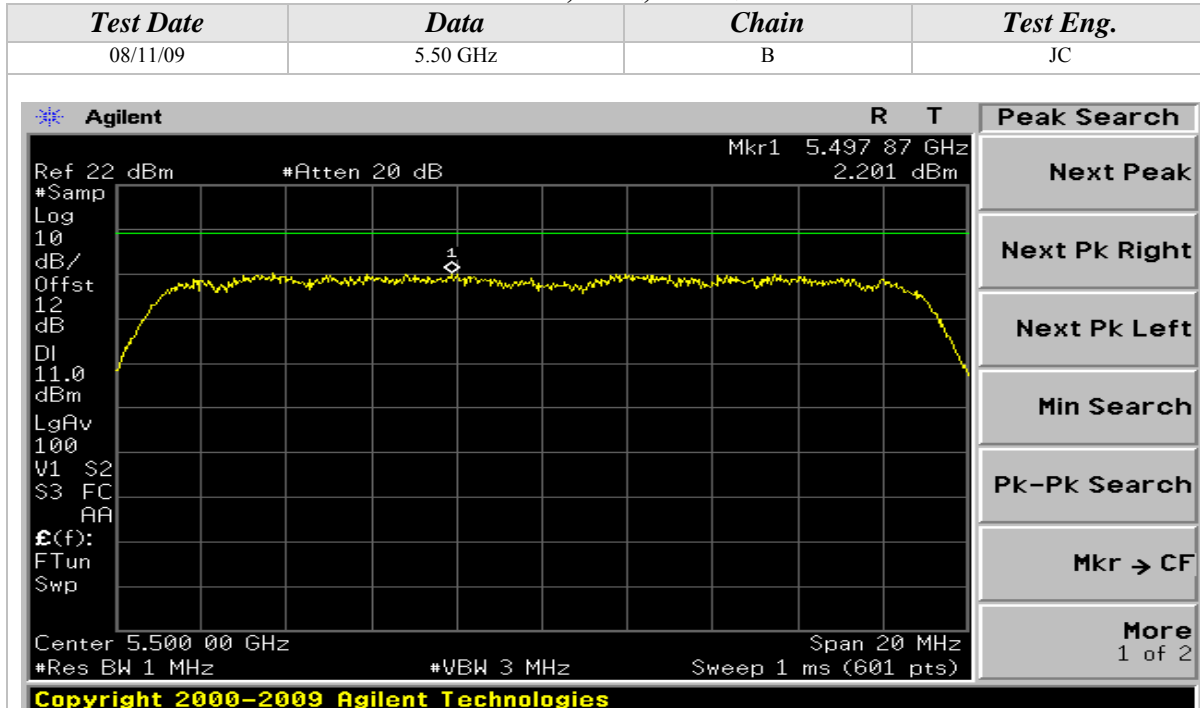

Peak Power Spectral Density (Continued)

802.11n Mode, 5GHz, 20MHz Wide

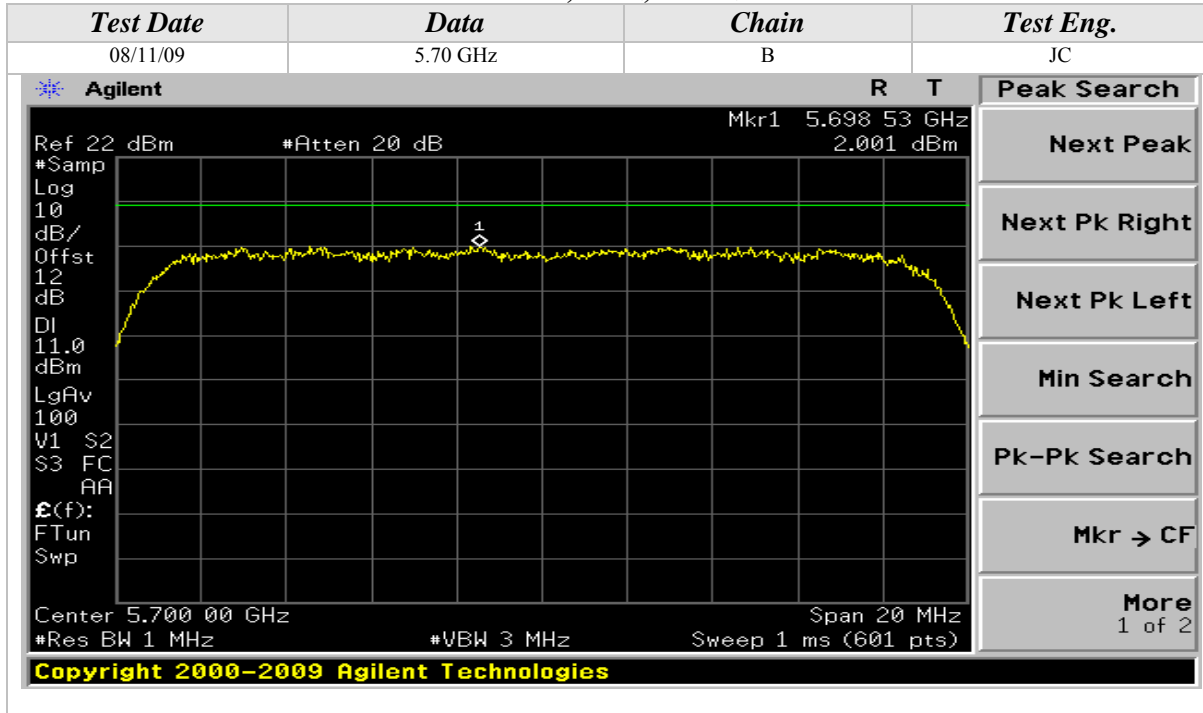

Peak Power Spectral Density (Continued)

802.11n Mode, 5GHz, 40MHz Wide

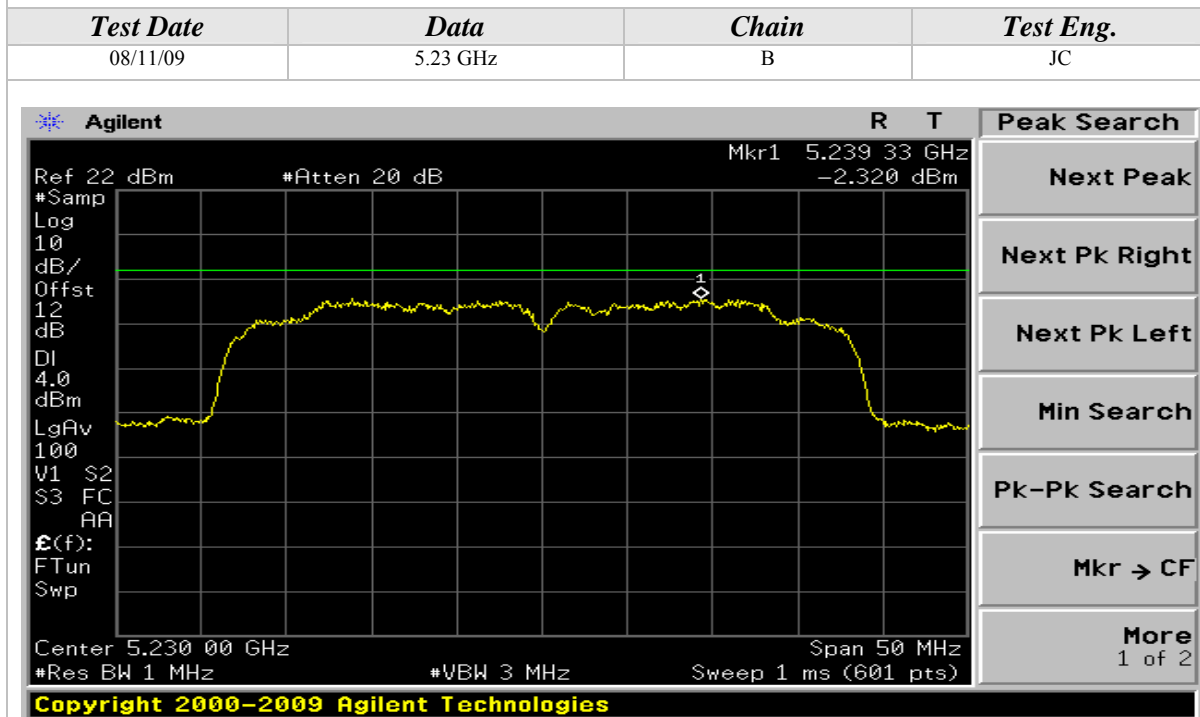
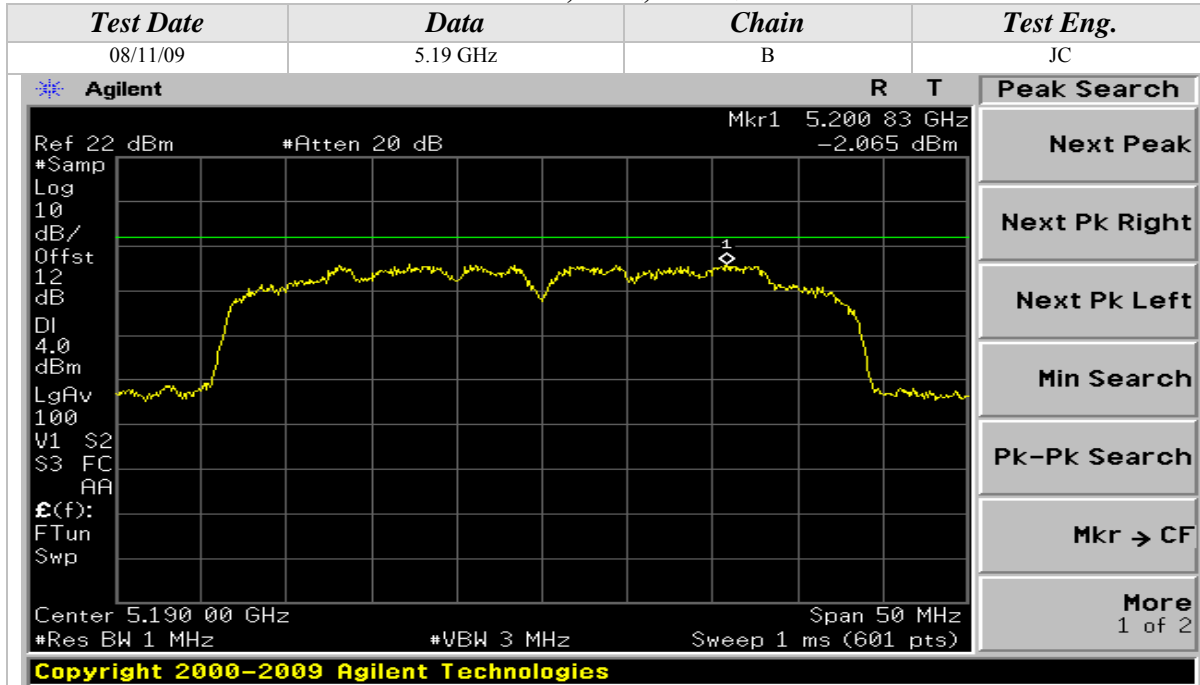





Peak Power Spectral Density (Continued)

802.11n Mode, 5GHz, 40MHz Wide

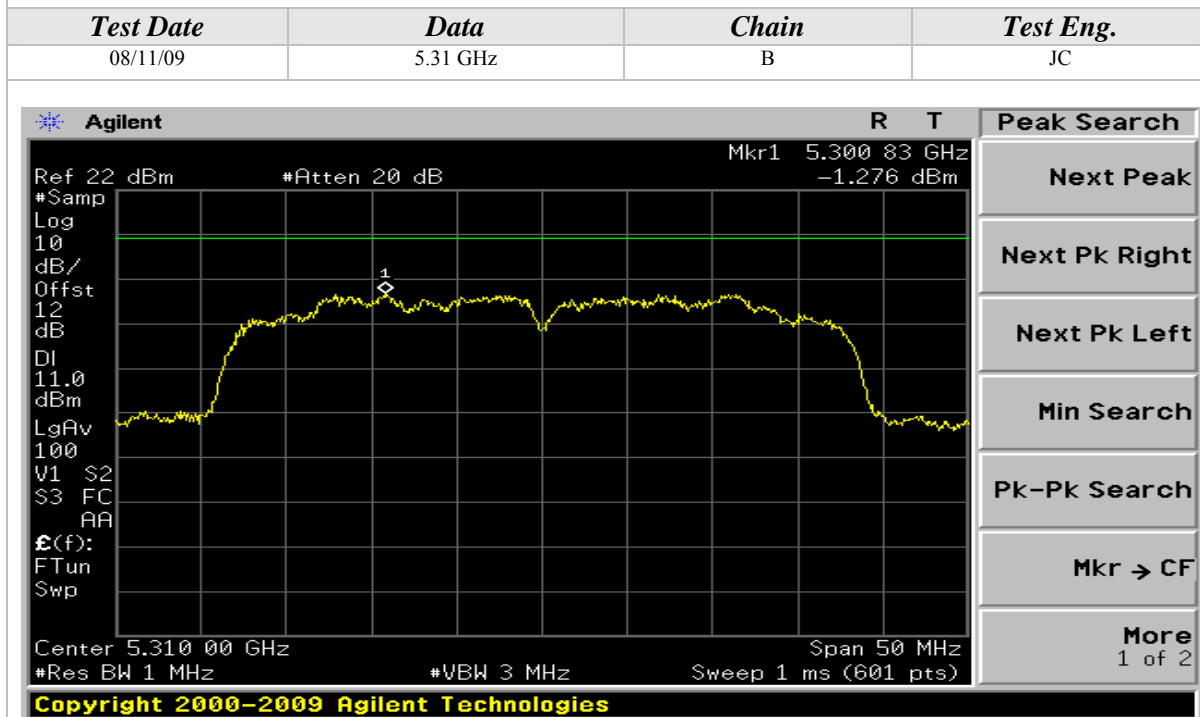
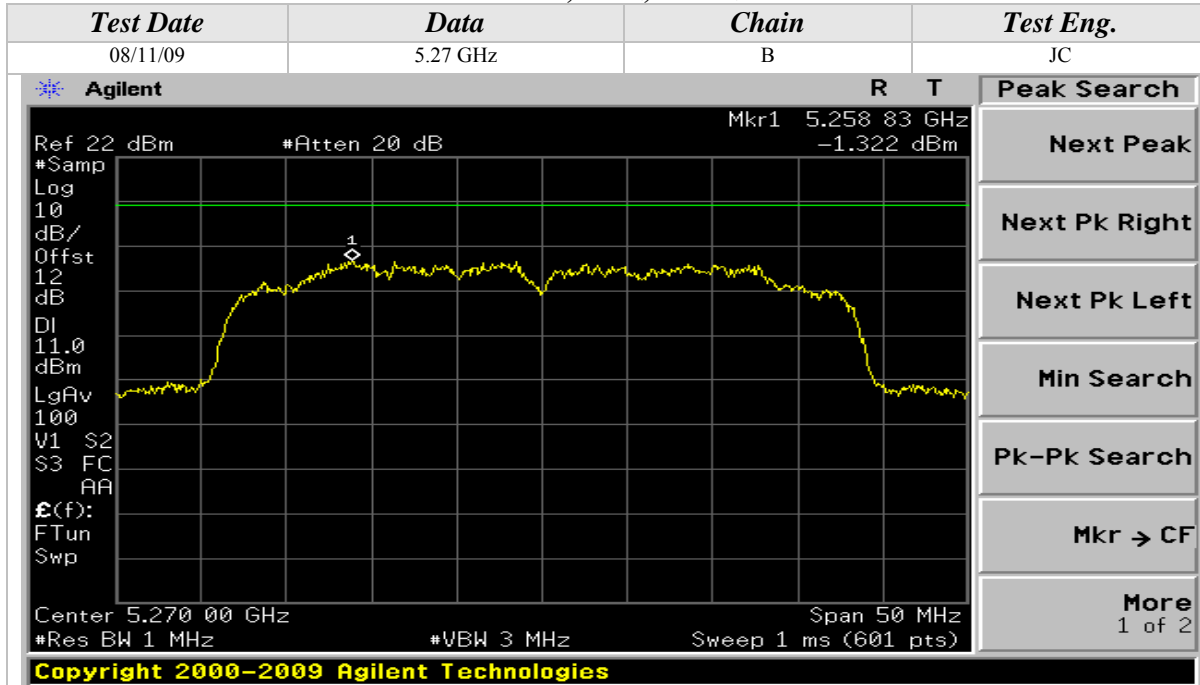



Peak Power Spectral Density (Continued)

802.11n Mode, 5GHz, 40MHz Wide

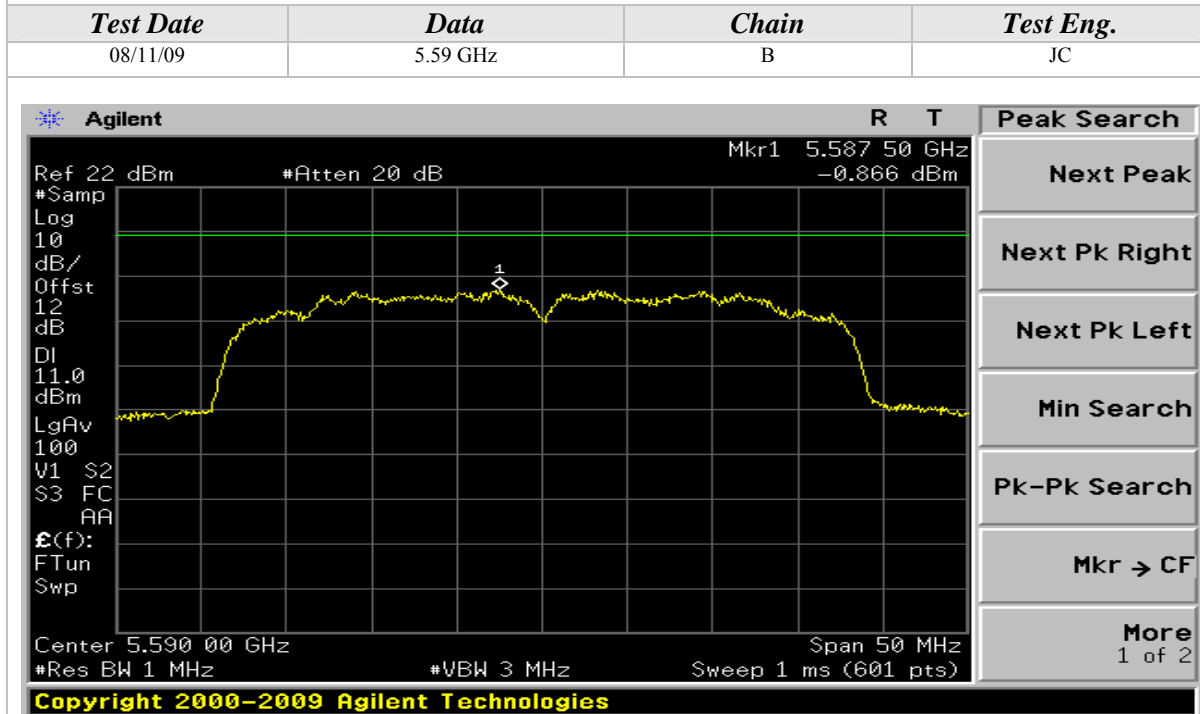

Peak Power Spectral Density (Continued)

802.11n Mode, 5GHz, 40MHz Wide

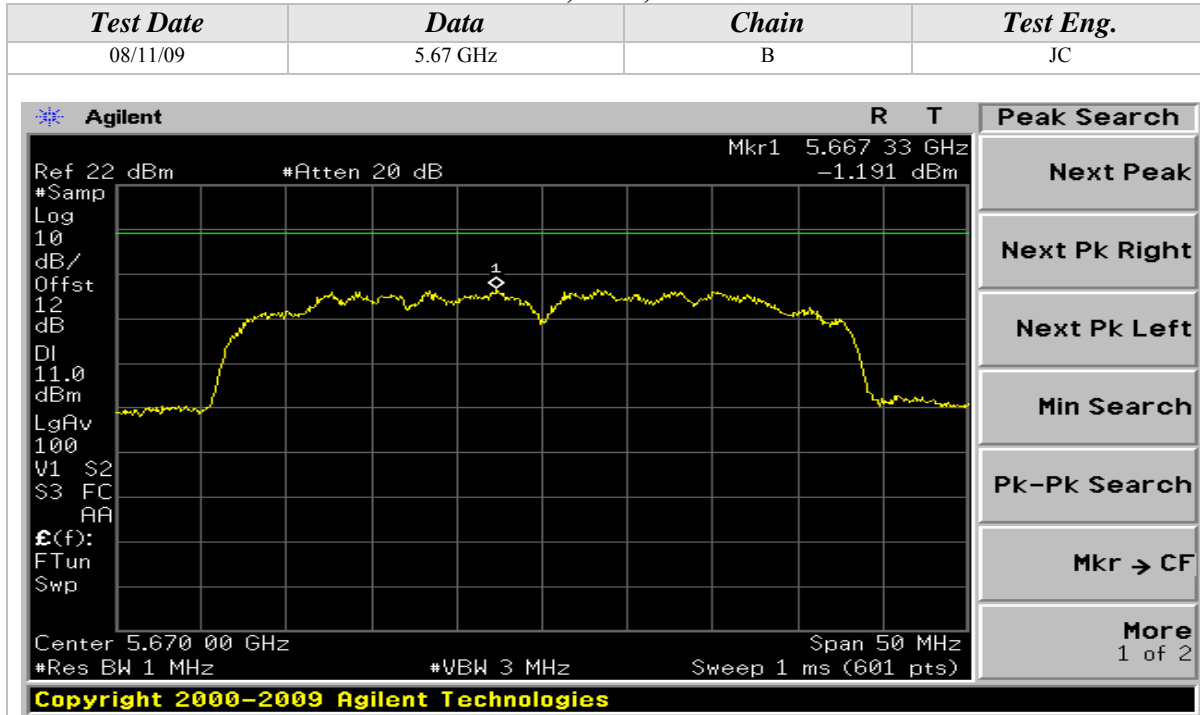

**PEAK EXCURSION**

<b>CLIENT:</b>	Intel Corporation	<b>DATE:</b>	08/12/09
<b>EUT:</b>	Intel WiFi Link 6200	<b>PROJECT NUMBER:</b>	INTEL-090601
<b>MODEL NUMBER:</b>	622ANHMW	<b>TEST ENGINEER:</b>	JC
<b>SERIAL NUMBER:</b>	0015005A70A4	<b>SITE #:</b>	2
<b>CONFIGURATION:</b>	Tested installed in an extender board connected to the host laptop's mini PCI slot	<b>TEMPERATURE:</b>	22 deg. C
		<b>HUMIDITY:</b>	32% RH
		<b>TIME:</b>	9:30 AM

<b>Description:</b>	The ratio of the peak excursion of the modulation envelope to the peak transmit power shall not exceed 13dB across any 1 MHz bandwidth or the emissions bandwidth whichever is less.
<b>Results:</b>	See Data Sheet
<b>Note:</b>	Conducted Emissions Measurements were performed on the EUT with power supply set at the following voltage and frequency. <ul style="list-style-type: none"><li>• 120VAC / 60 Hz.</li></ul>

<b>Peak Power Spectral Density Limits</b>	
<b>Frequency (MHz)</b>	<b>Limit (dBm)</b>
5150-5350	13
5470-5725	13



Peak Excursion (Continued)

802.11a Mode

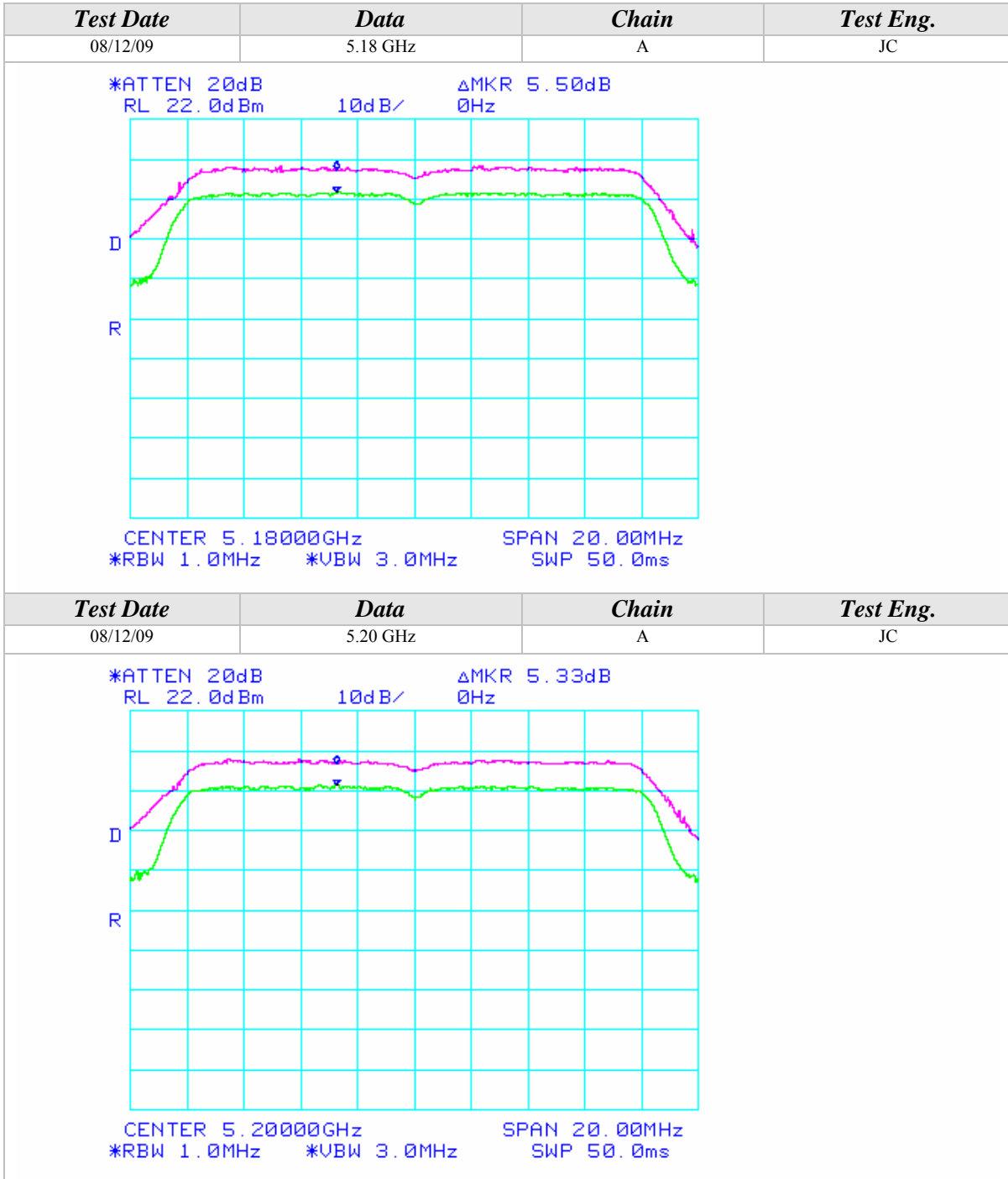



Peak Excursion (Continued)

802.11a Mode

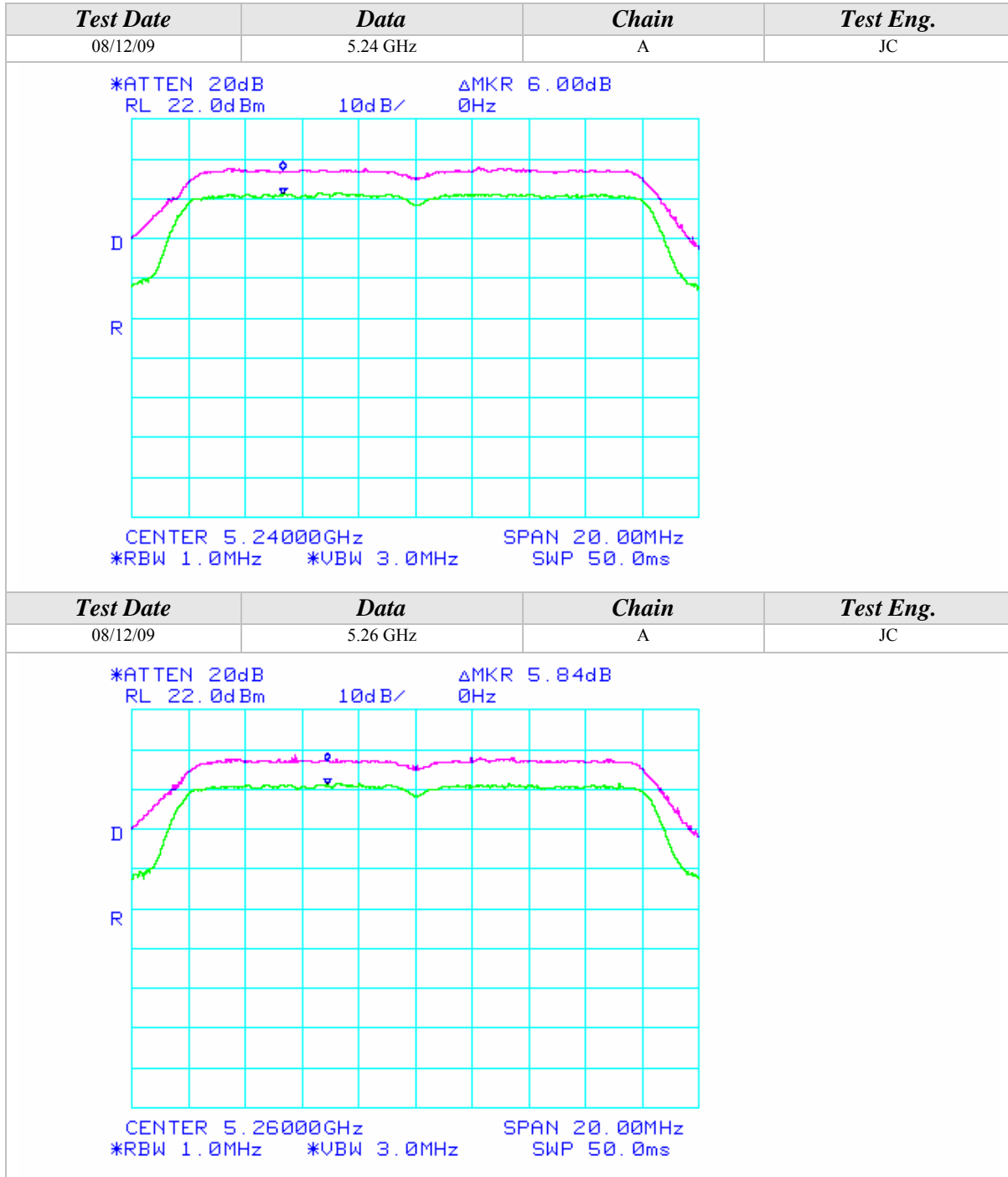

Peak Excursion (Continued)

802.11a Mode

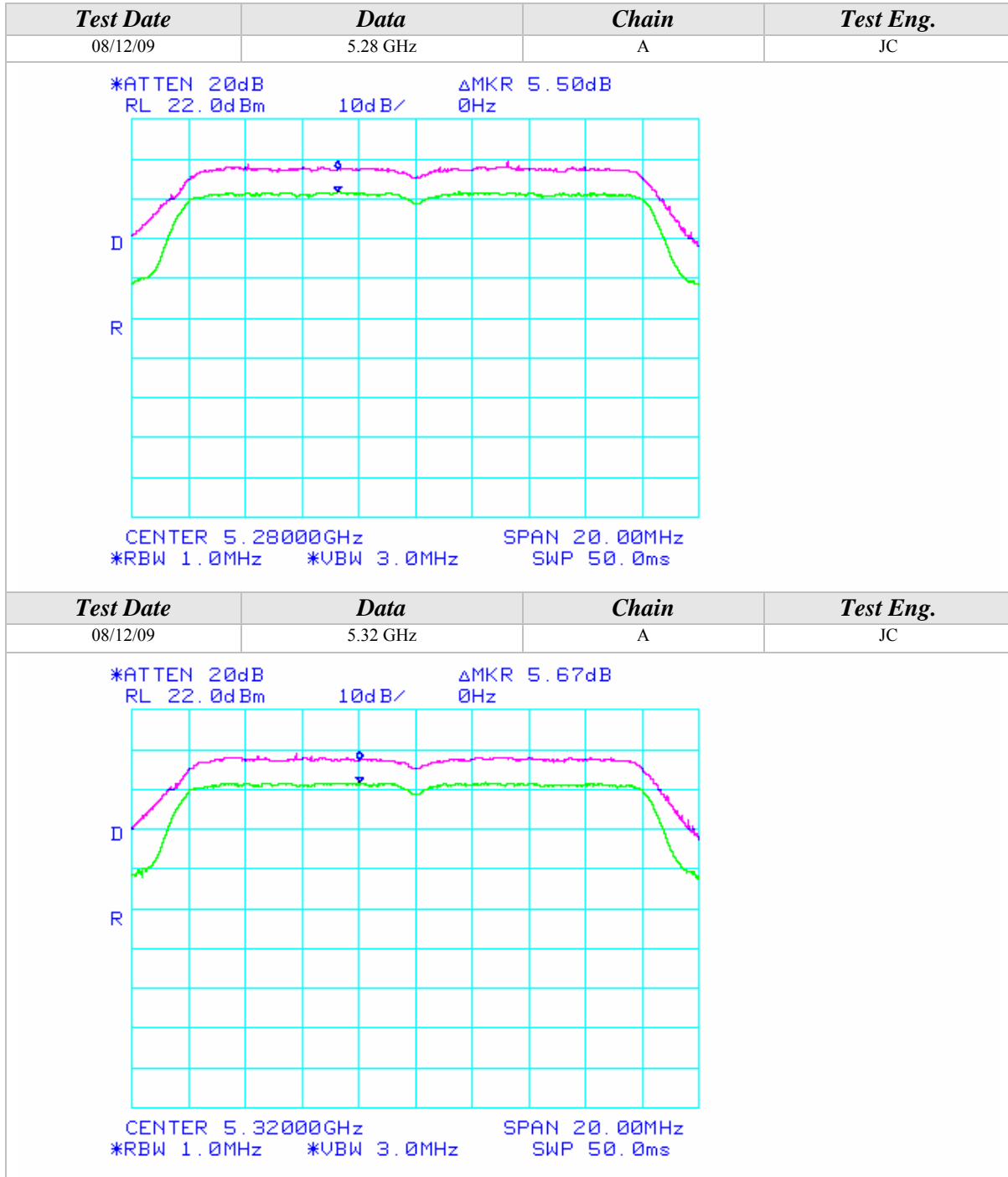



### Peak Excursion (Continued)

#### 802.11a Mode

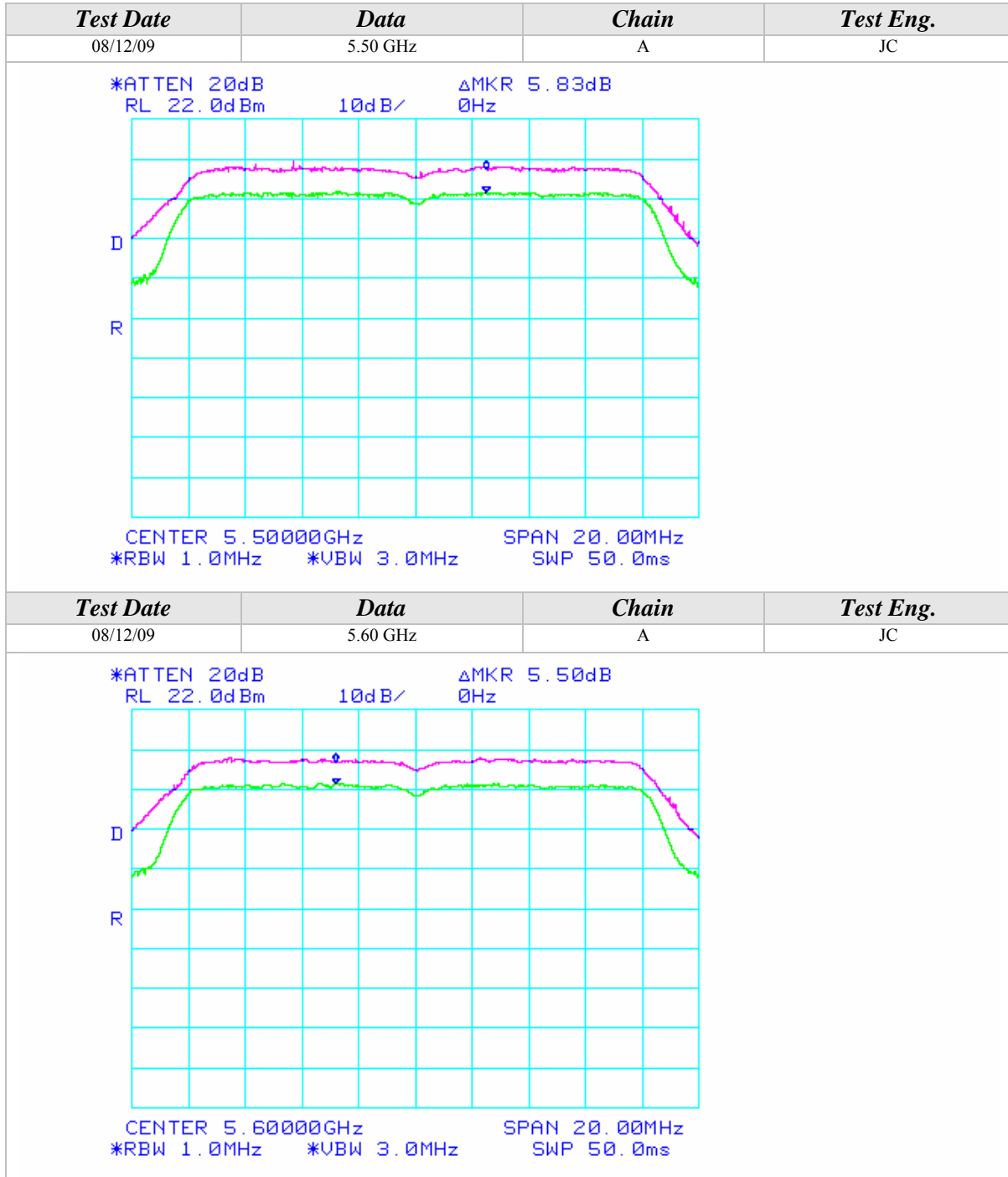



Peak Excursion (Continued)

802.11a Mode

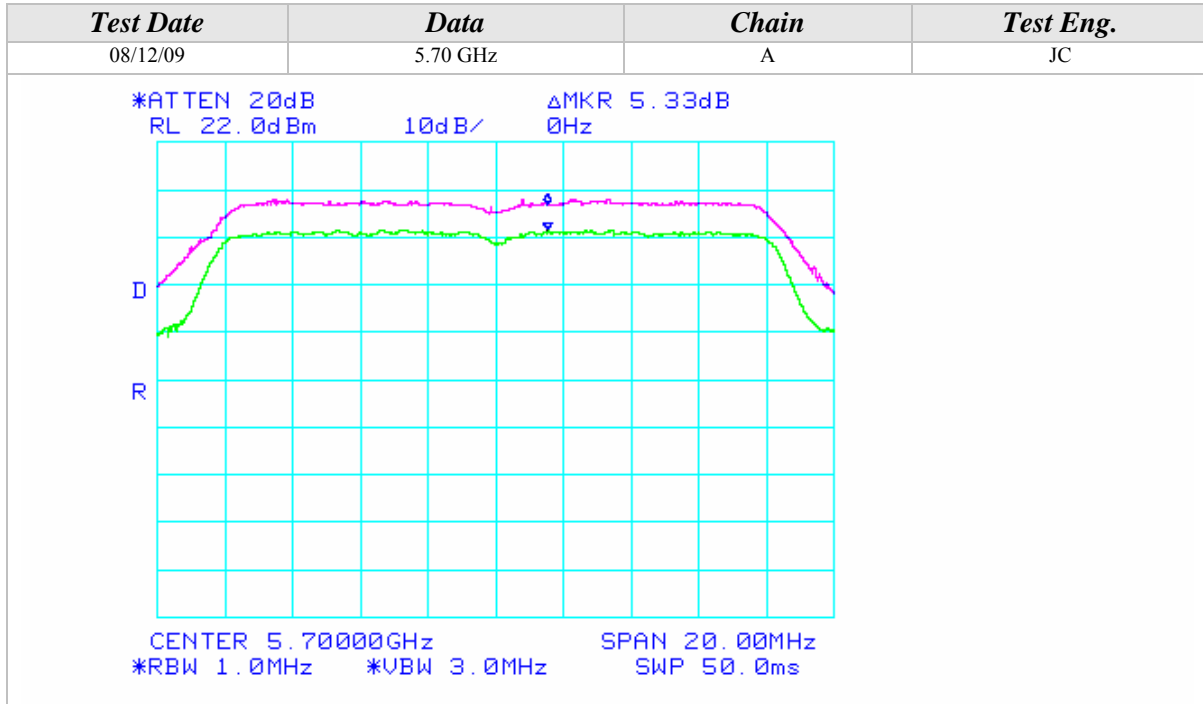



### Peak Excursion (Continued)

#### 802.11n Mode, 5GHz, 20MHz Wide

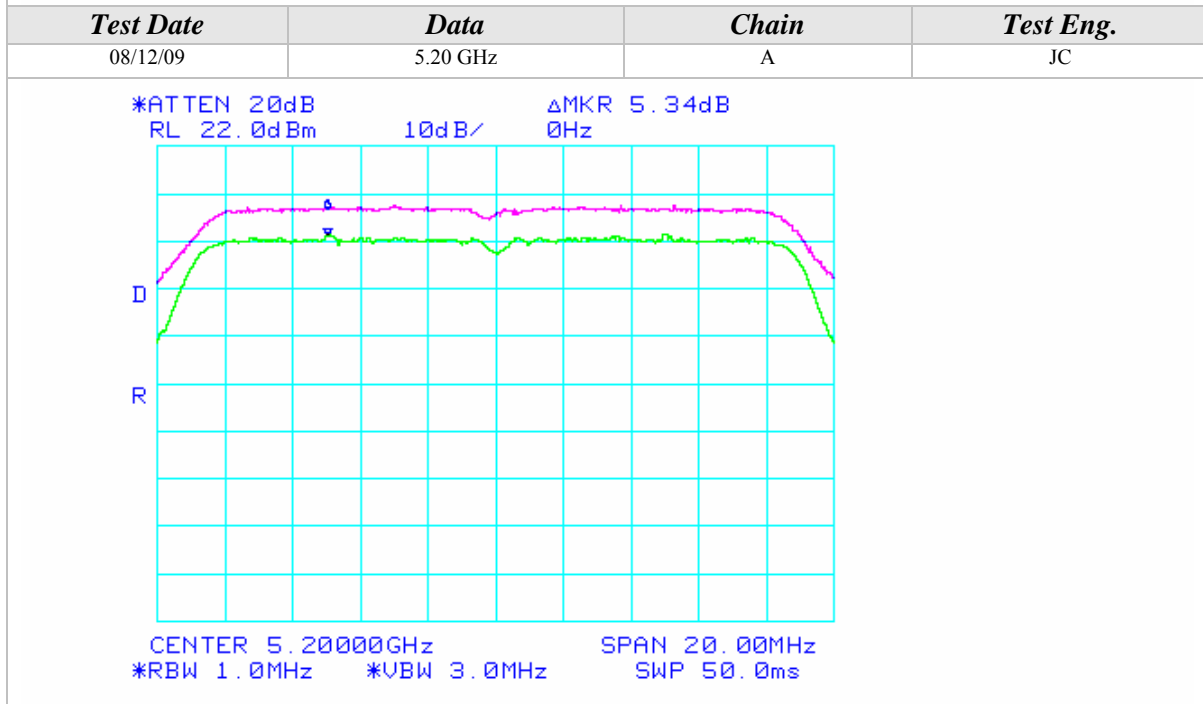
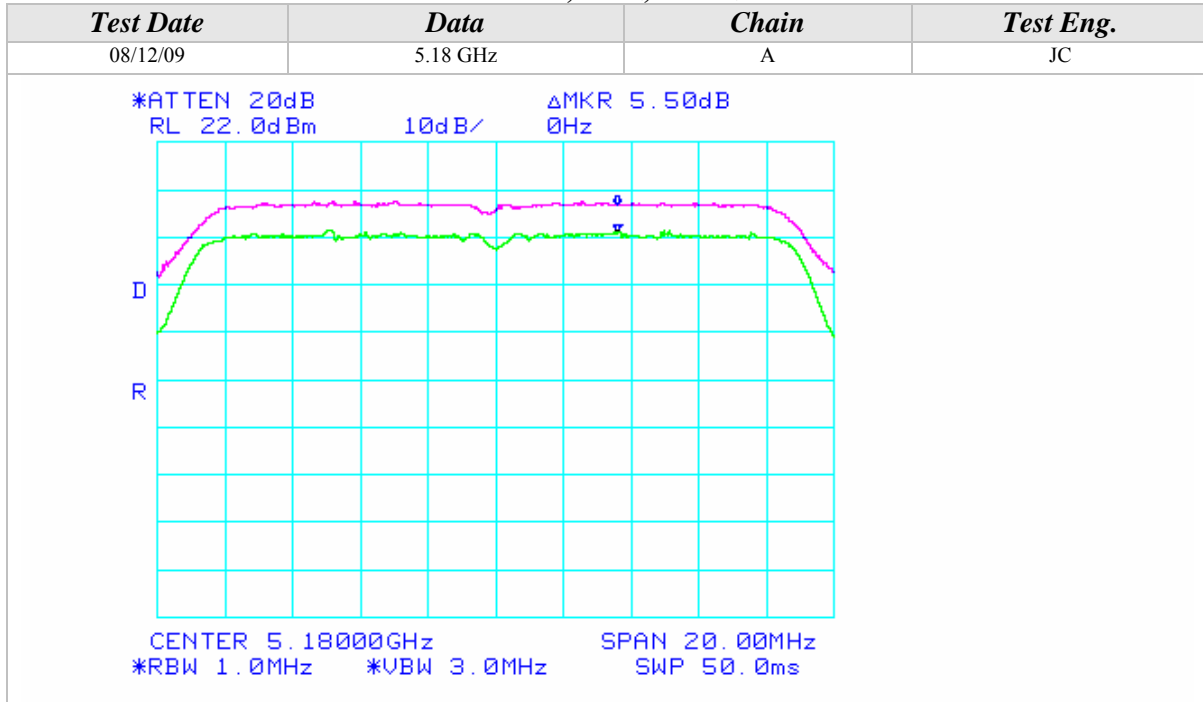

## Peak Excursion (Continued)

## 802.11n Mode, 5GHz, 20MHz Wide

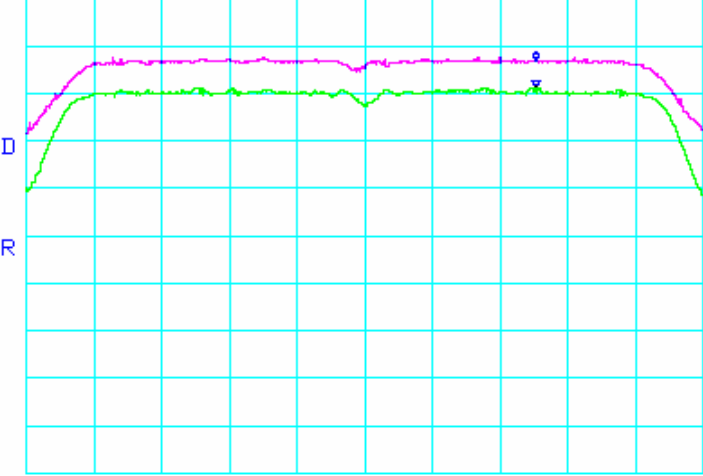
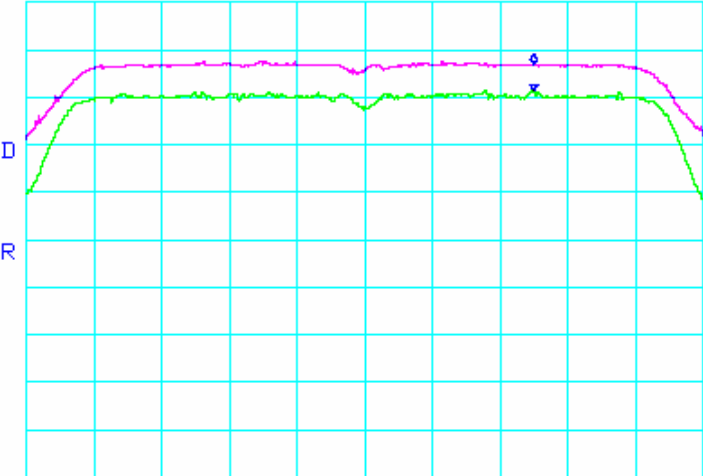
Test Date	Data	Chain	Test Eng.
08/12/09	5.24 GHz	A	JC
<div data-bbox="337 411 938 459">                     *ATTEN 20dB      ΔMKR 5.50dB                      RL 22.0dBm      10dB/      0Hz                 </div>  <div data-bbox="337 947 1036 995">                     CENTER 5.24000GHz      SPAN 20.00MHz                      *RBW 1.0MHz      *VBW 3.0MHz      SWP 50.0ms                 </div>			
Test Date	Data	Chain	Test Eng.
08/12/09	5.26 GHz	A	JC
<div data-bbox="337 1108 938 1157">                     *ATTEN 20dB      ΔMKR 5.50dB                      RL 22.0dBm      10dB/      0Hz                 </div>  <div data-bbox="337 1644 1036 1692">                     CENTER 5.26000GHz      SPAN 20.00MHz                      *RBW 1.0MHz      *VBW 3.0MHz      SWP 50.0ms                 </div>			

Peak Excursion (Continued)

802.11n Mode, 5GHz, 20MHz Wide

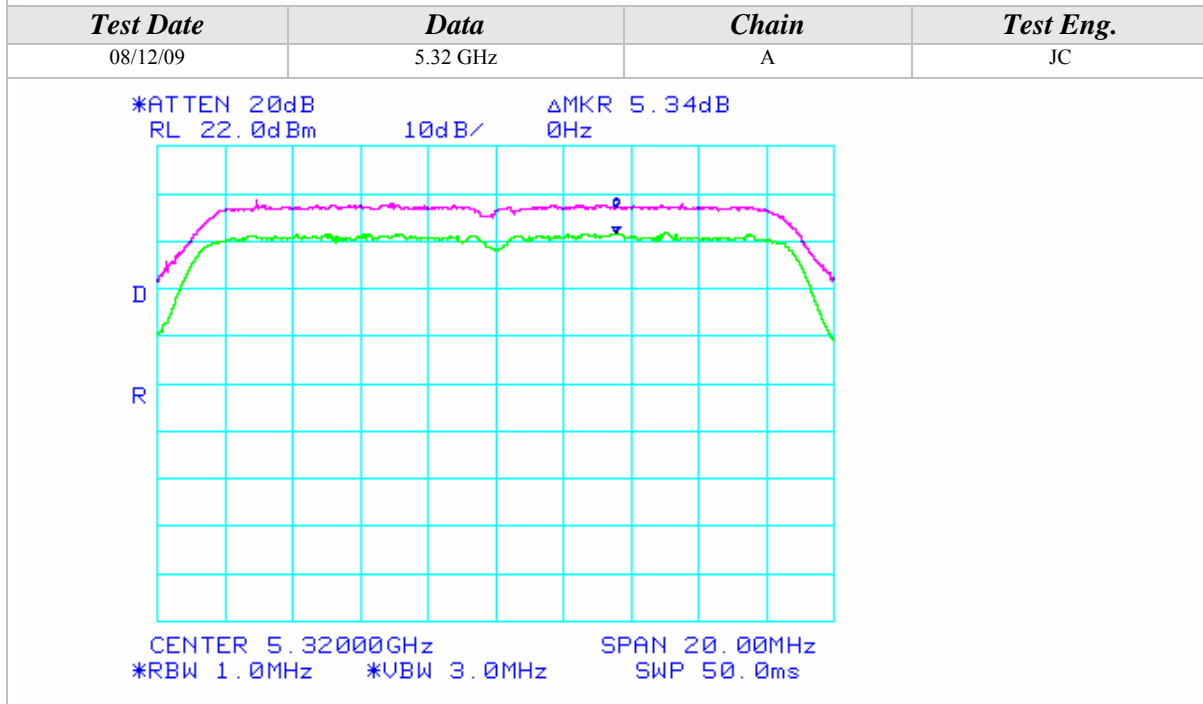
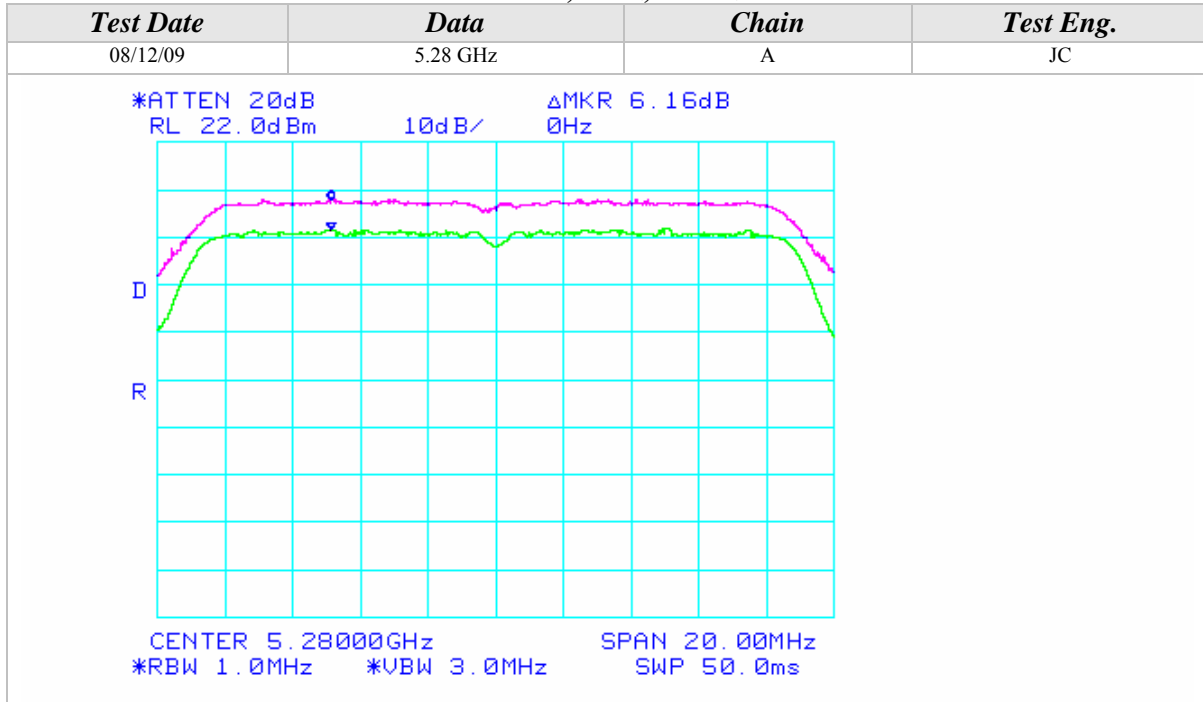

Peak Excursion (Continued)

*802.11n Mode, 5GHz, 20MHz Wide*

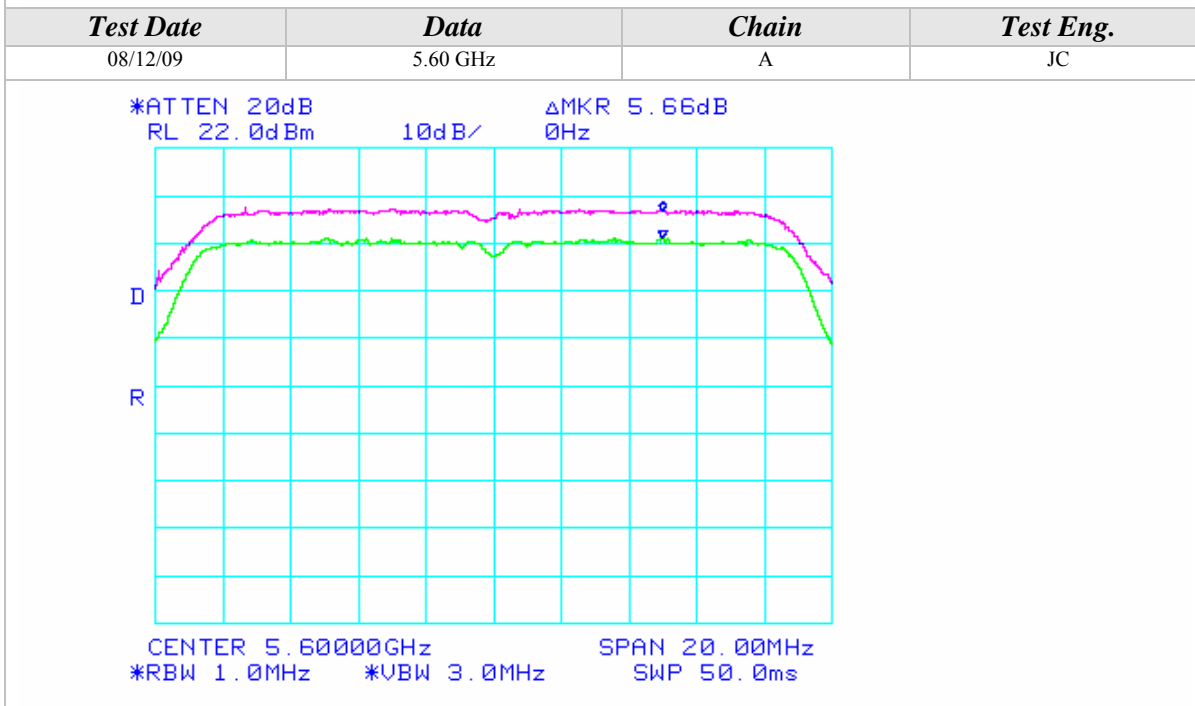
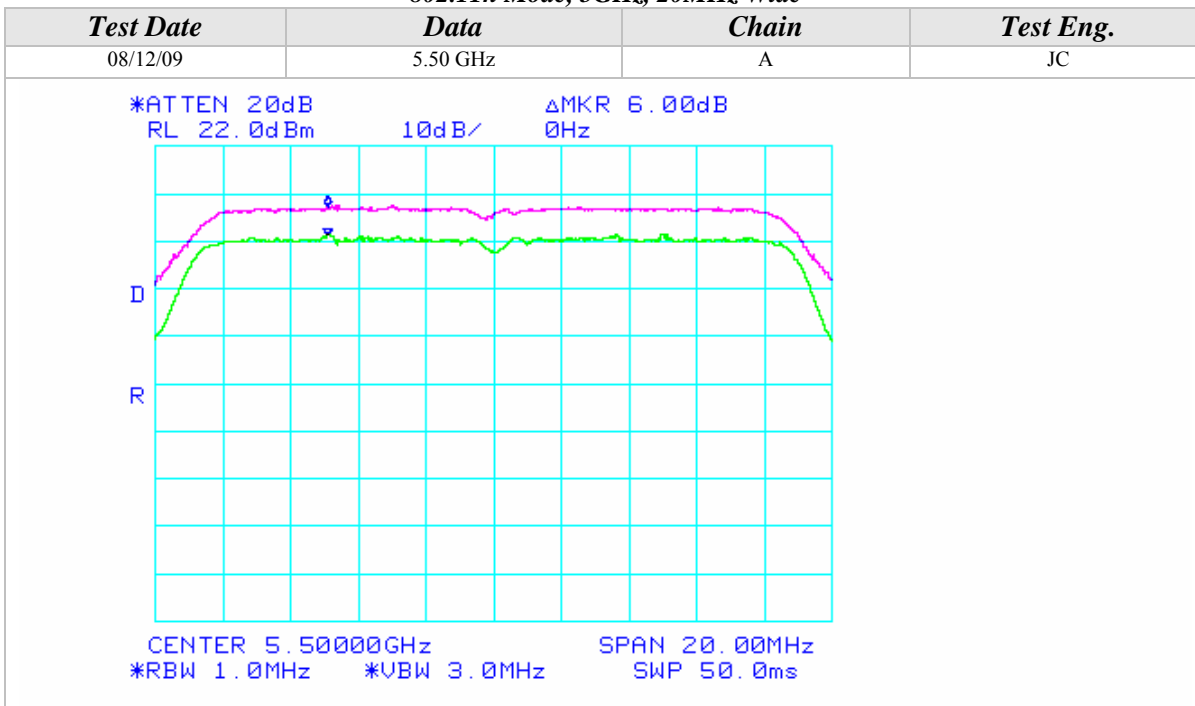



Peak Excursion (Continued)

802.11n Mode, 5GHz, 20MHz Wide

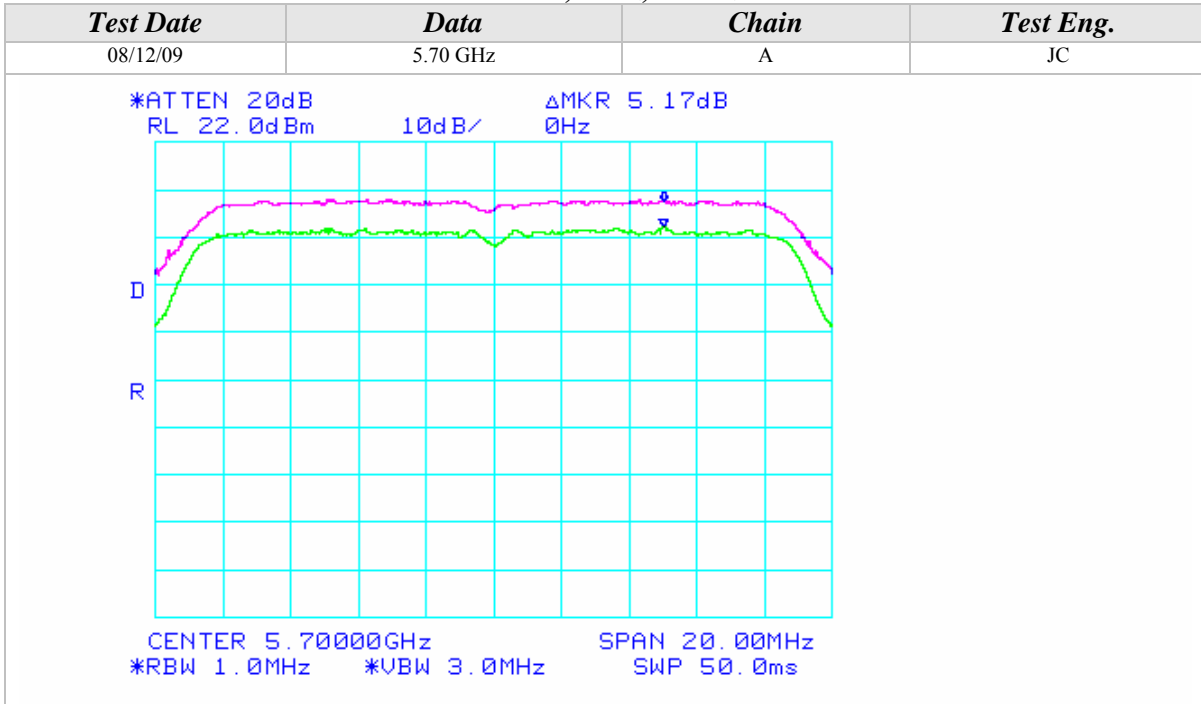

Peak Excursion (Continued)

802.11n Mode, 5GHz, 40MHz Wide

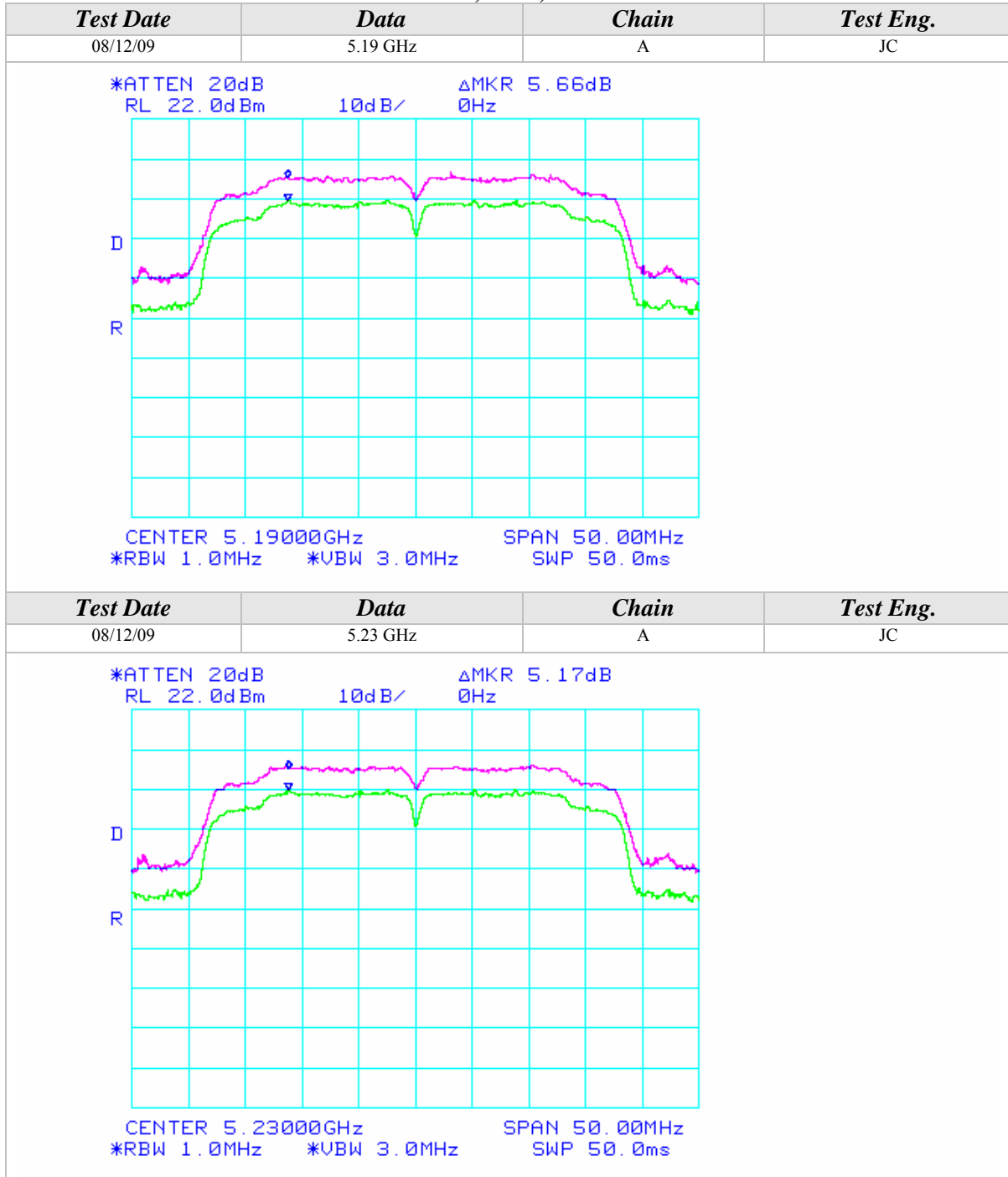

Peak Excursion (Continued)

802.11n Mode, 5GHz, 40MHz Wide

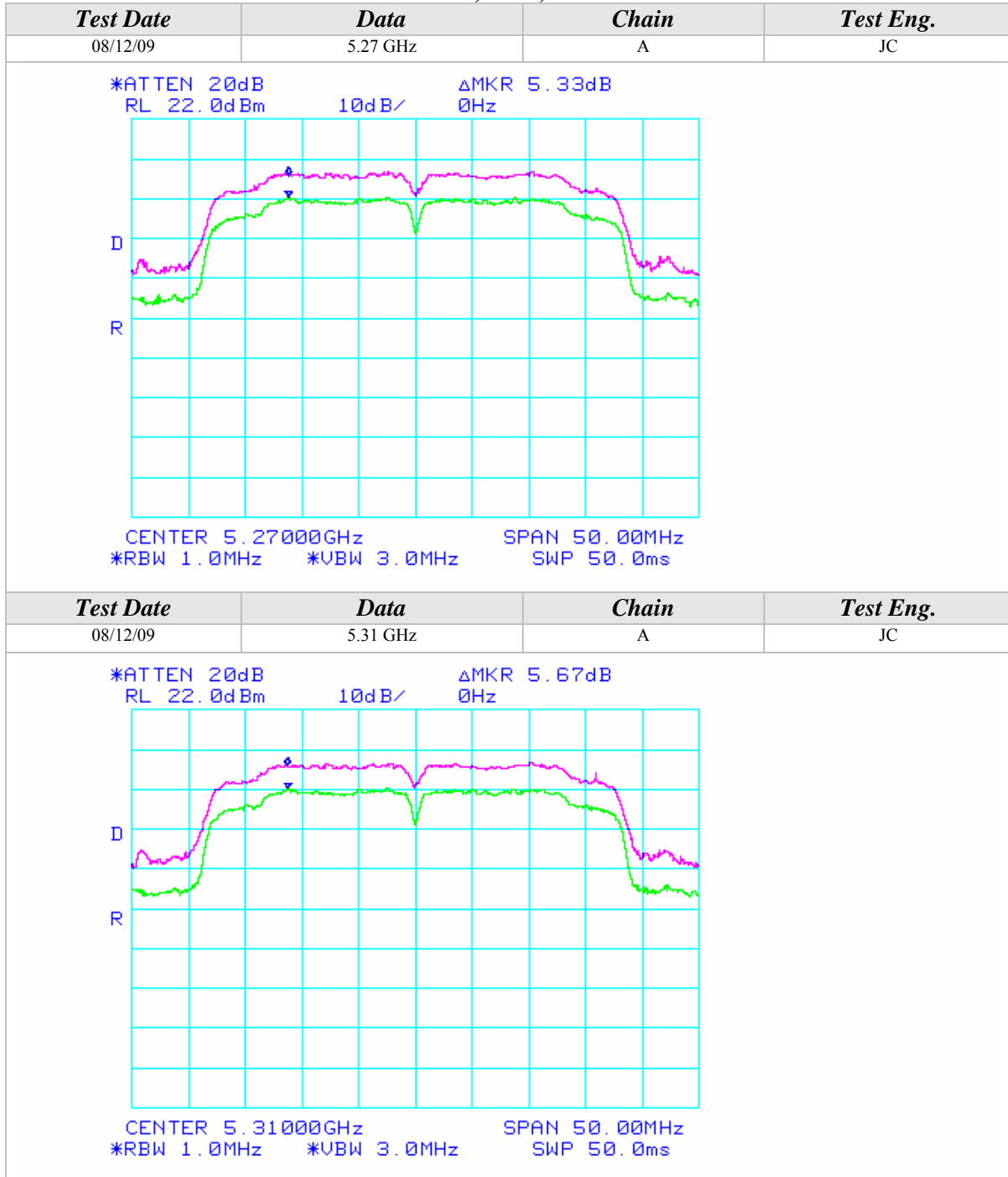



Peak Excursion (Continued)

802.11n Mode, 5GHz, 40MHz Wide

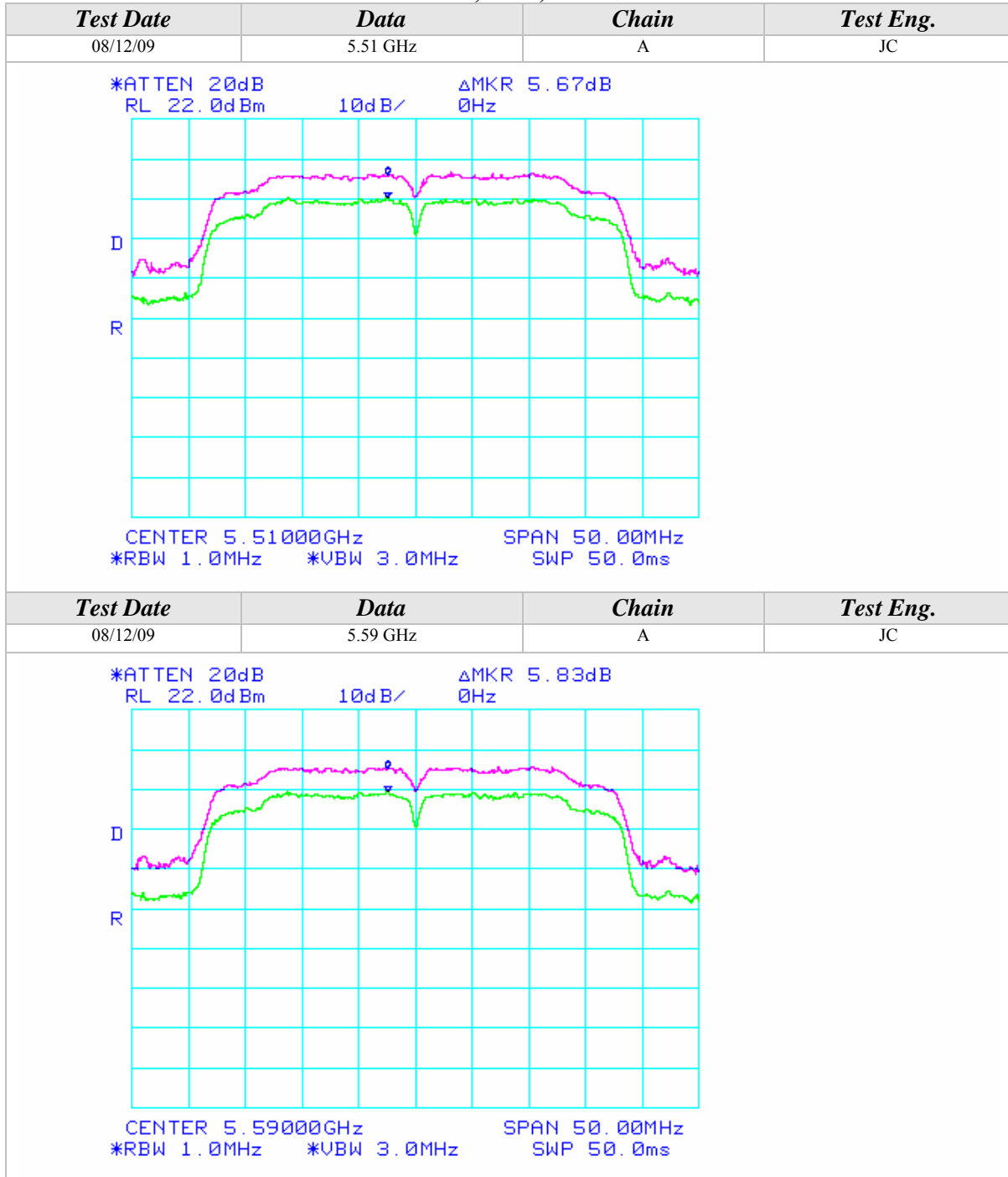

Peak Excursion (Continued)

802.11n Mode, 5GHz, 40MHz Wide

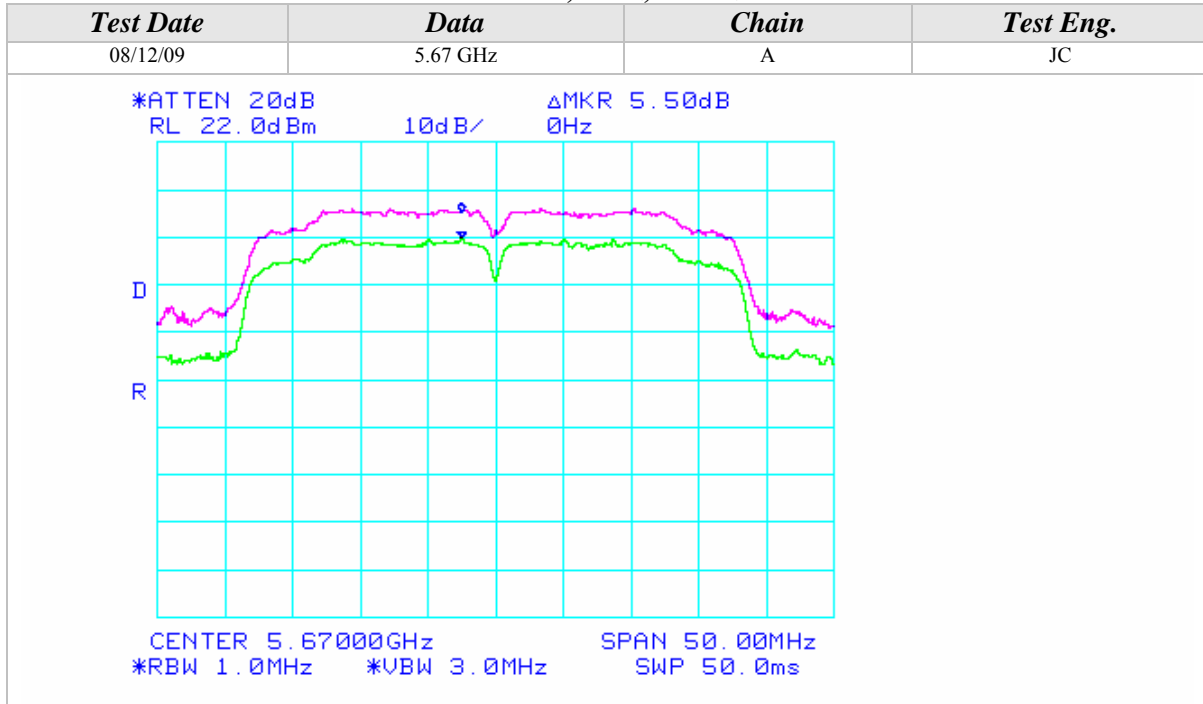



Peak Excursion (Continued)

802.11a Mode

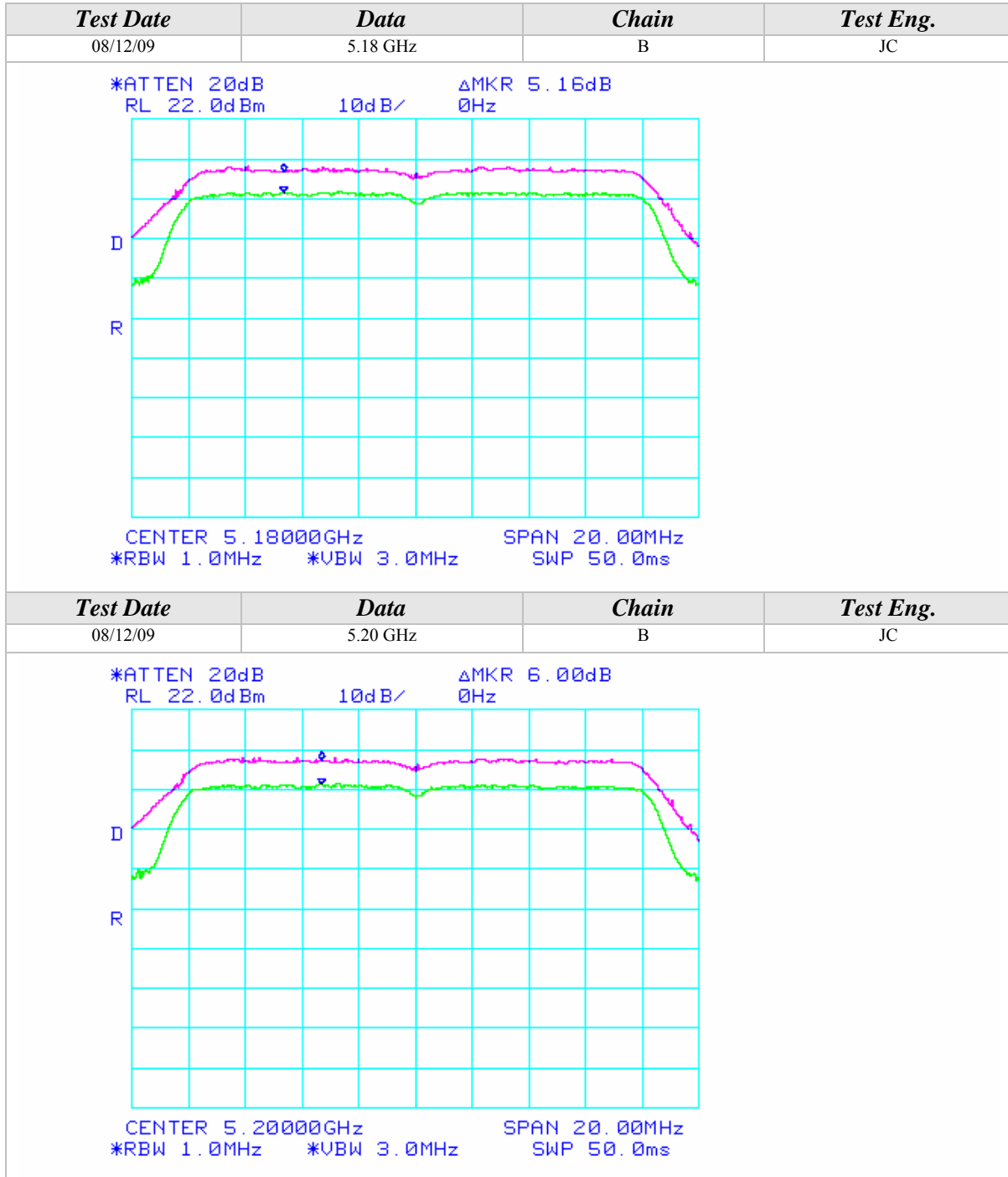



Peak Excursion (Continued)

802.11a Mode

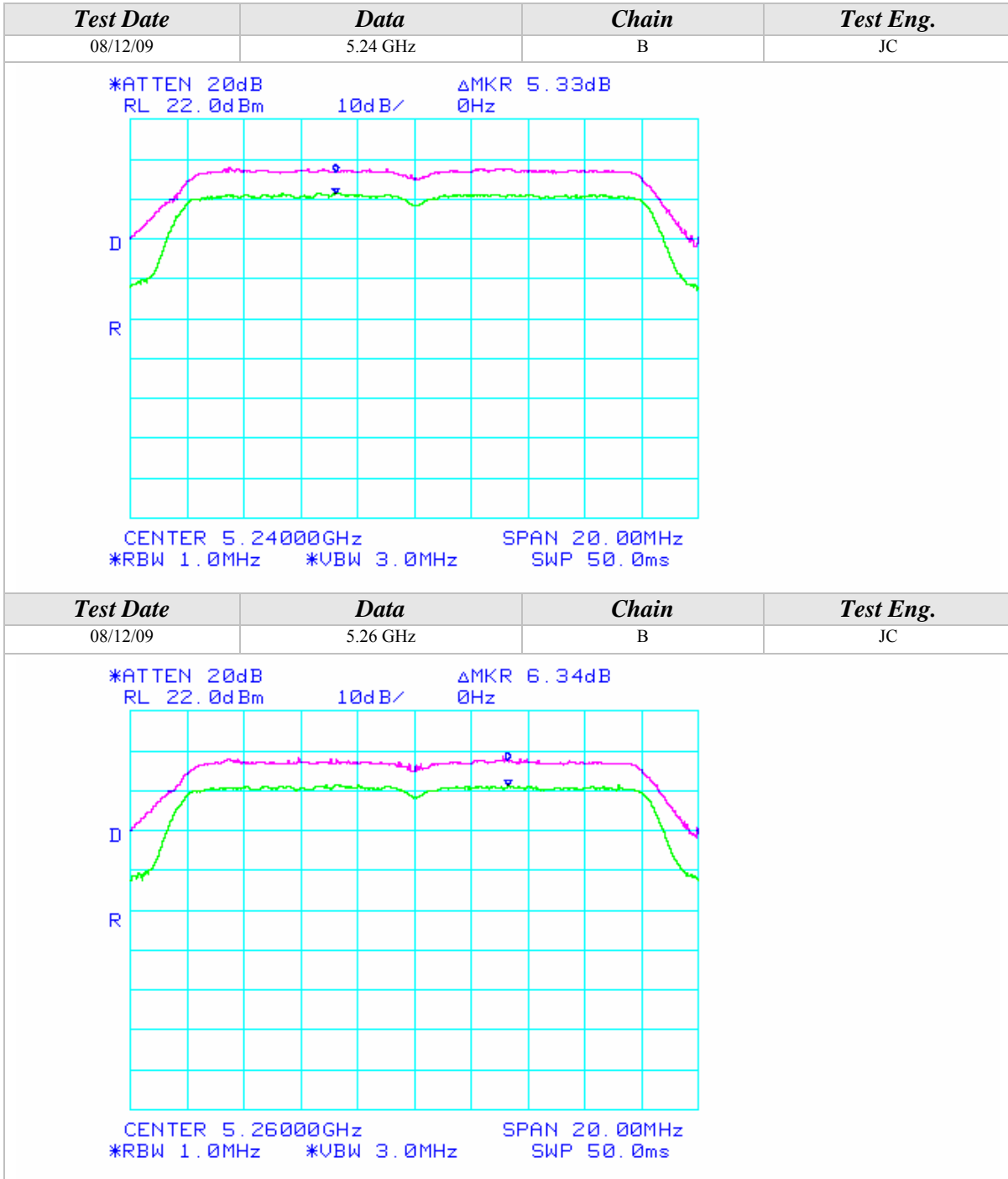

Peak Excursion (Continued)

802.11a Mode

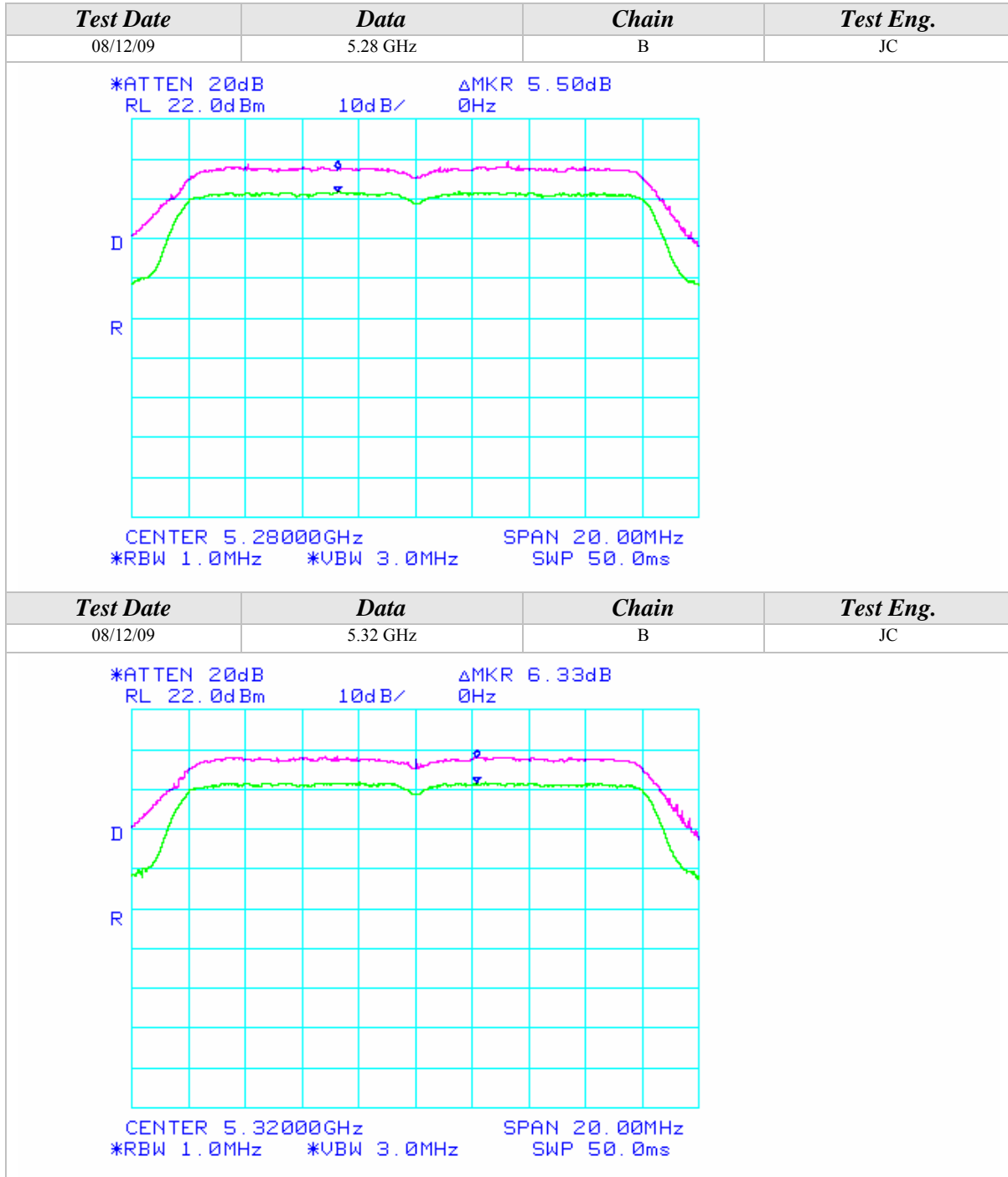

Peak Excursion (Continued)

802.11a Mode

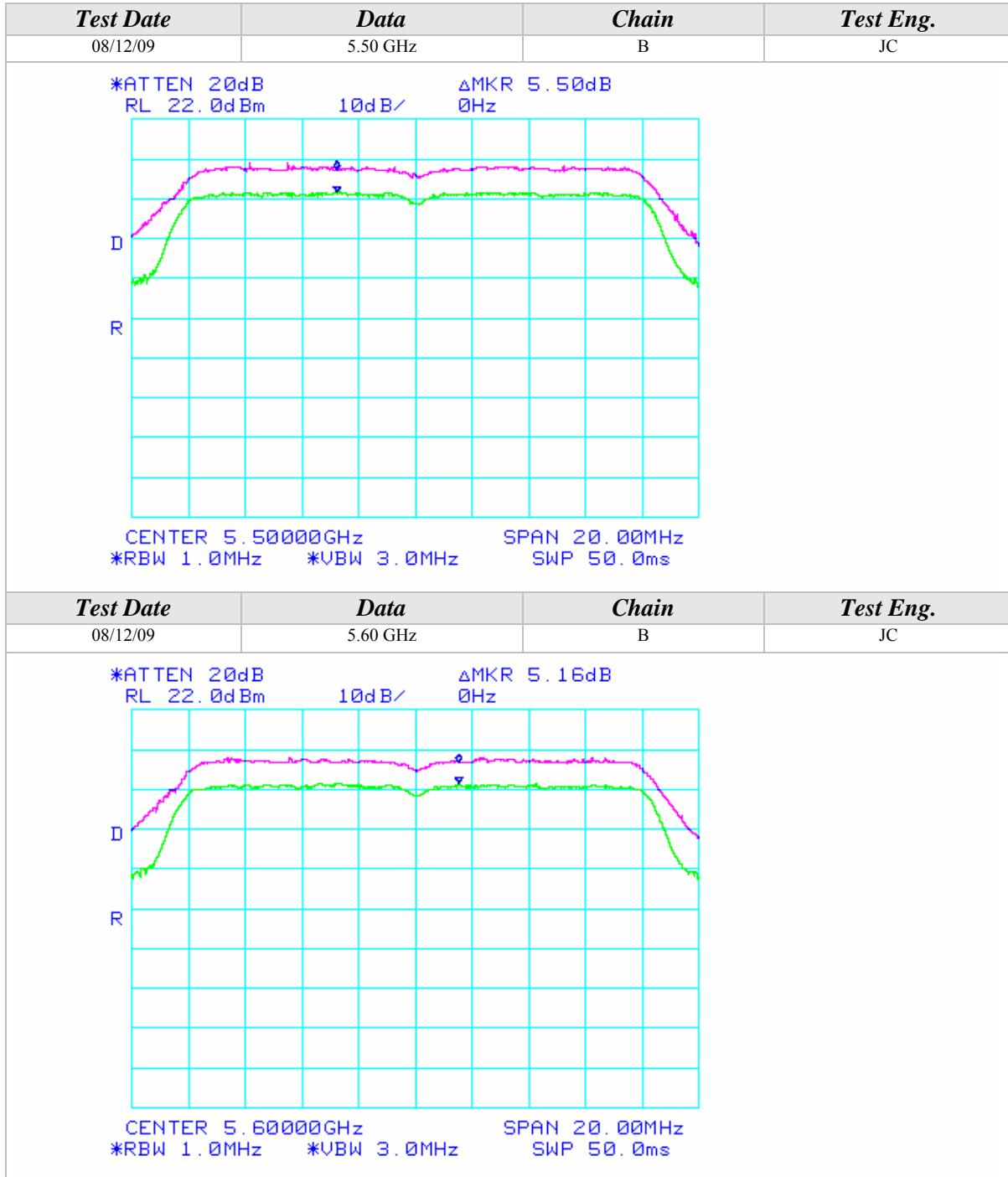



Peak Excursion (Continued)

802.11a Mode

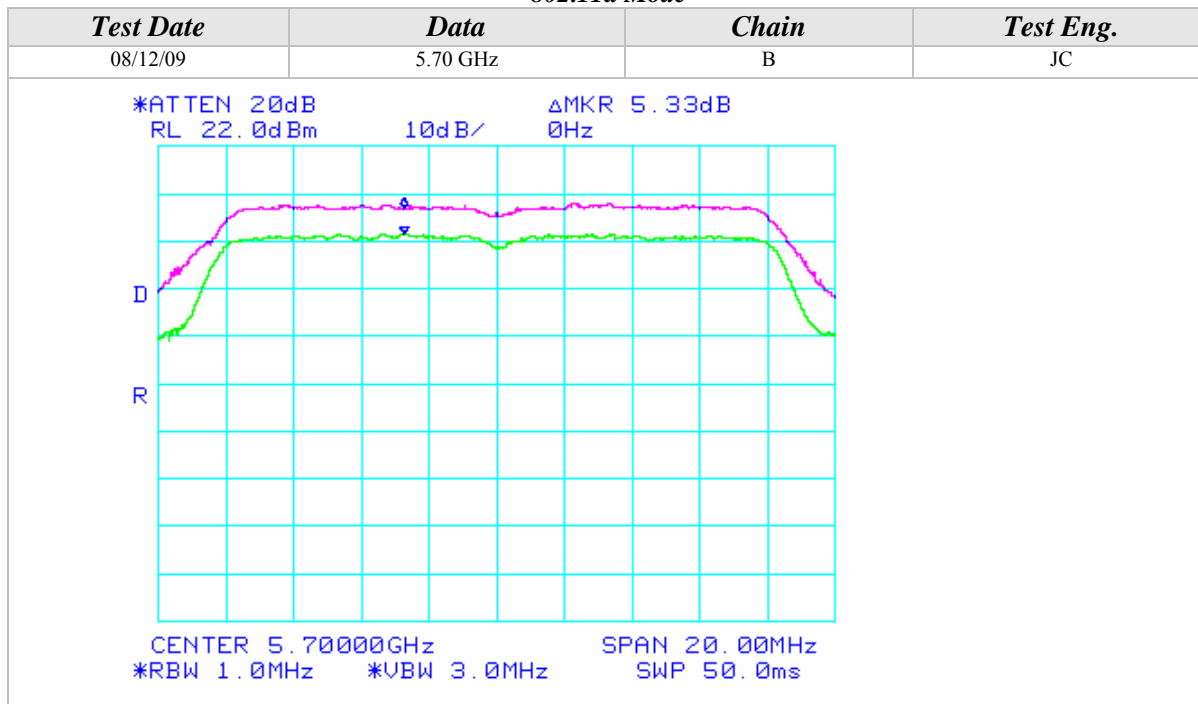

Peak Excursion (Continued)

802.11n Mode, 5GHz, 20MHz Wide

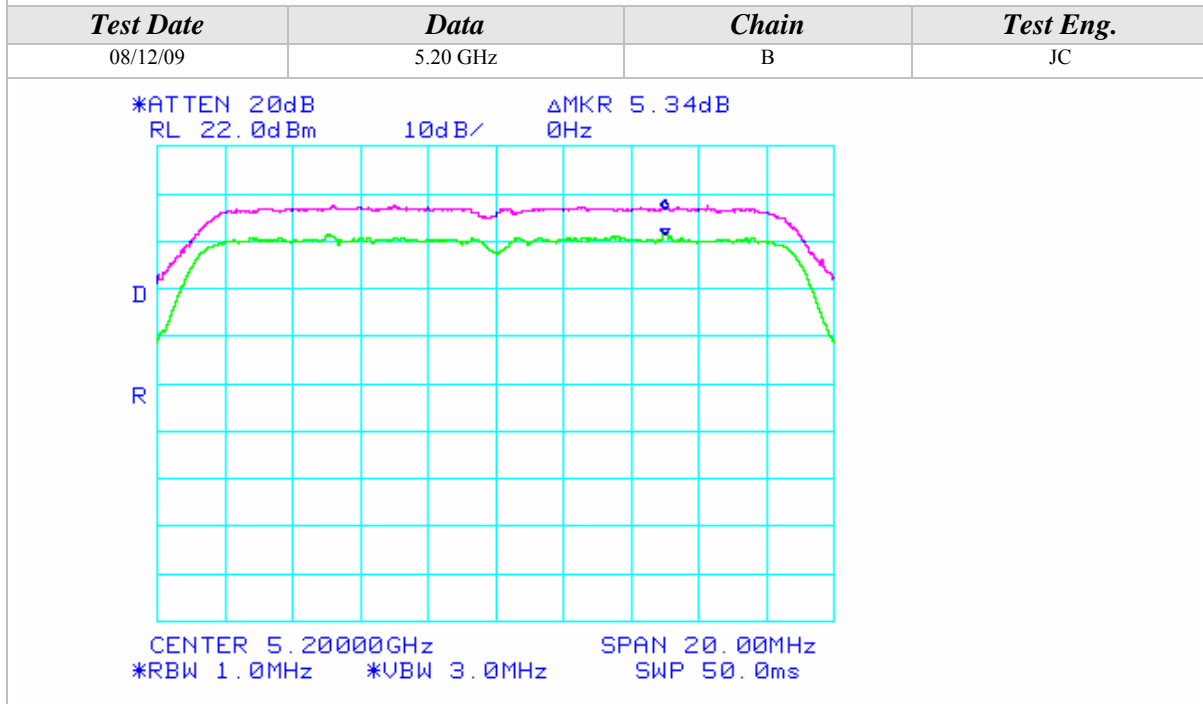
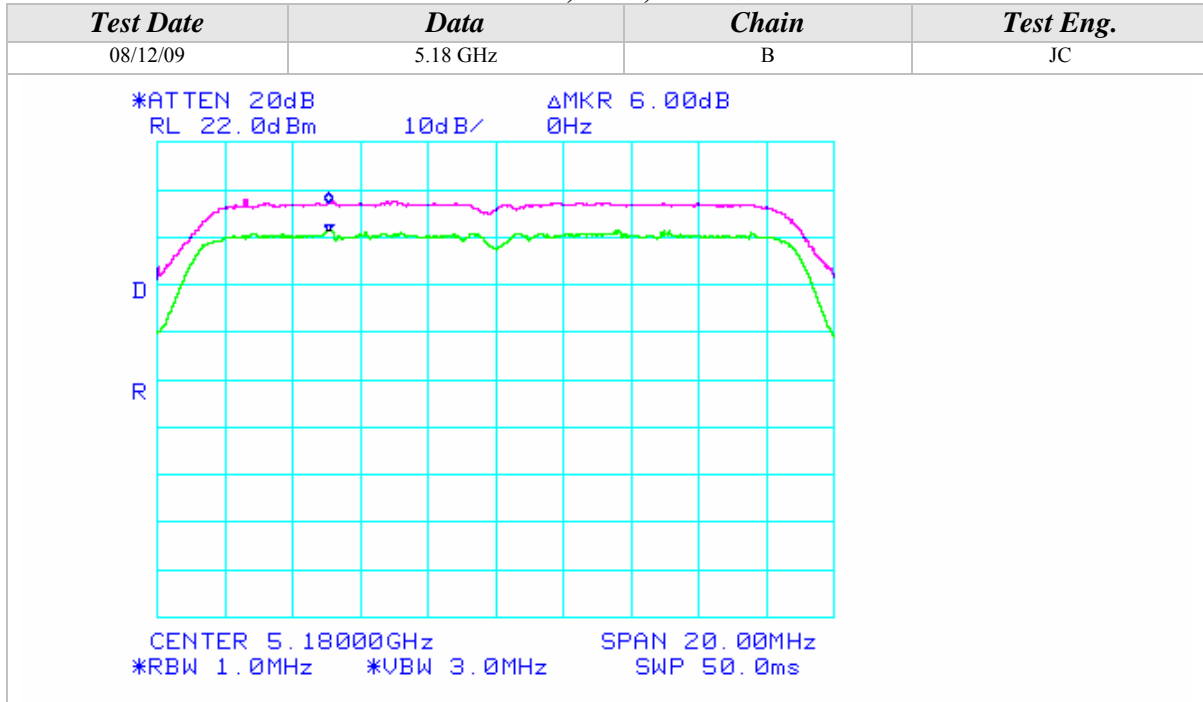



Peak Excursion (Continued)

802.11n Mode, 5GHz, 20MHz Wide

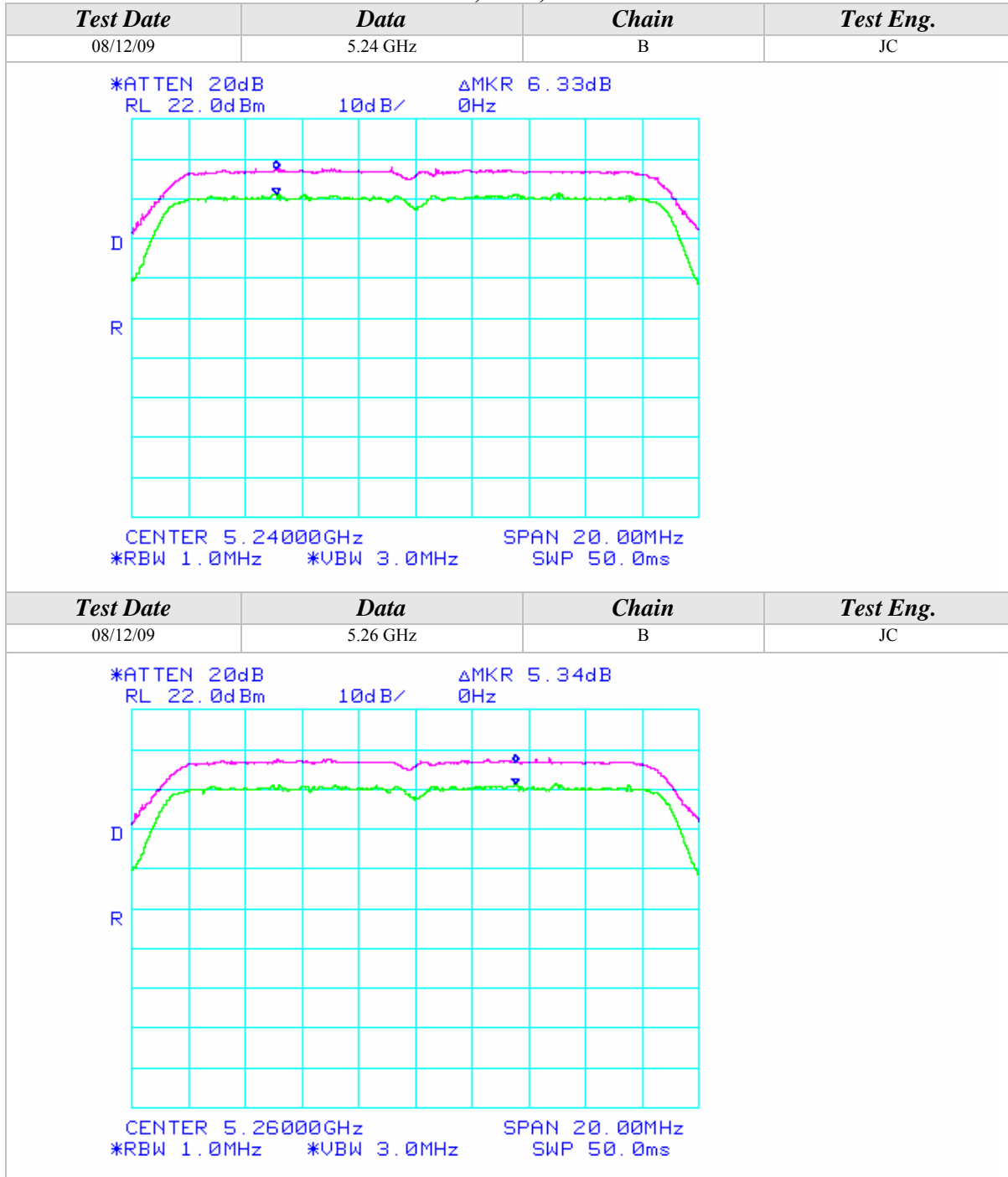

Peak Excursion (Continued)

802.11n Mode, 5GHz, 20MHz Wide

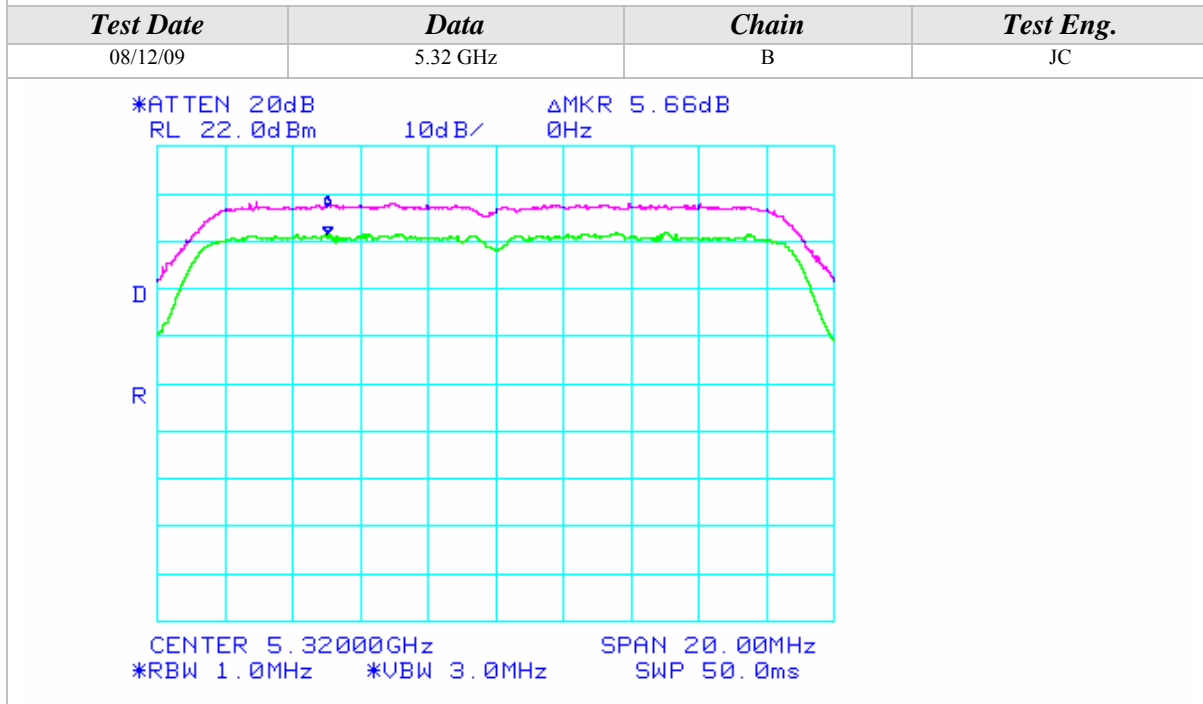
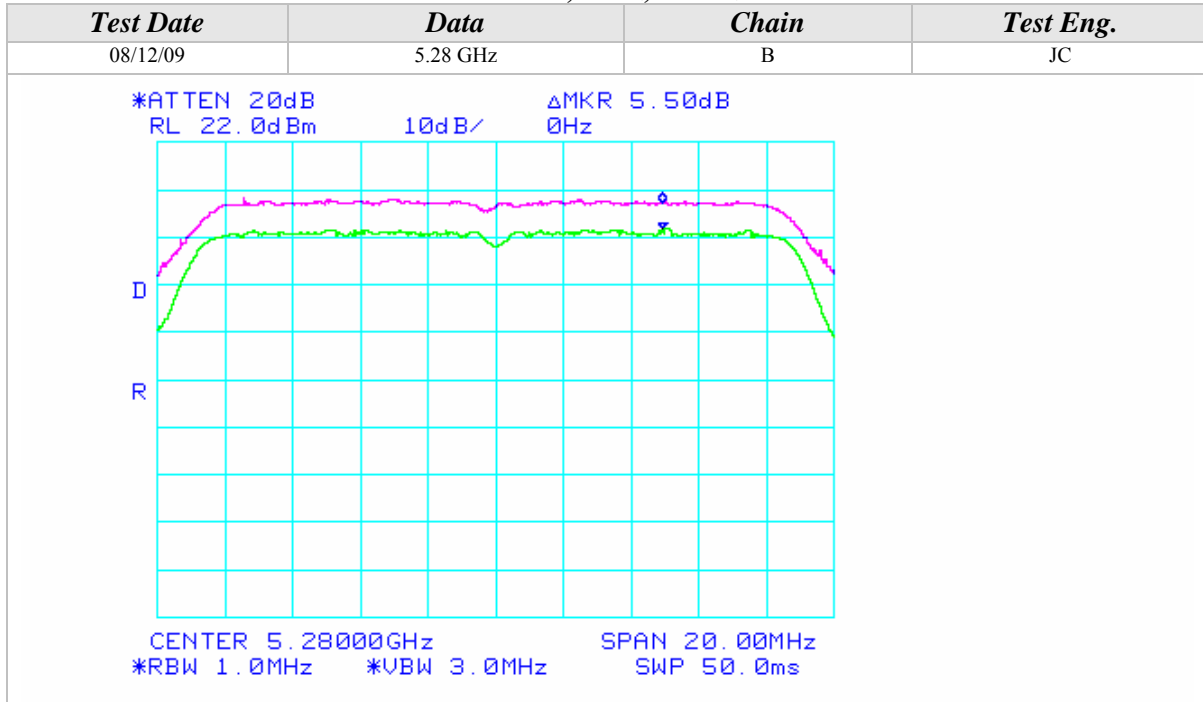



### Peak Excursion (Continued)

#### 802.11n Mode, 5GHz, 20MHz Wide

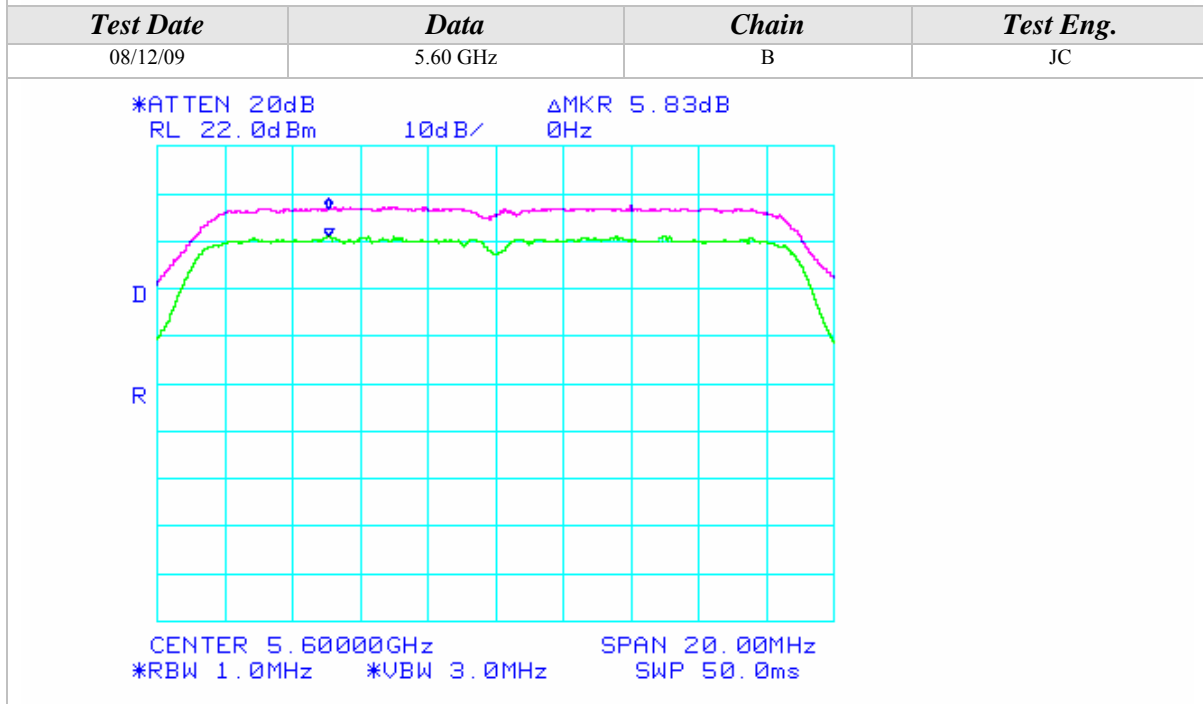
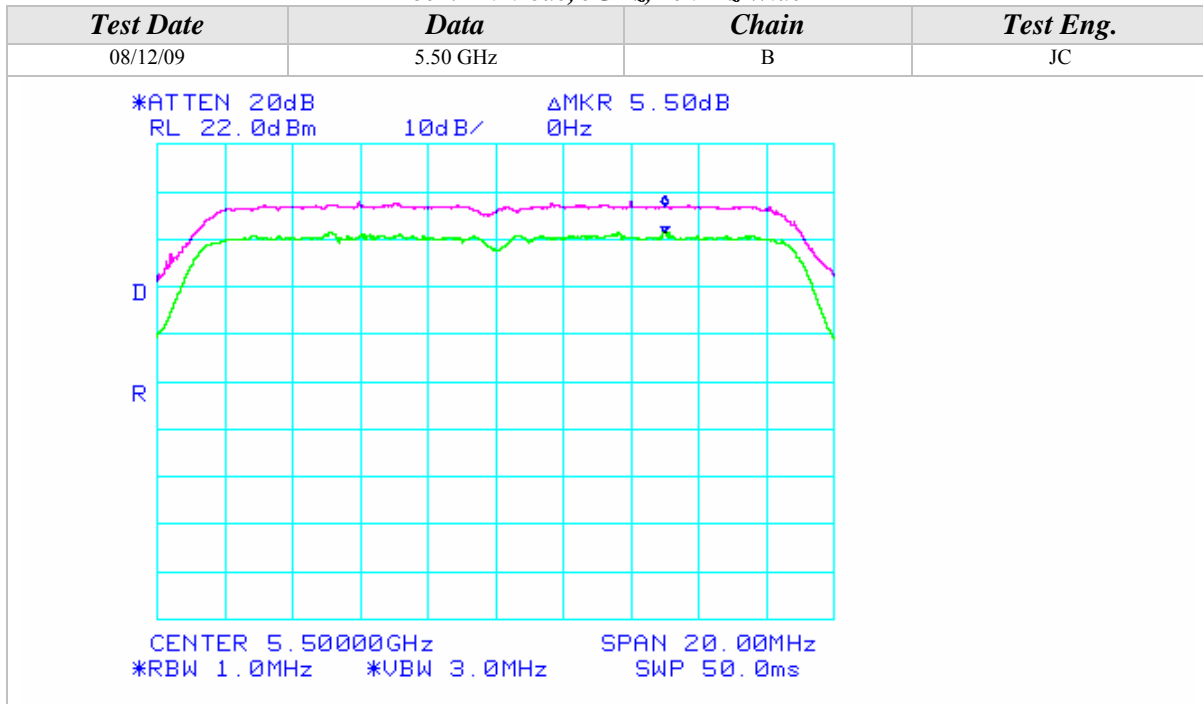

Peak Excursion (Continued)

802.11n Mode, 5GHz, 20MHz Wide

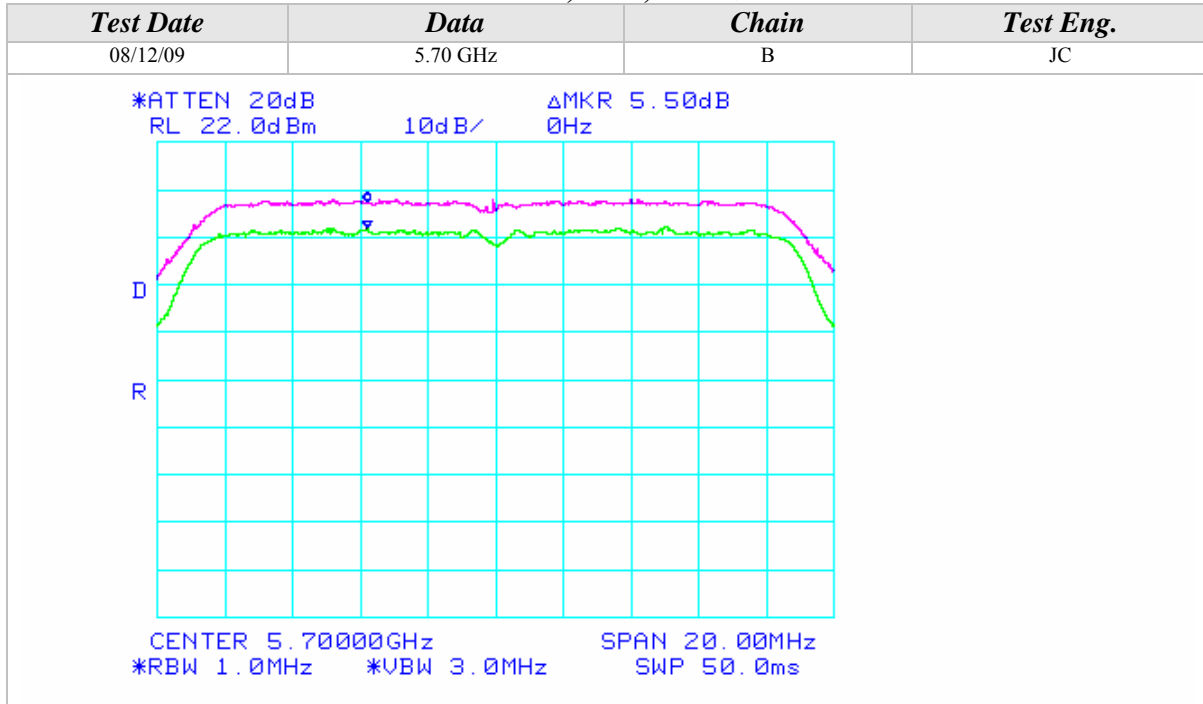



### Peak Excursion (Continued)

#### 802.11n Mode, 5GHz, 40MHz Wide

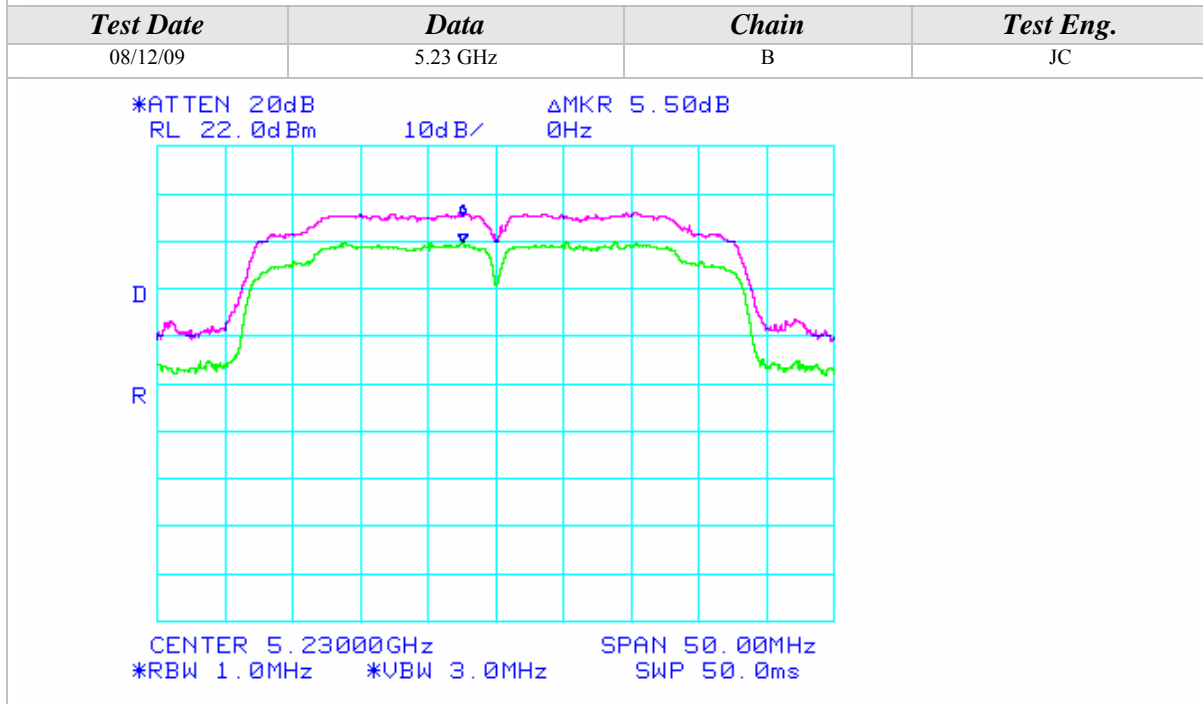
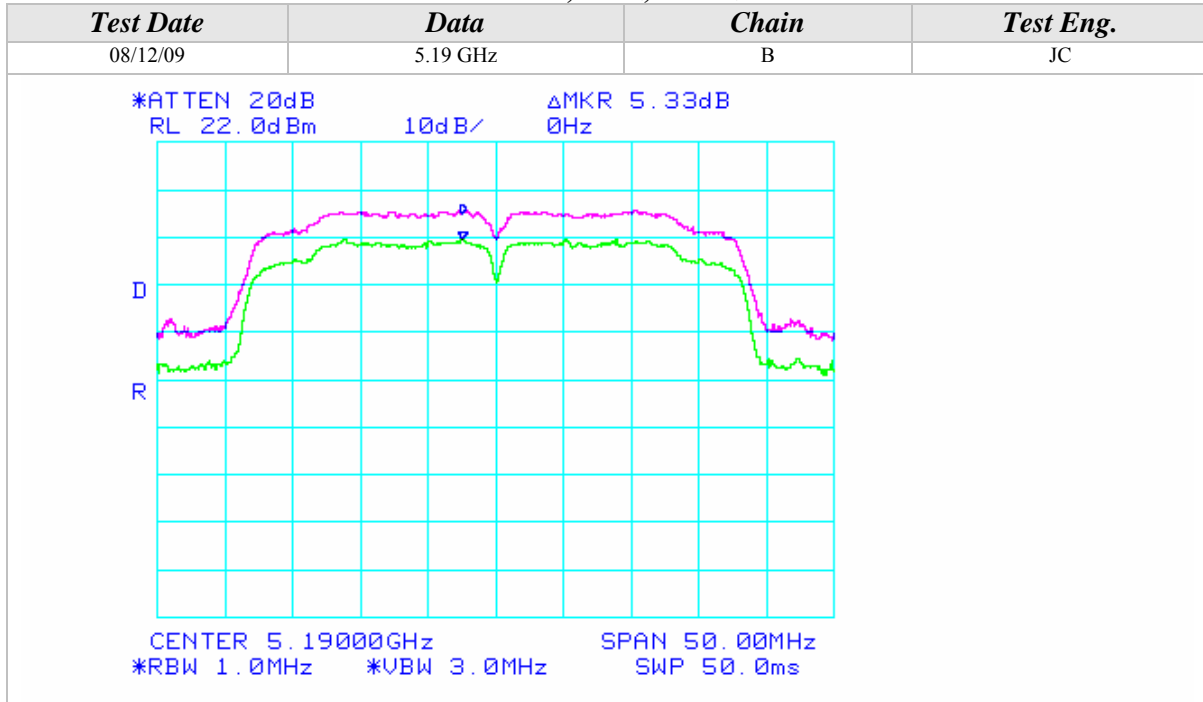



Peak Excursion (Continued)

802.11n Mode, 5GHz, 40MHz Wide

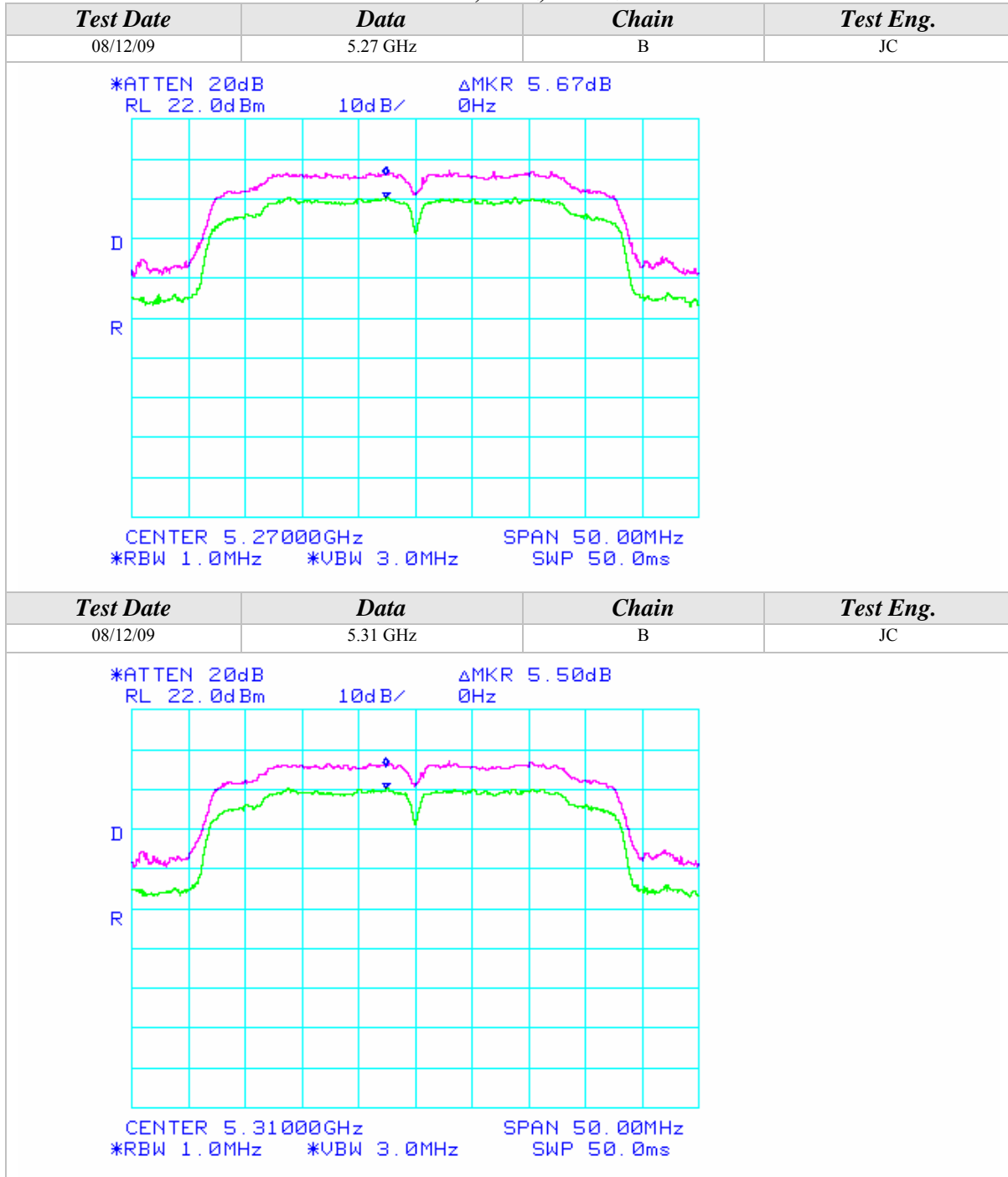

Peak Excursion (Continued)

802.11n Mode, 5GHz, 40MHz Wide

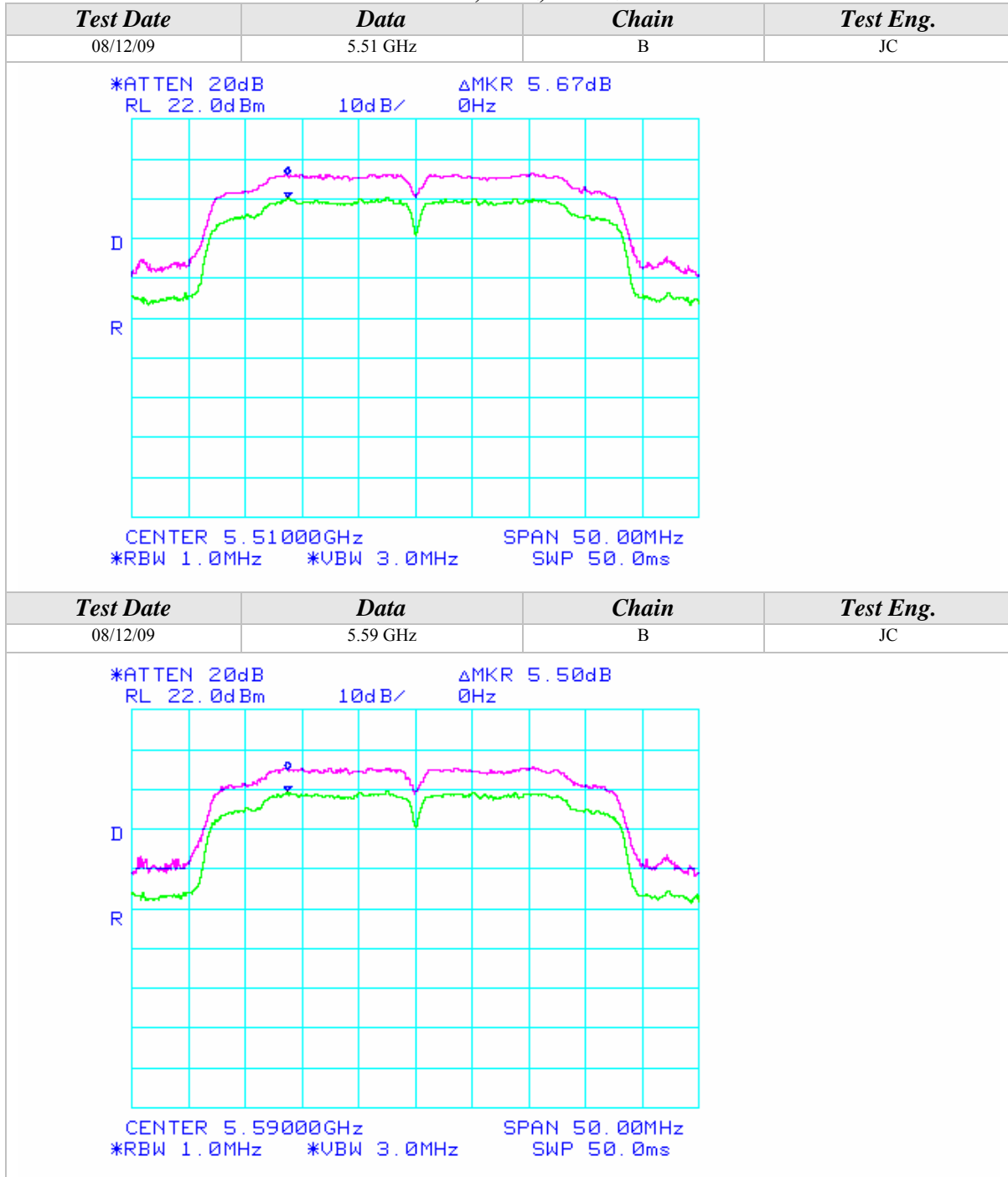

Peak Excursion (Continued)

802.11n Mode, 5GHz, 40MHz Wide

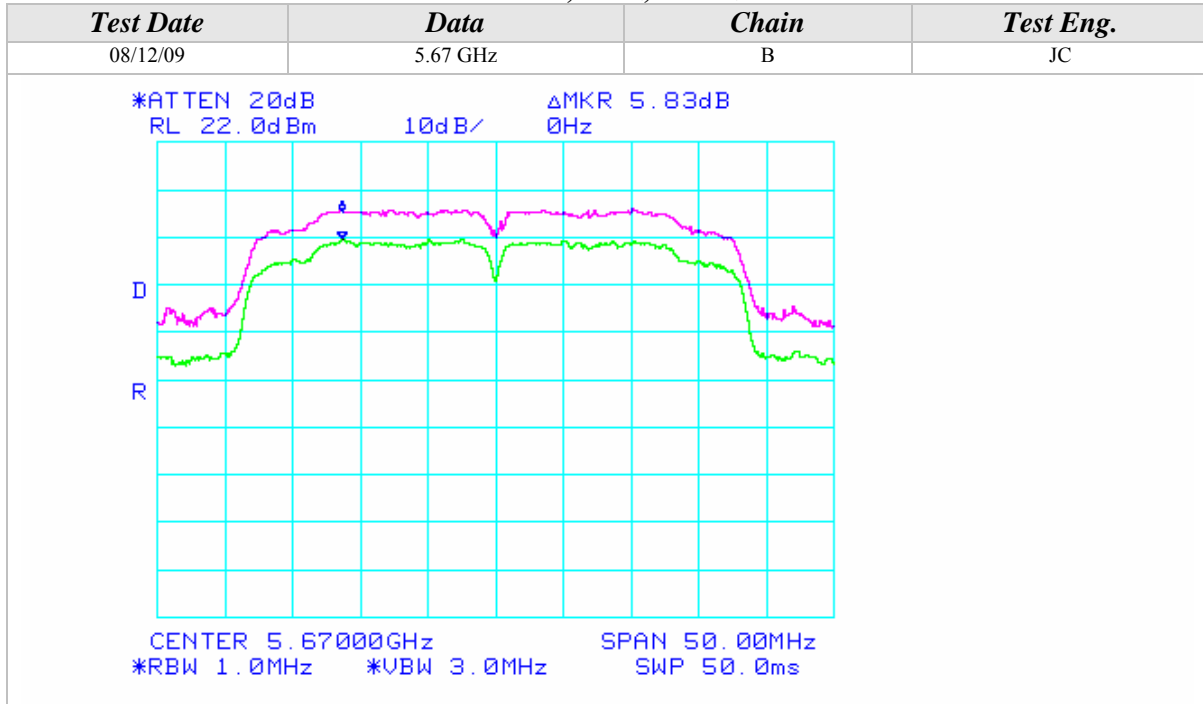



**CONDUCTED OUT OF BAND EMISSIONS**

<b>CLIENT:</b>	Intel Corporation	<b>DATE:</b>	08/05/09
<b>EUT:</b>	Intel WiFi Link 6200	<b>PROJECT NUMBER:</b>	INTEL-090601
<b>MODEL NUMBER:</b>	622ANHMW	<b>TEST ENGINEER:</b>	JC
<b>SERIAL NUMBER:</b>	0015005A70A4	<b>SITE #:</b>	2
<b>CONFIGURATION:</b>	Tested installed in an extender board connected to the host laptop's mini PCI slot	<b>TEMPERATURE:</b>	22 deg. C
		<b>HUMIDITY:</b>	46% RH
		<b>TIME:</b>	9:00 AM

<b>Description:</b>	<p>For transmitters operating in the 5.15-5.25 GHz band: all emissions outside of the 5.15-5.35 GHz band shall not exceed an EIRP of -27dBm/MHz.</p> <p>For transmitters operating in the 5.25-5.35 GHz band: all emissions outside of the 5.15-5.35 GHz band shall not exceed an EIRP of -27dBm/MHz. Devices operating in the 5.25-5.35 GHz band that generate emissions in the 5.15-5.25 GHz band must meet all applicable technical requirements for operation in the 5.15-5.25 GHz band (including indoor use) or alternatively meet an out-of-band emission EIRP limit of -27 dBm/MHz in the 5.15-5.25 GHz band.</p> <p>For transmitters operating in the 5.47-5.725 GHz band: all emissions outside of the 5.47-5.725 GHz band shall not exceed an EIRP of -27dBm/MHz.</p>
<b>Results:</b>	See Data Sheet
<b>Note:</b>	<p>Conducted Emissions Measurements were performed on the EUT with power supply set at the following voltage and frequency.</p> <ul style="list-style-type: none"><li>• 120VAC / 60 Hz.</li></ul>



### Conducted Out Of Band Emissions (Continued)

#### 802.11a Mode

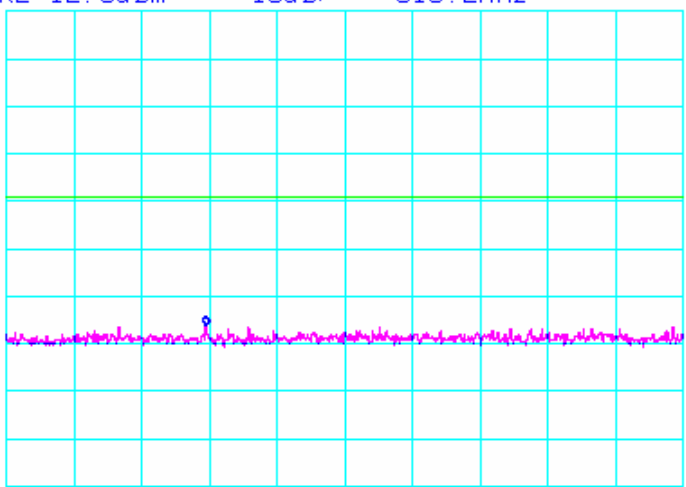
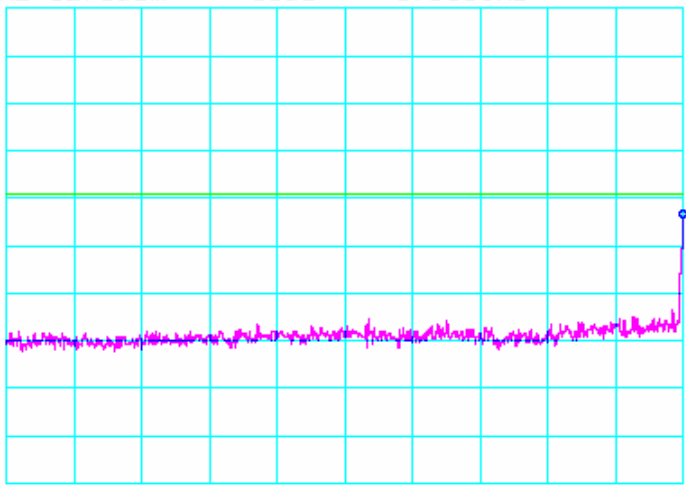
Test Date	Data	Chain	Test Eng.
08/05/09	5.18 GHz	A	JC
<p>*ATTEN 10dB                      MKR -54.17dBm RL 12.0dBm                      10dB/                      316.2MHz</p>  <p>START 30.0MHz                      STOP 1.0000GHz *RBW 1.0MHz                      *VBW 1.0MHz                      SWP 50.0ms</p>			
Test Date	Data	Chain	Test Eng.
08/05/09	5.18 GHz	A	JC
<p>*ATTEN 10dB                      MKR -32.33dBm RL 12.0dBm                      10dB/                      5.150GHz</p>  <p>START 1.000GHz                      STOP 5.150GHz *RBW 1.0MHz                      *VBW 1.0MHz                      SWP 83.0ms</p>			



Conducted Out Of Band Emissions (Continued)

802.11a Mode

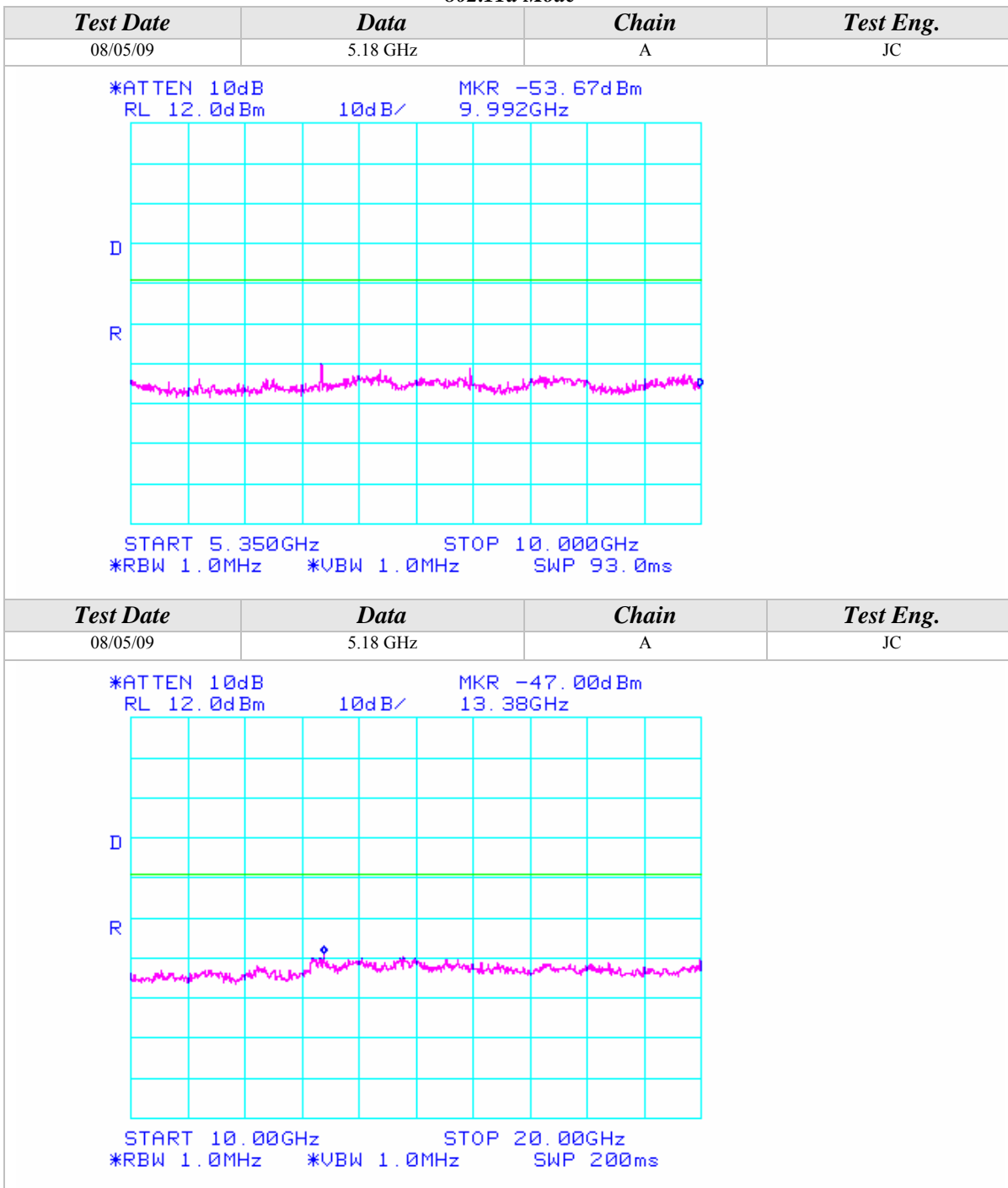

## Conducted Out Of Band Emissions (Continued)

## 802.11a Mode

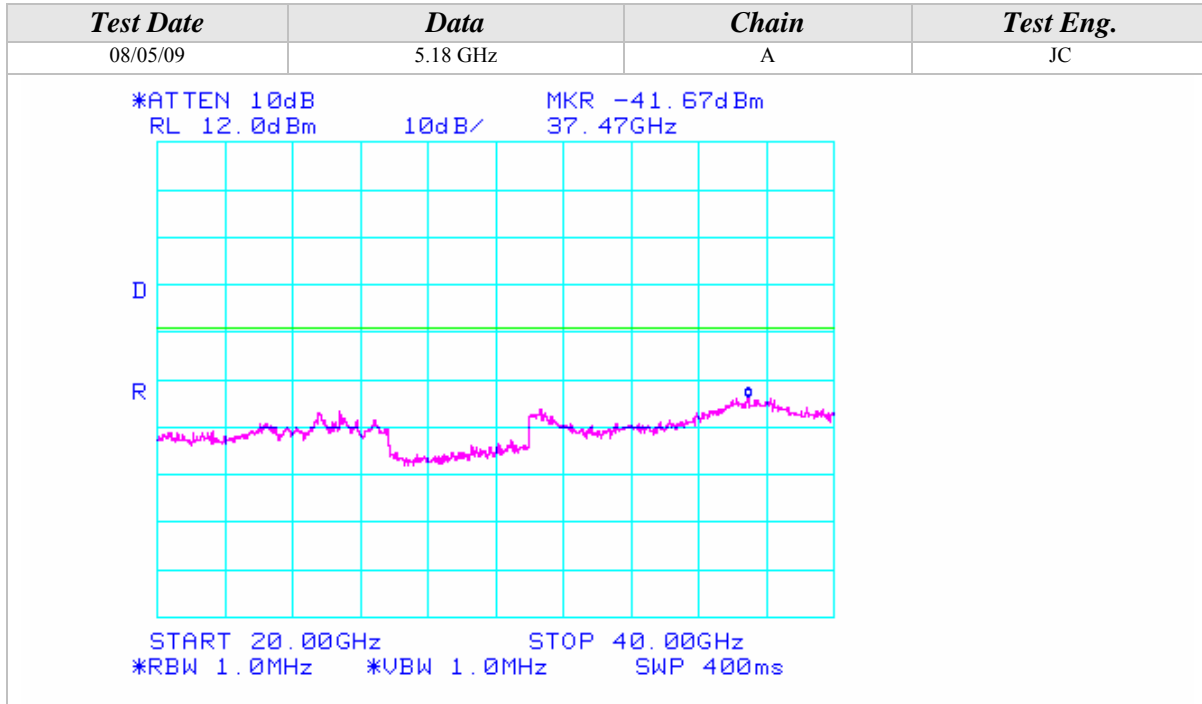



Conducted Out Of Band Emissions (Continued)

802.11a Mode

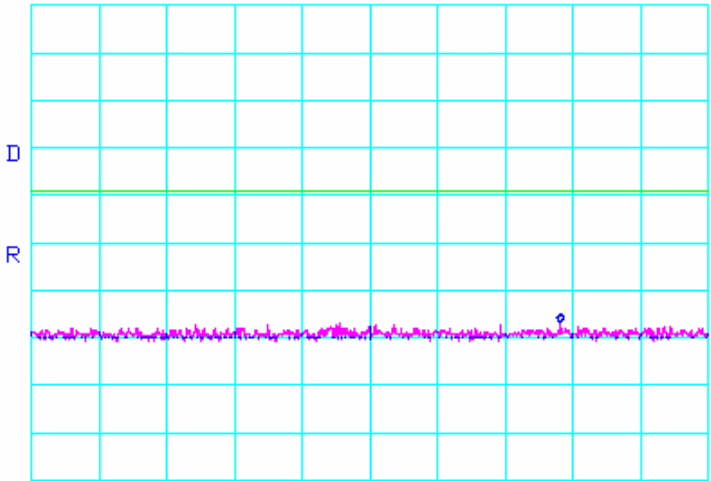
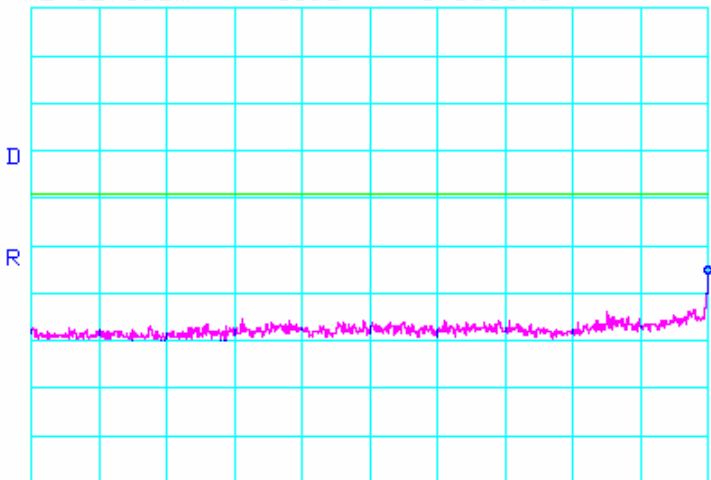
Test Date	Data	Chain	Test Eng.
08/05/09	5.20 GHz	A	JC
<p>*ATTEN 10dB                          MKR -54.83dBm RL 12.0dBm                          10dB/                          788.2MHz</p>  <p>D R</p> <p>START 30.0MHz                          STOP 1.0000GHz *RBW 1.0MHz                          *VBW 1.0MHz                          SWP 50.0ms</p>			
Test Date	Data	Chain	Test Eng.
08/05/09	5.20 GHz	A	JC
<p>*ATTEN 10dB                          MKR -44.17dBm RL 12.0dBm                          10dB/                          5.150GHz</p>  <p>D R</p> <p>START 1.000GHz                          STOP 5.150GHz *RBW 1.0MHz                          *VBW 1.0MHz                          SWP 83.0ms</p>			

Conducted Out Of Band Emissions (Continued)

802.11a Mode

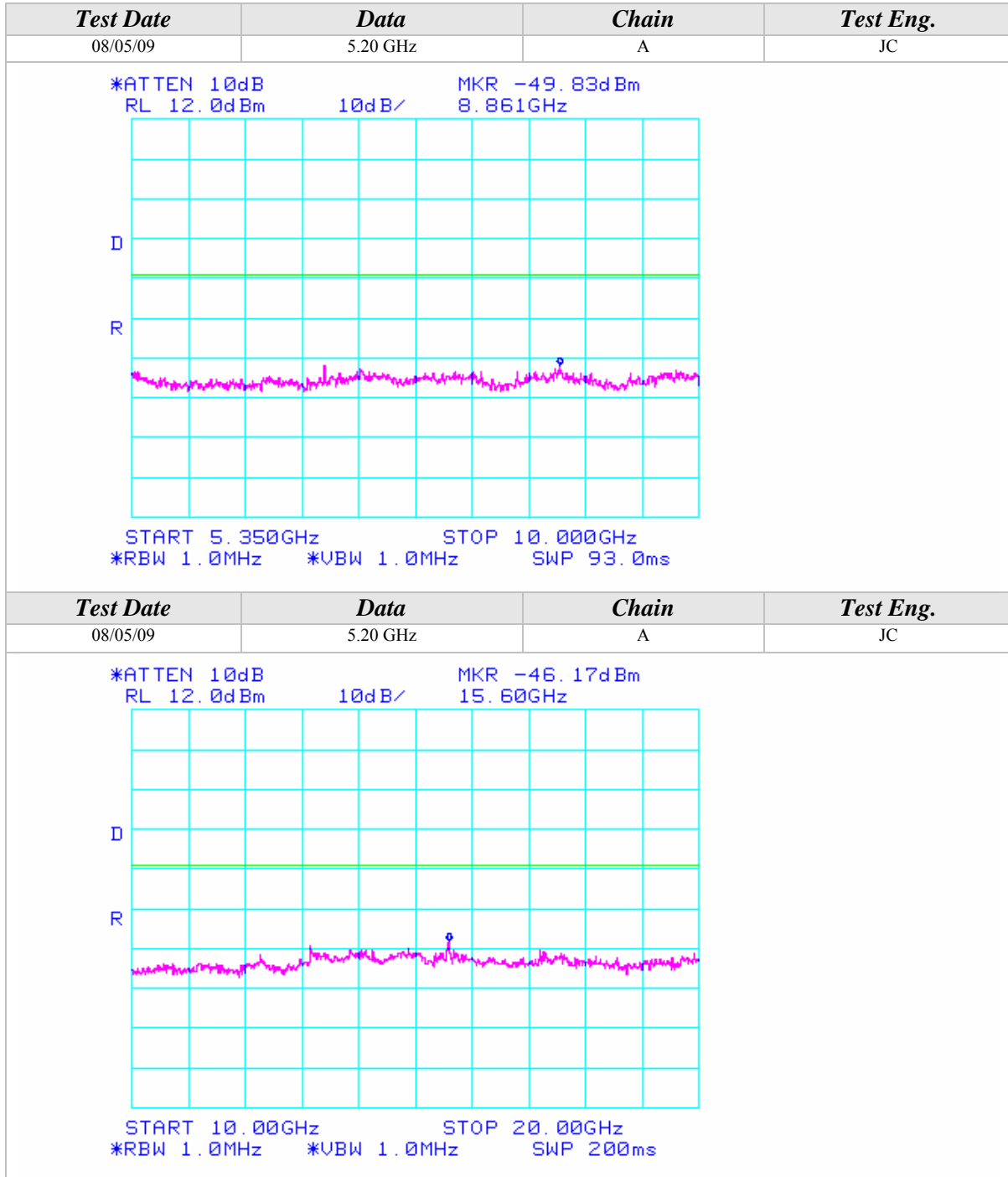



### Conducted Out Of Band Emissions (Continued)

#### 802.11a Mode

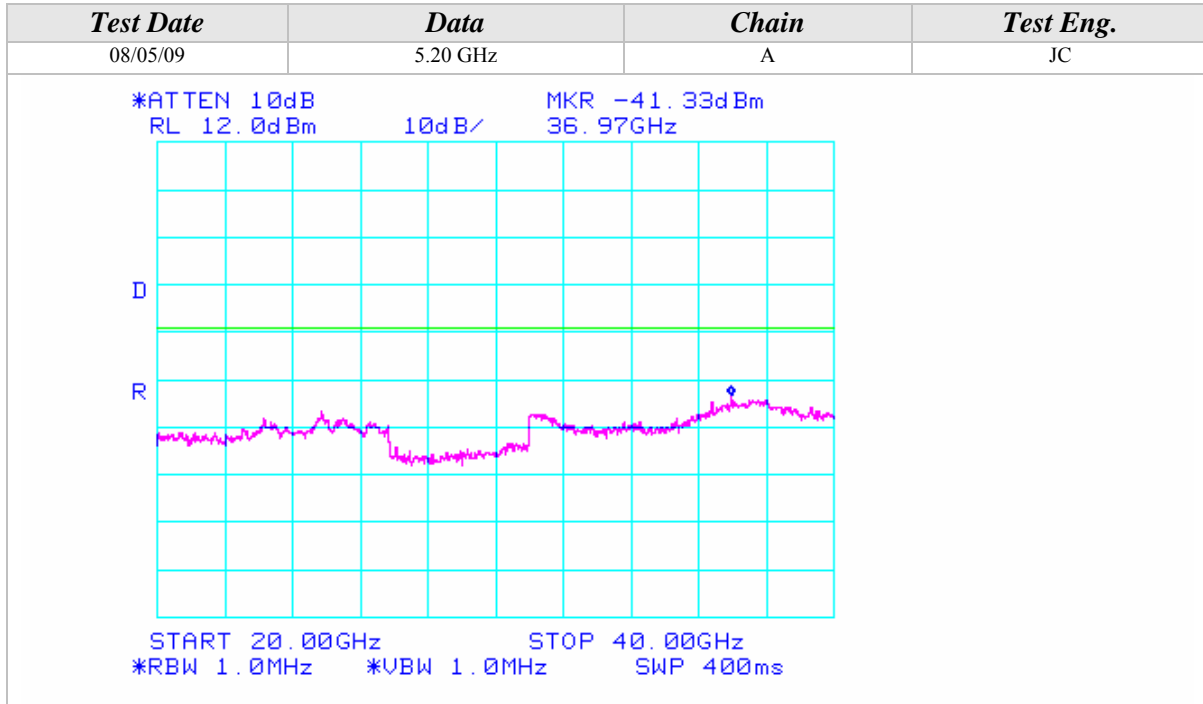



### Conducted Out Of Band Emissions (Continued)

#### 802.11a Mode

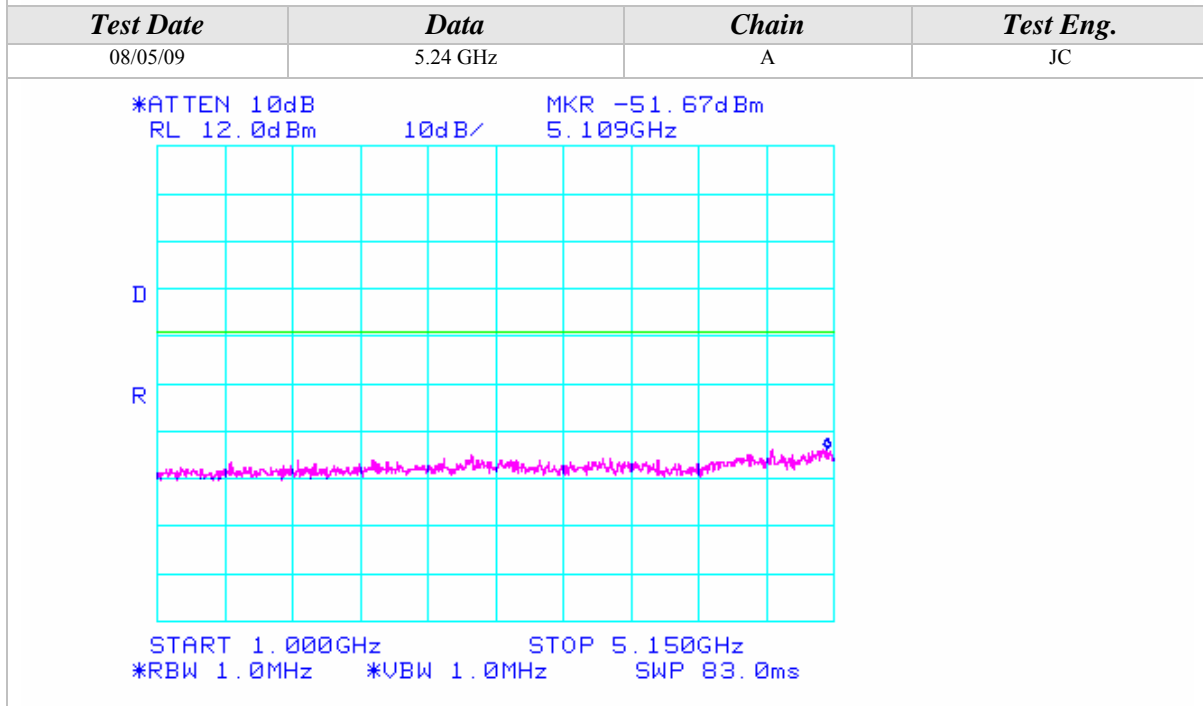
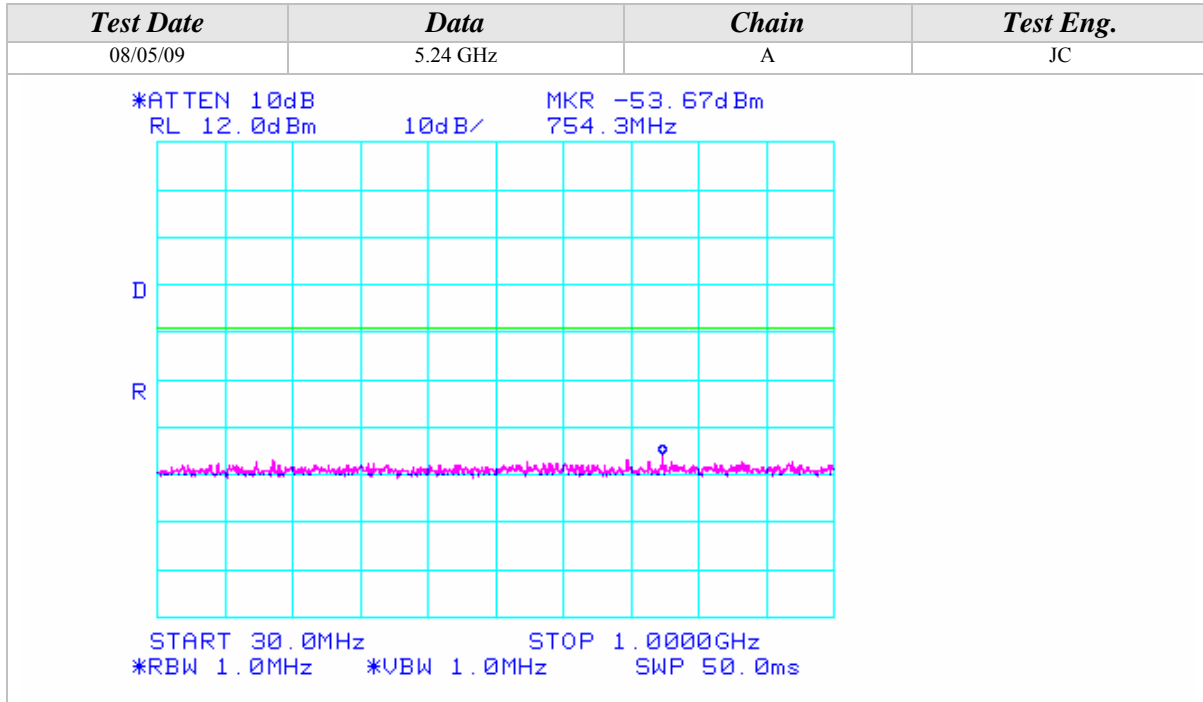





Conducted Out Of Band Emissions (Continued)

802.11a Mode

Test Date	Data	Chain	Test Eng.
08/05/09	5.24 GHz	A	JC
<p>*ATTEN 10dB                          MKR -49.17dBm RL 12.0dBm                          10dB/                          6.985GHz</p> <p>START 5.350GHz                          STOP 10.000GHz *RBW 1.0MHz                          *VBW 1.0MHz                          SWP 93.0ms</p>			
Test Date	Data	Chain	Test Eng.
08/05/09	5.24 GHz	A	JC
<p>*ATTEN 10dB                          MKR -46.00dBm RL 12.0dBm                          10dB/                          15.72GHz</p> <p>START 10.000GHz                          STOP 20.000GHz *RBW 1.0MHz                          *VBW 1.0MHz                          SWP 200ms</p>			



Conducted Out Of Band Emissions (Continued)

802.11a Mode

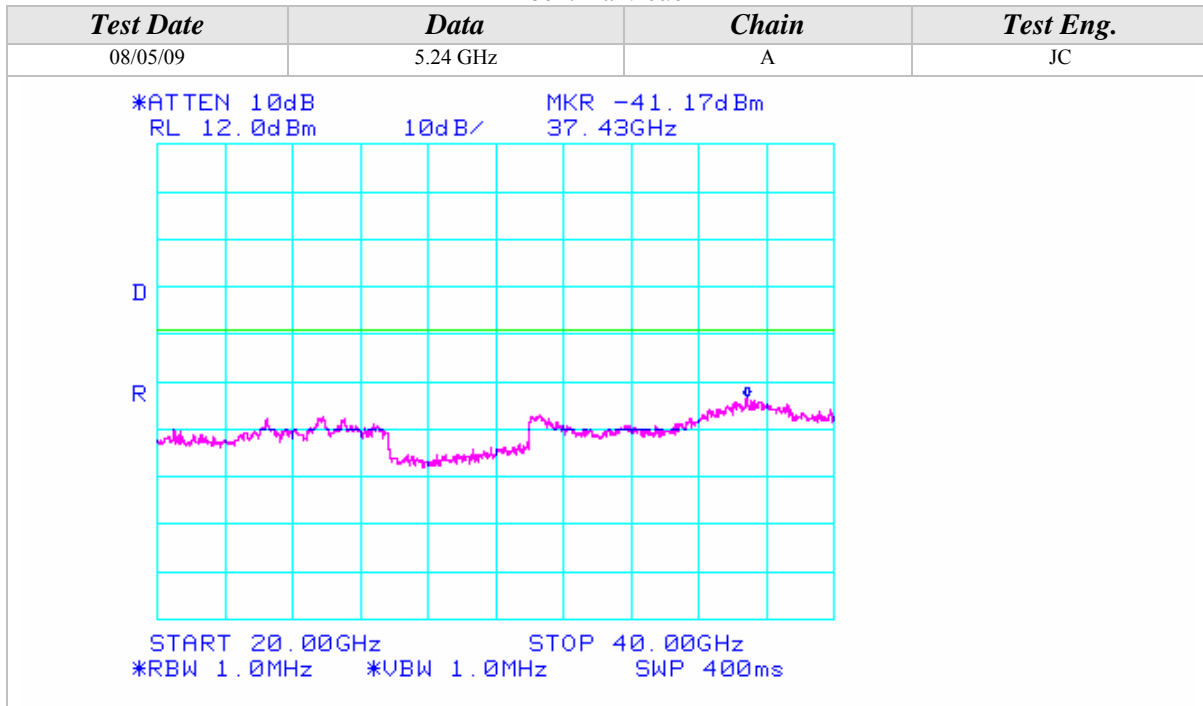

Conducted Out Of Band Emissions (Continued)

802.11a Mode

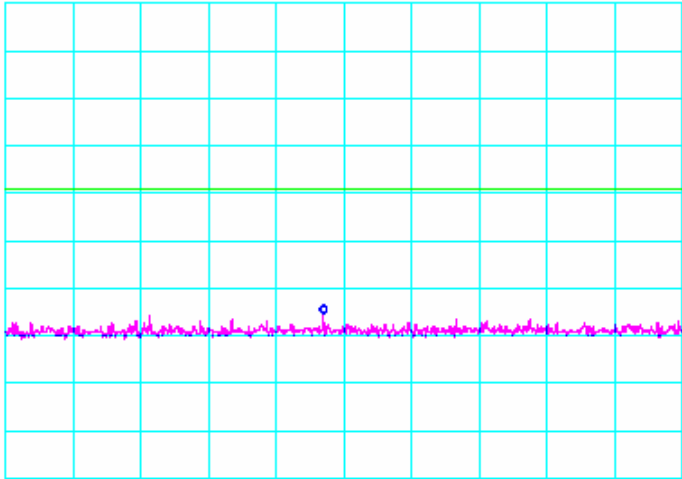
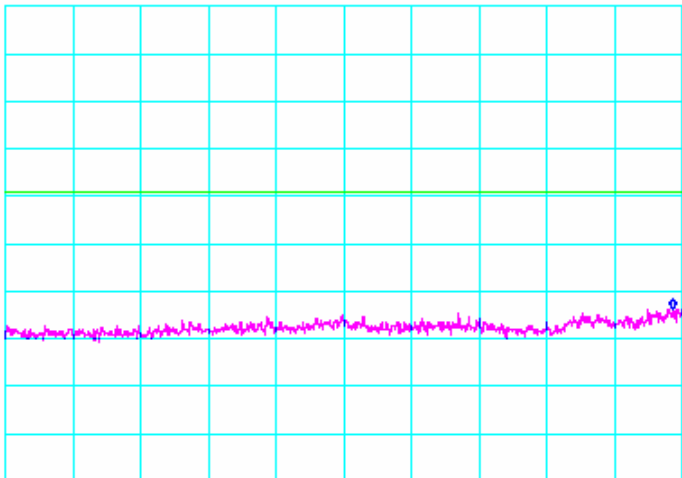
<b>Test Date</b>	<b>Data</b>	<b>Chain</b>	<b>Test Eng.</b>
08/05/09	5.26 GHz	A	JC
<p>*ATTEN 10dB      MKR -53.50dBm RL 12.0dBm    10dB/    485.9MHz</p>  <p>START 30.0MHz      STOP 1.0000GHz *RBW 1.0MHz    *VBW 1.0MHz    SWP 50.0ms</p>			
<b>Test Date</b>	<b>Data</b>	<b>Chain</b>	<b>Test Eng.</b>
08/05/09	5.26 GHz	A	JC
<p>*ATTEN 10dB      MKR -51.67dBm RL 12.0dBm    10dB/    5.095GHz</p>  <p>START 1.000GHz      STOP 5.150GHz *RBW 1.0MHz    *VBW 1.0MHz    SWP 83.0ms</p>			



### Conducted Out Of Band Emissions (Continued)

#### 802.11a Mode

<i>Test Date</i>	<i>Data</i>	<i>Chain</i>	<i>Test Eng.</i>
08/05/09	5.26 GHz	A	JC
<p>*ATTEN 10dB    MKR -49.67dBm RL 12.0dBm    10dB/    5.358GHz</p> <p>START 5.350GHz    STOP 10.000GHz *RBW 1.0MHz    *VBW 1.0MHz    SWP 93.0ms</p>			
<i>Test Date</i>	<i>Data</i>	<i>Chain</i>	<i>Test Eng.</i>
08/05/09	5.26 GHz	A	JC
<p>*ATTEN 10dB    MKR -44.83dBm RL 12.0dBm    10dB/    15.77GHz</p> <p>START 10.00GHz    STOP 20.00GHz *RBW 1.0MHz    *VBW 1.0MHz    SWP 200ms</p>			



Conducted Out Of Band Emissions (Continued)

802.11a Mode

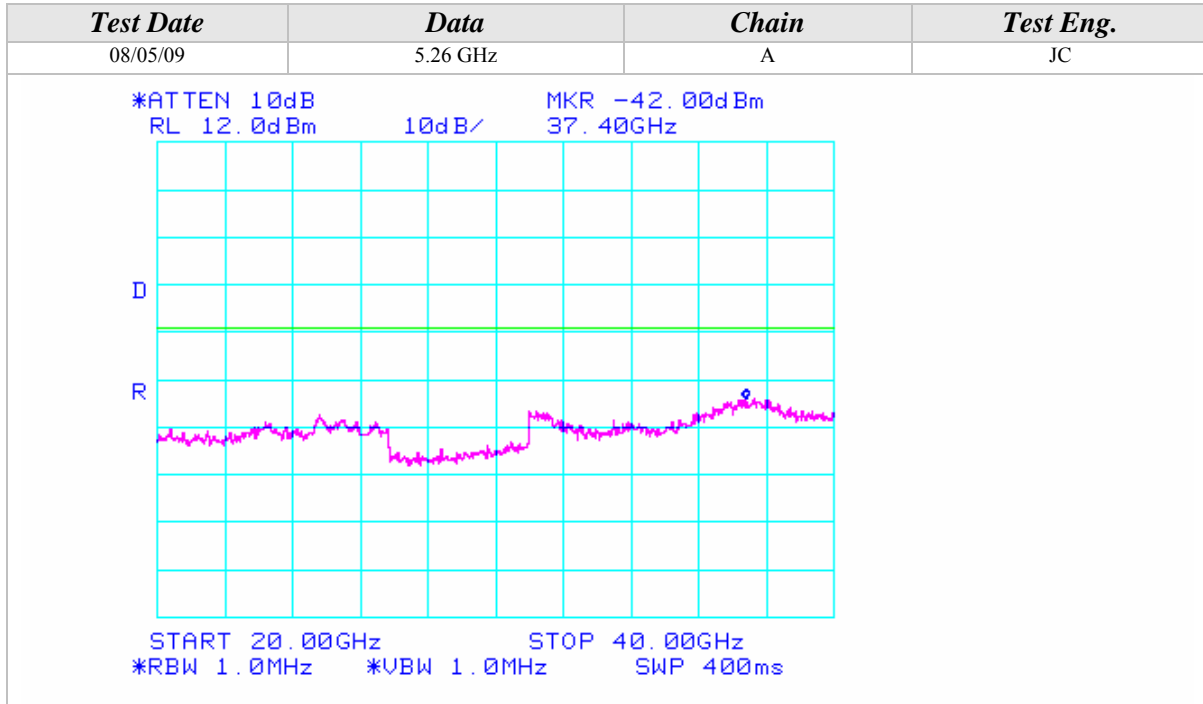

## Conducted Out Of Band Emissions (Continued)

## 802.11a Mode

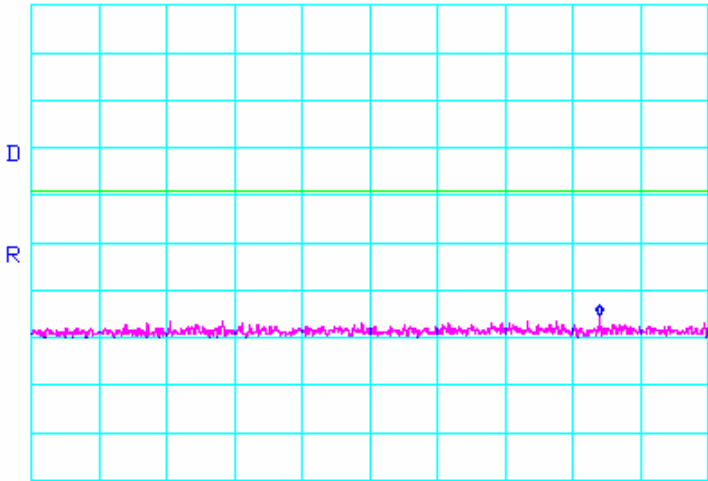
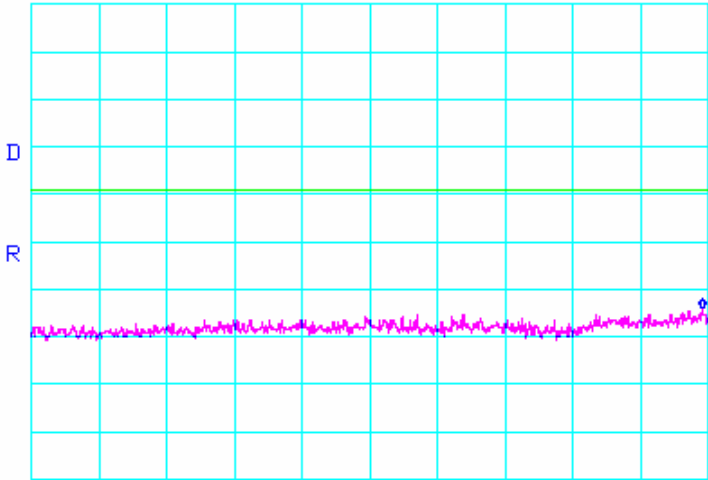
<i>Test Date</i>	<i>Data</i>	<i>Chain</i>	<i>Test Eng.</i>
08/05/09	5.28 GHz	A	JC
<p>*ATTEN 10dB                      MKR -53.17dBm            RL 12.0dBm                    10dB/                    844.8MHz</p>  <p>START 30.0MHz                    STOP 1.0000GHz            *RBW 1.0MHz                   *VBW 1.0MHz            SWP 50.0ms</p>			
<i>Test Date</i>	<i>Data</i>	<i>Chain</i>	<i>Test Eng.</i>
08/05/09	5.28 GHz	A	JC
<p>*ATTEN 10dB                      MKR -52.00dBm            RL 12.0dBm                    10dB/                    5.115GHz</p>  <p>START 1.000GHz                  STOP 5.150GHz            *RBW 1.0MHz                   *VBW 1.0MHz            SWP 83.0ms</p>			



Conducted Out Of Band Emissions (Continued)

802.11a Mode

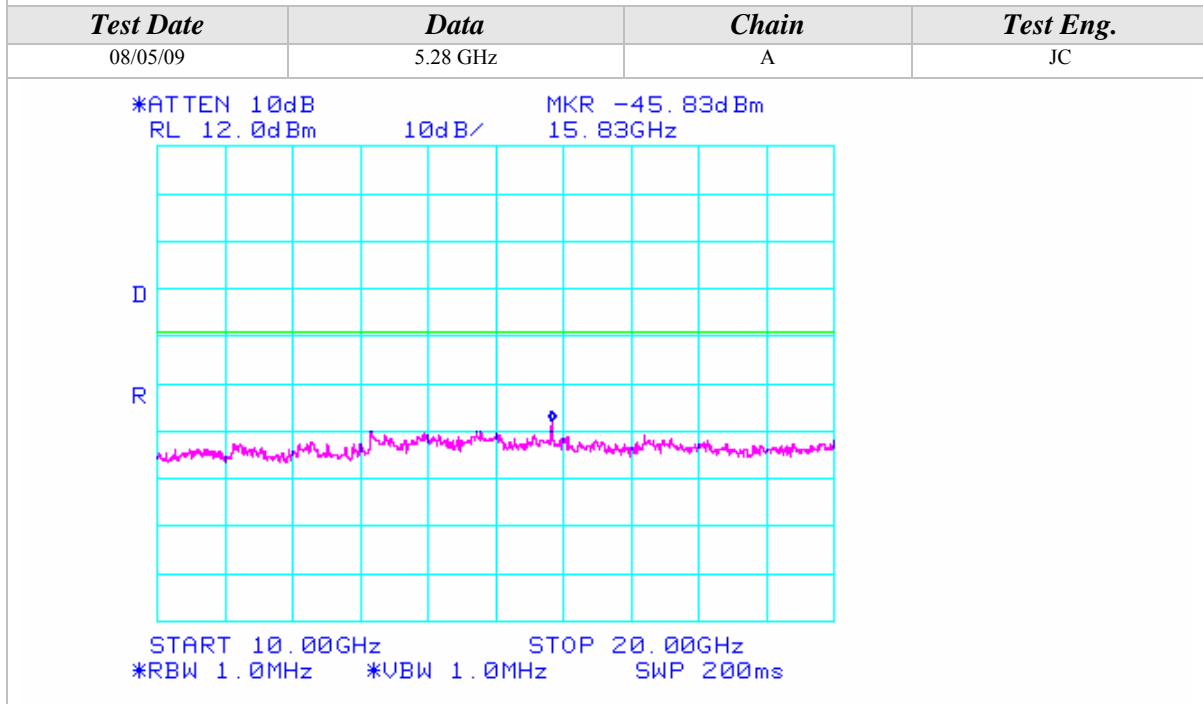
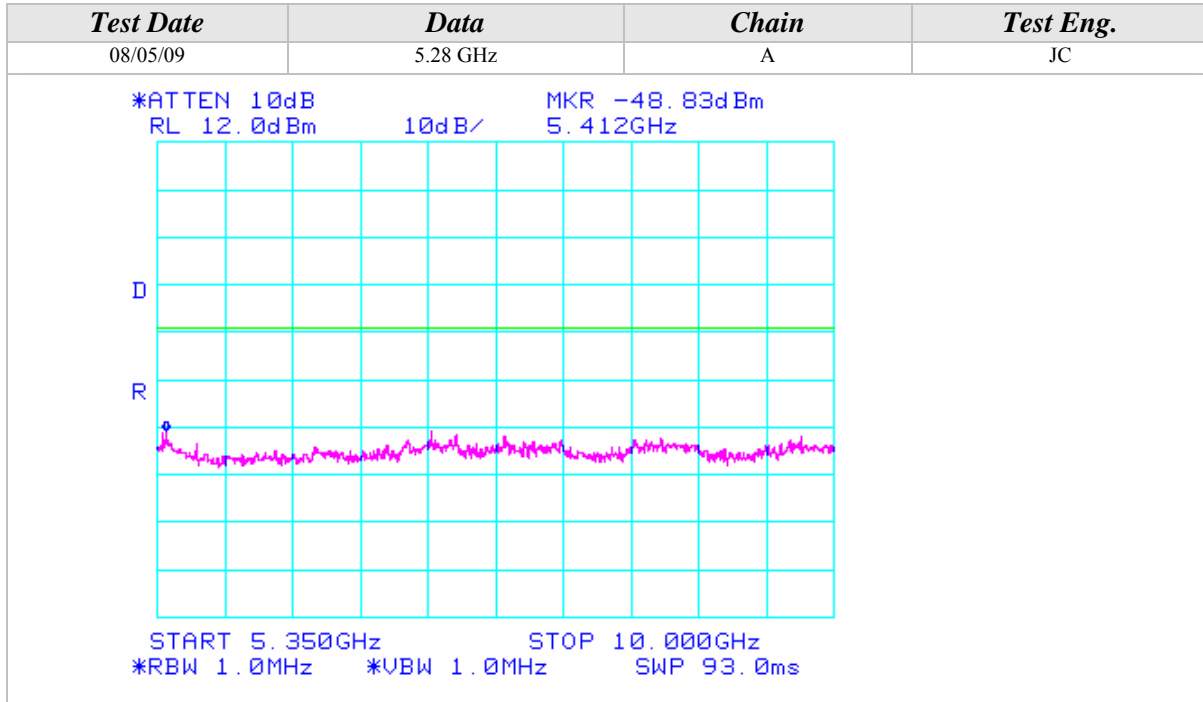







### Conducted Out Of Band Emissions (Continued)

#### 802.11a Mode

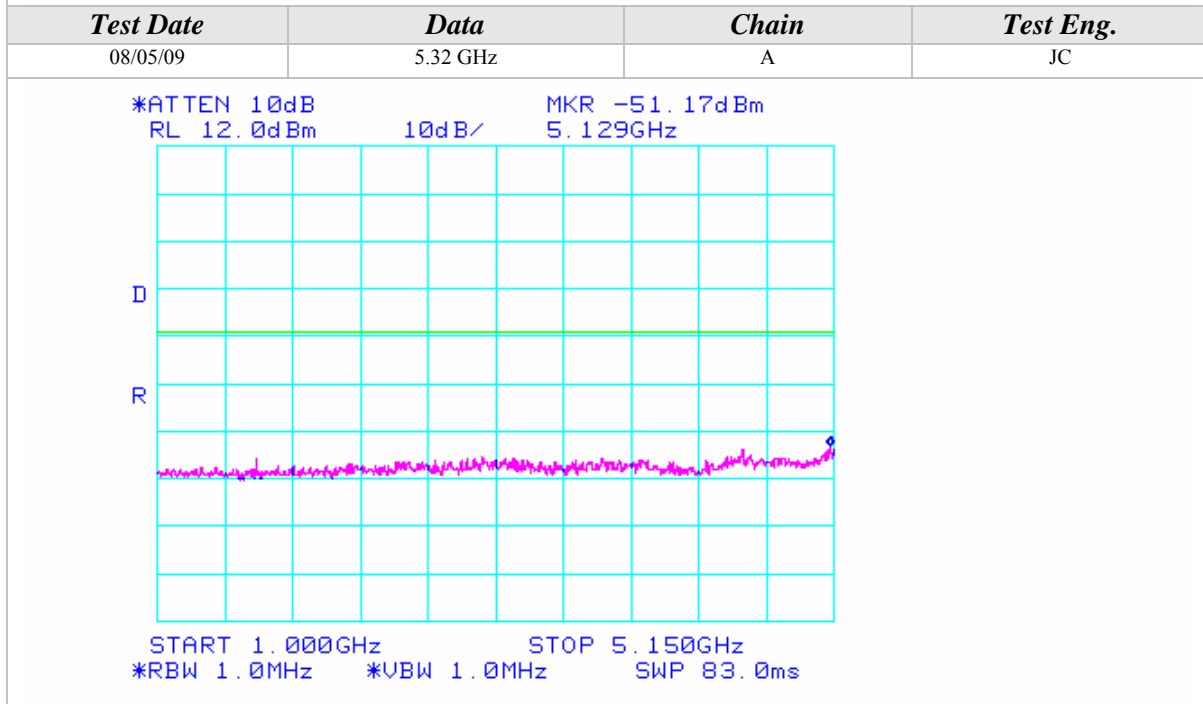
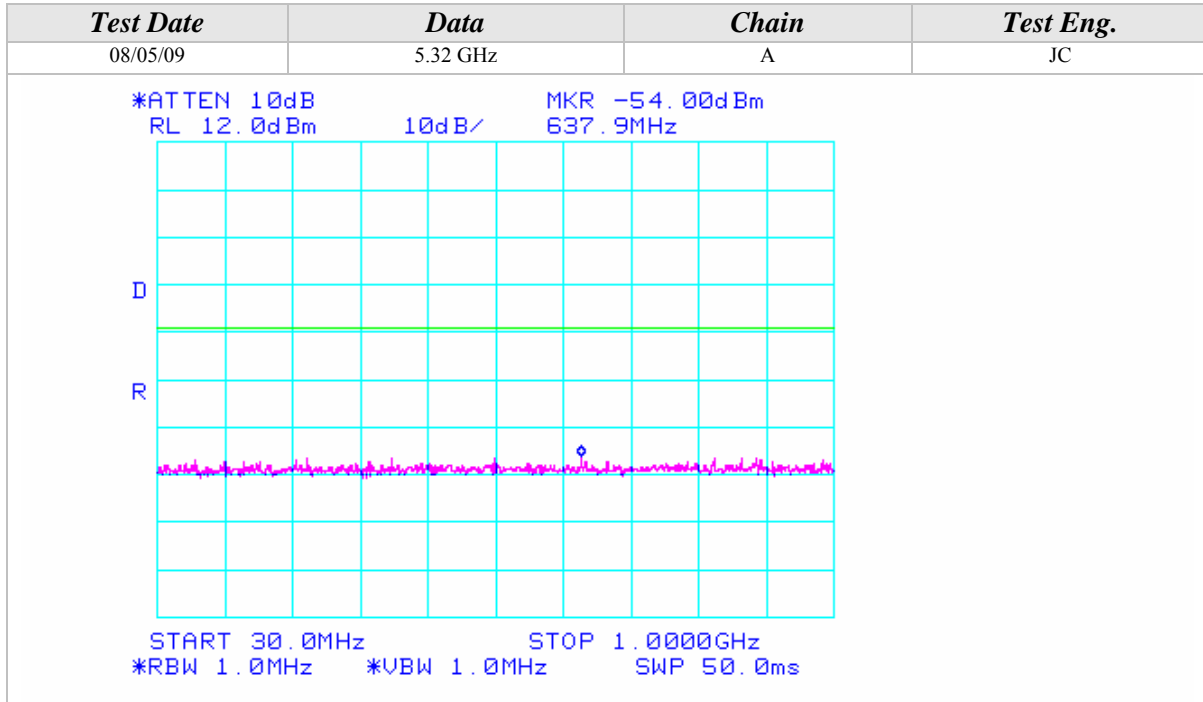



Conducted Out Of Band Emissions (Continued)

802.11a Mode

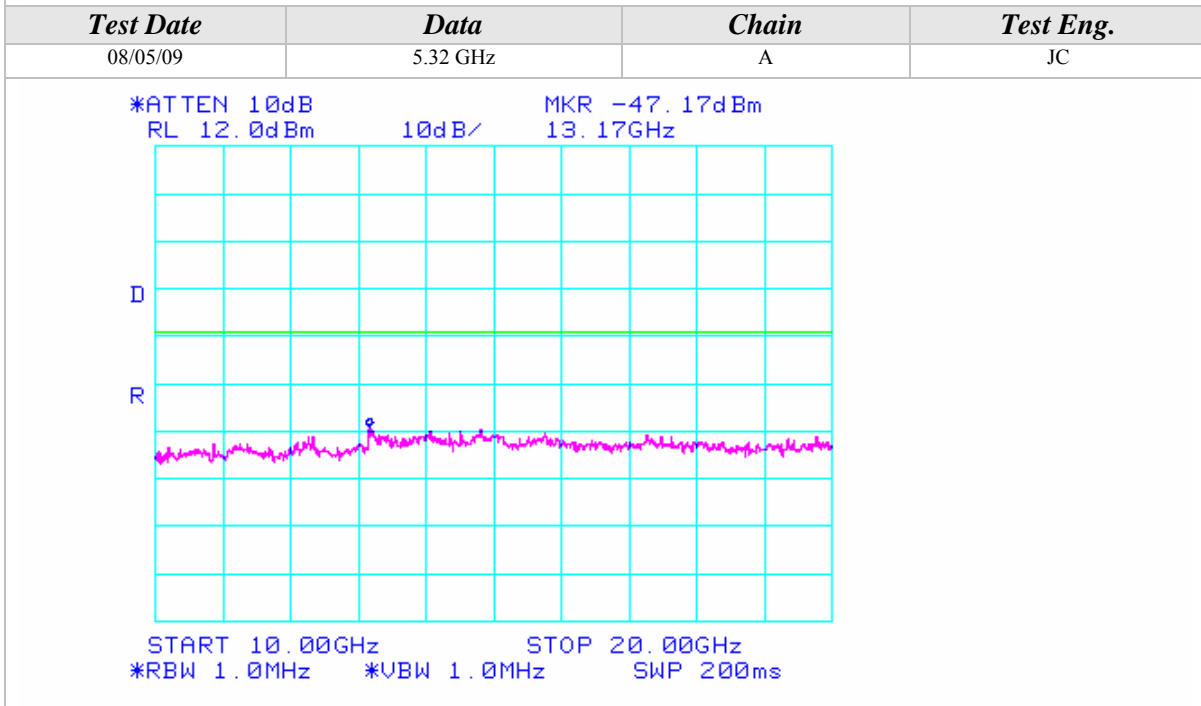
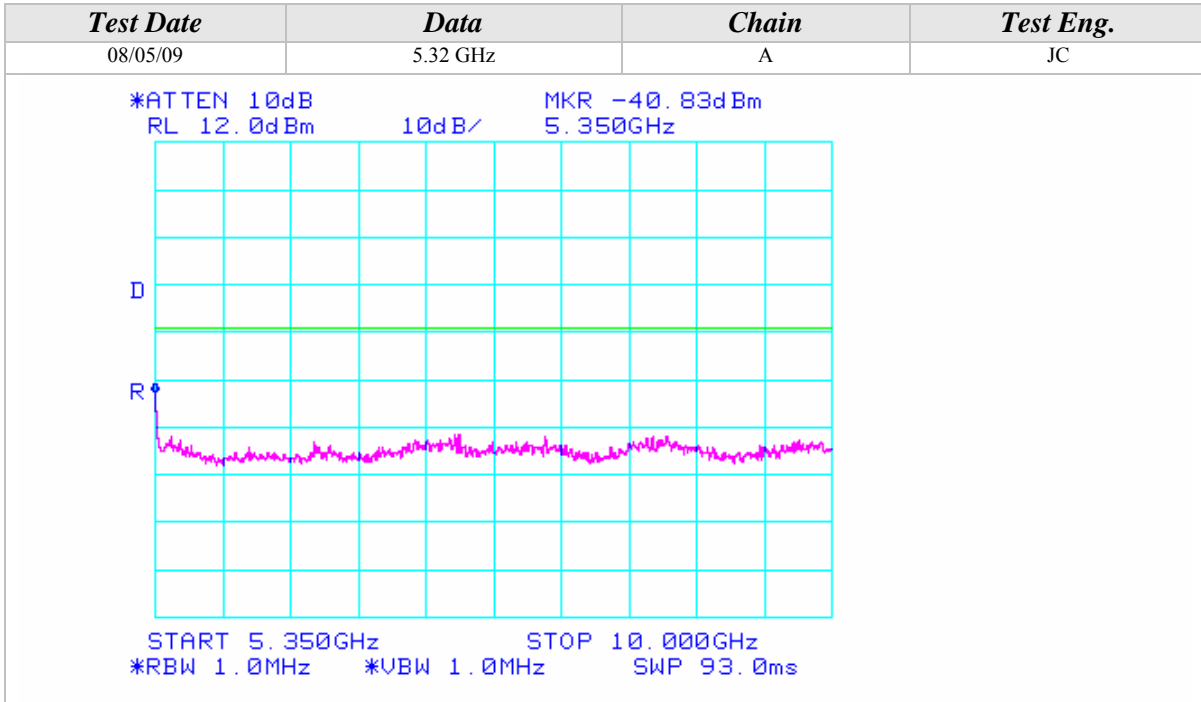



### Conducted Out Of Band Emissions (Continued)

#### 802.11a Mode

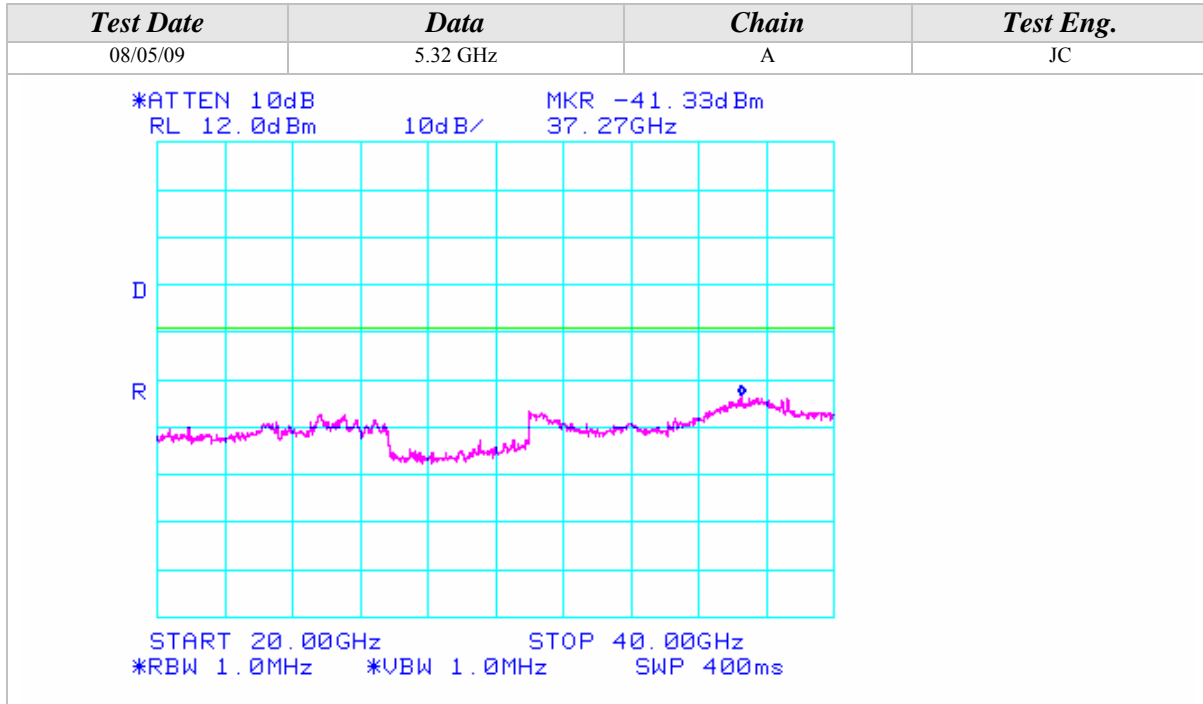



Conducted Out Of Band Emissions (Continued)

802.11a Mode

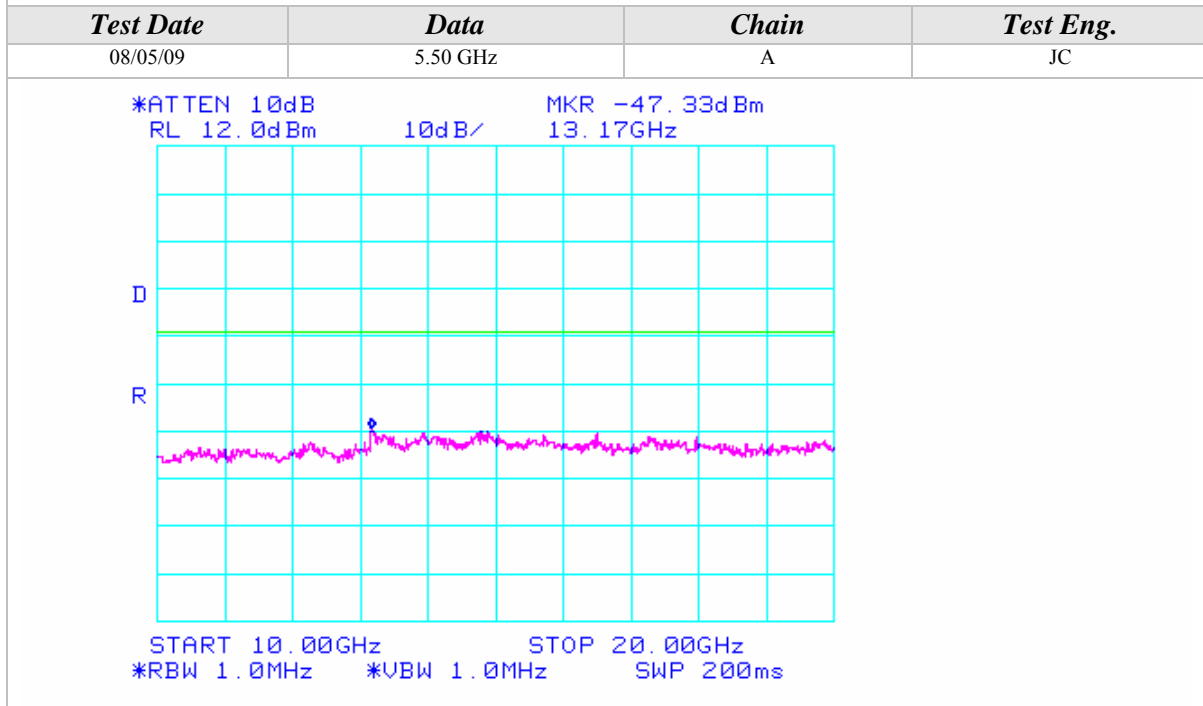
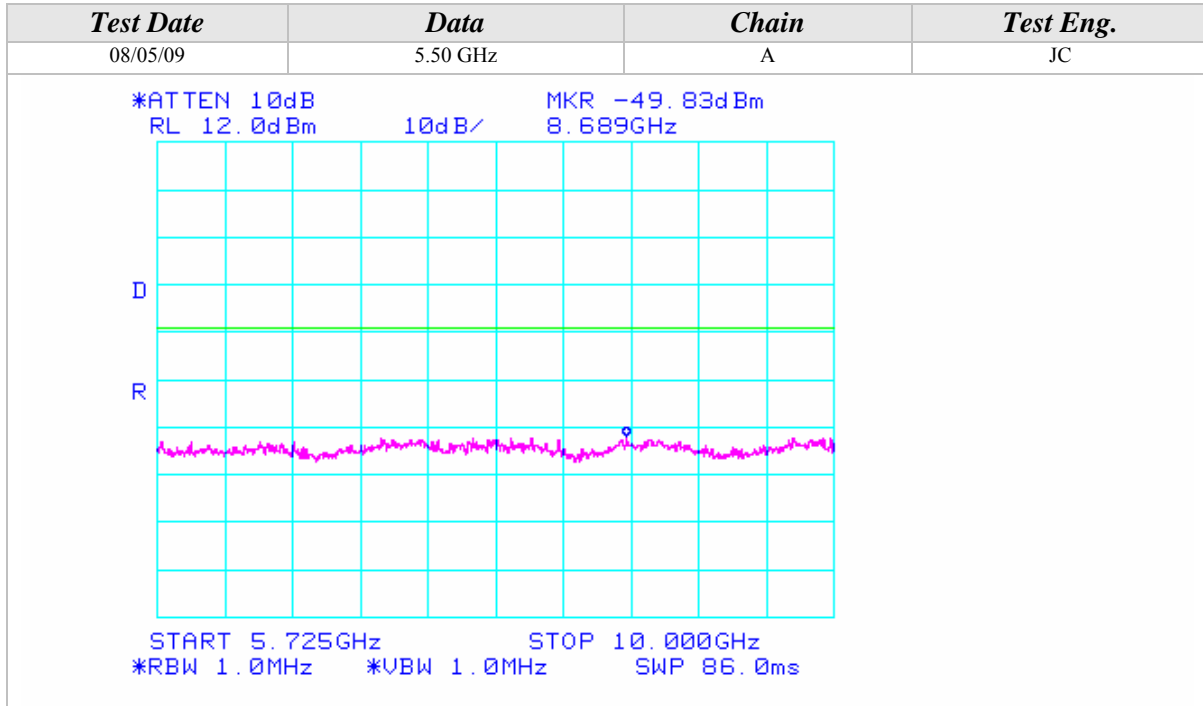



Conducted Out Of Band Emissions (Continued)

**802.11a Mode**

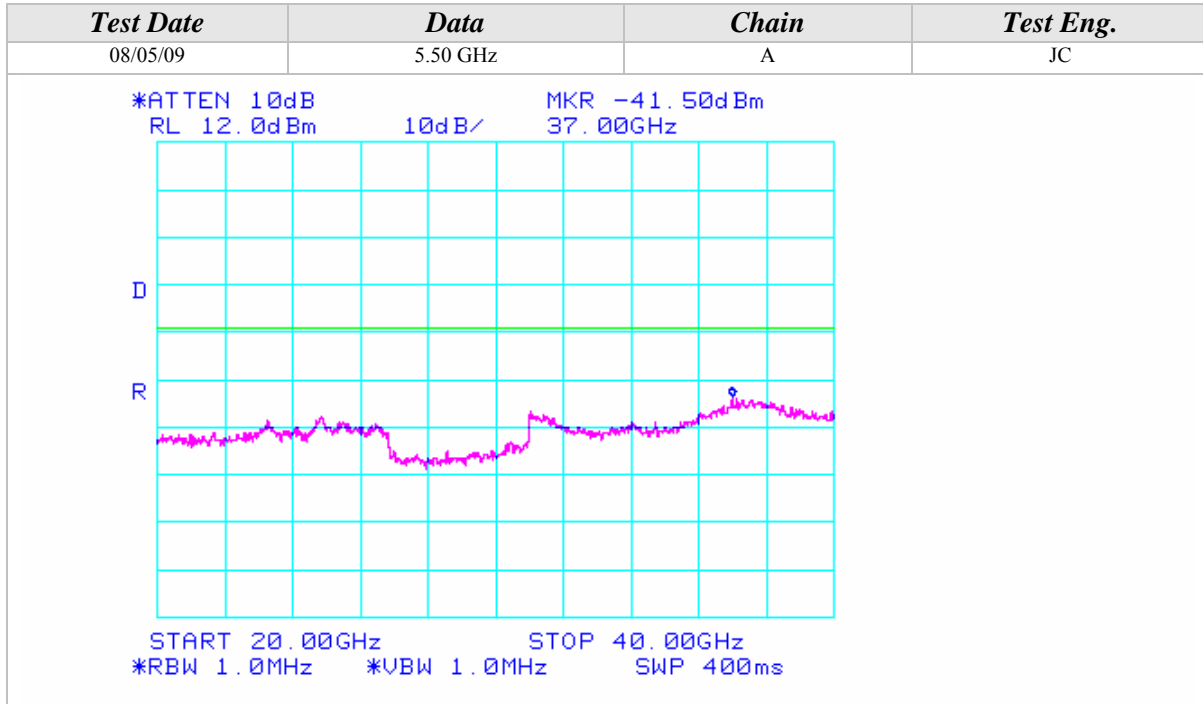



Conducted Out Of Band Emissions (Continued)

802.11a Mode

Test Date	Data	Chain	Test Eng.
08/05/09	5.60 GHz	A	JC
<p>*ATTEN 10dB                      MKR -54.00dBm  RL 12.0dBm                      10dB/                      888.5MHz</p> <p>START 30.0MHz                      STOP 1.0000GHz  *RBW 1.0MHz                      *VBW 1.0MHz                      SWP 50.0ms</p>			
Test Date	Data	Chain	Test Eng.
08/05/09	5.60 GHz	A	JC
<p>*ATTEN 10dB                      MKR -51.67dBm  RL 12.0dBm                      10dB/                      5.415GHz</p> <p>START 1.000GHz                      STOP 5.460GHz  *RBW 1.0MHz                      *VBW 1.0MHz                      SWP 90.0ms</p>			

## Conducted Out Of Band Emissions (Continued)

## 802.11a Mode

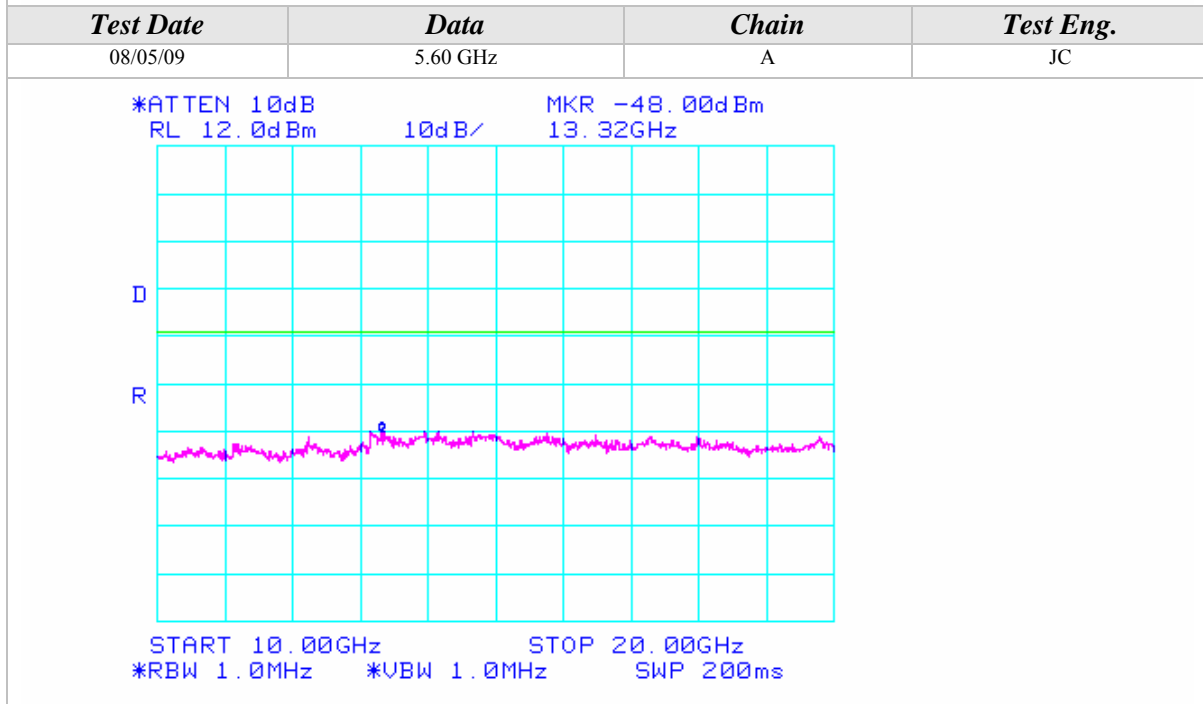
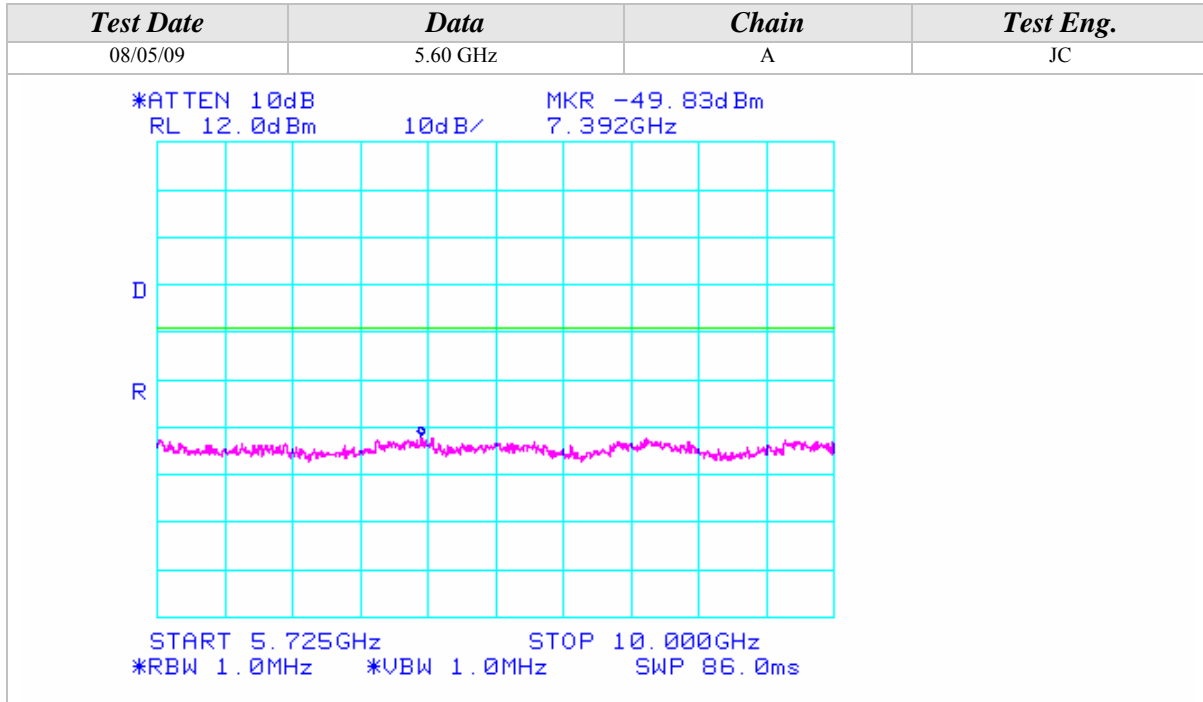





Conducted Out Of Band Emissions (Continued)

802.11a Mode

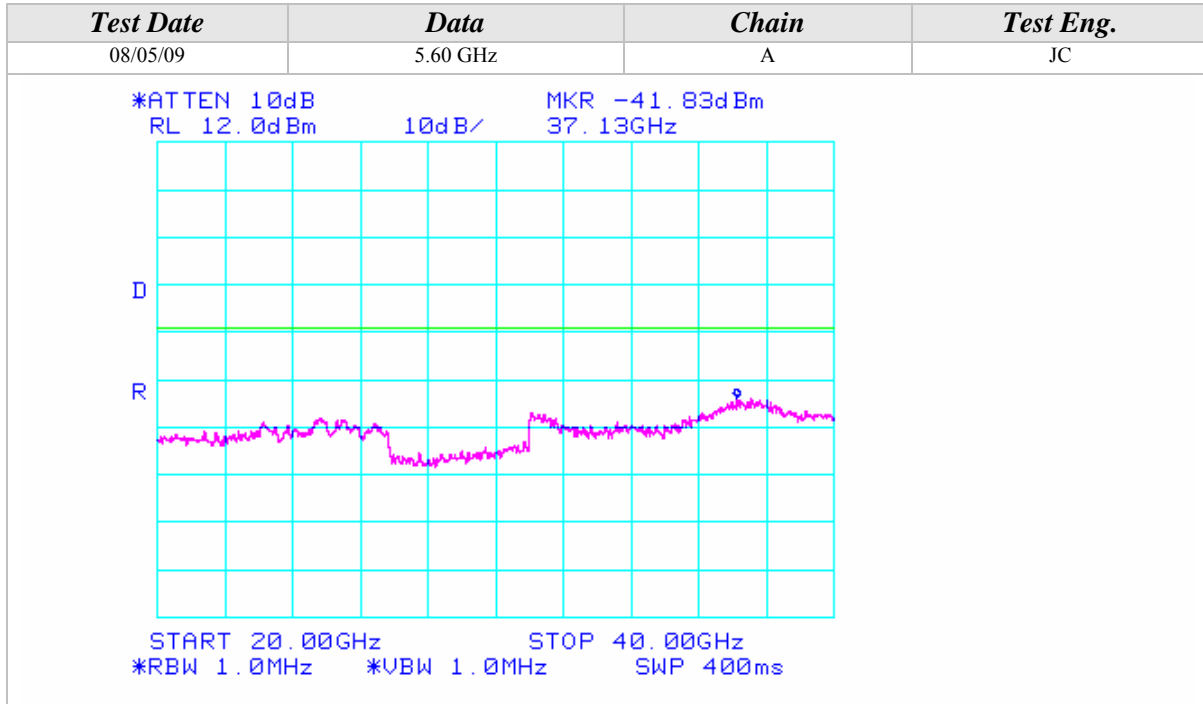





Conducted Out Of Band Emissions (Continued)

802.11a Mode

Test Date	Data	Chain	Test Eng.
08/05/09	5.70 GHz	A	JC
<p>*ATTEN 10dB MKR -35.67dBm RL 12.0dBm 10dB/ 5.725GHz</p> <p>START 5.725GHz STOP 10.000GHz *RBW 1.0MHz *VBW 1.0MHz SWP 86.0ms</p>			
Test Date	Data	Chain	Test Eng.
08/05/09	5.70 GHz	A	JC
<p>*ATTEN 10dB MKR -47.00dBm RL 12.0dBm 10dB/ 11.38GHz</p> <p>START 10.00GHz STOP 20.00GHz *RBW 1.0MHz *VBW 1.0MHz SWP 200ms</p>			



Conducted Out Of Band Emissions (Continued)

802.11a Mode

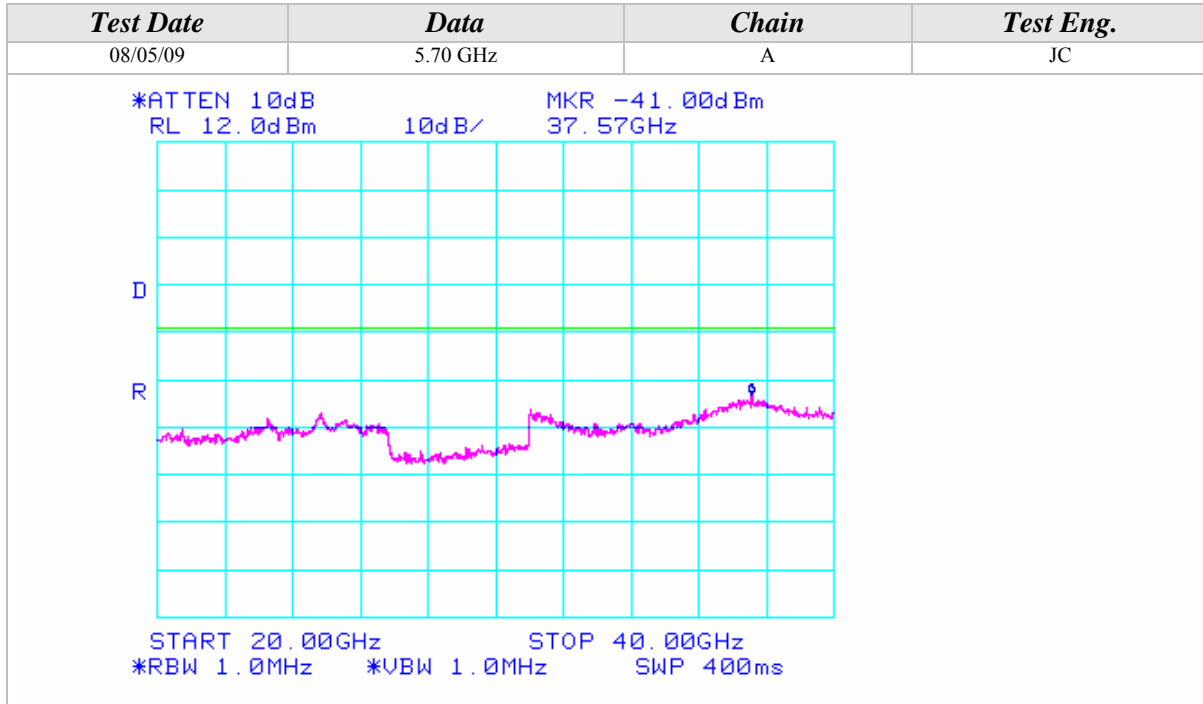



Conducted Out Of Band Emissions (Continued)

802.11n Mode, 5GHz, 20MHz Wide

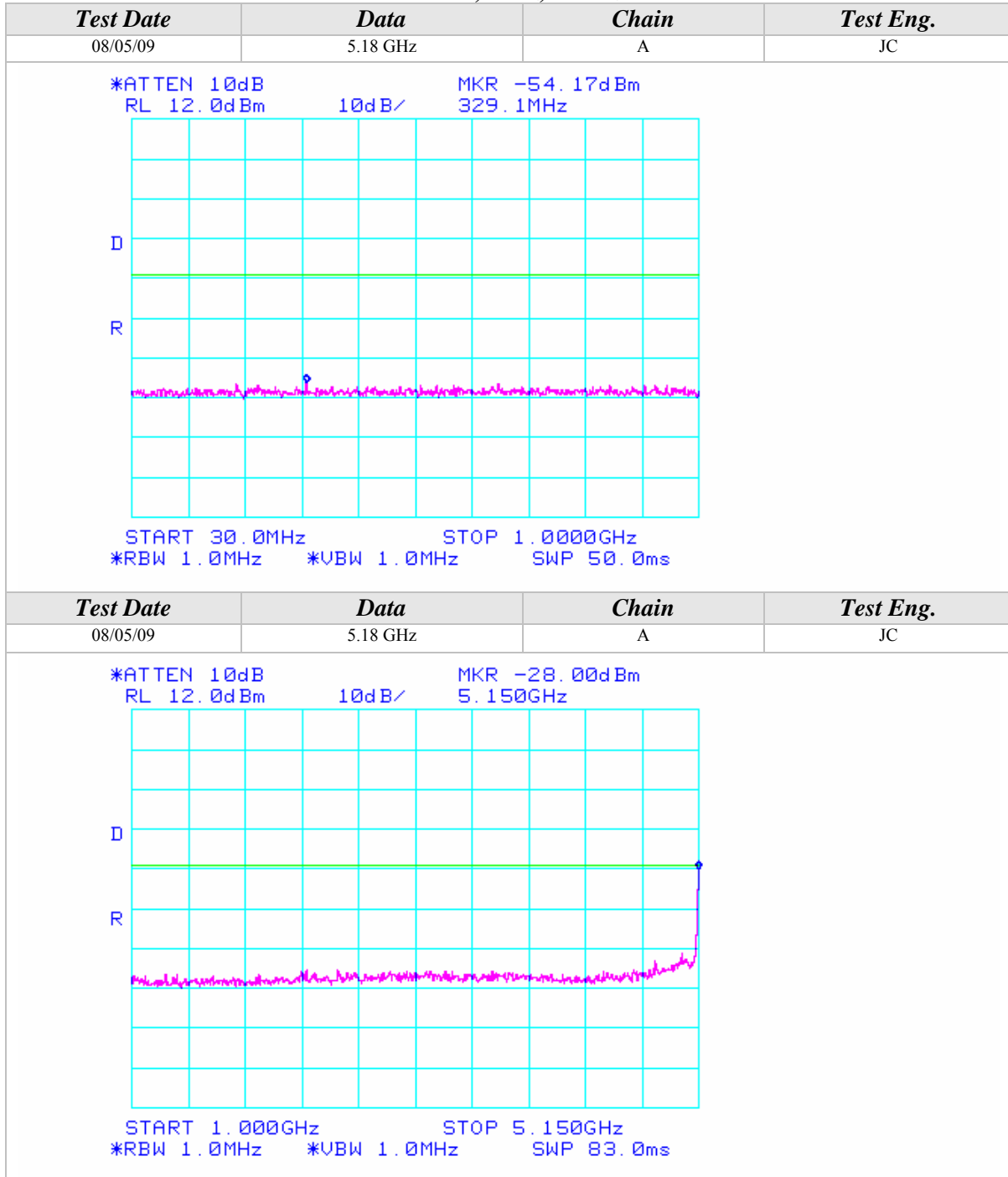



Conducted Out Of Band Emissions (Continued)

802.11n Mode, 5GHz, 20MHz Wide

Test Date	Data	Chain	Test Eng.
08/05/09	5.18 GHz	A	JC
<p>*ATTEN 10dB MKR -48.33dBm RL 12.0dBm 10dB/ 6.908GHz</p> <p>START 5.350GHz STOP 10.000GHz *RBW 1.0MHz *VBW 1.0MHz SWP 93.0ms</p>			
Test Date	Data	Chain	Test Eng.
05/30/08	5.18 GHz	A	JC
<p>*ATTEN 10dB MKR -44.83dBm RL 12.0dBm 10dB/ 15.53GHz</p> <p>START 10.00GHz STOP 20.00GHz *RBW 1.0MHz *VBW 1.0MHz SWP 200ms</p>			



Conducted Out Of Band Emissions (Continued)

802.11n Mode, 5GHz, 20MHz Wide

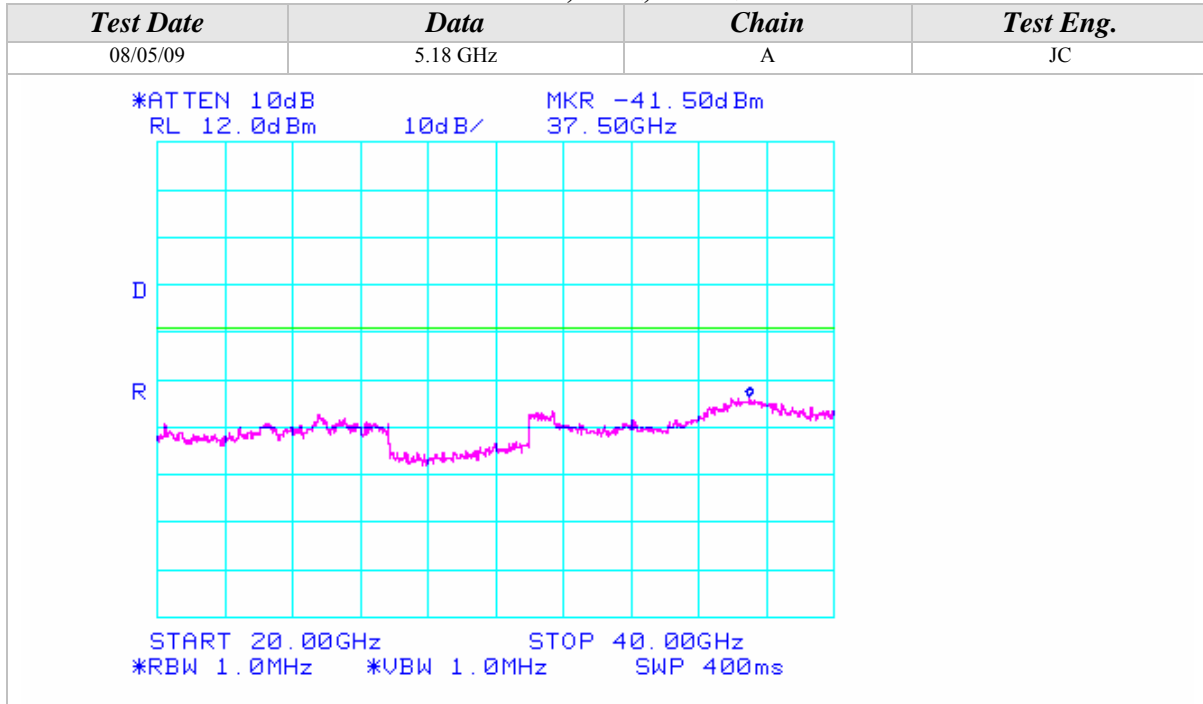



## Conducted Out Of Band Emissions (Continued)

## 802.11n Mode, 5GHz, 20MHz Wide

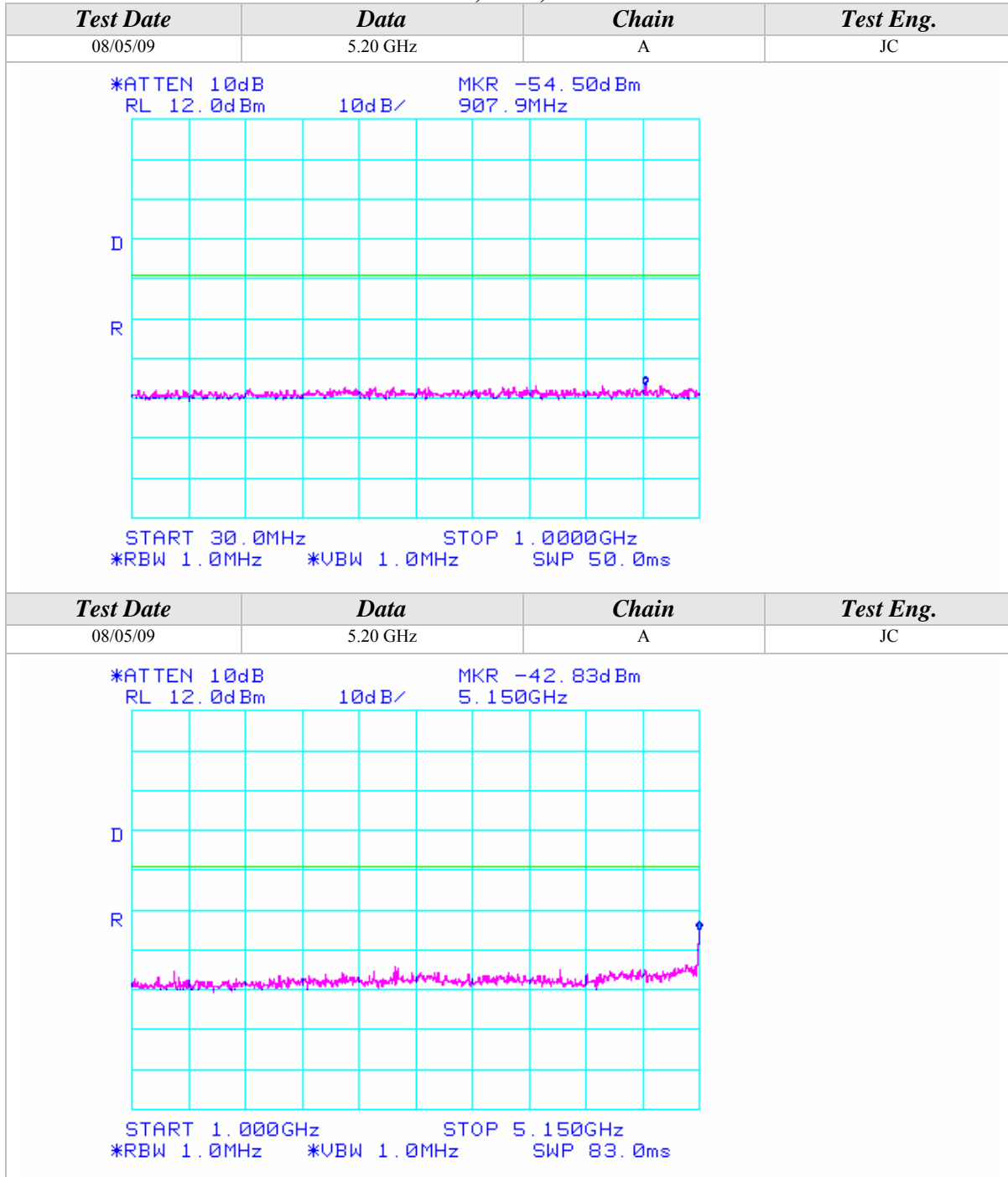



Conducted Out Of Band Emissions (Continued)

802.11n Mode, 5GHz, 20MHz Wide

<i>Test Date</i>	<i>Data</i>	<i>Chain</i>	<i>Test Eng.</i>
08/05/09	5.20 GHz	A	JC

\*ATTEN 10dB  
RL 12.0dBm 10dB/ MKR -48.33dBm  
6.931GHz

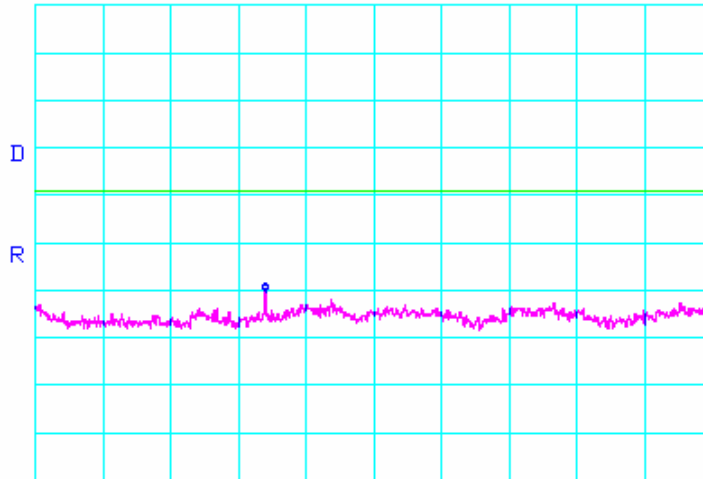

START 5.350GHz STOP 10.000GHz  
\*RBW 1.0MHz \*VBW 1.0MHz SWP 93.0ms

<i>Test Date</i>	<i>Data</i>	<i>Chain</i>	<i>Test Eng.</i>
08/05/09	5.20 GHz	A	JC

\*ATTEN 10dB  
RL 12.0dBm 10dB/ MKR -45.00dBm  
15.60GHz

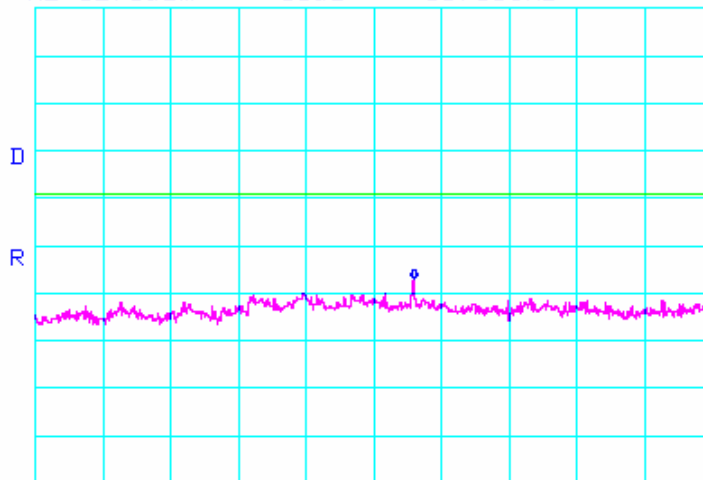

START 10.000GHz STOP 20.000GHz  
\*RBW 1.0MHz \*VBW 1.0MHz SWP 200ms



Conducted Out Of Band Emissions (Continued)

*802.11n Mode, 5GHz, 20MHz Wide*

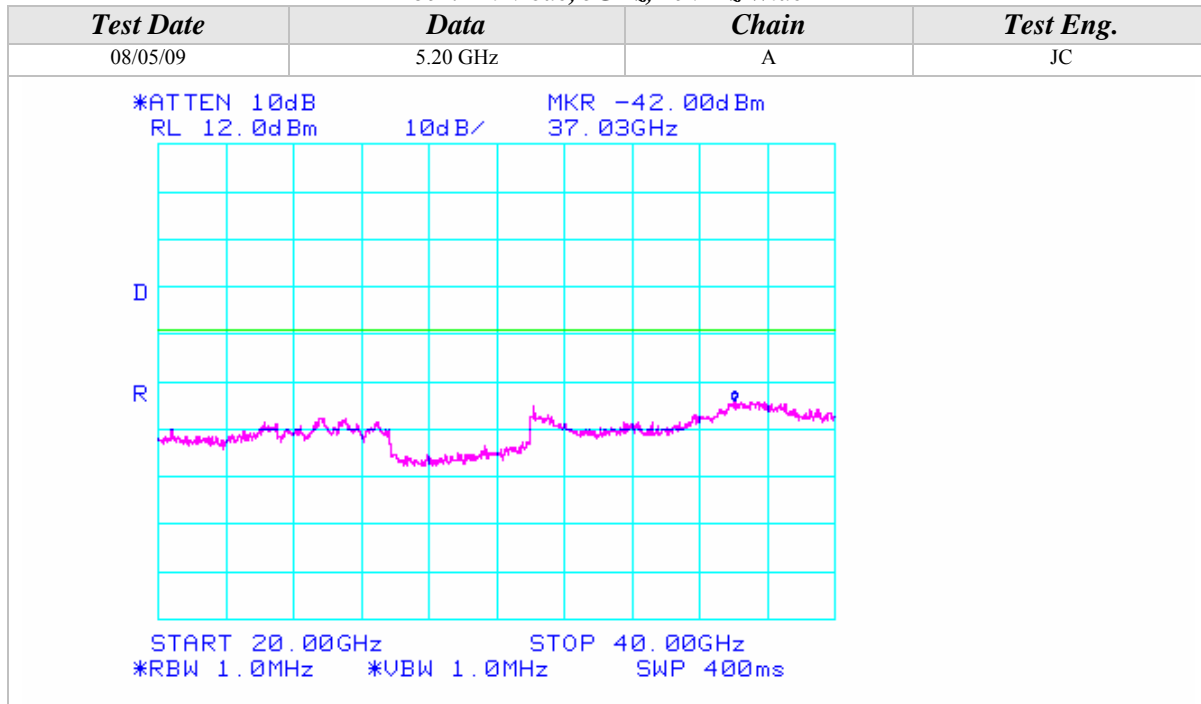



Conducted Out Of Band Emissions (Continued)

802.11n Mode, 5GHz, 20MHz Wide

Test Date	Data	Chain	Test Eng.
08/05/09	5.24 GHz	A	JC
<p>*ATTEN 10dB      MKR -54.67dBm            RL 12.0dBm      10dB/      540.9MHz</p> <p>START 30.0MHz      STOP 1.0000GHz            *RBW 1.0MHz      *VBW 1.0MHz      SWP 50.0ms</p>			
Test Date	Data	Chain	Test Eng.
08/05/09	5.24 GHz	A	JC
<p>*ATTEN 10dB      MKR -50.50dBm            RL 12.0dBm      10dB/      5.102GHz</p> <p>START 1.000GHz      STOP 5.150GHz            *RBW 1.0MHz      *VBW 1.0MHz      SWP 83.0ms</p>			



Conducted Out Of Band Emissions (Continued)

802.11n Mode, 5GHz, 20MHz Wide

Test Date	Data	Chain	Test Eng.
08/05/09	5.24 GHz	A	JC
<p>*ATTEN 10dB                      MKR -49.50dBm RL 12.0dBm                      10dB/                      5.366GHz</p> <p>START 5.350GHz                      STOP 10.000GHz *RBW 1.0MHz                      *VBW 1.0MHz                      SWP 93.0ms</p>			
Test Date	Data	Chain	Test Eng.
08/05/09	5.24 GHz	A	JC
<p>*ATTEN 10dB                      MKR -46.50dBm RL 12.0dBm                      10dB/                      15.70GHz</p> <p>START 10.00GHz                      STOP 20.00GHz *RBW 1.0MHz                      *VBW 1.0MHz                      SWP 200ms</p>			



Conducted Out Of Band Emissions (Continued)

802.11n Mode, 5GHz, 20MHz Wide

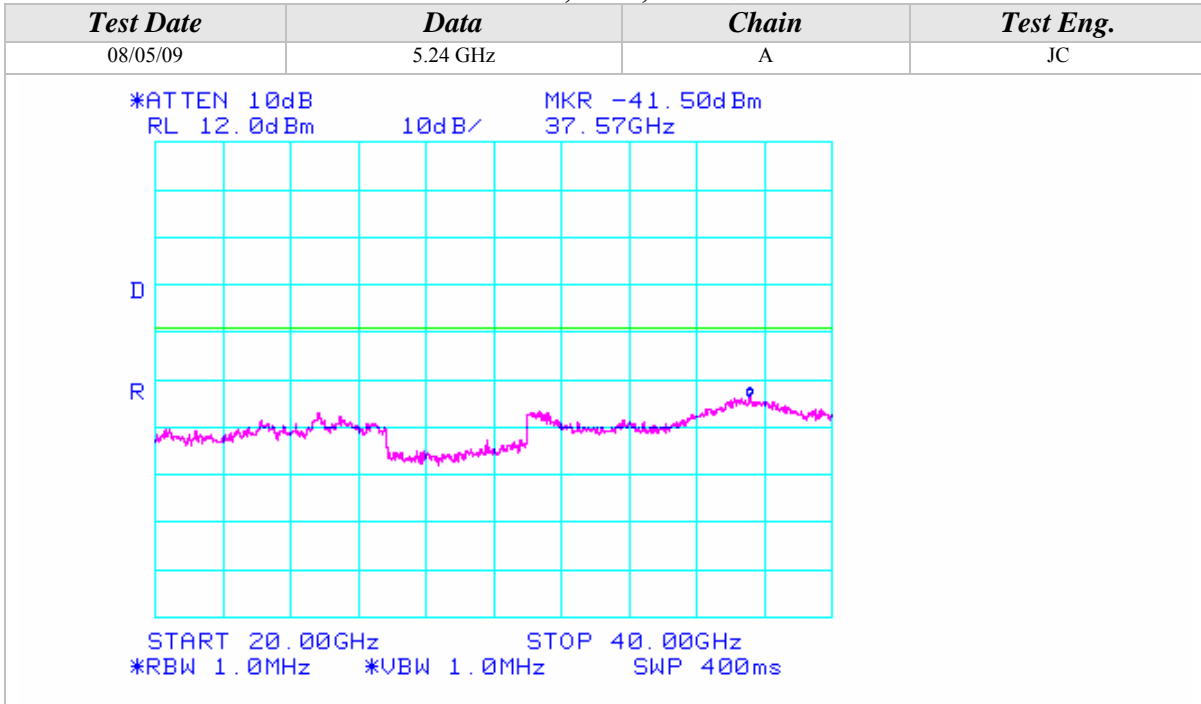

## Conducted Out Of Band Emissions (Continued)

## 802.11n Mode, 5GHz, 20MHz Wide

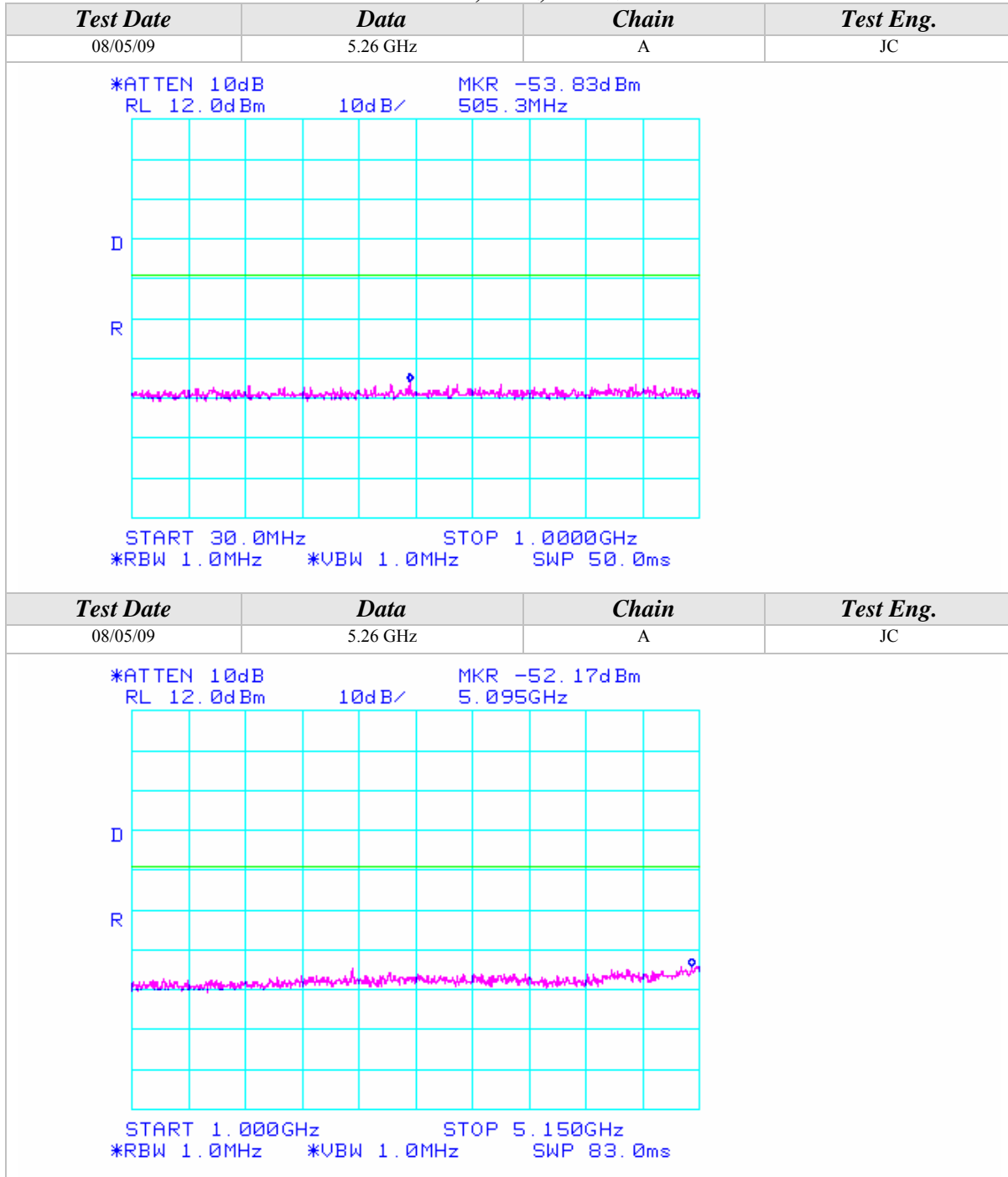



Conducted Out Of Band Emissions (Continued)

802.11n Mode, 5GHz, 20MHz Wide

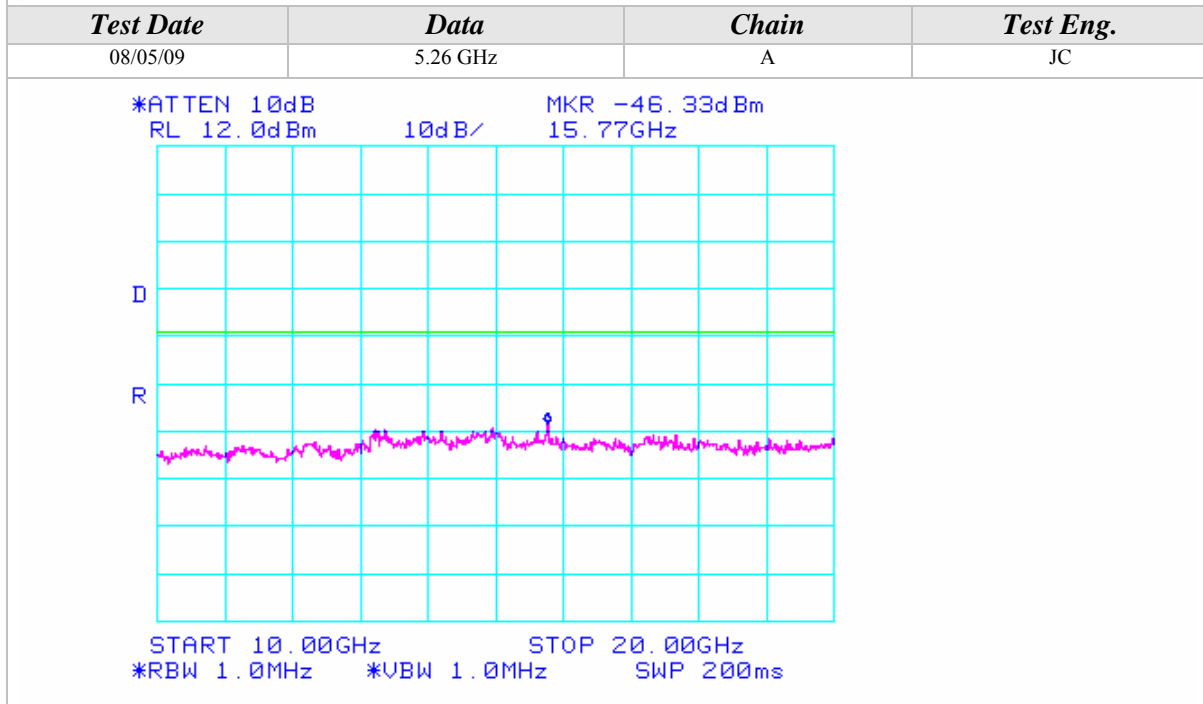
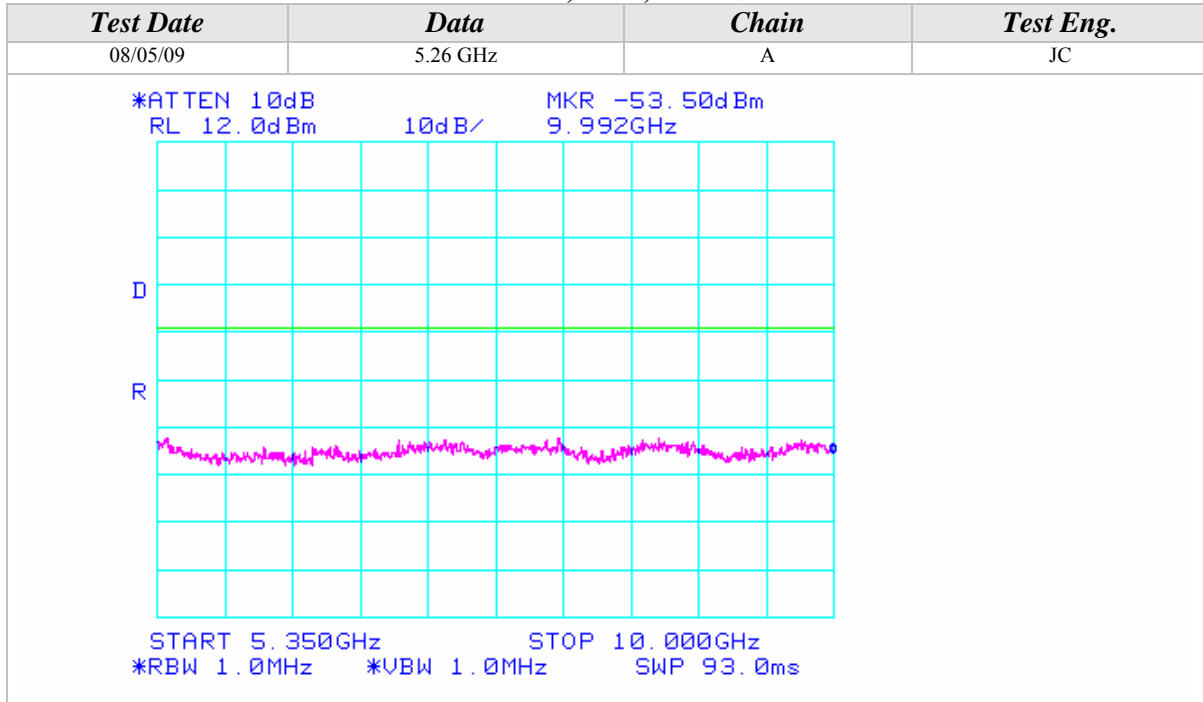



### Conducted Out Of Band Emissions (Continued)

#### 802.11n Mode, 5GHz, 20MHz Wide

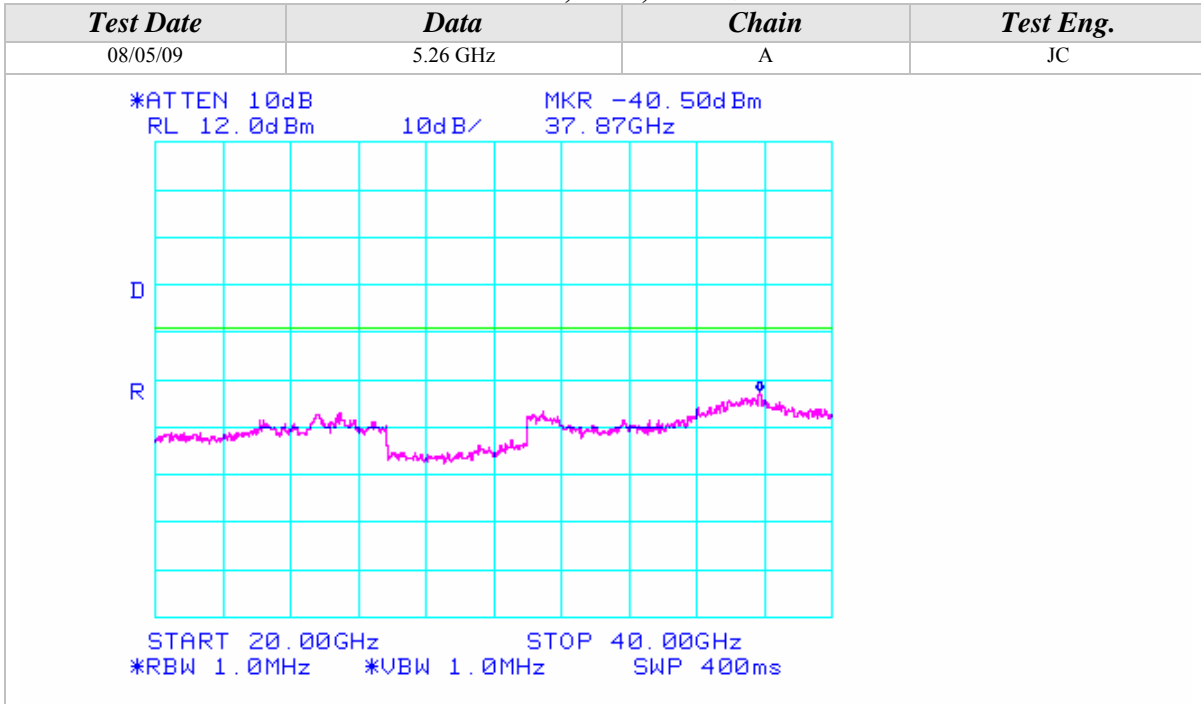





### Conducted Out Of Band Emissions (Continued)

802.11n Mode, 5GHz, 20MHz Wide

<b>Test Date</b>	<b>Data</b>	<b>Chain</b>	<b>Test Eng.</b>
08/05/09	5.28 GHz	A	JC
<p>*ATTEN 10dB                                    MKR -54.33dBm            RL 12.0dBm                                    10dB/                                    751.0MHz</p> <p>START 30.0MHz                                    STOP 1.0000GHz            *RBW 1.0MHz                                    *VBW 1.0MHz                                    SWP 50.0ms</p>			
<b>Test Date</b>	<b>Data</b>	<b>Chain</b>	<b>Test Eng.</b>
08/05/09	5.28 GHz	A	JC
<p>*ATTEN 10dB                                    MKR -52.17dBm            RL 12.0dBm                                    10dB/                                    5.129GHz</p> <p>START 1.000GHz                                    STOP 5.150GHz            *RBW 1.0MHz                                    *VBW 1.0MHz                                    SWP 83.0ms</p>			



### Conducted Out Of Band Emissions (Continued)

#### 802.11n Mode, 5GHz, 20MHz Wide

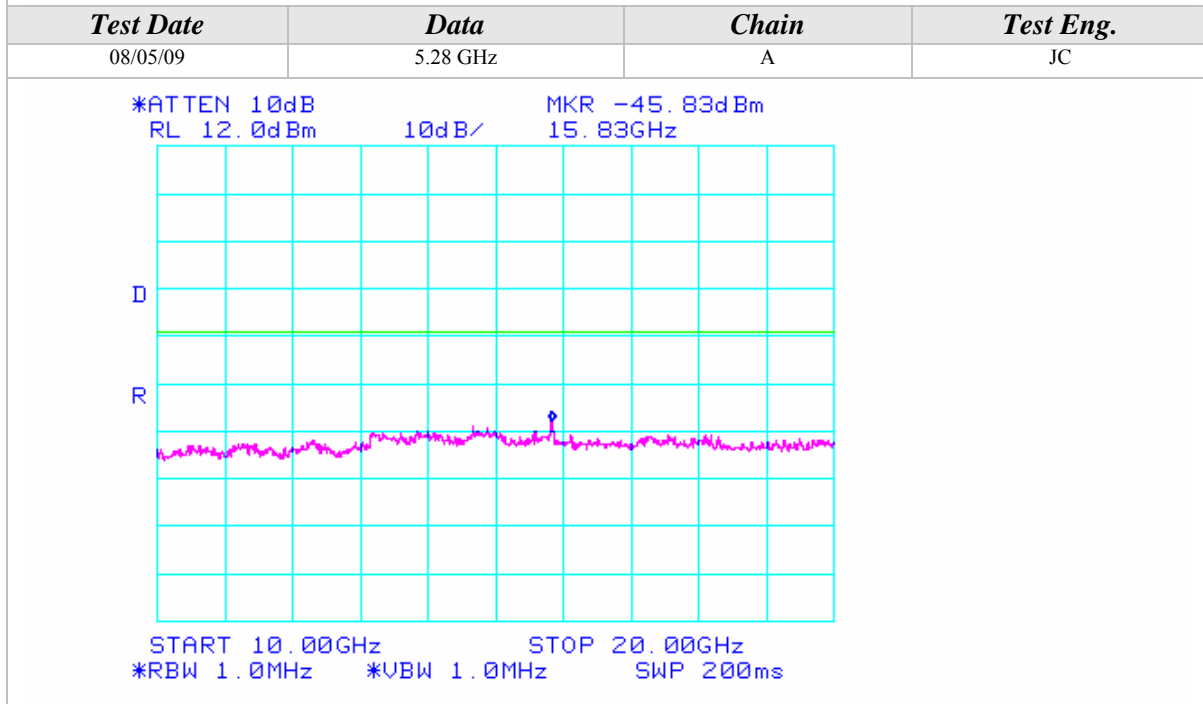
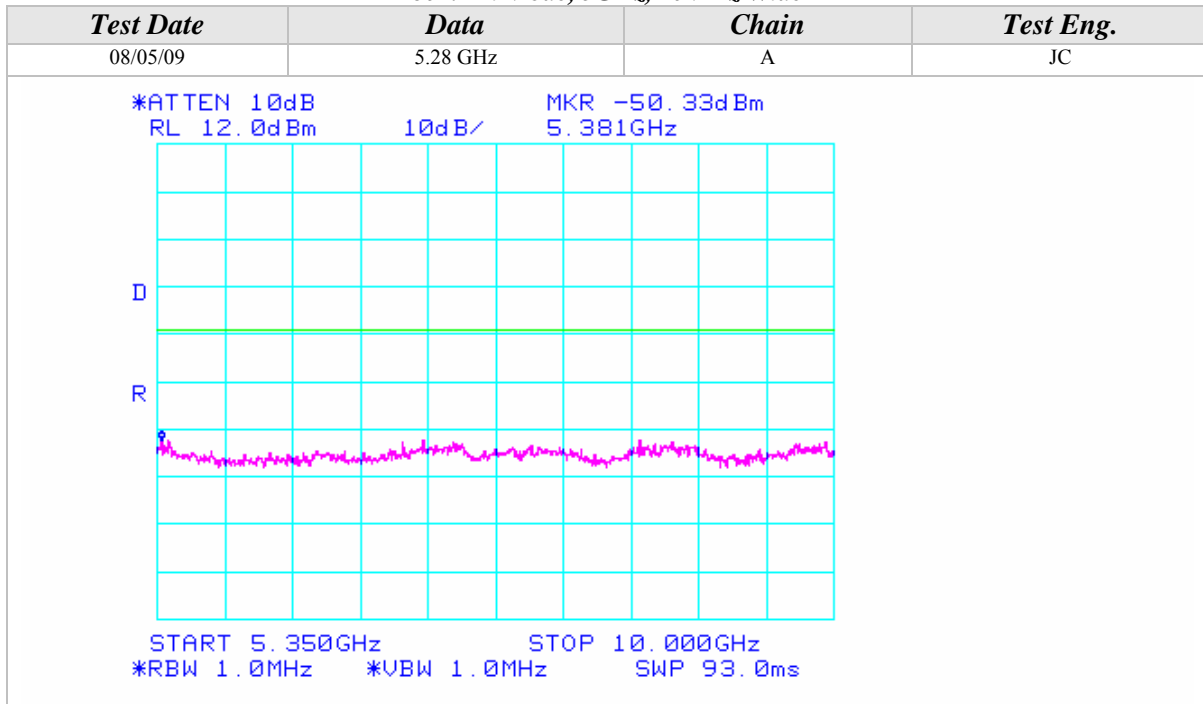

Conducted Out Of Band Emissions (Continued)

802.11n Mode, 5GHz, 20MHz Wide

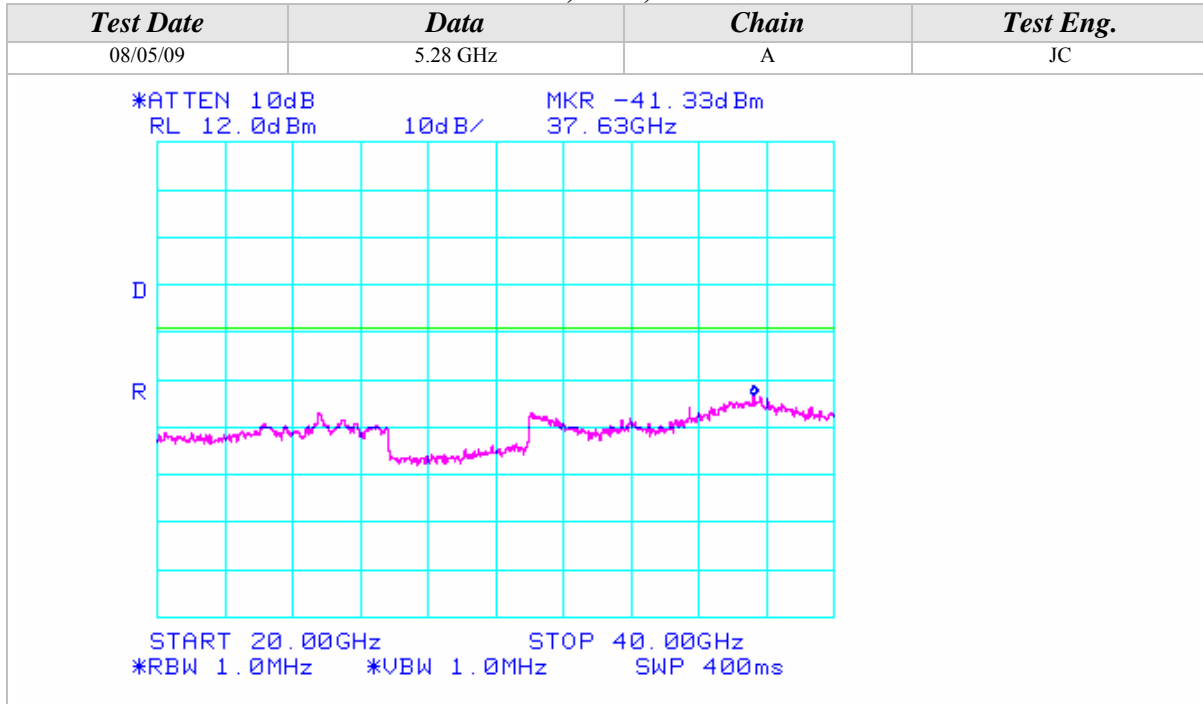



Conducted Out Of Band Emissions (Continued)

802.11n Mode, 5GHz, 20MHz Wide

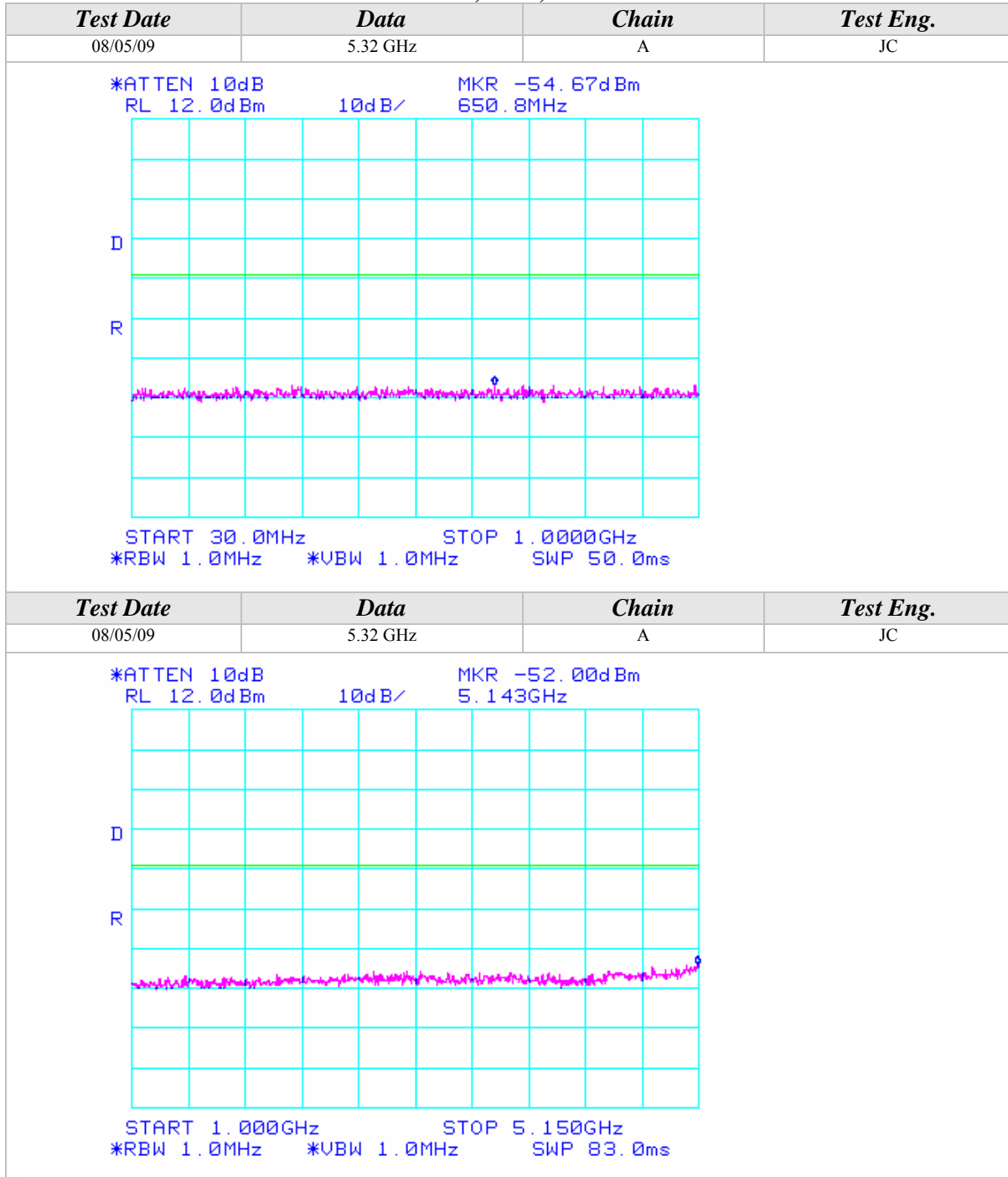



Conducted Out Of Band Emissions (Continued)

802.11n Mode, 5GHz, 20MHz Wide

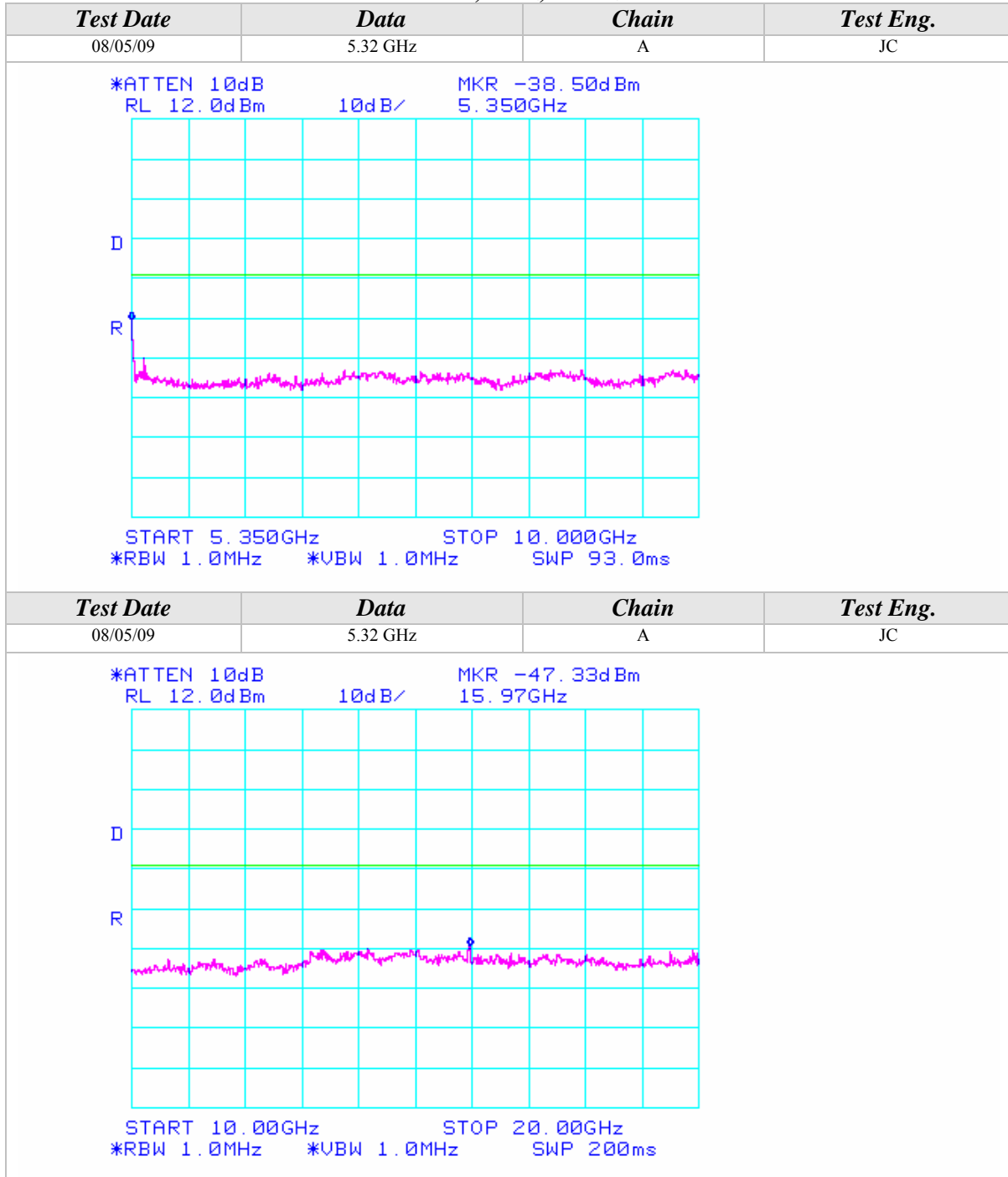



### Conducted Out Of Band Emissions (Continued)

802.11n Mode, 5GHz, 20MHz Wide

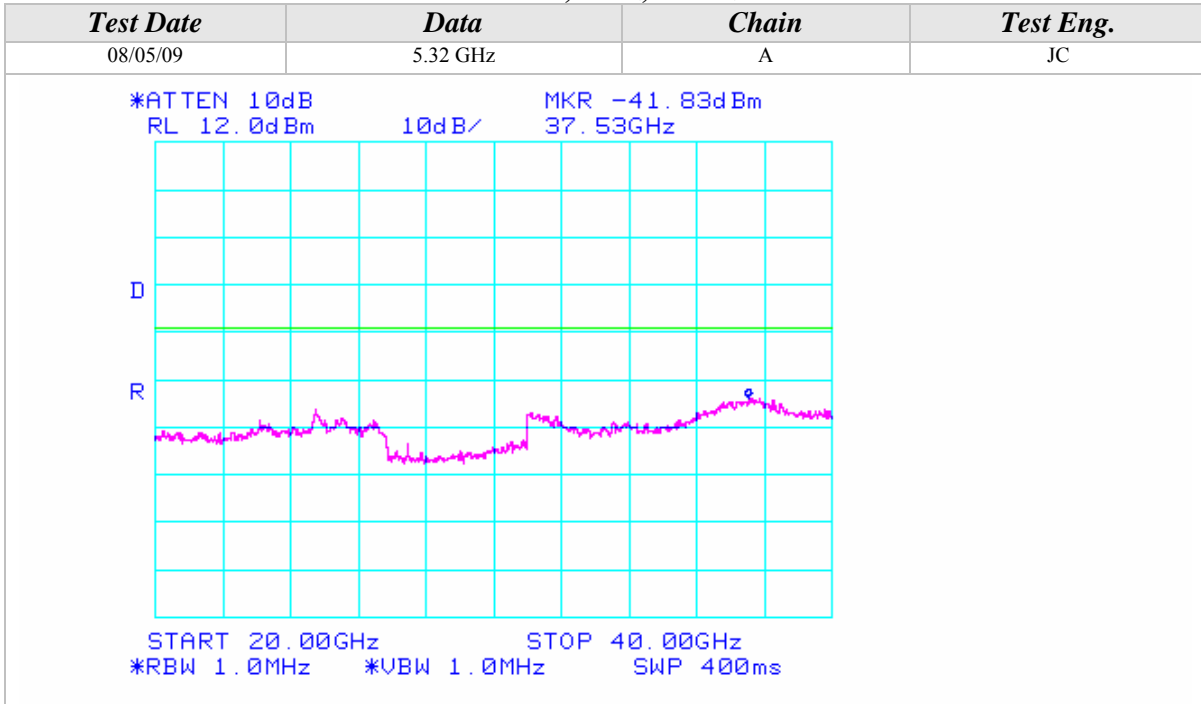



## Conducted Out Of Band Emissions (Continued)

**802.11n Mode, 5GHz, 20MHz Wide**

<b>Test Date</b>	<b>Data</b>	<b>Chain</b>	<b>Test Eng.</b>
08/05/09	5.50 GHz	A	JC
<p>*ATTEN 10dB                                    MKR -54.33dBm            RL 12.0dBm                                  10dB/                                  312.9MHz</p> <p>START 30.0MHz                                    STOP 1.0000GHz            *RBW 1.0MHz                                  *VBW 1.0MHz                                  SWP 50.0ms</p>			
<b>Test Date</b>	<b>Data</b>	<b>Chain</b>	<b>Test Eng.</b>
08/05/09	5.50 GHz	A	JC
<p>*ATTEN 10dB                                    MKR -37.00dBm            RL 12.0dBm                                  10dB/                                  5.460GHz</p> <p>START 1.000GHz                                    STOP 5.460GHz            *RBW 1.0MHz                                  *VBW 1.0MHz                                  SWP 90.0ms</p>			



Conducted Out Of Band Emissions (Continued)

802.11n Mode, 5GHz, 20MHz Wide

Test Date	Data	Chain	Test Eng.
08/05/09	5.50 GHz	A	JC
<p>*ATTEN 10dB                                      MKR -50.50dBm            RL 12.0dBm                                      10dB/                                      8.860GHz</p> <p>START 5.725GHz                                      STOP 10.000GHz            *RBW 1.0MHz                                      *VBW 1.0MHz                                      SWP 86.0ms</p>			
Test Date	Data	Chain	Test Eng.
08/05/09	5.50 GHz	A	JC
<p>*ATTEN 10dB                                      MKR -47.83dBm            RL 12.0dBm                                      10dB/                                      13.82GHz</p> <p>START 10.000GHz                                      STOP 20.000GHz            *RBW 1.0MHz                                      *VBW 1.0MHz                                      SWP 200ms</p>			



Conducted Out Of Band Emissions (Continued)

802.11n Mode, 5GHz, 20MHz Wide

Test Date	Data	Chain	Test Eng.
08/05/09	5.50 GHz	A	JC

\*ATTEN 10dB                      MKR -41.67dBm  
 RL 12.0dBm                      10dB/                      37.30GHz

START 20.00GHz                      STOP 40.00GHz  
 \*RBW 1.0MHz                      \*VBW 1.0MHz                      SWP 400ms



Conducted Out Of Band Emissions (Continued)

802.11n Mode, 5GHz, 20MHz Wide

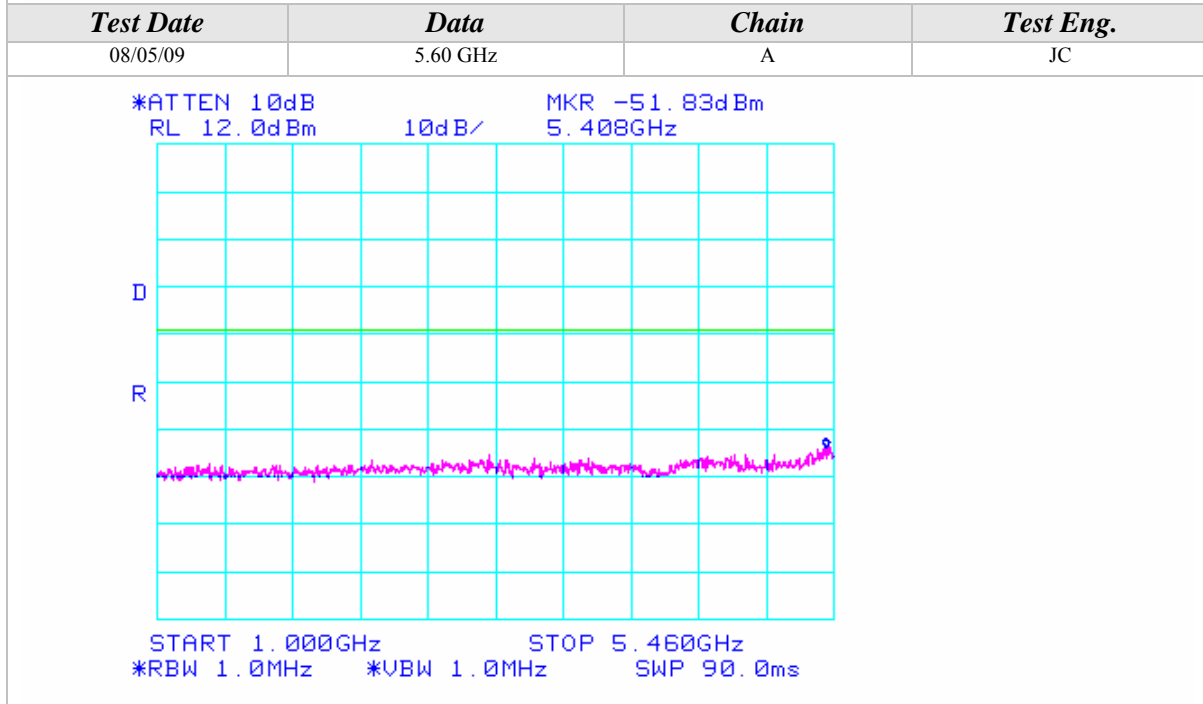
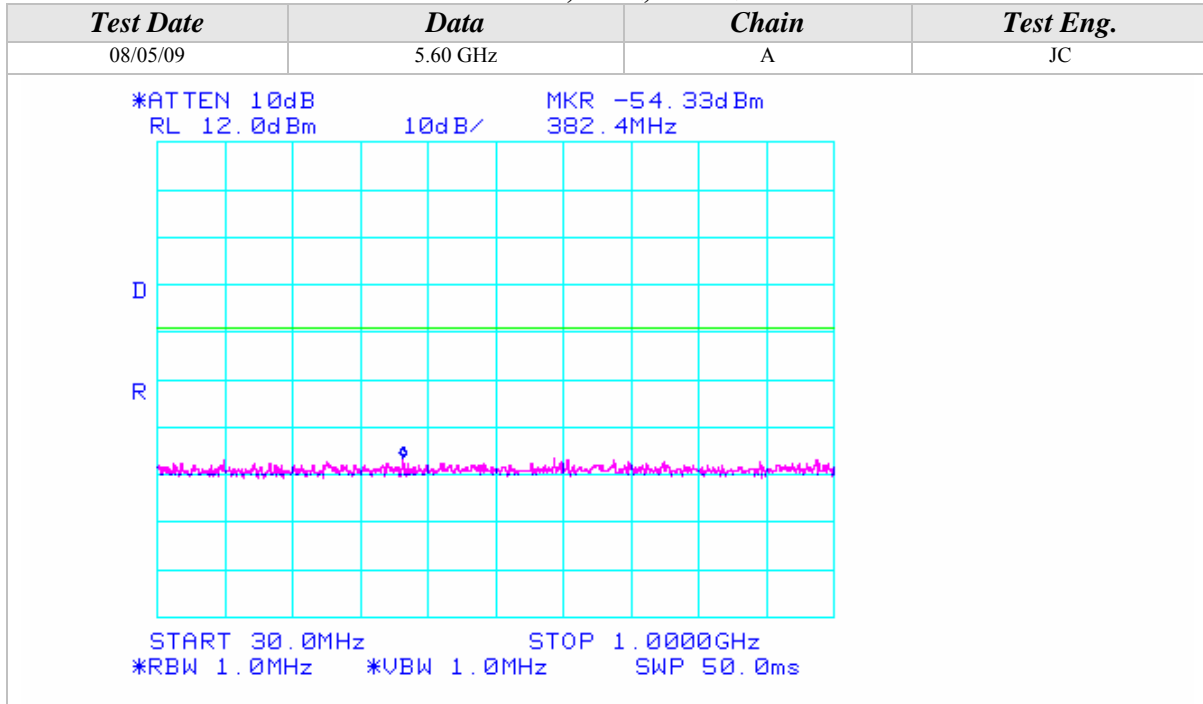

### Conducted Out Of Band Emissions (Continued)

802.11n Mode, 5GHz, 20MHz Wide

<i>Test Date</i>	<i>Data</i>	<i>Chain</i>	<i>Test Eng.</i>
08/05/09	5.60 GHz	A	JC
<p>*ATTEN 10dB          MKR -49.50dBm RL 12.0dBm          10dB/          8.034GHz</p> <p>START 5.725GHz          STOP 10.000GHz *RBW 1.0MHz          *VBW 1.0MHz          SWP 86.0ms</p>			
<i>Test Date</i>	<i>Data</i>	<i>Chain</i>	<i>Test Eng.</i>
08/05/09	5.60 GHz	A	JC
<p>*ATTEN 10dB          MKR -47.17dBm RL 12.0dBm          10dB/          13.17GHz</p> <p>START 10.00GHz          STOP 20.00GHz *RBW 1.0MHz          *VBW 1.0MHz          SWP 200ms</p>			



### Conducted Out Of Band Emissions (Continued)

802.11n Mode, 5GHz, 20MHz Wide

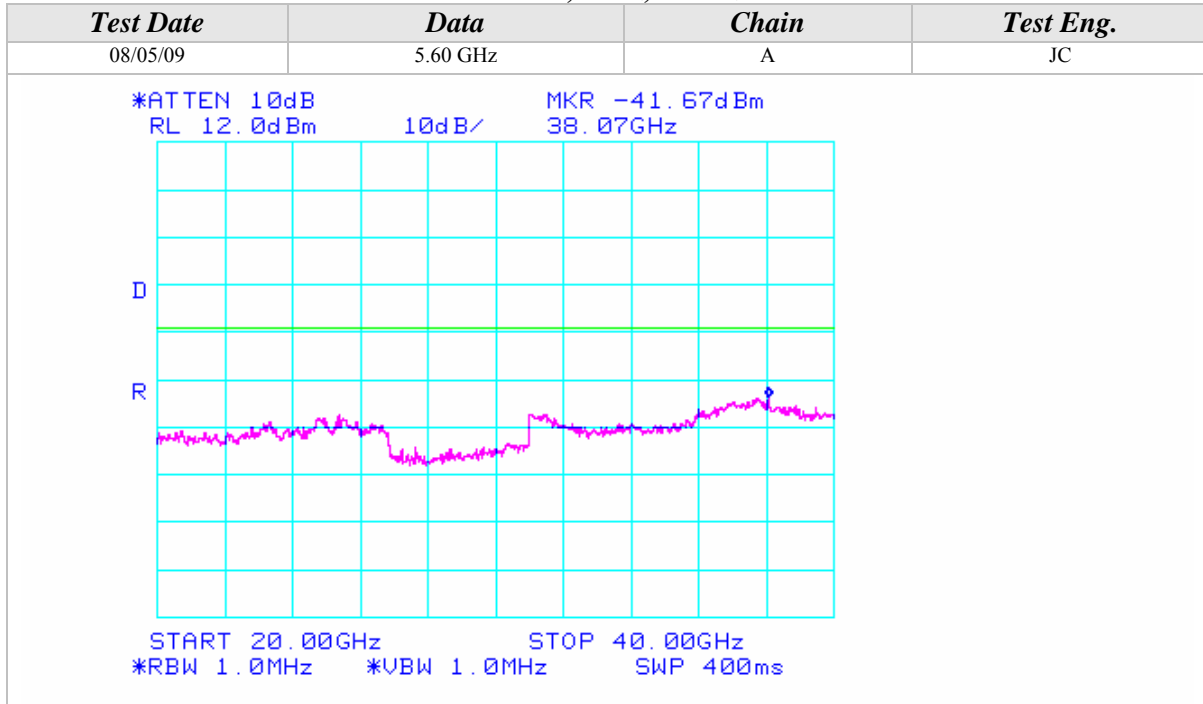



### Conducted Out Of Band Emissions (Continued)

#### 802.11n Mode, 5GHz, 20MHz Wide

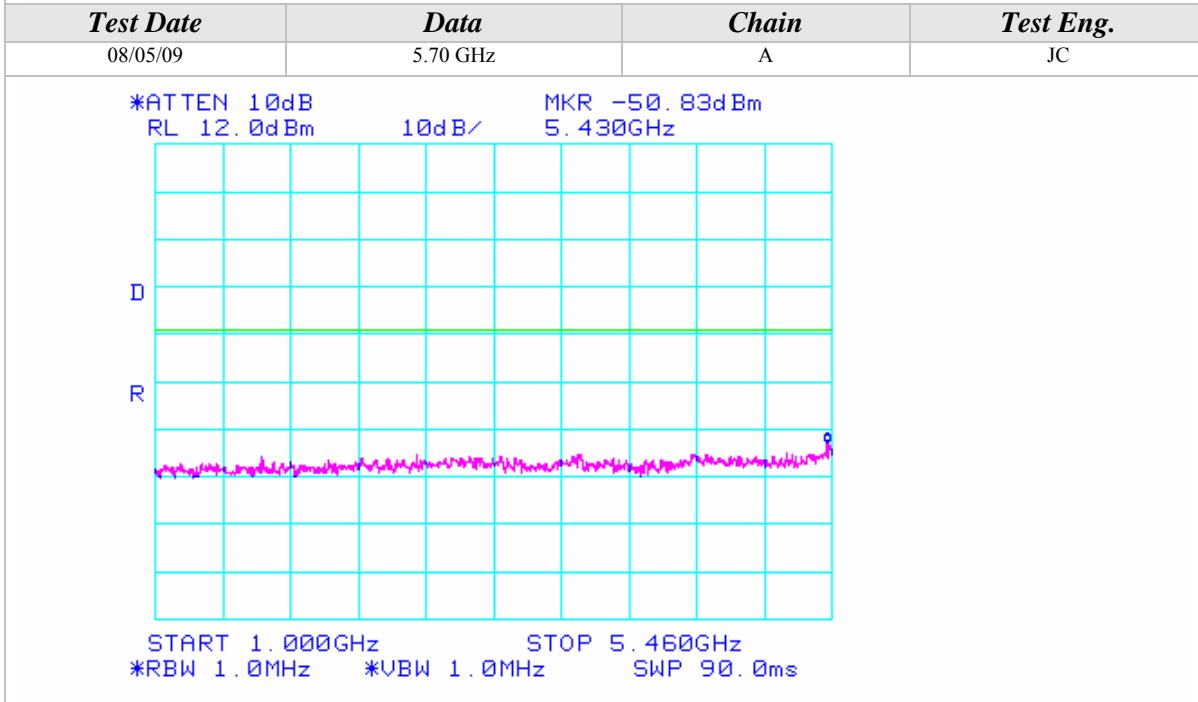
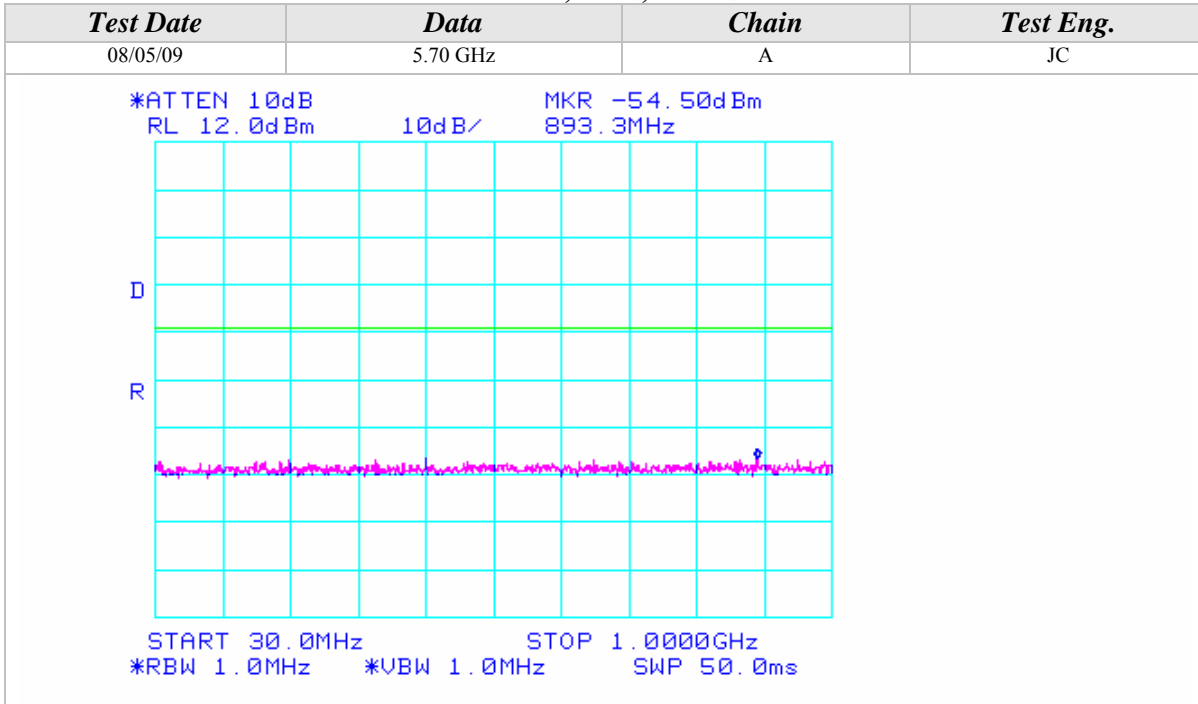



Conducted Out Of Band Emissions (Continued)

802.11n Mode, 5GHz, 20MHz Wide

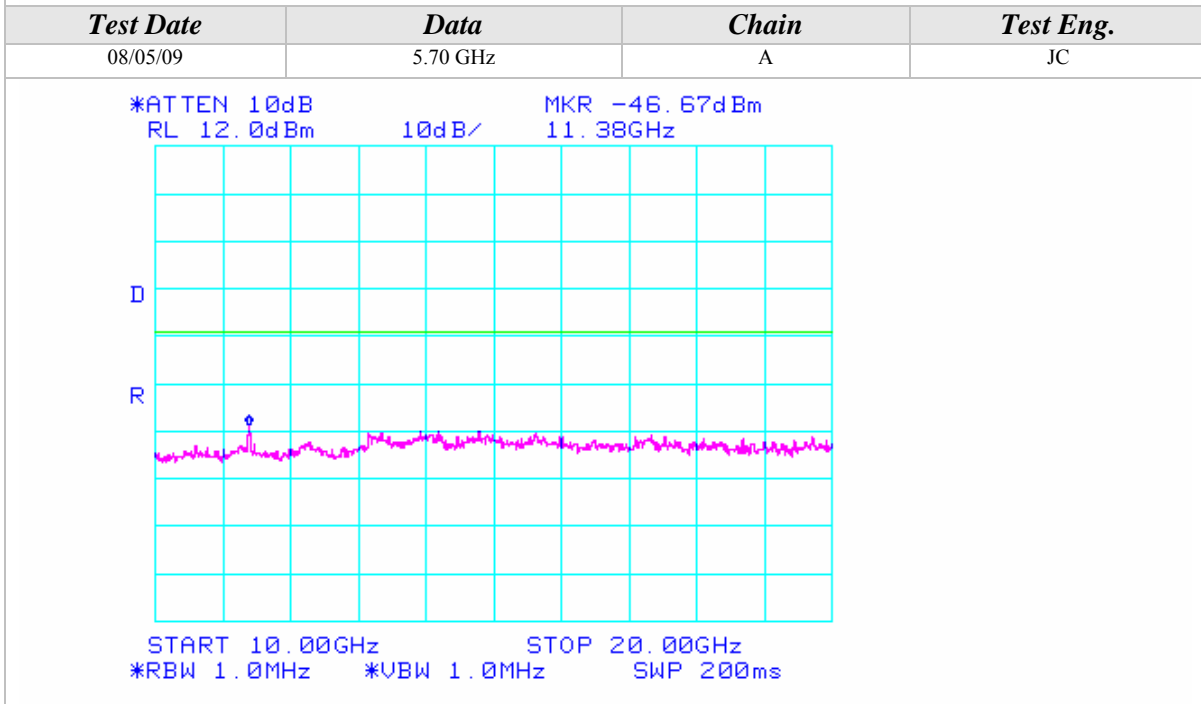
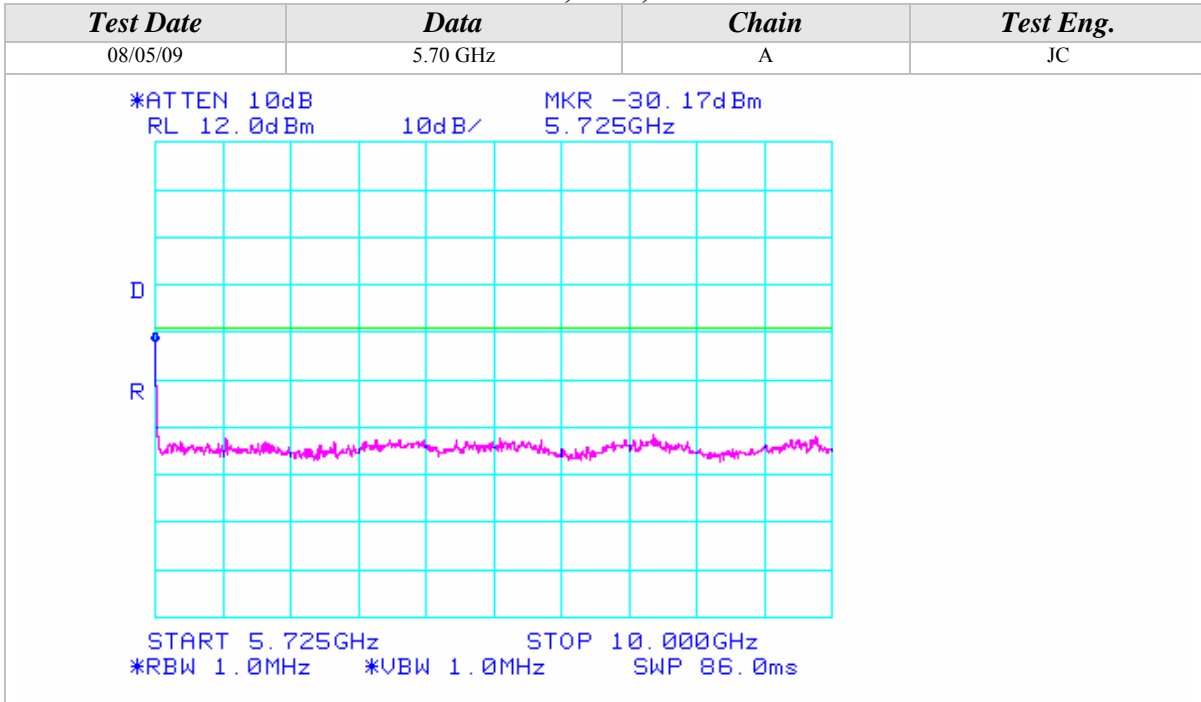



Conducted Out Of Band Emissions (Continued)

802.11n Mode, 5GHz, 20MHz Wide

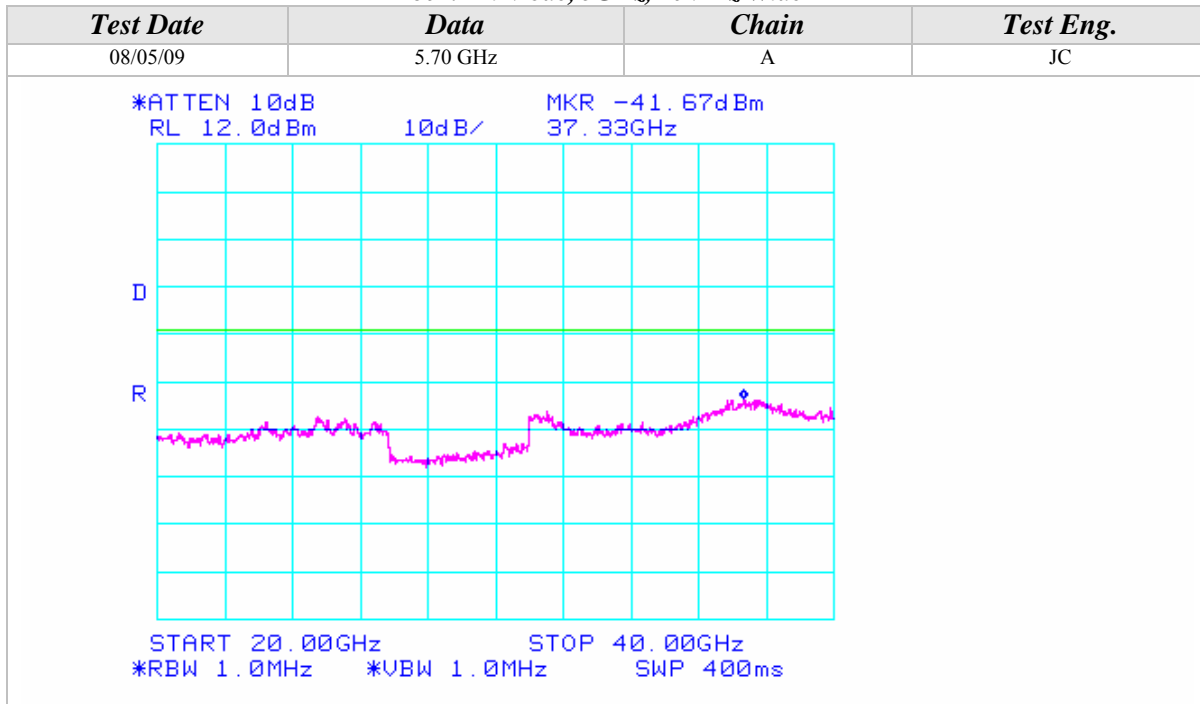



Conducted Out Of Band Emissions (Continued)

802.11n Mode, 5GHz, 40MHz Wide

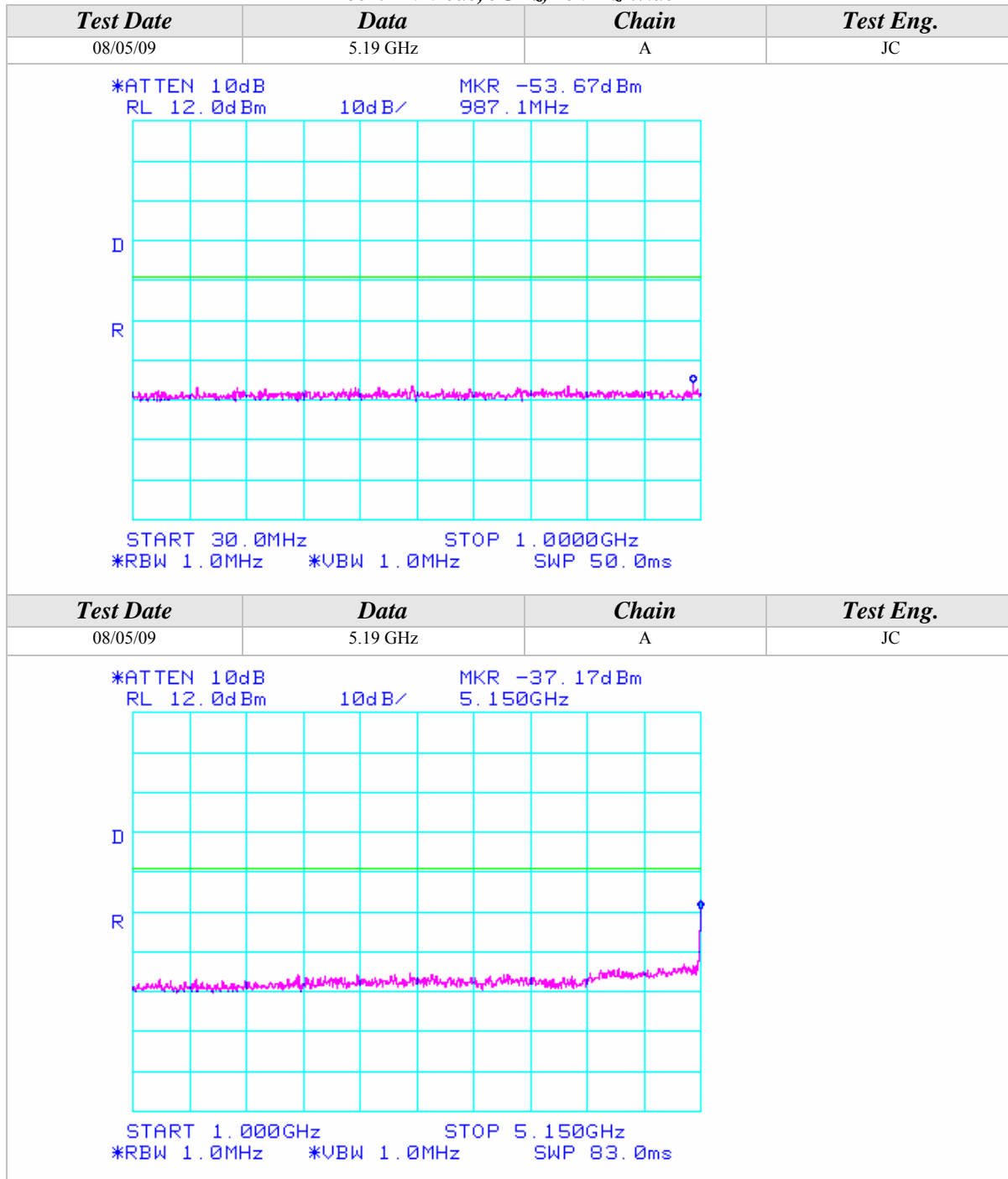





Conducted Out Of Band Emissions (Continued)

802.11n Mode, 5GHz, 40MHz Wide

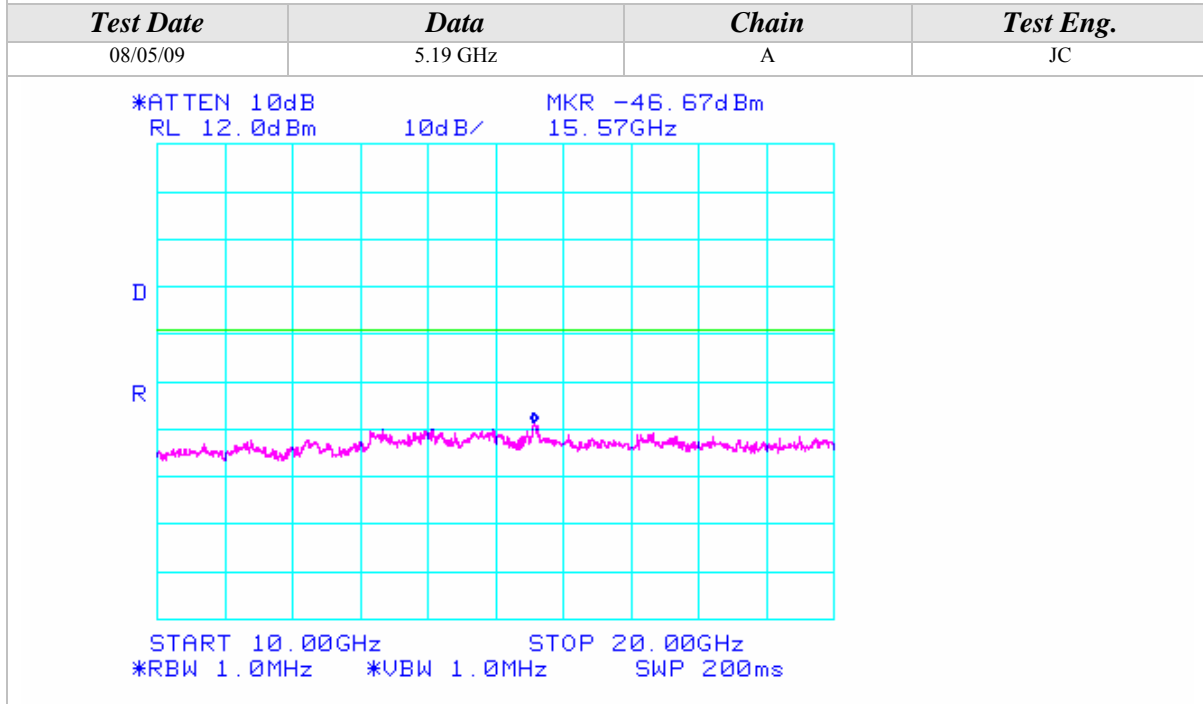
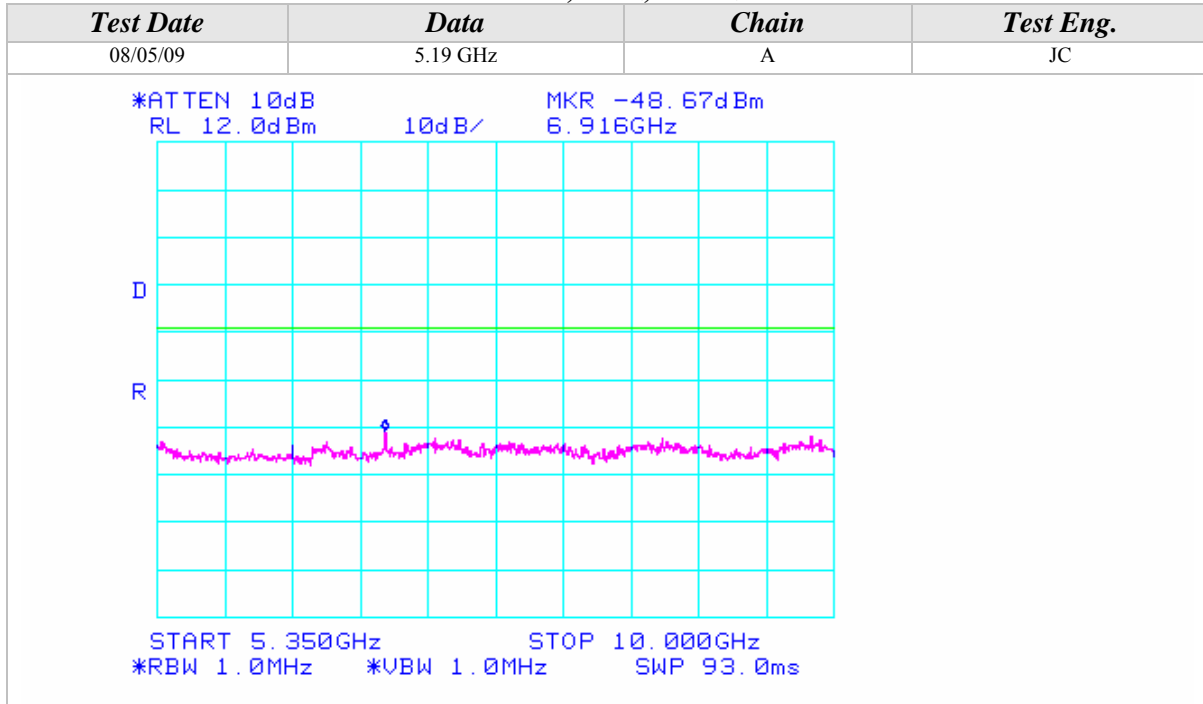



Conducted Out Of Band Emissions (Continued)

802.11n Mode, 5GHz, 40MHz Wide

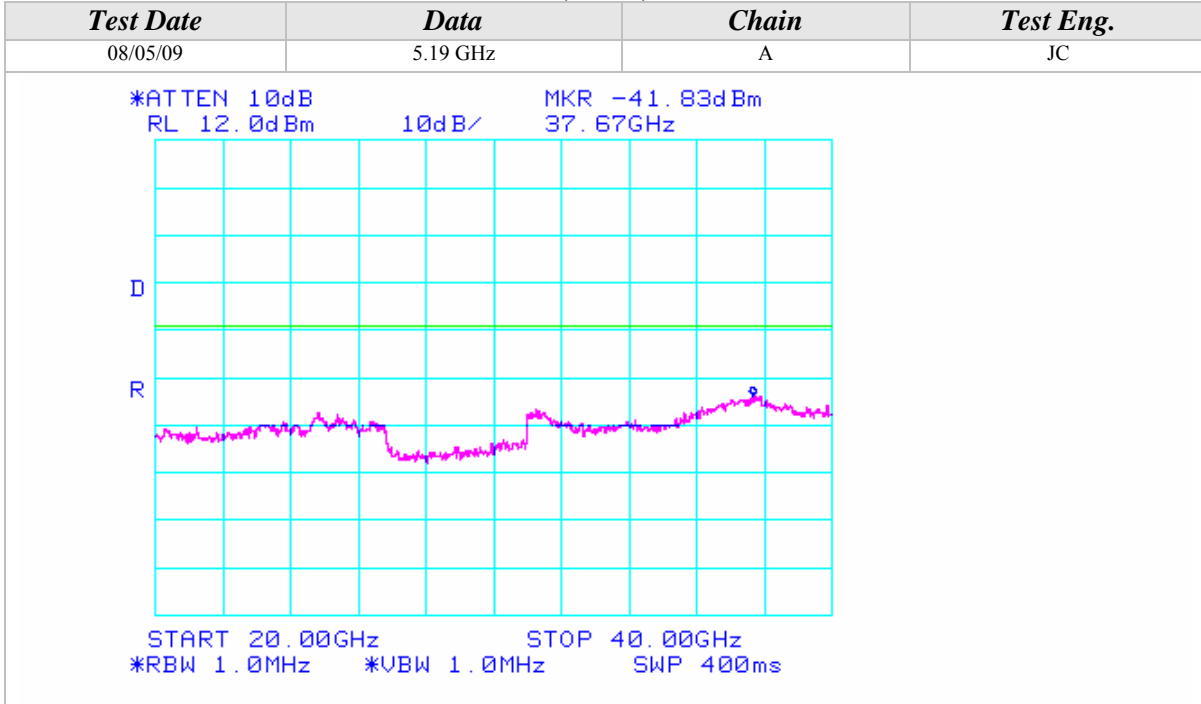



Conducted Out Of Band Emissions (Continued)

802.11n Mode, 5GHz, 40MHz Wide

<i>Test Date</i>	<i>Data</i>	<i>Chain</i>	<i>Test Eng.</i>
08/05/09	5.23 GHz	A	JC

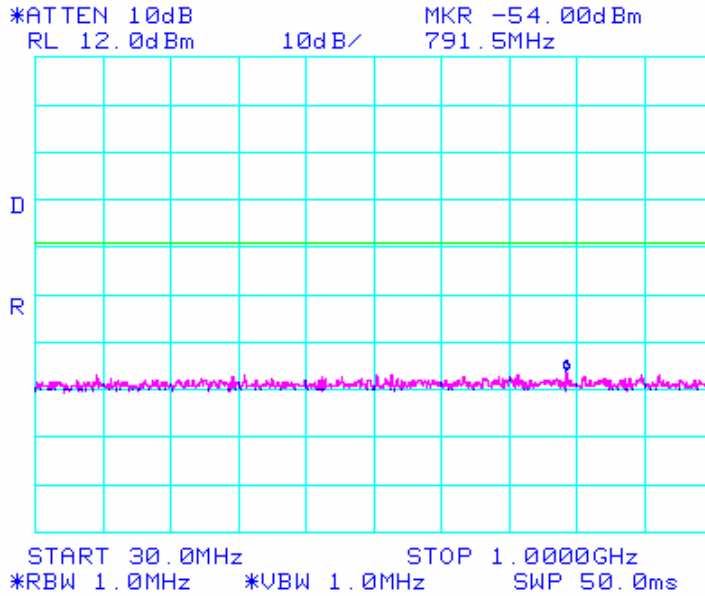

<i>Test Date</i>	<i>Data</i>	<i>Chain</i>	<i>Test Eng.</i>
08/05/09	5.23 GHz	A	JC

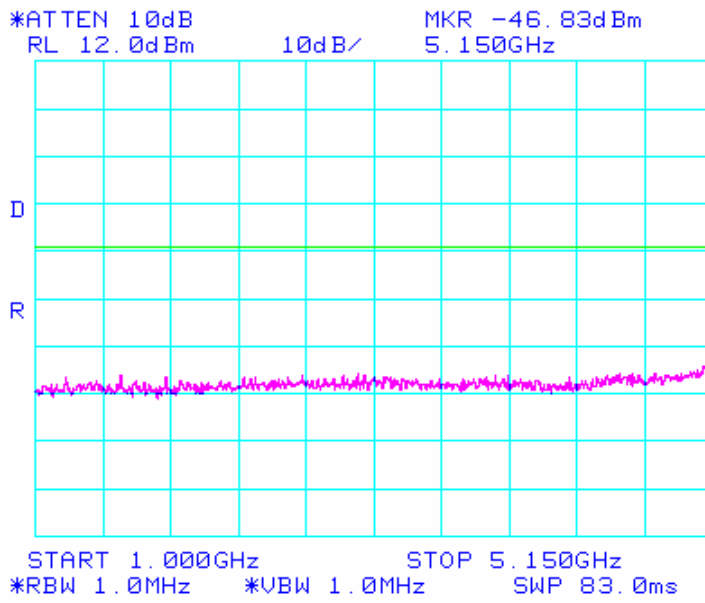



Conducted Out Of Band Emissions (Continued)

*802.11n Mode, 5GHz, 40MHz Wide*

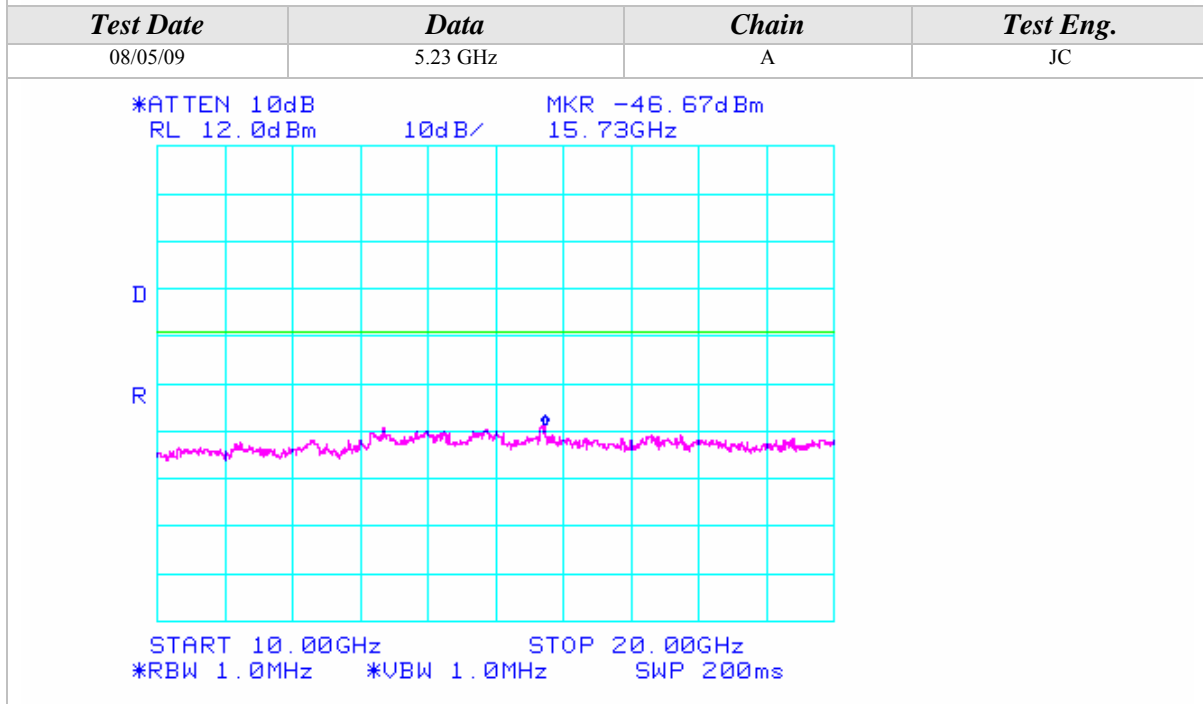
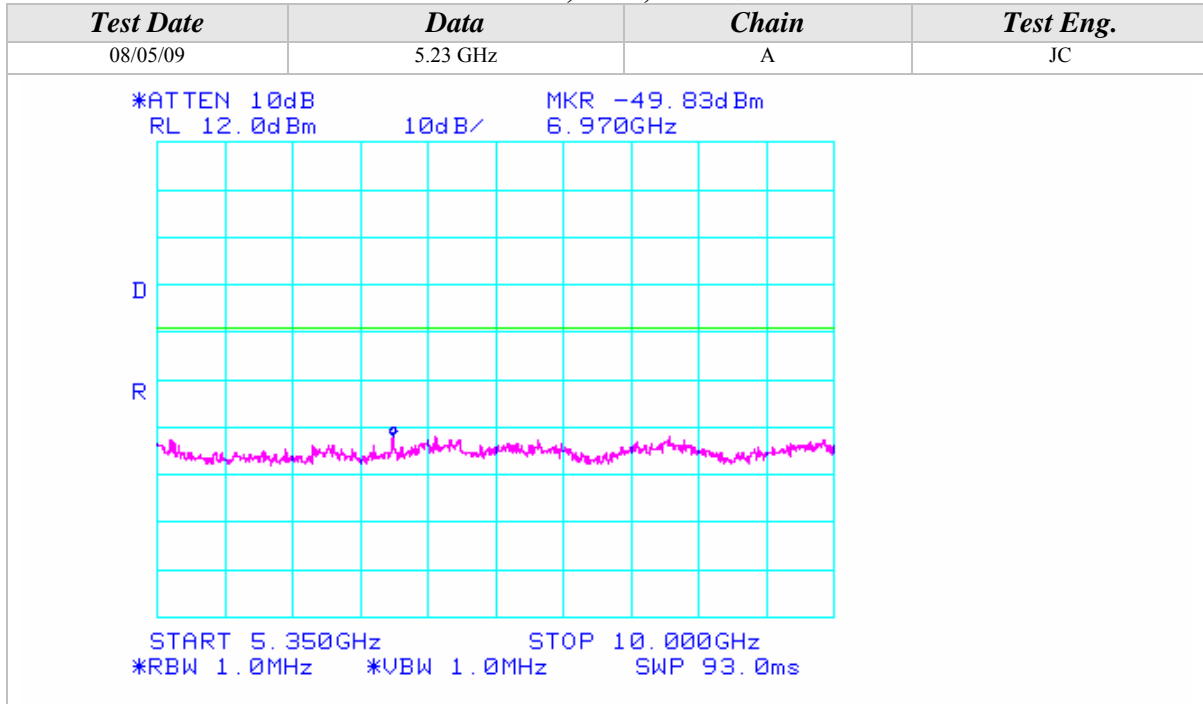



Conducted Out Of Band Emissions (Continued)

802.11n Mode, 5GHz, 40MHz Wide

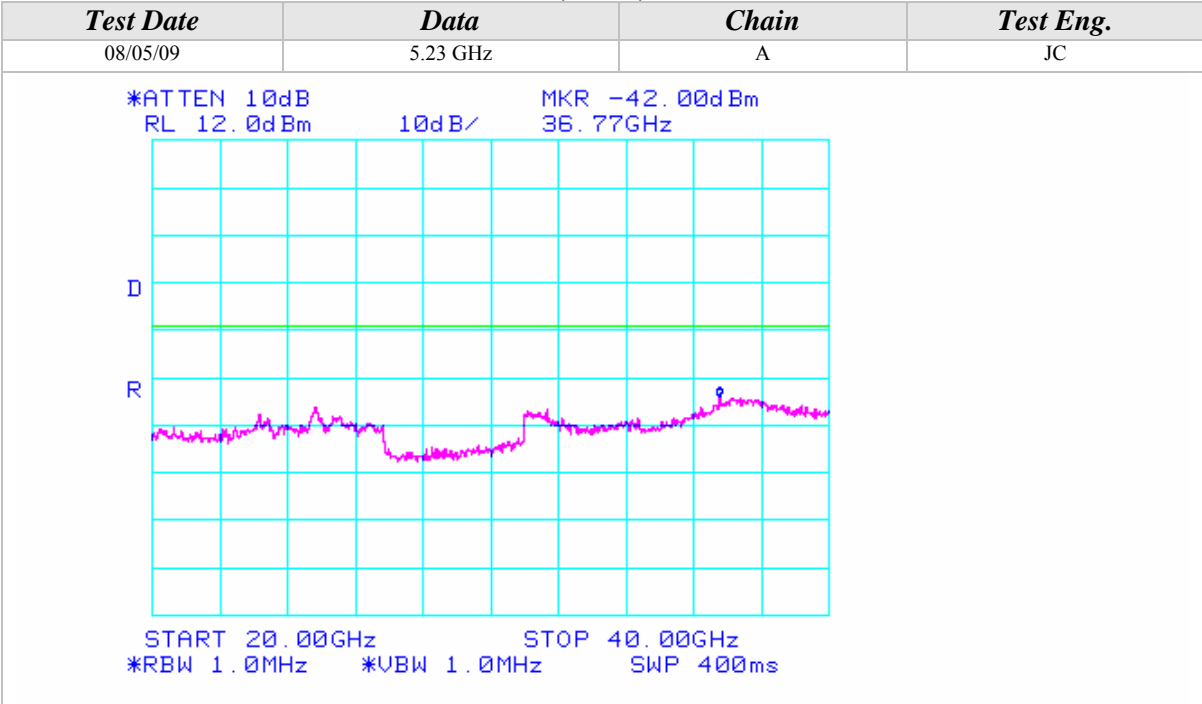



### Conducted Out Of Band Emissions (Continued)

#### 802.11n Mode, 5GHz, 40MHz Wide

Test Date	Data	Chain	Test Eng.
08/05/09	5.27 GHz	A	JC
<p>*ATTEN 10dB      MKR -53.83dBm RL 12.0dBm      10dB/      498.8MHz</p> <p>START 30.0MHz      STOP 1.0000GHz *RBW 1.0MHz      *VBW 1.0MHz      SWP 50.0ms</p>			
Test Date	Data	Chain	Test Eng.
08/05/09	5.27 GHz	A	JC
<p>*ATTEN 10dB      MKR -51.67dBm RL 12.0dBm      10dB/      5.109GHz</p> <p>START 1.000GHz      STOP 5.150GHz *RBW 1.0MHz      *VBW 1.0MHz      SWP 83.0ms</p>			



Conducted Out Of Band Emissions (Continued)

802.11n Mode, 5GHz, 40MHz Wide

<i>Test Date</i>	<i>Data</i>	<i>Chain</i>	<i>Test Eng.</i>
08/05/09	5.27 GHz	A	JC
<p>*ATTEN 10dB                      MKR -47.00dBm  RL 12.0dBm                    10dB/                      5.350GHz</p> <p>START 5.350GHz                    STOP 10.000GHz  *RBW 1.0MHz            *VBW 1.0MHz            SWP 93.0ms</p>			
<i>Test Date</i>	<i>Data</i>	<i>Chain</i>	<i>Test Eng.</i>
08/05/09	5.27 GHz	A	JC
<p>*ATTEN 10dB                      MKR -45.83dBm  RL 12.0dBm                    10dB/                      15.78GHz</p> <p>START 10.000GHz                  STOP 20.000GHz  *RBW 1.0MHz            *VBW 1.0MHz            SWP 200ms</p>			



### Conducted Out Of Band Emissions (Continued)

*802.11n Mode, 5GHz, 40MHz Wide*

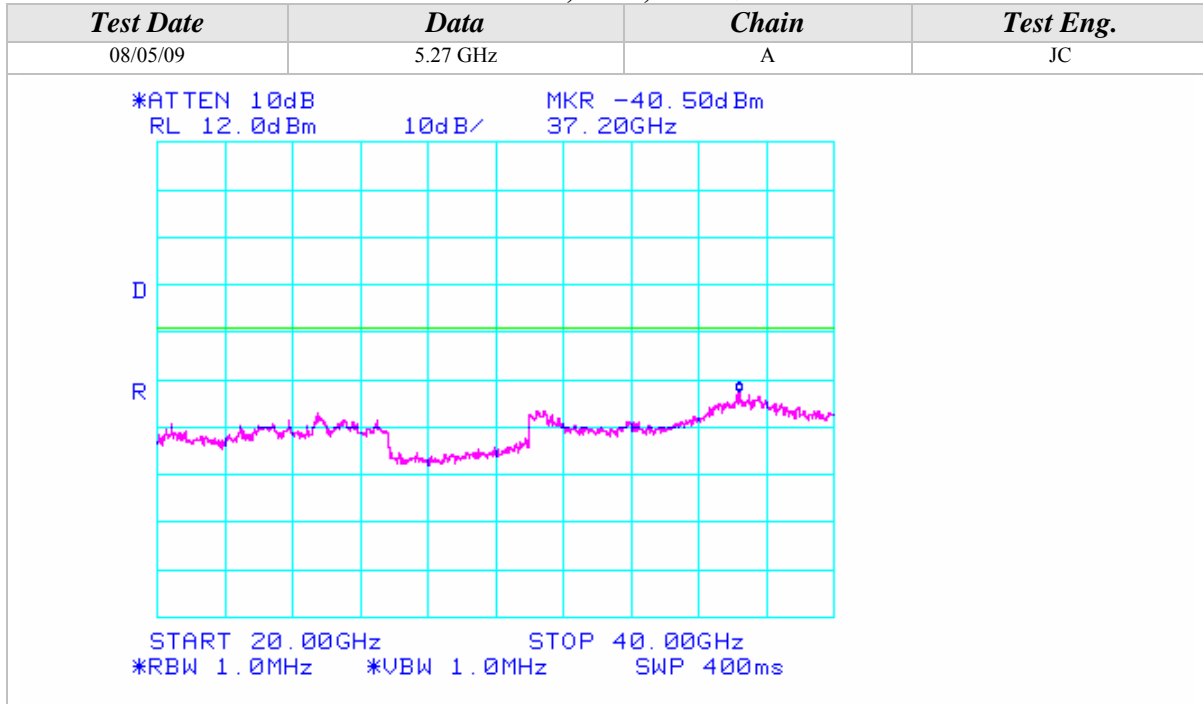





Conducted Out Of Band Emissions (Continued)

802.11n Mode, 5GHz, 40MHz Wide

Test Date	Data	Chain	Test Eng.
08/05/09	5.31 GHz	A	JC
<p>*ATTEN 10dB      MKR -54.33dBm RL 12.0dBm      10dB/      416.4MHz</p> <p>START 30.0MHz      STOP 1.0000GHz *RBW 1.0MHz      *VBW 1.0MHz      SWP 50.0ms</p>			
Test Date	Data	Chain	Test Eng.
08/05/09	5.31 GHz	A	JC
<p>*ATTEN 10dB      MKR -51.50dBm RL 12.0dBm      10dB/      5.136GHz</p> <p>START 1.000GHz      STOP 5.150GHz *RBW 1.0MHz      *VBW 1.0MHz      SWP 83.0ms</p>			

Conducted Out Of Band Emissions (Continued)

802.11n Mode, 5GHz, 40MHz Wide

Test Date	Data	Chain	Test Eng.
08/05/09	5.31 GHz	A	JC
<p>*ATTEN 10dB      MKR -29.17dBm RL 12.0dBm      10dB/      5.350GHz</p> <p>START 5.350GHz      STOP 10.000GHz *RBW 1.0MHz      *VBW 1.0MHz      SWP 93.0ms</p>			
Test Date	Data	Chain	Test Eng.
08/05/09	5.31 GHz	A	JC
<p>*ATTEN 10dB      MKR -47.17dBm RL 12.0dBm      10dB/      14.10GHz</p> <p>START 10.000GHz      STOP 20.000GHz *RBW 1.0MHz      *VBW 1.0MHz      SWP 200ms</p>			

## Conducted Out Of Band Emissions (Continued)

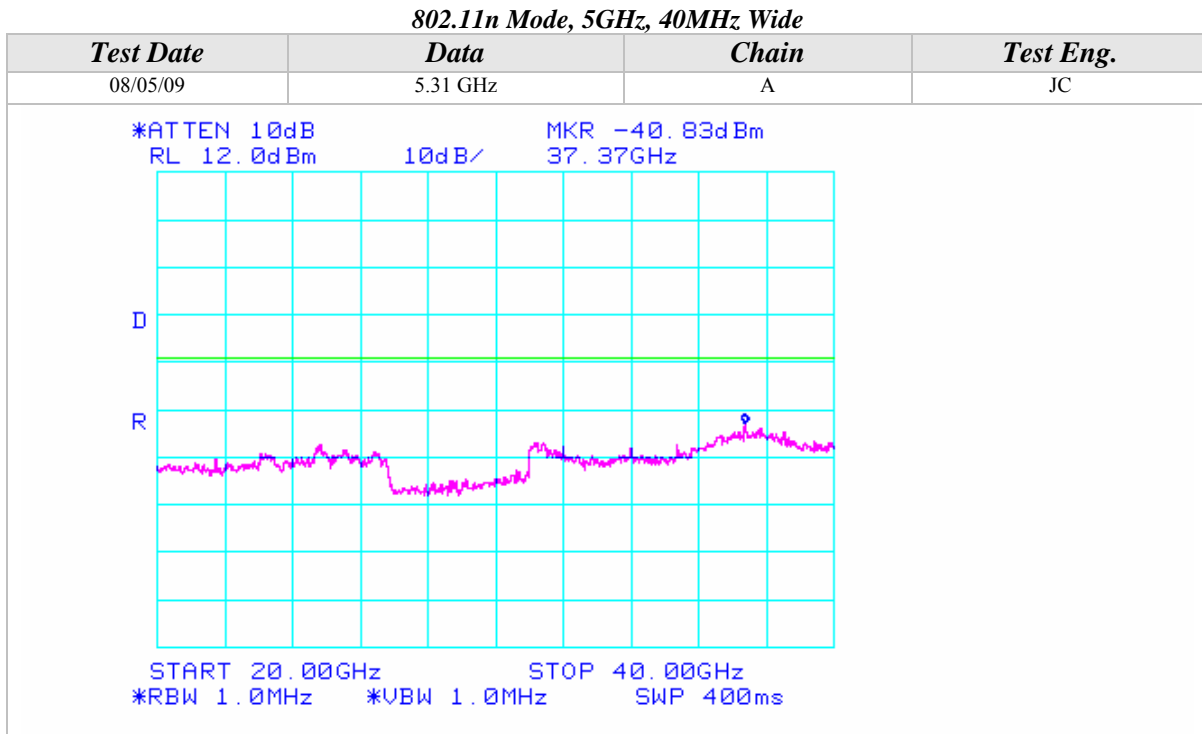



### Conducted Out Of Band Emissions (Continued)

#### 802.11n Mode, 5GHz, 40MHz Wide

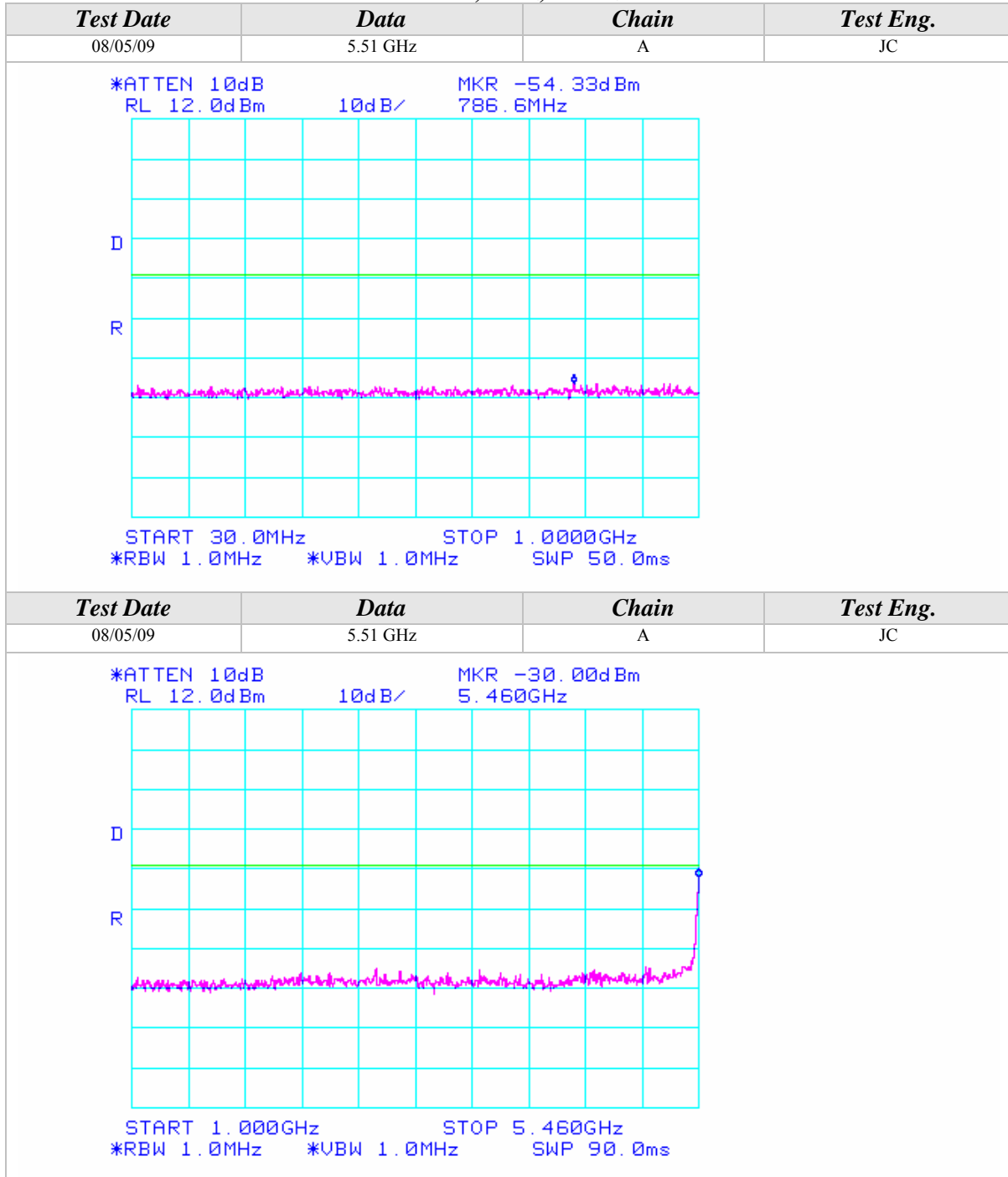



Conducted Out Of Band Emissions (Continued)

802.11n Mode, 5GHz, 40MHz Wide

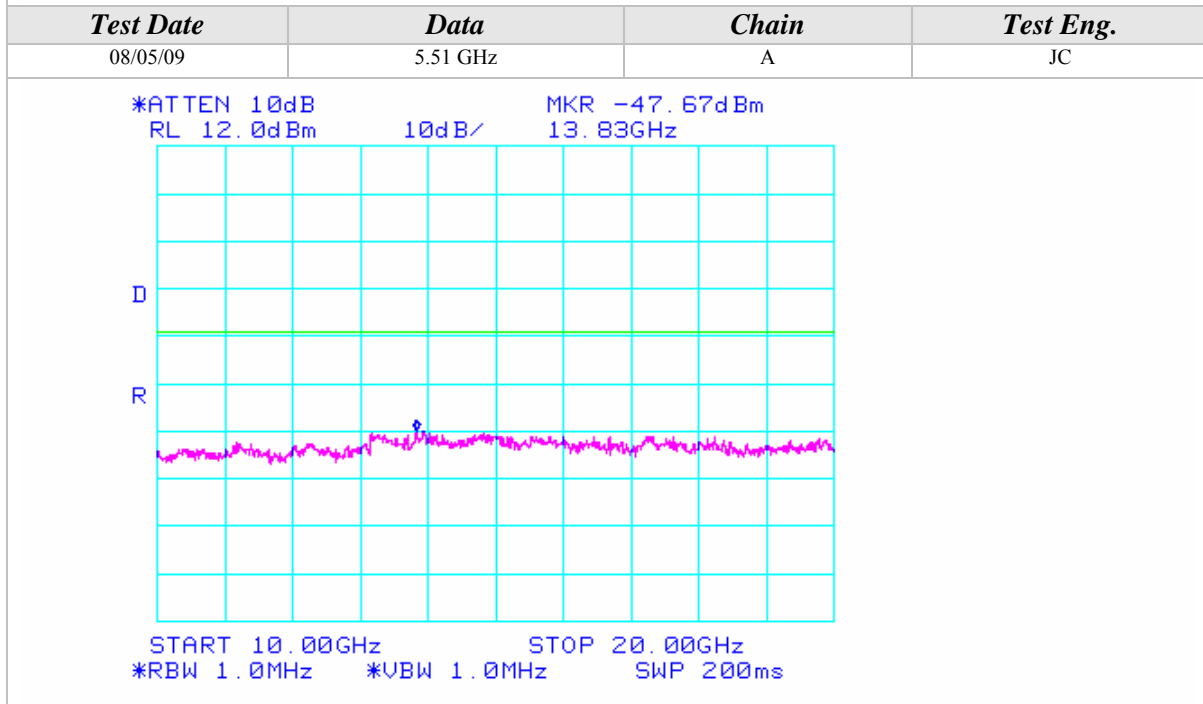
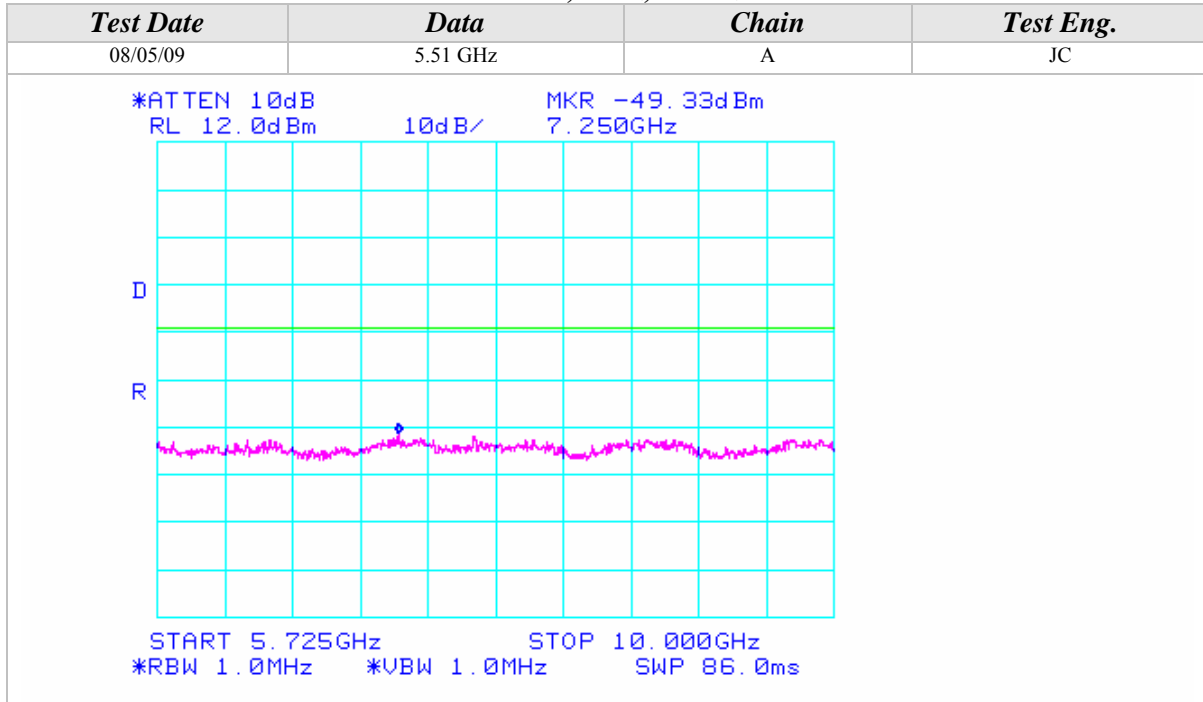

## Conducted Out Of Band Emissions (Continued)

## 802.11n Mode, 5GHz, 40MHz Wide

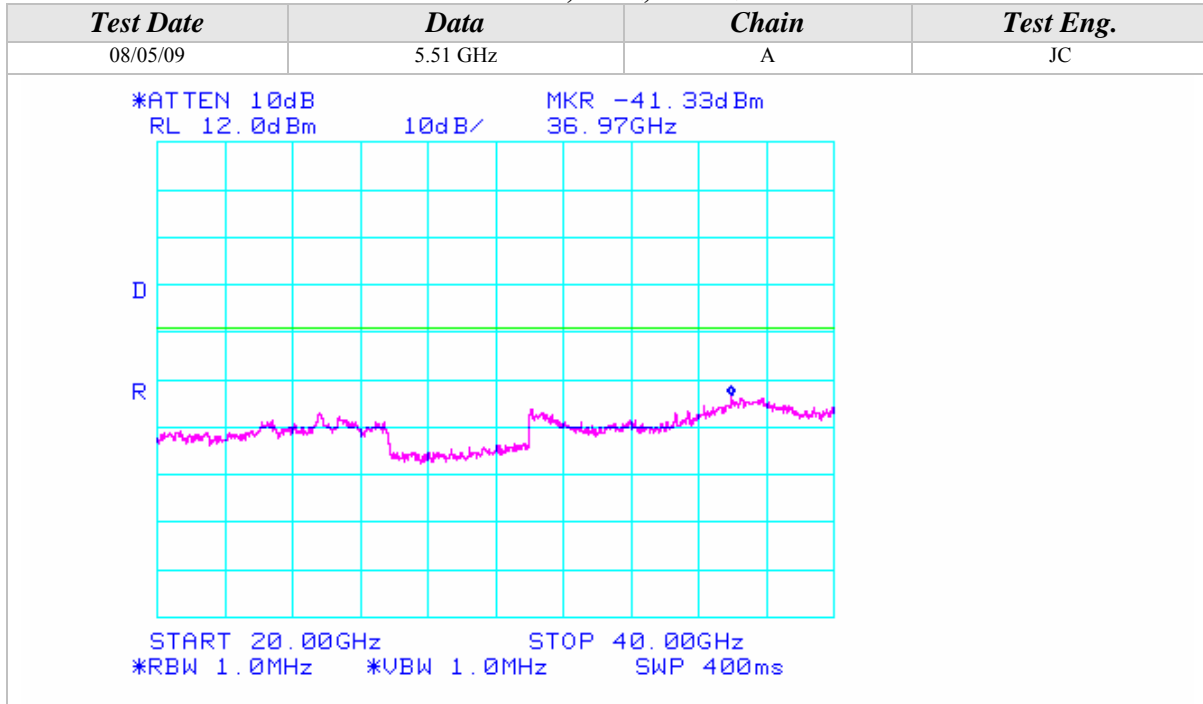



Conducted Out Of Band Emissions (Continued)

*802.11n Mode, 5GHz, 40MHz Wide*

<i>Test Date</i>	<i>Data</i>	<i>Chain</i>	<i>Test Eng.</i>
08/05/09	5.59 GHz	A	JC

\*ATTEN 10dB      MKR -54.33dBm  
RL 12.0dB      10dB/      55.9MHz

START 30.0MHz      STOP 1.0000GHz  
\*RBW 1.0MHz      \*VBW 1.0MHz      SWP 50.0ms

<i>Test Date</i>	<i>Data</i>	<i>Chain</i>	<i>Test Eng.</i>
08/05/09	5.59 GHz	A	JC

\*ATTEN 10dB      MKR -49.33dBm  
RL 12.0dB      10dB/      5.378GHz

START 1.000GHz      STOP 5.460GHz  
\*RBW 1.0MHz      \*VBW 1.0MHz      SWP 90.0ms



Conducted Out Of Band Emissions (Continued)

802.11n Mode, 5GHz, 40MHz Wide

Test Date	Data	Chain	Test Eng.
08/05/09	5.59 GHz	A	JC
<p>*ATTEN 10dB                      MKR -49.33dBm RL 12.0dBm                      10dB/                      7.350GHz</p> <p>START 5.725GHz                      STOP 10.000GHz *RBW 1.0MHz                      *VBW 1.0MHz                      SWP 86.0ms</p>			
Test Date	Data	Chain	Test Eng.
08/05/09	5.59 GHz	A	JC
<p>*ATTEN 10dB                      MKR -47.33dBm RL 12.0dBm                      10dB/                      14.95GHz</p> <p>START 10.000GHz                      STOP 20.000GHz *RBW 1.0MHz                      *VBW 1.0MHz                      SWP 200ms</p>			



## Conducted Out Of Band Emissions (Continued)

## 802.11n Mode, 5GHz, 40MHz Wide

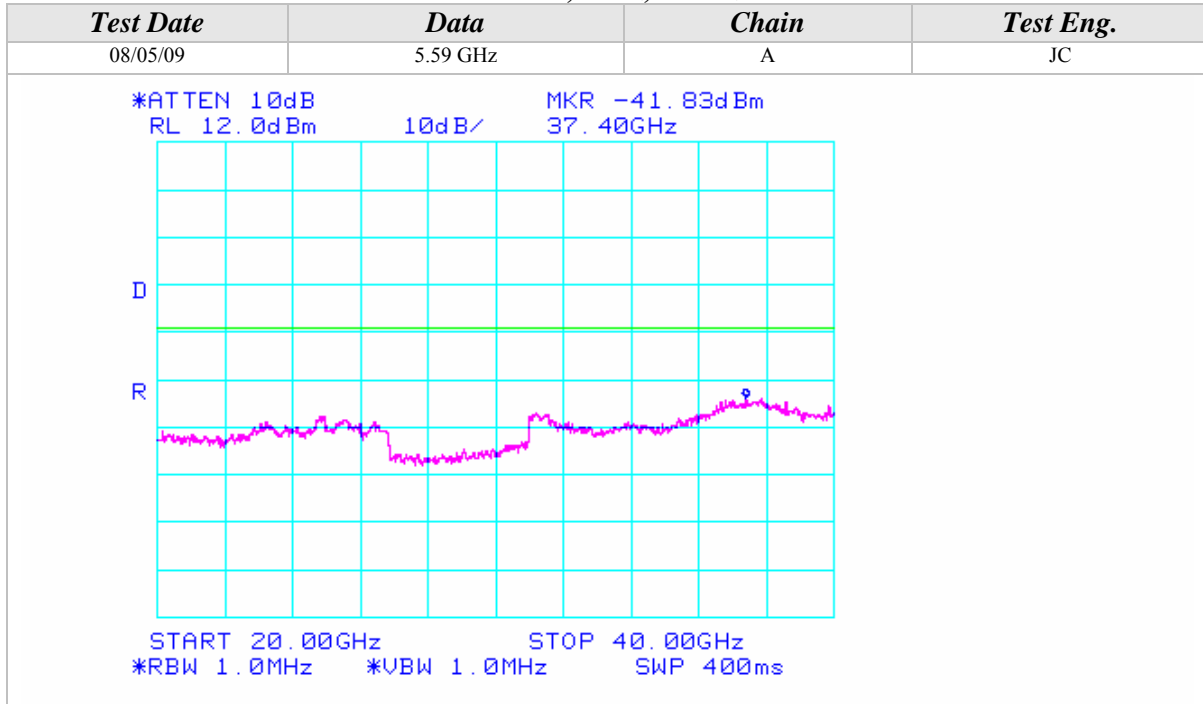



Conducted Out Of Band Emissions (Continued)

**802.11n Mode, 5GHz, 40MHz Wide**

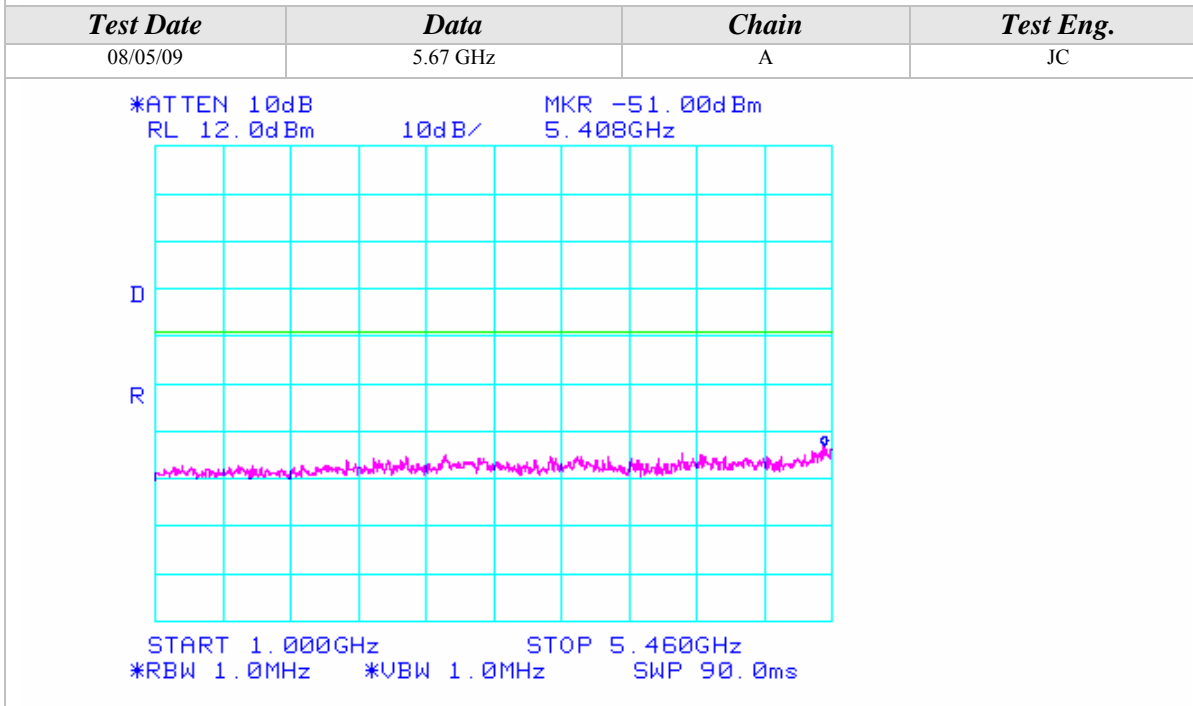
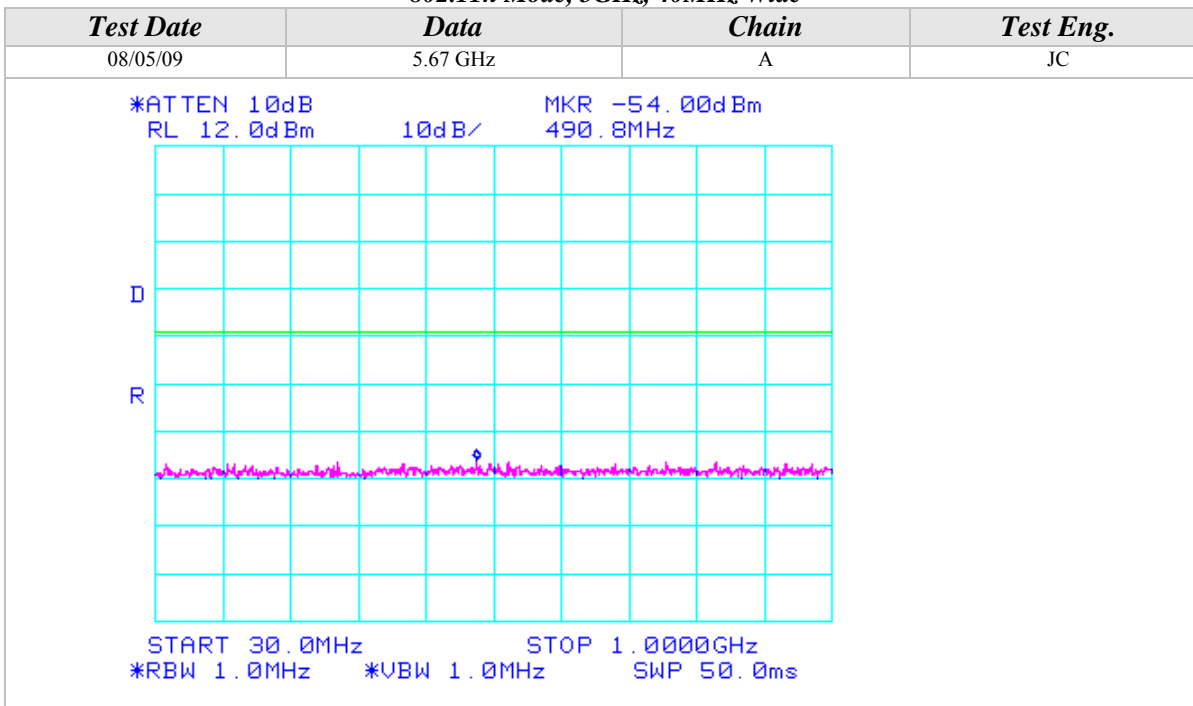

### Conducted Out Of Band Emissions (Continued)

#### 802.11n Mode, 5GHz, 40MHz Wide

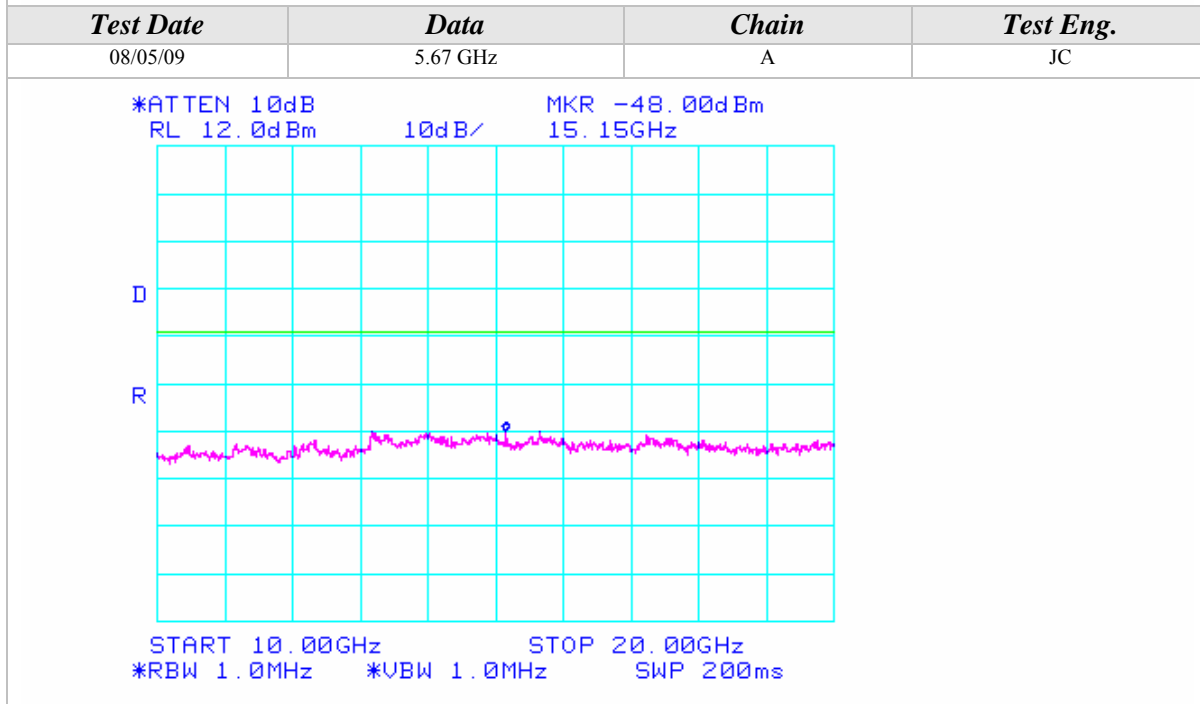
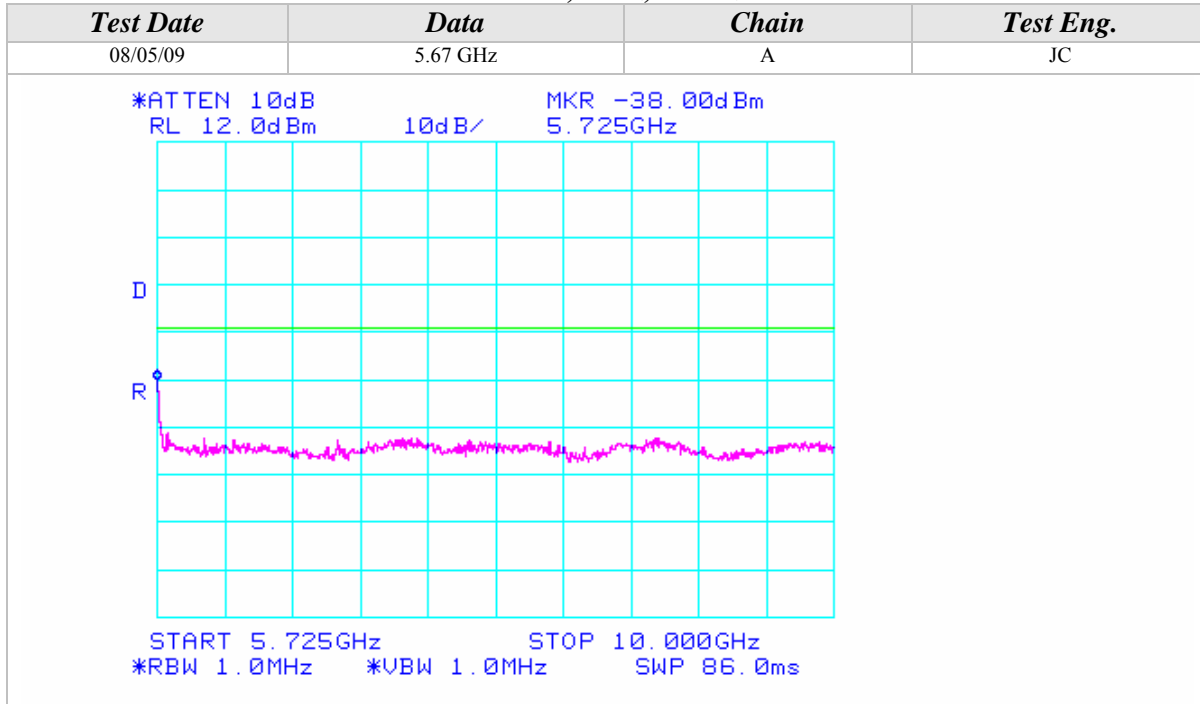



### Conducted Out Of Band Emissions (Continued)

#### 802.11n Mode, 5GHz, 40MHz Wide

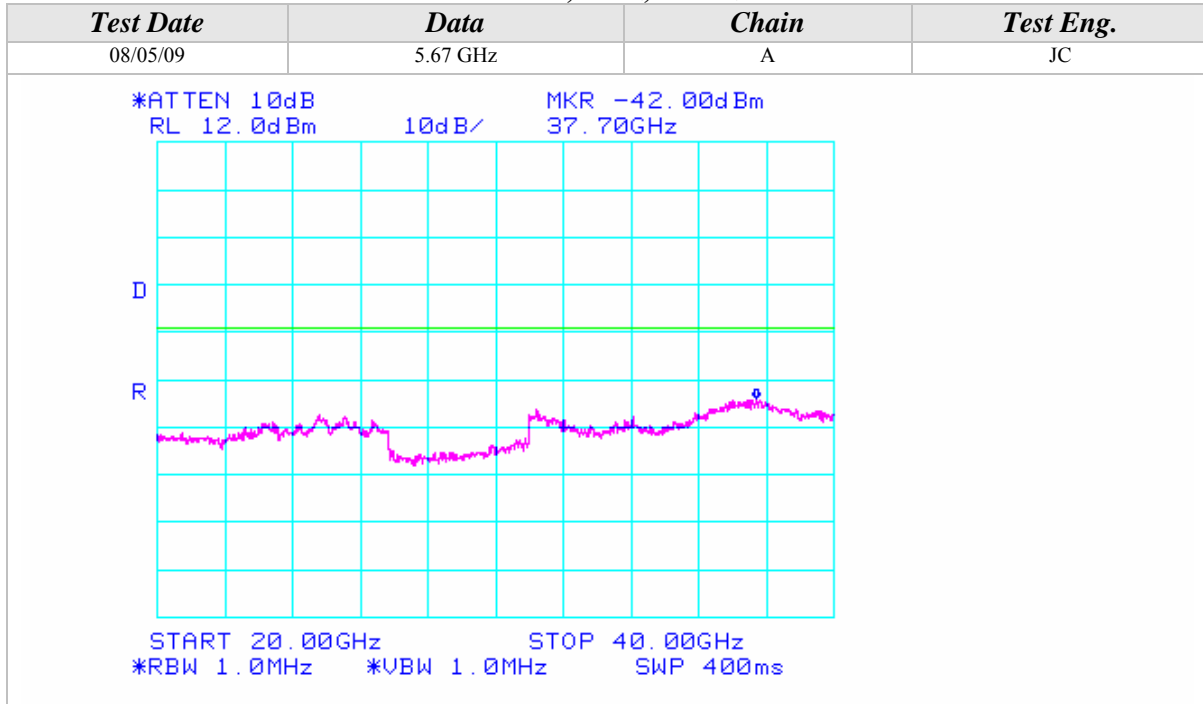



Conducted Out Of Band Emissions (Continued)

802.11a Mode

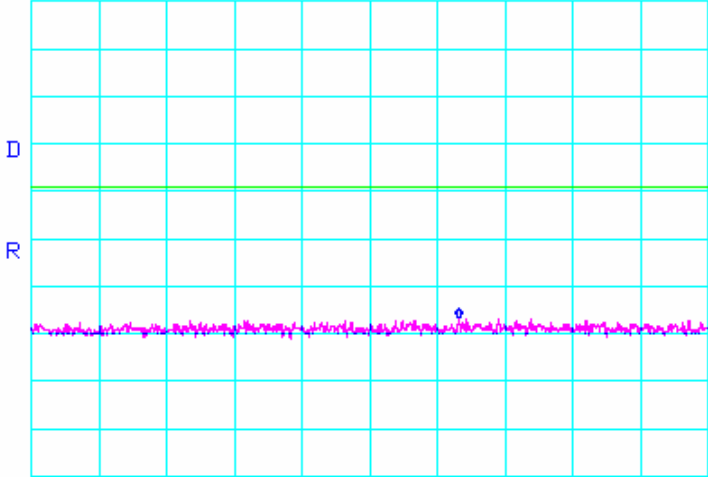
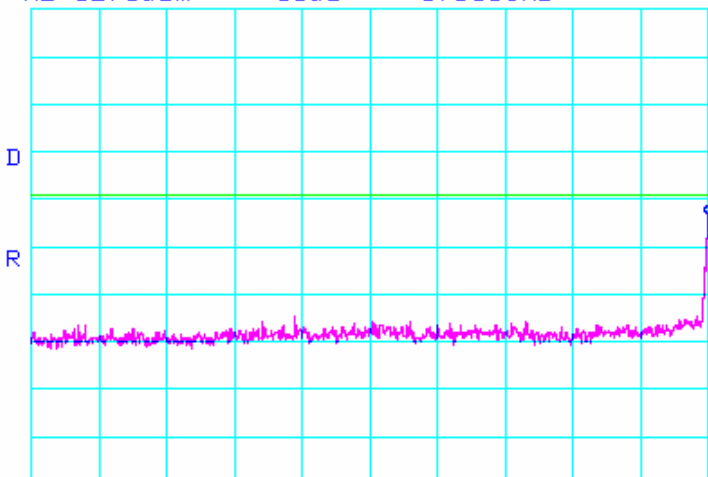
Test Date	Data	Chain	Test Eng.
08/05/09	5.18 GHz	B	JC
<p>*ATTEN 10dB    MKR -54.67dBm  RL 12.0dBm    10dB/    642.7MHz</p>  <p>START 30.0MHz    STOP 1.0000GHz  *RBW 1.0MHz    *VBW 1.0MHz    SWP 50.0ms</p>			
Test Date	Data	Chain	Test Eng.
08/05/09	5.18 GHz	B	JC
<p>*ATTEN 10dB    MKR -31.17dBm  RL 12.0dBm    10dB/    5.150GHz</p>  <p>START 1.000GHz    STOP 5.150GHz  *RBW 1.0MHz    *VBW 1.0MHz    SWP 83.0ms</p>			



Conducted Out Of Band Emissions (Continued)

802.11a Mode

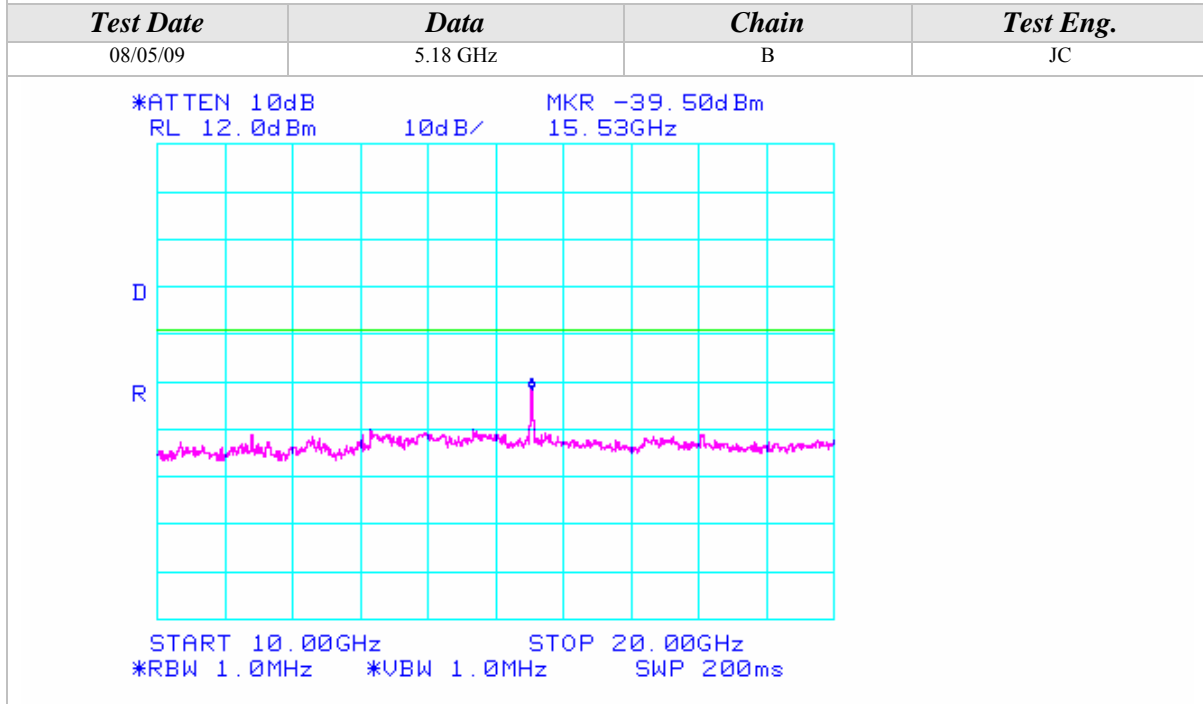
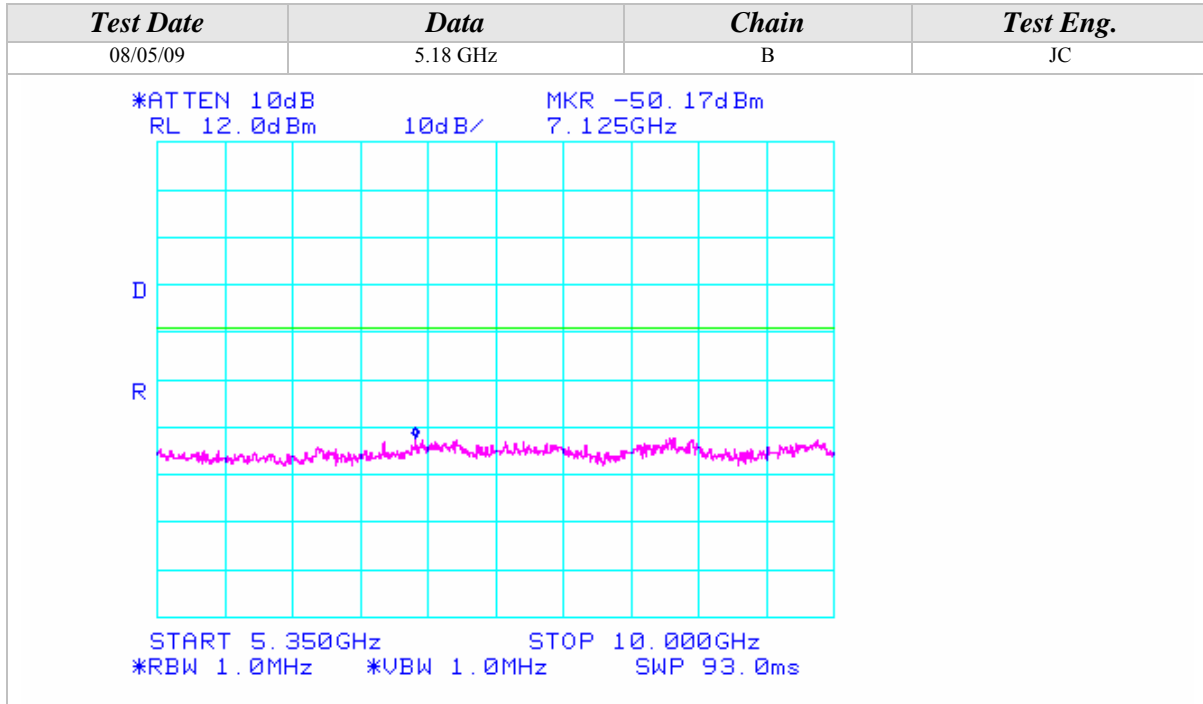



### Conducted Out Of Band Emissions (Continued)

#### 802.11a Mode

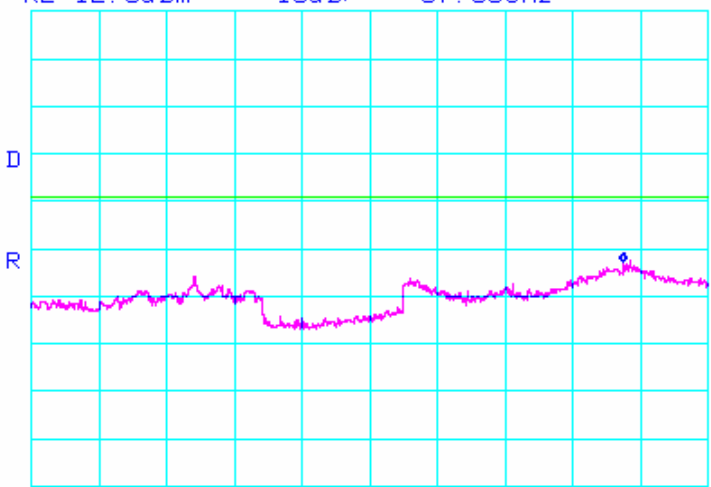
<i>Test Date</i>	<i>Data</i>	<i>Chain</i>	<i>Test Eng.</i>
08/05/09	5.18 GHz	B	JC
<pre> *ATTEN 10dB      MKR -40.83dBm RL 12.0dBm      10dB/ 37.50GHz           </pre>  <pre> START 20.00GHz      STOP 40.00GHz *RBW 1.0MHz      *VBW 1.0MHz      SWP 400ms           </pre>			



Conducted Out Of Band Emissions (Continued)

802.11a Mode

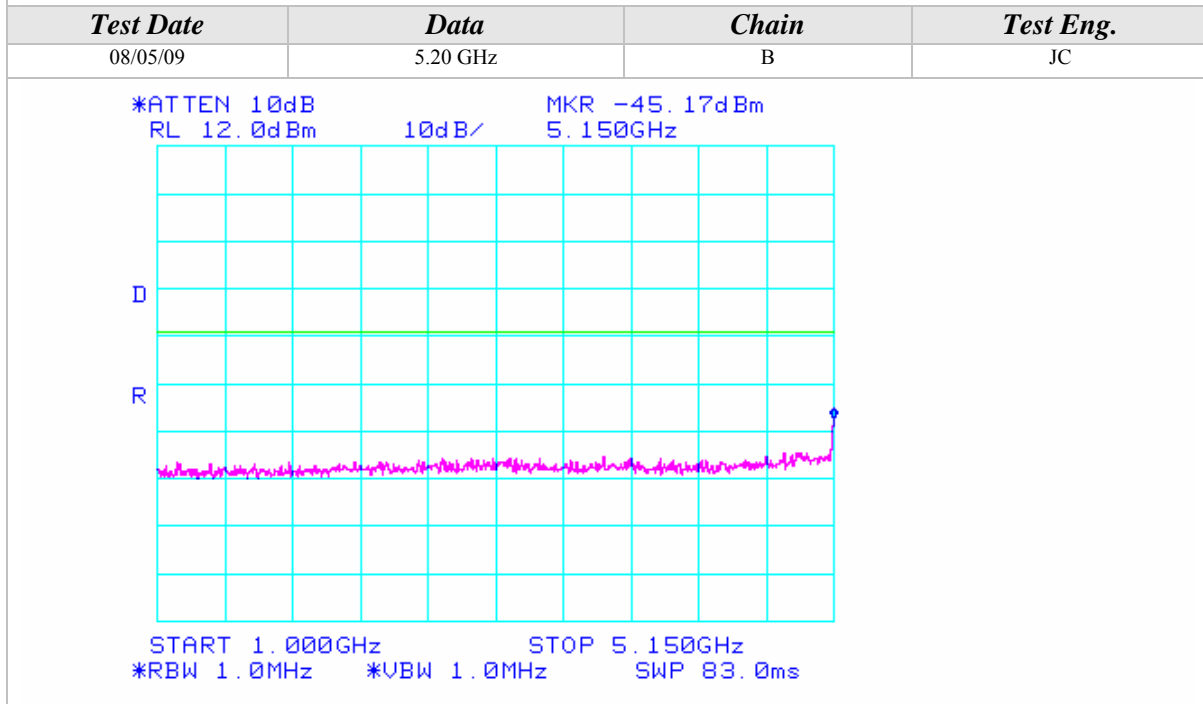
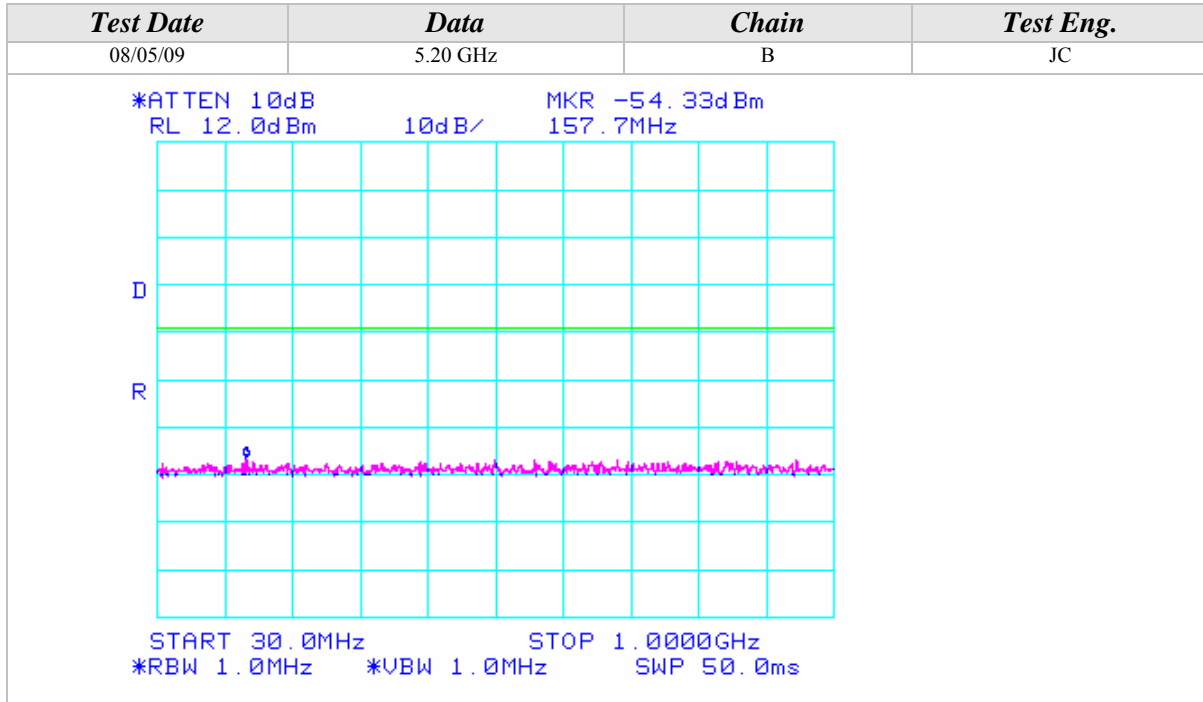





### Conducted Out Of Band Emissions (Continued)

#### 802.11a Mode

Test Date	Data	Chain	Test Eng.
08/05/09	5.20 GHz	B	JC
<p>*ATTEN 10dB    MKR -50.33dBm RL 12.0dBm    10dB/    7.233GHz</p> <p>START 5.350GHz    STOP 10.000GHz *RBW 1.0MHz    *VBW 1.0MHz    SWP 93.0ms</p>			
Test Date	Data	Chain	Test Eng.
08/05/09	5.20 GHz	B	JC
<p>*ATTEN 10dB    MKR -38.67dBm RL 12.0dBm    10dB/    15.58GHz</p> <p>START 10.000GHz    STOP 20.000GHz *RBW 1.0MHz    *VBW 1.0MHz    SWP 200ms</p>			

## Conducted Out Of Band Emissions (Continued)

## 802.11a Mode

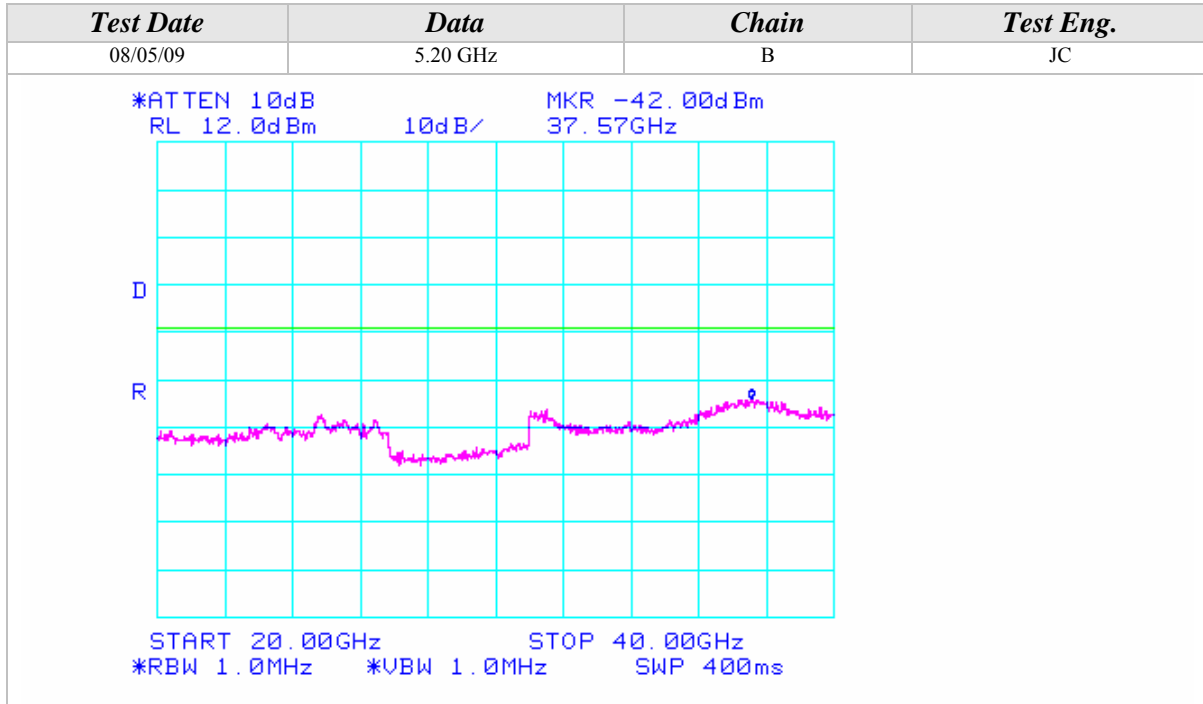



### Conducted Out Of Band Emissions (Continued)

#### 802.11a Mode

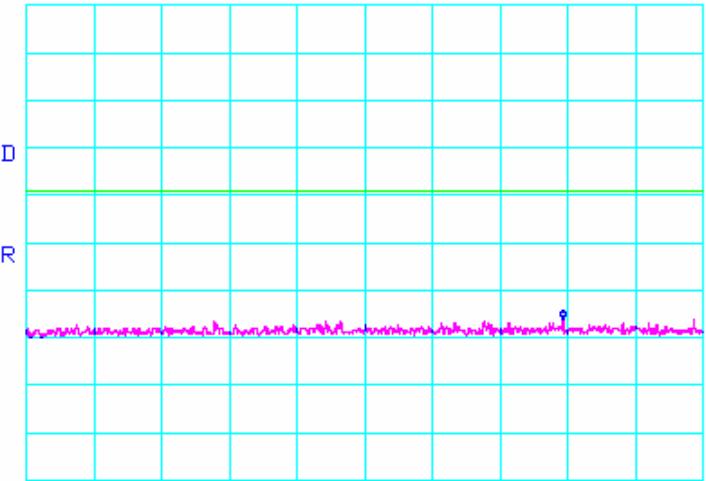
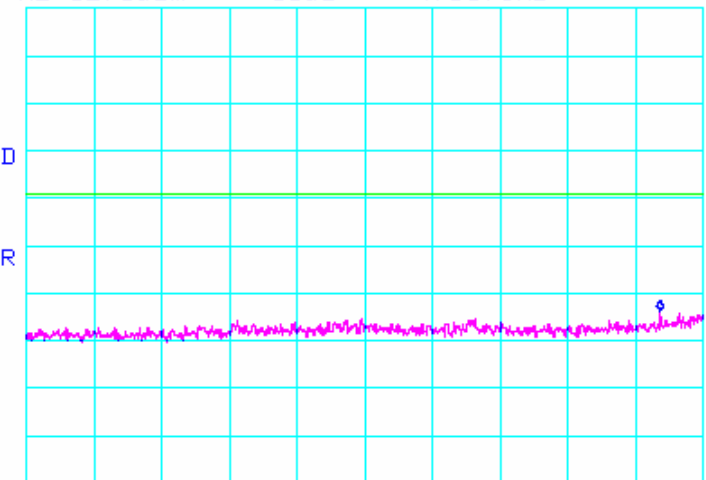
Test Date	Data	Chain	Test Eng.
08/05/09	5.24 GHz	B	JC
<p>*ATTEN 10dB                      MKR -54.17dBm RL 12.0dBm                      10dB/                      799.5MHz</p>  <p>START 30.0MHz                      STOP 1.0000GHz *RBW 1.0MHz                      *VBW 1.0MHz                      SWP 50.0ms</p>			
Test Date	Data	Chain	Test Eng.
08/05/09	5.24 GHz	B	JC
<p>*ATTEN 10dB                      MKR -51.67dBm RL 12.0dBm                      10dB/                      4.887GHz</p>  <p>START 1.000GHz                      STOP 5.150GHz *RBW 1.0MHz                      *VBW 1.0MHz                      SWP 83.0ms</p>			



### Conducted Out Of Band Emissions (Continued)

#### 802.11a Mode

Test Date	Data	Chain	Test Eng.
08/05/09	5.24 GHz	B	JC

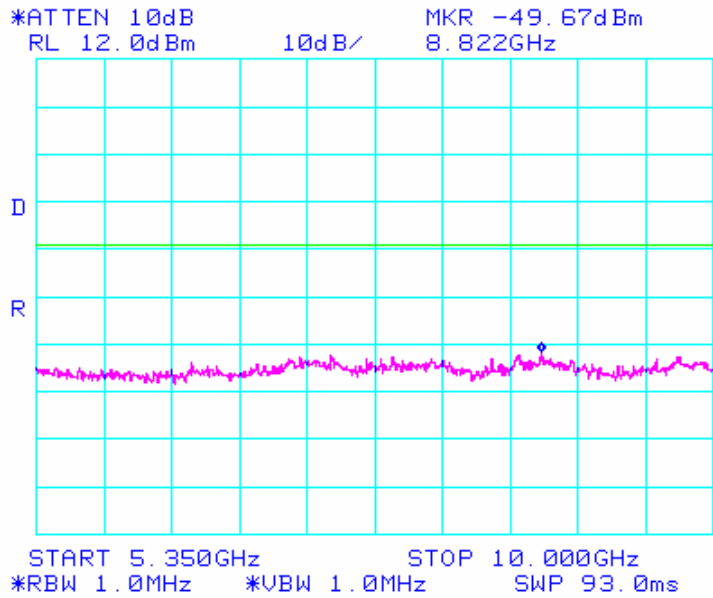

Test Date	Data	Chain	Test Eng.
08/05/09	5.24 GHz	B	JC

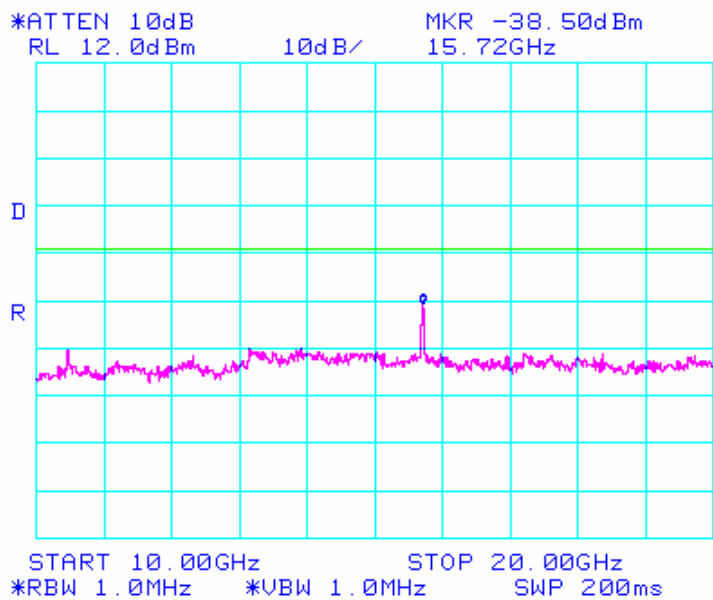



Conducted Out Of Band Emissions (Continued)

802.11a Mode

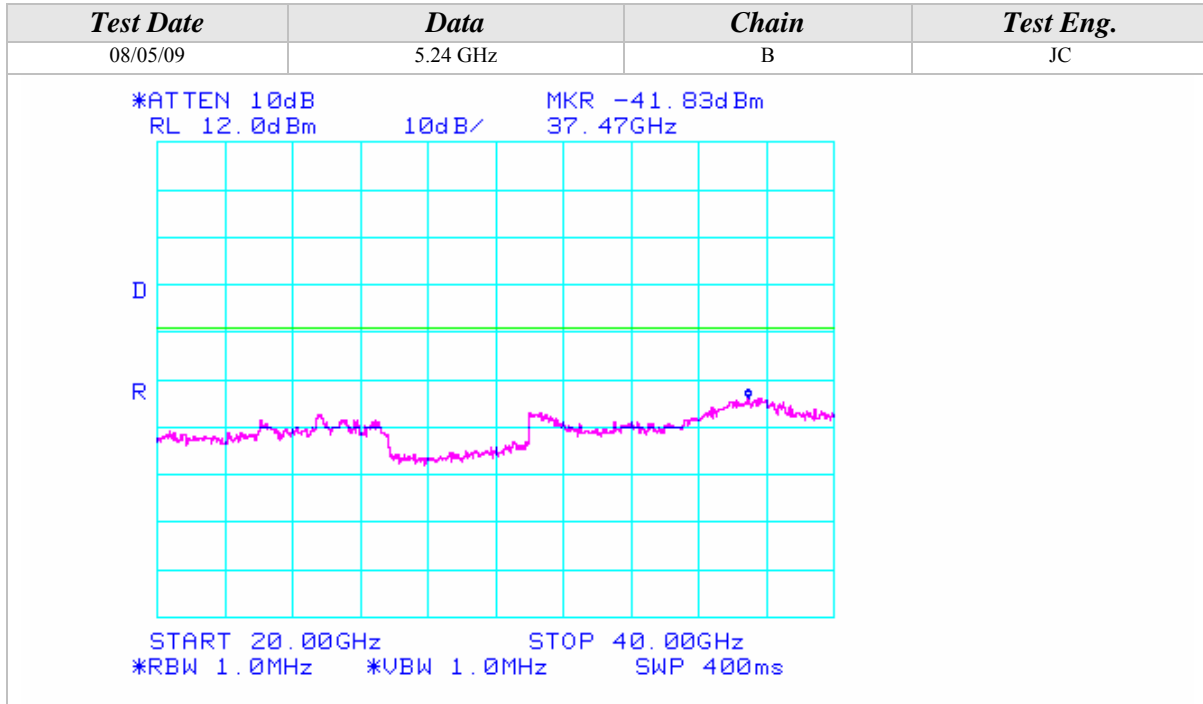



Conducted Out Of Band Emissions (Continued)

802.11a Mode

<i>Test Date</i>	<i>Data</i>	<i>Chain</i>	<i>Test Eng.</i>
08/05/09	5.26 GHz	B	JC
<p>*ATTEN 10dB                      MKR -54.00dBm RL 12.0dBm                      10dB/                      907.9MHz</p> <p>START 30.0MHz                      STOP 1.0000GHz *RBW 1.0MHz                      *VBW 1.0MHz                      SWP 50.0ms</p>			
<i>Test Date</i>	<i>Data</i>	<i>Chain</i>	<i>Test Eng.</i>
08/05/09	5.26 GHz	B	JC
<p>*ATTEN 10dB                      MKR -53.17dBm RL 12.0dBm                      10dB/                      5.053GHz</p> <p>START 1.000GHz                      STOP 5.150GHz *RBW 1.0MHz                      *VBW 1.0MHz                      SWP 83.0ms</p>			



Conducted Out Of Band Emissions (Continued)

802.11a Mode

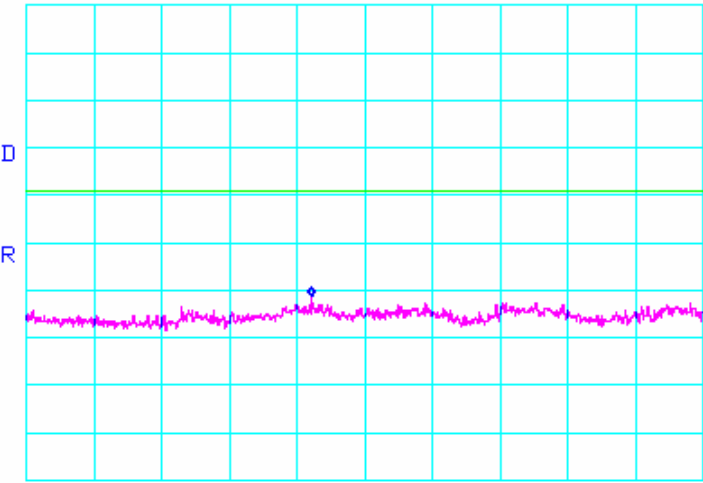
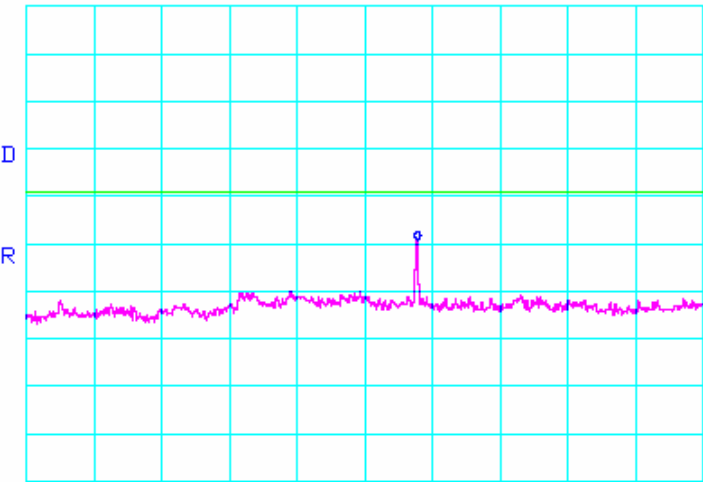
<i>Test Date</i>	<i>Data</i>	<i>Chain</i>	<i>Test Eng.</i>
08/05/09	5.26 GHz	B	JC
<p>*ATTEN 10dB RL 12.0dBm      10dB/      MKR -49.33dBm 7.311GHz</p>  <p>D</p> <p>R</p> <p>START 5.350GHz      STOP 10.000GHz *RBW 1.0MHz      *VBW 1.0MHz      SWP 93.0ms</p>			
<i>Test Date</i>	<i>Data</i>	<i>Chain</i>	<i>Test Eng.</i>
08/05/09	5.26 GHz	B	JC
<p>*ATTEN 10dB RL 12.0dBm      10dB/      MKR -37.33dBm 15.78GHz</p>  <p>D</p> <p>R</p> <p>START 10.000GHz      STOP 20.000GHz *RBW 1.0MHz      *VBW 1.0MHz      SWP 200ms</p>			

### Conducted Out Of Band Emissions (Continued)

#### 802.11a Mode

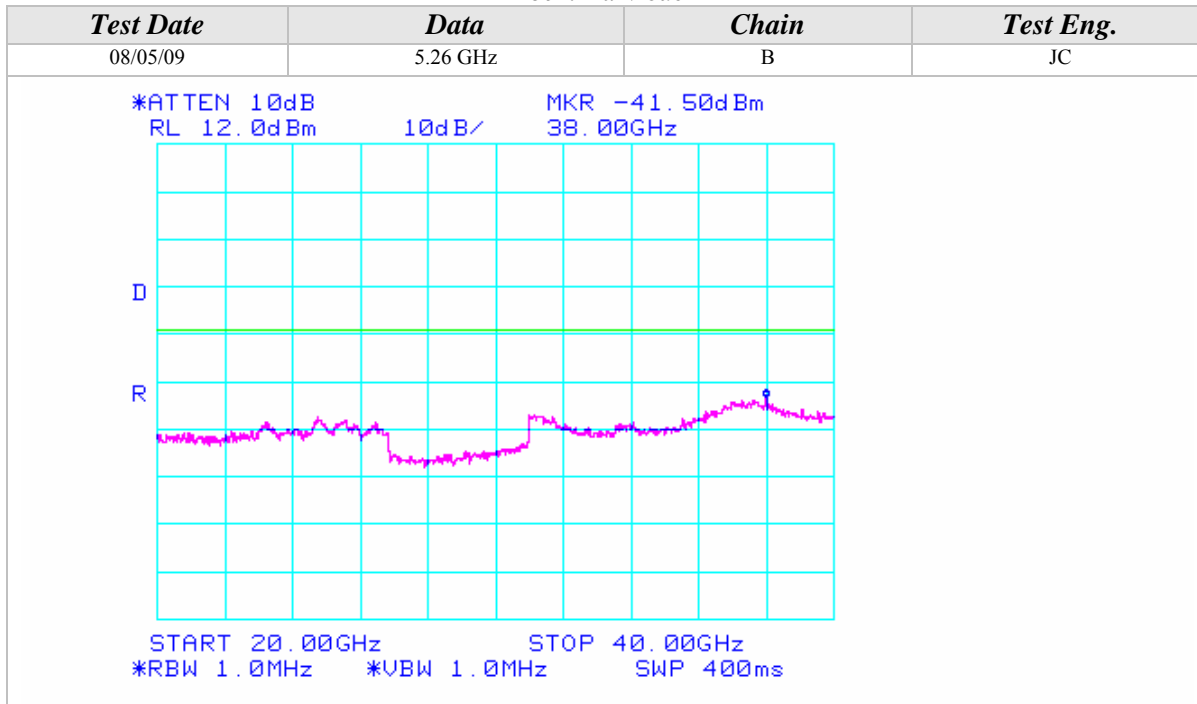





Conducted Out Of Band Emissions (Continued)

802.11a Mode

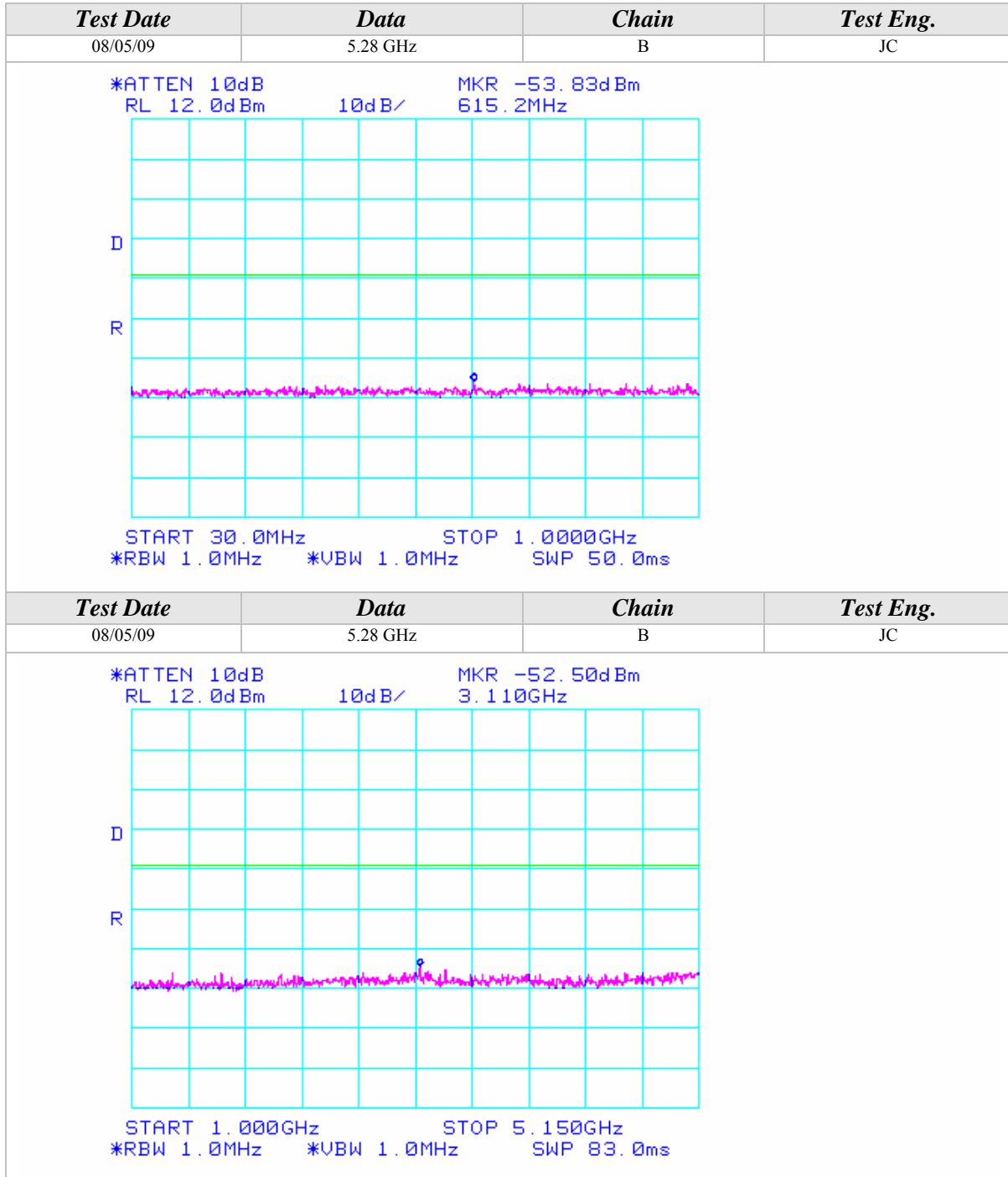



Conducted Out Of Band Emissions (Continued)

802.11a Mode

<i>Test Date</i>	<i>Data</i>	<i>Chain</i>	<i>Test Eng.</i>
08/05/09	5.28 GHz	B	JC
<p>*ATTEN 10dB      MKR -49.17dBm            RL 12.0dBm      10dB/      7.350GHz</p> <p>START 5.350GHz      STOP 10.000GHz            *RBW 1.0MHz      *VBW 1.0MHz      SWP 93.0ms</p>			
<i>Test Date</i>	<i>Data</i>	<i>Chain</i>	<i>Test Eng.</i>
08/05/09	5.28 GHz	B	JC
<p>*ATTEN 10dB      MKR -37.50dBm            RL 12.0dBm      10dB/      15.83GHz</p> <p>START 10.000GHz      STOP 20.000GHz            *RBW 1.0MHz      *VBW 1.0MHz      SWP 200ms</p>			

Conducted Out Of Band Emissions (Continued)

802.11a Mode

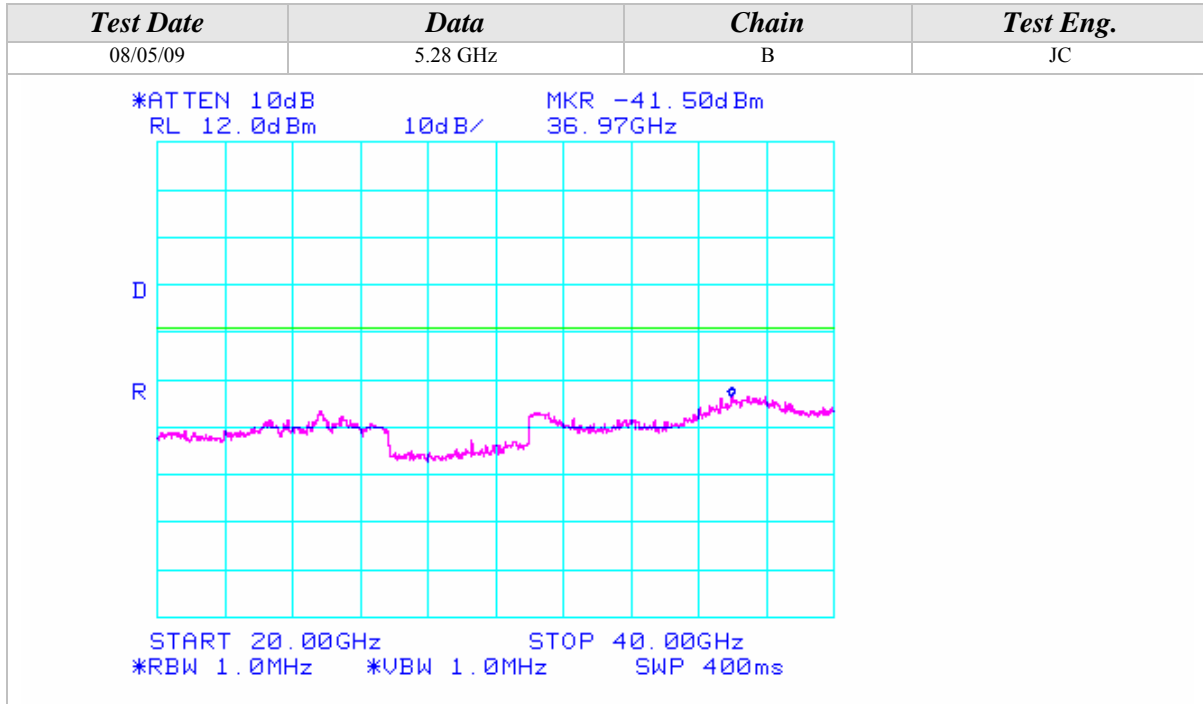



Conducted Out Of Band Emissions (Continued)

802.11a Mode

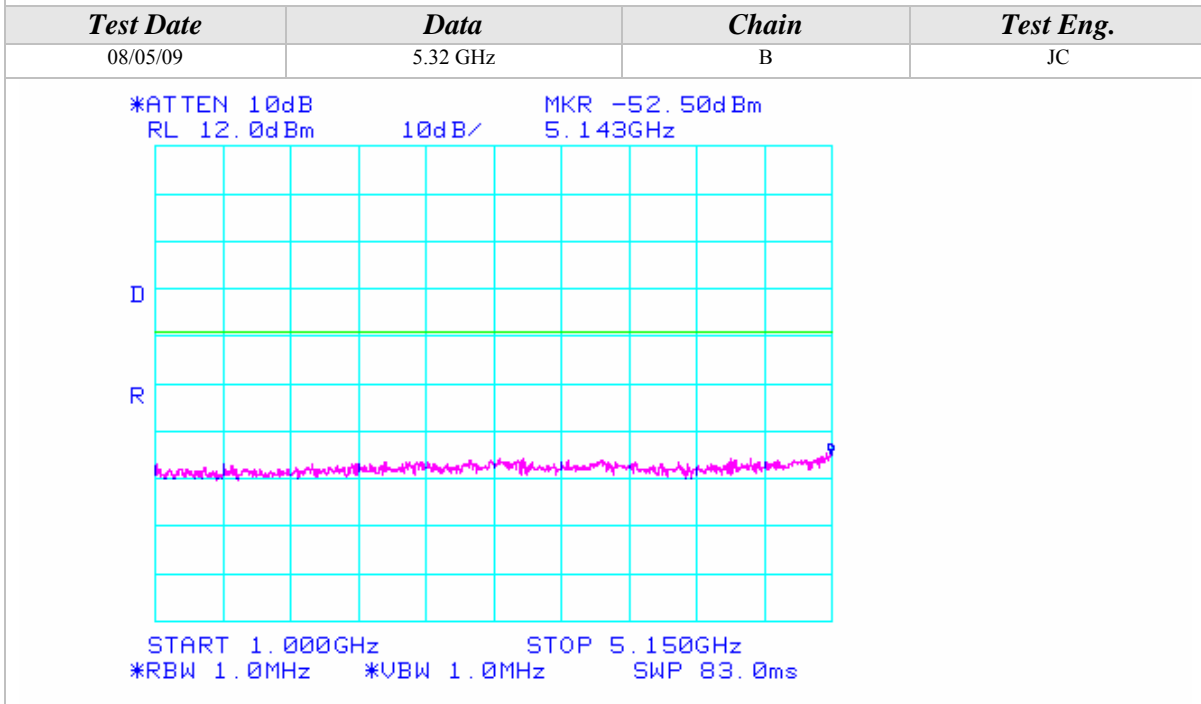
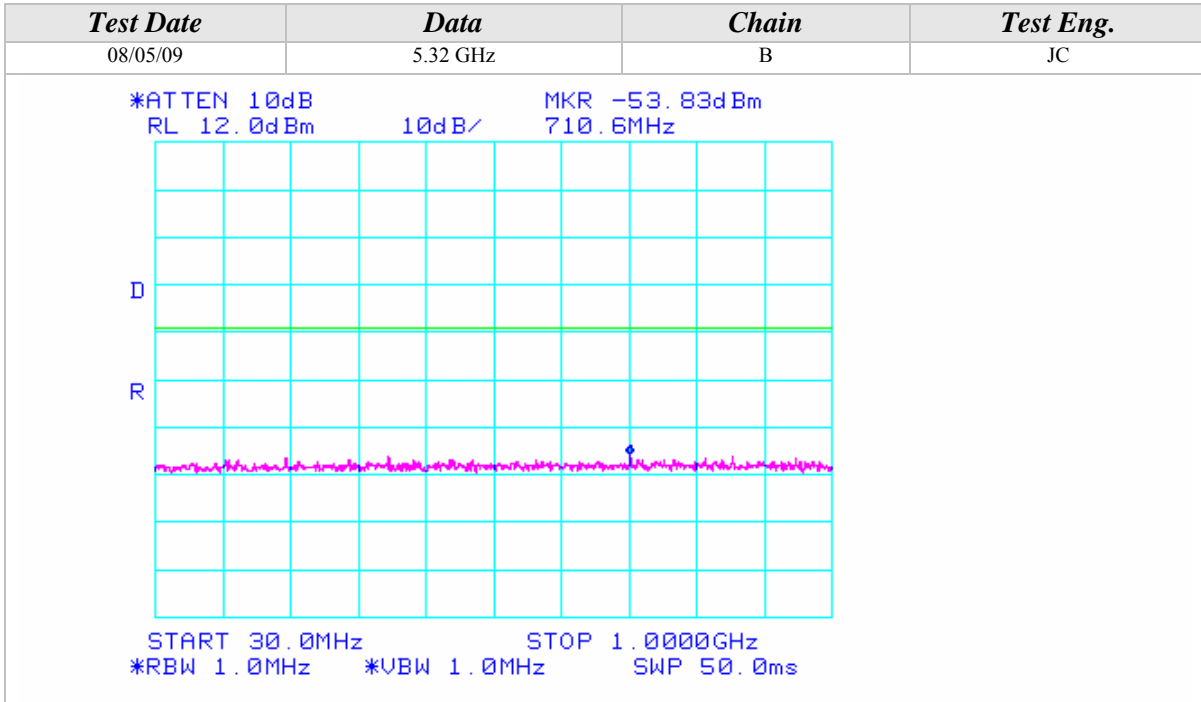

### Conducted Out Of Band Emissions (Continued)

#### 802.11a Mode

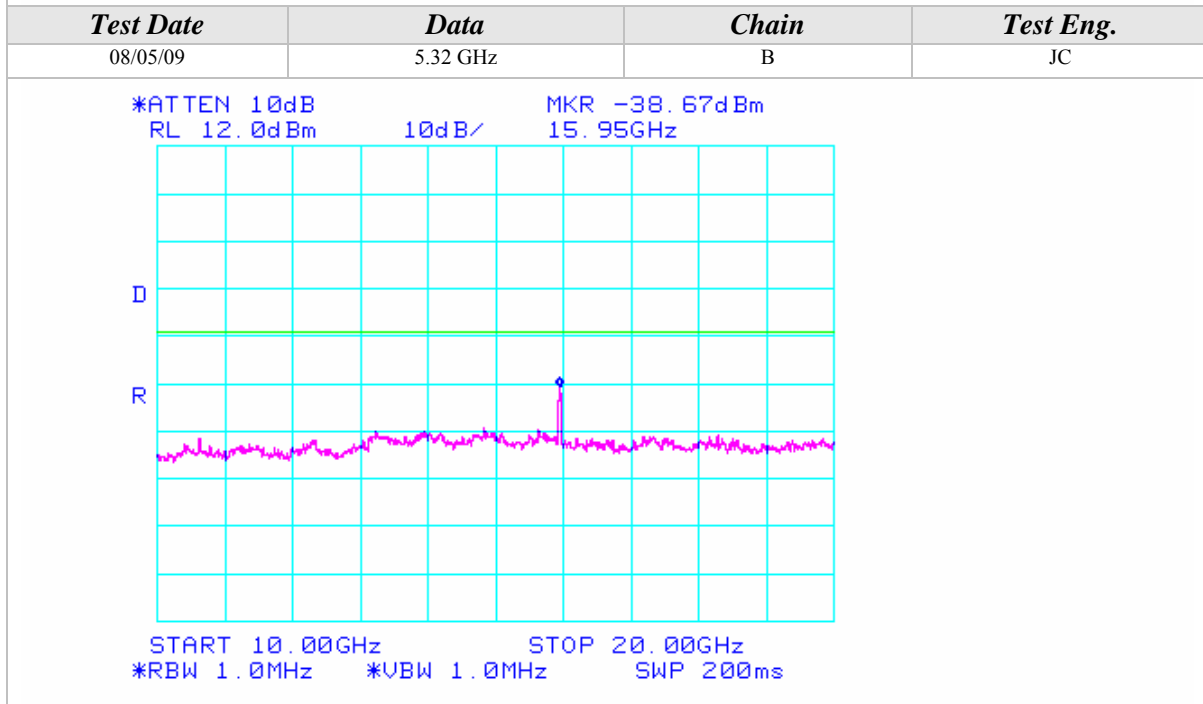
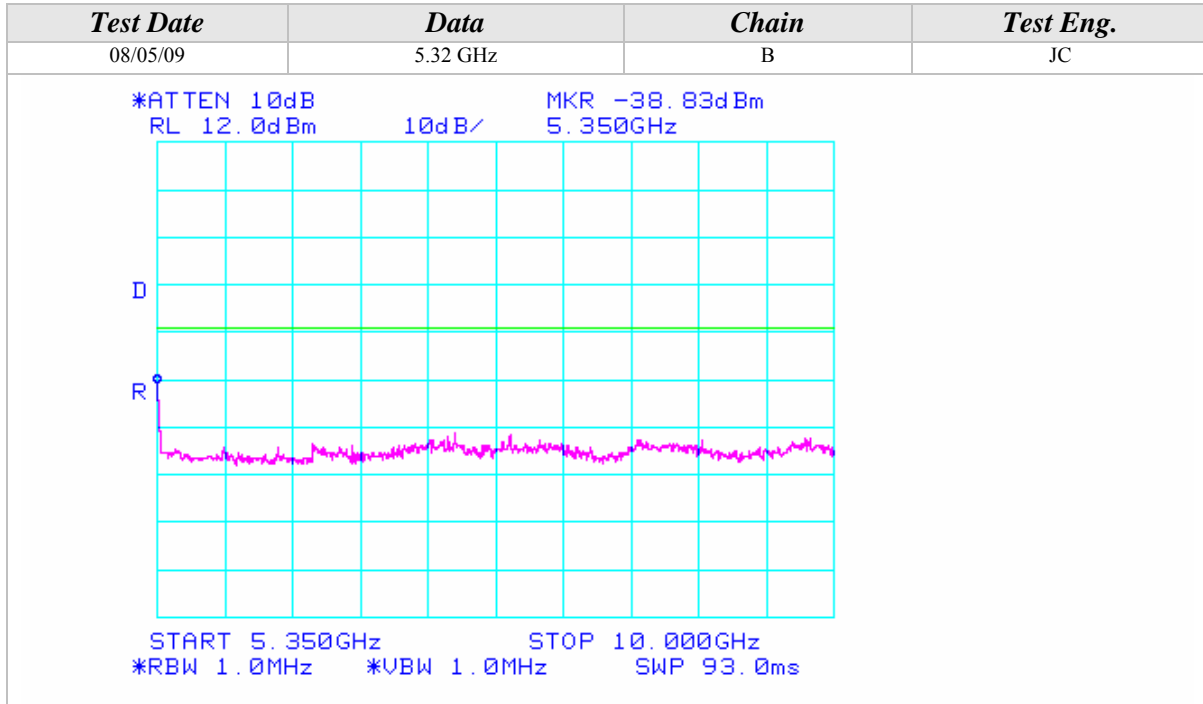



Conducted Out Of Band Emissions (Continued)

802.11a Mode

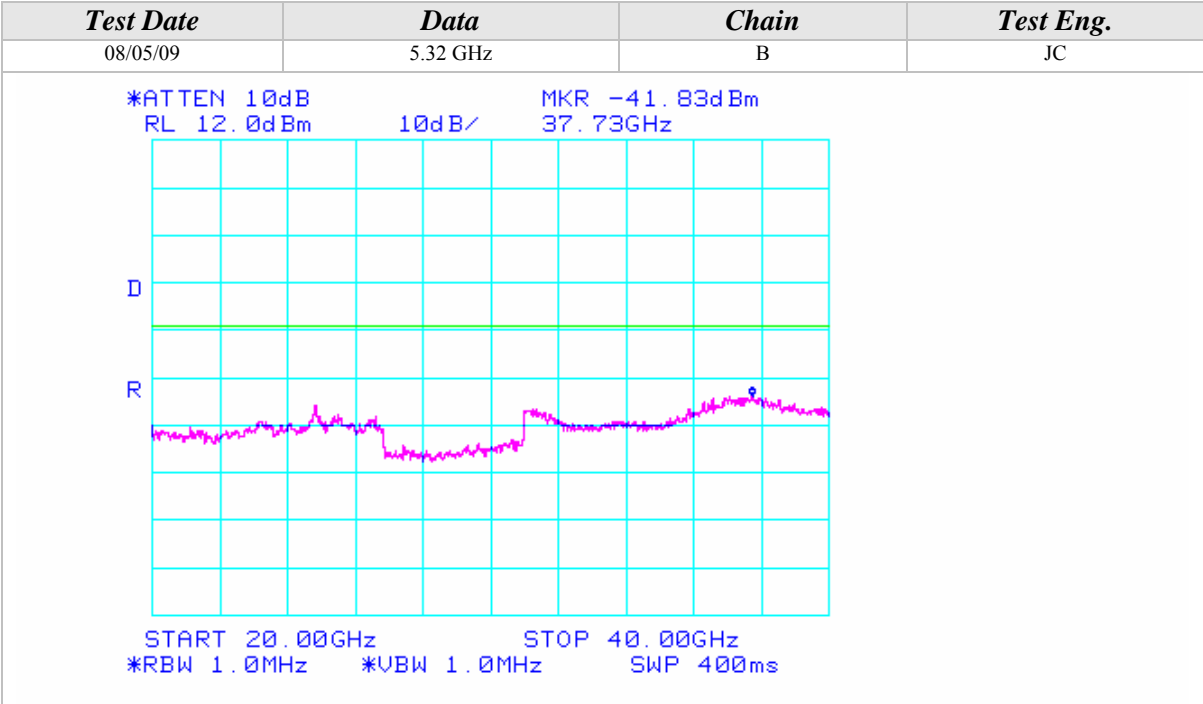

Conducted Out Of Band Emissions (Continued)

802.11a Mode

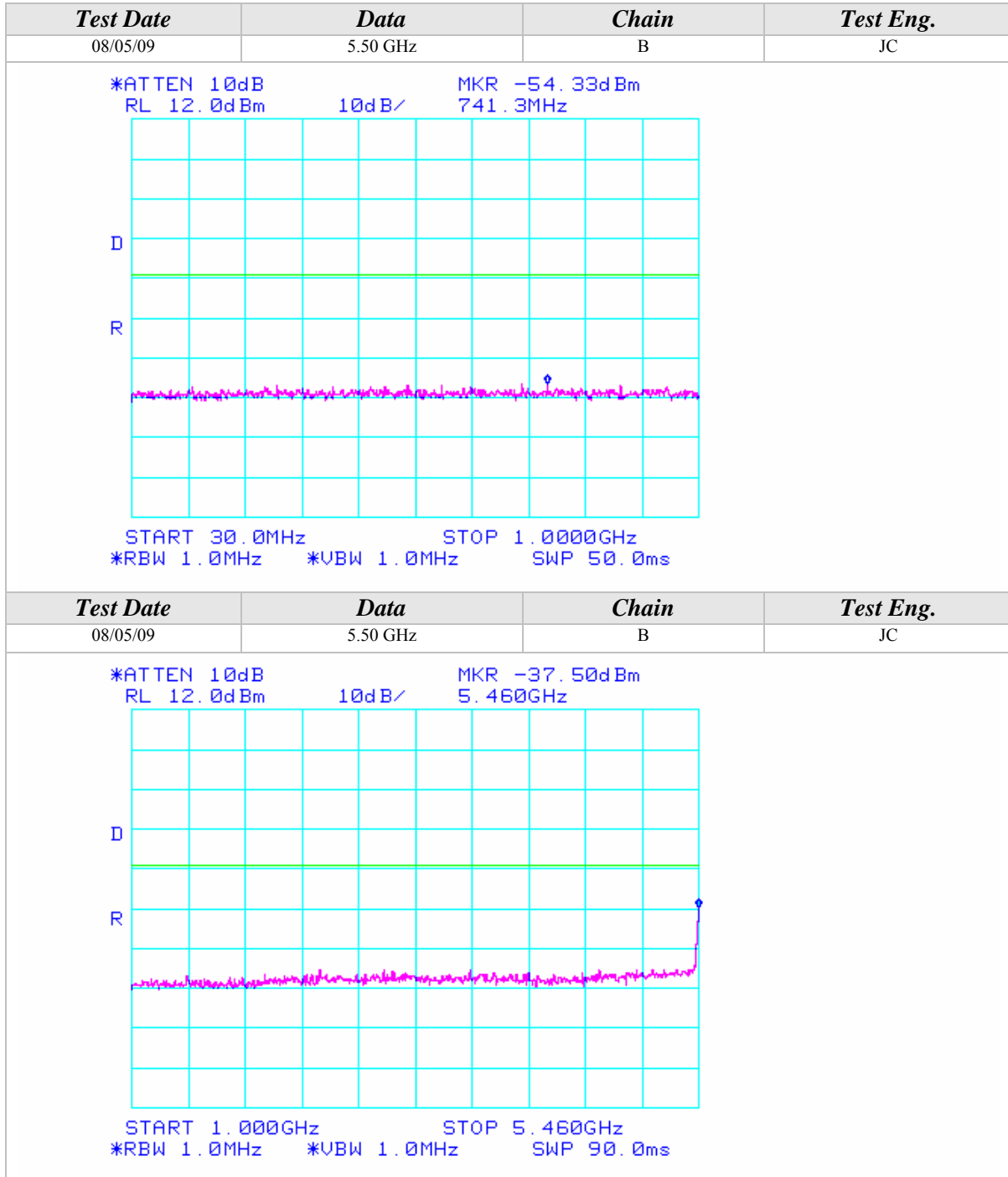

## Conducted Out Of Band Emissions (Continued)

## 802.11a Mode

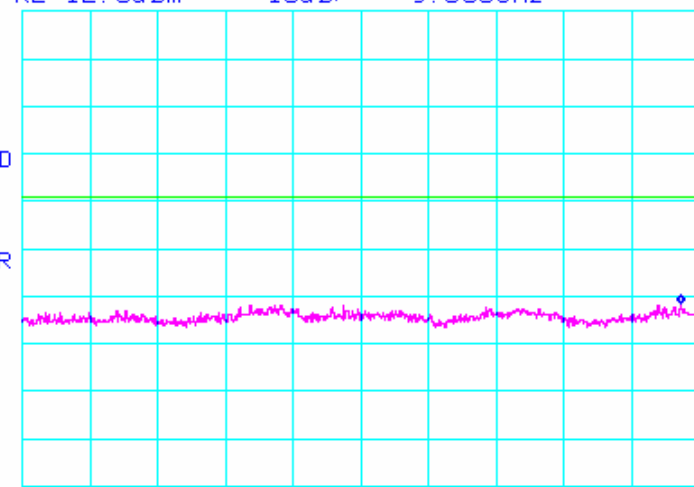
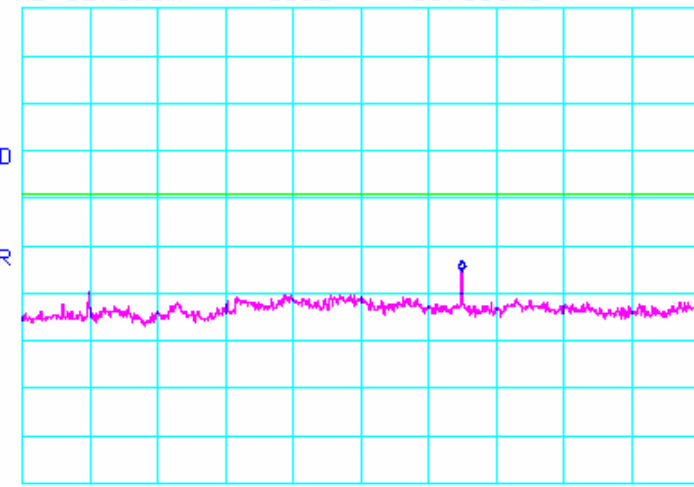
Test Date	Data	Chain	Test Eng.
08/05/09	5.50 GHz	B	JC
<p>*ATTEN 10dB                      MKR -49.67dBm RL 12.0dBm                      10dB/                      9.886GHz</p>  <p>START 5.725GHz                      STOP 10.000GHz *RBW 1.0MHz                      *VBW 1.0MHz                      SWP 86.0ms</p>			
Test Date	Data	Chain	Test Eng.
08/05/09	5.50 GHz	B	JC
<p>*ATTEN 10dB                      MKR -43.33dBm RL 12.0dBm                      10dB/                      16.50GHz</p>  <p>START 10.00GHz                      STOP 20.00GHz *RBW 1.0MHz                      *VBW 1.0MHz                      SWP 200ms</p>			



Conducted Out Of Band Emissions (Continued)

802.11a Mode

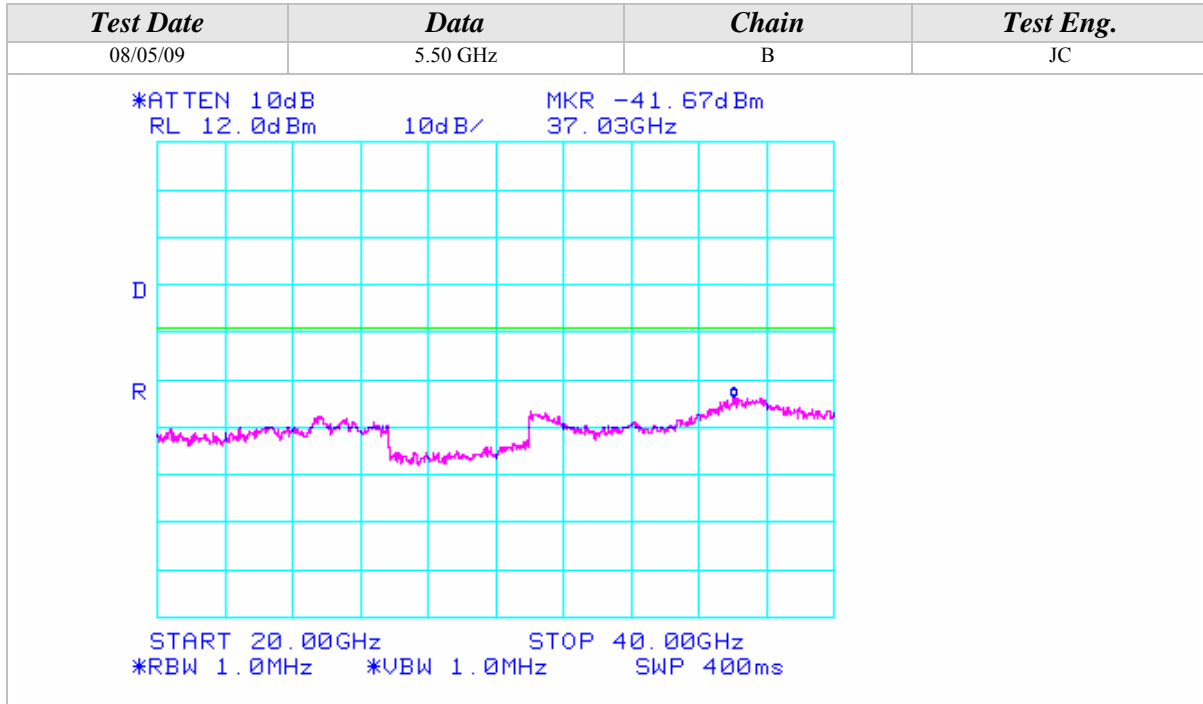





Conducted Out Of Band Emissions (Continued)

802.11a Mode

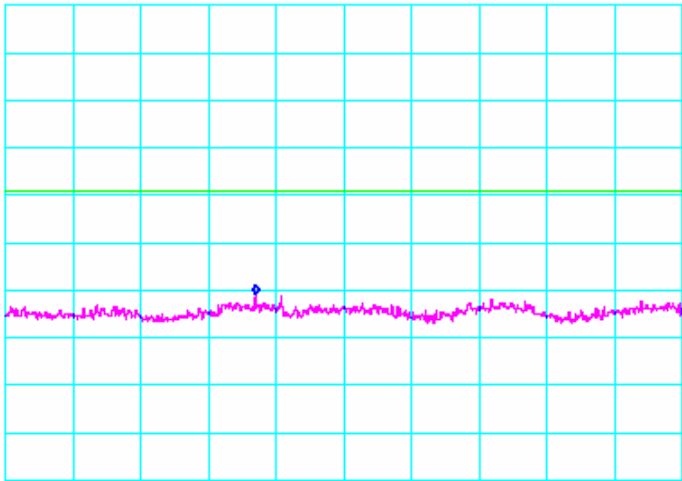
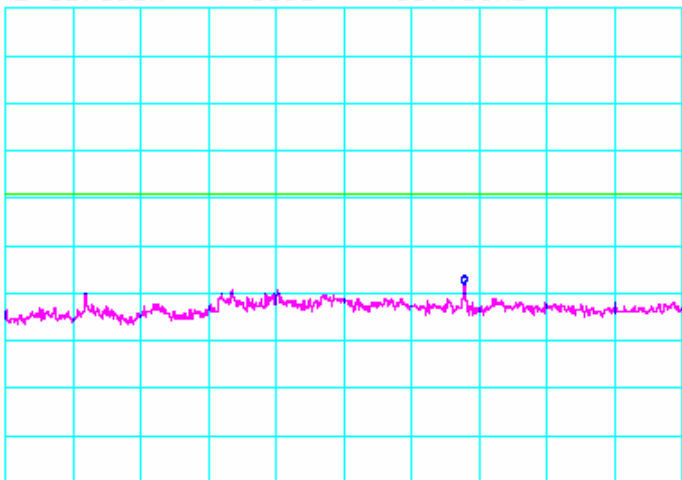
Test Date	Data	Chain	Test Eng.
08/05/09	5.60 GHz	B	JC
<div style="display: flex; justify-content: space-between; font-size: small;"> <span>*ATTEN 10dB</span> <span>MKR -48.83dBm</span> </div> <div style="display: flex; justify-content: space-between; font-size: small;"> <span>RL 12.0dBm</span> <span>10dB/</span> <span>7.307GHz</span> </div>  <div style="display: flex; justify-content: space-between; font-size: small; margin-top: 10px;"> <span>START 5.725GHz</span> <span>STOP 10.000GHz</span> </div> <div style="display: flex; justify-content: space-between; font-size: small;"> <span>*RBW 1.0MHz</span> <span>*VBW 1.0MHz</span> <span>SWP 86.0ms</span> </div>			
Test Date	Data	Chain	Test Eng.
08/05/09	5.60 GHz	B	JC
<div style="display: flex; justify-content: space-between; font-size: small;"> <span>*ATTEN 10dB</span> <span>MKR -46.17dBm</span> </div> <div style="display: flex; justify-content: space-between; font-size: small;"> <span>RL 12.0dBm</span> <span>10dB/</span> <span>16.78GHz</span> </div>  <div style="display: flex; justify-content: space-between; font-size: small; margin-top: 10px;"> <span>START 10.000GHz</span> <span>STOP 20.000GHz</span> </div> <div style="display: flex; justify-content: space-between; font-size: small;"> <span>*RBW 1.0MHz</span> <span>*VBW 1.0MHz</span> <span>SWP 200ms</span> </div>			



### Conducted Out Of Band Emissions (Continued)

#### 802.11a Mode

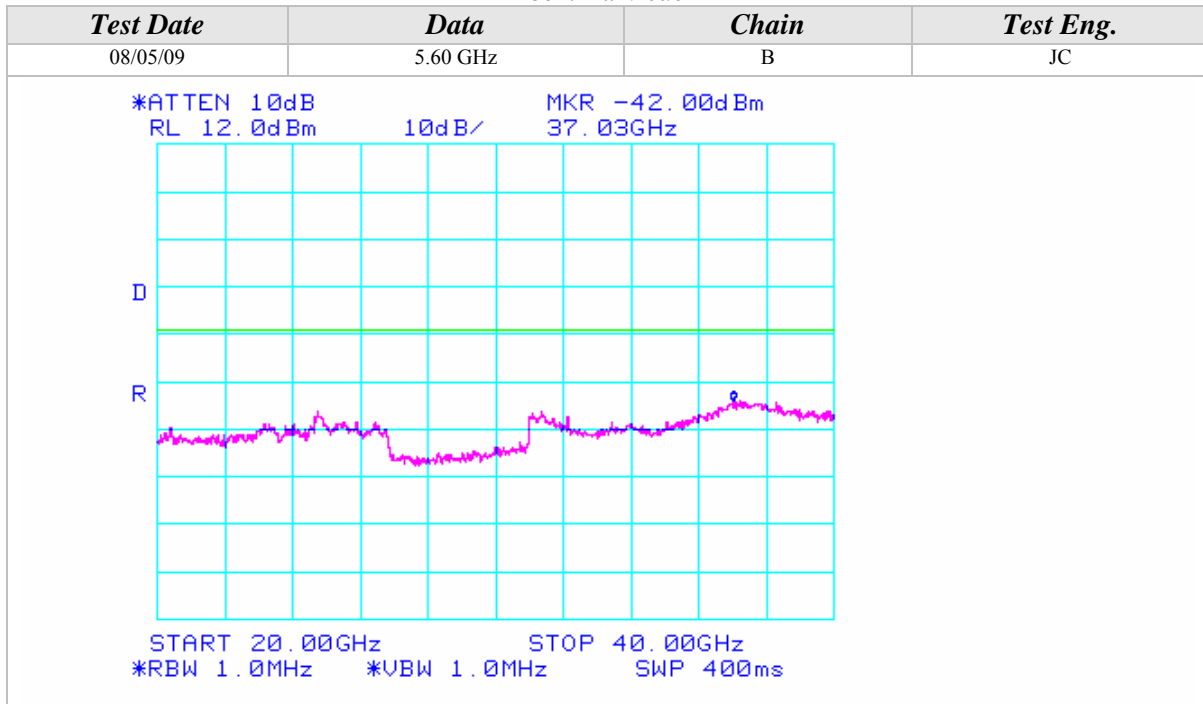



### Conducted Out Of Band Emissions (Continued)

#### 802.11a Mode

Test Date	Data	Chain	Test Eng.
08/05/09	5.70 GHz	B	JC
<p>*ATTEN 10dB                      MKR -54.50dBm RL 12.0dBm                      10dB/                      644.3MHz</p> <p>START 30.0MHz                      STOP 1.0000GHz *RBW 1.0MHz                      *VBW 1.0MHz                      SWP 50.0ms</p>			
Test Date	Data	Chain	Test Eng.
08/05/09	5.70 GHz	B	JC
<p>*ATTEN 10dB                      MKR -51.50dBm RL 12.0dBm                      10dB/                      3.795GHz</p> <p>START 1.000GHz                      STOP 5.460GHz *RBW 1.0MHz                      *VBW 1.0MHz                      SWP 90.0ms</p>			



Conducted Out Of Band Emissions (Continued)

802.11a Mode

Test Date	Data	Chain	Test Eng.
08/05/09	5.70 GHz	B	JC
<p>*ATTEN 10dB      MKR -35.67dBm RL 12.0dBm      10dB/      5.725GHz</p> <p>START 5.725GHz      STOP 10.000GHz *RBW 1.0MHz      *VBW 1.0MHz      SWP 86.0ms</p>			
Test Date	Data	Chain	Test Eng.
08/05/09	5.70 GHz	B	JC
<p>*ATTEN 10dB      MKR -47.50dBm RL 12.0dBm      10dB/      17.08GHz</p> <p>START 10.00GHz      STOP 20.00GHz *RBW 1.0MHz      *VBW 1.0MHz      SWP 200ms</p>			



### Conducted Out Of Band Emissions (Continued)

*802.11a Mode*

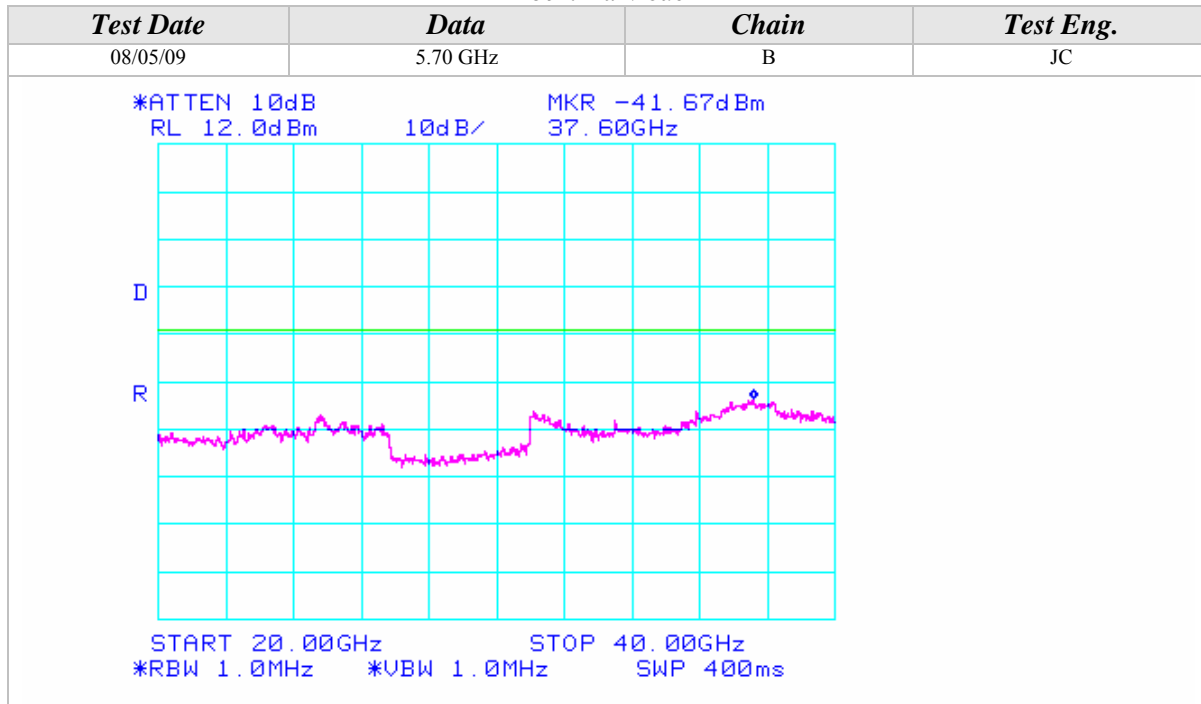



Conducted Out Of Band Emissions (Continued)

802.11n Mode, 5GHz, 20MHz Wide

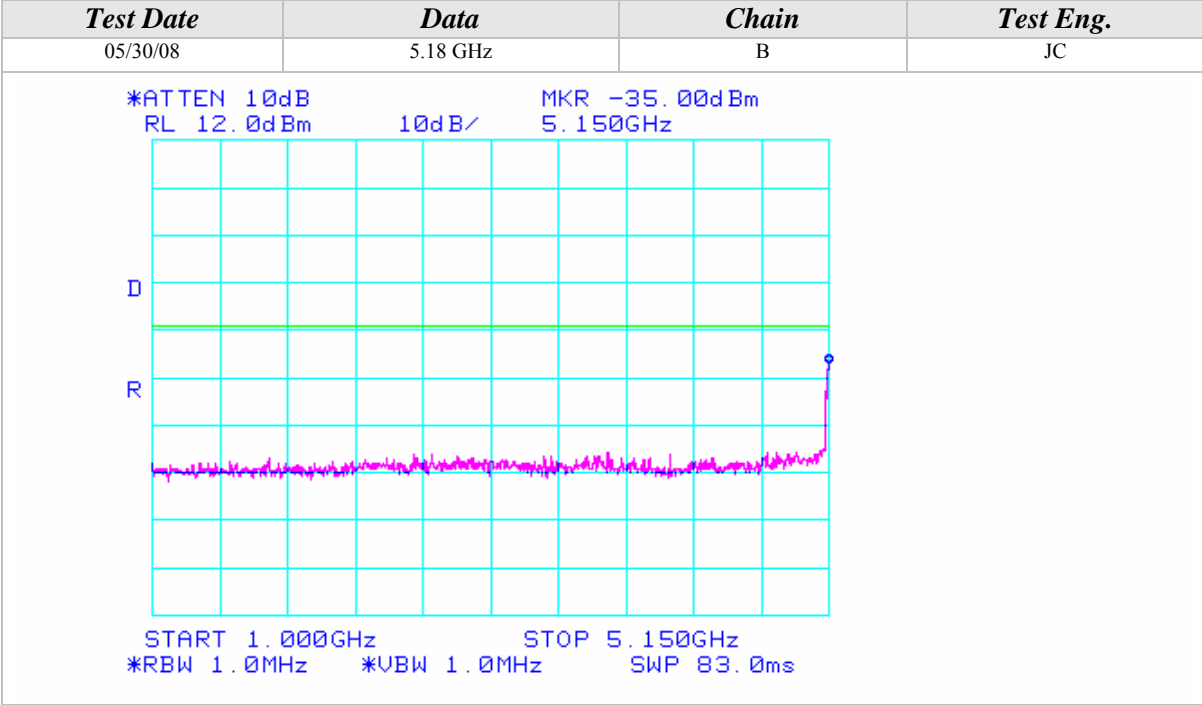
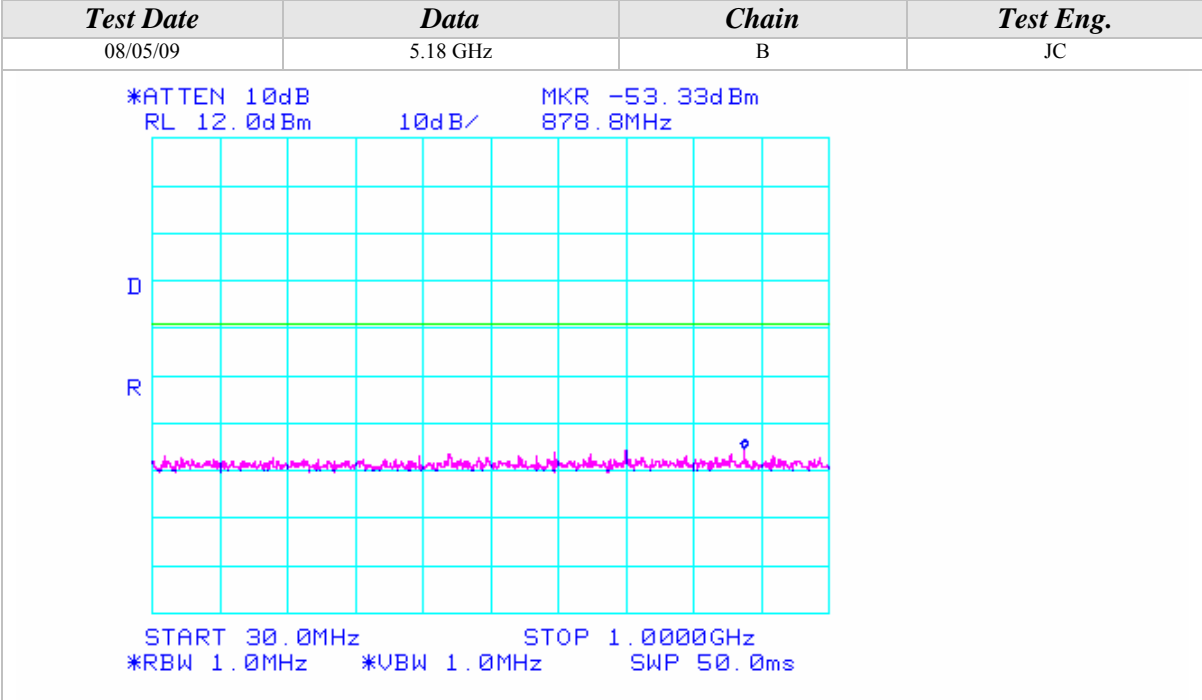



## Conducted Out Of Band Emissions (Continued)

*802.11n Mode, 5GHz, 20MHz Wide*

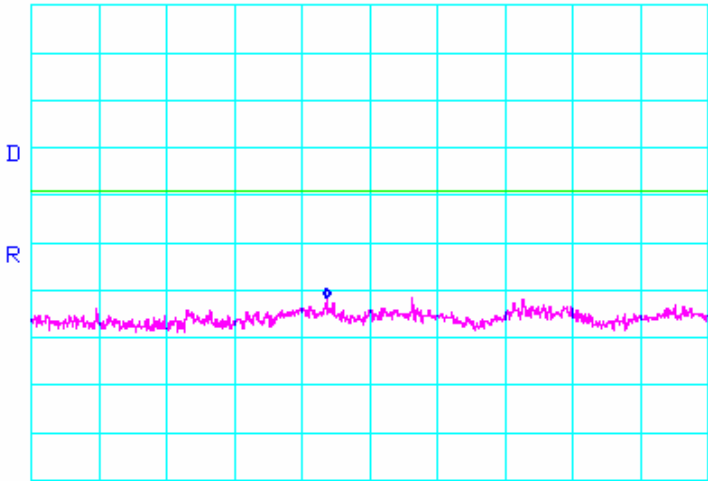
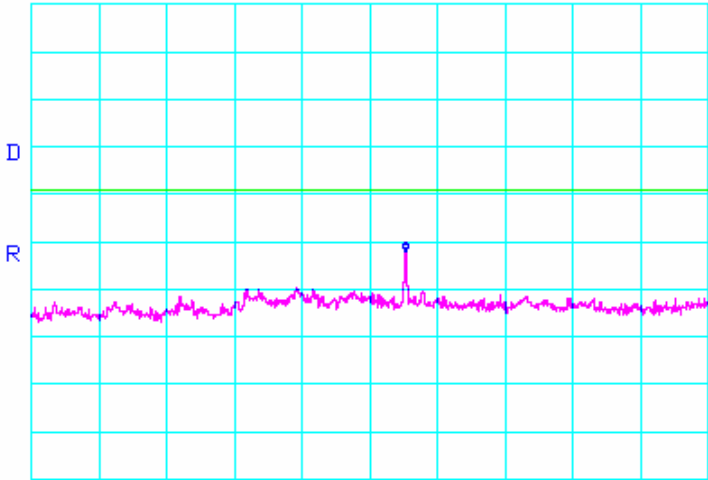
<i>Test Date</i>	<i>Data</i>	<i>Chain</i>	<i>Test Eng.</i>
08/05/09	5.18 GHz	B	JC
<p>*ATTEN 10dB                                  MKR -49.67dBm RL 12.0dBm                              10dB/                              7.381GHz</p>  <p>START 5.350GHz                              STOP 10.000GHz *RBW 1.0MHz                              *VBW 1.0MHz                              SWP 93.0ms</p>			
<i>Test Date</i>	<i>Data</i>	<i>Chain</i>	<i>Test Eng.</i>
05/30/08	5.18 GHz	B	JC
<p>*ATTEN 10dB                                  MKR -40.00dBm RL 12.0dBm                              10dB/                              15.53GHz</p>  <p>START 10.00GHz                              STOP 20.00GHz *RBW 1.0MHz                              *VBW 1.0MHz                              SWP 200ms</p>			

Conducted Out Of Band Emissions (Continued)

802.11n Mode, 5GHz, 20MHz Wide

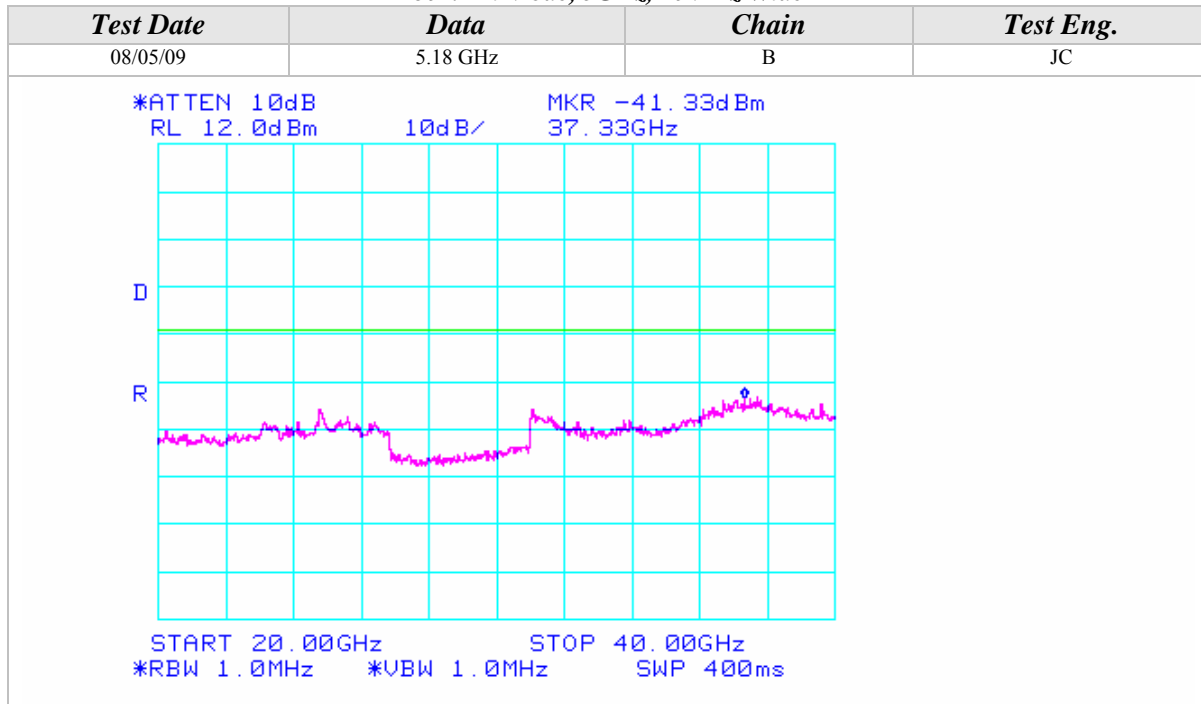

Conducted Out Of Band Emissions (Continued)

802.11n Mode, 5GHz, 20MHz Wide

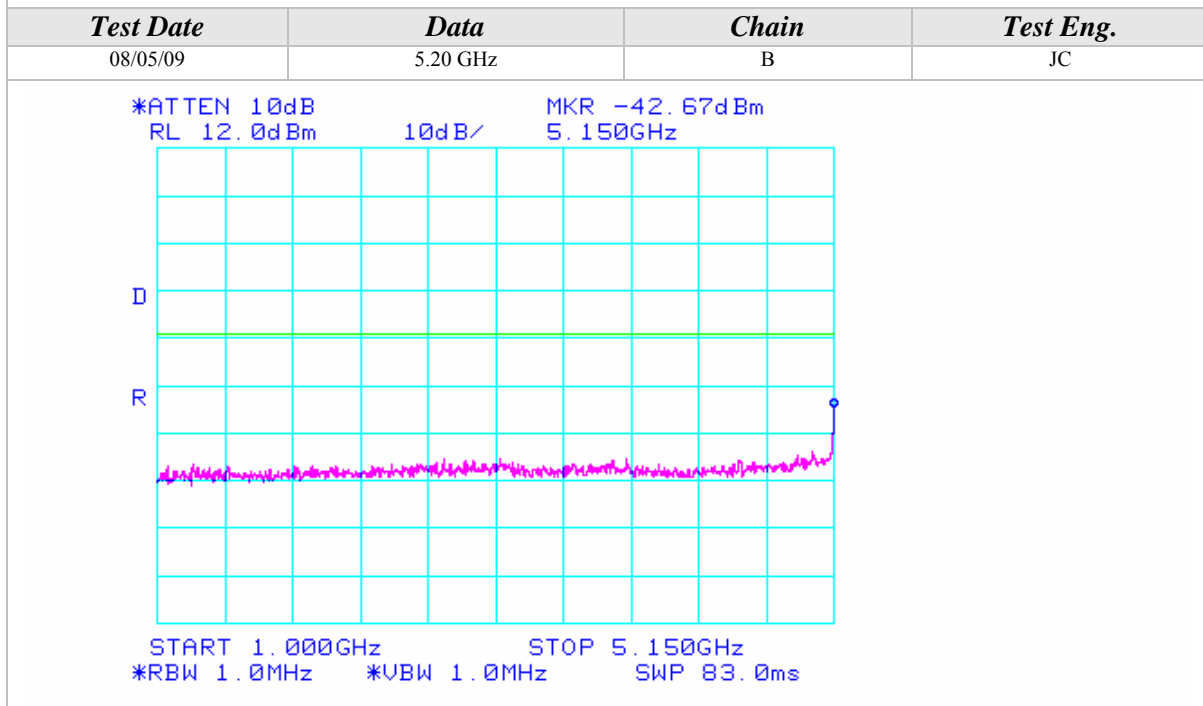
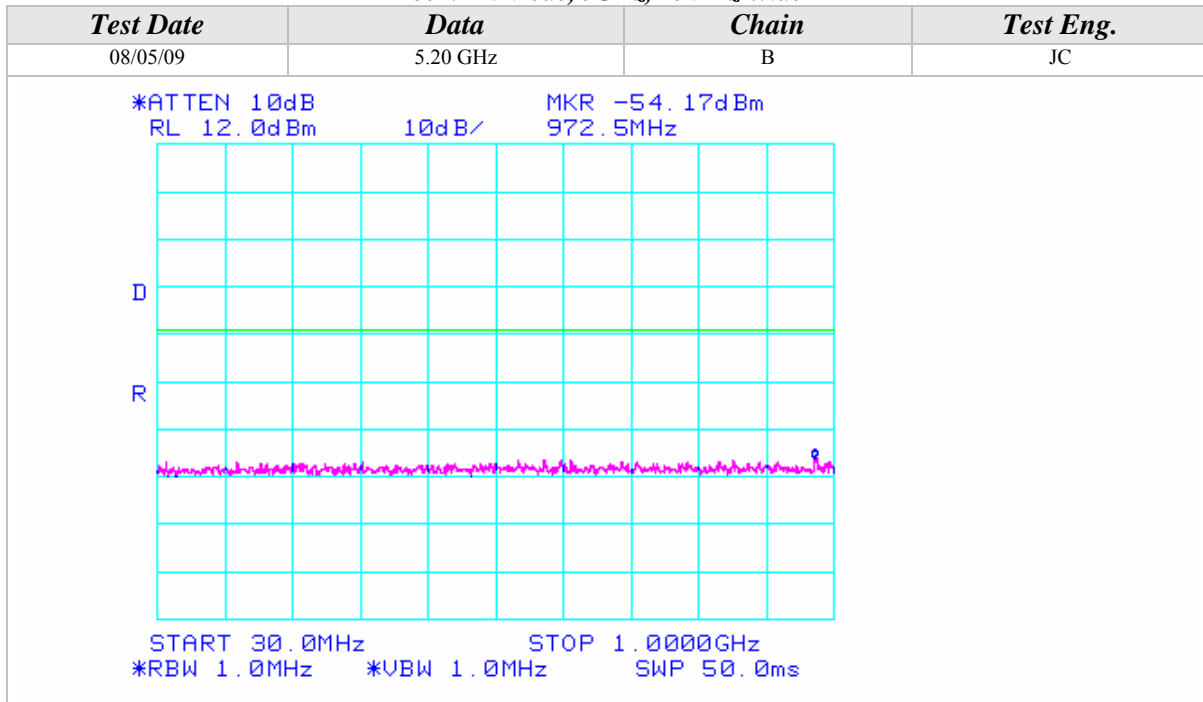



Conducted Out Of Band Emissions (Continued)

802.11n Mode, 5GHz, 20MHz Wide

Test Date	Data	Chain	Test Eng.
08/05/09	5.20 GHz	B	JC

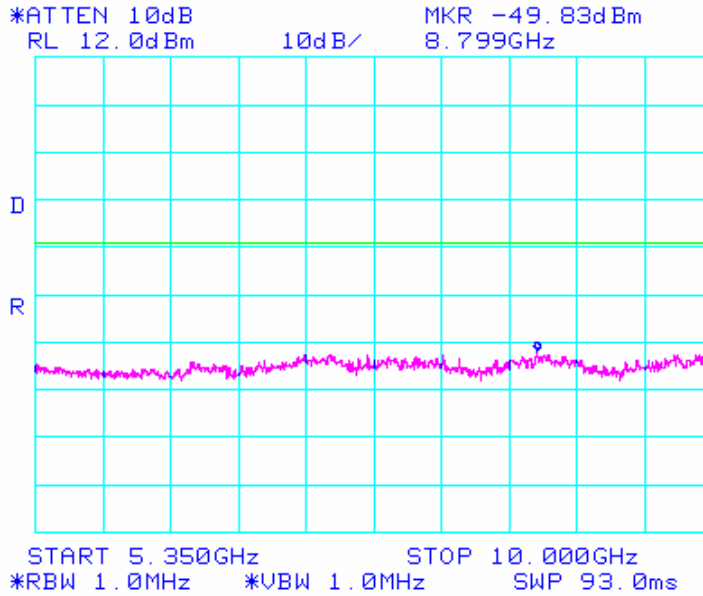

Test Date	Data	Chain	Test Eng.
08/05/09	5.20 GHz	B	JC

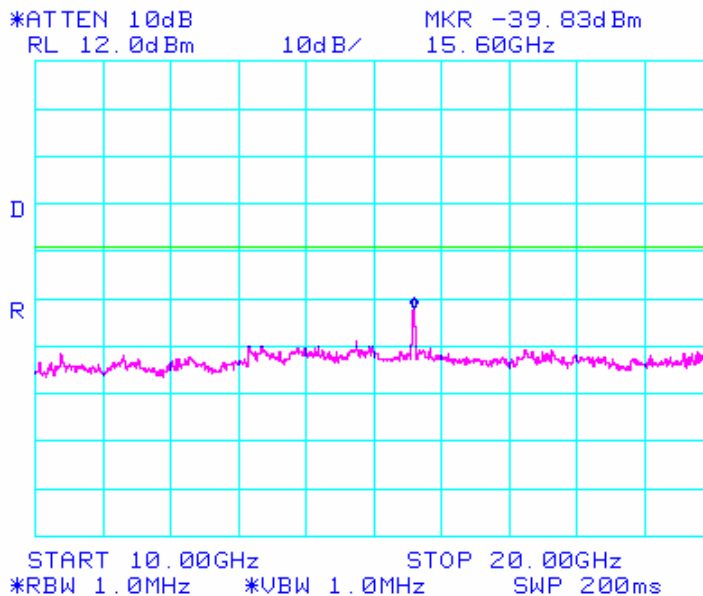



### Conducted Out Of Band Emissions (Continued)

#### 802.11n Mode, 5GHz, 20MHz Wide

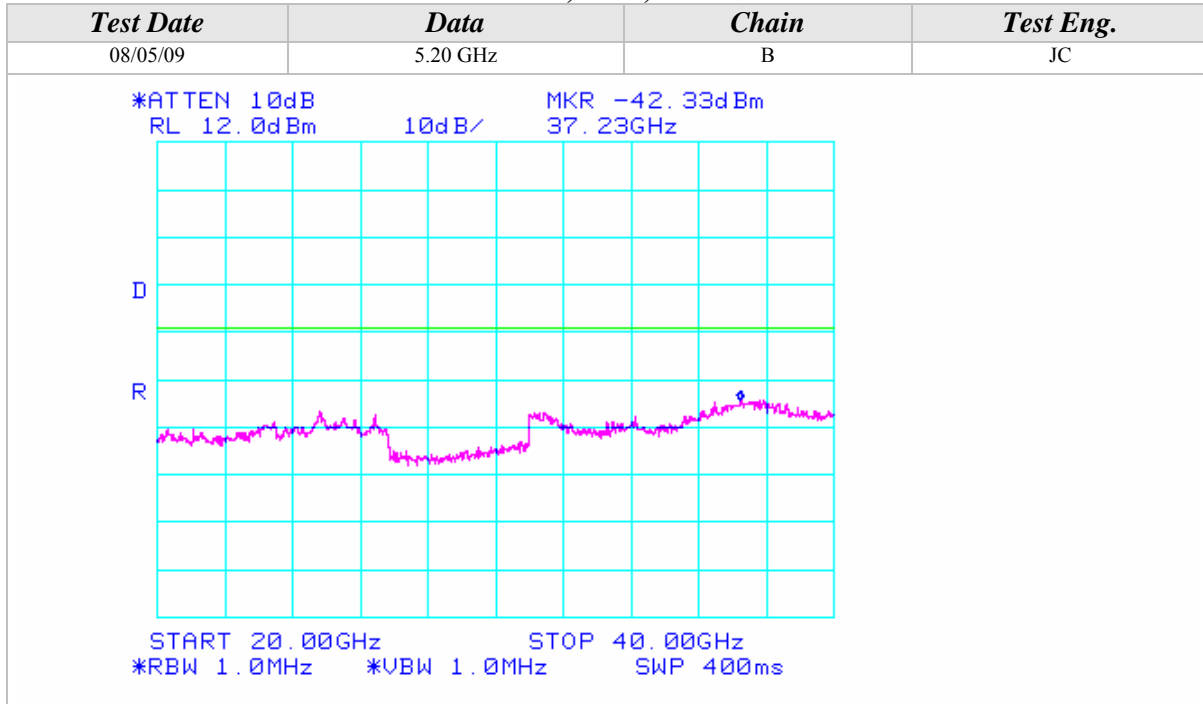



Conducted Out Of Band Emissions (Continued)

802.11n Mode, 5GHz, 20MHz Wide

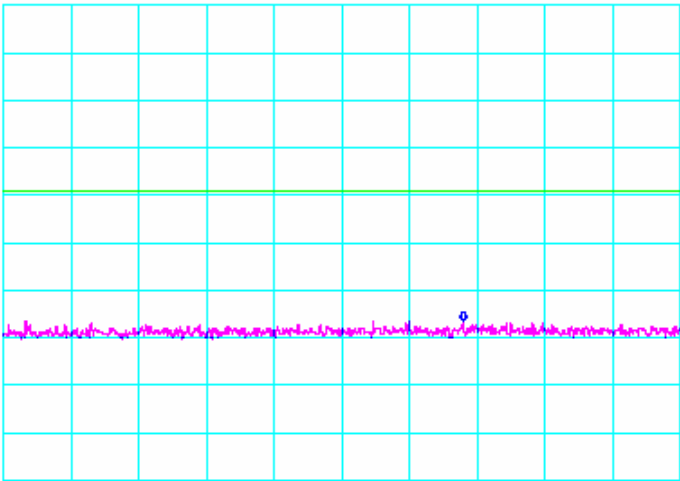
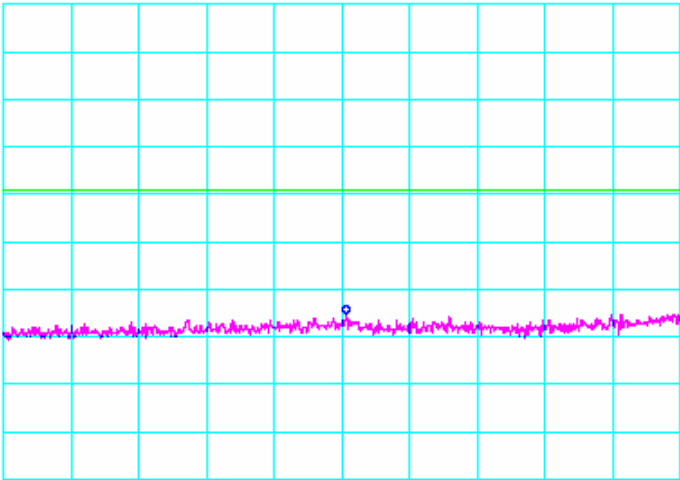
Test Date	Data	Chain	Test Eng.
08/05/09	5.24 GHz	B	JC
<p>*ATTEN 10dB RL 12.0dBm      10dB/      MKR -54.50dBm 689.6MHz</p>  <p>START 30.0MHz      STOP 1.0000GHz *RBW 1.0MHz      *VBW 1.0MHz      SWP 50.0ms</p>			
Test Date	Data	Chain	Test Eng.
08/05/09	5.24 GHz	B	JC
<p>*ATTEN 10dB RL 12.0dBm      10dB/      MKR -53.33dBm 3.103GHz</p>  <p>START 1.000GHz      STOP 5.150GHz *RBW 1.0MHz      *VBW 1.0MHz      SWP 83.0ms</p>			



### Conducted Out Of Band Emissions (Continued)

#### 802.11n Mode, 5GHz, 20MHz Wide

Test Date	Data	Chain	Test Eng.
08/05/09	5.24 GHz	B	JC
<p>*ATTEN 10dB                                      MKR -50.67dBm RL 12.0dBm                                      10dB/                                      9.690GHz</p> <p>START 5.350GHz                                      STOP 10.000GHz *RBW 1.0MHz                                      *VBW 1.0MHz                                      SWP 93.0ms</p>			
Test Date	Data	Chain	Test Eng.
08/05/09	5.24 GHz	B	JC
<p>*ATTEN 10dB                                      MKR -39.17dBm RL 12.0dBm                                      10dB/                                      15.72GHz</p> <p>START 10.000GHz                                      STOP 20.000GHz *RBW 1.0MHz                                      *VBW 1.0MHz                                      SWP 200ms</p>			



Conducted Out Of Band Emissions (Continued)

802.11n Mode, 5GHz, 20MHz Wide

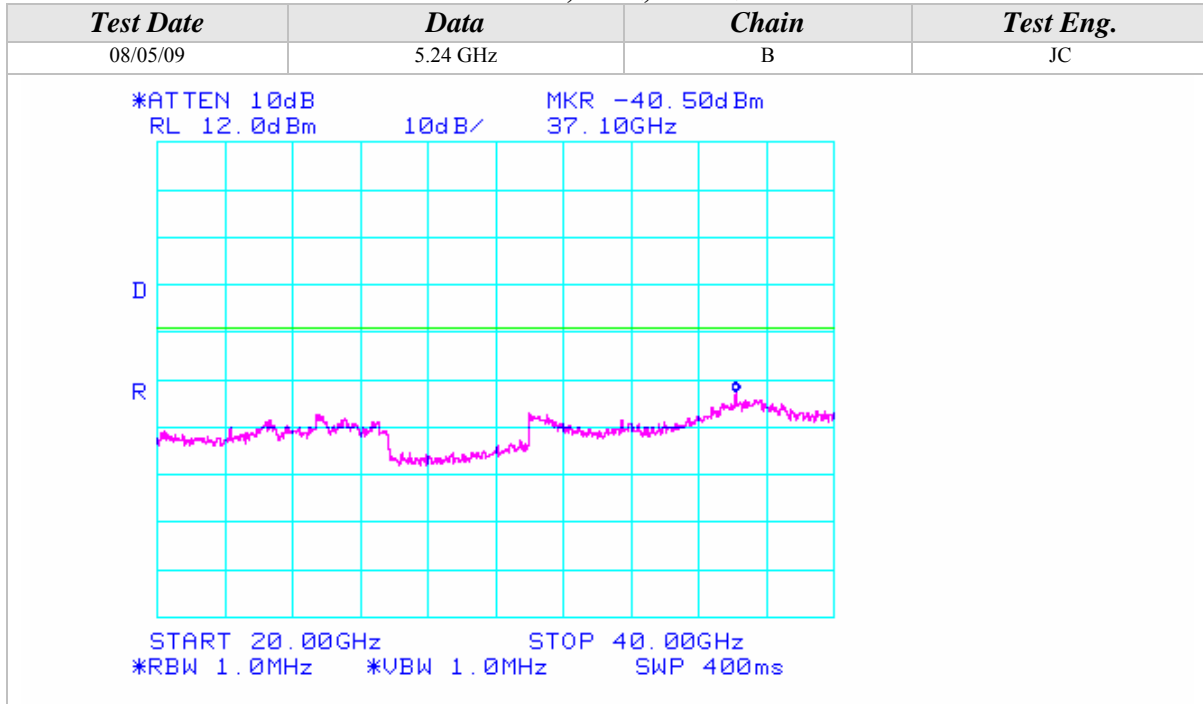





Conducted Out Of Band Emissions (Continued)

802.11n Mode, 5GHz, 20MHz Wide

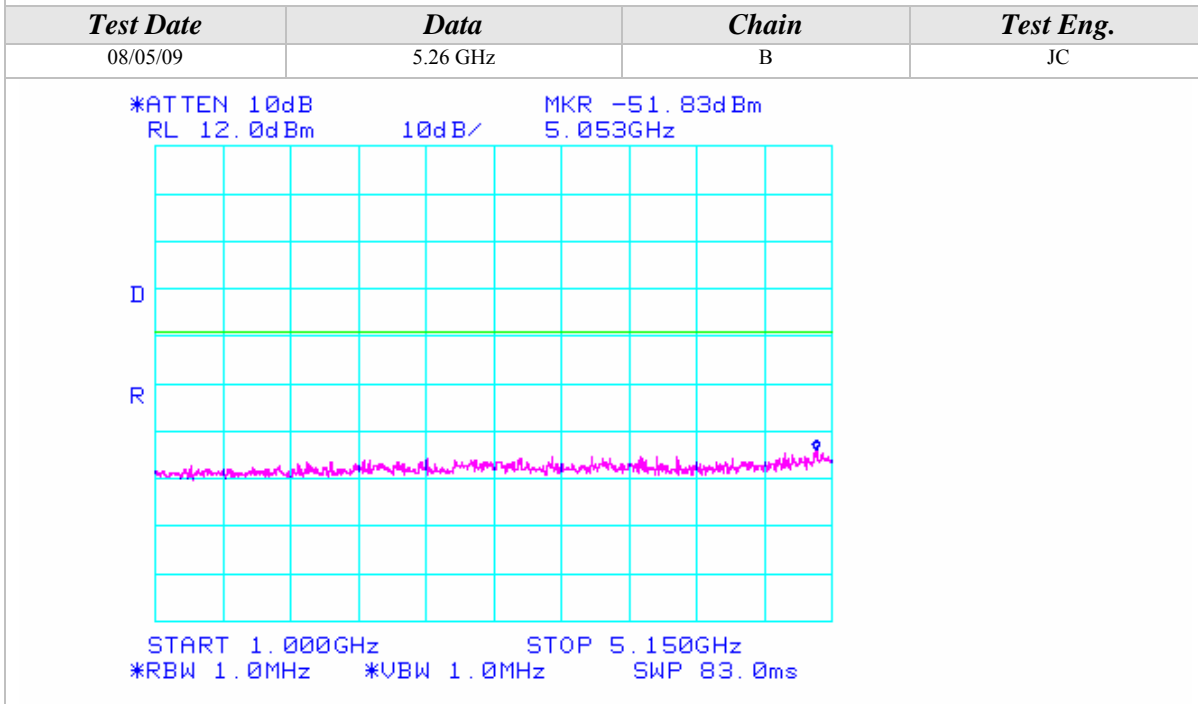
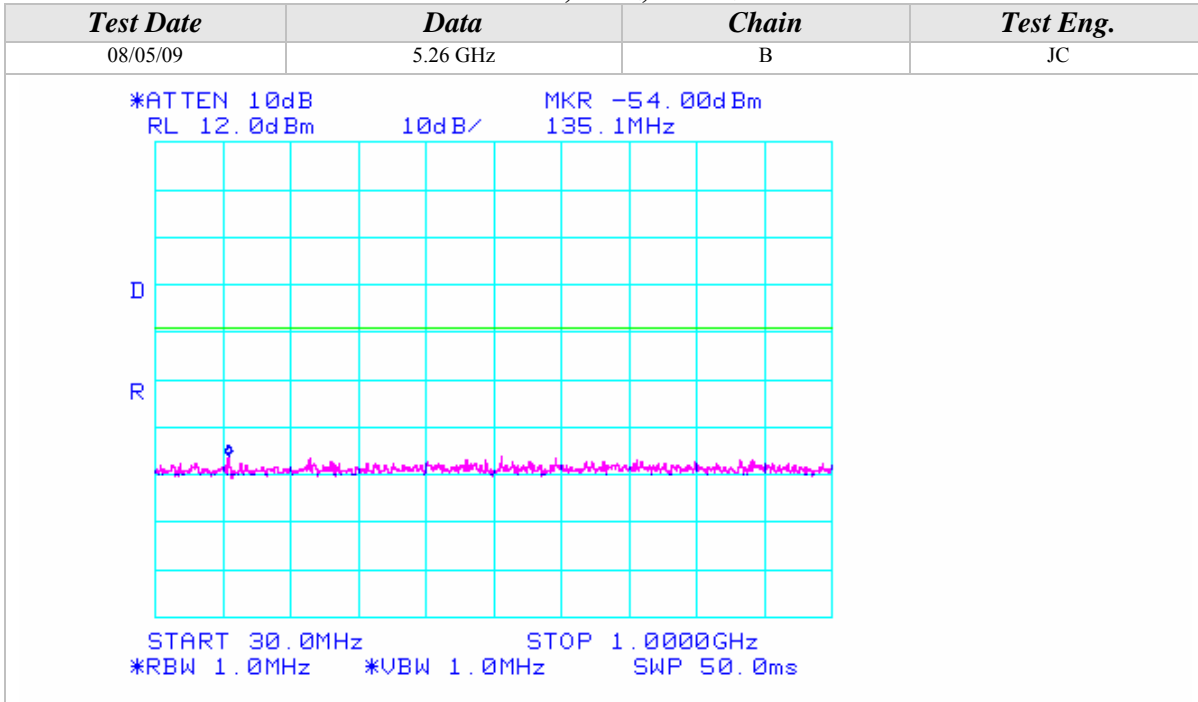



Conducted Out Of Band Emissions (Continued)

802.11n Mode, 5GHz, 20MHz Wide

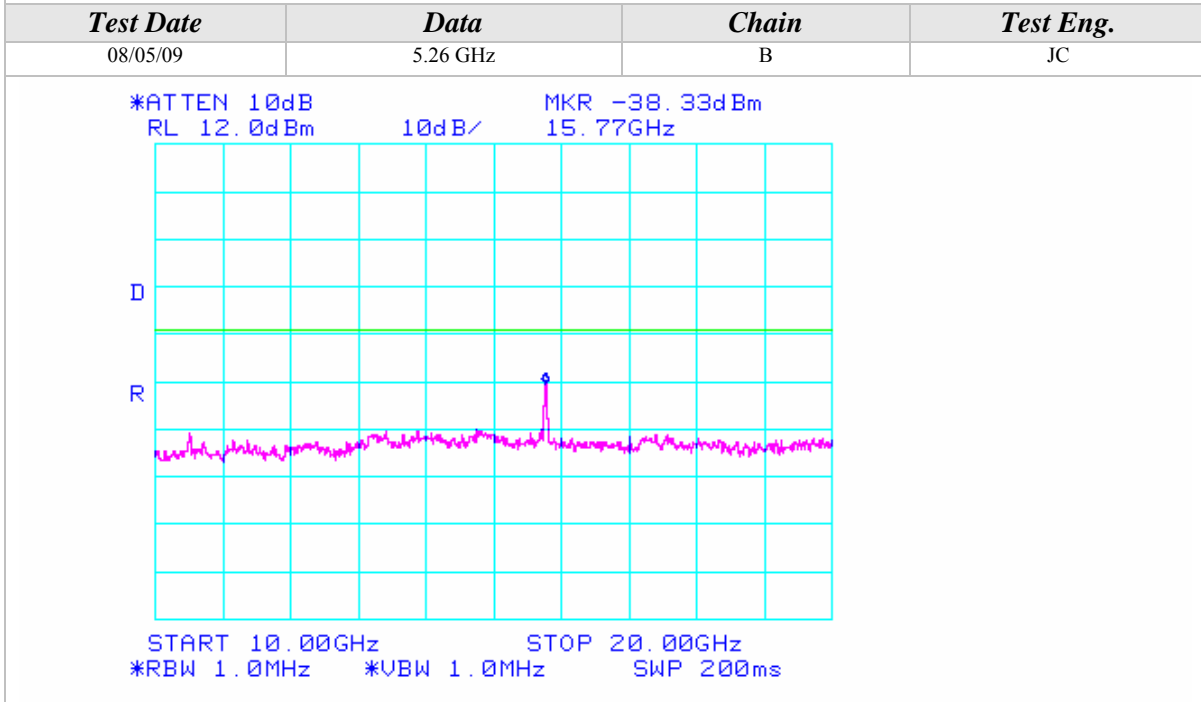
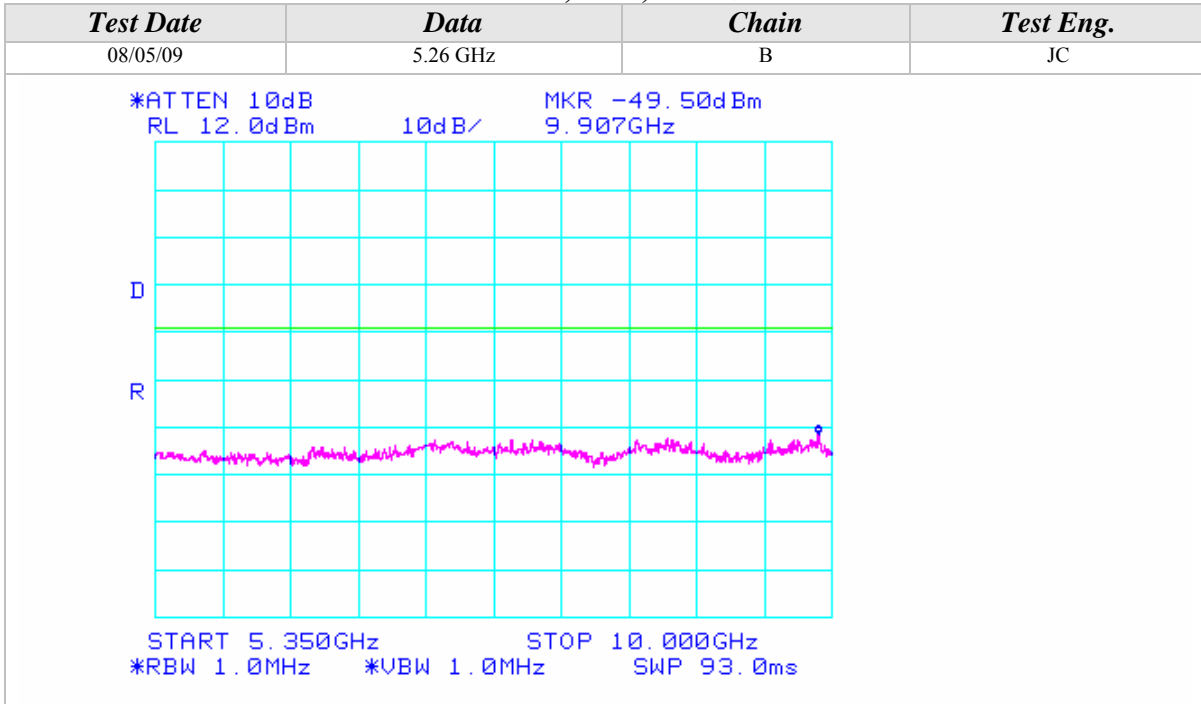



Conducted Out Of Band Emissions (Continued)

802.11n Mode, 5GHz, 20MHz Wide

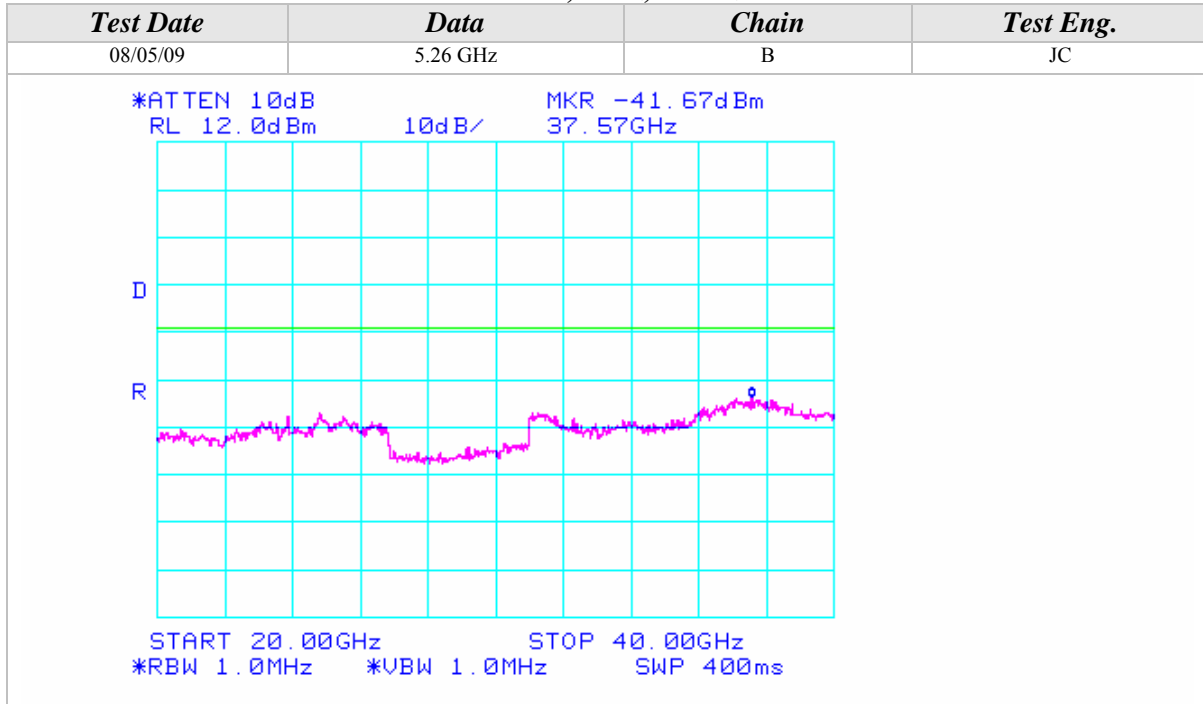

### Conducted Out Of Band Emissions (Continued)

802.11n Mode, 5GHz, 20MHz Wide

<b>Test Date</b>	<b>Data</b>	<b>Chain</b>	<b>Test Eng.</b>
08/05/09	5.28 GHz	B	JC
<p>*ATTEN 10dB                                      MKR -54.17dBm RL 12.0dBm                                      10dB/                                      801.2MHz</p> <p>START 30.0MHz                                      STOP 1.0000GHz *RBW 1.0MHz                                      *VBW 1.0MHz                                      SWP 50.0ms</p>			
<b>Test Date</b>	<b>Data</b>	<b>Chain</b>	<b>Test Eng.</b>
08/05/09	5.28 GHz	B	JC
<p>*ATTEN 10dB                                      MKR -52.83dBm RL 12.0dBm                                      10dB/                                      4.998GHz</p> <p>START 1.000GHz                                      STOP 5.150GHz *RBW 1.0MHz                                      *VBW 1.0MHz                                      SWP 83.0ms</p>			

## Conducted Out Of Band Emissions (Continued)

## 802.11n Mode, 5GHz, 20MHz Wide

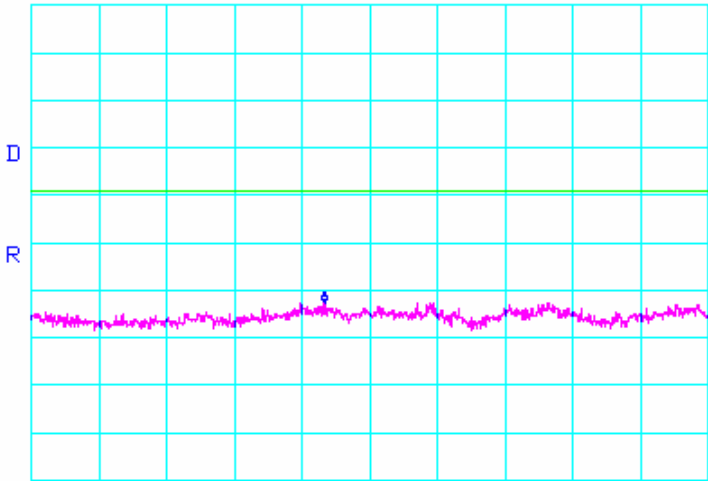
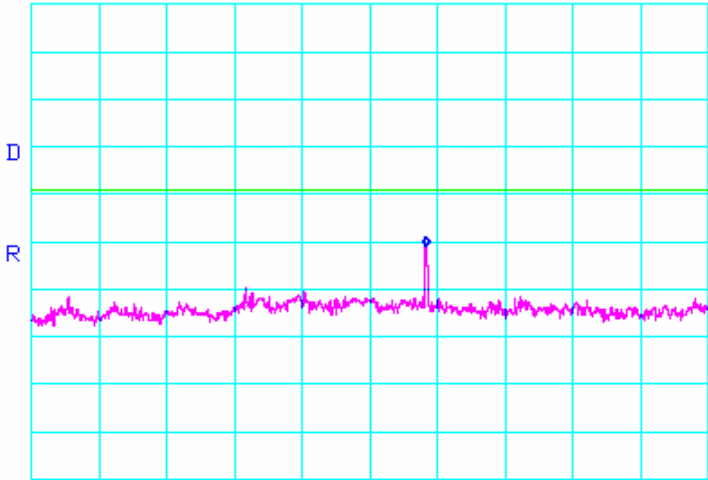
Test Date	Data	Chain	Test Eng.
08/05/09	5.28 GHz	B	JC
*ATTEN 10dB MKR -50.50dBm RL 12.0dBm 10dB/ 7.365GHz  <p>START 5.350GHz STOP 10.000GHz            *RBW 1.0MHz *VBW 1.0MHz SWP 93.0ms</p>			
Test Date	Data	Chain	Test Eng.
08/05/09	5.28 GHz	B	JC
*ATTEN 10dB MKR -39.00dBm RL 12.0dBm 10dB/ 15.83GHz  <p>START 10.000GHz STOP 20.000GHz            *RBW 1.0MHz *VBW 1.0MHz SWP 200ms</p>			

Conducted Out Of Band Emissions (Continued)

802.11n Mode, 5GHz, 20MHz Wide

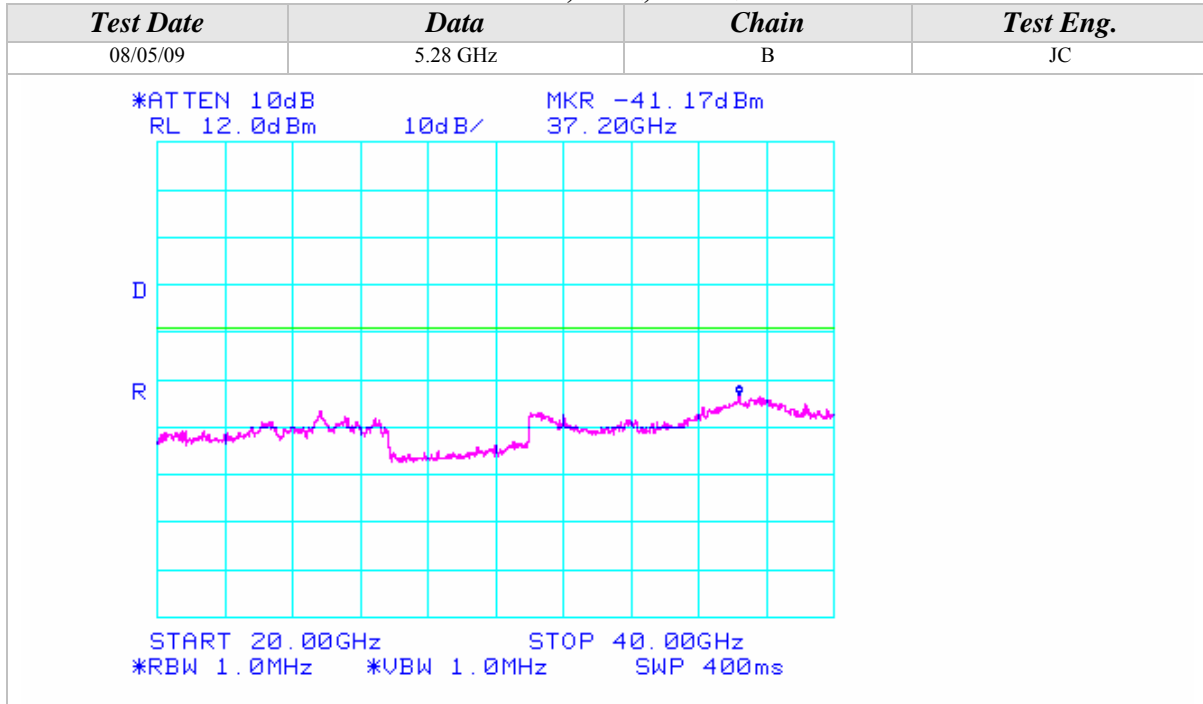



Conducted Out Of Band Emissions (Continued)

802.11n Mode, 5GHz, 20MHz Wide

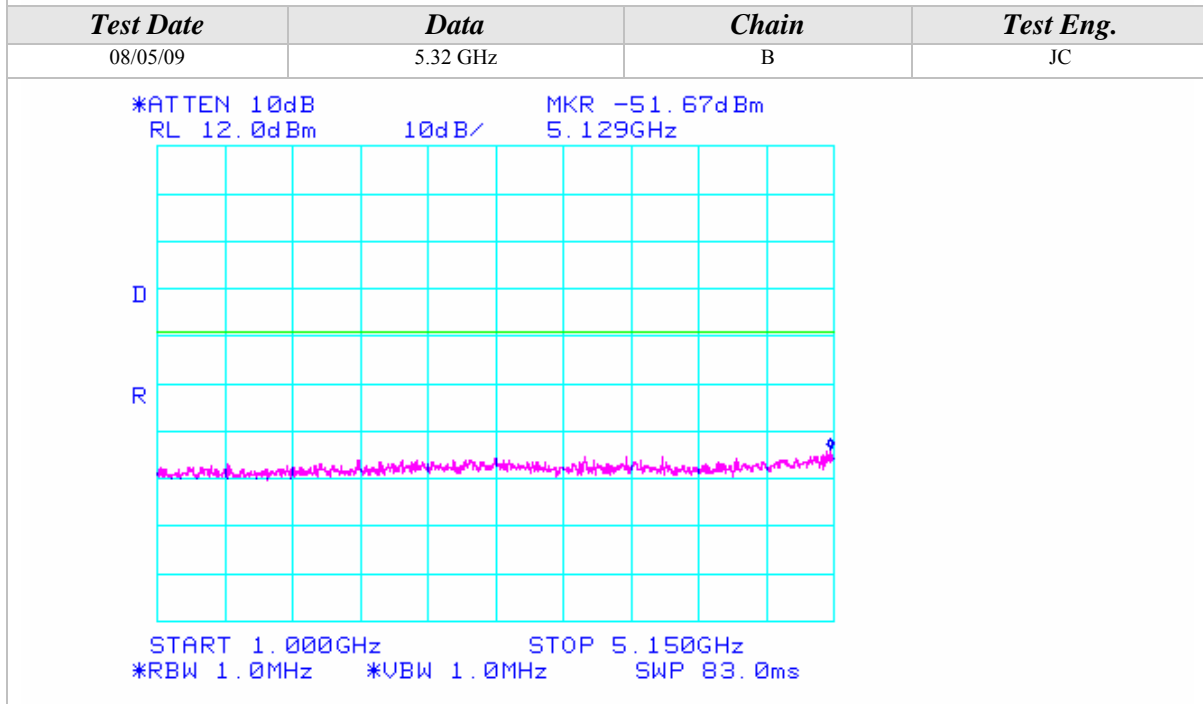
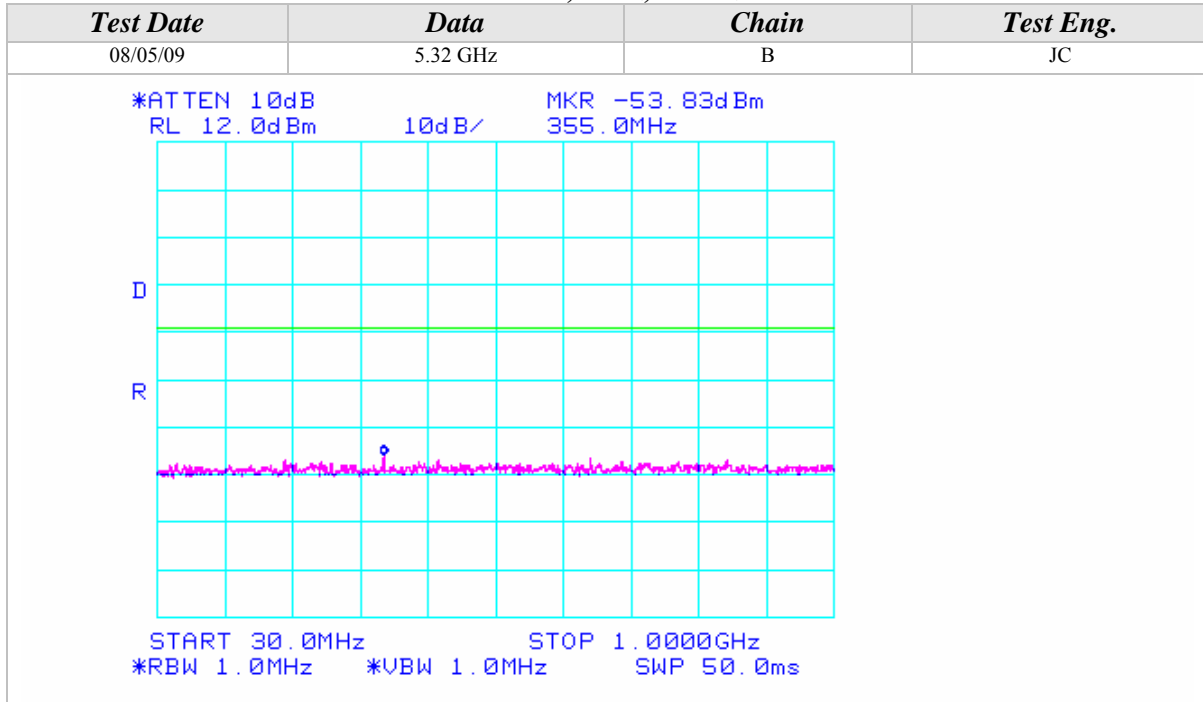







Conducted Out Of Band Emissions (Continued)

802.11n Mode, 5GHz, 20MHz Wide

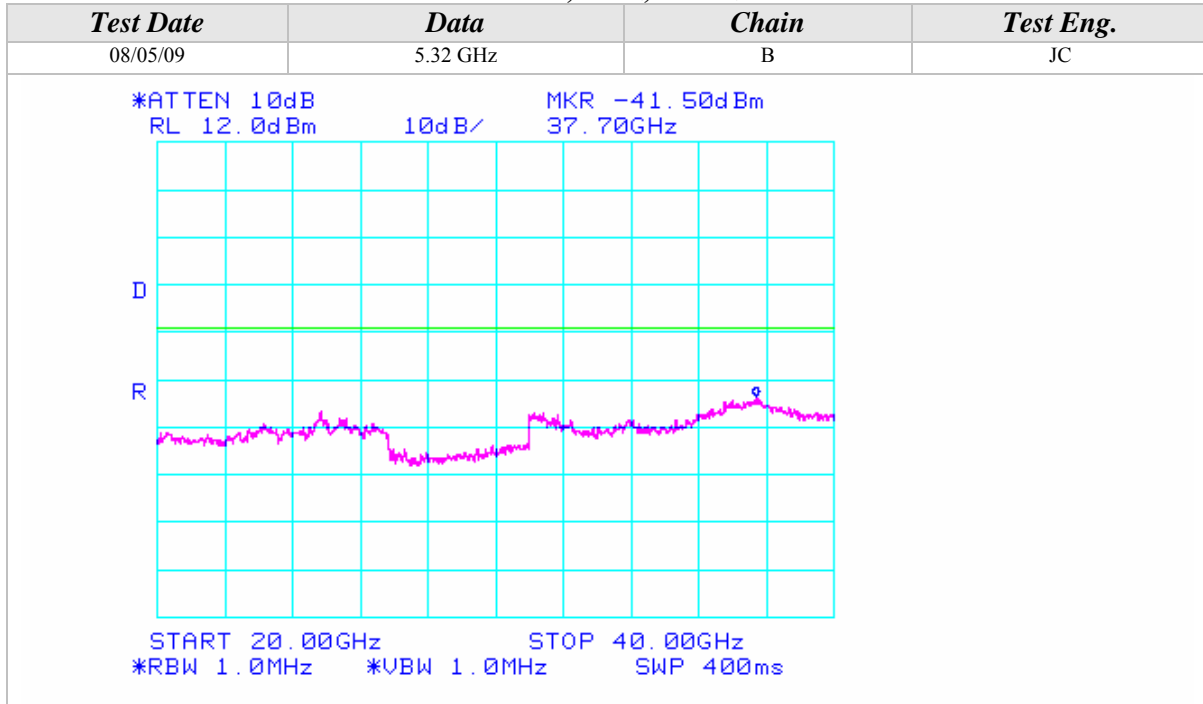





Conducted Out Of Band Emissions (Continued)

802.11n Mode, 5GHz, 20MHz Wide

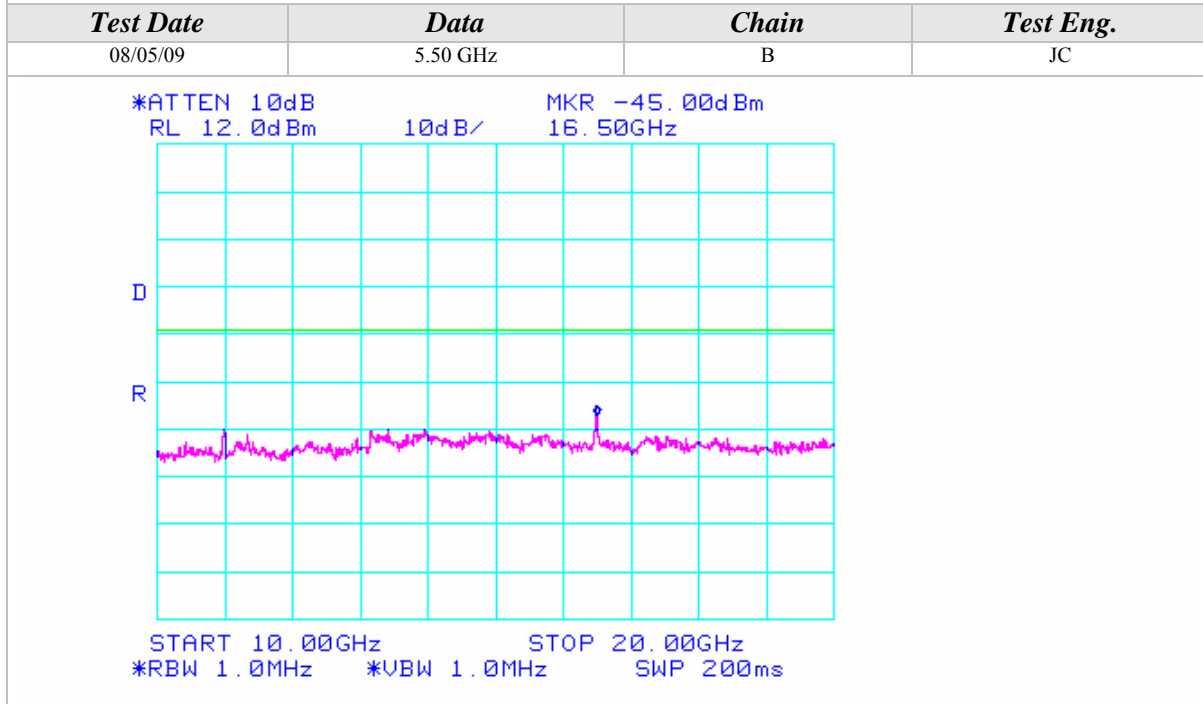
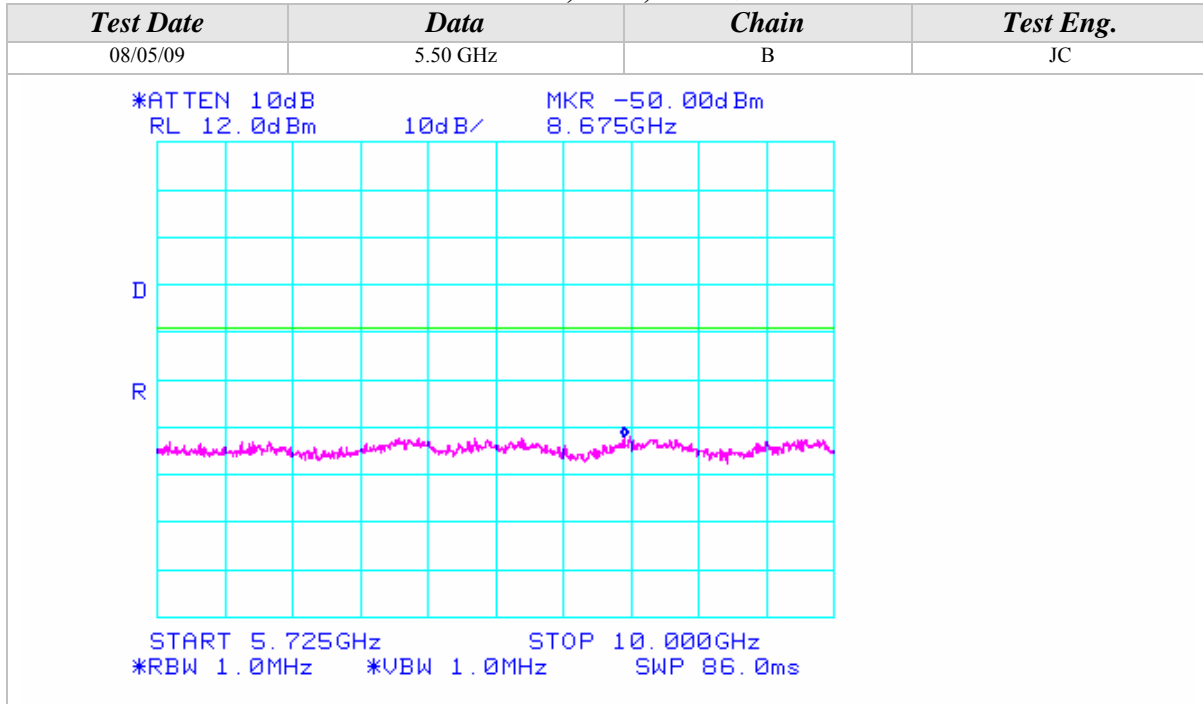



### Conducted Out Of Band Emissions (Continued)

#### 802.11n Mode, 5GHz, 20MHz Wide

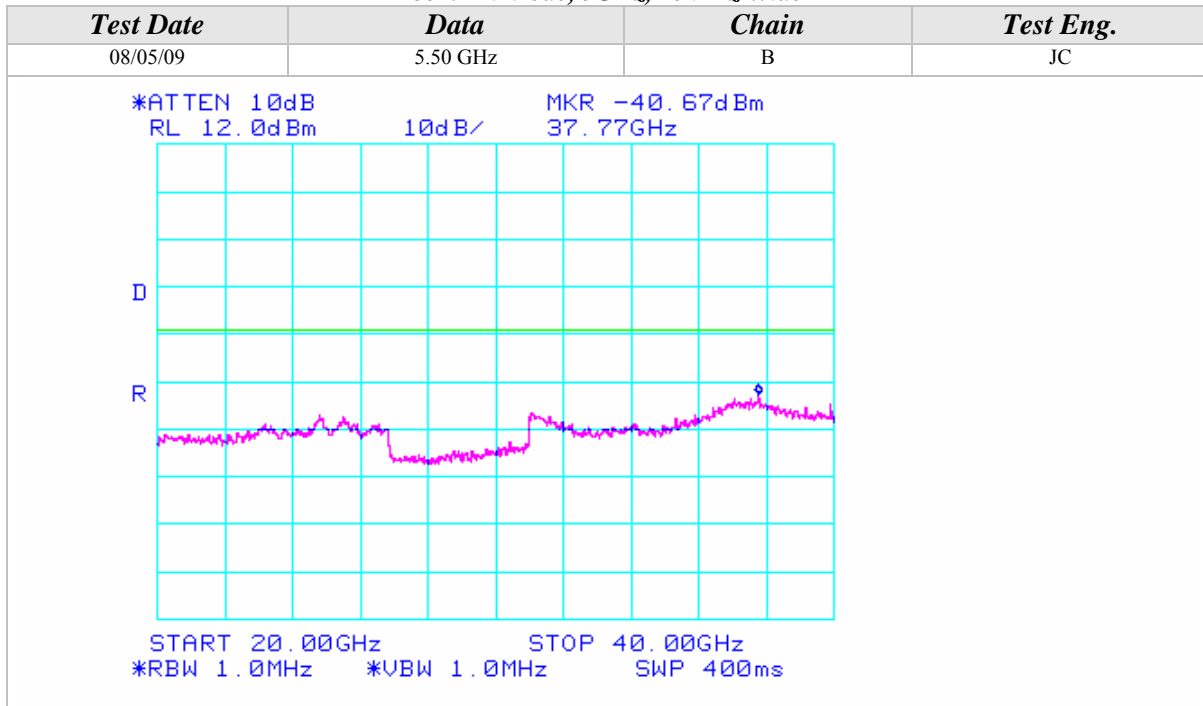

## Conducted Out Of Band Emissions (Continued)

## 802.11n Mode, 5GHz, 20MHz Wide

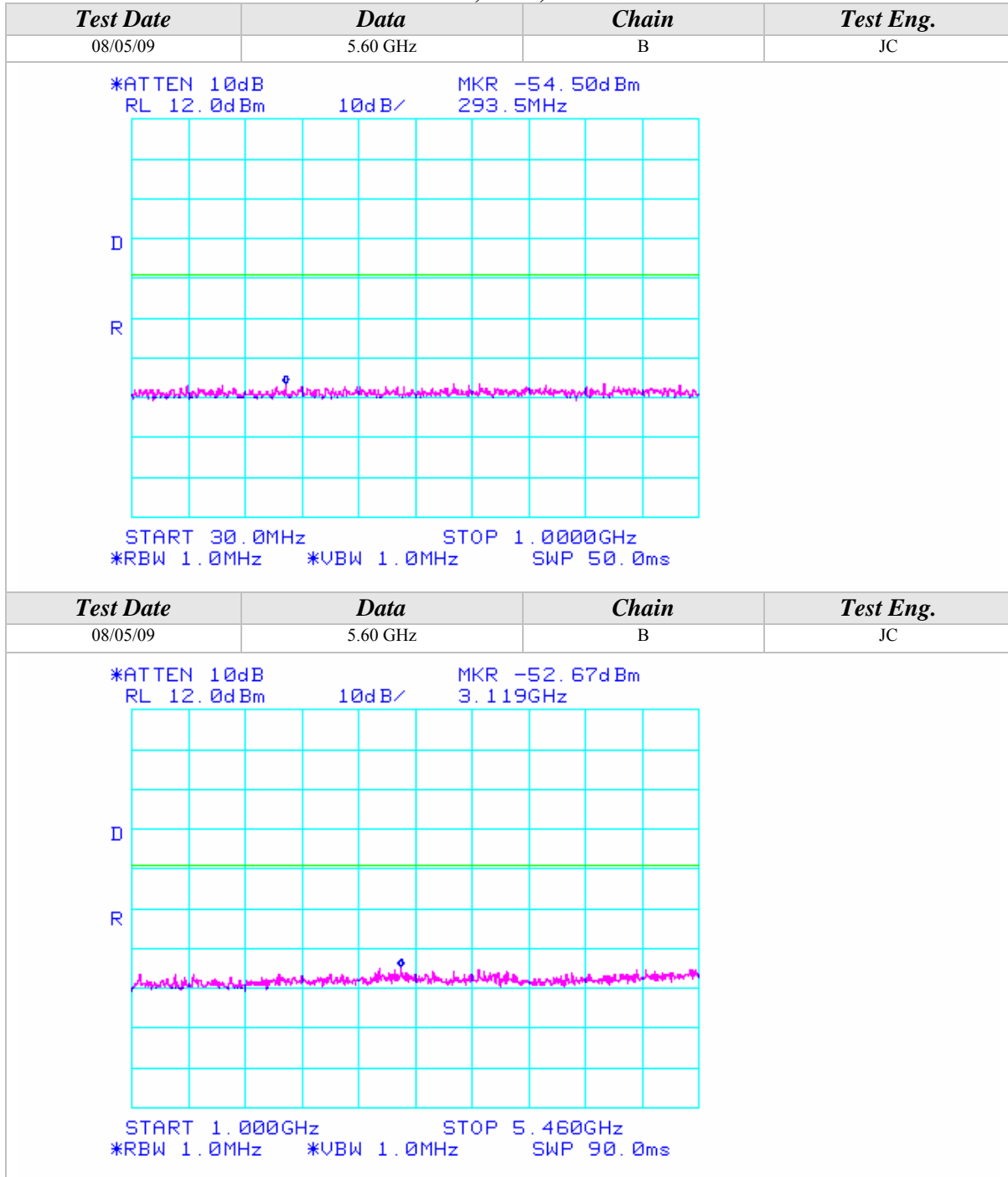





### Conducted Out Of Band Emissions (Continued)

#### 802.11n Mode, 5GHz, 20MHz Wide

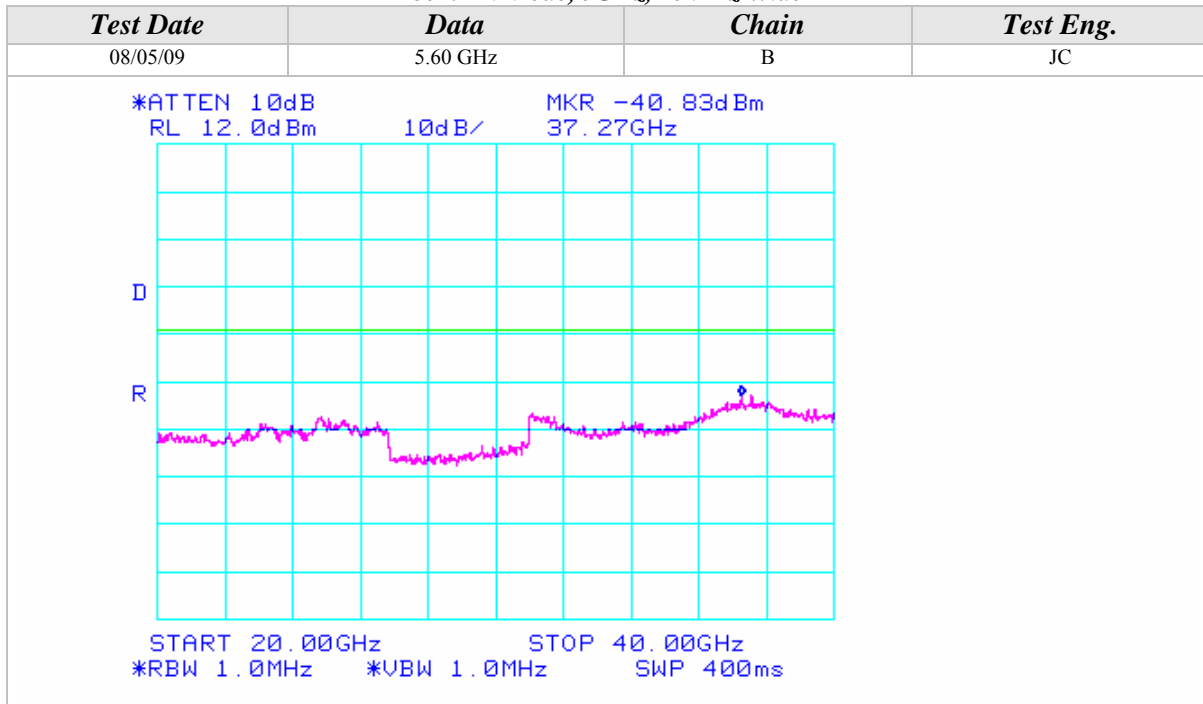







### Conducted Out Of Band Emissions (Continued)

802.11n Mode, 5GHz, 20MHz Wide

Test Date	Data	Chain	Test Eng.
08/05/09	5.70 GHz	B	JC
<p>*ATTEN 10dB                                      MKR -32.83dBm            RL 12.0dBm                                    10dB/                                    5.725GHz</p> <p>START 5.725GHz                                    STOP 10.000GHz            *RBW 1.0MHz                                    *VBW 1.0MHz                            SWP 86.0ms</p>			
Test Date	Data	Chain	Test Eng.
08/05/09	5.70 GHz	B	JC
<p>*ATTEN 10dB                                      MKR -47.67dBm            RL 12.0dBm                                    10dB/                                    11.38GHz</p> <p>START 10.000GHz                                   STOP 20.000GHz            *RBW 1.0MHz                                    *VBW 1.0MHz                            SWP 200ms</p>			



Conducted Out Of Band Emissions (Continued)

802.11n Mode, 5GHz, 20MHz Wide

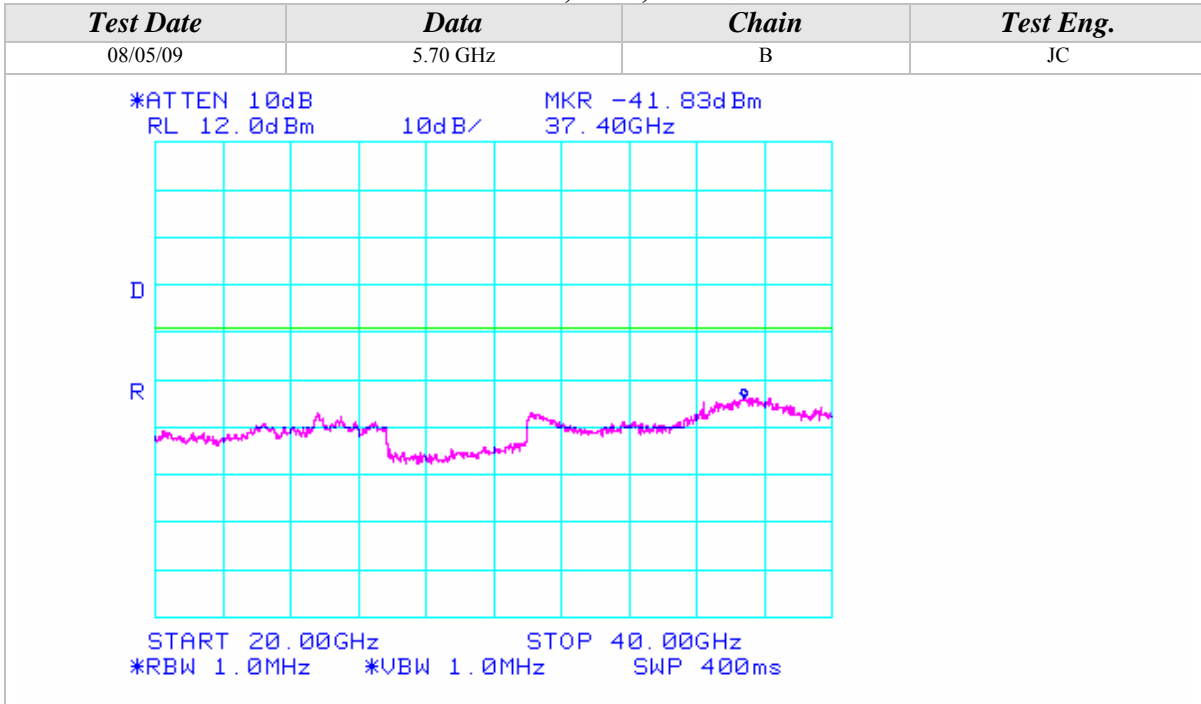





Conducted Out Of Band Emissions (Continued)

802.11n Mode, 5GHz, 40MHz Wide

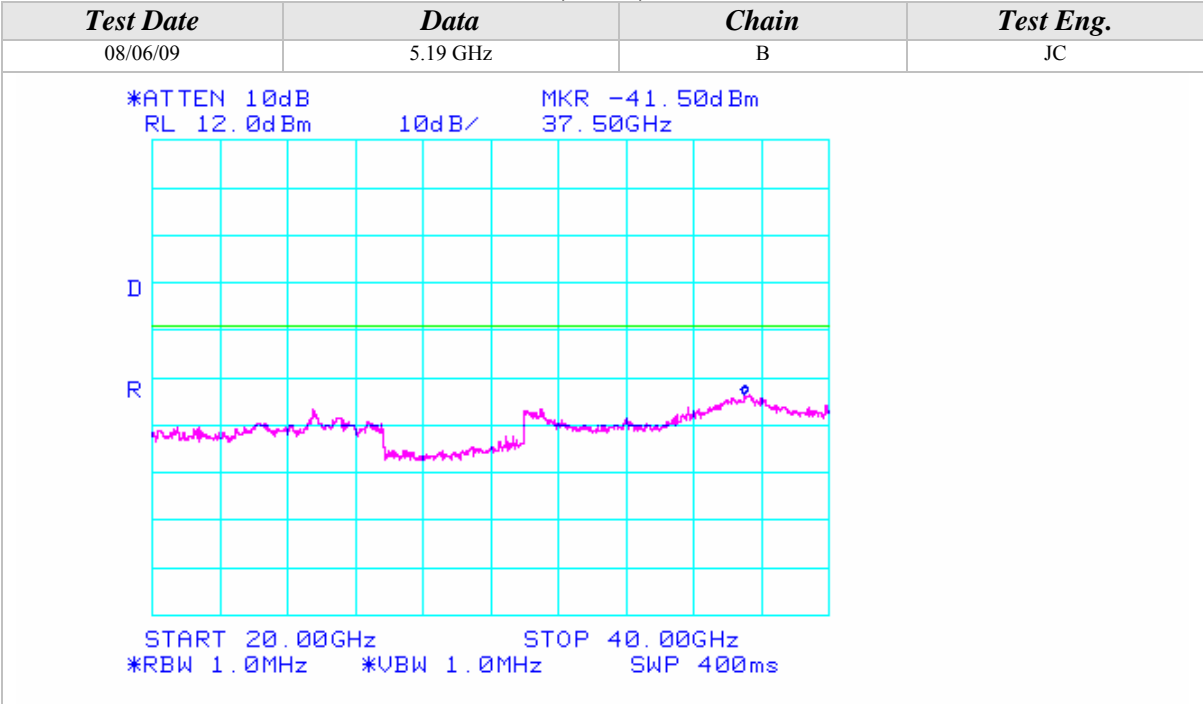



Conducted Out Of Band Emissions (Continued)

802.11n Mode, 5GHz, 40MHz Wide

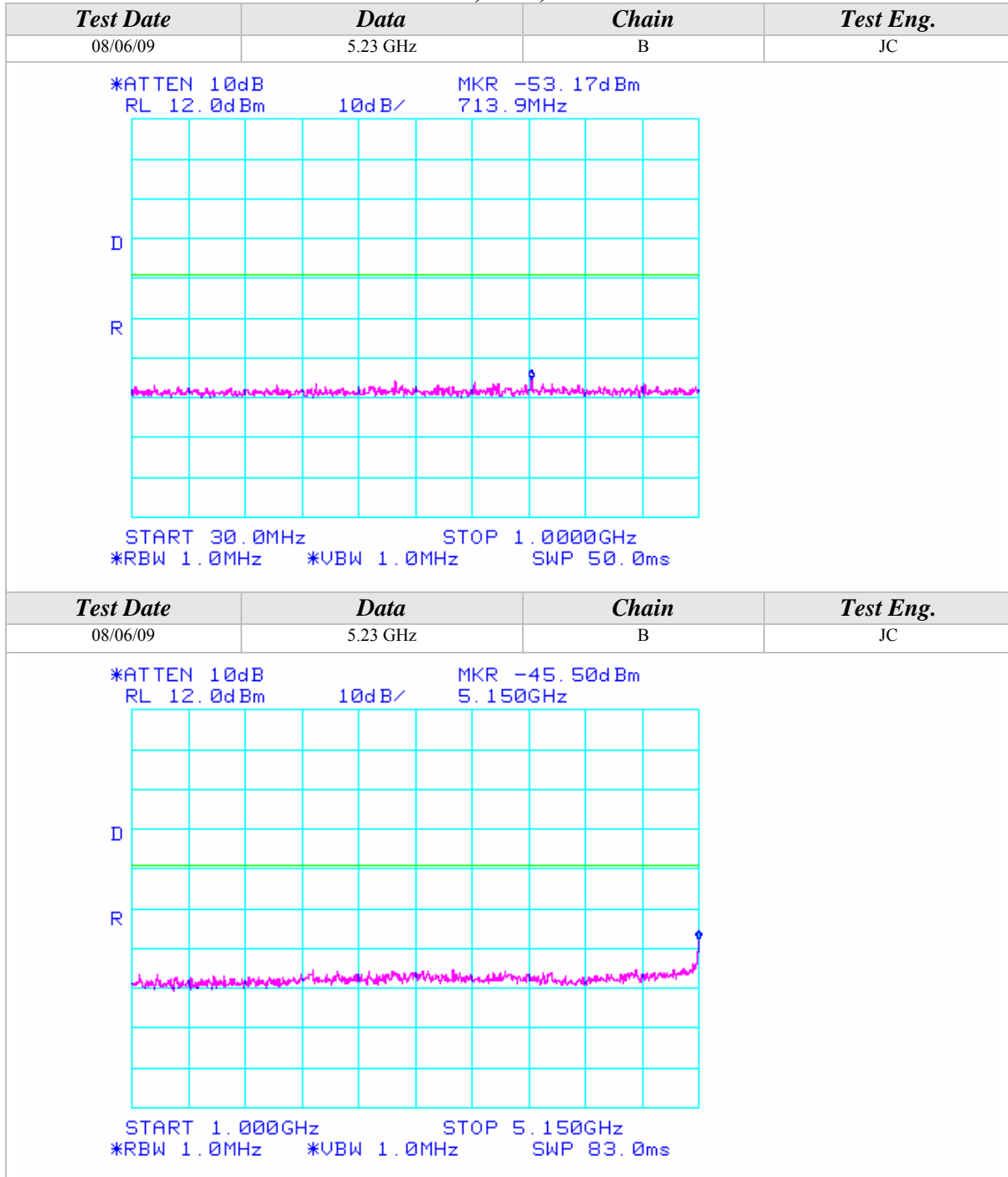



Conducted Out Of Band Emissions (Continued)

802.11n Mode, 5GHz, 40MHz Wide

Test Date	Data	Chain	Test Eng.
08/06/09	5.23 GHz	B	JC
<p>*ATTEN 10dB      MKR -49.17dBm RL 12.0dBm      10dB/      7.303GHz</p> <p>START 5.350GHz      STOP 10.000GHz *RBW 1.0MHz      *VBW 1.0MHz      SWP 93.0ms</p>			
Test Date	Data	Chain	Test Eng.
08/06/09	5.23 GHz	B	JC
<p>*ATTEN 10dB      MKR -40.83dBm RL 12.0dBm      10dB/      15.68GHz</p> <p>START 10.00GHz      STOP 20.00GHz *RBW 1.0MHz      *VBW 1.0MHz      SWP 200ms</p>			







## Conducted Out Of Band Emissions (Continued)

## 802.11n Mode, 5GHz, 40MHz Wide

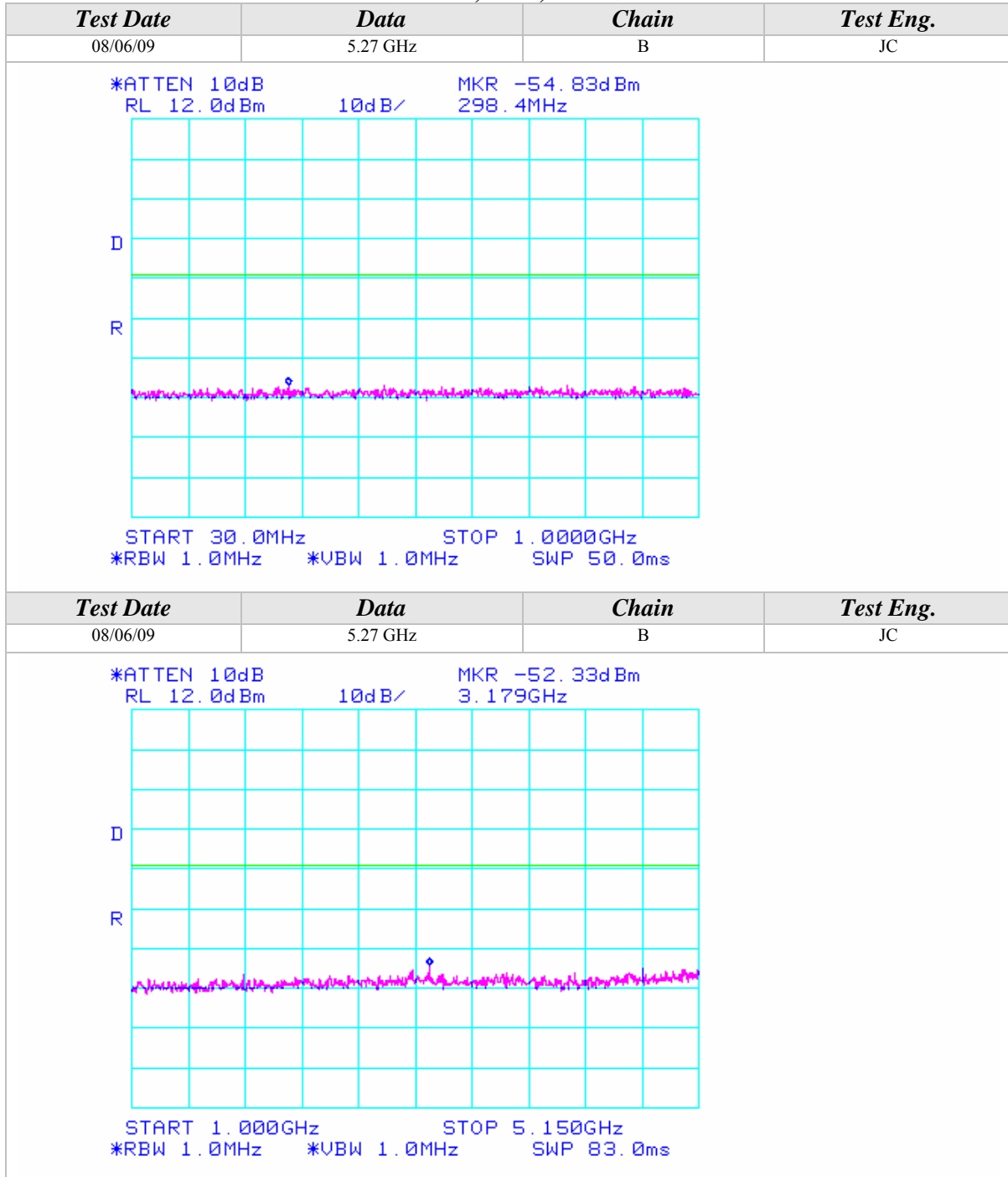

## Conducted Out Of Band Emissions (Continued)

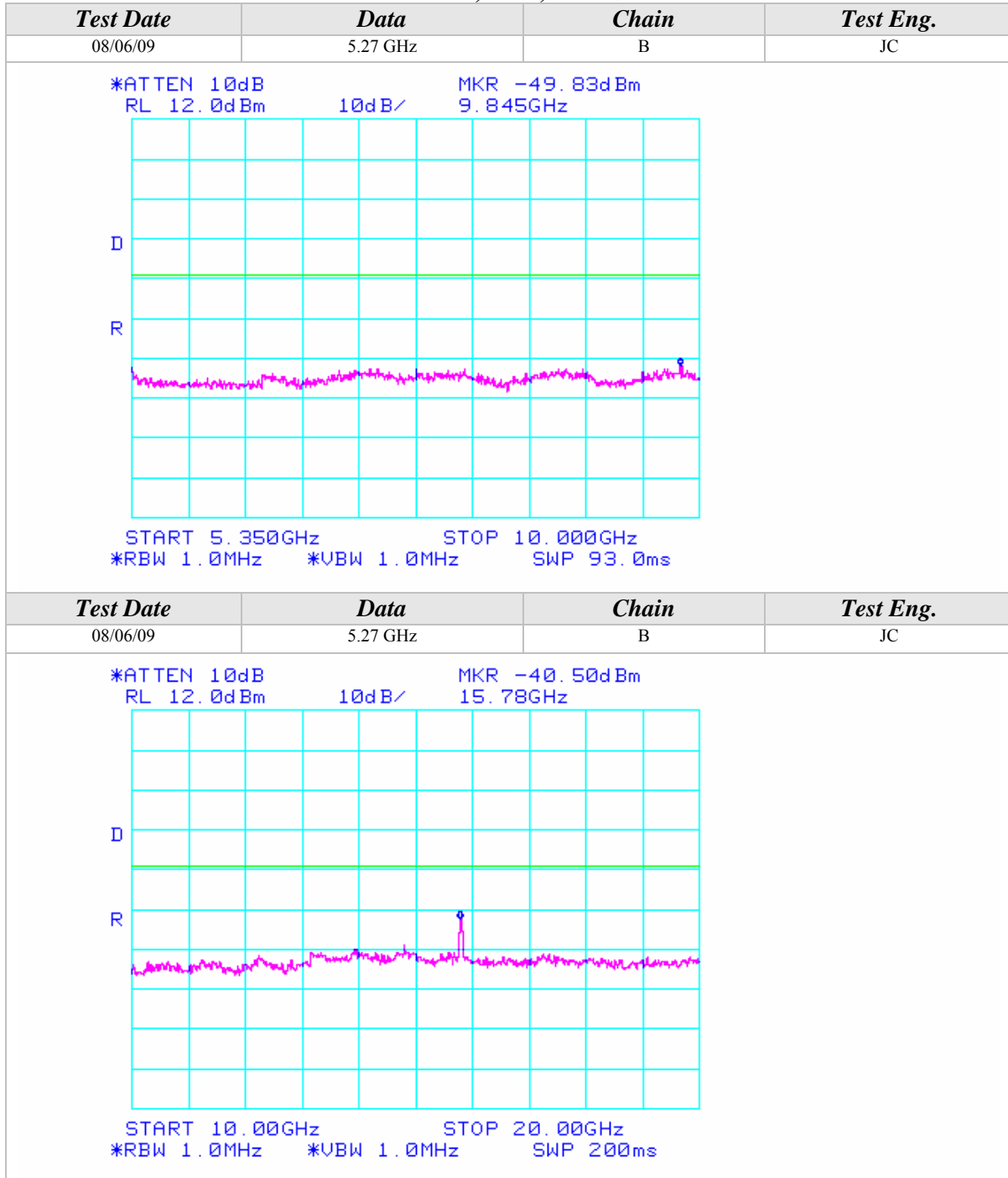
*802.11n Mode, 5GHz, 40MHz Wide*

## Conducted Out Of Band Emissions (Continued)

## 802.11n Mode, 5GHz, 40MHz Wide

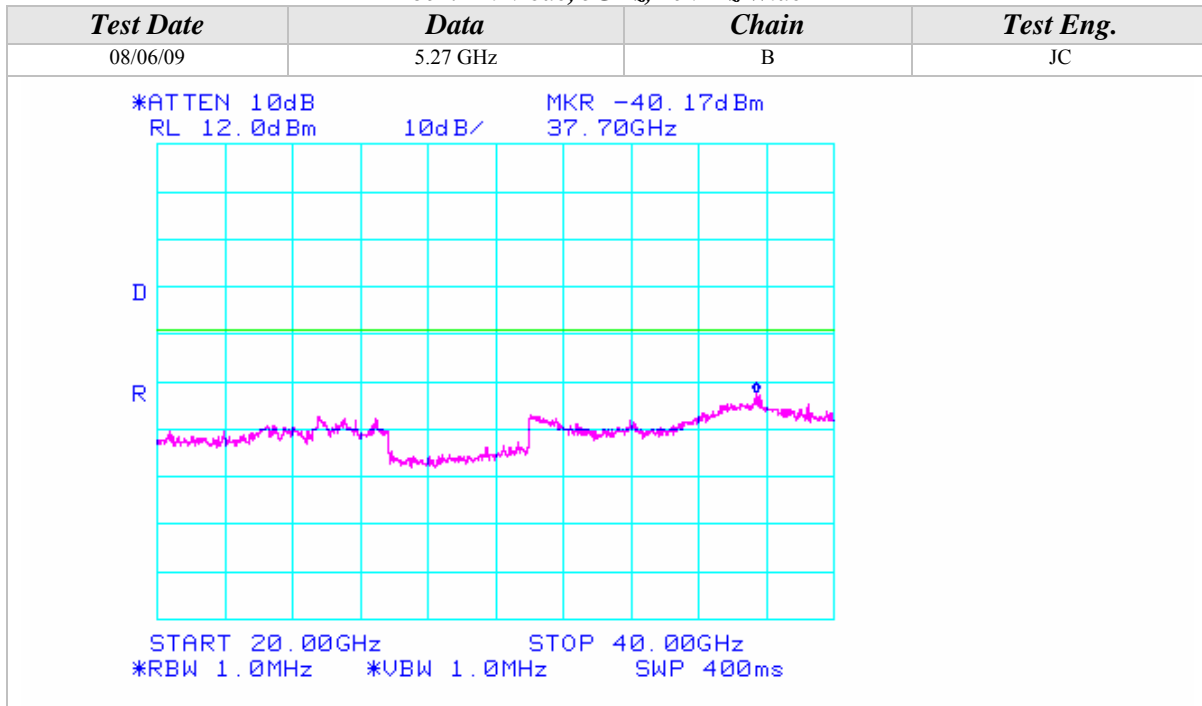



Conducted Out Of Band Emissions (Continued)

802.11n Mode, 5GHz, 40MHz Wide

Test Date	Data	Chain	Test Eng.
08/06/09	5.31 GHz	B	JC

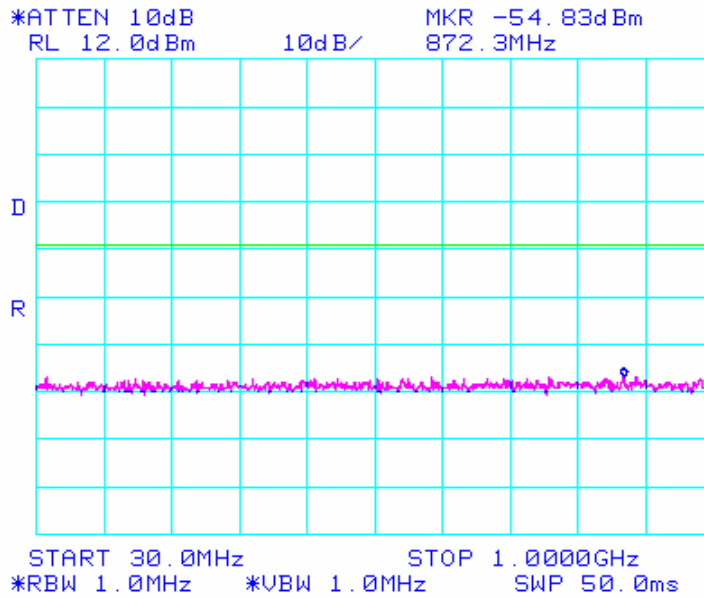

Test Date	Data	Chain	Test Eng.
08/06/09	5.31 GHz	B	JC

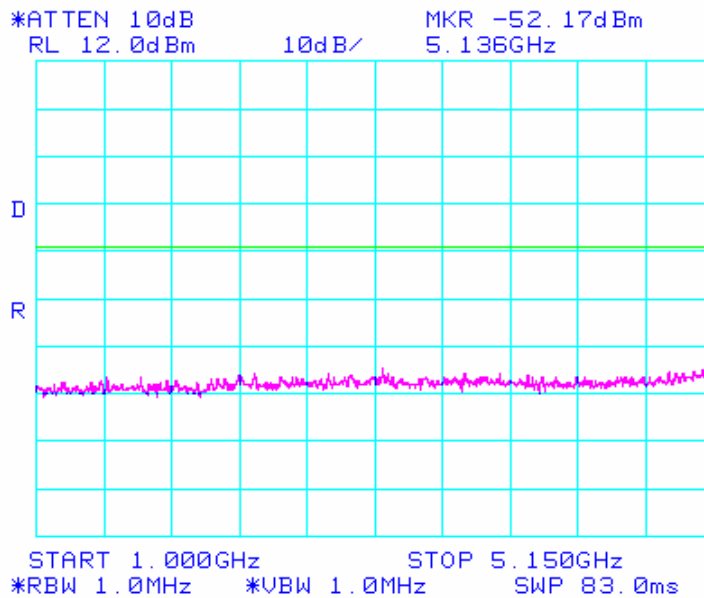



Conducted Out Of Band Emissions (Continued)

802.11n Mode, 5GHz, 40MHz Wide

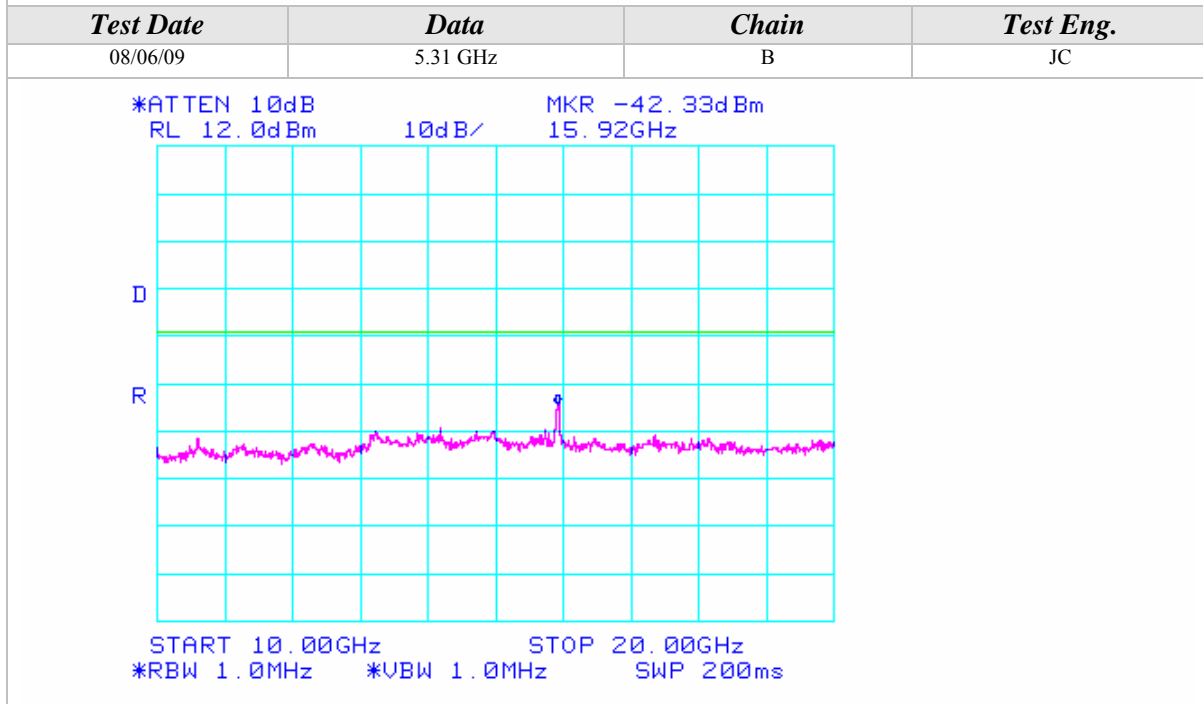
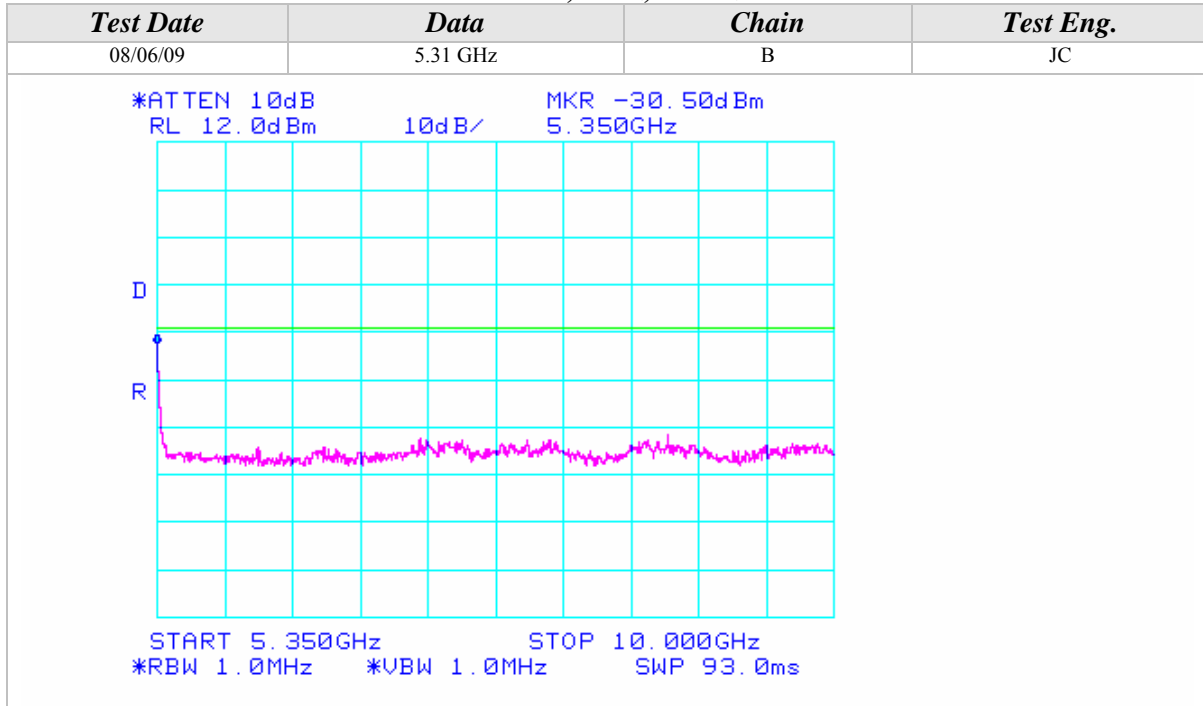





### Conducted Out Of Band Emissions (Continued)

#### 802.11n Mode, 5GHz, 40MHz Wide

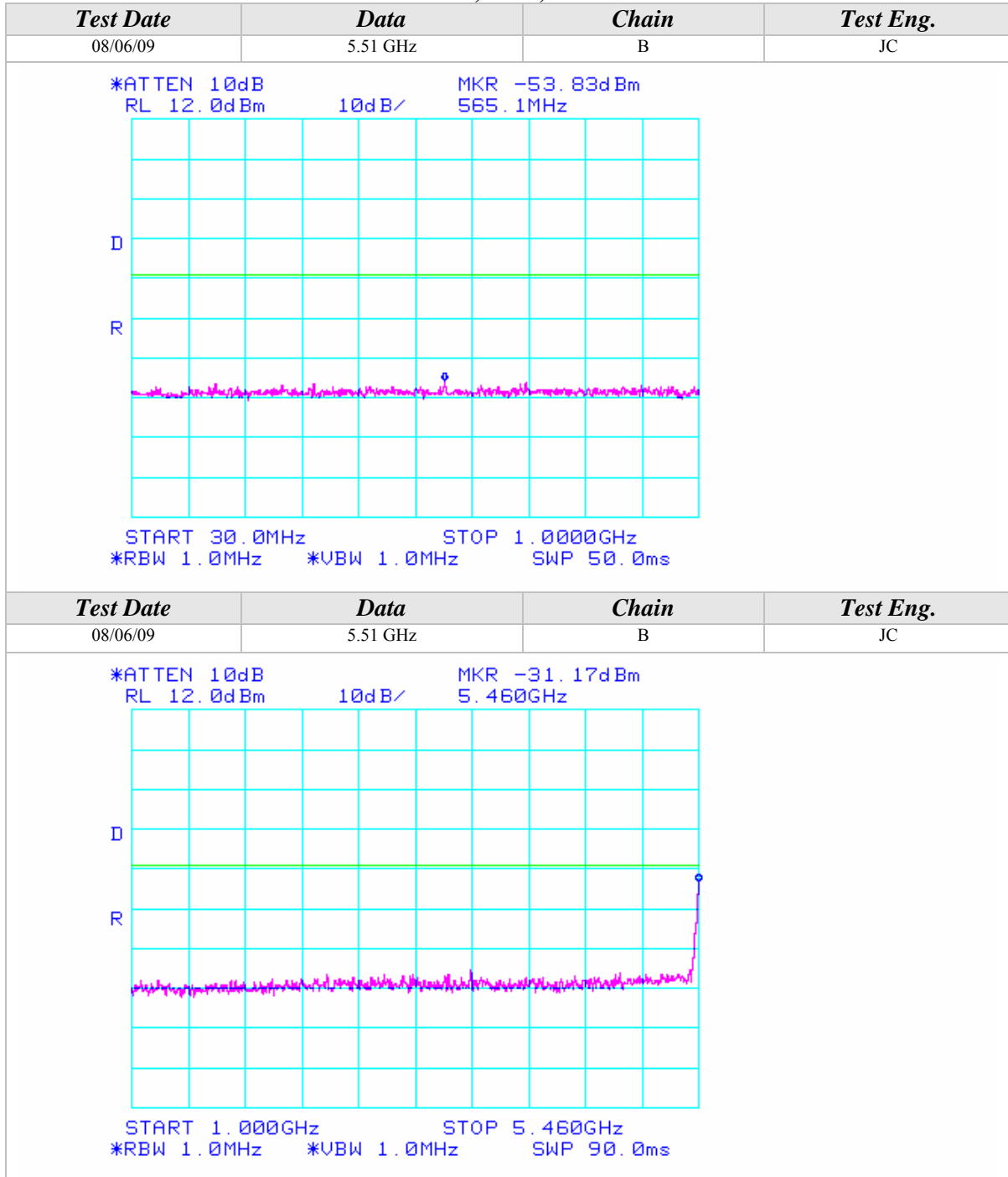



Conducted Out Of Band Emissions (Continued)

802.11n Mode, 5GHz, 40MHz Wide

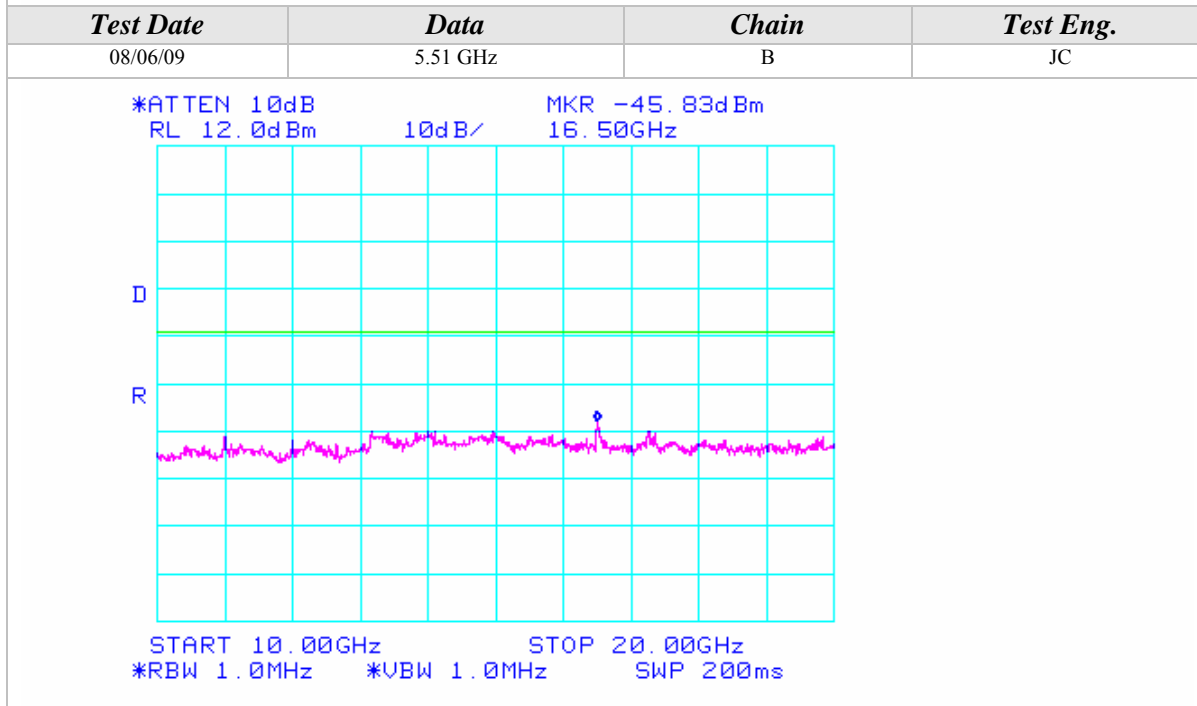
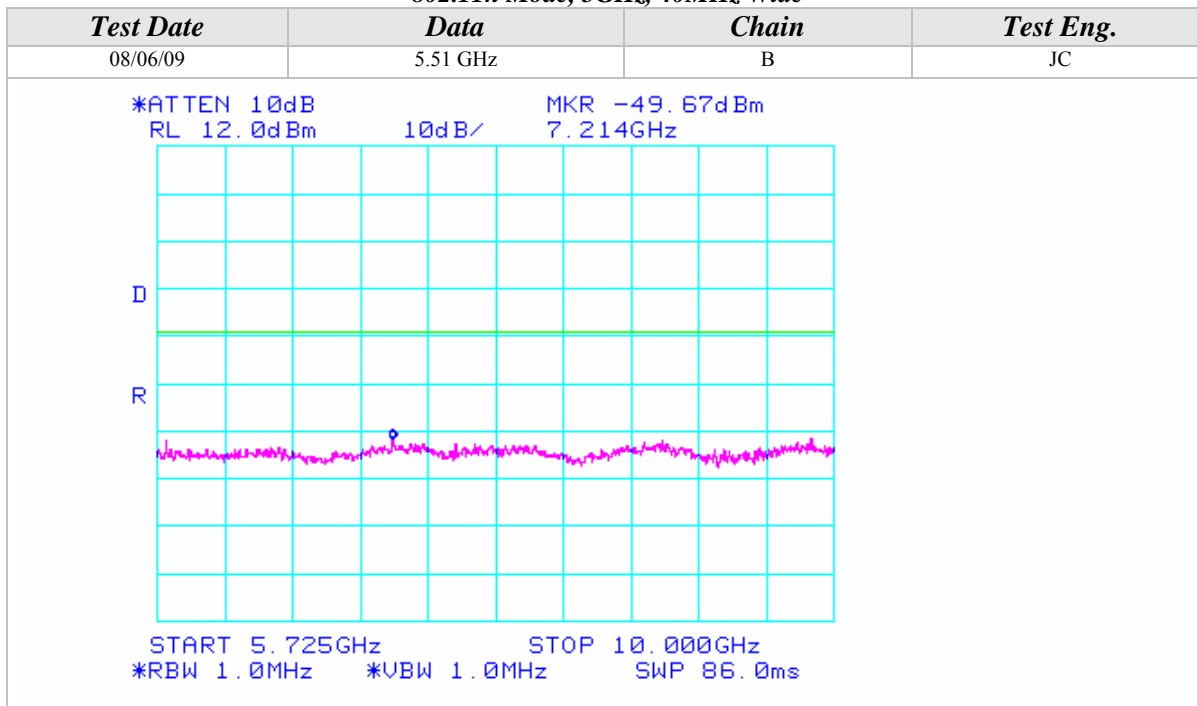





Conducted Out Of Band Emissions (Continued)

802.11n Mode, 5GHz, 40MHz Wide

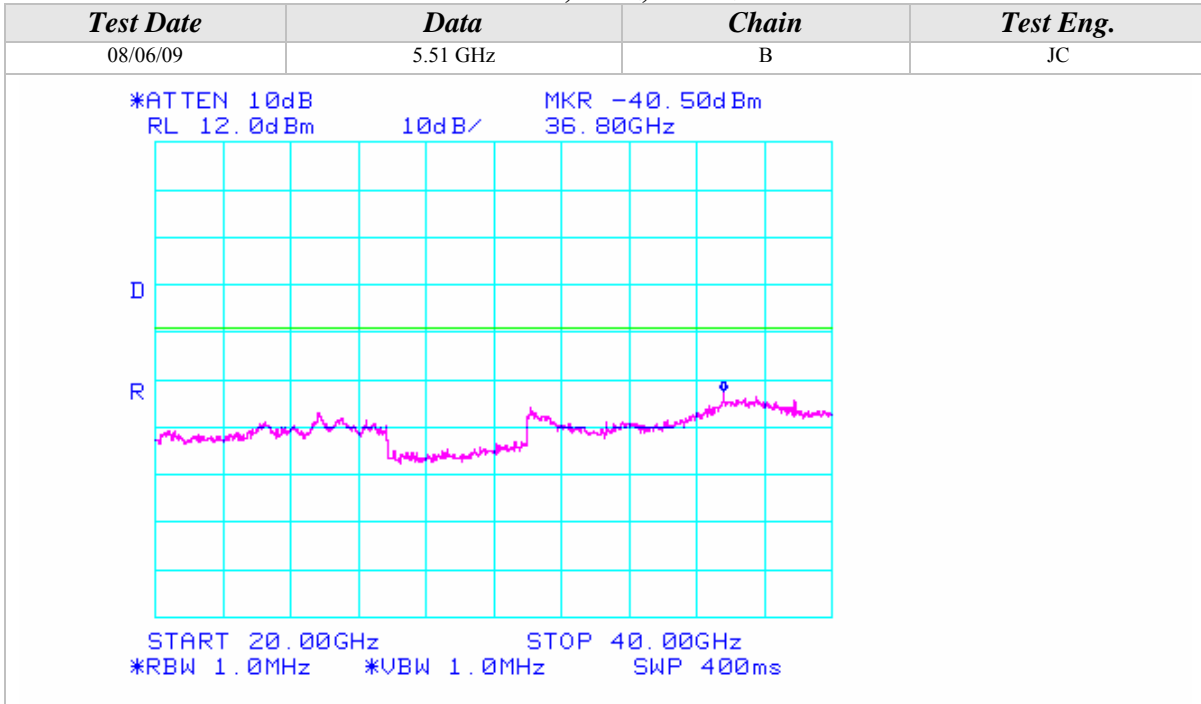



### Conducted Out Of Band Emissions (Continued)

#### 802.11n Mode, 5GHz, 40MHz Wide

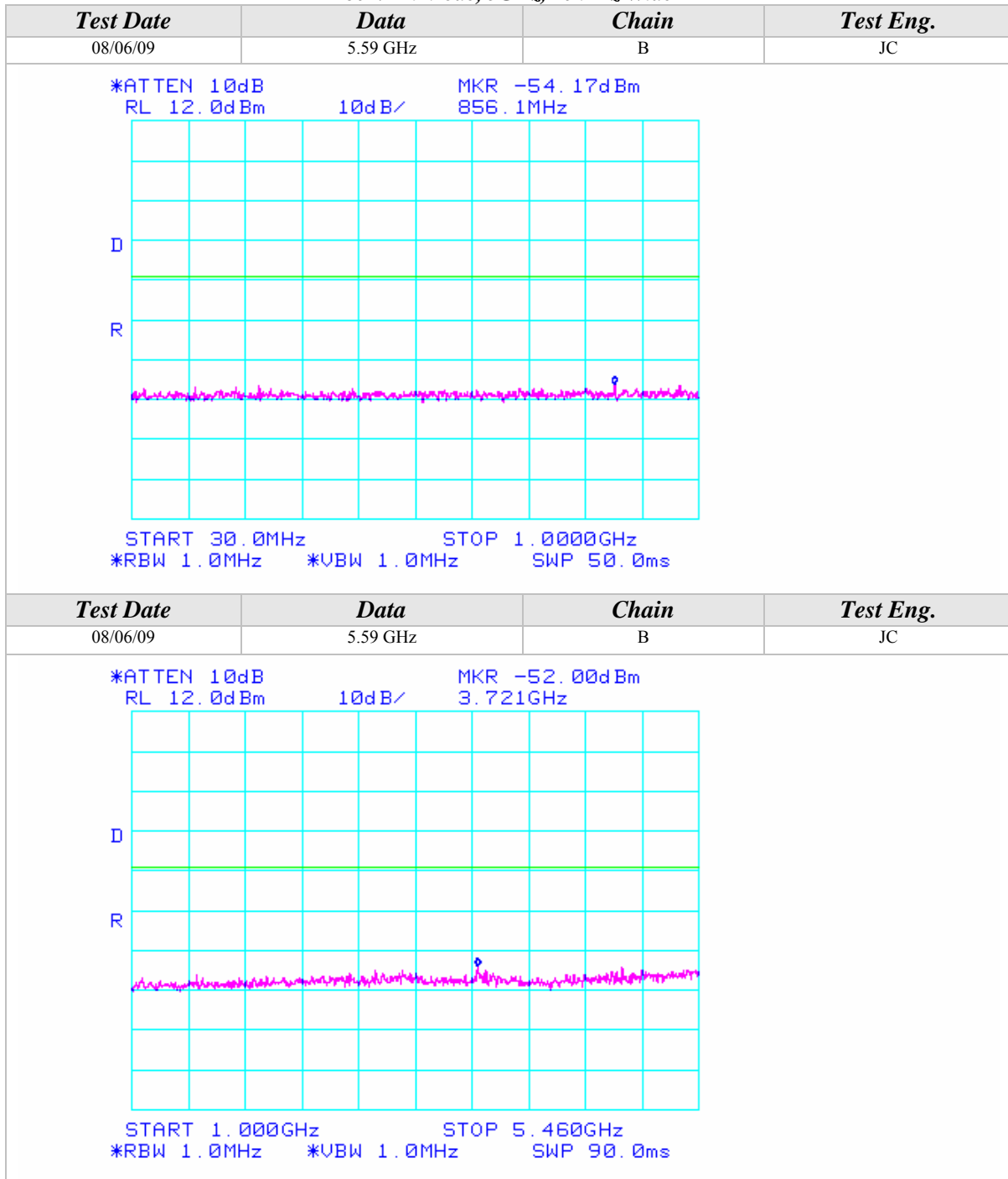



### Conducted Out Of Band Emissions (Continued)

#### 802.11n Mode, 5GHz, 40MHz Wide

Test Date	Data	Chain	Test Eng.
08/06/09	5.59 GHz	B	JC
<p>*ATTEN 10dB RL 12.0dBm      10dB/      MKR -49.67dBm    7.342GHz</p> <p>START 5.725GHz      STOP 10.000GHz *RBW 1.0MHz      *VBW 1.0MHz      SWP 86.0ms</p>			
Test Date	Data	Chain	Test Eng.
08/06/09	5.59 GHz	B	JC
<p>*ATTEN 10dB RL 12.0dBm      10dB/      MKR -47.83dBm    13.15GHz</p> <p>START 10.000GHz      STOP 20.000GHz *RBW 1.0MHz      *VBW 1.0MHz      SWP 200ms</p>			

Conducted Out Of Band Emissions (Continued)

802.11n Mode, 5GHz, 40MHz Wide

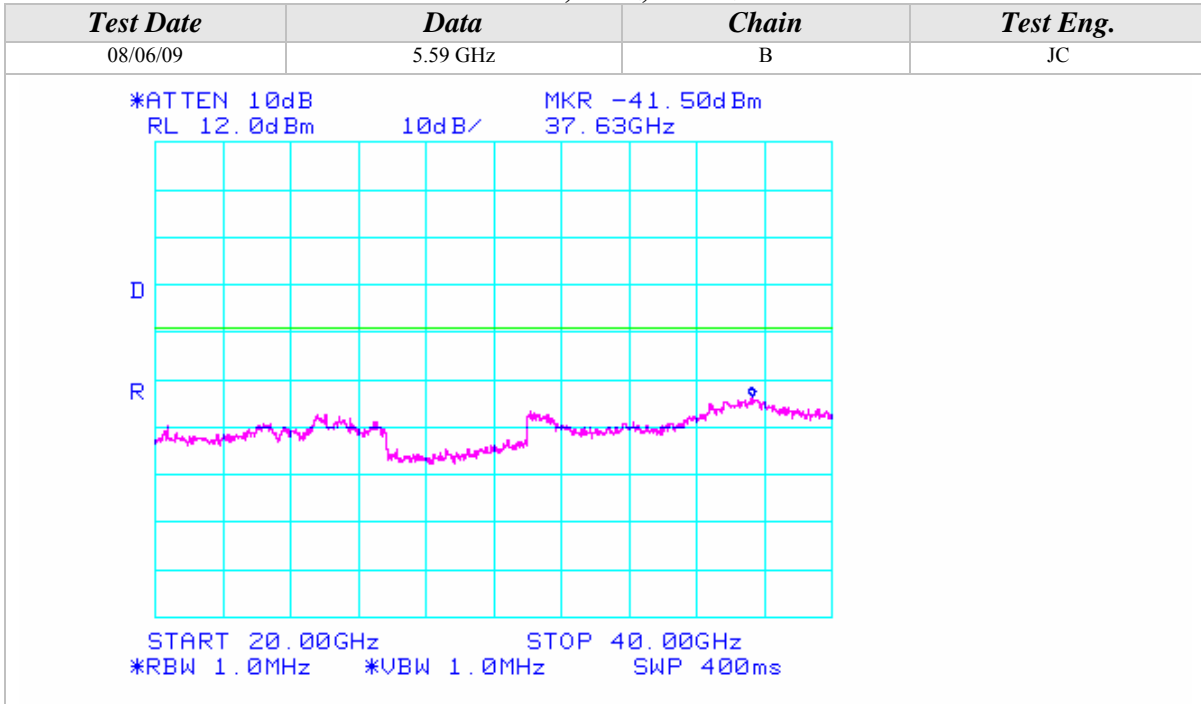



Conducted Out Of Band Emissions (Continued)

802.11n Mode, 5GHz, 40MHz Wide

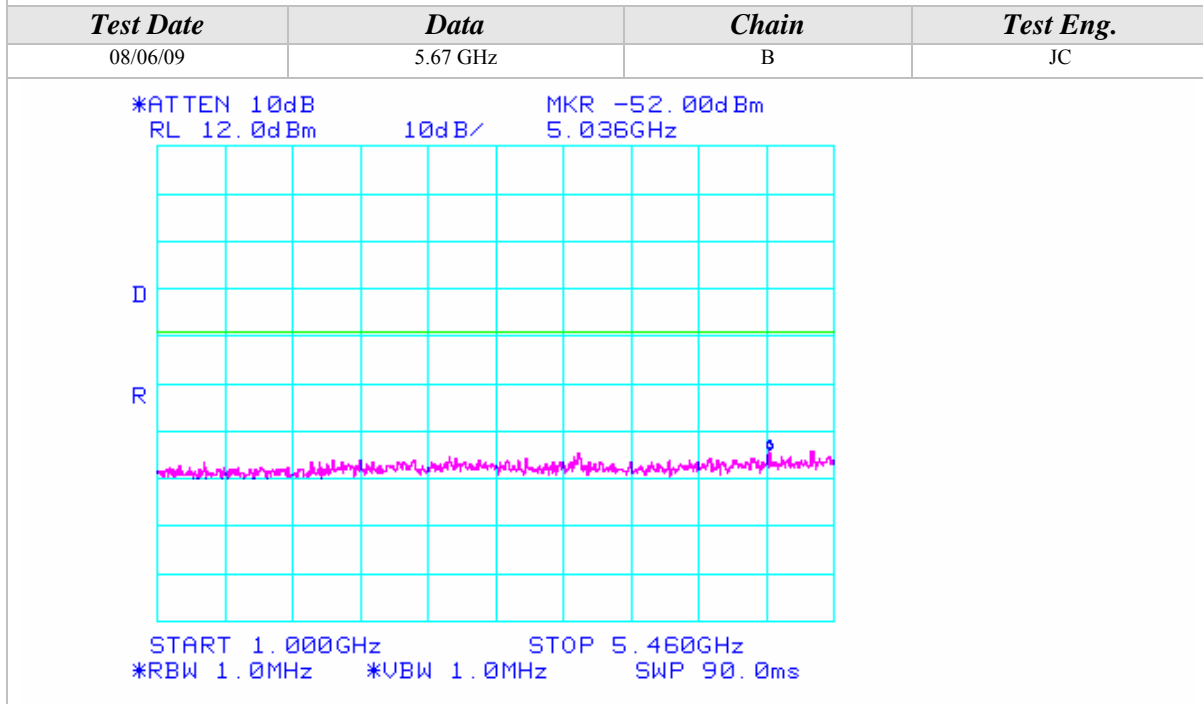
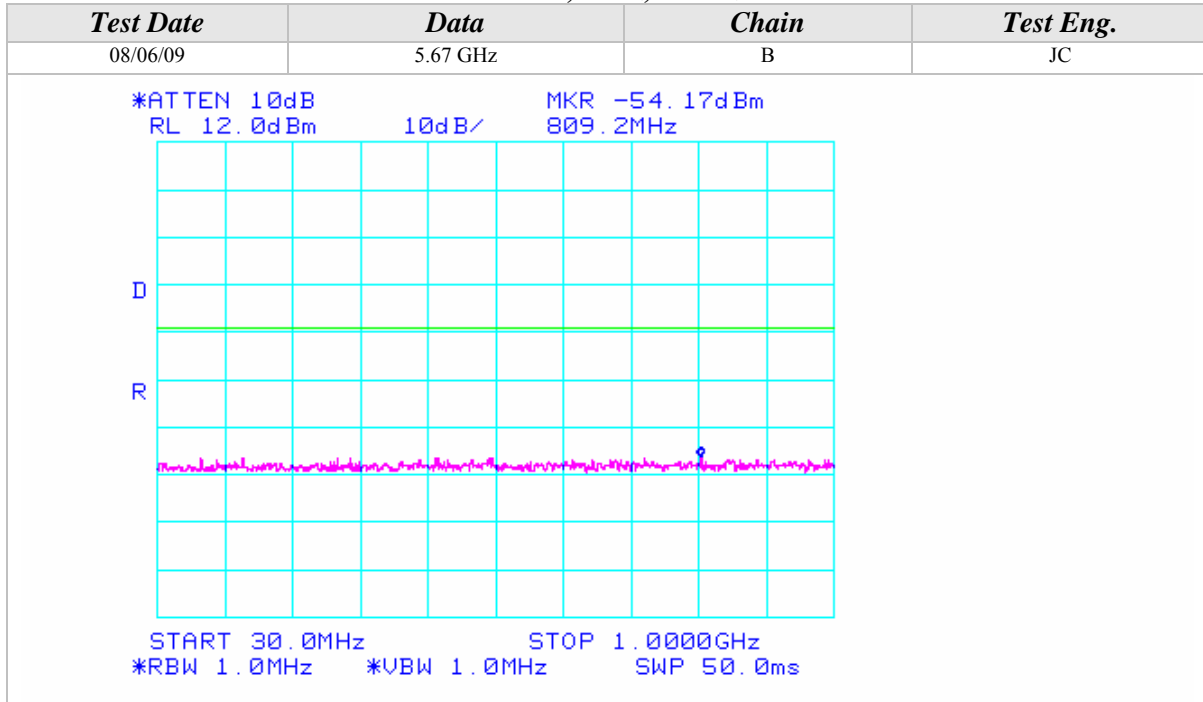



Conducted Out Of Band Emissions (Continued)

802.11n Mode, 5GHz, 40MHz Wide

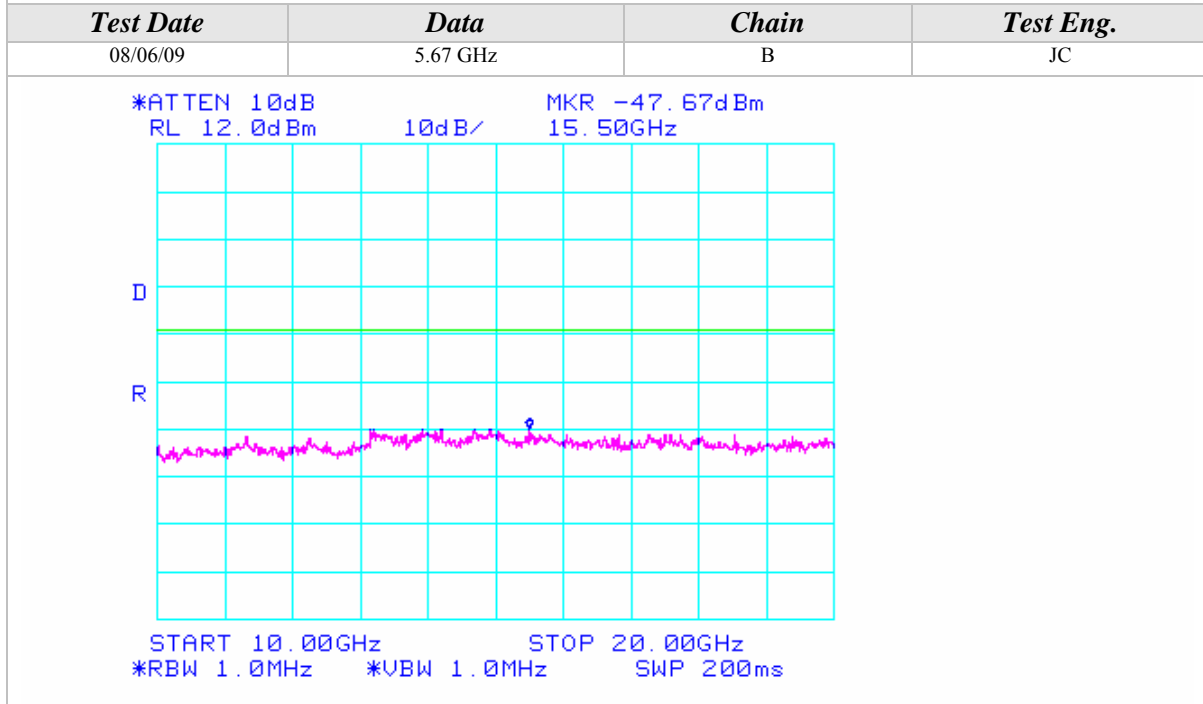
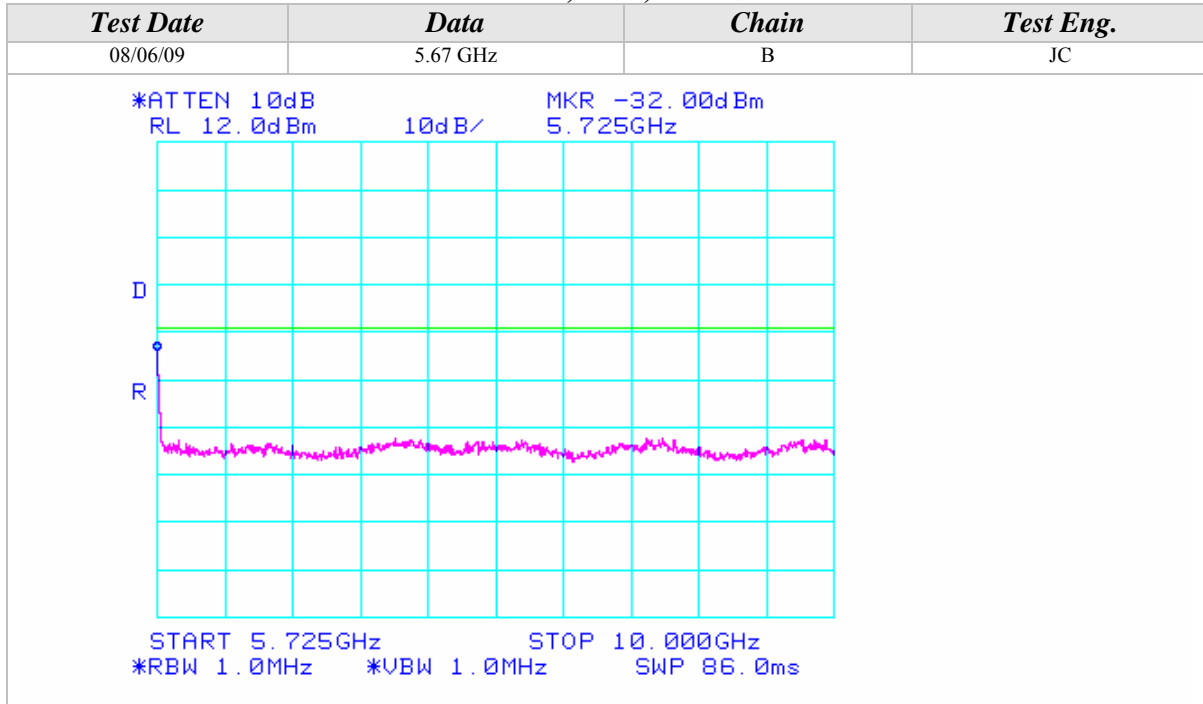



Conducted Out Of Band Emissions (Continued)

802.11n Mode, 5GHz, 40MHz Wide

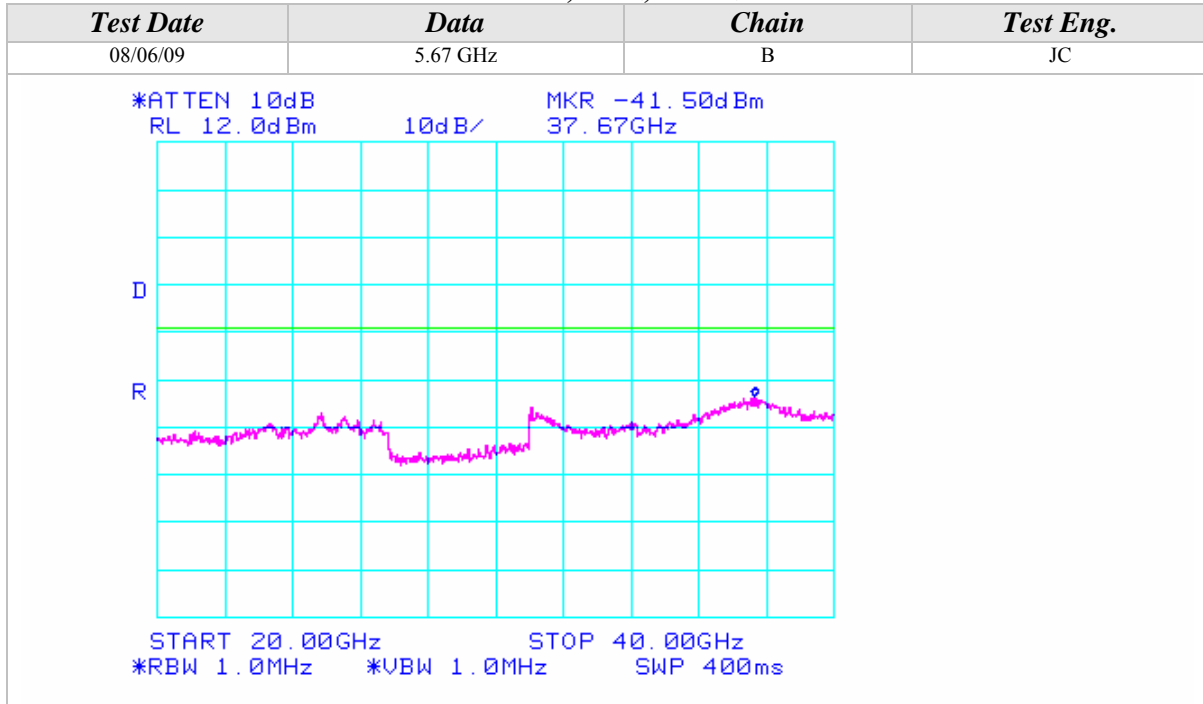



## APPENDIX B

### *MODIFICATIONS AND RECOMMENDATIONS*

<b>1.0</b>	NONE