



Inter**Lab**<sup>®</sup>

# FCC Measurement/Technical Report on GSM/UMTS module Siemens Cellular Engine HC25

**Report Reference:** MDE\_Siem\_0605\_FCCb

**Test Laboratory:**

7 layers AG  
Borsigstrasse 11  
40880 Ratingen  
Germany  
email: [info@7Layers.de](mailto:info@7Layers.de)



**Note:**

The following test results relate only to the devices specified in this document. This report shall not be reproduced in parts without the written approval of the testing laboratory.

7 layers AG  
Borsigstrasse 11  
40880 Ratingen, Germany  
Phone: +49 (0) 2102 749 0  
Fax: +49 (0) 2102 749 350  
[www.7Layers.com](http://www.7Layers.com)

*Aufsichtsratsvorsitzender •  
Chairman of the Supervisory Board:*  
Markus Becker  
*Vorstand • Board:*  
Dr. Hans-Jürgen Meckelburg  
René Schildknecht

*Registergericht • registered in:*  
Düsseldorf, HRB 44096  
*USt-IdNr • VAT Nr:*  
DE 203159652



## Table of Contents

<b>0</b>	<b>Summary</b>	<b>3</b>
0.1	Technical Report Summary	3
0.2	Measurement Summary	4
<b>1</b>	<b>Administrative Data</b>	<b>6</b>
1.1	Testing Laboratory	6
1.2	Project Data	6
1.3	Applicant Data	6
1.4	Manufacturer Data	6
<b>2</b>	<b>Testobject Data</b>	<b>7</b>
2.1	General EUT Description	7
2.2	EUT Main components	8
2.3	Ancillary Equipment	8
2.4	EUT Setups	8
2.5	Operating Modes	9
<b>3</b>	<b>Test Results</b>	<b>10</b>
3.1	RF Power Output	10
3.2	Frequency stability	14
3.3	Spurious emissions at antenna terminals	20
3.4	Field strength of spurious radiation	24
3.5	Emission and Occupied Bandwidth	28
3.6	Band edge compliance	32
<b>4</b>	<b>Test Equipment</b>	<b>35</b>
<b>5</b>	<b>Photo Report</b>	<b>38</b>
<b>6</b>	<b>Setup Drawings</b>	<b>42</b>
<b>7</b>	<b>Annex</b>	<b>44</b>
	Measurement Plots	



## **0 Summary**

### **0.1 Technical Report Summary**

#### **Type of Authorization**

Certification for a GSM cellular radiotelephone device

#### **Applicable FCC Rules**

Prepared in accordance with the requirements of FCC Rules and Regulations as listed in 47 CFR Ch.1 Parts 0 to 19 and Parts 20 to 69 (10-1-06 Edition). The following subparts are applicable to the results in this test report.

##### Part 2

Subpart J - Equipment Authorization Procedures, Certification

- § 2.1046 Measurement required: RF power output
- § 2.1049 Measurement required: Occupied bandwidth
- § 2.1051 Measurement required: Spurious emissions at antenna terminals
- § 2.1053 Measurement required: Field strength of spurious radiation
- § 2.1055 Measurement required: Frequency stability
- § 2.1057 Frequency spectrum to be investigated

##### Part 22

Subpart C – Operational and Technical Requirements

- § 22.355 Frequency tolerance

Subpart H – Cellular Radiotelephone Service

- § 22.913 Effective radiated power limits
- § 22.917 Emission limitations for cellular equipment

#### **Summary Test**

**The EUT complied with all performed tests as listed in chapter 0.2 Measurement Summary.**



## 0.2 Measurement Summary

---

### RF Power Output

The measurement was performed according to FCC §2.1046 10-1-06

<b>OP-Mode</b>	<b>Setup</b>	<b>Port</b>	<b>Final Result</b>
op-mode 1	setup_a01	antenna connector	passed
op-mode 2	setup_a01	antenna connector	passed
op-mode 3	setup_a01	antenna connector	passed
op-mode 4	setup_a01	antenna connector	passed
op-mode 5	setup_a01	antenna connector	passed
op-mode 6	setup_a01	antenna connector	passed
op-mode 7	setup_a01	antenna connector	passed
op-mode 8	setup_a01	antenna connector	passed
op-mode 9	setup_a01	antenna connector	passed

---

### Frequency stability

The measurement was performed according to FCC §2.1055 10-1-06

<b>OP-Mode</b>	<b>Setup</b>	<b>Port</b>	<b>Final Result</b>
op-mode 2	setup_a01	antenna connector	passed
op-mode 5	setup_a01	antenna connector	passed
op-mode 8	setup_a01	antenna connector	passed

---

### Spurious emissions at antenna terminals

The measurement was performed according to FCC §2.1051 10-1-06

<b>OP-Mode</b>	<b>Setup</b>	<b>Port</b>	<b>Final Result</b>
op-mode 1	setup_a01	antenna connector	passed
op-mode 2	setup_a01	antenna connector	passed
op-mode 3	setup_a01	antenna connector	passed
op-mode 4	setup_a01	antenna connector	passed
op-mode 5	setup_a01	antenna connector	passed
op-mode 6	setup_a01	antenna connector	passed
op-mode 7	setup_a01	antenna connector	passed
op-mode 8	setup_a01	antenna connector	passed
op-mode 9	setup_a01	antenna connector	passed

---

### Field strength of spurious radiation

The measurement was performed according to FCC §2.1053 10-1-06

<b>OP-Mode</b>	<b>Setup</b>	<b>Port</b>	<b>Final Result</b>
op-mode 1	setup_a02	enclosure	passed
op-mode 2	setup_a02	enclosure	passed
op-mode 3	setup_a02	enclosure	passed
op-mode 4	setup_a02	enclosure	passed
op-mode 5	setup_a02	enclosure	passed
op-mode 6	setup_a02	enclosure	passed
op-mode 7	setup_a02	enclosure	passed
op-mode 8	setup_a02	enclosure	passed
op-mode 9	setup_a02	enclosure	passed

---

**Emission and Occupied Bandwidth**

The measurement was performed according to FCC §2.1049 10-1-06

OP-Mode	Setup	Port	Final Result
op-mode 1	setup_a01	antenna connector	passed
op-mode 2	setup_a01	antenna connector	passed
op-mode 3	setup_a01	antenna connector	passed
op-mode 4	setup_a01	antenna connector	passed
op-mode 5	setup_a01	antenna connector	passed
op-mode 6	setup_a01	antenna connector	passed
op-mode 7	setup_a01	antenna connector	passed
op-mode 8	setup_a01	antenna connector	passed
op-mode 9	setup_a01	antenna connector	passed

---

**Band edge compliance**

The measurement was performed according to FCC §2.1053 10-1-06

OP-Mode	Setup	Port	Final Result
op-mode 1	setup_a01	antenna connector	passed
op-mode 3	setup_a01	antenna connector	passed
op-mode 4	setup_a01	antenna connector	passed
op-mode 6	setup_a01	antenna connector	passed
op-mode 7	setup_a01	antenna connector	passed
op-mode 9	setup_a01	antenna connector	passed



7 layers AG, Borsigstr. 11  
40880 Ratingen, Germany  
Phone +49 (0)2102 749 0

Responsible for  
Accreditation Scope:



Responsible  
for Test Report:





## 1 Administrative Data

### 1.1 Testing Laboratory

Company Name: 7 Layers AG  
Address Borsigstr. 11  
40880 Ratingen  
Germany

This facility has been fully described in a report submitted to the FCC and accepted under the registration number 96716 .

The test facility is also accredited by the following accreditation organisation:  
- Deutscher Akkreditierungs Rat DAR-Registration no. DAT-P-192/99-01

Responsible for Accreditation Scope: Dipl.-Ing. Bernhard Retka  
Dipl.-Ing. Robert Machulec  
Dipl.-Ing. Thomas Hoell

Report Template Version: 2006-12-18

### 1.2 Project Data

Responsible for testing and report: Dipl.-Ing. Andreas Petz  
Date of Test(s): 2007-02-09 to 2007-03-02  
Date of Report: 2007-03-15

### 1.3 Applicant Data

Company Name: Siemens AG  
Address: Siemensdamm 50  
13629 Berlin  
Germany  
Contact Person: Mr. Hussein Halawi

### 1.4 Manufacturer Data

Company Name: please see applicant data  
Address:  
Contact Person:



## 2 Testobject Data

### 2.1 General EUT Description

<b>Equipment under Test:</b>	GSM/UMTS module
<b>Type Designation:</b>	Siemens Cellular Engine HC25
<b>Kind of Device:</b>	GSM 850/900/1800/1900 + UMTS FDD I/II/V
<b>(optional)</b>	module
<b>Voltage Type:</b>	DC
<b>Nominal Voltage:</b>	4.2 V
<b>Maximum Voltage:</b>	4.2 V
<b>Minimum Voltage:</b>	3.2 V

#### General product description:

The Equipment Under Test (EUT) is a GSM 850/900/1800/1900 module and supports EDGE and FDD I/II/V.

The manufacturer declared that nominal voltage is equal to maximum voltage.

In GSM 850 mode the EUT operates in channel blocks A and B from 824.2 MHz (lowest channel = 128) to 848.8 MHz (highest channel = 251).

In FDD V mode the EUT operates in channel blocks A and B from 826.4 MHz (lowest channel = 4132) to 846.6 MHz (highest channel = 4233).

#### The EUT provides the following ports:

##### Ports

antenna connector  
enclosure

**The main components of the EUT are listed and described in Chapter 2.2**



## 2.2 EUT Main components

### Type, S/N, Short Descriptions etc. used in this Test Report

Short Description	Equipment under Test	Type Designation	Serial No.	HW Status	SW Status	Date of Receipt
EUT A (Code: 01900AO12)	GSM/UMTS module	Siemens Cellular Engine HC25	008933	B1.4	rev. 00.150	2007-01-12
Remark: EUT A is equipped with an antenna connector. It is used for conducted tests.						
EUT B (Code: 01900AP13)	GSM/UMTS module	Siemens Cellular Engine HC25	008970	B1.4	rev. 00.152	2007-01-15
Remark: EUT B is equipped with an antenna connector. It is used for radiated tests.						

**NOTE: The short description is used to simplify the identification of the EUT in this test report.**

## 2.3 Ancillary Equipment

For the purposes of this test report, ancillary equipment is defined as equipment which is used in conjunction with the EUT to provide operational and control features to the EUT. It is necessary to configure the system in a typical fashion, as a customer would normally use it. But nevertheless Ancillary Equipment can influence the test results.

Short Description	Equipment under Test	Type Designation	HW Status	SW Status	Serial no.	FCC ID
AE_1	External antenna Allgon-MiniMAG	Dualband Antenna Ordering number: 1140.26	-	-	-	-
Remark: The antenna gain is declared by the applicant as: 1.65 dBi = -0.49 dBD.						
AE_2	Development Board DSB3	DSB75	DSB75_B1.1	-	GBI: ICM-100012-03	-
AE_3	Adapter Board	Quinn DSB75 Adapter A1	-	-	Q_DSB75_A1_344	-
AE_4	Housing for DSB75	-	-	-	DSB75_B1 0009	-

## 2.4 EUT Setups

This chapter describes the combination of EUT's and ancillary equipment used for testing.

Setup No.	Combination of EUTs	Description
setup_a01	EUT A + AE_2 + AE_3	setup for conducted tests
setup_a02	EUT B + AE_1 + AE_2 + AE_3 + AE_4	setup for radiated spurious emissions tests





## 2.5 Operating Modes

This chapter describes the operating modes of the EUT's used for testing.

Op. Mode	Description of Operating Modes	Remarks
<b>PCS data call</b>		
op-mode 1	Call established on Traffic Channel (TCH) 128, Carrier Frequency 824.2 MHz	128 is the lowest channel PCS data call
op-mode 2	Call established on Traffic Channel (TCH) 190, Carrier Frequency 836.6 MHz	190 is a mid channel PCS data call
op-mode 3	Call established on Traffic Channel (TCH) 251, Carrier Frequency 848.8 MHz	251 is the highest channel PCS data call
<b>EDGE data call</b>		
op-mode 4	Call established on Traffic Channel (TCH) 128, Carrier Frequency 824.2 MHz	128 is the lowest channel EDGE data call
op-mode 5	Call established on Traffic Channel (TCH) 190, Carrier Frequency 836.6 MHz	190 is a mid channel EDGE data call
op-mode 6	Call established on Traffic Channel (TCH) 251, Carrier Frequency 848.8 MHz	251 is the highest channel EDGE data call
<b>FDD V data call</b>		
op-mode 7	Call established on Traffic Channel (TCH) 4132, Carrier Frequency 826.4 MHz	4132 is the lowest channel FDD V data call
op-mode 8	Call established on Traffic Channel (TCH) 4183, Carrier Frequency 836.6 MHz	4183 is a mid channel FDD V data call
op-mode 9	Call established on Traffic Channel (TCH) 4233, Carrier Frequency 846.6 MHz	4233 is the highest channel FDD V data call



## 3 Test Results

### 3.1 RF Power Output

**Standard** FCC Part 22, 10-1-06  
Subpart H

The test was performed according to: FCC §2.1046, 10-1-06

#### 3.1.1 Test Description

1) The EUT was coupled to the R&S Spectrum Analyser and the R&S CMU200 Digital Communication Tester through a Power Divider. Refer to chapter "Setup Drawings".

2) The total insertion losses for RF Path 1 and RF Path 2 were measured. The values were used to correct the readings from the R&S Spectrum Analyser and the R&S CMU200 Digital Communication Tester.

3) A call was established on a Traffic Channel (TCH) between the EUT and the base station simulator (R&S CMU200 Digital Communication Tester).

Important Settings:

- Discontinuous Transmission: OFF
- Modulation Signal: PSR16-1 (Pseudo Random Sequence)
- Output Power: Varied during measurements
- Channel (Frequency): Varied during measurements

4) The transmitted power of the EUT was recorded for all possible power control level by using an internal measurement function of the CMU200.

5) During this test the Spectrum Analyser was only used to check if the results are comprehensible.

#### 3.1.2 Test Requirements / Limits

§2.1046 Measurements Required: RF Power Output

(a) For transmitters other than single sideband, independent sideband and controlled carrier radiotelephone, power output shall be measured at the RF output terminals when the transmitter is adjusted in accordance with the tune-up procedure to give the values of current and voltage on the circuit elements specified in § 2.1033(c)(8). The electrical characteristics of the output terminals when this test is made shall be stated.

§22.913 Effective radiated power limits

(a) Maximum ERP. ... The ERP of mobile transmitters and auxiliary test transmitters must not exceed 7 Watts.



### 3.1.3 Test Protocol

Temperature: 23 °C  
 Air Pressure: 1006 hPa  
 Humidity: 40 %

Op. Mode	Setup	Port
op-mode 1	setup_a01	antenna connector

Power Control Level	Output power Nominal (dBm)	Output power Measured (dBm)	Difference dB
5	33	32.30	-0.70
6	31	30.70	-0.30
7	29	29.20	0.20
8	27	27.30	0.30
9	25	25.30	0.30
10	23	23.30	0.30
11	21	21.30	0.30
12	19	19.30	0.30
13	17	17.30	0.30
14	15	15.40	0.40
15	13	13.40	0.40
16	11	11.40	0.40
17	9	9.40	0.40
18	7	7.40	0.40
19	5	5.40	0.40

Remark: The ERP including antenna gain (-0.49 dBD) is 31.81 dBm.

Op. Mode	Setup	Port
op-mode 2	setup_a01	antenna connector

Power Control Level	Output power Nominal (dBm)	Output power Measured (dBm)	Difference dB
5	33	32.20	-0.80
6	31	30.70	-0.30
7	29	29.30	0.30
8	27	27.30	0.30
9	25	25.30	0.30
10	23	23.30	0.30
11	21	21.30	0.30
12	19	19.30	0.30
13	17	17.40	0.40
14	15	15.40	0.40
15	13	13.40	0.40
16	11	11.40	0.40
17	9	9.40	0.40
18	7	7.40	0.40
19	5	5.50	0.50

Remark: The ERP including antenna gain (-0.49 dBD) is 31.71 dBm.



**Op. Mode**      **Setup**                      **Port**  
op-mode 3      setup\_a01                      antenna connector

Power Control Level	Output power Nominal (dBm)	Output power Measured (dBm)	Difference dB
5	33	32.20	-0.80
6	31	30.70	-0.30
7	29	29.20	0.20
8	27	27.20	0.20
9	25	25.20	0.20
10	23	23.20	0.20
11	21	21.30	0.30
12	19	19.30	0.30
13	17	17.30	0.30
14	15	15.30	0.30
15	13	13.30	0.30
16	11	11.30	0.30
17	9	9.40	0.40
18	7	7.30	0.30
19	5	5.40	0.40

Remark: The ERP including antenna gain (-0.49 dBD) is 31.71 dBm.

**Op. Mode**      **Setup**                      **Port**  
op-mode 4      setup\_a01                      antenna connector

Power Control Level	Output power Nominal (dBm)	Output power Measured (dBm)	Difference dB
5	33	27.70	-5.30

Remark: The ERP including antenna gain (-0.49 dBD) is 27.21 dBm.

**Op. Mode**      **Setup**                      **Port**  
op-mode 5      setup\_a01                      antenna connector

Power Control Level	Output power Nominal (dBm)	Output power Measured (dBm)	Difference dB
5	33	27.60	-5.40

Remark: The ERP including antenna gain (-0.49 dBD) is 27.11 dBm.

**Op. Mode**      **Setup**                      **Port**  
op-mode 6      setup\_a01                      antenna connector

Power Control Level	Output power Nominal (dBm)	Output power Measured (dBm)	Difference dB
5	33	27.80	-5.20

Remark: The ERP including antenna gain (-0.49 dBD) is 27.31 dBm.



Op. Mode	Setup	Port
op-mode 7	setup_a01	antenna connector

Power Control Level	Output power Nominal (dBm)	Output power Measured (dBm)	Difference dB
5	33	26.90	-6.10

Remark: The ERP including antenna gain (-0.49 dBD) is 26.41 dBm.

Op. Mode	Setup	Port
op-mode 8	setup_a01	antenna connector

Power Control Level	Output power Nominal (dBm)	Output power Measured (dBm)	Difference dB
5	33	27.00	-6.00

Remark: The ERP including antenna gain (-0.49 dBD) is 26.51 dBm.

Op. Mode	Setup	Port
op-mode 9	setup_a01	antenna connector

Power Control Level	Output power Nominal (dBm)	Output power Measured (dBm)	Difference dB
5	33	26.90	-6.10

Remark: The ERP including antenna gain (-0.49 dBD) is 26.41 dBm.

### 3.1.4 Test result: RF Power Output

FCC Part 22, Subpart H	Op. Mode	Result
	op-mode 1	passed
	op-mode 2	passed
	op-mode 3	passed
	op-mode 4	passed
	op-mode 5	passed
	op-mode 6	passed
	op-mode 7	passed
	op-mode 8	passed
	op-mode 9	passed



## 3.2 Frequency stability

**Standard** FCC Part 22, 10-1-06  
Subpart H

**The test was performed according to** FCC §2.1055, 10-1-06

### 3.2.1 Test Description

- 1) The EUT was placed inside the climatic chamber.
- 2) The EUT was coupled to the R&S CMU200 Digital Communication Tester. Refer to chapter "Setup Drawings".
- 3) The climatic chamber was cycled down/up to a certain temperature, starting with  $-30^{\circ}\text{C}$ .
- 4) After the temperature was stabilized (at least one hour) the EUT was switched on and a call was established on a Traffic Channel (TCH) between the EUT and the base station simulator (R&S CMU200 Digital Communication Tester).  
Important Settings:
  - Discontinuous Transmission: OFF
  - Modulation Signal: PSR16-1 (Pseudo Random Sequence)
  - Output Power: Maximum
  - Mid Channel
- 5) The frequency error of the EUT were recorded by using an internal measurement function of the CMU200 immediately after the call was established, five minutes after the call was established and ten minutes after the call was established.
- 6) This measurement procedure was performed for all combinations of voltage (low, nominal, high) and temperature (from  $-30^{\circ}\text{C}$  to  $+50^{\circ}\text{C}$  in increments of  $10^{\circ}\text{C}$ ).

### 3.2.2 Test Requirements / Limits

§2.1055 Measurements required: Frequency stability

(a) The frequency stability shall be measured with variation of ambient temperature as follows:

(1) From  $-30^{\circ}$  to  $+50^{\circ}$  centigrade for all equipment except that specified in paragraphs (a) (2) and (3) of this section.

(b) Frequency measurements shall be made at the extremes of the specified temperature range and at intervals of not more than  $10^{\circ}$  centigrade through the range. A period of time sufficient to stabilize all of the components of the oscillator circuit at each temperature level shall be allowed prior to frequency measurement. The short term transient effects on the frequency of the transmitter due to keying (except for broadcast transmitters) and any heating element cycling normally occurring at each ambient temperature level also shall be shown. Only the portion or portions of the transmitter containing the frequency determining and stabilizing circuitry need be subjected to the temperature variation test.



(d) The frequency stability shall be measured with variation of primary supply voltage as follows:

- (1) Vary primary supply voltage from 85 to 115 percent of the nominal value for other than hand carried battery equipment.
- (2) For hand carried, battery powered equipment, reduce primary supply voltage to the battery operating end point which shall be specified by the manufacturer.
- (3) The supply voltage shall be measured at the input to the cable normally provided with the equipment, or at the power supply terminals if cables are not normally provided. Effects on frequency of transmitter keying (except for broadcast transmitters) and any heating element cycling at the nominal supply voltage and at each extreme also shall be shown.

§22.355 Frequency tolerance

...the carrier frequency of each transmitter in the Public Mobile Service must be maintained within the tolerances given in table C-1 of this section.

Table C-1.- Frequency Tolerance for Transmitters in the Public Mobile Services

Frequency range (ppm)	Base, fixed (ppm)	Mobile up to 3 watts (ppm)	Mobile above 3 watts (ppm)
25 to 50	20.0	20.0	50.0
50 to 450	5.0	5.0	50.0
450 to 512	2.5	5.0	5.0
821 to 896	1.5	<b>2.5</b>	2.5
928 to 929	5.0	n/a	n/a
929 to 960	1.5	n/a	n/a
2110 to 2220	10.0	n/a	n/a

For the mid channel (836.6 MHz) the frequency tolerance is 2.5 ppm (2091.5 Hz).

### 3.2.3 Test Protocol

Temperature: 21..24 °C  
 Air Pressure: 1010..1012 hPa  
 Humidity: 35..41 %

Op. Mode	Setup	Port
op-mode 2	setup_a01	antenna connector

		Normal Voltage / V	
		4.2	
Temp. °C	Duration min	Freq. error Average (Hz)	Freq. error Max. (Hz)
+50	0	3	6
+50	5	3	10
+50	10	15	19
+40	0	5	9
+40	5	14	17
+40	10	11	13
+30	0	-3	-5
+30	5	3	6
+30	10	-1	-4
+10	0	-4	-13
+10	5	-23	-28
+10	10	-19	-24
0	0	-12	-21
0	5	-16	-22
0	10	-17	-20
-10	0	-24	-30
-10	5	-15	-20
-10	10	-16	-22
-20	0	2	7
-20	5	-16	-27
-20	10	-15	-23
-30	0	7	11
-30	5	16	21
-30	10	14	20

Remark: none

		Minimum Voltage / V		Normal Voltage / V		Maximum Voltage / V	
		3.2		4.2		-	
Temp. °C	Duration min	Freq. error Average (Hz)	Freq. error Max. (Hz)	Freq. error Average (Hz)	Freq. error Max. (Hz)	Freq. error Average (Hz)	Freq. error Max. (Hz)
+20	0	-6	-9	-17	-20		
+20	5	7	11	-18	-23		
+20	10	-2	-5	-17	-21		

Remark: The manufacturer declared normal = maximum voltage.

		battery operating end point voltage / V	
		3.2	
Temp. °C	Duration min	Freq. error Average (Hz)	Freq. error Max. (Hz)
20	0	-6	-9
20	5	7	11
20	10	-2	-5

Remark: The battery operating end point is equal to Minimum Voltage.





**Op. Mode**      **Setup**      **Port**  
 op-mode 5      setup\_a01      antenna connector

		Normal Voltage / V	
		4.2	
Temp. °C	Duration min	Freq. error Average (Hz)	Freq. error Max. (Hz)
+50	0	13	19
+50	5	29	34
+50	10	31	37
+40	0	-32	-37
+40	5	28	34
+40	10	26	30
+30	0	-35	-43
+30	5	-25	-31
+30	10	-20	-26
+10	0	-6	-13
+10	5	-16	-24
+10	10	-27	-34
0	0	-37	-44
0	5	-36	-44
0	10	-28	-35
-10	0	16	22
-10	5	-34	-40
-10	10	-30	-36
-20	0	22	29
-20	5	32	40
-20	10	17	26
-30	0	-10	-21
-30	5	18	26
-30	10	4	10

Remark: none

		Minimum Voltage / V		Normal Voltage / V		Maximum Voltage / V	
		3.2		4.2		-	
Temp. °C	Duration min	Freq. error Average (Hz)	Freq. error Max. (Hz)	Freq. error Average (Hz)	Freq. error Max. (Hz)	Freq. error Average (Hz)	Freq. error Max. (Hz)
+20	0	-13	-19	-31	-36		
+20	5	-33	-39	-34	-41		
+20	10	-32	-37	-34	-41		

Remark: The manufacturer declared normal = maximum voltage.

		battery operating end point voltage / V	
		3.2	
Temp. °C	Duration min	Freq. error Average (Hz)	Freq. error Max. (Hz)
20	0	-13	-19
20	5	-33	-39
20	10	-32	-37

Remark: The battery operating end point is equal to Minimum Voltage.



**Op. Mode**      **Setup**      **Port**  
 op-mode 8      setup\_a01      antenna connector

		Normal Voltage / V	
		4.2	
Temp. °C	Duration min	Freq. error Average (Hz)	Freq. error Max. (Hz)
+50	0	0	-10
+50	5	-1	-14
+50	10	-1	-17
+40	0	-1	-13
+40	5	-1	12
+40	10	0	-15
+30	0	-1	-13
+30	5	-1	-14
+30	10	-1	15
+10	0	-2	-15
+10	5	-3	12
+10	10	-3	-19
0	0	-1	14
0	5	-1	-15
0	10	-2	-15
-10	0	-1	-20
-10	5	-1	-13
-10	10	-1	12
-20	0	-1	-15
-20	5	-1	-14
-20	10	0	-13
-30	0	0	-14
-30	5	-2	-16
-30	10	-2	14

Remark: none

		Minimum Voltage / V		Normal Voltage / V		Maximum Voltage / V	
		3.2		4.2		-	
Temp. °C	Duration min	Freq. error Average (Hz)	Freq. error Max. (Hz)	Freq. error Average (Hz)	Freq. error Max. (Hz)	Freq. error Average (Hz)	Freq. error Max. (Hz)
+20	0	0	13	-1	-12		
+20	5	-1	-17	0	-13		
+20	10	-1	-11	0	-13		

Remark: The manufacturer declared normal = maximum voltage.

		battery operating end point voltage / V	
		3.2	
Temp. °C	Duration min	Freq. error Average (Hz)	Freq. error Max. (Hz)
20	0	0	13
20	5	-1	-17
20	10	-1	-11

Remark: The battery operating end point is equal to Minimum Voltage.



### 3.2.4 Test result: Frequency stability

FCC Part 22, Subpart H	Op. Mode	Result
	op-mode 2	passed
	op-mode 5	passed
	op-mode 8	passed



### 3.3 Spurious emissions at antenna terminals

**Standard** FCC Part 22, 10-1-06  
Subpart H

**The test was performed according to** FCC §2.1051, 10-1-06

#### 3.3.1 Test Description

1) The EUT was coupled to the R&S Spectrum Analyser and the R&S CMU200 Digital Communication Tester through a Power Divider. Refer to chapter "Setup Drawings".

2) The total insertion losses for RF Path 1 and RF Path 2 were measured. The values were used to correct the readings from the R&S Spectrum Analyser and the R&S CMU200 Digital Communication Tester.

3) A call was established on a Traffic Channel (TCH) between the EUT and the base station simulator (R&S CMU200 Digital Communication Tester).

Important Settings:

- Discontinuous Transmission: OFF
- Modulation Signal: PSR16-1 (Pseudo Random Sequence)
- Output Power: Maximum
- Channel: Varied during measurements

4) Important Analyser Settings

- [Resolution Bandwidth / Video Bandwidth]:
  - a) [3 kHz / 10 kHz] in the Span of 1 MHz directly below and above the GSM-Band,
  - b) [10 kHz / 30 kHz] in case the curve of the analyser IF-Filter leads to an exceeding of the limit, in this case a worst case correction factor of 20 dB (1 MHz -> 10 kHz) was used
  - c) [1 MHz / 3 MHz] otherwise
- Sweep Time: Calculated by using a formula given in the Product Standard "GSM 11.10-1 edition 4" for spurious emissions measurements (depending on the transmitting signal, the span and the resolution bandwidth)

5) The spurious emissions (peak) were measured in the frequency range from 9 kHz to 10 GHz (up to the 10th harmonic) during the call is established on the lowest channel

#### 3.3.2 Test Requirements / Limits

§ 2.1051 Spurious emissions at antenna terminals

The radio frequency voltage or power generated within the equipment and appearing on a spurious frequency shall be checked at the equipment output terminals when properly loaded with a suitable artificial antenna. Curves or equivalent data shall show the magnitude of each harmonic and other spurious emission that can be detected when the equipment is operated under the conditions specified in Sec. 2.1049 as appropriate. The magnitude of spurious emissions which are attenuated more than 20 dB below the permissible value need not be specified.



§ 2.1057 Frequency spectrum to be investigated.

(a) In all of the measurements set forth in Secs. 2.1051 and 2.1053, the spectrum shall be investigated from the lowest radio frequency signal generated in the equipment, without going below 9 kHz, up to at least the frequency shown below:

(1) If the equipment operates below 10 GHz: to the tenth harmonic of the highest fundamental frequency or to 40 GHz, whichever is lower.

(b) Particular attention should be paid to harmonics and subharmonics of the carrier frequency as well as to those frequencies removed from the carrier by multiples of the oscillator frequency. Radiation at the frequencies of multiplier stages should also be checked.

(c) The amplitude of spurious emissions which are attenuated more than 20 dB below the permissible value need not be reported.

(d) Unless otherwise specified, measurements above 40 GHz shall be performed using a minimum resolution bandwidth of 1 MHz.

§ 22.917 Emission limitations for cellular equipment

(a) The power of any emission outside of the authorized operating frequency ranges must be attenuated below the transmitting power (P) by a factor of at least  $43 + 10 \log(P)$  dB.

Remark of the test laboratory: This is calculated to be -13 dBm.

(b) Compliance with these rules is based on the use of measurement instrumentation employing a resolution bandwidth of 100 kHz or greater. In the 1 MHz bands immediately outside and adjacent to the frequency block a resolution bandwidth of at least one percent of the emission bandwidth of the fundamental emission of the transmitter may be employed. A narrower resolution bandwidth is permitted in all cases to improve measurement accuracy provided the measured power is integrated over the full required measurement bandwidth (*i.e.* 100 kHz or 1 percent of emission bandwidth, as specified). The emission bandwidth is defined as the width of the signal between two points, one below the carrier center frequency and one above the carrier center frequency, outside of which all emissions are attenuated at least 26 dB below the transmitter power.

(c) Licensees in this service may establish an alternative out of band emission limit to be used at specified band edge(s) in specified geographical areas [...].

(d) If any emission from a transmitter operating in this service results in interference to users of another radio service, the FCC may require a greater attenuation of that emission than specified in this section.

### 3.3.3 Test Protocol

Temperature: 21 °C  
 Air Pressure: 1013 hPa  
 Humidity: 40 %

Op. Mode	Setup	Port
op-mode 1	setup_a01	antenna connector

Frequency MHz	Bandwidth kHz	Measured Level dBm	Limit dBm
824	3	-14.4	-13.0
2473	1000	-32.93	-13.0

Remark: No (further) spurious emissions were found in the range 20 dB below the limit.

Op. Mode	Setup	Port
op-mode 2	setup_a01	antenna connector

Frequency MHz	Bandwidth kHz	Measured Level dBm	Limit dBm
2511	1000	-32.99	-13.0

Remark: No (further) spurious emissions were found in the range 20 dB below the limit.

Op. Mode	Setup	Port
op-mode 3	setup_a01	antenna connector

Frequency MHz	Bandwidth kHz	Measured Level dBm	Limit dBm
849	3.0	-13.79	-13.0

Remark: No (further) spurious emissions were found in the range 20 dB below the limit.

Op. Mode	Setup	Port
op-mode 4	setup_a01	antenna connector

Frequency MHz	Bandwidth kHz	Measured Level dBm	Limit dBm
824	3.0	-22.56	-13.0

Remark: No (further) spurious emissions were found in the range 20 dB below the limit.

Op. Mode	Setup	Port
op-mode 5	setup_a01	antenna connector

Frequency MHz	Bandwidth kHz	Measured Level dBm	Limit dBm
2511	1000	-37.12	-13.0

Remark: No (further) spurious emissions were found in the range 20 dB below the limit.



Op. Mode	Setup	Port
op-mode 6	setup_a01	antenna connector

Frequency MHz	Bandwidth kHz	Measured Level dBm	Limit dBm
849	3.0	-20-93	-13.0

Remark: No (further) spurious emissions were found in the range 20 dB below the limit.

Op. Mode	Setup	Port
op-mode 7	setup_a01	antenna connector

Frequency MHz	Bandwidth kHz	Measured Level dBm	Limit dBm
-	-	-	-13.0

Remark: No (further) spurious emissions were found in the range 20 dB below the limit.

Op. Mode	Setup	Port
op-mode 8	setup_a01	antenna connector

Frequency MHz	Bandwidth kHz	Measured Level dBm	Limit dBm
-	-	-	-13.0

Remark: No (further) spurious emissions were found in the range 20 dB below the limit.

Op. Mode	Setup	Port
op-mode 9	setup_a01	antenna connector

Frequency MHz	Bandwidth kHz	Measured Level dBm	Limit dBm
-	-	-	-13.0

Remark: No (further) spurious emissions were found in the range 20 dB below the limit.

### 3.3.4 Test result: Spurious emissions at antenna terminals

FCC Part 22, Subpart H	Op. Mode	Result
	op-mode 1	passed
	op-mode 2	passed
	op-mode 3	passed
	op-mode 4	passed
	op-mode 5	passed
	op-mode 6	passed
	op-mode 7	passed
	op-mode 8	passed
	op-mode 9	passed

### 3.4 Field strength of spurious radiation

**Standard** FCC Part 22, 10-1-06  
Subpart H

The test was performed according to: FCC §2.1053, 10-1-06

#### 3.4.1 Test Description

1) The EUT was placed inside an anechoic chamber. Refer to chapter "Setup Drawings". The EUT was coupled to the R&S CMU200 Digital Communication Tester which was located outside the chamber via coaxial cable.

2) A call was established on a Traffic Channel (TCH) between the EUT and the base station simulator (R&S CMU200 Digital Communication Tester).

Important Settings:

- Discontinuous Transmission: OFF
- Modulation Signal: PSR16-1 (Pseudo Random Sequence)
- Output Power: Maximum
- Channel : Varied during measurements

3) A pre-calibration procedure is used so that the readings from the spectrum analyser are corrected and represent directly the equivalent radiated power (related to a  $\lambda/2$  dipole).

4) All spurious radiation measurements were made with spectrum analyser and the appropriate calibrated antennas for the frequency range of 30 MHz to 10 GHz (up to the 10th harmonic of the transmit frequency).

5) Important Analyser Settings

- [Resolution Bandwidth / Video Bandwidth]:

a) [3 kHz / 10 kHz] in the Span of 1 MHz directly below and above the GSM-Band,

b) [10 kHz / 30 kHz] in case the curve of the analyser IF-Filter leads to an exceeding of the limit, in this case a worst case correction factor of 20 dB (1 MHz -> 10 kHz) was used

c) [1 MHz / 3 MHz] otherwise

- Sweep Time: Calculated by using a formula given in the Product Standard "GSM 11.10-1 edition 4" for spurious emissions measurements (depending on the transmitting signal, the span and the resolution bandwidth)

6) The spurious emissions (peak) were measured in both vertical and horizontal antenna polarisation during the call is established on the lowest channel, mid channel and on the highest channel.

#### 3.4.2 Test Requirements / Limits

§ 2.1053 Measurements required: Field strength of spurious radiation.

Measurements shall be made to detect spurious emissions that may be radiated directly from the cabinet, control circuits, power leads, or intermediate circuit elements under normal conditions of installation and operation. Curves or equivalent data shall be supplied showing the magnitude of each harmonic and other spurious emission. For this test, single sideband, independent sideband, and controlled carrier transmitters shall be modulated under the conditions specified in paragraph (c) of Sec. 2.1049, as appropriate.



For equipment operating on frequencies below 890 MHz, an open field test is normally required, with the measuring instrument antenna located in the far-field at all test frequencies. In the event it is either impractical or impossible to make open field measurements (e.g. a broadcast transmitter installed in a building) measurements will be accepted of the equipment as installed. Such measurements must be accompanied by a description of the site where the measurements were made showing the location of any possible source of reflections which might distort the field strength measurements. Information submitted shall include the relative radiated power of each spurious emission with reference to the rated power output of the transmitter, assuming all emissions are radiated from halfwave dipole antennas.

(b) The measurements specified in paragraph (a) of this section shall be made for the following equipment:

(2) All equipment operating on frequencies higher than 25 MHz.

§ 2.1057 Frequency spectrum to be investigated.

(a) In all of the measurements set forth in Secs. 2.1051 and 2.1053, the spectrum shall be investigated from the lowest radio frequency signal generated in the equipment, without going below 9 kHz, up to at least the frequency shown below:

(1) If the equipment operates below 10 GHz: to the tenth harmonic of the highest fundamental frequency or to 40 GHz, whichever is lower.

(b) Particular attention should be paid to harmonics and subharmonics of the carrier frequency as well as to those frequencies removed from the carrier by multiples of the oscillator frequency. Radiation at the frequencies of multiplier stages should also be checked.

(c) The amplitude of spurious emissions which are attenuated more than 20 dB below the permissible value need not be reported.

(d) Unless otherwise specified, measurements above 40 GHz shall be performed using a minimum resolution bandwidth of 1 MHz.

§ 22.917 Emission limitations for cellular equipment

(a) The power of any emission outside of the authorized operating frequency ranges must be attenuated below the transmitting power (P) by a factor of at least  $43 + 10 \log(P)$  dB.

This is calculated to be -13 dBm (effective radiated power) which corresponds to 84.6 dB $\mu$ V/m (field strength) in a distance of 3 m.

(b) Compliance with these rules is based on the use of measurement instrumentation employing a resolution bandwidth of 100 kHz or greater. In the 1 MHz bands immediately outside and adjacent to the frequency block a resolution bandwidth of at least one percent of the emission bandwidth of the fundamental emission of the transmitter may be employed. A narrower resolution bandwidth is permitted in all cases to improve measurement accuracy provided the measured power is integrated over the full required measurement bandwidth (*i.e.* 100 kHz or 1 percent of emission bandwidth, as specified). The emission bandwidth is defined as the width of the signal between two points, one below the carrier center frequency and one above the carrier center frequency, outside of which all emissions are attenuated at least 26 dB below the transmitter power.

(c) Licensees in this service may establish an alternative out of band emission limit to be used at specified band edge(s) in specified geographical areas [...].

(d) If any emission from a transmitter operating in this service results in interference to users of another radio service, the FCC may require a greater attenuation of that emission than specified in this section.

### 3.4.3 Test Protocol

Temperature: 21..23 °C  
 Air Pressure: 989..1021 hPa  
 Humidity: 32..40 %

Op. Mode	Setup	Port
op-mode 1	setup_a02	enclosure

Frequency MHz	Antenna Polarisation	Bandwidth kHz	Measured Level dBm	Limit dBm
824	Vertical	3.0	-18.8	-13.0

Remark: No (further) spurious emissions were found in the range 20 dB below the limit.

Op. Mode	Setup	Port
op-mode 2	setup_a02	enclosure

Frequency MHz	Antenna Polarisation	Bandwidth kHz	Measured Level dBm	Limit dBm
-	-	-	-	-13.0

Remark: No (further) spurious emissions were found in the range 20 dB below the limit.

Op. Mode	Setup	Port
op-mode 3	setup_a02	enclosure

Frequency MHz	Antenna Polarisation	Bandwidth kHz	Measured Level dBm	Limit dBm
849	Vertical	3.0	-17.1	-13.0

Remark: No (further) spurious emissions were found in the range 20 dB below the limit.

Op. Mode	Setup	Port
op-mode 4	setup_a02	enclosure

Frequency MHz	Antenna Polarisation	Bandwidth kHz	Measured Level dBm	Limit dBm
824	Vertical	3.0	-26.4	-13.0

Remark: No (further) spurious emissions were found in the range 20 dB below the limit.

Op. Mode	Setup	Port
op-mode 5	setup_a02	enclosure

Frequency MHz	Antenna Polarisation	Bandwidth kHz	Measured Level dBm	Limit dBm
-	-	-	-	-13.0

Remark: No (further) spurious emissions were found in the range 20 dB below the limit.



Op. Mode	Setup	Port
op-mode 6	setup_a02	enclosure

Frequency MHz	Antenna Polarisation	Bandwidth kHz	Measured Level dBm	Limit dBm
849	Vertical	3.0	-26.1	-13.0

Remark: No (further) spurious emissions were found in the range 20 dB below the limit.

Op. Mode	Setup	Port
op-mode 7	setup_a02	enclosure

Frequency MHz	Antenna Polarisation	Bandwidth kHz	Measured Level dBm	Limit dBm
-	-	-	-	-13.0

Remark: No (further) spurious emissions were found in the range 20 dB below the limit.

Op. Mode	Setup	Port
op-mode 8	setup_a02	enclosure

Frequency MHz	Antenna Polarisation	Bandwidth kHz	Measured Level dBm	Limit dBm
-	-	-	-	-13.0

Remark: No (further) spurious emissions were found in the range 20 dB below the limit.

Op. Mode	Setup	Port
op-mode 9	setup_a02	enclosure

Frequency MHz	Antenna Polarisation	Bandwidth kHz	Measured Level dBm	Limit dBm
-	-	-	-	-13.0

Remark: No (further) spurious emissions were found in the range 20 dB below the limit.

### 3.4.4 Test result: Field strength of spurious radiation

FCC Part 22, Subpart H	Op. Mode	Result
	op-mode 1	passed
	op-mode 2	passed
	op-mode 3	passed
	op-mode 4	passed
	op-mode 5	passed
	op-mode 6	passed
	op-mode 7	passed
	op-mode 8	passed
	op-mode 9	passed



### 3.5 Emission and Occupied Bandwidth

**Standard** FCC Part 22, 10-1-06  
Subpart H

The test was performed according to: FCC §2.1049, 10-1-06

#### 3.5.1 Test Description

1) The EUT was coupled to the R&S Spectrum Analyser and the R&S CMU200 Digital Communication Tester through a Power Divider. Refer to chapter "Setup Drawings".

2) The total insertion losses for RF Path 1 and RF Path 2 were measured. The values were used to correct the readings from the R&S Spectrum Analyser and the R&S CMU200 Digital Communication Tester.

3) A call was established on a Traffic Channel (TCH) between the EUT and the base station simulator (R&S CMU200 Digital Communication Tester).

Important Settings:

- Discontinuous Transmission: OFF
- Modulation Signal: PSR16-1 (Pseudo Random Sequence)
- Output Power: Maximum
- Channel: Varied during measurements

4) Important Analyser Settings:

- Resolution Bandwidth: 3 kHz (1% of the manufacturers stated occupied bandwidth)
- Video Bandwidth: 10 kHz (three times the Resolution Bandwidth)
- Sweep Span: 1 MHz (at least 250% of the emission bandwidth)

5) The maximum spectral level of the modulated signal was recorded as the reference.

6) The emission bandwidth is measured as follows:

the two furthest frequencies above and below the frequency of the maximum reference level where the spectrum is  $-26$  dB down have to be found.

7) The occupied bandwidth (99% Bandwidth) is measured as follows:

the occupied bandwidth, that is the frequency bandwidth such that, below its lower and above its upper frequency limits, the mean powers radiated are each equal to 0.5 percent of the total mean power.



### **3.5.2 Test Requirements / Limits**

#### § 2.1049 Measurements required: Occupied bandwidth

The occupied bandwidth, that is the frequency bandwidth such that, below its lower and above its upper frequency limits, the mean powers radiated are each equal to 0.5 percent of the total mean power radiated by a given emission shall be measured under the following conditions (as applicable):

(h) Transmitters employing digital modulation techniques - when modulated by an input signal such that its amplitude and symbol rate represent the maximum rated conditions under which the equipment will be operated. The signal shall be applied through any filter networks, pseudo-random generators or other devices required in normal service. Additionally, the occupied bandwidth shall be shown for operation with any devices used for modifying the spectrum when such devices are optional at the discretion of the user.

### 3.5.3 Test Protocol

Temperature: 21 °C  
 Air Pressure: 1013 hPa  
 Humidity: 40 %

Op. Mode	Setup	Port
op-mode 1	setup_a01	antenna connector

Bandwidth kHz	Remarks
316	please see annex

Remark: The given value is the result of the 26dB bandwidth measurement.  
 The 99% Bandwidth is 246 kHz.

Op. Mode	Setup	Port
op-mode 2	setup_a01	antenna connector

Bandwidth kHz	Remarks
318	please see annex

Remark: The given value is the result of the 26dB bandwidth measurement.  
 The 99% Bandwidth is 248 kHz.

Op. Mode	Setup	Port
op-mode 3	setup_a01	antenna connector

Bandwidth kHz	Remarks
318	please see annex

Remark: The given value is the result of the 26dB bandwidth measurement.  
 The 99% Bandwidth is 244 kHz.

Op. Mode	Setup	Port
op-mode 4	setup_a01	antenna connector

Bandwidth kHz	Remarks
314	please see annex

Remark: The given value is the result of the 26dB bandwidth measurement.  
 The 99% Bandwidth is 246 kHz.

Op. Mode	Setup	Port
op-mode 5	setup_a01	antenna connector

Bandwidth kHz	Remarks
306	please see annex

Remark: The given value is the result of the 26dB bandwidth measurement.  
 The 99% Bandwidth is 250 kHz.



Op. Mode	Setup	Port
op-mode 6	setup_a01	antenna connector

Bandwidth kHz	Remarks
316	please see annex

Remark: The given value is the result of the 26dB bandwidth measurement.  
The 99% Bandwidth is 244 kHz.

Op. Mode	Setup	Port
op-mode 7	setup_a01	antenna connector

Bandwidth kHz	Remarks
4700	please see annex

Remark: The given value is the result of the 26dB bandwidth measurement.  
The 99% Bandwidth is 4160 kHz.

Op. Mode	Setup	Port
op-mode 8	setup_a01	antenna connector

Bandwidth kHz	Remarks
4680	please see annex

Remark: The given value is the result of the 26dB bandwidth measurement.  
The 99% Bandwidth is 4180 kHz.

Op. Mode	Setup	Port
op-mode 9	setup_a01	antenna connector

Bandwidth kHz	Remarks
4720	please see annex

Remark: The given value is the result of the 26dB bandwidth measurement.  
The 99% Bandwidth is 4160 kHz.

### 3.5.4 Test result: Emission and Occupied Bandwidth

FCC Part 22, Subpart H	Op. Mode	Result
	op-mode 1	passed
	op-mode 2	passed
	op-mode 3	passed
	op-mode 4	passed
	op-mode 5	passed
	op-mode 6	passed
	op-mode 7	passed
	op-mode 8	passed
	op-mode 9	passed



### **3.6 Band edge compliance**

**Standard** FCC Part 22, 10-1-06  
Subpart H

The test was performed according to: FCC §22.913, 10-1-06

#### **3.6.1 Test Description**

- 1) The EUT was coupled to the R&S CMU200 Digital Communications Tester via a 10 dB attenuator and a 6 dB coupler.
- 2) For the measurement the EUT is connected to the Spectrum Analyser via 30 dB attenuator and 6 dB coupler.
- 3) The spectrum analyser is set to a RBW/VBW of 1% of the signal's bandwidth.

#### **3.6.2 Test Requirements / Limits**

§ 22.913 Effective radiated power limits



### 3.6.3 Test Protocol

Temperature: 23 °C  
 Air Pressure: 1007 hPa  
 Humidity: 32 %

Op. Mode	Setup	Port
op-mode 1	setup_a01	antenna connector

Frequency MHz	Measured value dBm	Limit dBm
824	-13.32	-13

Remark: Please see annex for the measurement plot.

Op. Mode	Setup	Port
op-mode 3	setup_a01	antenna connector

Frequency MHz	Measured value dBm	Limit dBm
849	-13.67	-13

Remark: Please see annex for the measurement plot.

Op. Mode	Setup	Port
op-mode 4	setup_a01	antenna connector

Frequency MHz	Measured value dBm	Limit dBm
824	-20.17	-13

Remark: Please see annex for the measurement plot.

Op. Mode	Setup	Port
op-mode 6	setup_a01	antenna connector

Frequency MHz	Measured value dBm	Limit dBm
849	-20.91	-13

Remark: Please see annex for the measurement plot.



<b>Op. Mode</b>	<b>Setup</b>	<b>Port</b>
op-mode 7	setup_a01	antenna connector

<b>Frequency MHz</b>	<b>Measured value dBm</b>	<b>Limit dBm</b>
824	-24.52	-13

Remark: Please see annex for the measurement plot.

<b>Op. Mode</b>	<b>Setup</b>	<b>Port</b>
op-mode 9	setup_a01	antenna connector

<b>Frequency MHz</b>	<b>Measured value dBm</b>	<b>Limit dBm</b>
849	-20.15	-13

Remark: Please see annex for the measurement plot.

### 3.6.4 Test result: Band edge compliance

<b>FCC Part 22, Subpart H</b>	<b>Op. Mode</b>	<b>Result</b>
	op-mode 1	passed
	op-mode 3	passed
	op-mode 4	passed
	op-mode 6	passed
	op-mode 7	passed
	op-mode 9	passed

## 4 Test Equipment

### *EUT Digital Signalling System*

<b>Equipment</b>	<b>Type</b>	<b>Serial No.</b>	<b>Manufacturer</b>
Digital Radio Communication Tester	CMD 55	831050/020	Rohde & Schwarz
Signalling Unit for Bluetooth Spurious Emissions	PTW60	100004	Rohde & Schwarz
Universal Radio Communication Tester	CMU 200	102366	Rohde & Schwarz

### *EMI Test System*

<b>Equipment</b>	<b>Type</b>	<b>Serial No.</b>	<b>Manufacturer</b>
Comparison Noise Emitter	CNE III	99/016	York
EMI Analyzer	ESI 26	830482/004	Rohde & Schwarz
Signal Generator	SMR 20	846834/008	Rohde & Schwarz

### *EMI Radiated Auxiliary Equipment*

<b>Equipment</b>	<b>Type</b>	<b>Serial No.</b>	<b>Manufacturer</b>
Antenna mast 4m	MA 240	240/492	HD GmbH H. Deisel
Biconical dipole	VUBA 9117	9117108	Schwarzbeck
Broadband Amplifier 18MHz-26GHz	JS4-18002600-32	849785	Miteq
Broadband Amplifier 30MHz-18GHz	JS4-00101800-35	896037	Miteq
Broadband Amplifier 45MHz-27GHz	JS4-00102600-42	619368	Miteq
Cable "ESI to EMI Antenna"	EcoFlex10	W18.01-2 + W38.01-2	Kabel Kusch
Cable "ESI to Horn Antenna"	UFB311A + UFB293C	W18.02-2 + W38.02-2	Rosenberger-Microcoax
Double-ridged horn	HF 906	357357/002	Rohde & Schwarz
Double-ridged horn	HF 906	357357/001	Rohde & Schwarz
High Pass Filter	5HC3500/12750-1.2-KK	200035008	Trilithic
High Pass Filter	5HC2700/12750-1.5-KK	9942012	Trilithic
High Pass Filter	4HC1600/12750-1.5-KK	9942011	Trilithic
KUEP pre amplifier	Kuep 00304000	001	7layers
Log.-per. Antenna	HL 562 Ultralog	830547/003	Rohde & Schwarz
Loop Antenna	HFH2-Z2	829324/006	Rohde & Schwarz
Pyramidal Horn Antenna 26.5 GHz	Model 3160-09	9910-1184	EMCO

### EMI Conducted Auxiliary Equipment

Equipment	Type	Serial No.	Manufacturer
Cable "LISN to ESI"	RG214	W18.03+W48.03	Huber+Suhner
Two-Line V-Network	ESH 3-Z5	828304/029	Rohde & Schwarz
Two-Line V-Network	ESH 3-Z5	829996/002	Rohde & Schwarz

### Auxiliary Test Equipment

Equipment	Type	Serial No.	Manufacturer
Broadband Resist. Power Divider N	1506A / 93459	LM390	Weinschel
Broadband Resist. Power Divider SMA	1515 / 93459	LN673	Weinschel
Digital Multimeter 01	Voltcraft M-3860M	IJ096055	Conrad
Digital Multimeter 02	Voltcraft M-3860M	IJ095955	Conrad
Digital Oscilloscope	TDS 784C	B021311	Tektronix
Fibre optic link Satellite	FO RS232 Link	181-018	Pontis
Fibre optic link Transceiver	FO RS232 Link	182-018	Pontis
I/Q Modulation Generator	AMIQ-B1	832085/018	Rohde & Schwarz
Notch Filter ultra stable	WRCA800/960-6E	24	Wainwright
Spectrum Analyzer 9 kHz to 3 GHz	FSP3	838164/004	Rohde & Schwarz
Temperature Chamber	VT 4002	58566002150010	Vötsch
Temperature Chamber	KWP 120/70	59226012190010	Weiss
ThermoHygro Datalogger 03	Opus10 THI (8152.00)	7482	Lufft Mess- und Regeltechnik GmbH

### Anechoic Chamber

Equipment	Type	Serial No.	Manufacturer
Air Compressor (pneumatic)			Atlas Copco
Controller	CO 2000	CO2000/328/12470406 /L	Innco innovative constructions GmbH
EMC Camera	CE-CAM/1		CE-SYS
EMC Camera for observation of EUT	CCD-400E	0005033	Mitsubishi
Filter ISDN	B84312-C110-E1		Siemens&Matsushita
Filter telephone systems / modem	B84312-C40-B1		Siemens&Matsushita
Filter Universal 1A	B84312-C30-H3		Siemens&Matsushita
Fully/Semi AE Chamber	10.58x6.38x6		Frankonia
Turntable	DS 420S	420/573/99	HD GmbH, H. Deisel
Valve Control Unit (pneum.)	VE 615P	615/348/99	HD GmbH, H. Deisel



*7 layers Bluetooth™ Full RF Test  
Solution*

*Bluetooth RF Conformance  
Test System TS8960*

<b>Equipment</b>	<b>Type</b>	<b>Serial No.</b>	<b>Manufacturer</b>
10 MHz Reference	MFS	5489/001	Efratom
Power Meter 832025/059	NRVD	832025/059	Rohde & Schwarz
Power Sensor A 832279/013	NRV-Z1	832279/013	Rohde & Schwarz
Power Sensor B 832279/015	NRV-Z1	832279/015	Rohde & Schwarz
Power Supply	E3632A	MY40003776	Agilent
Power Supply	PS-2403D	-	Conrad
RF Step Attenuator 833695/001	RSP	833695/001	Rohde & Schwarz
Rubidium Frequency Normal	MFS	002	Efratom
Signal Analyzer FS1Q26 832695/007	FS1Q26	832695/007	Rohde & Schwarz
Signal Generator 833680/003	SMP 03	833680/003	Rohde & Schwarz
Signal Generator A 834344/002	SM1Q03B	834344/002	Rohde & Schwarz
Signal Generator B 832870/017	SM1Q03B	832870/017	Rohde & Schwarz
Signal Switching and Conditioning Unit	SSCU	338826/005	Rohde & Schwarz
Signalling Unit PTW60 838312/014	PTW60 for TS8960	838312/014	Rohde & Schwarz
System Controller 829323/008	PSM12	829323/008	Rohde & Schwarz

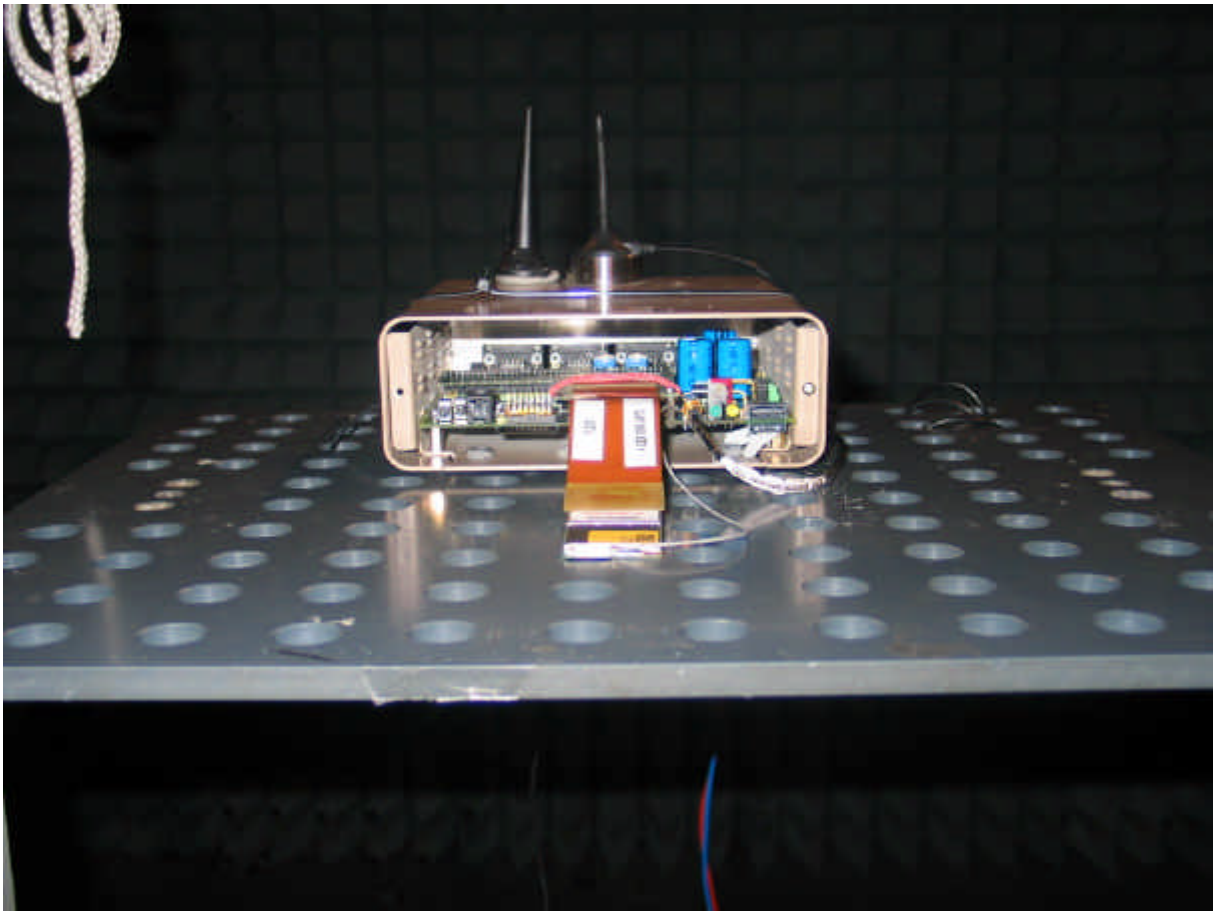
## 5 Photo Report



**Photo 1:** EUT (front side)  
(Photo is provided by customer and may not show the tested sample)

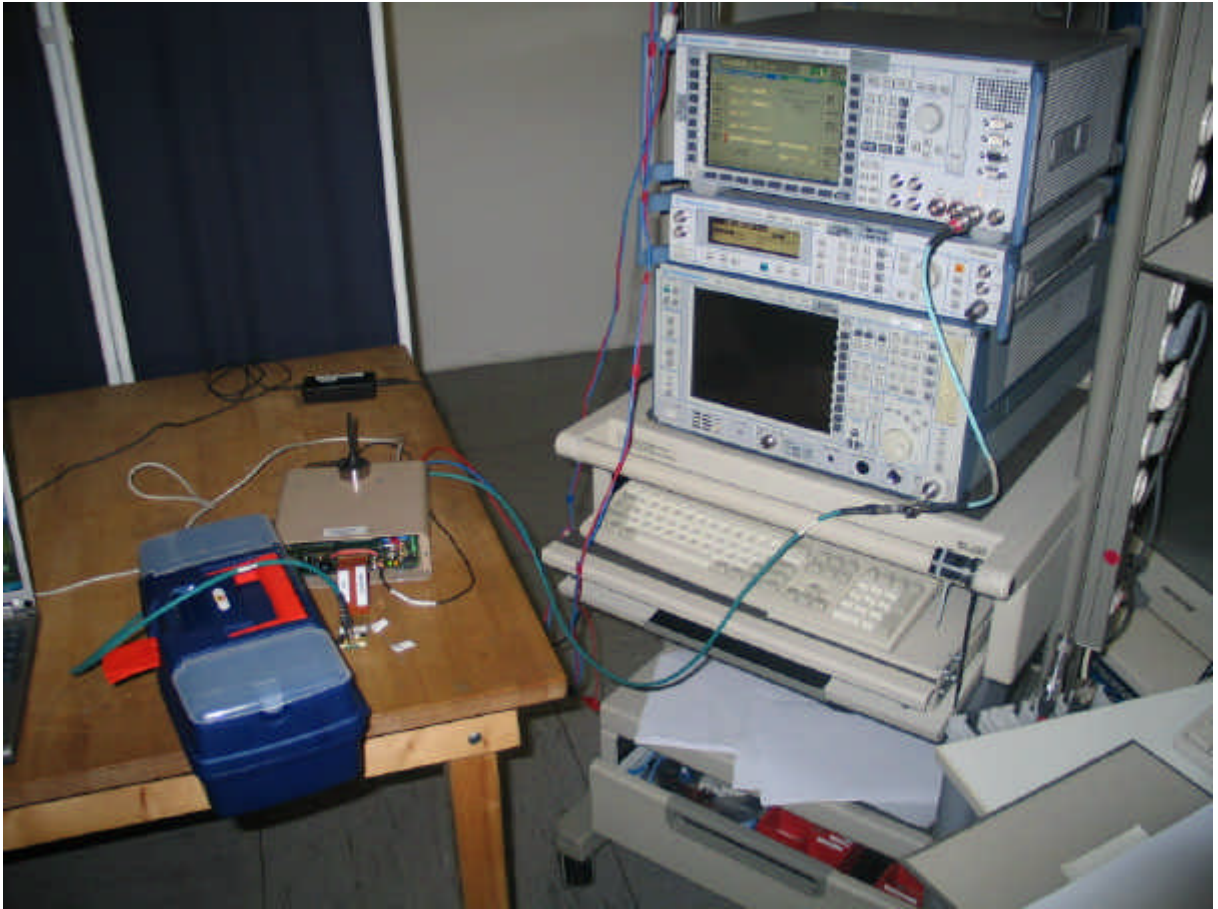


**Photo 2:** EUT (rear side)  
(Photo is provided by customer and may not show the tested sample)



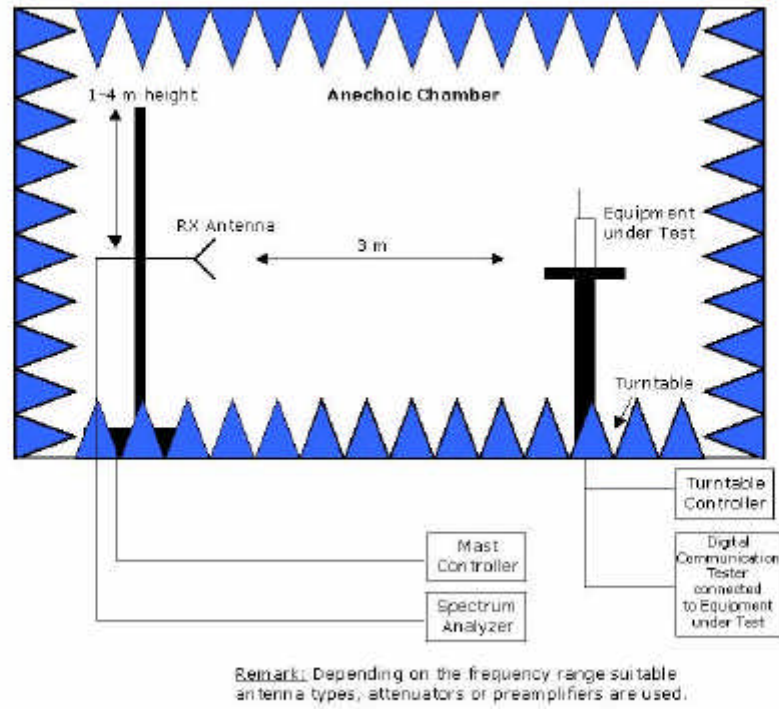
**Photo 3:** Setup for radiated tests



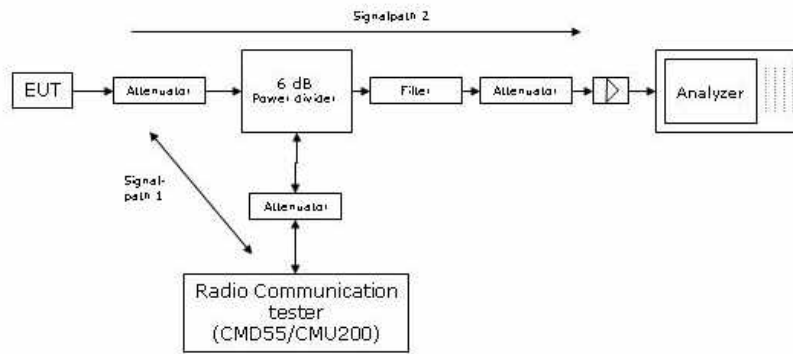


**Photo 4:** Setup for conducted tests

## 6 Setup Drawings

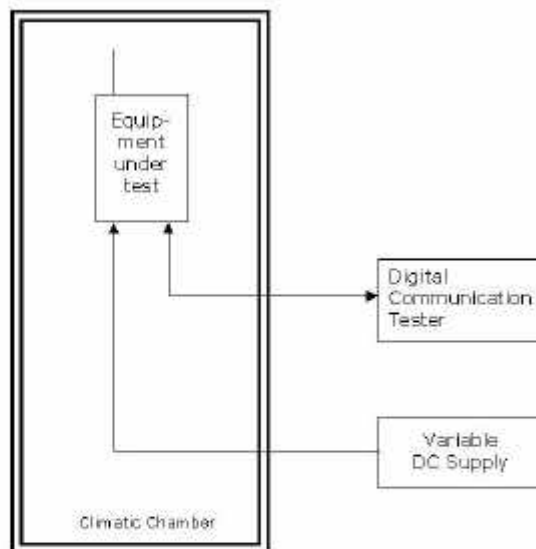


**Drawing 1:** Principle setup for radiated measurements.



Remark: Depending on the frequency range suitable attenuators and/or filters and/or amplifiers are used.

**Drawing 2:** Principle setup for conducted measurements under nominal conditions



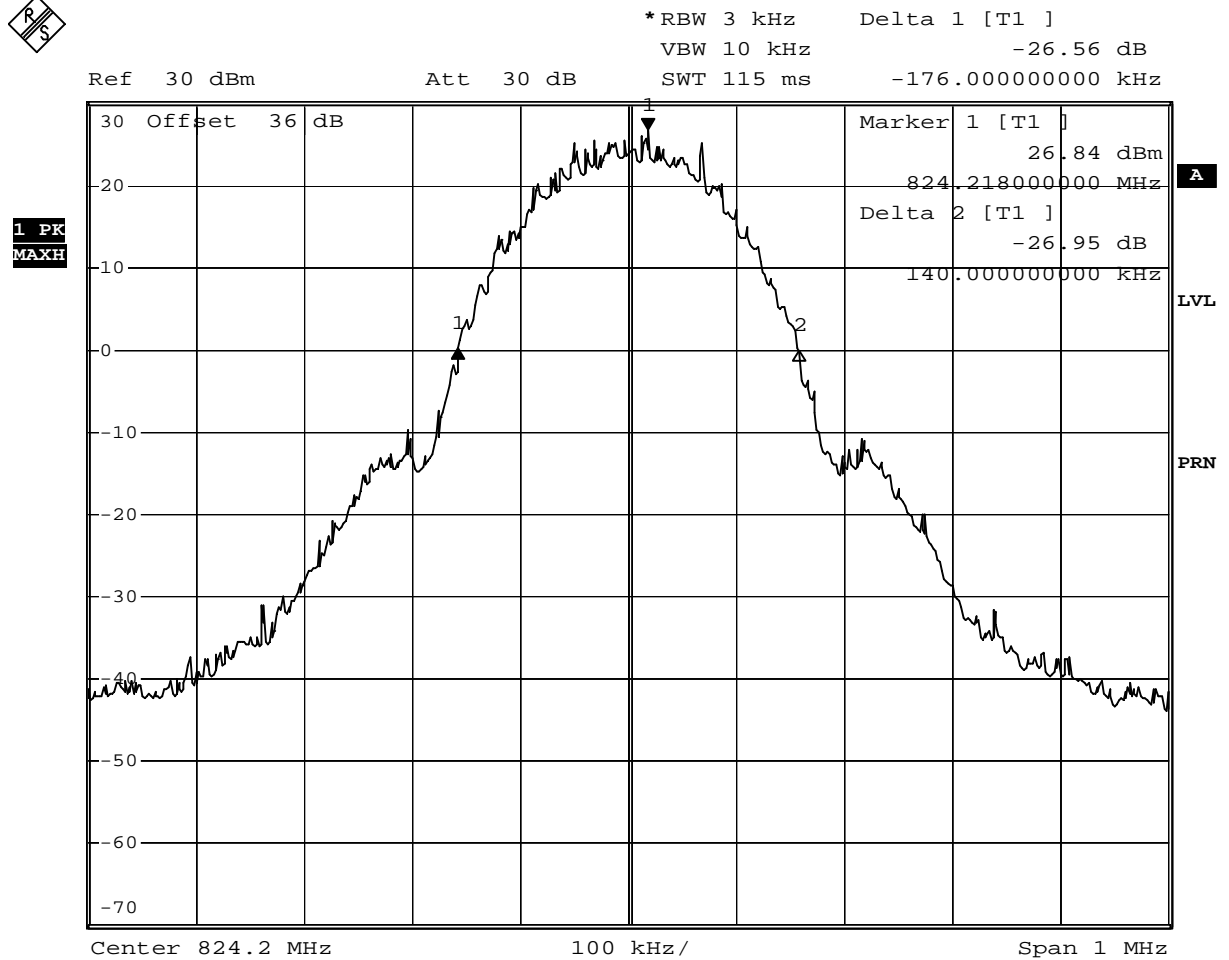
**Drawing 3:** Principle setup for tests under extreme test conditions

## 7 Annex

### Measurement plots Emission and Occupied Bandwidth

#### Op. Mode

op-mode 1

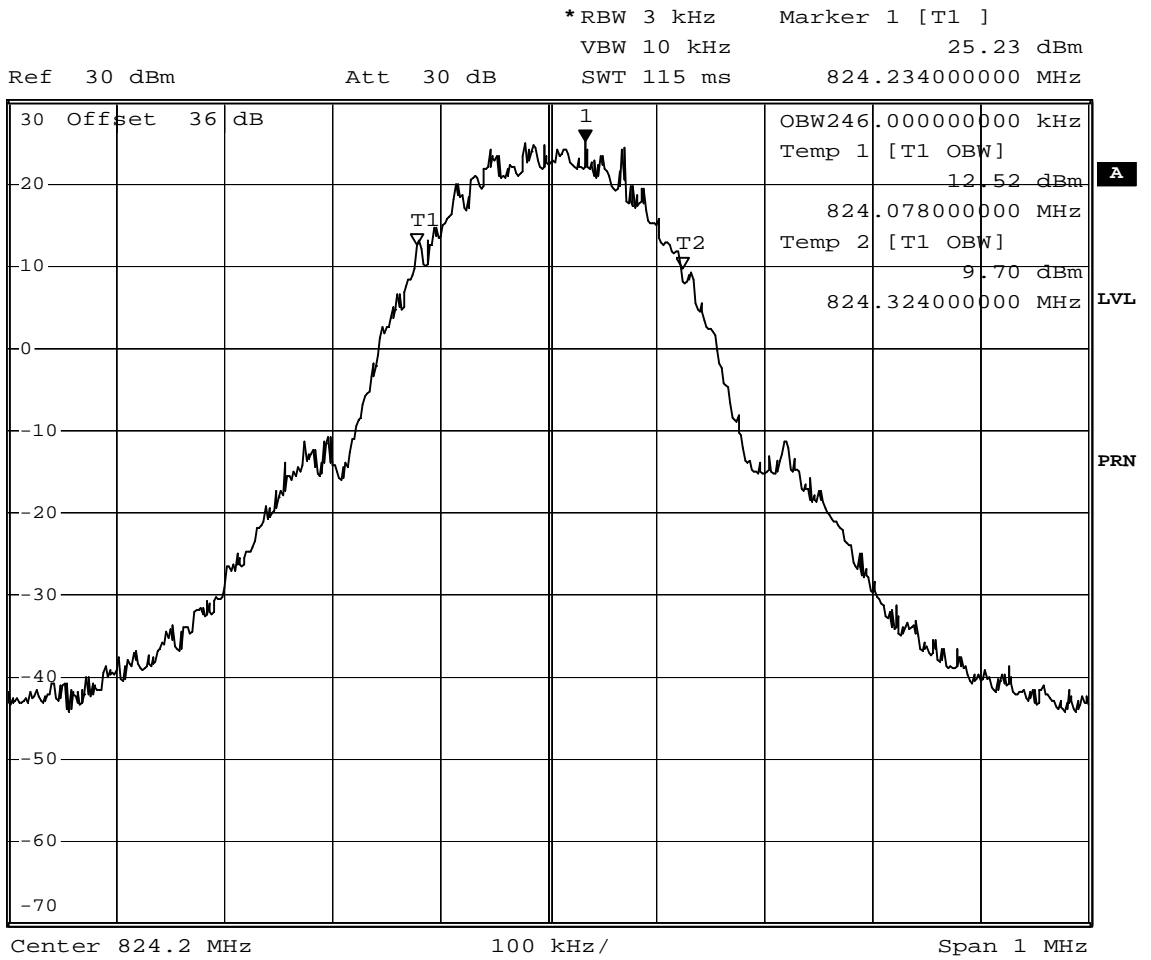


Date: 17.FEB.2007 12:55:38

Test: Emissions bandwidth (26 dB bandwidth), Channel 128 (824.2 MHz)

**Op. Mode**

op-mode 1

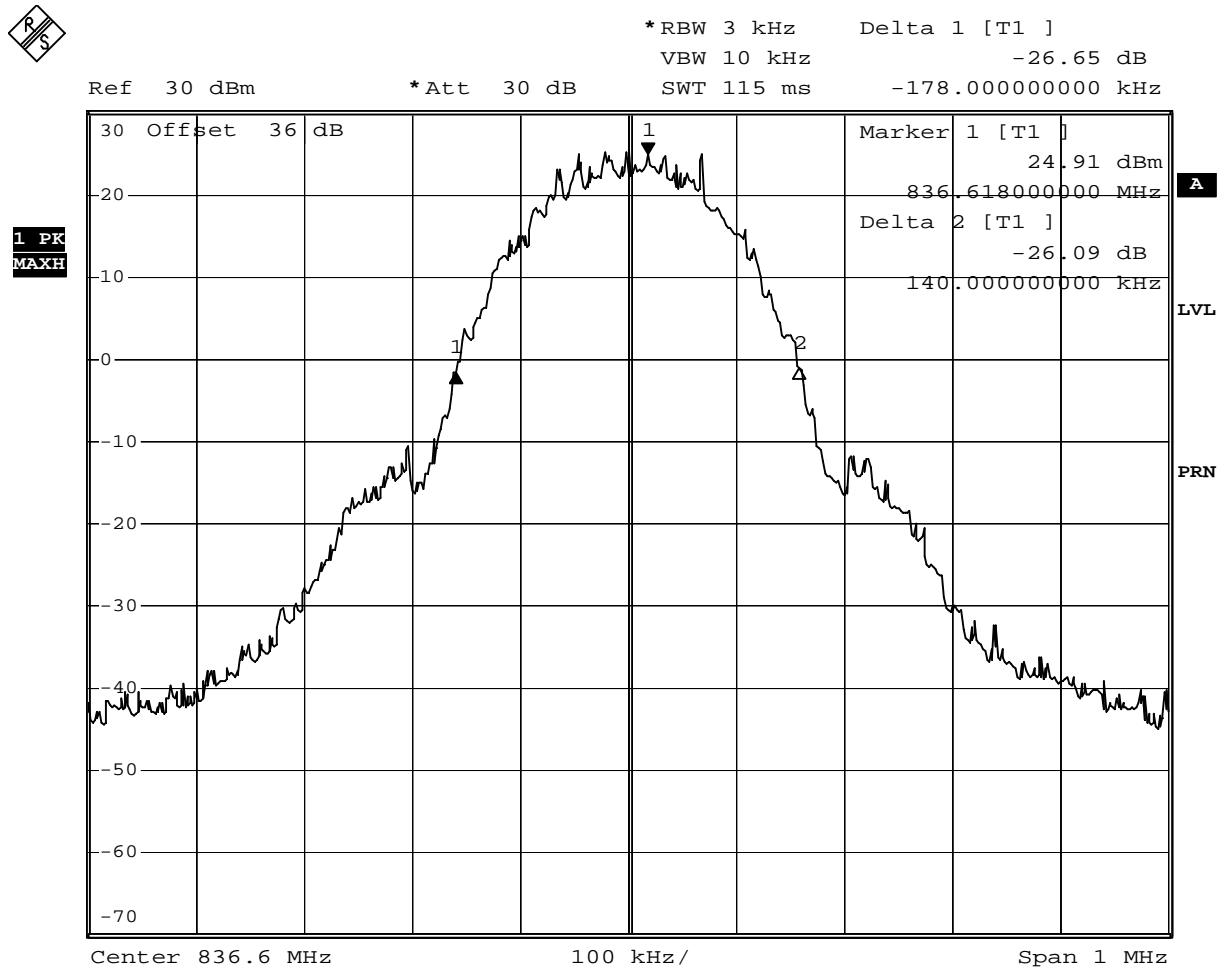


Date: 17.FEB.2007 12:57:44

Test: Occupied bandwidth, Channel 128 (824.2 MHz)

**Op. Mode**

op-mode 2

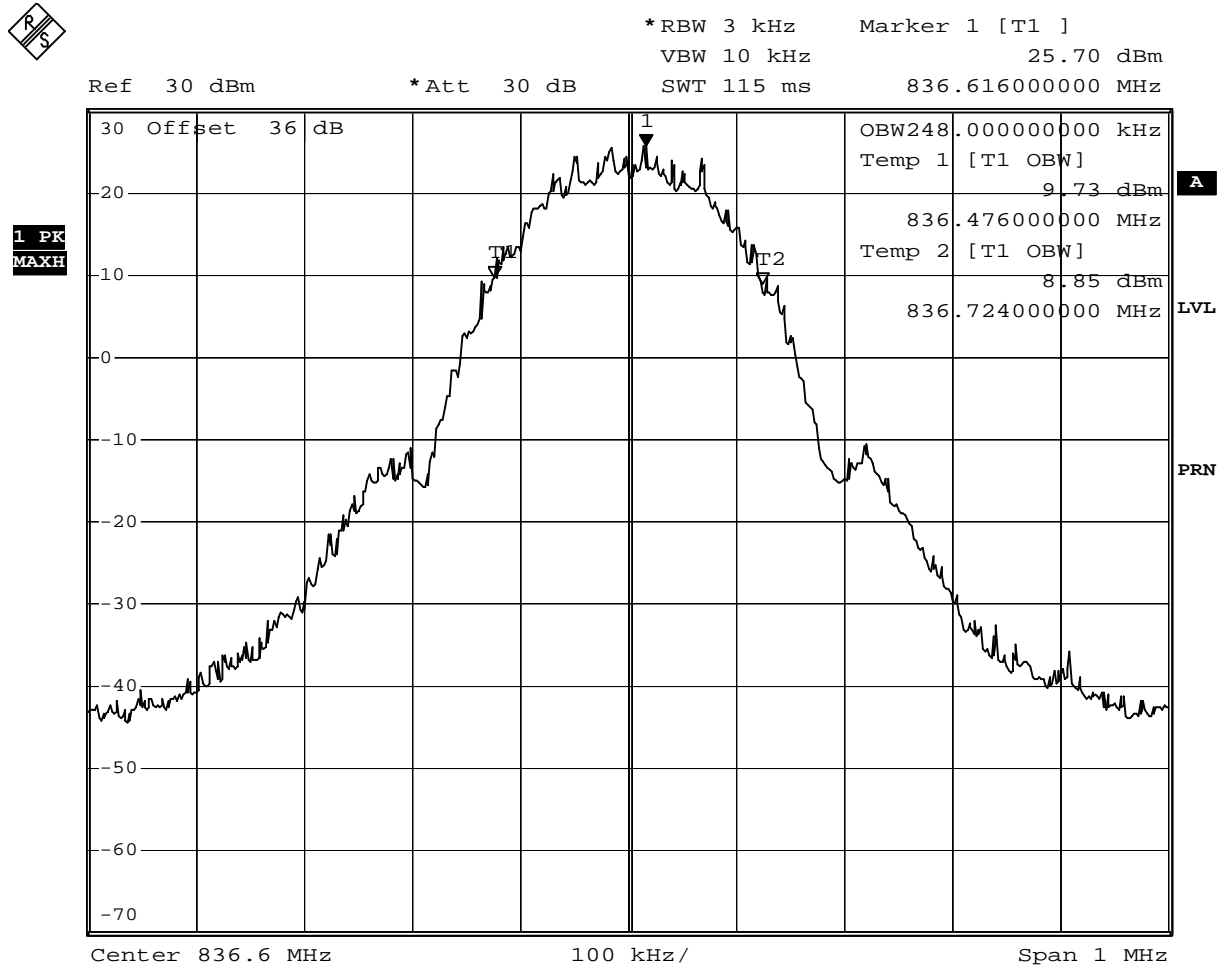


Date: 17.FEB.2007 13:02:26

Test: Emissions bandwidth (26 dB bandwidth), Channel 190 (836.6 MHz)

**Op. Mode**

op-mode 2



Date: 17.FEB.2007 13:03:59

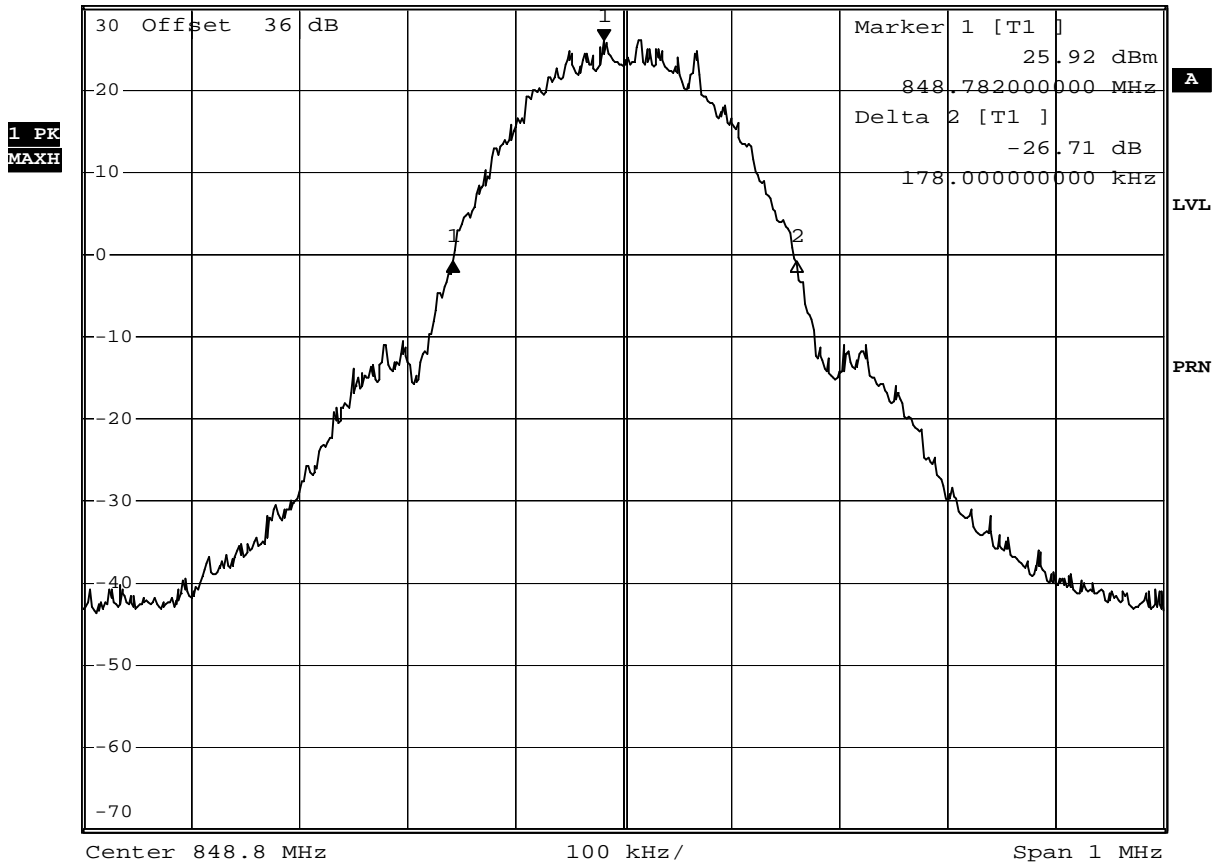
Test: Occupied bandwidth, Channel 190 (836.6 MHz)

**Op. Mode**

op-mode 3



Ref 30 dBm      \*Att 30 dB      \*RBW 3 kHz      Delta 1 [T1 ]      VBW 10 kHz      -26.87 dB      SWT 115 ms      -140.00000000 kHz



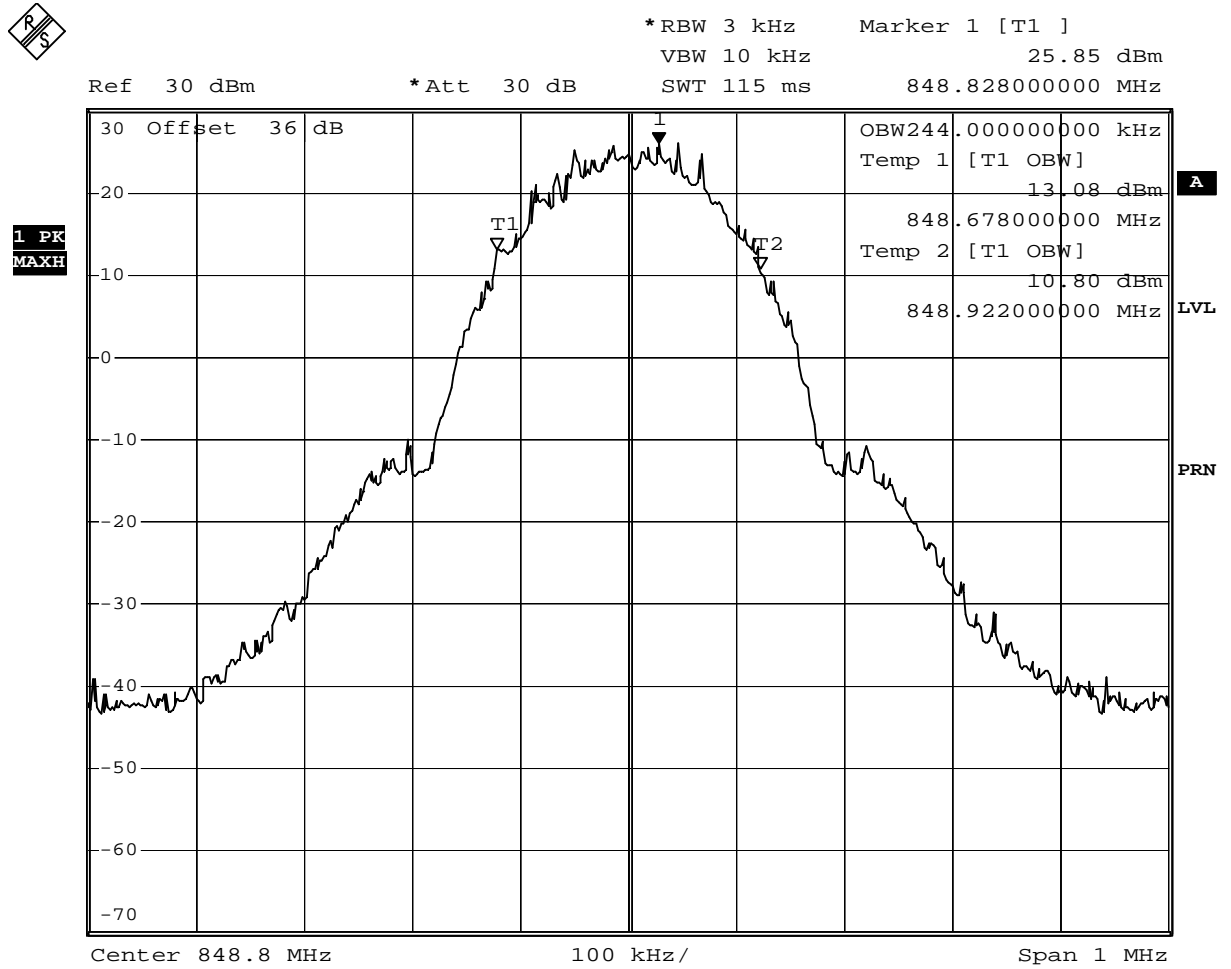
Date: 17.FEB.2007 13:09:04

Test: Emissions bandwidth (26 dB bandwidth), Channel 251 (848.8 MHz)



**Op. Mode**

op-mode 3

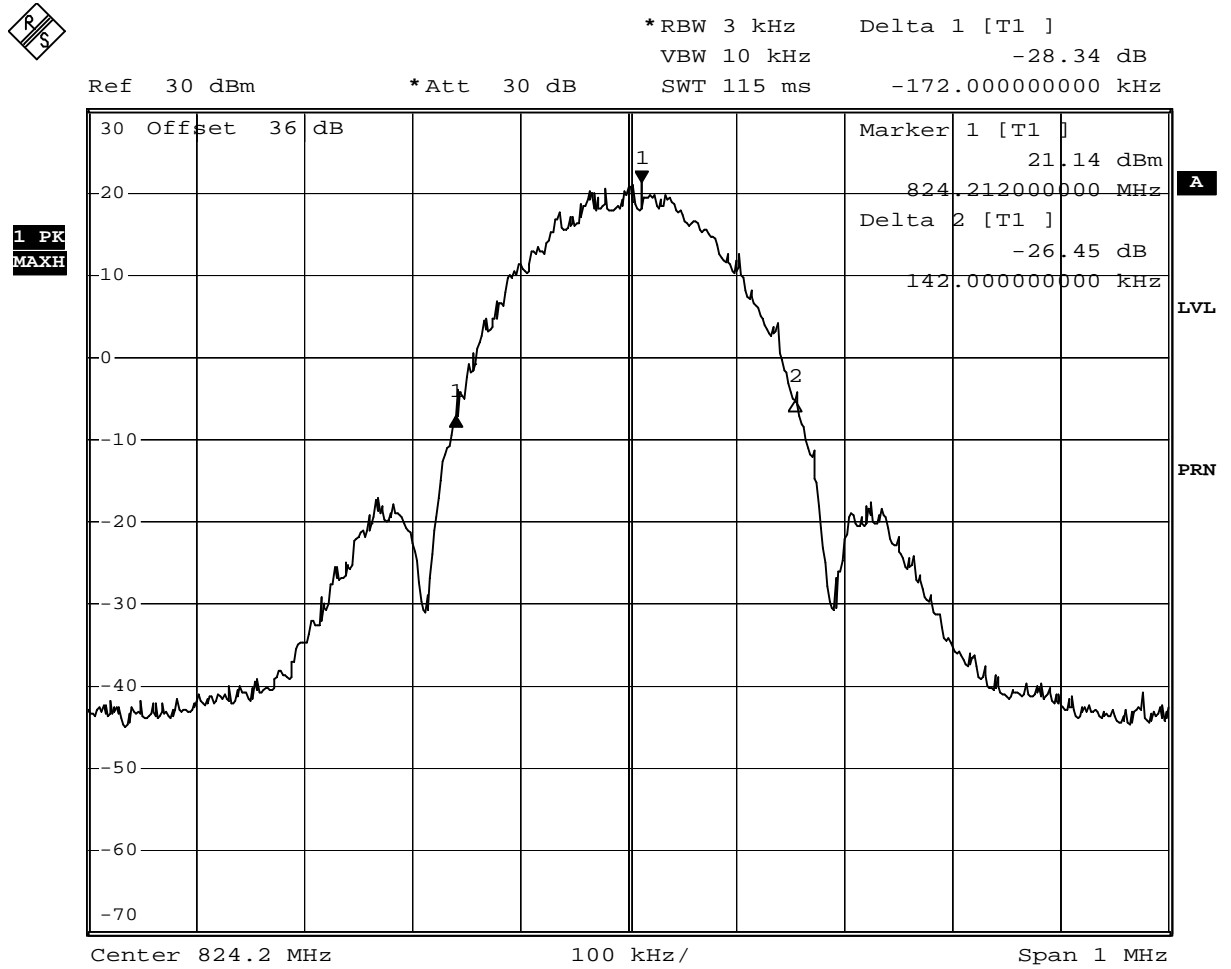


Date: 17.FEB.2007 13:12:53

Test: Occupied bandwidth, Channel 251 (848.8 MHz)

**Op. Mode**

op-mode 4

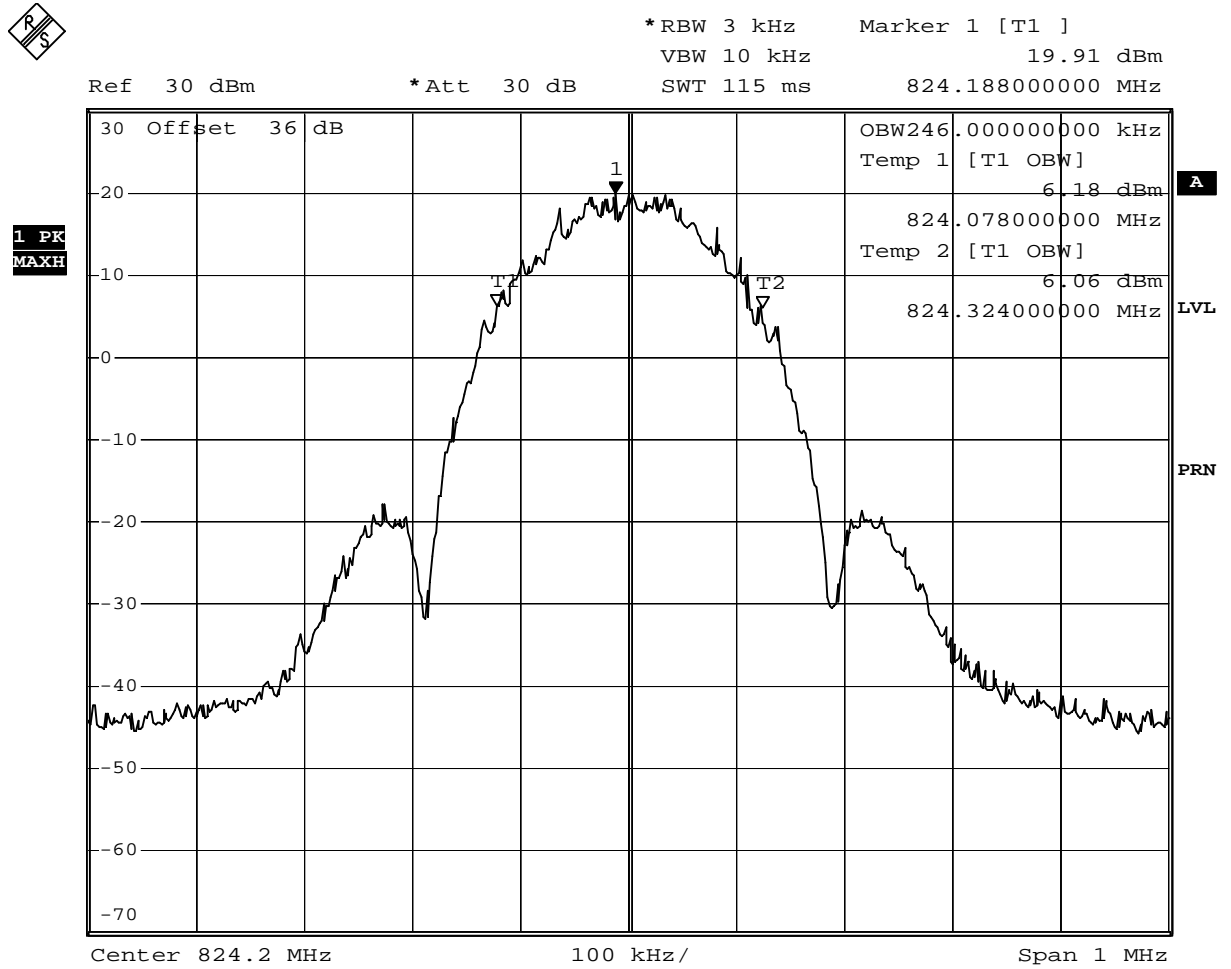


Date: 17.FEB.2007 13:36:50

Test: Emissions bandwidth (26 dB bandwidth), Channel 128 (824.2 MHz)

**Op. Mode**

op-mode 4

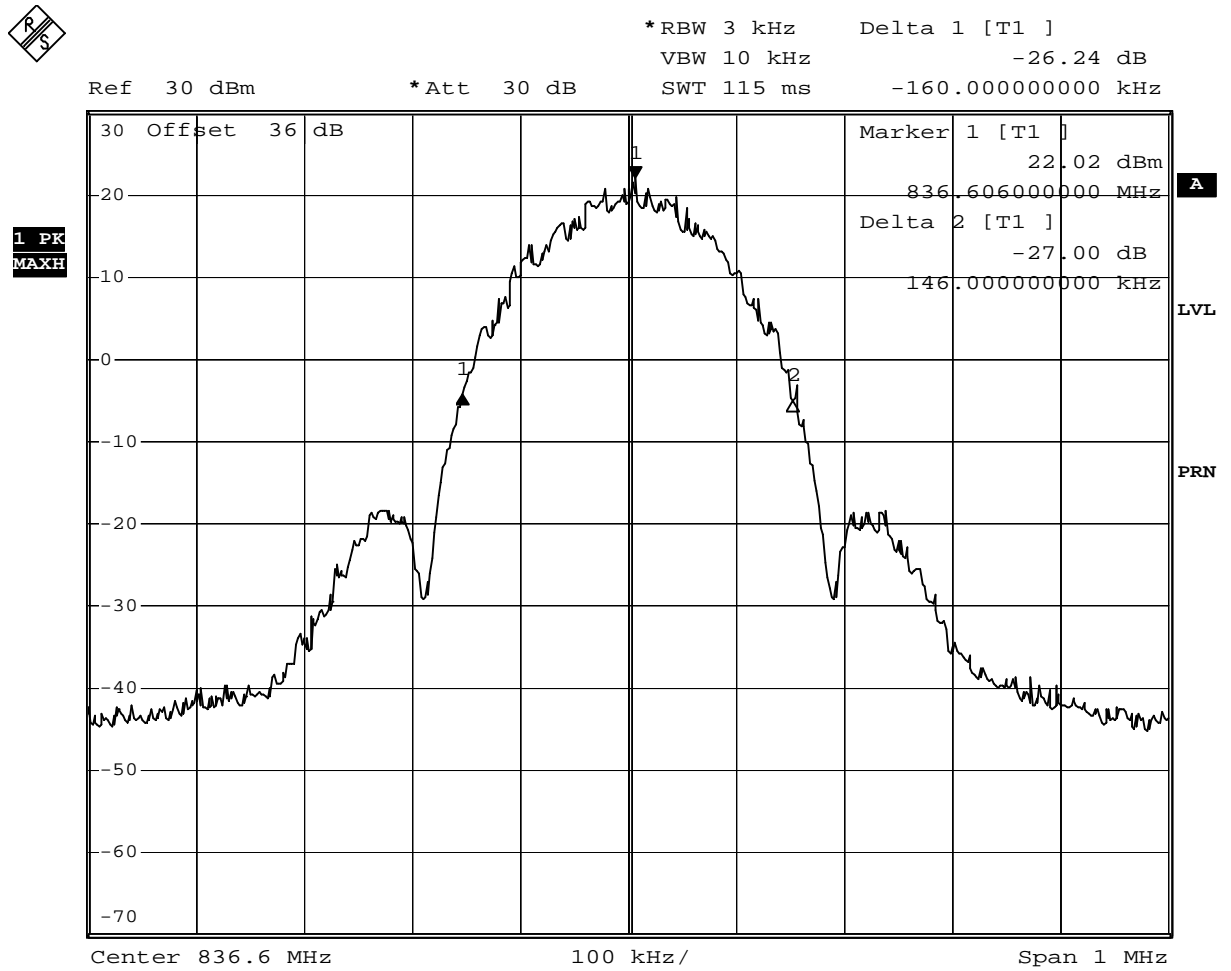


Date: 17.FEB.2007 13:39:12

Test: Occupied bandwidth, Channel 128 (824.2 MHz)

**Op. Mode**

op-mode 5

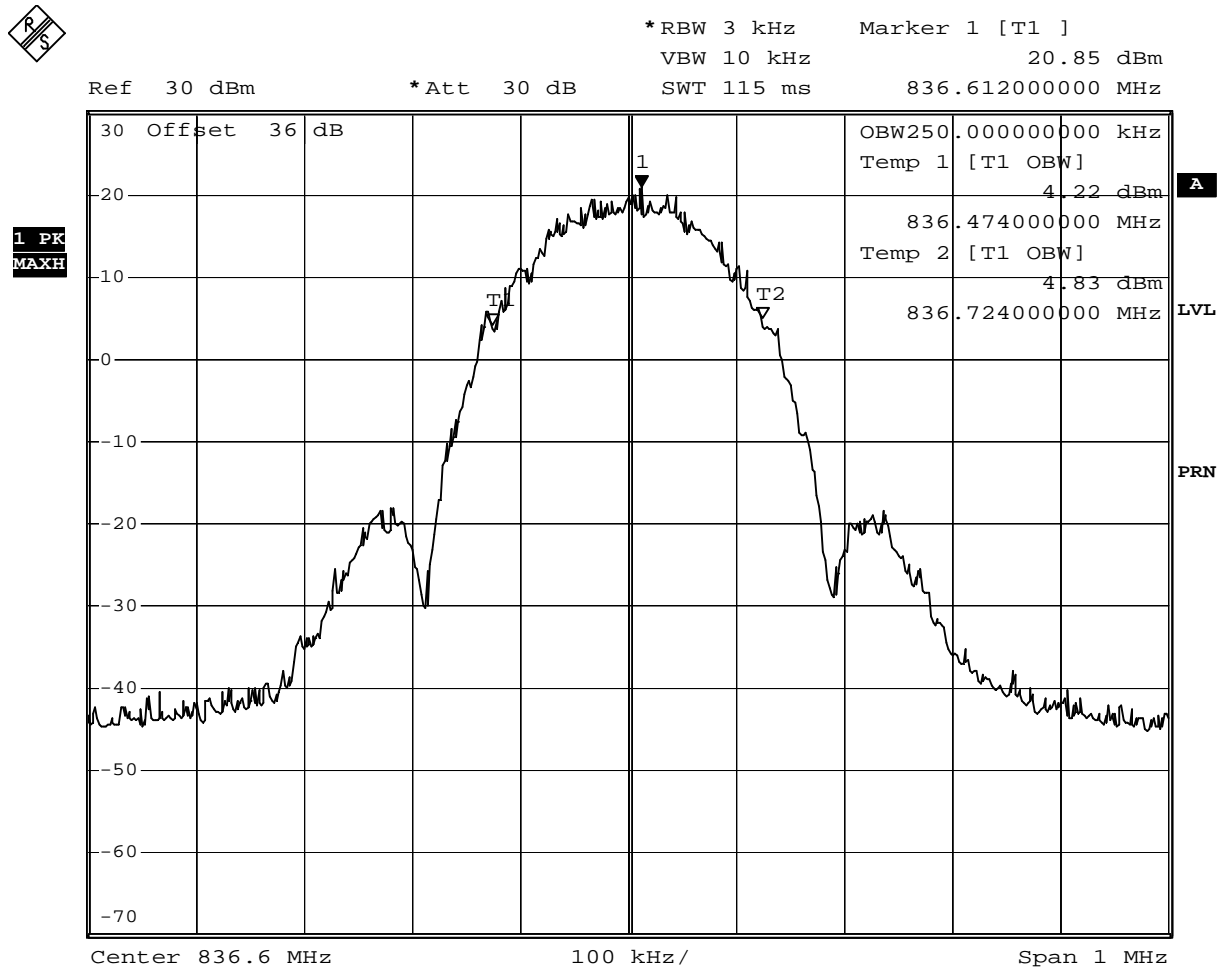


Date: 17.FEB.2007 13:28:46

Test: Emissions bandwidth (26 dB bandwidth), Channel 190 (836.6 MHz)

**Op. Mode**

op-mode 5

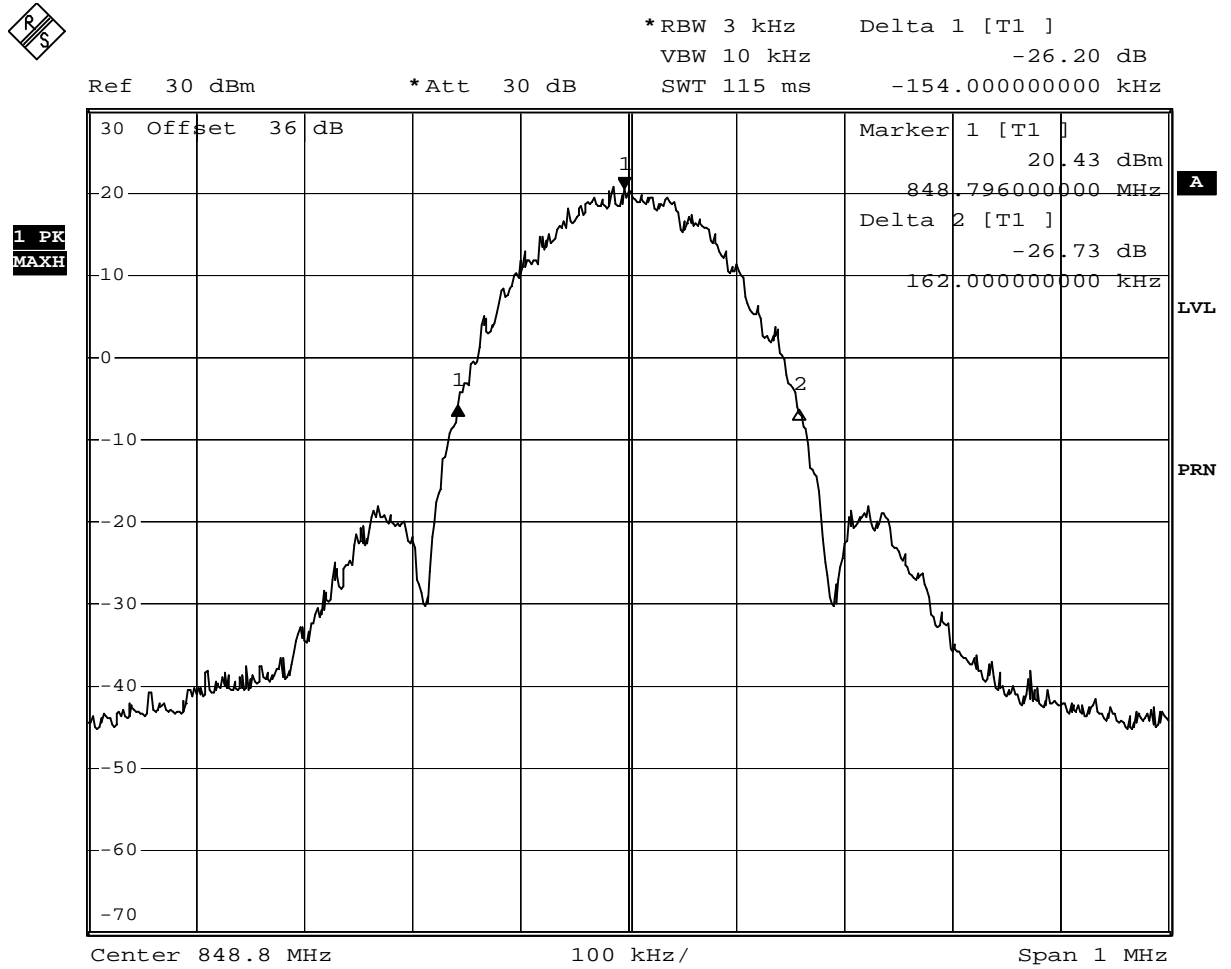


Date: 17.FEB.2007 13:30:53

Test: Occupied bandwidth, Channel 190 (836.6 MHz)

**Op. Mode**

op-mode 6

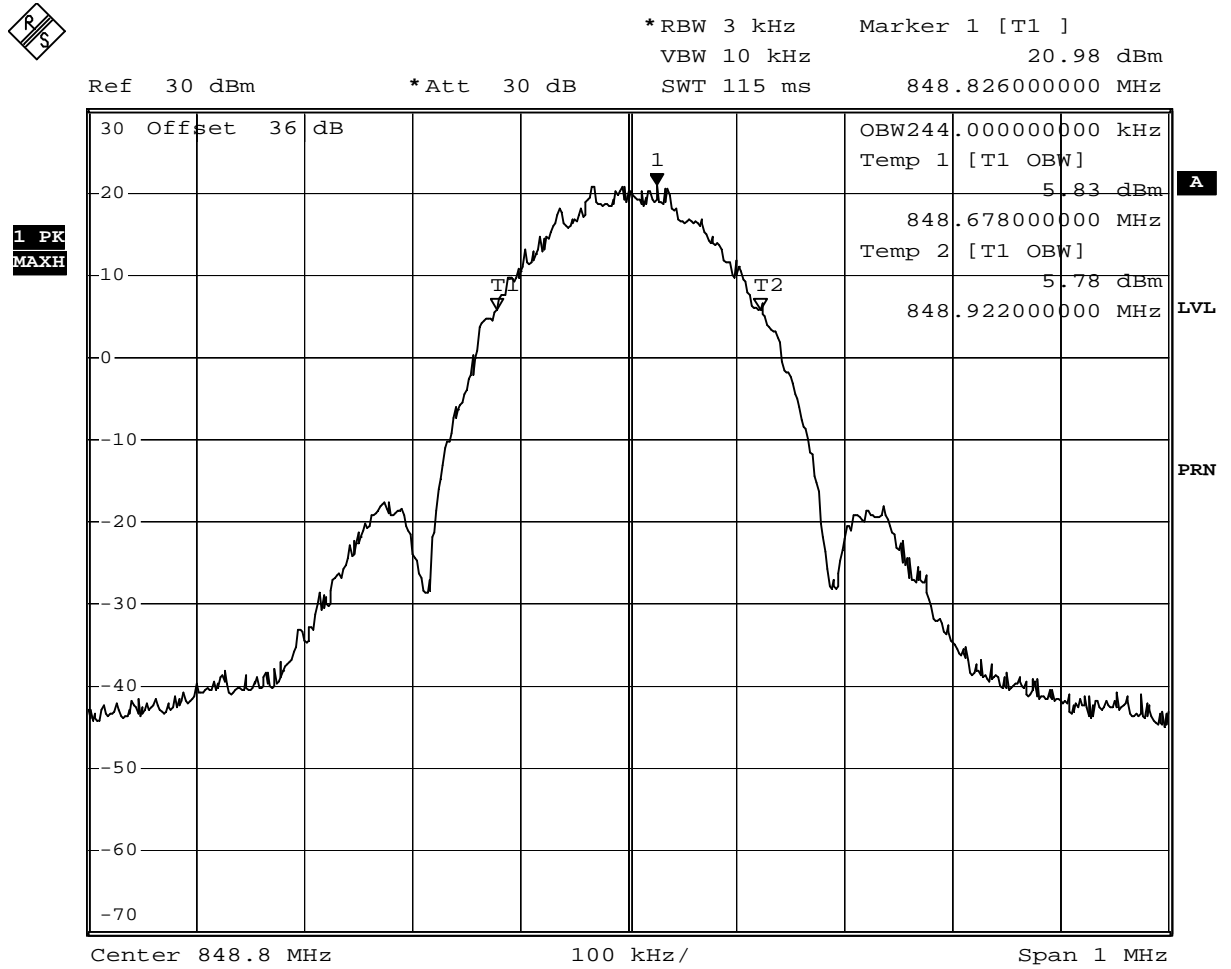


Date: 17.FEB.2007 13:18:38

Test: Emissions bandwidth (26 dB bandwidth), Channel 251 (848.8 MHz)

**Op. Mode**

op-mode 6

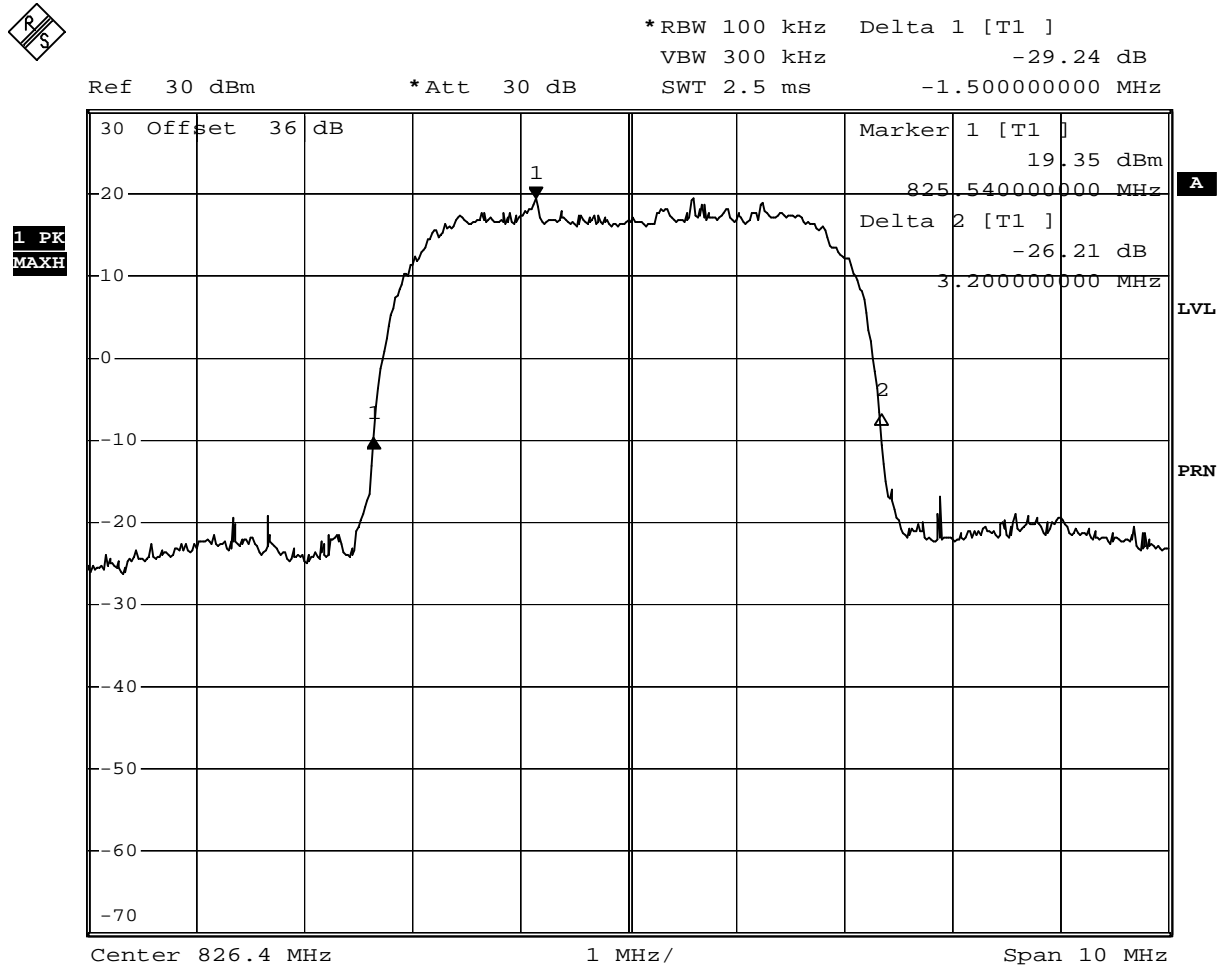


Date: 17.FEB.2007 13:24:01

Test: Occupied bandwidth, Channel 251 (848.8 MHz)

**Op. Mode**

op-mode 7



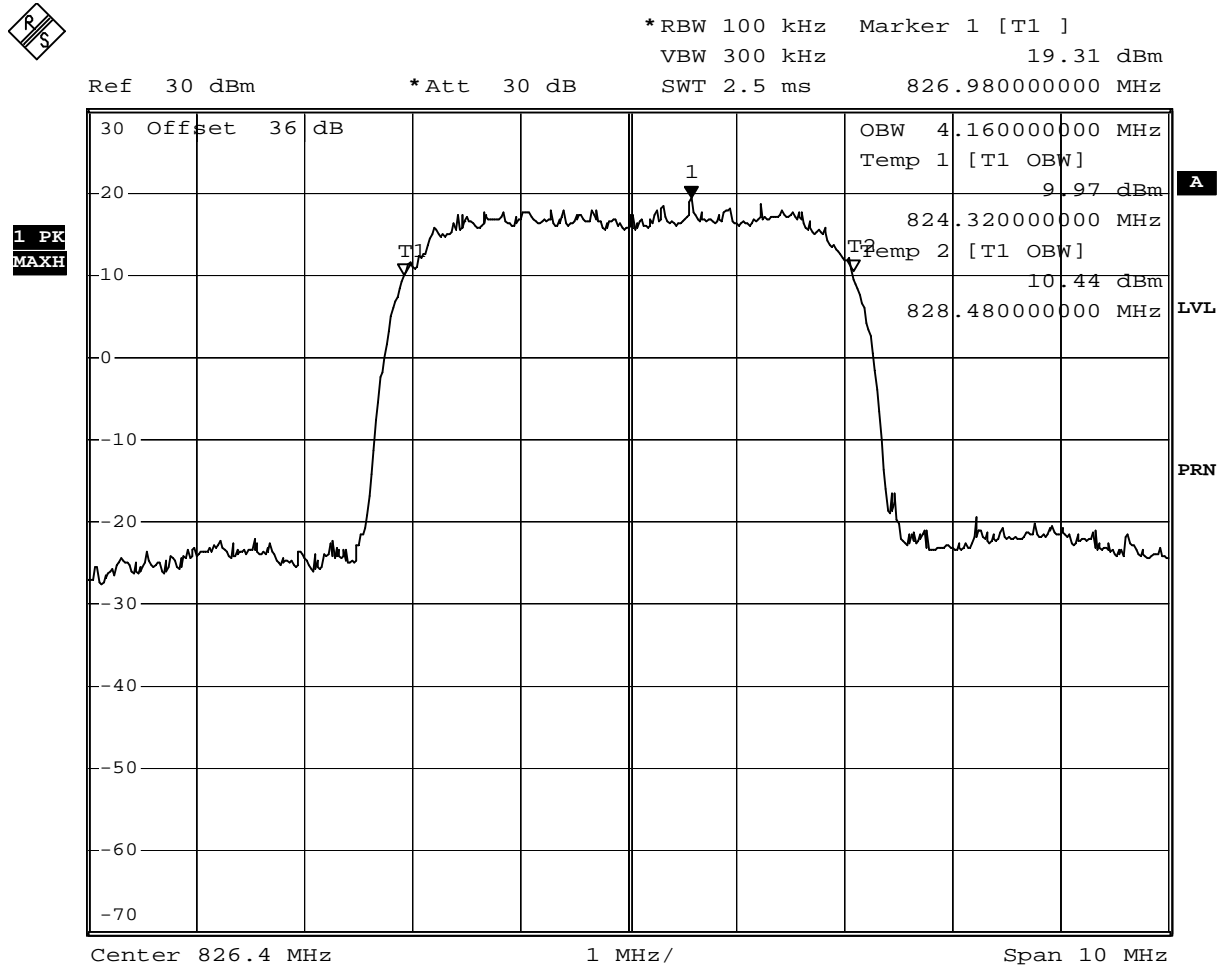
Date: 17.FEB.2007 13:51:51

Test: Emissions bandwidth (26 dB bandwidth), Channel 4132 (826.4 MHz)



**Op. Mode**

op-mode 7

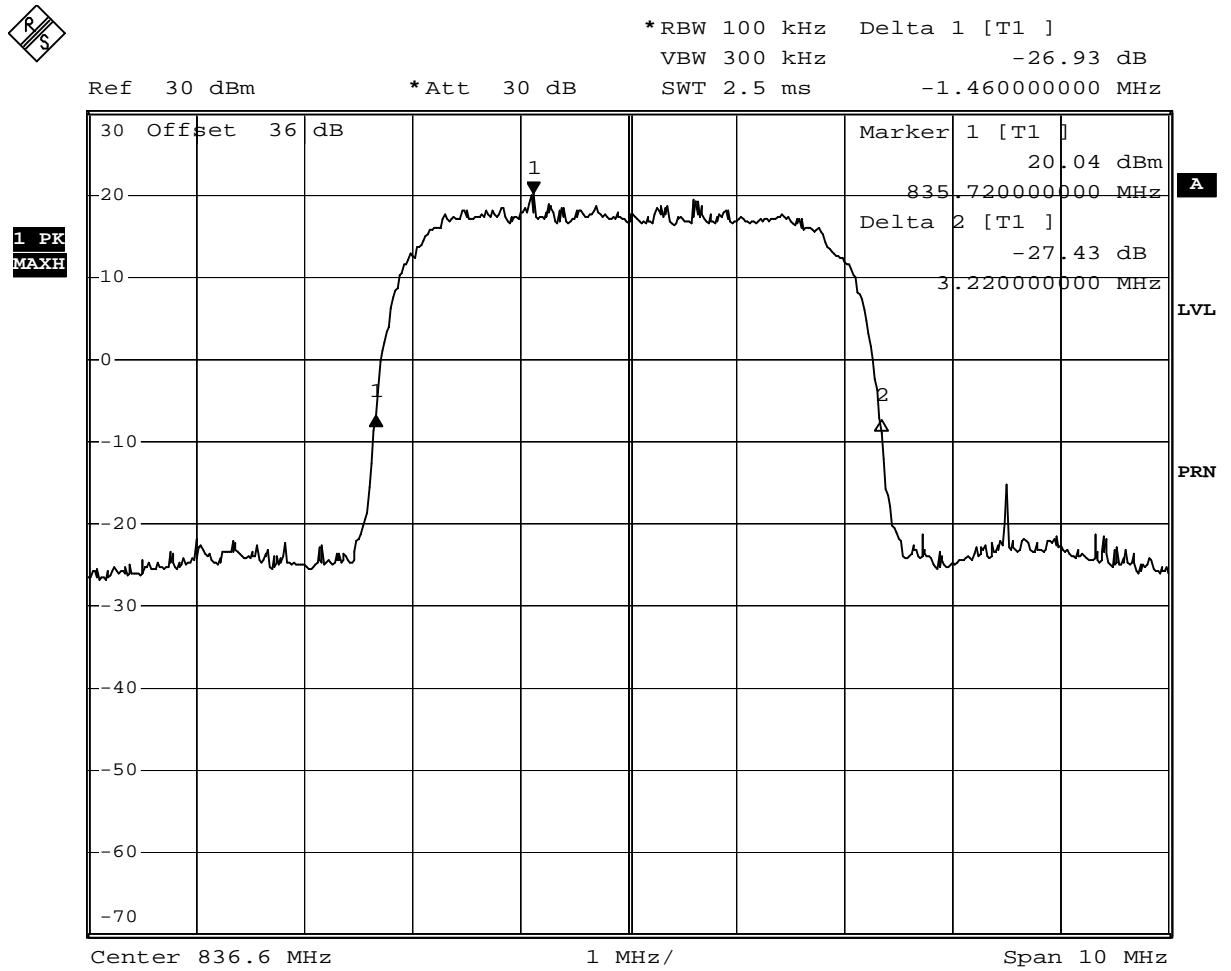


Date: 17.FEB.2007 13:53:19

Test: Occupied bandwidth, Channel 4132 (826.4 MHz)

**Op. Mode**

op-mode 8

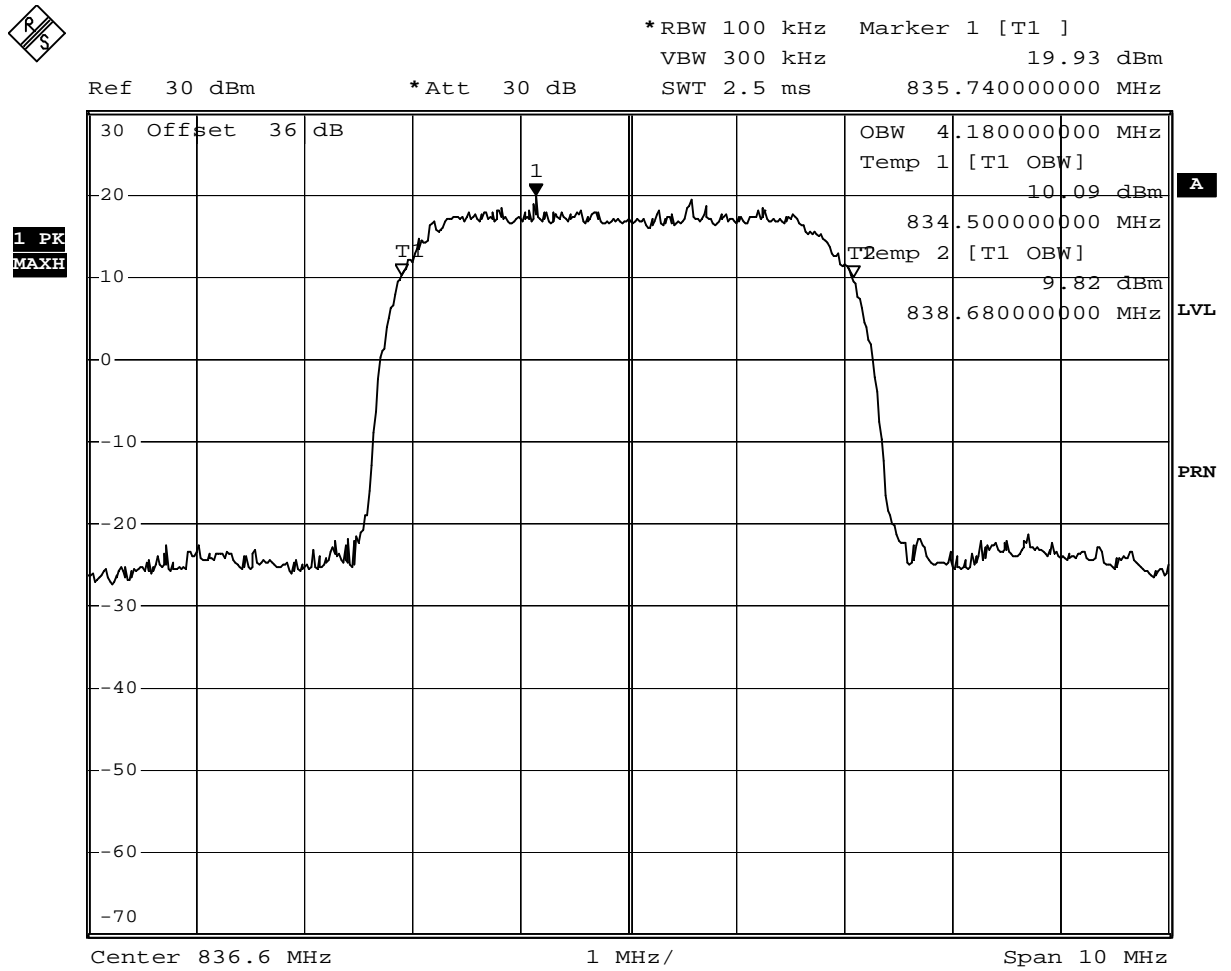


Date: 17.FEB.2007 13:56:05

Test: Emissions bandwidth (26 dB bandwidth), Channel 4183 (836.6 MHz)

**Op. Mode**

op-mode 8



Date: 17.FEB.2007 13:57:21

Test: Occupied bandwidth, Channel 4183 (836.6 MHz)

**Op. Mode**

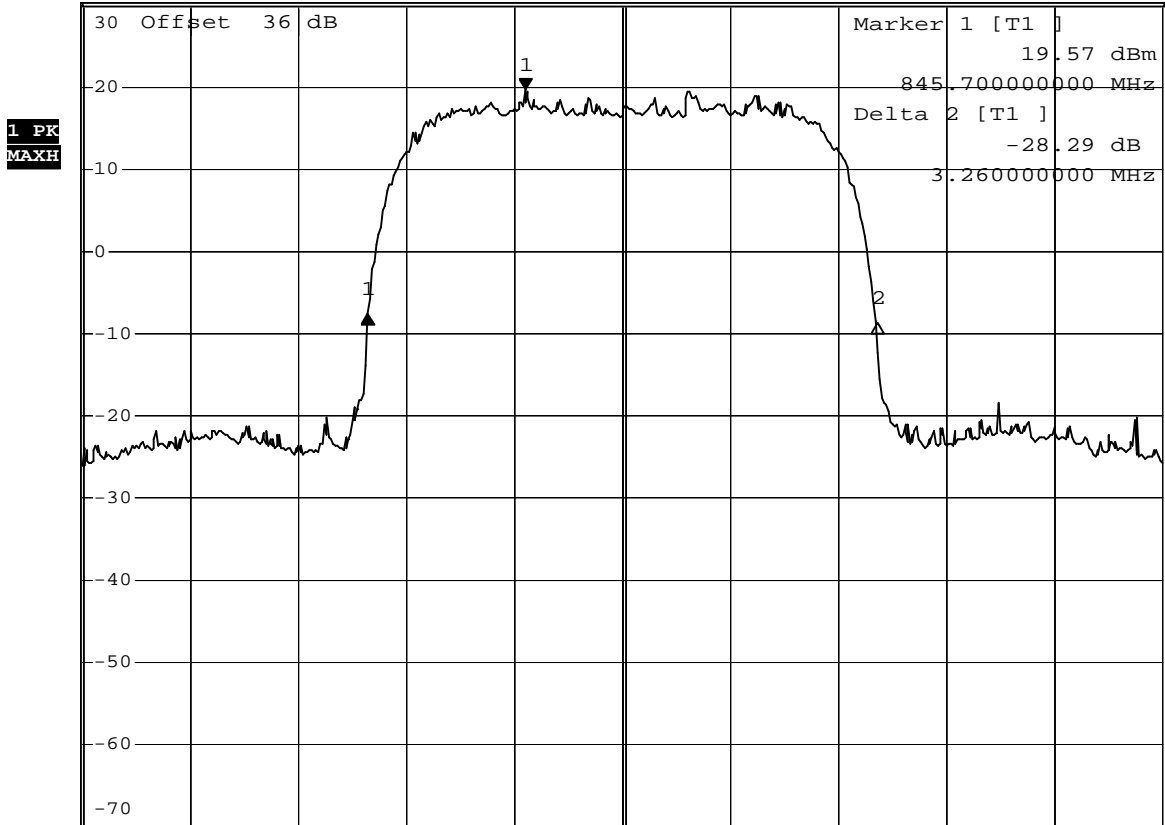
op-mode 9



\*RBW 100 kHz Delta 1 [T1 ]  
 VBW 300 kHz -27.19 dB  
 SWT 2.5 ms -1.460000000 MHz

Ref 30 dBm

\*Att 30 dB



Center 846.6 MHz

1 MHz/

Span 10 MHz

Date: 17.FEB.2007 14:00:00

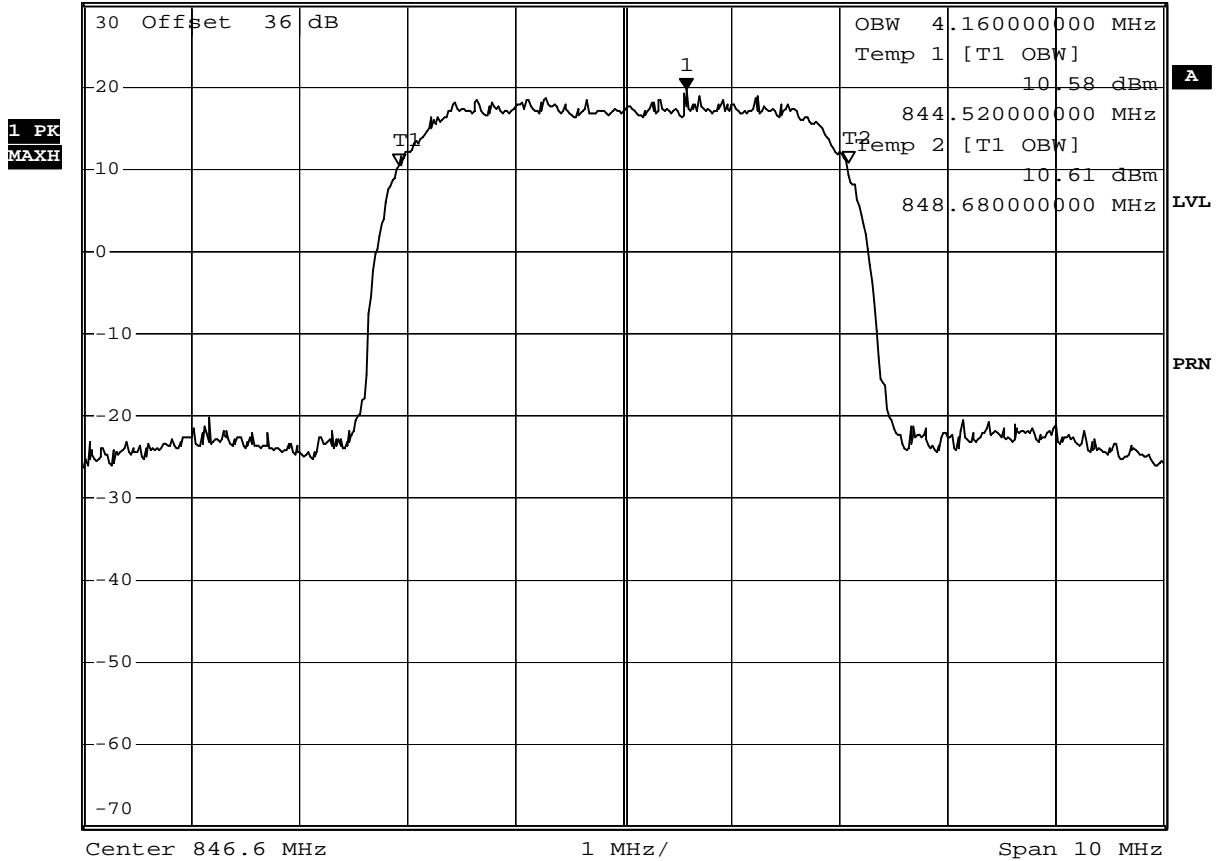
Test: Emissions bandwidth (26 dB bandwidth), Channel 4233 (846.6 MHz)

**Op. Mode**

op-mode 9



\*RBW 100 kHz Marker 1 [T1 ]  
 VBW 300 kHz 19.59 dBm  
 Ref 30 dBm \*Att 30 dB SWT 2.5 ms 847.18000000 MHz




Date: 17.FEB.2007 14:00:56

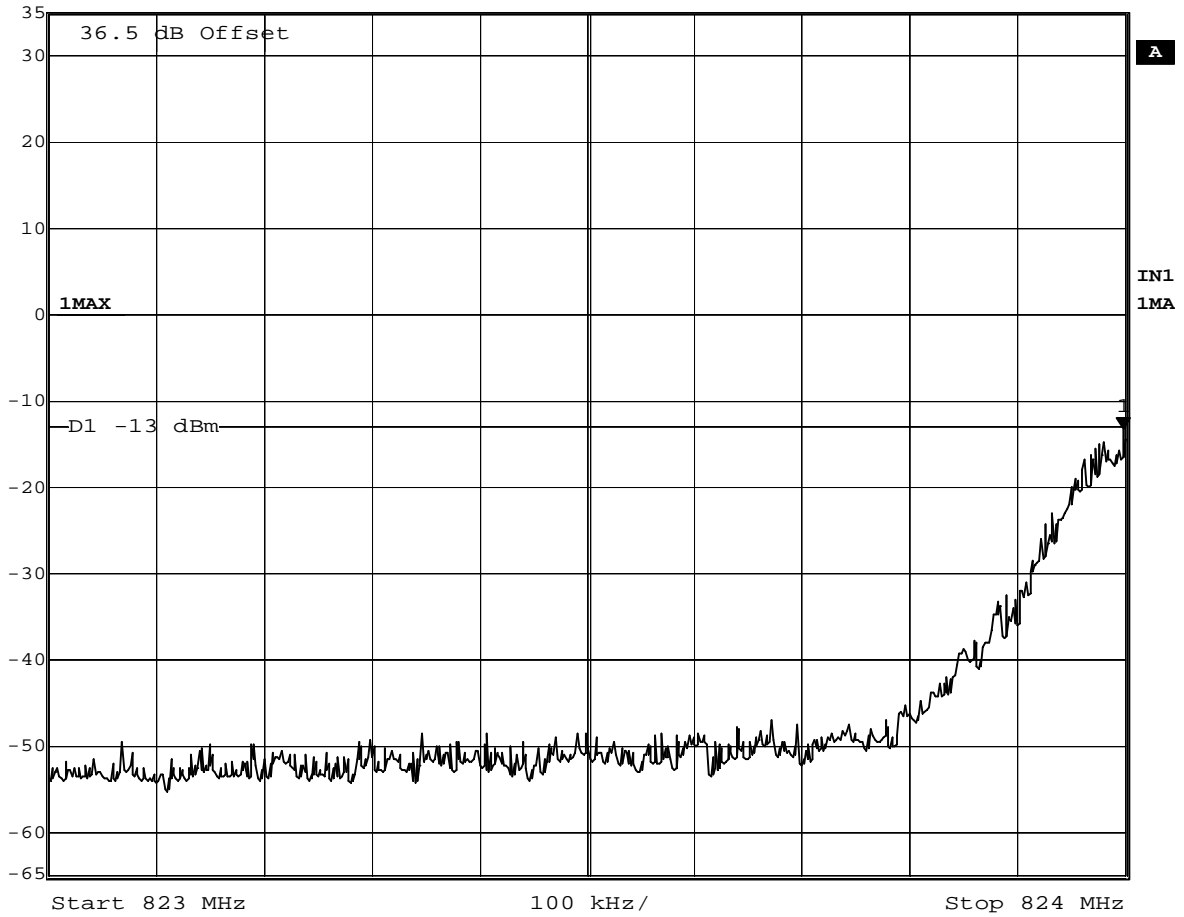
Test: Occupied bandwidth, Channel 4233 (846.6 MHz)

## Measurement plots Band edge compliance

### Op. Mode

op-mode 1

	Marker 1 [T1]	RBW	3 kHz	RF Att	20 dB
	Ref Lvl	-13.32 dBm	VBW	3 kHz	
	35 dBm	823.99799599 MHz	SWT	280 ms	Unit



Date: 9.FEB.2007 20:11:17

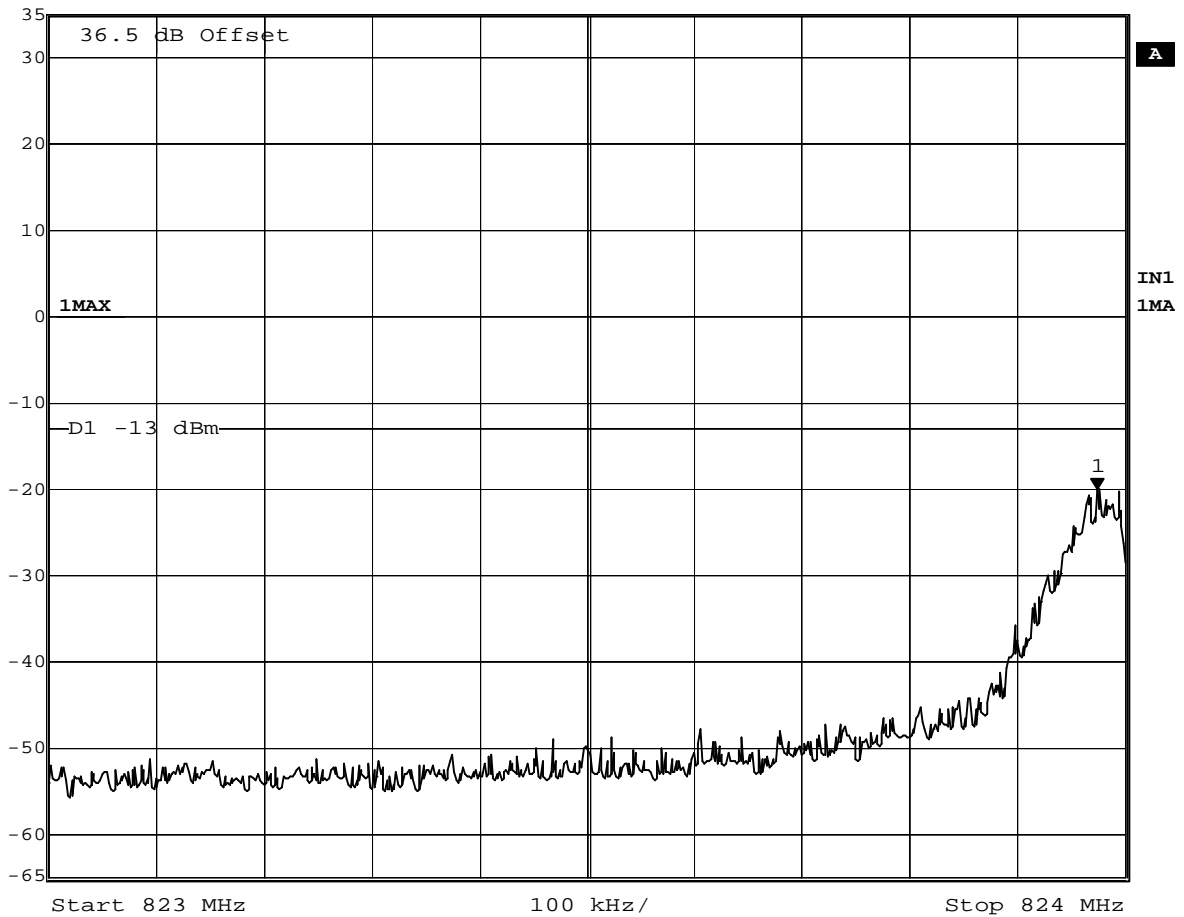
Test: band edge compliance , Channel 128, GSM



**Op. Mode**

op-mode 4

	Marker 1 [T1]	RBW	3 kHz	RF Att	20 dB
Ref Lvl	-20.17 dBm	VBW	3 kHz		
35 dBm	823.97394790 MHz	SWT	280 ms	Unit	dBm



Date: 9.FEB.2007 20:14:19

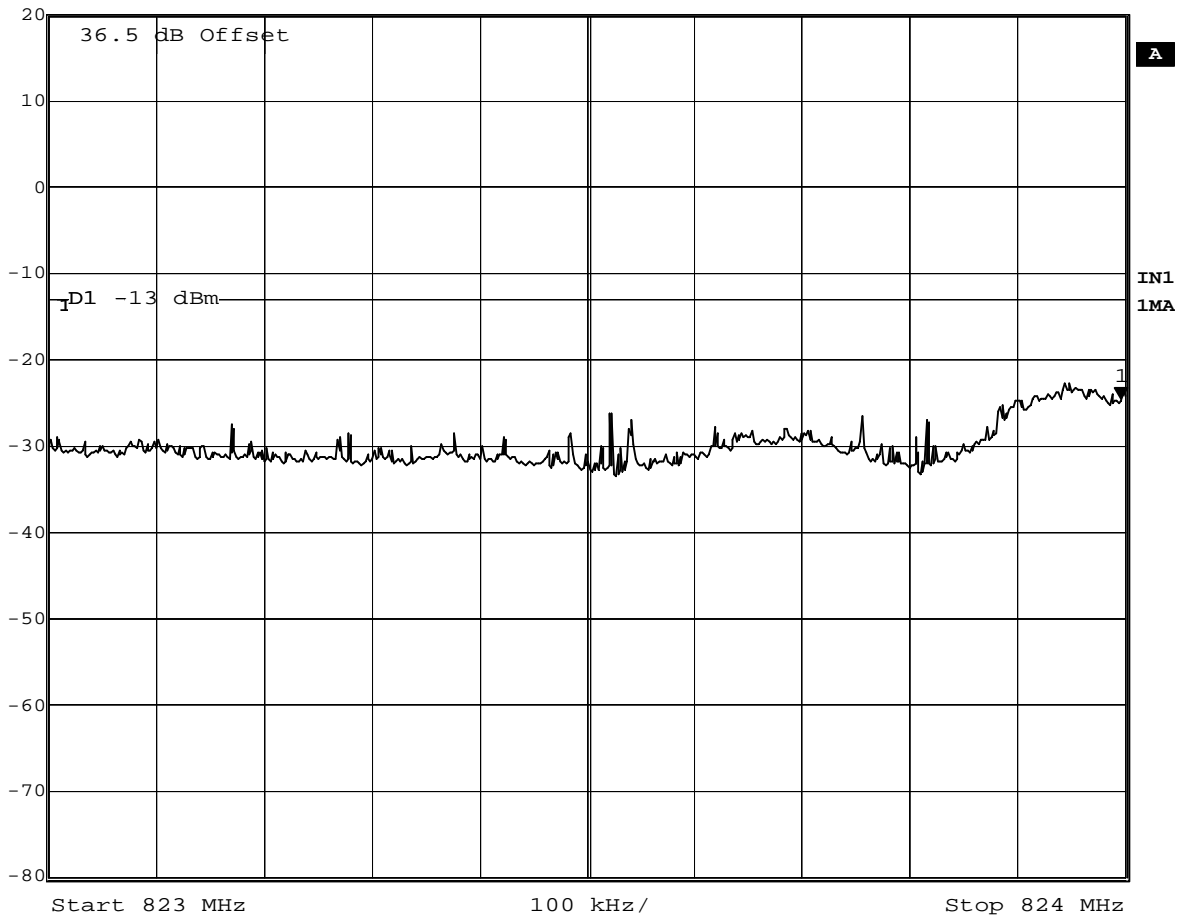
Test: band edge compliance , Channel 128, EDGE



Op. Mode

op-mode 7

	Marker 1 [T1]	RBW	50 kHz	RF Att	10 dB
Ref Lvl	-24.52 dBm	VBW	50 kHz		
20 dBm	823.99599198 MHz	SWT	5 ms	Unit	dBm



Date: 9.FEB.2007 20:32:12

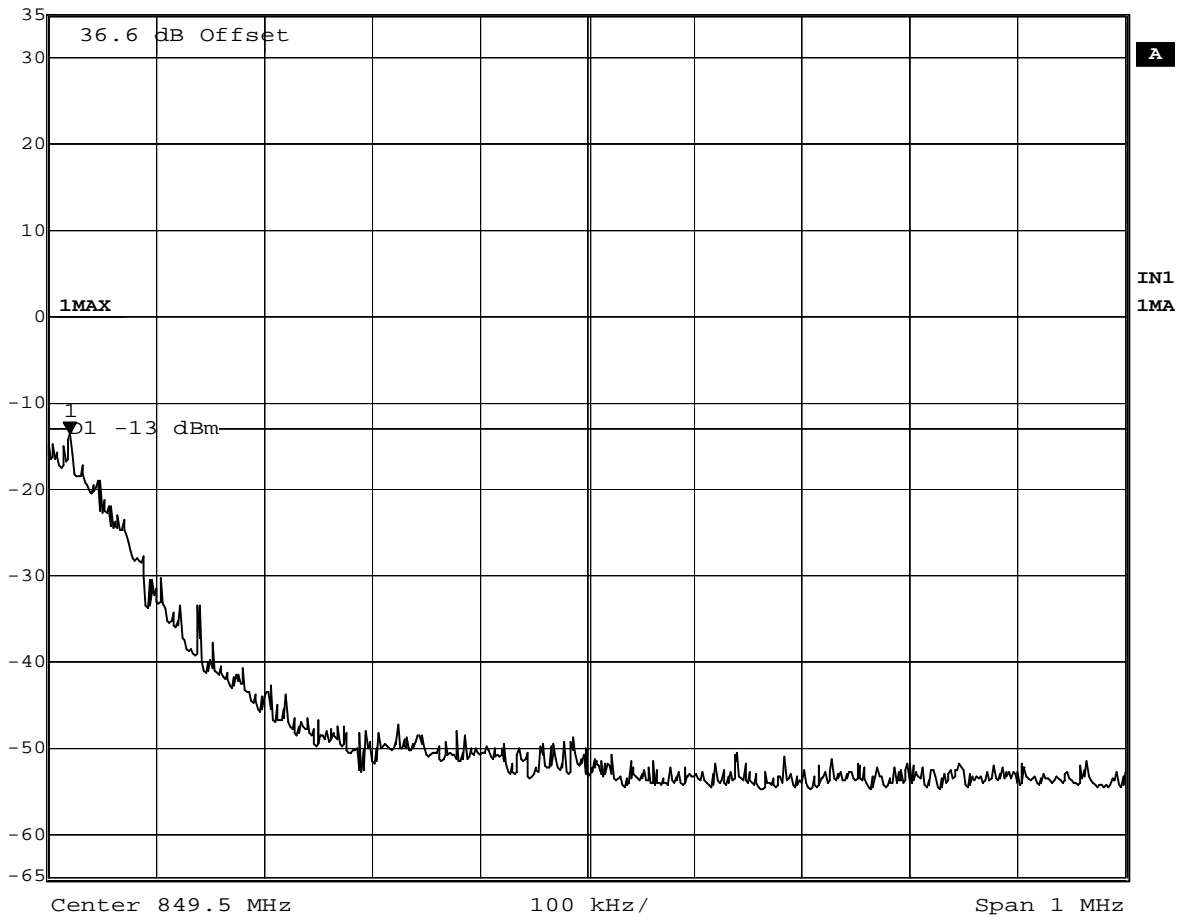
Test: band edge compliance , Channel 4132, FDD V



**Op. Mode**

op-mode 3

	Marker 1 [T1]	RBW	3 kHz	RF Att	20 dB
Ref Lvl	-13.67 dBm	VBW	3 kHz		
35 dBm	849.02004008 MHz	SWT	280 ms	Unit	dBm




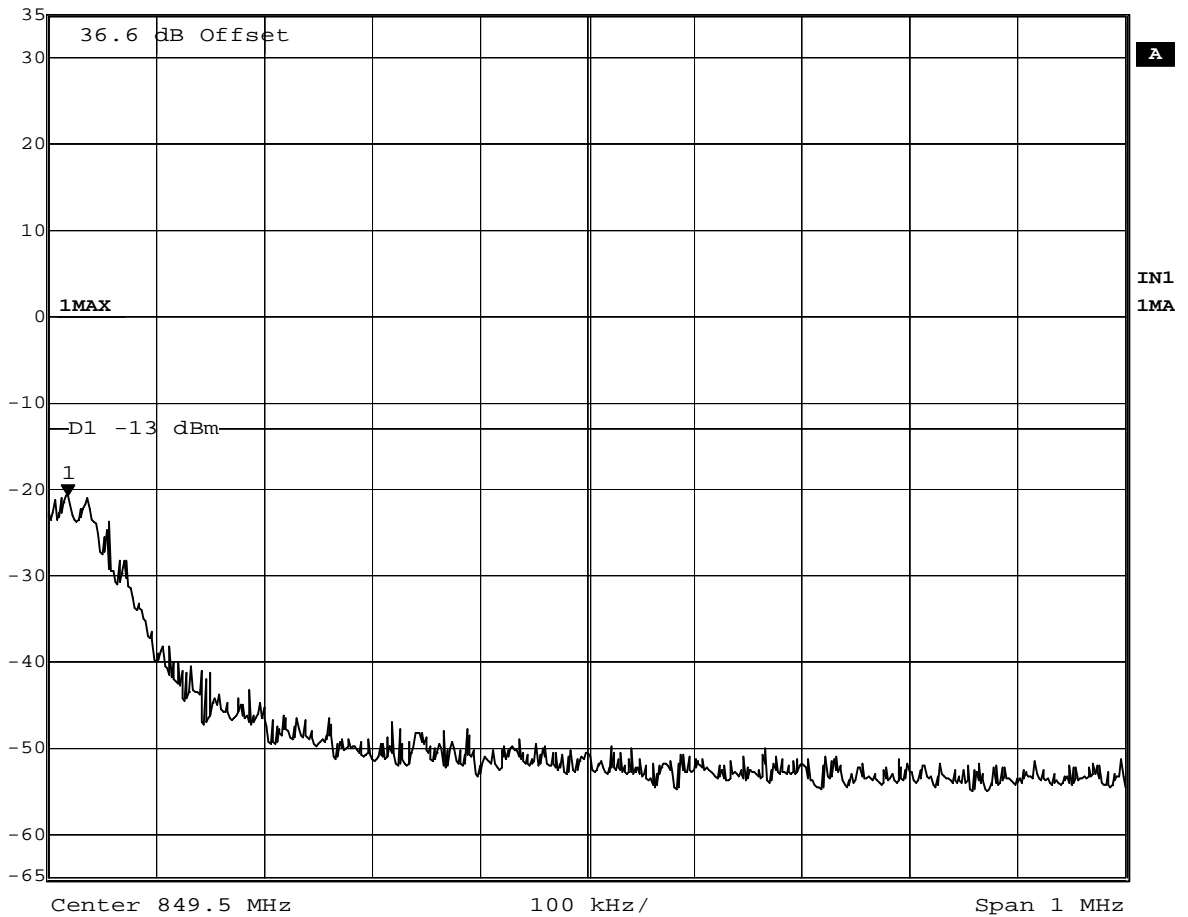
Date: 9.FEB.2007 20:04:10

Test: band edge compliance , Channel 251, GSM

**Op. Mode**

op-mode 6

	Marker 1 [T1]	RBW	3 kHz	RF Att	20 dB
	Ref Lvl	-20.91 dBm	VBW	3 kHz	
	35 dBm	849.01803607 MHz	SWT	280 ms	Unit dBm




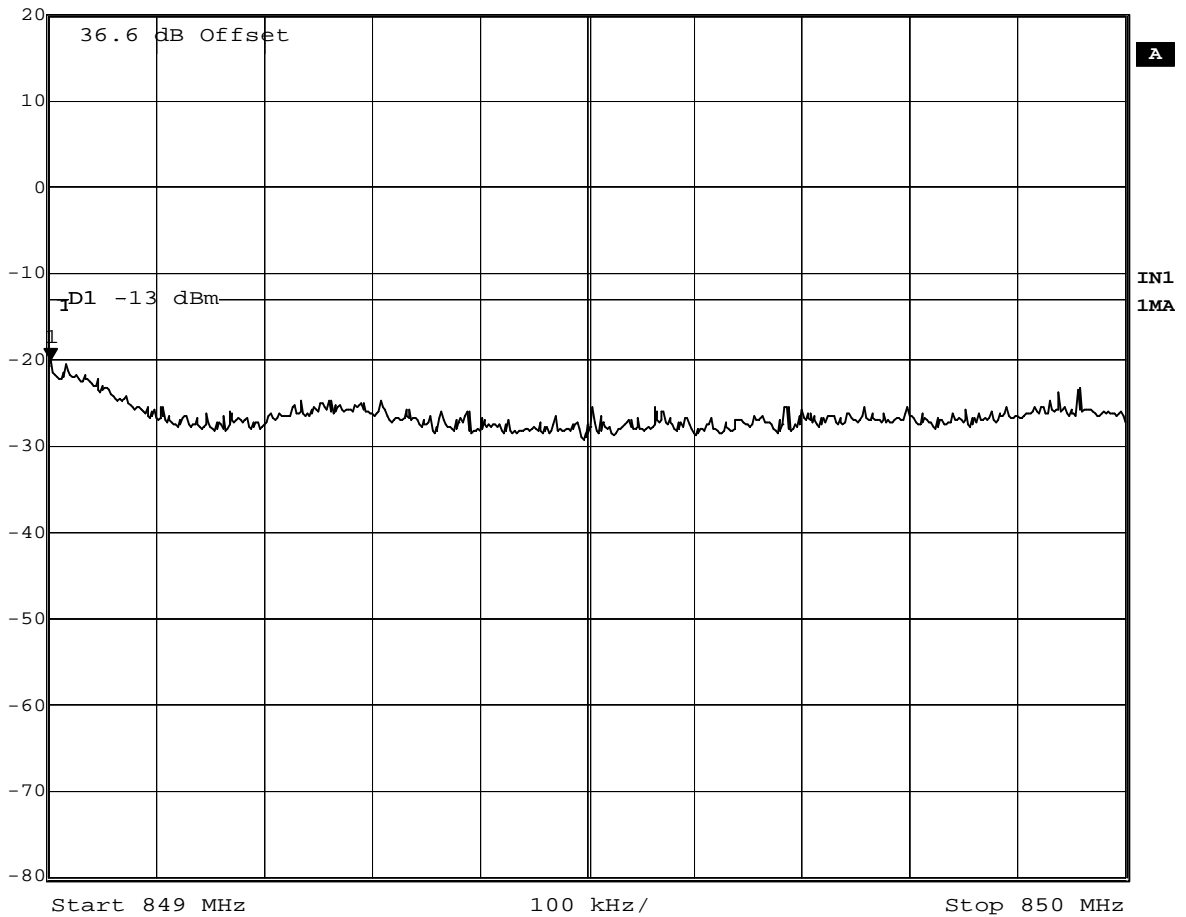
Date: 9.FEB.2007 20:15:26

Test: band edge compliance, Channel 251, EDGE

## Op. Mode

op-mode 9

	Marker 1 [T1]	RBW	50 kHz	RF Att	10 dB
	Ref Lvl	-20.15 dBm	VBW	50 kHz	
	20 dBm	849.00200401 MHz	SWT	5 ms	Unit



Date: 9.FEB.2007 20:43:09

Test: band edge compliance, Channel 4233, FDD V