

A

B

C

D

E

F

1

2

3

4

5

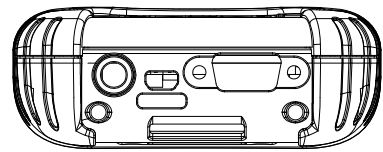
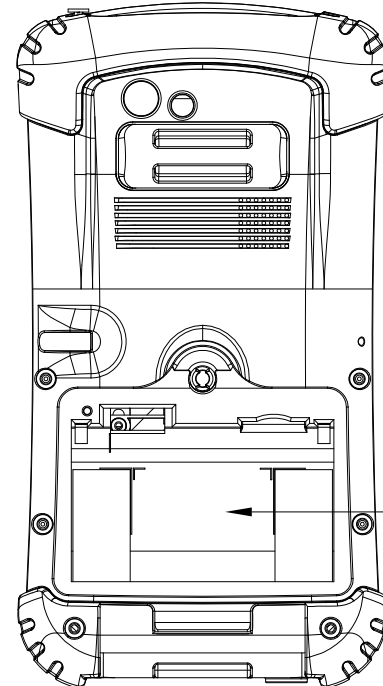
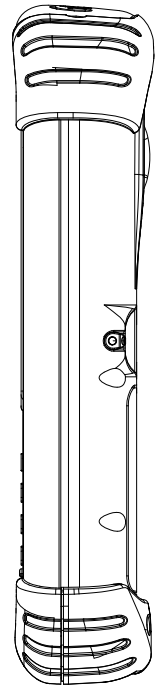
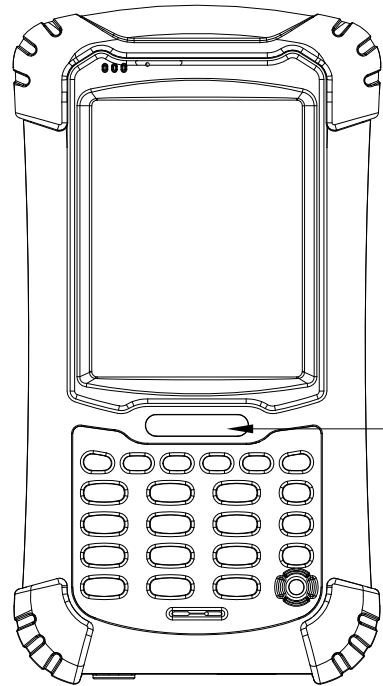
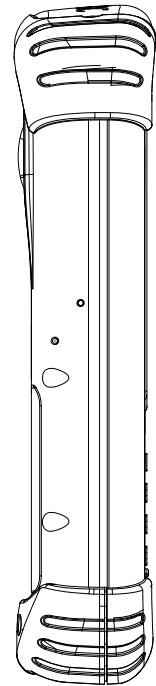
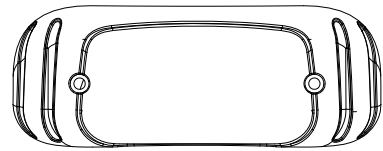

① GETAC LOGO



② LABEL; RATING

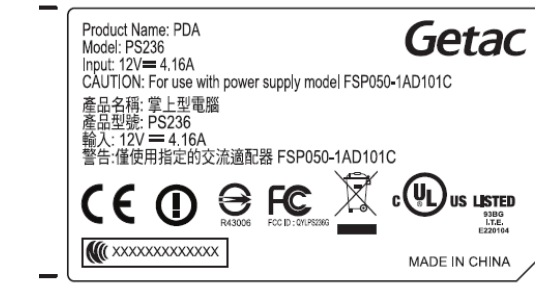

3	242816800010	TF1-LABEL; BAR CODE, BLANK, 7*24MM, PS535E	1	IE Printing
②	242820900005	TF1-LABEL; RATING, WORLDWIDE, W/3G, PS236	1	
①	241821500002	TF1-GETAC LOGO; PS535F	1	
ITEM	PART NO.	DESCRIPTION	Q'TY	REMARK

										DATE	06-AUG-2009	MATERIAL	SEE NOTES	TREATMENT	REMARK		
										UNIT	MM	SCALE	— —	DRAWING NAME	TF1-LABEL KIT; WORLDWILD, WZ 3G, GETAC, PS236		
										DRAWN	DESIGNED	CHECKED	APPROVED	MATERIAL NO.	AD 451	8209 10051 R 00	
										MITAC Technology Corp.							
ITEM	CONTENTS OF CHANGE				RVS	CHK	APV	M/D/Y									

A

B

C

D

E

SHEET No. 1 of 1