

Getac

S410 Series

USER MANUAL

November 2020

TRADEMARKS

The Bluetooth® word mark and logos are registered trademarks owned by Bluetooth SIG, Inc.

All brand and product names are trademarks or registered trademarks of their respective companies.

NOTE

The information in this manual is subject to change without notice. For the latest version of the manual, please visit the Getac website at www.getac.com.

Table of Contents

Chapter 1	Getting Started.....	1
	Getting the Computer Running.....	2
	Unpacking.....	2
	Connecting to AC Power.....	3
	Turning On and Off the Computer.....	4
	Taking a Look at the Computer.....	6
	Front Components.....	6
	Rear Components.....	7
	Right-Side Components.....	8
	Left-Side Components.....	9
	Top-open Components.....	10
	Bottom Components.....	13
Chapter 2	Operating Your Computer.....	15
	Using the Keyboard.....	16
	Typewriter Keys.....	16
	Cursor-Control Keys.....	16
	Numeric Keypad.....	17
	Function Keys.....	17
	Fn Key.....	17
	Hot Keys.....	18
	Windows Keys.....	19
	Using the Touchpad.....	20
	Touch Gestures for Windows 10.....	21
	Configuring the Touchpad.....	21
	Using the Touchscreen (Optional).....	22
	Using Multi-touch Gestures.....	23
	Using the Tether (Optional).....	25
	Using Network and Wireless Connections.....	26
	Using the LAN.....	26
	Using the WLAN.....	27

	Using the Bluetooth Feature	28
	Using the WWAN Feature (Optional)	29
	Using the Optical Disc Drive (Optional).....	31
	Inserting and Removing a Disc	32
	Using the Fingerprint Scanner	33
	Enrolling a Fingerprint	33
	Using the Contactless Smart Card Reader (Optional).....	34
	Using the Barcode Scanner (Optional)	35
	Notes.....	36
Chapter 3	Managing Power	37
	AC Adapter	38
	Battery Pack.....	39
	Charging the Battery Pack	39
	Initializing the Battery Pack.....	40
	Checking the Battery Level	40
	Battery Low Signals and Actions	40
	Replacing the Battery Pack	41
	Power-Saving Tips	43
Chapter 4	Expanding Your Computer	44
	Connecting Peripheral Devices	45
	Connecting a USB Device	45
	Connecting a Thunderbolt Device.....	46
	Connecting a Device for USB Charging (Optional)	46
	Connecting a Monitor	47
	Connecting a Serial Device (Optional)	48
	Connecting an Audio Device	49
	Using Storage and Expansion Cards	50
	Using Storage Cards	50
	Using Smart Cards.....	51
	Using ExpressCards (Optional).....	52
	Using PC Cards (Optional).....	53
	Changing or Replacing	54
	Changing the Component in the Multi-Purpose Bay.....	54
	Replacing the SSD.....	55
	System Memory Upgrade.....	56
Chapter 5	Using BIOS Setup.....	58
	When and How to Use.....	59
	Menu Descriptions	60
	Information Menu	60
	Main Menu.....	60

	Advanced Menu.....	60
	Security Menu	62
	Boot Menu	63
	Exit Menu	63
Chapter 6	Using Getac Software	65
	G-Manager	66
Chapter 7	Care and Maintenance	67
	Protecting the Computer.....	68
	Using an Anti-Virus Strategy.....	68
	Using the Cable Lock	68
	Taking Care of the Computer	69
	Location Guidelines	69
	General Guidelines	69
	Cleaning Guidelines.....	70
	Battery Pack Guidelines.....	70
	Touchscreen Guidelines.....	72
	When Traveling.....	73
Chapter 8	Troubleshooting	74
	Preliminary Checklist.....	75
	Solving Common Problems.....	76
	Battery Problems	76
	Bluetooth Problems.....	76
	Display Problems.....	77
	DVD Drive Problems	77
	Hardware Device Problems.....	78
	Keyboard and Touchpad Problems	78
	LAN Problems.....	79
	Power Management Problems	79
	Software Problems	79
	Sound Problems	80
	Startup Problems	80
	WLAN Problems	80
	Other Problems.....	82
	Resetting the Computer	83
	System Recovery.....	84
	Using Windows RE.....	84
	Using Recovery Partition	85
	Using the Driver Disc (Optional)	86

Appendix A Specifications	87
Appendix B Regulatory Information.....	89
On the Use of the System	90
Class B Regulations	90
Safety Notices.....	91
On the Use of the RF Device.....	96
USA and Canada Safety Requirements and Notices.....	96
European Union CE Marking and Compliance Notices.....	98
User Notification of Take-back Service.....	100
ENERGY STAR	101
Battery Recycling.....	103
California Proposition 65.....	104
About Battery and External Enclosure Replacement	105
Battery	105
External Enclosure	105

Chapter 1





Getting Started

This chapter first tells you step by step how to get the computer up and running. Then, you will find a section briefly introducing the external components of the computer.

Getting the Computer Running

Unpacking

After unpacking the shipping carton, you should find these standard items:

● S410 notebook computer	
● AC adapter 	● AC power cord 
● Battery pack 	● Stylus* 
	● Tether* 
● Document(s)	● Driver disc*

* Optional

Inspect all the items. If any item is damaged or missing, notify your dealer immediately.

NOTE: Specific models do not have the AC adapter and power cord as standard items. To purchase the AC adapter kit for your model, contact a Getac authorized distributor. (Check <https://www.getac.com/en/contact/> for contact information.)

Connecting to AC Power

CAUTION: Use only the AC adapter included with your computer. Using other AC adapters may damage the computer.

NOTE:

- The battery pack is shipped to you in power saving mode that protects it from charging/discharging. It will get out of the mode to be ready for use when you install the battery pack and connect AC power to the computer for the very first time.
- When the AC adapter is connected, it also charges the battery pack. For information on using battery power, see Chapter 3.

You must use AC power when starting up the computer for the very first time.

1. Plug the DC cord of the AC adapter to the power connector of the computer (❶).
2. Plug the female end of the AC power cord to the AC adapter and the male end to an electrical outlet (❷).



3. Power is being supplied from the electrical outlet to the AC adapter and onto your computer. Now, you are ready to turn on the computer.

Turning On and Off the Computer

Turning On

1. Open the top cover by pulling the cover latch and lifting up the cover. You can tilt the cover forward or backward for optimal viewing clarity.







2. Press the power button (). The Windows operating system should start.



Turning Off

When you finish a working session, you can stop the system by turning off the power or leaving it in Sleep or Hibernation mode:

To...	Do this...
Power off (Shutdown)	Click  →  Power → Shut down .
Sleep	Use one of these methods: <ul style="list-style-type: none">● Press the power button.*● Close the top cover.*● Press Fn + F12.*● Click  →  Power → Sleep.
Hibernate	By default, this option is not shown in the Start menu. If you want to use the feature, set up accordingly in Windows settings.

* "Sleep" is the default result of the action. You can change what the action does through Windows settings.

Taking a Look at the Computer

NOTE: Depending on the specific model you purchased, the color and look of your model may not exactly match the graphics shown in this document.

CAUTION: You need to open the protective covers to access the connectors. When not using a connector, make sure to close the cover completely for water- and dust-proof integrity. (Engage the locking mechanism if existing.)

Front Components

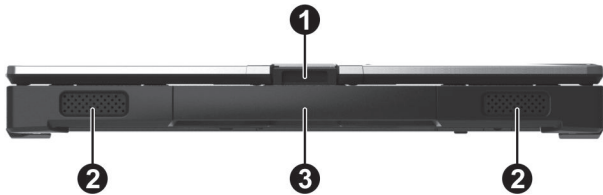

Ref	Component	Description
❶	Top cover latch	Locks the top cover.
❷	Stereo speaker	Sends out sound and voice from the computer.
❸	Handle	Provides a convenient way to carry the computer. NOTE: When carrying the computer around, always use the handle or the carrying strap (purchased separately).

Rear Components

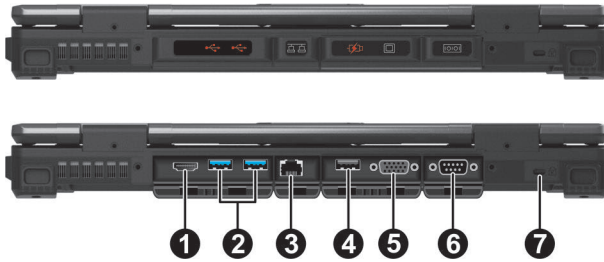

Ref	Component	Description
①	HDMI connector	Connects a HDMI monitor or TV set.
②	USB 3.1 Gen 2 port	Connects a USB device.
③	RJ45 connector	Connects the LAN cable.
④	Depending on the model, the component can be one of the following:	
	RJ45 connector	Connects the LAN cable (for LAN 2).
	PowerShare USB port 3.0	Provides either of the below two functions depending on your setting.
		Charges a connected mobile device.
		- or -
		Functions as a standard USB 3.0 port (default setting).
⑤	Depending on the model, the component can be one of the following:	
	VGA connector	Connects an external display monitor.
	DisplayPort connector	Connects an external display monitor.
	RS-232 serial connector	Connects a serial mouse or serial communication device.

Ref	Component	Description
⑥	RS-232 serial connector	Connects a serial mouse or serial communication device.
⑦	Kensington lock	Locks the computer to a stationary object for security.

Right-Side Components

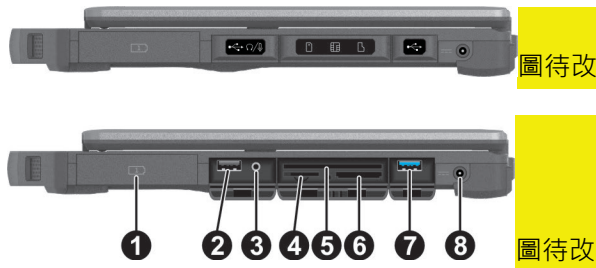

Ref	Component	Description
①	Second Battery pack (optional)	Provides additional battery power to your computer.
②	Stylus slot	For storing the stylus (optional).
③	Tether hole	Stylus tethered to this hole.
④	USB 2.0 port	Connects a USB device.
⑤	Smart card reader	Accepts a smart card for additional security feature.
⑥	SIM card slot (optional)	Accepts a SIM card for models having the WWAN module. NOTE: The slot still exists but cannot be used for models without the WWAN module.
⑦	Combo audio connector	Connects a set of headphones or external speakers with amplifier. Supports a headset microphone with 4-pole TRRS 3.5mm jack.

Ref	Component	Description
⑧	Storage card reader	Accepts a microSD card for removable storage media.
⑨	USB-C Thunderbolt 3 port	Connects to devices that support Thunderbolt or USB-C connection.
⑩	Power connector	Connects the AC adapter.

Left-Side Components



Ref	Component	Description
①	This is a multi-purpose bay. Select models have one of the below components:	
	Additional battery pack	Provides additional battery power to your computer.
		Typically as the third battery pack
	Super multi drive	Accepts a compact disc.
	PC card slot	Accepts a PC card for additional functions.
	ExpressCard slot	Accepts an ExpressCard for additional functions.
	Barcode scanner	Scans and reads barcodes.
	Second SSD	Provides additional storage space to your computer.
	Discrete GPU module	Provides high graphics processing performance to your computer.





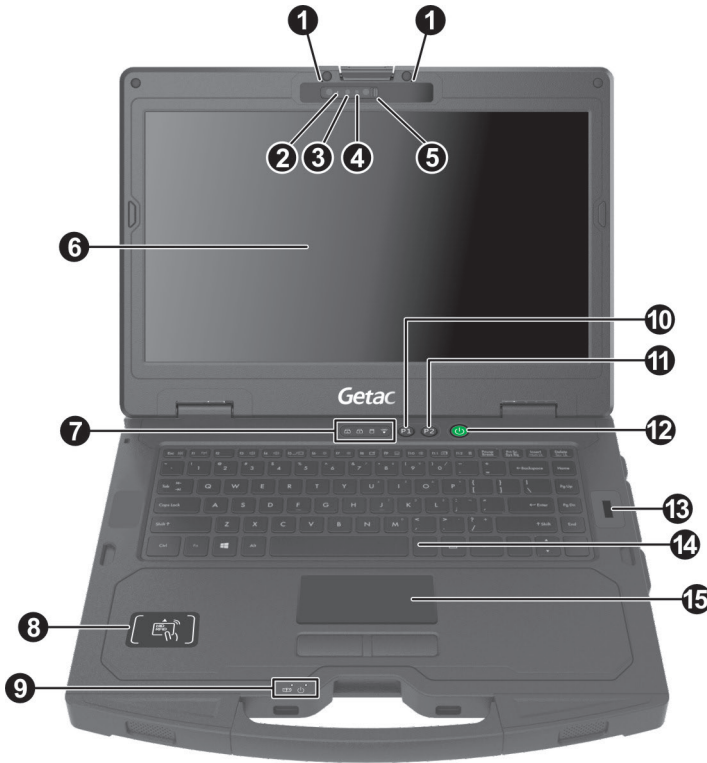

Ref	Component	Description
②	Battery pack	Supplies power to your computer when external power is not connected.

Top-open Components



圖待改

Ref	Component	Description
①	Microphone	Receives sound and voice for the computer.
②	Camera indicator (optional)	Lights up when the camera is in use.
③	IR sensor (optional)	Detects the infrared energy of objects to form an image. The sensor flashes red light when in use.

Ref	Component	Description
		The near infrared (IR) imaging capability allows you to use Windows Hello face authentication.
④	Camera lens (optional)	Allows you to use the camera function.
⑤	Camera cover (optional)	Covers the camera lens. Slide the camera cover toward the right to use the camera; slide it toward the left for privacy protection.
⑥	LCD screen	Displays the output of the computer. Select models have the touchscreen feature.
⑦	Indicators	
	 Caps Lock	Lights green when Caps Lock is on.
	 Num Lock	Lights green when Num Lock is on.
	 SSD	Blinks green when the computer is accessing the SSD.
	 Airplane mode	Lights green when the RF radio of any RF feature (WLAN/Bluetooth/MWWAN) is on. If Airplane mode is switched on, the light turns off.
⑧	Contactless smart card reader (optional)	Serves as an RFID reader/writer.
⑨	Indicators	
	 Battery	Lights amber when the battery is being charged.
		Lights green when battery charging is completed.
		Blinks green to indicate the battery's built-in high temperature protection mechanism is activated. CAUTION: Do not remove the battery during this period.
		Blinks red when the battery's capacity is below 10 %.
		Blinks amber when the battery is in an abnormal condition.
	 Power	Lights green when computer is on.

Ref	Component	Description
		Blinks green when computer is in Sleep mode.
10	P1 button	Toggles Blackout mode on or off. In Blackout mode, the LCD backlight, keyboard/ button backlight, and LED indicators are all turned off; and the sound is muted.
		Serves as the trigger button for the barcode scanner if your model has the module.
		Can be changed to a different function using G-Manager.
11	P2 button	Toggles the sunlight-readable mode on or off. In sunlight-readable mode, the LCD brightness is increased to the highest level.
		Can be changed to a different function using G-Manager.
12	Power button	Turns the power on or off. (The default "off" state is "Sleep mode.")
13	Fingerprint scanner	Serves as the fingerprint verification, preventing unauthorized access to your computer.
14	Keyboard	Serves as the data input device of the computer.
15	Touchpad	Serves as the pointing device of the computer.

Bottom Components

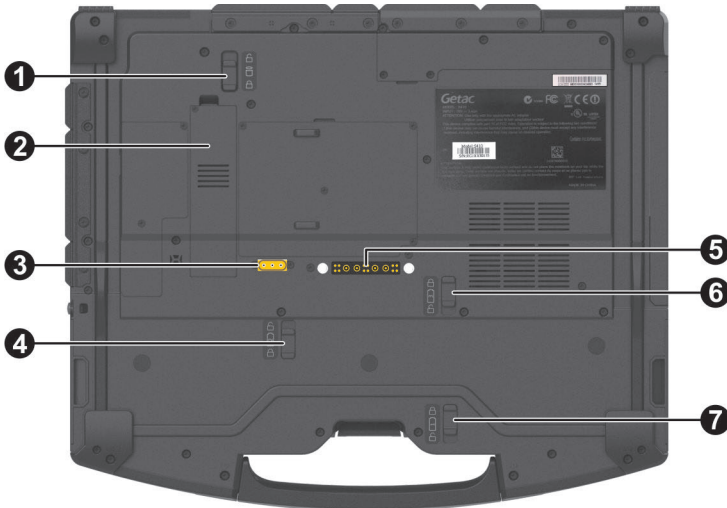

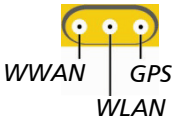
Ref	Component	Description
①	SSD cover latch	Locks the SSD cover in place.
②	SSD	Inside is the solid-state drive, which is the mass storage device of your computer.
③	Antenna pass-through (optional)	Connects to the docking station for using external WWAN/WLAN/GPS antenna. 
④	Battery latch	Locks the second battery pack (if existing) in place.
⑤	Docking connector	Connects to the office or vehicle dock (purchased separately).
⑥	Security latch	Locks the component in the multi-purpose bay in place. This latch functions only if the component is user-removable.

Ref	Component	Description
7	Battery latch	Locks the main battery pack in place.

Chapter 2

Operating Your Computer

This chapter provides information about the use of the computer.

If you are new to computers, reading this chapter will help you learn the operating basics. If you are already a computer user, you may choose to read only the parts containing information unique to your computer.

CAUTION:

- Do not expose your skin to the computer when operating it in a very hot or cold environment.
- The computer can get uncomfortably warm when you use it in high temperatures. As a safety precaution in such a circumstance, do not place the computer on your lap or touch it with your bare hands for extended periods of time. Prolonged body contact can cause discomfort and potentially a burn.

Using the Keyboard

Your keyboard has all the standard functions of a full-sized computer keyboard plus an **Fn** key added for specific functions.

The standard functions of the keyboard can be further divided into four major categories:

- Typewriter keys
- Cursor-control keys
- Numeric keys
- Function keys

Typewriter Keys

Typewriter keys are similar to the keys on a typewriter. Several keys are added such as the **Ctrl**, **Alt**, **Esc**, and lock keys for special purposes.

The Control (**Ctrl**) / Alternate (**Alt**) key is normally used in combination with other keys for program-specific functions. The Escape (**Esc**) key is usually used for stopping a process. Examples are exiting a program and canceling a command. The function depends on the program you are using.

Cursor-Control Keys

Cursor-control keys are generally used for moving and editing purposes.

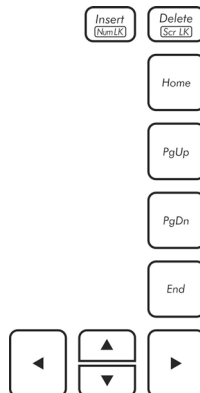

NOTE: The word “cursor” refers to the indicator on the screen that lets you know exactly where on your screen anything you type will appear. It can take the form of a vertical or horizontal line, a block, or one of many other shapes.

Numeric Keypad

A 15-key numeric keypad is embedded in the typewriter keys as shown next:

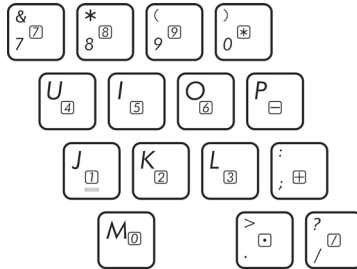

Numeric keys facilitate entering of numbers and calculations. When Num Lock is on, the numeric keys are activated; meaning you can use these keys to enter numerals.

NOTE:

- When the numeric keypad is activated and you need to type the English letter in the keypad area, you can turn Num Lock off or you can press **Fn** and then the letter without turning Num Lock off.
- Some software may not be able to use the numeric keypad on the computer. If so, use the numeric keypad on an external keyboard instead.
- The **Num Lock** key can be disabled. (See “Main Menu” in Chapter 5.)

Function Keys

On the top row of the keys are the function keys: **F1** to **F12**. Function keys are multi-purpose keys that perform functions defined by individual programs.









Fn Key

The **Fn** key, at the lower left corner of the keyboard, is used with another key to perform the alternative function of a key. To perform a desired function, first press and hold **Fn**, then press the other key.

Hot Keys

Hot keys refer to a combination of keys that can be pressed any time to activate special functions of the computer. Most hot keys operate in a cyclic way. Each time a hot key combination is pressed, it shifts the corresponding function to the other or next choice.

You can easily identify the hot keys with the icons imprinted on the keytop. The hot keys are described next.

Key	Description
	Switches the keyboard backlight off or on (with 4-level brightness). *
	Switches the RF (radio frequency) radio on and off. When off, all wireless modules (such as WLAN, Bluetooth, and WWAN) cannot be used. When on, individual settings of the module work.
	Decreases the sound volume.
	Increases the sound volume.
	<p>Switches the display output to the next choice if an external display is connected. Choices are:</p> <pre> graph TD A[LCD only] --> B[LCD + External display Duplicate] B --> C[LCD + External display Extend] C --> D[External display only] D --> A </pre> <p>The hot keys are equivalent to  Windows logo key + P.</p>
	Decreases the LCD brightness.
	Increases the LCD brightness.















Key	Description
 	Switches the touchscreen function off or on.*
 	Switches the touchpad function off or on.
 	Switches the system sound output off (mute) or on.
 	Switches the display backlight off or on.
 	Serves as the sleep button that you can define with Windows' Power Options .

TABLE NOTE: * means "select models only."

Windows Keys

The keyboard has two keys that perform Windows-specific functions:  Windows Logo key and  Application key.

The  Windows Logo key opens the **Start** menu and performs software-specific functions when used in combination with other keys. The  Application key usually has the same effect as a right mouse click.

Using the Touchpad

CAUTION: Do not use a sharp object such as a pen on the touchpad. Doing so may damage the touchpad surface.

NOTE:

- You can press **Fn+F9** to toggle the touchpad function on or off.
- For optimal performance of the touchpad, keep your fingers and the pad clean and dry. When tapping on the pad, tap lightly. Do not use excessive force.

The touchpad is a pointing device that allows you to communicate with the computer by controlling the location of the pointer on the screen and making selection with the buttons.



The touchpad consists of a rectangular pad (work surface) and a left and right buttons. To use the touchpad, place your forefinger or thumb on the pad. The rectangular pad acts like a miniature duplicate of your display. As you slide your fingertip across the pad, the pointer (also called cursor) on the screen moves accordingly. When your finger reaches the edge of the pad, simply relocate yourself by lifting the finger and placing it on the other side of the pad.

Here are some common terms that you should know when using the touchpad:

Term	Action
Point	Move your finger on the pad until the cursor points to the selection on the screen.

Term	Action
Click	Press and release the left button. –or– Tap gently anywhere on the pad.
Double-click	Press and release the left button twice in quick succession. –or– Tap twice on the pad rapidly.
Drag and drop	Press and hold the left button, then move your finger until you reach your destination (drag). Finally, release the button (drop) when you finish dragging your selection to the destination. The object will drop into the new location. –or– Gently tap twice on the pad and on the second tap, keep your finger in contact with the pad. Then, move your finger across the pad to drag the selected object to your destination. When you lift your finger from the pad, the selected object will drop into place.

TABLE NOTE: If you swap the left and right buttons, “tapping” on the touchpad as an alternative method of pressing the left button will no longer be valid.

Touch Gestures for Windows 10

The touchpad supports touch gestures for Windows 10 such as two-finger scrolling, pinch zoom, rotating, and others. For settings information, go to **Settings → Devices → Touchpad**.

Configuring the Touchpad

You may want to configure the touchpad to suit your needs. For example, if you are a left-handed user, you can swap the two buttons so that you can use the right button as the left button and vice versa. You can also change the size of the on-screen pointer, the speed of the pointer, and so on.

To configure the touchpad, go to **Settings → Devices → Touchpad**.

Using the Touchscreen (Optional)

NOTE: You can press **Fn+F8** to toggle the touchscreen function on or off.

CAUTION: Do not use a sharp object such as a ballpoint pen or pencil on the touchscreen. Doing so may damage the touchscreen surface. Use your finger or the included stylus.

Select models have a capacitive touchscreen. This type of touchscreen responds to objects that have conductive properties, such as fingertips and a capacitive-tipped stylus. You can navigate on the screen without using a keyboard, touchpad, or mouse.

You can change the touchscreen sensitivity settings to suit your scenario. Double-tap the **Touch Screen Mode** shortcut on Windows desktop to open the settings menu and select one of the options (as shown below).



Select this if you prefer using fingertips. Also, select this when raindrops are falling on the screen and should be rejected as input.

Select this if you are wearing gloves (referring to warm gloves or work gloves, not referring to touchscreen-capable gloves).

Select this if you are using the stylus. (You must use the one supplied with your model.)

NOTE:



- In high temperatures (above 60 °C / 140 °F), set the mode to **Touch** instead of **Glove** or **Pen** mode.
- If liquid is spilled on the touchscreen causing a wet area, the area will stop responding to any inputs. For the area to function again, you must dry it.

The following table shows how you use the touchscreen to obtain equivalent mouse functions.

Term/Action	Equivalent Mouse Function
Tap: Touch the screen once.	Click/Point
Double-tap: Touch the screen twice rapidly.	Double-click
Tap and hold: Tap and hold until a popup menu appears.	Right-click
Drag: Hold the stylus (or finger) on the screen and drag across the screen until reaching your destination.	Drag

Using Multi-touch Gestures

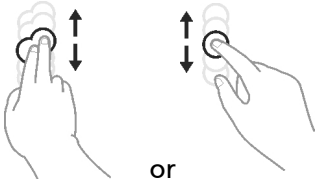
You can interact with your computer by placing two fingers on the screen. The movement of the fingers across the screen creates “gestures,” which send commands to the computer. Here are the multi-touch gestures that you can use:

Gestures	Actions (○ = finger down; ◉ = finger up)	Descriptions
Pan (Scroll)	 <p>Drag 1 or 2 fingers up or down.</p>	Use panning to see another part of a page that has scroll bars.
Zoom (Pinch)	 <p>Move two fingers apart/toward each other.</p>	Use zooming to make an item (a photo for example) on the screen larger or smaller. The gesture works in applications that support mouse wheel zooming.

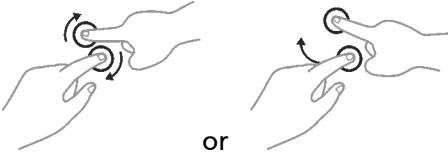
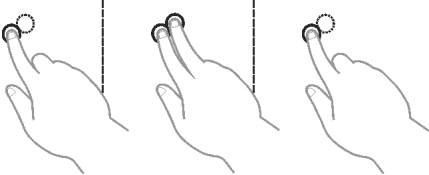
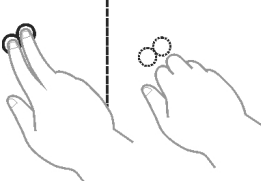
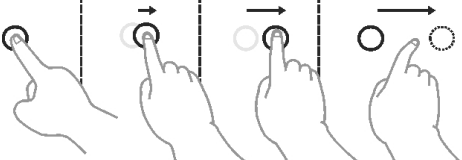
Gestures	Actions (○ = finger down; ○ = finger up)	Descriptions
Rotate	 <p>or</p> <p>Move two fingers in opposing directions. -or- Use one finger to pivot around another.</p>	Use rotating to move a picture or other item on the screen in a circular direction (clockwise or counter-clockwise). The gesture works in applications that support the specific gesture.
Press and Tap	 <p>Press on target and tap using a second finger.</p>	Use press and tap to access the shortcut menu.
Two-finger Tap	 <p>Tap two fingers at the same time (where the target is in the midpoint between the fingers).</p>	The function is defined by applications that support the specific gesture.
Flicks	 <p>Make quick drag gestures in the desired direction.</p>	Flick left or right to navigate back and forward in a browser and other applications. The gesture works in most applications that support back and forward.

Using the Tether (Optional)

You can purchase a stylus and tether for your computer model. Use the tether to attach the stylus to the computer.

1. Insert one of the tether's loop ends through the hole of the stylus (as indicated by ❶ below). Then, insert the other end through the first loop (as indicated by ❷ below) and pull it tight.

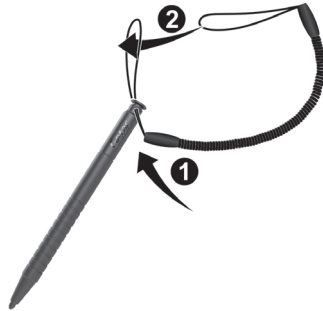

2. Insert the other loop end to the hook on the computer (as indicated by ❶ below). Then, insert the stylus end through the loop (as indicated by ❷ below) and pull it tight.

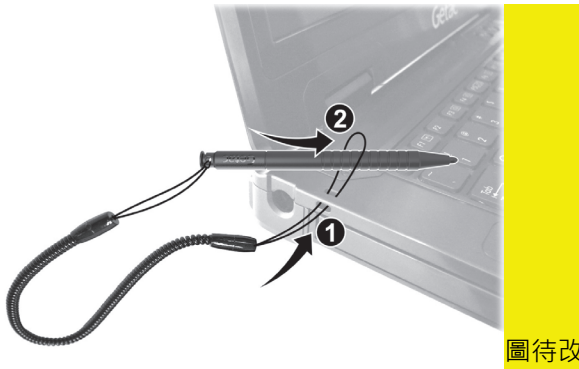

3. When not in use, store the stylus in the stylus slot.

CAUTION: Be careful the tether does not get in the way when you connect the computer to the office or vehicle dock.

Using Network and Wireless Connections

Using the LAN

The internal 10/100/1000Base-T LAN (Local Area Network) module allows you to connect your computer to a network. It supports data transfer rate up to 1000 Mbps.



Select models have a second LAN module so you can connect to two networks at the same time.



NOTE: LAN2 module implements DSM (Deep Slumber Mode) to save battery power. Power is supplied to the LAN module only when the LAN cable is connected. This means the LAN module will not appear in Windows' **Device Manager** if the LAN cable is not connected and will appear if the cable is connected.

Using the WLAN

The WLAN (Wireless Local Area Network) module supports IEEE 802.11ax.

Turning On/Off the WLAN Radio

To turn on the WLAN radio:

Click  → **Settings** → **Network & Internet** → **Wi-Fi**. Slide the **Wi-Fi** switch to the **On** position.

To turn off the WLAN radio:

You can turn off the WLAN radio the same way you turn it on.

If you want to quickly turn off all wireless radio, simply switch on Airplane mode. Click  → **Settings** → **Network & Internet** → **Airplane mode**. Slide the **Airplane mode** switch to the **On** position.

Connecting to a WLAN Network

1. Make sure that the WLAN function is enabled (as described above).
2. Click the network icon  in the lower right of the task bar.
3. In the list of available wireless networks, click a network, and then click **Connect**.
4. Some networks require a network security key or passphrase. To connect to one of those networks, ask your network administrator or Internet service provider (ISP) for the security key or passphrase.

For more information on setting a wireless network connection, refer to Windows online help.

Using the Bluetooth Feature

The Bluetooth technology allows short-range wireless communications between devices without requiring a cable connection. Data can be transmitted through walls, pockets and briefcases as long as two devices are within range.

Turning On/Off the Bluetooth Radio

To turn on the Bluetooth radio:

Click  → **Settings** → **Devices** → **Bluetooth**. Slide the **Bluetooth** switch to the **On** position.

To turn off the Bluetooth radio:

You can turn off the Bluetooth radio the same way you turn it on.

If you want to quickly turn off all wireless radio, simply switch on Airplane mode. Click  → **Settings** → **Network & Internet** → **Airplane mode**. Slide the **Airplane mode** switch to the **On** position.

Connecting to another Bluetooth Device

1. Make sure that the Bluetooth function is enabled (as described above).
2. Make sure that the target Bluetooth device is turned on, discoverable and within close range. (See the documentation that came with the Bluetooth device.)
3. Click  → **Settings** → **Devices** → **Bluetooth**.
4. Select the device you want to connect from the search results.
5. Depending on the type of Bluetooth device that you want to connect to, you will need to enter the pertinent information.

For detailed information on using the Bluetooth feature, see Windows' online Help.

Using the WWAN Feature (Optional)

A WWAN (Wireless Wide Area Network) uses mobile telecommunication cellular network technologies to transfer data. The WWAN module of your computer supports 4G LTE or 5G NR.

NOTE: Your model only supports data transmission; voice transmission is not supported.

Installing a SIM Card

1. Turn off the computer and disconnect the AC adapter.
2. Open the cover of the SIM card slot.
3. Remove one screw to detach the small metal plate that covers the SIM card slot.

圖待補

4. Insert the SIM card into the slot. Make sure the golden contact area on the card is facing upward and the beveled corner on the SIM card facing inward.



5. Close the cover.

Turning On/Off the WWAN Radio

To turn on the WWAN radio:

Click  → Settings → Network & Internet → Airplane mode. Slide the Cellular switch to the On position.

To turn off the WWAN radio:

You can turn off the WWAN radio the same way you turn it on.

If you want to quickly turn off all wireless radio, simply switch on Airplane mode. Click  → **Settings** → **Network & Internet** → **Airplane mode**. Slide the **Airplane mode** switch to the **On** position.

Setting up a WWAN Connection

Click  → **Settings** → **Network & Internet** → **Cellular**. (For detailed information on cellular settings in Windows 10, see Microsoft Support website.)

Using the Optical Disc Drive (Optional)

Select models have a Super Multi DVD drive or Blu-ray DVD drive.

CAUTION:

- When inserting a disc, do not use force.
- Make sure that the disc is correctly inserted into the tray, and then close the tray.
- Do not leave the drive tray open. Also, avoid touching the lens in the tray with your hand. If the lens becomes dirty, the drive may malfunction.
- Do not wipe the lens using materials with rough surface (such as paper towel). Instead, use a cotton swab to gently wipe the lens.

FDA regulations require the following statement for all laser-based devices: “Caution, Use of controls or adjustments or performance of procedures other than those specified herein may result in hazardous radiation exposure.”

NOTE: The DVD drive is classified as a Class 1 laser product. This label is located on the DVD drive.



CLASS 1 LASER PRODUCT
LASER KLASSE 1

NOTE: This product incorporates copyright protection technology that is protected by method claims of certain U.S. patents and other intellectual property rights owned by Macrovision Corporation and other rights owners. Use of this copyright protection technology must be authorized by Macrovision Corporation, and is intended for home and other limited viewing uses only unless otherwise authorized by Macrovision Corporation. Reverse engineering or disassembly is prohibited.

Inserting and Removing a Disc

Follow this procedure to insert or remove a disc:

1. Turn on the computer.
2. Press the eject button and the disc tray will slide out partially. Gently pull on it until it is fully extended.
3. To insert a disc, place down the disc in the tray with its label facing up. Slightly press the center of the disc until it clicks into place.

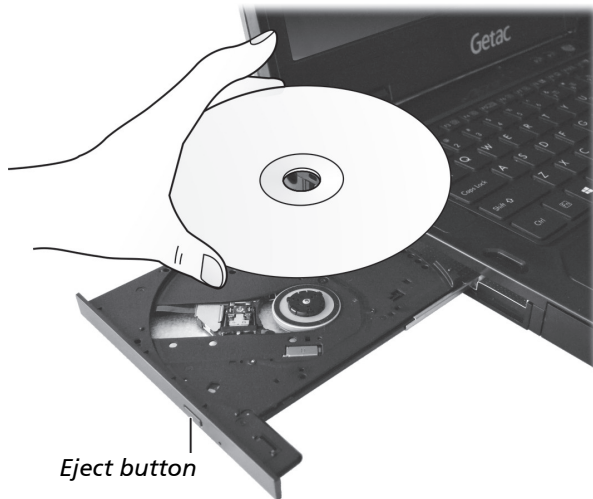

To remove a disc, hold the disc by its outer edge and lift it up from the tray.

4. Gently push the tray back into the drive.

NOTE: In the unlikely event that you are unable to release the drive tray by pressing the eject button, you can manually release the disc. (See “DVD Drive Problems” in Chapter 8.)

Using the Fingerprint Scanner

CAUTION:

- For optimal performance, both the scanning surface and the finger should be clean and dry. Clean the scanning surface when needed. You can use adhesive tape to remove dirt and oil from the scanner surface.
- It is not recommended that you use the fingerprint scanner in a below-freezing temperature. The moisture on your finger can freeze to the scanner's metal surface when you touch it, resulting in a failed operation. Besides, touching freezing metal with your finger can cause frostbite.

The fingerprint scanner provides a strong authentication mechanism based on fingerprint recognition. You can log on to Windows and dismiss the lock screen with an enrolled fingerprint instead of a password.



Enrolling a Fingerprint

NOTE:

- You can enroll a fingerprint only after creating a password for the Windows user account.
- The fingerprint logon process can take a while. This is because the system has to check hardware devices and security configuration before initiating the fingerprint scanner.

1. Click  → **Settings** → **Accounts** → **Sign-in options**.
2. On the right side under **Fingerprint**, click **Set up**.
3. Follow the onscreen instructions to complete.

Using the Contactless Smart Card Reader (Optional)

Select models have a contactless smart card reader module. The reader can read data from HF (High Frequency) RFID (Radio Frequency Identification) tags.



This module is enabled by default. To enable or disable the module, run the BIOS Setup program and select **Advanced** → **Device Configuration** → **RFID Card Reader**. (See Chapter 5 for information on BIOS Setup.)

For optimal results when reading an RFID tag, have the tag face the antenna in the same orientation as indicated by the icon on the exterior of the computer.

NOTE:

- When not using an RFID card, do not leave it within or near the antenna area.
- For enhanced applications and customization of the module, contact your authorized Getac dealer.
- The notebook models with this module do not comply with ENERGY STAR®.

Using the Barcode Scanner (Optional)

NOTE:

- For enhanced applications and customization of the module, you can use the Barcode Manager program. (For detailed information on the program, see the program's online help.)
- The maximum operating temperature for the barcode scanner is 50 °C (122 °F).

If your model has the barcode scanner module, you can scan and decode most common 1D and 2D symbologies. To read barcodes:

1. Start your processing software and open a new or existing file. Place the insertion point (or called cursor) where you want the data to be entered.
2. Press the Trigger button (P1) on your computer. (The button function is configured by G-Manager.)
3. Aim the scan beam at the barcode. (The scan beam projected from the lens varies with models.)

Adjust the lens' distance from the barcode, shorter for a smaller barcode and farther for a larger one.



NOTE: Improper ambient light and scanning angle can affect the scanning results.

CAUTION: When or immediately after using the barcode scanner for a long time, do not touch the lens area as the area might be hot.

4. Upon a successful scan, the system beeps and the decoded barcode data is entered.

Notes

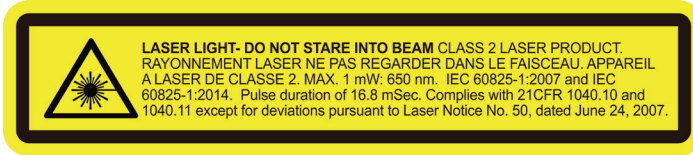

- **Pulse repetition rate:** 57.67 Hz
- **Scan angle:** 360° tilt; ±60° pitch; ±60° skew

Chapter 3

Managing Power

Your computer operates either on external AC power or on internal battery power.

This chapter tells you how you can effectively manage power. To maintain optimal battery performance, it is important that you use the battery in the proper way.

AC Adapter

CAUTION:

- The AC adapter is designed for use with your computer only. Connecting the AC adapter to another device can damage the adapter.
- The AC power cord supplied with your computer is for use in the country where you purchased your computer. If you plan to go overseas with the computer, consult your dealer for the appropriate power cord.
- When you disconnect the AC adapter, disconnect from the electrical outlet first and then from the computer. A reverse procedure may damage the AC adapter or computer.
- When unplugging the connector, always hold the plug head. Never pull on the cord.

The AC adapter serves as a converter from AC (Alternating Current) to DC (Direct Current) power because your computer runs on DC power, but an electrical outlet usually provides AC power. It also charges the battery pack when connected to AC power.

The adapter operates on any voltage in the range of 100-240 VAC.

Battery Pack

The battery pack is the internal power source for the computer. It is rechargeable using the AC adapter.

CAUTION: A battery pack can be removed only when it is not being charged/discharged or if you are hot-swapping the battery pack (for models having more than one battery pack).

NOTE: Care and maintenance information for the battery is provided in the “Battery Pack Guidelines” section in Chapter 7.

Charging the Battery Pack

NOTE:

- Charging will not start if the internal temperature of the battery pack is below 0 °C (32 °F) or above 50 °C (122 °F); the charging process will stop if the internal temperature of the battery pack gets above 60 °C (140 °F). To avoid damaging the battery under this situation, disconnect the AC adapter and wait for the battery to return to room temperature before charging again.
- During charging, do not disconnect the AC adapter before the battery has been fully charged; otherwise you will get a prematurely charged battery.
- The battery has a high temperature protection mechanism which limits the maximum charge of the battery to 80% of its total capacity in the event of high temperature conditions. In such conditions, the battery will be regarded as fully charged at 80% capacity.
- The battery level may automatically lessen due to the self-discharge process, even when the battery pack is fully charged. This happens no matter if the battery pack is installed in the computer.

To charge the battery pack, connect the AC adapter to the computer and an electrical outlet. The Battery Indicator () on the computer glows amber to indicate that charging is in progress. You are advised to keep the computer power off while the battery is being charged. When the battery is fully charged, the Battery Indicator lights green.

It takes approximately 2.5 to 3 hours to fully charge one battery pack. For models having more than one battery pack, the battery packs are charged in sequence.

CAUTION: After the computer has been fully recharged, do not immediately disconnect and reconnect the AC adapter to charge it again. Doing so may damage the battery.

Initializing the Battery Pack

You need to initialize a new battery pack before using it for the first time or when the actual operating time of a battery pack is much less than expected. Initializing is the process of fully charging, discharging, and then charging. It can take several hours.

The G-Manager program provides a tool called “Battery Recalibration” for the purpose. (See “G-Manager” in Chapter 6.)

Checking the Battery Level

NOTE: Any battery level indication is an estimated result. The actual operating time can be different from the estimated time, depending on how you are using the computer.

The operating time of a fully charged battery pack depends on how you are using the computer. When your applications often access peripherals, you will experience a shorter operating time.



You can find the battery icon on the Windows taskbar (lower-right corner). The icon shows the approximate battery level.

For models having more than one battery pack, the battery packs are discharged in parallel.

Battery Low Signals and Actions

The battery icon changes appearance to display the current state of the battery.

Battery Icon	Battery Level	Description
	Discharging	The icon shows the charge remaining in 10-percent increments until the charge reaches the low-battery level.

Battery Icon	Battery Level	Description
	Low	The battery charge has reached the low-battery level.
	Critically low	The battery charge has reached the critical battery level. By default, Windows will display a notification and put your computer into Hibernation.

When the battery is low, the computer's Battery Indicator () also blinks red to alert you to take actions.

Always respond to low-battery by connecting the AC adapter, placing your computer in Hibernation mode, or turning off the computer.

Replacing the Battery Pack

CAUTION:

- There is danger of explosion if the battery is incorrectly replaced. Replace the battery only with the computer manufacturer's optional battery packs. Discard used batteries according to the dealer's instructions.
- Do not attempt to disassemble the battery pack.
- A battery pack can get hot due to long working hours. Do not touch a hot battery pack with bare hands. After removing a battery pack, put it in a well-ventilated area.

NOTE: You can hot swap a battery pack when your computer has another one supplying the power. The appropriate temperature range for hot swapping the battery pack is between -21°C (-5.8°F) and 45°C (113°F).

1. Turn off the computer and disconnect the AC adapter. After turning off the computer, allow a cool-down time of at least 5 minutes before removing the battery pack.

For models having more than one battery pack: Skip this step if you are hot swapping the battery pack.

2. Carefully place the computer upside down.
3. Locate the battery pack you want to remove.

NOTE: If you are replacing the battery pack in the multi-purpose bay, see "Changing the Component in the Multi-Purpose Bay" for instructions.

- Slide the battery latch to the unlocked position (🔓) (❶) and hold it there. Meanwhile, grasp the edge of the battery pack using the other hand and pull it out of the bay (❷).

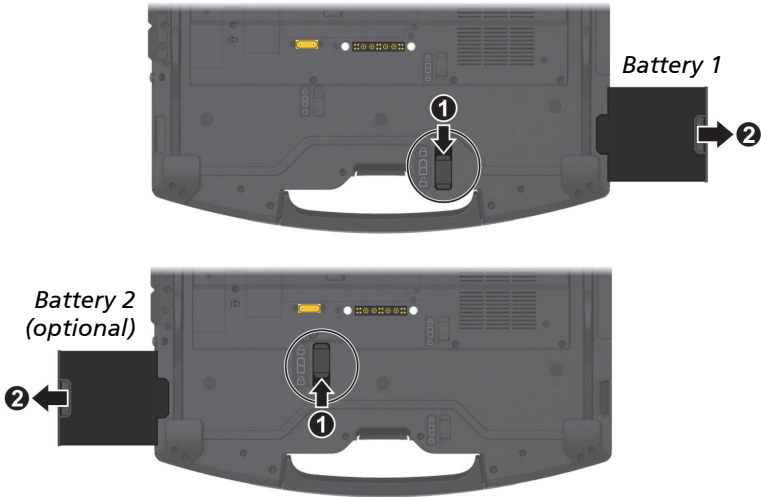

- Noting the orientation, insert the new battery pack all the way into the bay. The battery latch should be engaged in the locked position (🔒).

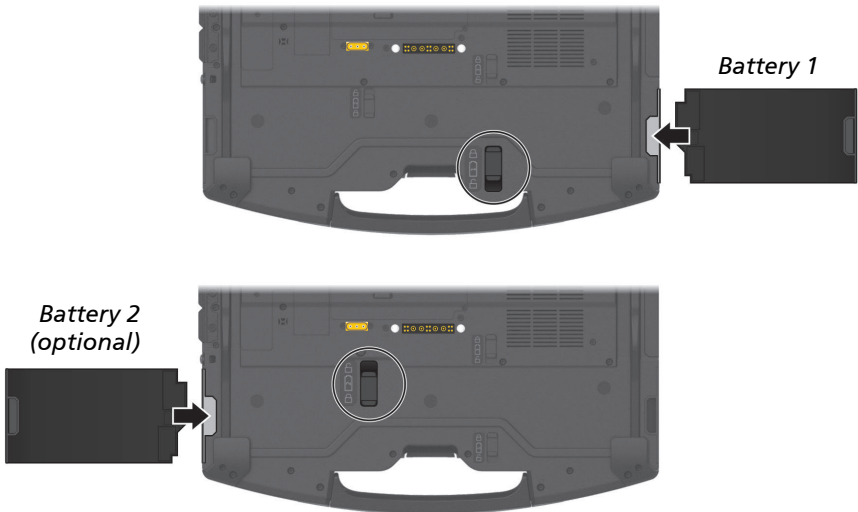

Power-Saving Tips

Aside from enabling your computer's power saving mode, you can do your part to maximize the battery's operating time by following these suggestions.

- Do not disable Power Management.
- Decrease the LCD brightness to the lowest comfortable level.
- Shorten the length of time before Windows turn off the display.
- When not using a connected device, disconnect it.
- Remove the card (such as smart card, ExpressCard, or PC card) if not using it.
- Turn off the wireless radio if you are not using the wireless module (such as WLAN, Bluetooth, or WWAN).
- Turn off the computer when you are not using it.

Chapter 4

Expanding Your Computer

You can expand the capabilities of your computer by connecting other peripheral devices.

When using a device, be sure to read the instructions accompanying the device together with the relevant section in this chapter.

Connecting Peripheral Devices

Connecting a USB Device

NOTE: USB 3.1/3.0 port is backward compatible with USB 2.0 port. However, if necessary, you can set the USB 3.1/3.0 port to be a USB 2.0 port in the BIOS Setup Utility. Go to the utility, select **Advanced** → **Device Configuration**, find the setting item, and change the setting to USB 2.0.

Your computer has three USB Type-A ports for connecting USB devices, such as a digital camera, scanner, printer, and mouse.

USB 3.1 Gen 2 supports a transfer rate up to 10 Gbit/s.

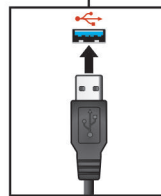

USB 2.0 supports a transfer rate up to 480 Mbit/s.

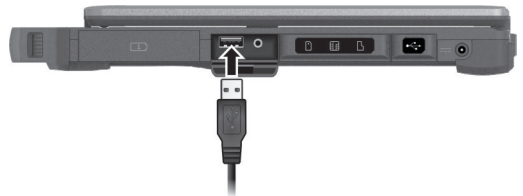

圖待改

NOTE: Select models have a PowerShare USB port. This port can be set to function as a standard USB 3.0 port. (See “Connecting a Device for USB Charging (Optional)” later for information.)

Connecting a Thunderbolt Device

Your computer has a Thunderbolt 3 port. This port features:

- USB-C connector format
- Up to 40 Gbps data transfer speed
- DisplayPort
- Power Delivery
Note that you should use the appropriate wattage/voltage USB-C power adapter for your specific computer model.
For Standard models: 57W or above (19-20V, 3A or above)
For Discrete GPU models: 95W or above (19-20V, 5A or above)

Applications include storage, display, networking, single-cable docking, and more.



NOTE: Thunderbolt 3 ports are backward-compatible with USB-C devices. An USB-C device plugged into a Thunderbolt 3 port will function normally.

Connecting a Device for USB Charging (Optional)

Select models have a PowerShare USB port (⚡). You can use this port to charge mobile devices even when the computer is in power-off, sleep, or hibernation state.



Select models have a VGA connector.



Select models have a DisplayPort connector.



The connected device should respond by default. If not, you can switch the display output by pressing the **Fn+F5** hot keys. (You can also change the display through Windows **Control Panel**.)

Connecting a Serial Device (Optional)

Your computer has one or two RS-232 serial ports for connecting a serial device.

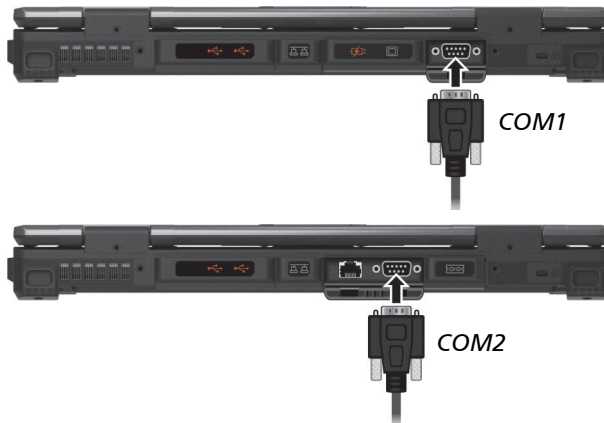

Connecting an Audio Device

The audio combo connector is the “4-pole TRRS 3.5mm” type so you can connect a compatible headset microphone.



SAFETY WARNING: 

To prevent possible hearing damage, do not listen at high volume levels for long periods.

Using Storage and Expansion Cards

Using Storage Cards

Your computer has a storage card reader for reading from and writing to removable storage cards (or called memory cards). The reader supports SD (Secure Digital) and SDXC (Secure Digital eXtended Capacity) cards.

To insert a storage card:

1. Locate the microSD card reader on the right side of the computer and open the cover.
2. Align the card with its connector pointing to the slot and its label facing up. Slide the card into the slot until it reaches the end.

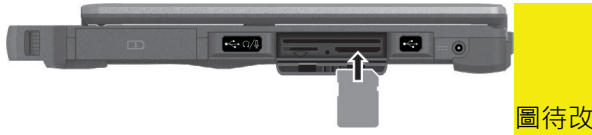

3. Close the cover.
4. Windows will detect the card and assign it a drive name.

To remove a storage card:

1. Open **File Explorer** and click **Computer**.
2. Right-click the drive with the card and select **Eject**.
3. Slightly push the card to release and then pull it out of the slot.
4. Close the cover.

Using Smart Cards

Your computer has a smart card reader. With an embedded microcontroller, smart cards have the unique ability to store large amounts of data, carry out their own on-card functions (e.g., encryption and mutual authentication), and interact intelligently with a smart card reader.

To insert a smart card:

1. Locate the smart card slot on the right of the computer and open the cover.
2. Slide the smart card, with its label and embedded computer chip facing up into the slot.

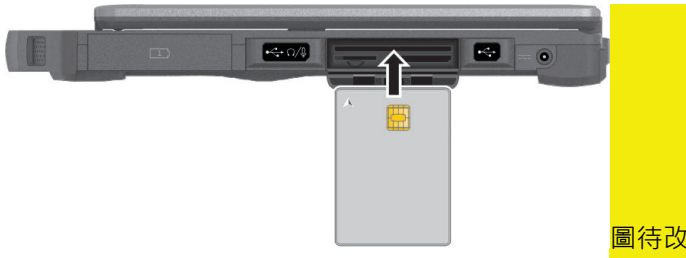

3. Close the cover.

To remove a smart card:

1. Make sure that the third-party smart card software is not accessing the smart card.
2. Pull the card out of the slot.
3. Close the cover.

Using ExpressCards (Optional)

Select models have an ExpressCard slot. The ExpressCard slot can accommodate a 54 mm (ExpressCard/54) or 34 mm (ExpressCard/34) wide ExpressCard. Typical ExpressCards support a very extensive range of applications including memory, wired and wireless communication cards, and security devices.

To insert an ExpressCard:

1. Locate the ExpressCard slot on the left side of the computer.
2. Remove the rubber cover by grasping and pulling out.
3. Slide the ExpressCard, with its label facing up, all the way into the slot until the rear connectors click into place.

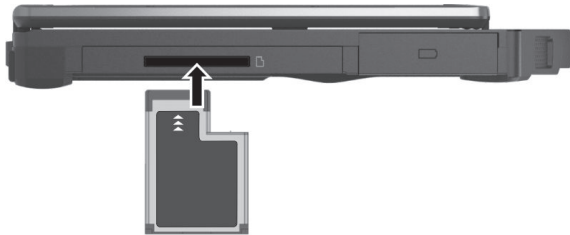

To remove an ExpressCard:

1. Double-click the **Safely Remove Hardware**  icon found on the Windows taskbar and the **Safely Remove Hardware** window appears on screen.
2. Select (highlight) the ExpressCard from the list to disable the card.
3. Slightly push the card to release and then pull it out of the slot.
4. Insert the rubber cover back into place.

Using PC Cards (Optional)

Select models have a PC card slot. The PC card slot supports type II card and CardBus specifications.

To insert a PC card:

1. Locate the PC card slot on the left side of the computer.
2. Remove the rubber cover by grasping and pulling out.
3. Slide the PC card, with its label facing up, into the slot until the eject button pops out.

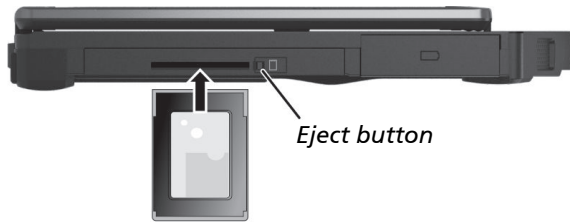

To remove a PC card:

1. Double-click the **Safely Remove Hardware**  icon found on the Windows taskbar and the **Safely Remove Hardware** window appears on screen.
2. Select (highlight) the PC card from the list to disable the card.
3. Push the eject button and the card will slide out slightly.
4. Insert the rubber cover back into place.

Changing or Replacing

Changing the Component in the Multi-Purpose Bay

If you have a user-removable component in the multi-purpose bay, you can purchase a different one and change the component as needed.

1. Turn off the computer and disconnect the AC adapter.
Skip this step if you are removing the battery pack in the multi-purpose bay for the purpose of hot swapping.
2. Carefully place the computer upside down.
3. If removing the DVD drive, unfasten the screw that secures the drive.

圖待補

4. Slide the security latch to the unlocked position (🔓) (❶) and hold it there. Meanwhile, grasp the edge of the existing component using the other hand and pull it out of the bay (❷).

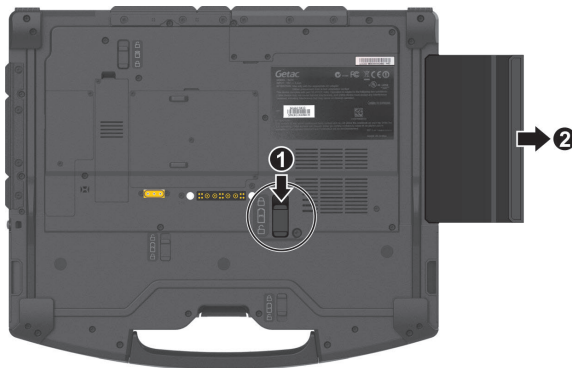

5. Noting the orientation, insert the new component all the way into the bay. The security latch should be engaged in the locked position (🔒).

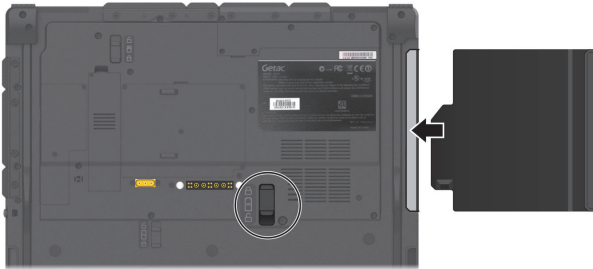

Replacing the SSD

1. Turn off the computer and disconnect the AC adapter.
2. Carefully place the computer upside down.
3. Remove the screw from the SSD cover (❶).
4. Slide the SSD cover latch to the unlocked position (🔓) (❷) and hold it there. Meanwhile, pry open the cover. ???

圖待補

5. Detach the SSD from the system board. 說明文字待補

圖待補



6. Plug the new SSD into place. 説明文字待補

圖待補

System Memory Upgrade

You can upgrade your computer by expanding system memory.

CAUTION:

- It is not recommended that you buy and install RAM modules by yourself. If you want to expand system memory, please ask Getac service center to install DRAM modules for you so that full compatibility can be guaranteed.
- RAM modules are extremely sensitive to static electricity. There are cases where static electricity generated by the human body has adversely affected such modules. When inserting or removing a RAM module, do not touch the terminals or internal components, insert objects other than the module, or allow foreign particles to enter. Doing so has been known to cause damage, fire, or electrical shock.

To install the RAM module:

1. Disconnect the AC adapter and remove the battery pack(s).
2. Carefully place the computer upside down.
3. Remove the 3 screws to open the compartment cover.

圖待補

4. To install the RAM module, match the module's notched part with the socket's projected part and firmly insert the module into the socket at a 20-degree angle (❶). Then push down until the retaining clips lock the module into position (❷).

圖待補

CAUTION: If the RAM module is difficult to insert or difficult to push down, do not force it. Check once more to ensure that the module is positioned correctly.

5. Close the compartment cover and secure with the screws.
6. Replace the battery pack(s).

Chapter 5

Using BIOS Setup

BIOS Setup Utility is a program for configuring the BIOS (Basic Input/ Output System) settings of the computer. BIOS is a layer of software, called firmware, that translates instructions from other layers of software into instructions that the computer hardware can understand. The BIOS settings are needed by your computer to identify the types of installed devices and establish special features.

This chapter tells you how to use the BIOS Setup Utility.

When and How to Use

You need to run BIOS Setup Utility when:

- You see an error message on the screen requesting you to run BIOS Setup Utility.
- You want to restore the factory default BIOS settings.
- You want to modify some specific settings according to the hardware.
- You want to modify some specific settings to optimize the system performance.

To run BIOS Setup Utility, click  → **Settings** → **Update & Security** → **Recovery**. Under **Advanced startup**, click **Restart now**. In the boot options menu, click **Troubleshoot** → **Advanced options** → **UEFI Firmware Settings**. Click **Restart**. In the next menu that appears, use the arrow key to select **Setup Utility** and press **Enter**.

The BIOS Setup Utility main screen appears. In general, you can use the arrow keys to move around and **F5/F6** keys to change the setup values. Keyboard information can be found at the bottom of the screen.

NOTE:

- The actual setting items on your model may differ from those described in this chapter.
- The availability of some setting items depends on the Windows version your computer is running.

Menu Descriptions

Information Menu

The Information menu contains the basic configuration information of the system. There are no user-definable items in this menu.

NOTE: The “Asset Tag” information appears when you have entered the asset number for this computer using the asset management program. The program is provided in the **Asset tag** folder of the Driver disc.

Main Menu

The Main menu contains the various system settings.

- **System Date** sets the system date.
- **System Time** sets the system time.
- **Internal Numlock** sets if the Num Lock function of the built-in keyboard can work. When set to *Enabled*, you can press **Fn + Num LK** to activate the numeric keypad, which is embedded in the typewriter keys. When set to *Disabled*, Num Lock does not work. In this case, you can still press **Fn + a letter key** to enter a number.

Advanced Menu

The Advanced menu contains the advanced settings.

- **System Policy** allows you to choose between *Performance* and *Balance*. If battery life is your first priority, select *Balance*. If you need system performance more than battery life, select *Performance*.
- **AC Initiation** sets if connecting AC power will automatically start or resume the system.
- **USB Power-off Charging (PowerShare USB)** enables or disables the USB charging feature of the PowerShare USB port. When disabled, the PowerShare USB port functions as a standard USB 3.0 port. For detailed information on the PowerShare USB port, see “Connecting a Device for USB Charging (Optional)” in Chapter 4. (This item appears only if your model has the option.)

- **MAC Address Pass Through** allows the system specific MAC address to pass through a connected dock, meaning the dock specific MAC address will be overridden by the system specific MAC address. This feature only works for UEFI PXE boot.
- **Active Management Technology Support** (This item appears only on models supporting vPro.)
Intel AMT Support enables or disables Intel® Active Management Technology BIOS extension execution. AMT allows the system administrator to access an AMT featured computer remotely.
Intel AMT Setup Prompt determines whether the prompt for entering Intel AMT Setup appears or not during POST. (This item only appears when the previous item is set to *Enabled*.)
USB Provisioning of AMT enables or disables the use of a USB key for provisioning Intel AMT.
- **Virtualization Technology Setup** sets Virtualization Technology parameters.
Intel(R) Virtualization Technology enables or disables Intel® VT (Intel Virtualization Technology) feature which provides hardware support for processor virtualization. When enabled, a VMM (Virtual Machine Monitor) can utilize the additional hardware virtualization capabilities provided by this technology.
Intel(R) VT for Directed I/O (VT-d) enables or disables VT-d (Intel® Virtualization Technology for Directed I/O). When enabled, VT-d helps enhance Intel platforms for efficient virtualization of I/O devices.
- **Device Configuration** enables or disables several hardware components. The items available for setting depend on your model.
- **Diagnostics and System Tester**
H2ODST Tool performs system baseline check.
- **Recovery Partition** allows you to restore your Windows 10 system to the factory default state by using the “recovery partition” feature. Recovery partition is a portion of your hard disk drive (SSD) that is set aside by the manufacturer to hold the original image of your system.

WARNING:

- Using this feature will reinstall Windows to your system and configure it to the system’s factory default settings. All data on the hard disk drive (SSD) will be lost.
- Make sure that power is not interrupted during the recovery process. An unsuccessful recovery may result in Windows startup problems.

- **Windows RE** launches Windows Recovery Environment. Windows RE (Windows Recovery Environment) is a recovery environment that provides recovery, repair, and troubleshooting tools in Windows 10.

Security Menu

The Security menu contains the security settings, which safeguard your system against unauthorized use.

NOTE:

- You can set the user password only when the supervisor password has been set.
- If both the administrator and user passwords are set, you can enter any of them for starting up the system and/or entering BIOS Setup. However, the user password only allows you to view/change the settings of certain items.
- A password setting is applied right after it is confirmed. To cancel a password, leave the password empty by pressing the **Enter** key.
- **Set Supervisor/User Password** sets the supervisor/user password. You can set the supervisor/user password to be required for starting up the system and/or entering BIOS Setup.
- **Strong Password** enables or disables strong password. When enabled, the password you set must contain at least one upper-case letter, one lower-case letter, and one digit.
- **Password Configuration** sets the minimum password length. Enter the number in the input field and select **[Yes]**. The number should be between 4 and 64.
- **Password on Boot** allows you to enable or disable the entering of password for booting up your system.
- **Secure Boot Configuration** You can access this item only after setting the **Supervisor Password**.
Secure Boot enables or disables Secure Boot. Secure Boot is a feature that helps prevent unauthorized firmware, operating systems, or UEFI drivers from running at boot time.
Delete all Security Boot Keys deletes all secure boot variables.
Restore Factory Defaults resets secure boot variables to manufacturing defaults.

- Set **HDD 0/ HDD 1 User Password** sets the password for locking the hard disk drive (SSD). After setting a password, the hard disk drive can only be unlocked by the password no matter where it is installed.

NOTE: The item “**Set HDD 1 User Password**” appears only when your model has the second SSD.

- **Security Freeze Lock** enables or disables the “Security Freeze Lock” function. This function is only applicable to SATA drives in AHCI mode. It prevents attacks on the SATA drive by freezing the security state of the drive at POST and also when the system resumes from S3.
- **TPM Setup Menu** sets various TPM parameters.
TPM Support enables or disables TPM support. TPM (Trusted Platform Module) is a component on your computer’s mainboard that is specifically designed to enhance platform security by providing a protected space for key operations and other security critical tasks.
Change TPM State allows you to select between *No Operation* and *Clear*.
- **Intel Trusted Execution Technology** enables utilization of additional hardware capabilities provided by Intel® Trusted Execution Technology.

Boot Menu

The Boot menu sets the sequence of the devices to be searched for the operating system.

Press the arrow key to select a device on the boot order list and then press +/- key to change the order of the selected device.

The [X] sign after a device name means the device is included in the search. To exclude a device from the search, move to the [X] sign of the device and press **Enter**.

Exit Menu

The Exit menu displays ways of exiting BIOS Setup Utility. After finishing with your settings, you must save and exit so that the changes can take effect.

- **Exit Saving Changes** saves the changes you have made and exits BIOS Setup Utility.

- **Exit Discarding Changes** exits BIOS Setup Utility without saving the changes you have made.
- **Load Setup Defaults** loads the factory default values for all the items.
- **Discard Changes** restores the previous values for all the items.
- **Saves Changes** saves the changes you have made.

Chapter 6

Using Getac Software

Getac software includes application programs for specific computer components and utility programs for overall management.

This chapter briefly introduces the programs.

G-Manager

G-Manager allows you to view, manage, and configure several system functions and features. The G-Manager home menu presents four categories. Select a category name to open it.

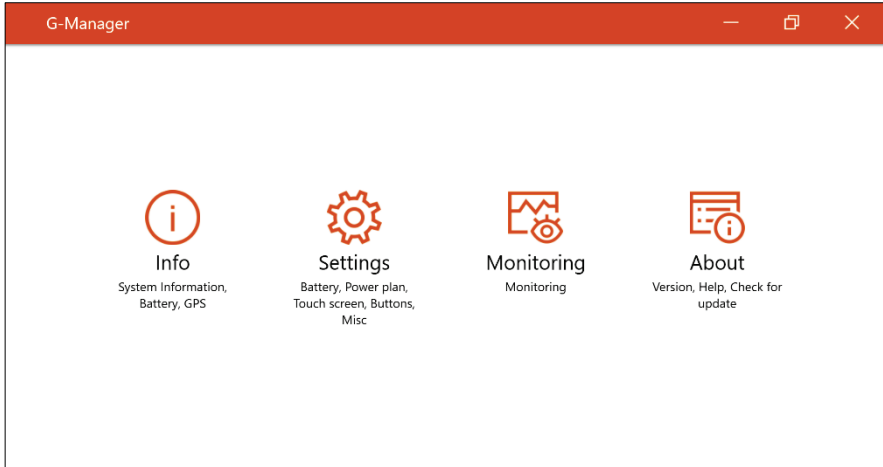

For detailed information, see the program's online help. Select **About** → **Help**.

Chapter 7

Care and Maintenance

Taking good care of your computer will ensure a trouble-free operation and reduce the risk of damage to your computer.

This chapter gives you guidelines covering areas such as protecting, storing, cleaning, and traveling.

Protecting the Computer

To safeguard the integrity of your computer data as well as the computer itself, you can protect the computer in several ways as described in this section.

Using an Anti-Virus Strategy

You can install a virus-detecting program to monitor potential viruses that could damage your files.

Using the Cable Lock

You can use a Kensington-type cable lock to protect your computer against theft. The cable lock is available in most computer stores.

To use the lock, loop the lock cable around a stationary object such as a table. Insert the lock to the Kensington lock hole and turn the key to secure the lock. Store the key in a safe place.

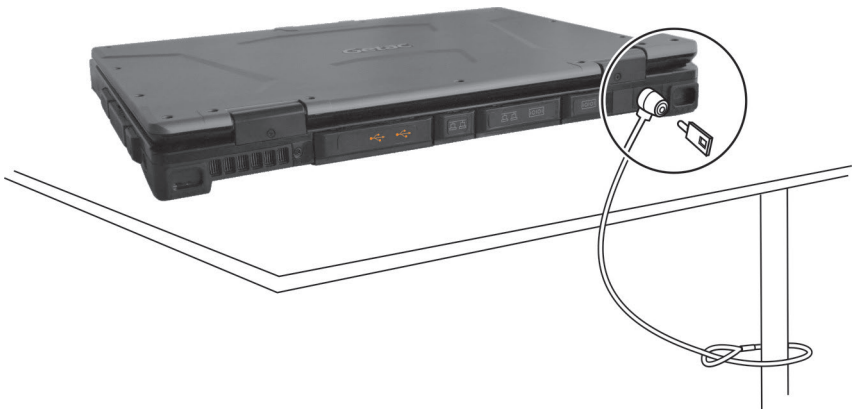

Taking Care of the Computer

Location Guidelines

- For optimal performance, use the computer where the recommended temperature is between 0 °C (32 °F) and 40 °C (104 °F). (Actual operating temperature depends on product specifications.)
- Avoid placing the computer in a location subject to high humidity, extreme temperatures, mechanical vibration, direct sunlight, or heavy dust. Using the computer in extreme environments for long periods can result in product deterioration and a shortened product life.
- Operating in an environment with metallic dust is not allowed.
- Place the computer on a flat and steady surface. Do not stand the computer on its side or store it in an upside-down position. A strong impact by dropping or hitting may damage the computer.
- Do not cover or block any ventilation openings on the computer. For example, do not place the computer on a bed, sofa, rug, or other similar surface. Otherwise, overheating may occur that results in damage to the computer.
- As the computer can become very hot during operation, keep it away from objects that are vulnerable to heat.
- Keep the computer at least 13 cm (5 inches) away from electrical appliances that can generate a strong magnetic field such as a TV, refrigerator, motor, or a large audio speaker.
- Avoid moving the computer abruptly from a cold to a warm place. A temperature difference of more than 10 °C (18 °F) may cause condensation inside the unit, which may damage the storage media.

General Guidelines

- Do not place heavy objects on top of the computer when it is closed as this may damage the display.
- Do not move the computer simply by grasping the display screen.
- To avoid damaging the screen, do not touch it with any sharp object.

- LCD image sticking occurs when a fixed pattern is displayed on the screen for a prolonged period of time. You can avoid the problem by limiting the amount of static content on the display. It is recommended that you use a screen saver or turn off the display when it is not in use.
- To maximize the life of the backlight in the display, allow the backlight to automatically turn off as a result of power management.

Cleaning Guidelines

- Never clean the computer with its power on.
- Use a soft cloth moistened with water or a non-alkaline detergent to wipe the exterior of the computer.
- Gently wipe the display with a soft, lint-free cloth.
- Dust or grease on the touchpad can affect its sensitivity. Clean the pad by using adhesive tape to remove the dust and grease on its surface.
- If water or liquid is split onto the computer, wipe it dry and clean when possible. Though your computer is water-proof, do not leave the computer wet when you can dry it.
- If the computer gets wet where the temperature is 0°C (32°F) or below, freeze damage may occur. Make sure to dry the wet computer.

Battery Pack Guidelines

- Recharge the battery pack when it is nearly discharged. When recharging, make sure that the battery pack is fully charged. Doing so may avoid harm to the battery pack.
- The battery pack is a consumable product and the following conditions will shorten its life:
 - when frequently charging the battery pack
 - when using, charging, or storing in high temperature condition
- To avoid hastening the deterioration of the battery pack thereby prolonging its useful life, minimize the number of times you charge it so as not to frequently increase its internal temperature.

- Charge the battery pack between 10 °C ~ 30 °C (50 °F ~ 86 °F) temperature range. A higher environment temperature will cause the battery pack's temperature to rise. Avoid charging the battery pack inside a closed vehicle and in hot weather condition. Also, charging will not start if the battery pack is not within the allowed temperature range.
- It is recommended that you do not charge the battery pack more than once a day.
- It is recommended that you charge the battery pack with the computer's power off.
- To maintain the battery pack's operating efficiency, store it in a cool dark place removed from the computer and with 30 % ~ 40 % charge remaining.
- Important guidelines when using the battery pack.
When installing or removing the battery pack take note of the following:
 - avoid installing or removing the battery pack when the computer is in Sleep mode. Abruptly removing the battery pack may cause loss of data or the computer may become unstable.
 - avoid touching the battery pack terminals or damage may occur, thereby causing improper operation to it or the computer.
 The computer's input voltage and surrounding temperature will directly affect the battery pack's charge and discharge time:
 - charging time will be prolonged when the computer is turned on. To shorten the charging time, it is recommended that you place the computer in sleep or hibernation mode.
 - a low temperature will prolong the charging time as well as hasten the discharge time.
- When using battery power in an extremely low temperature environment, you may experience shortened operating time and incorrect battery level reading. This phenomenon comes from the chemical characteristics of batteries. The appropriate operating temperature for the battery is -10 °C ~ 50 °C (14 °F ~ 122 °F).
- Do not leave the battery pack in storage for more than six months without recharging it.

Touchscreen Guidelines

- Use the finger or stylus on the display. Using a sharp or metallic object other than your finger or stylus may cause scratches and damage the display, thereby causing errors.
- Use a soft cloth to remove dirt on the display. The touchscreen surface has a special protective coating that prevents dirt from sticking to it. Not using a soft cloth may cause damage to the special protective coating on the touchscreen surface.
- Turn off the computer power when cleaning the display. Cleaning the display with the power on may cause improper operation.
- Do not use excessive force on the display. Avoid placing objects on top of the display as this may cause the glass to break thereby damaging the display.
- In low and high temperatures (below 5 °C / 41 °F and above 60 °C / 140 °F), the touchscreen may have a slower response time or register the touch in the wrong location. It will go back to normal after returning to room temperature.
- When there is noticeable discrepancy in the operation of the touchscreen function (wrong location on intended operation or improper display resolution), refer to the Windows online Help for instructions on recalibrating the touchscreen display.

When Traveling

- Make sure that the battery pack is fully charged.
- Make sure that the computer is turned off and the top cover is securely closed.
- Make sure that all the connector covers are closed completely to ensure the waterproof integrity.
- Do not leave objects in between the keyboard and closed display.
- Disconnect the AC adapter from the computer and take it with you. Use the AC adapter as the power source and as a battery-charger.
- Hand-carry the computer. Do not check it in as luggage.
- If you need to leave the computer in the car, put it in the trunk of the car to avoid exposing the computer to excessive heat.
- When going through airport security, it is recommended that you send the computer and flash disks through the X-ray machine (the device you set your bags on). Avoid the magnetic detector (the device you walk through) or the magnetic wand (the handheld device used by security personnel).
- If you plan to travel abroad with your computer, consult your dealer for the appropriate AC power cord for use in your country of destination.

Chapter 8

Troubleshooting

Computer problems can be caused by hardware, software, or both. When you encounter any problem, it might be a typical problem that can easily be solved.

This chapter tells you what actions to take when solving common computer problems.

Preliminary Checklist

Here are helpful hints to follow before you take further actions when you encounter any problem:

- Try to isolate which part of the computer is causing the problem.
- Make sure that you turn on all peripheral devices before turning on the computer.
- If an external device has a problem, make sure that the cable connections are correct and secure.
- Make sure that the configuration information is properly set in the BIOS Setup program.
- Make sure that all the device drivers are correctly installed.
- Make notes of your observations. Are there any messages on the screen? Do any indicators light? Do you hear any beeps? Detailed descriptions are useful to the service personnel when you need to consult one for assistance.

If any problem persists after you follow the instructions in this chapter, contact an authorized dealer for help.

Solving Common Problems

Battery Problems

The battery does not charge (Battery Charge indicator does not light amber).

- Make sure that the AC adapter is properly connected.
- Make sure that the battery is not too hot or cold. Allow time for the battery pack to return to room temperature.
- If the battery doesn't charge after it has been stored in very low temperatures, try disconnecting and reconnecting the AC adapter to solve the problem.
- Make sure that the battery pack is installed correctly.
- Make sure that the battery terminals are clean.

The operating time of a fully charged battery becomes shorter.

- If you often partially recharge and discharge, the battery might not be charged to its full potential. Initialize the battery to solve the problem.

The battery operating time indicated by the battery meter does not match the actual operating time.

- The actual operating time can be different from the estimated time, depending on how you are using the computer. If the actual operating time is much less than the estimated time, initialize the battery.

Bluetooth Problems

I cannot connect to another Bluetooth-enabled device.

- Make sure that both devices have activated Bluetooth feature.
- Make sure that the distance between the two devices is within the limit and that there are no walls or other obstructions between the devices.
- Make sure that the other device is not in "Hidden" mode.
- Make sure that both devices are compatible.

Display Problems

Nothing appears on the screen.

- During operation, the screen may automatically turn off as a result of power management. Press any key to see if the screen comes back.
- The brightness level might be too low. Increase brightness.
- The display output might be set to an external device. To switch the display back to the LCD, press the **Fn+F5** hot key or change the display through the **Display Settings Properties**.

The characters on the screen are dim.

- Adjust the brightness and/or contrast.

The display brightness cannot be increased.

- As a protection, the display brightness will be fixed at a low level when the surrounding temperature is too high or too low. It is not a malfunction in this situation.

Bad dots appear on the display at all times.

- A small number of missing, discolored, or bright dots on the screen are an intrinsic characteristic of TFT LCD technology. It is not regarded as a LCD defect.

DVD Drive Problems

The DVD drive cannot read a disc.

- Make sure that the disc is correctly seated in the tray, with the label facing up.
- Make sure that the disc is not dirty. Clean the disc with a disc cleaning kit, available in most computer stores.
- Make sure that the computer supports the disc or the files contained.

You cannot eject a disc.

- The disc is not properly seated in the drive. Manually release the disc by inserting a small rod, such as a straightened paperclip, into the drive's manual eject hole and pushing firmly to release the tray.



Hardware Device Problems

The computer does not recognize a newly installed device.

- The device may not be correctly configured in the BIOS Setup program. Run the BIOS Setup program to identify the new type.
- Make sure if any device driver needs to be installed. (Refer to the documentation that came with the device.)
- Check the cables or power cords for correct connections.
- For an external device that has its own power switch, make sure that the power is turned on.

Keyboard and Touchpad Problems

The keyboard does not respond.

- Try connecting an external keyboard. If it works, contact an authorized dealer, as the internal keyboard cable might be loose.

Water or liquid is spilt into the keyboard.

- Immediately turn off the computer and unplug the AC adapter. Then turn the keyboard upside down to drain the liquid out of the keyboard. Make sure to clean up any part of the spill you can get to. Though the keyboard of your computer is spill-proof, liquid will remain in the keyboard enclosure if you don't remove it. Wait for the keyboard to air dry before using the computer again.

The touchpad does not work, or the pointer is difficult to control with the touchpad.

- Make sure that the touchpad is clean.

LAN Problems

I cannot access the network.

- Make sure that the LAN cable is properly connected to the RJ45 connector and the network hub.
- Make sure that the network configuration is appropriate.
- Make sure that the user name or password is correct.

Power Management Problems

The computer does not enter Sleep or Hibernation mode automatically.

- If you have a connection to another computer, the computer does not enter Sleep or Hibernation mode if the connection is actively in use.
- Make sure that the Sleep or Hibernation time-out is enabled.

The computer does not enter Sleep or Hibernation mode immediately.

- If the computer is performing an operation, it normally waits for the operation to finish.

The computer does not resume from Sleep or Hibernation mode.

- The computer automatically enters Sleep or Hibernation mode when the battery pack is empty. Do any one of the following:
 - Connect the AC adapter to the computer.
 - Replace the empty battery pack with a fully charged one.

Software Problems

An application program does not work correctly.

- Make sure that the software is correctly installed.
- If an error message appears on the screen, consult the software program's documentation for further information.
- If you are sure the operation has stop, reset the computer.

Sound Problems

No sound is produced.

- Make sure that the volume control is not set too low.
- Make sure that the computer is not in Sleep mode.
- If using an external speaker, make sure that the speaker is properly connected.

Distorted sound is produced.

- Make sure that the volume control is not set too high or too low. In most cases, a high setting can cause the audio electronics to distort the sound.

The sound system does not record.

- Adjust the playback or recording sound levels.

Startup Problems

When you turn on the computer, it does not seem to respond.

- If you are using an external AC power, make sure that the AC adapter is correctly and securely connected. If so, make sure that the electrical outlet works properly.
- If you are using the battery power, make sure that the battery is not discharged.

WLAN Problems

I cannot use the WLAN feature.

- Make sure that the WLAN feature is turned on.

Transmission quality is poor.

- Your computer may be in an out-of-range situation. Move your computer closer to the Access Point or another WLAN device it is associated with.

- Check if there is high interference around the environment and solve the problem as described next.

Radio interference exists.

- Move your computer away from the device causing the radio interference such as microwave oven and large metal objects.
- Plug your computer into an outlet on a different branch circuit from that used by the affecting device.
- Consult your dealer or an experienced radio technician for help.

I cannot connect to another WLAN device.

- Make sure that the WLAN feature is turned on.
- Make sure that the SSID setting is the same for every WLAN device in the network.
- Your computer is not recognizing changes. Restart the computer.
- Make sure that the IP address or subnet mask setting is correct.

I cannot communicate with the computer in the network when Infrastructure mode is configured.

- Make sure that the Access Point your computer is associated with is powered on and all the LEDs are working properly.
- If the operating radio channel is in poor quality, change the Access Point and all the wireless station(s) within the BSSID to another radio channel.
- Your computer may be in an out-of-range situation. Move your computer closer to the Access Point it is associated with.
- Make sure that your computer is configured with the same security option (encryption) to the Access Point.
- Use the Web Manager/Telnet of the Access Point to check whether it is connected to the network.
- Reconfigure and reset the Access Point.

I cannot access the network.

- Make sure that the network configuration is appropriate.

- Make sure that the user name or password is correct.
- You have moved out of range of the network.
- Turn off power management.

Other Problems

The date/time is incorrect.

- Correct the date and time via the operating system or BIOS Setup program.
- After you have performed everything as described above and still have the incorrect date and time every time you turn on the computer, the RTC (Real-Time Clock) battery is at the end of its life. Call an authorized dealer to replace the RTC battery.

GPS signals drop when they are not supposed to.

- If your computer is connected to the docking station which has one or more USB 3.1/3.0 devices connected, the USB 3.1/3.0 device can interfere with the radio frequency, causing poor GPS signal reception. To solve the problem in this situation, run the BIOS Setup Utility, go to **Advanced** → **Device Configuration** → **Docking USB Port Setting** and change the setting to USB 2.0.

Resetting the Computer

You may have to reset (reboot) your computer on some occasions when an error occurs and the program you are using hangs up.

If you are sure the operation has stopped and you cannot use the “restart” function of the operating system, reset the computer

Reset the computer by any of these methods:

- Press **Ctrl+Alt+Del** on the keyboard. This opens the **Ctrl-Alt-Del** screen where you can select actions including **Restart**.
- If the above action does not work, press and hold the power button for more than 5 seconds to force the system to turn off. Then turn on the power again.

System Recovery

Using Windows RE

Windows 10 has a recovery environment (Windows RE) that provides recovery, repair, and troubleshooting tools. The tools are referred to as Advanced Startup Options. You can access these options by selecting  → **Settings** → **Update & security**. There are several choices:

- **System Restore**
This option allows you to restore Windows to an earlier point in time if you have created a restore point.
- **Recover from a drive**
If you have created a recovery drive on Windows 10, you can use the recovery drive to reinstall Windows.
- **Reset this PC**
This option allows you to reinstall Windows with or without keeping your files.

See Microsoft website for more information.

NOTE:

- If you are in a situation where your computer won't boot into Windows, you can access the Advanced Startup Options by running the BIOS Setup Utility and selecting **Advanced** → **Windows RE**.
- System recovery for Windows 10 typically will take several hours to complete.

Using Recovery Partition

When necessary, you can restore your Windows 10 system to the factory default state by using the “recovery partition” feature. Recovery partition is a portion of your hard disk drive (SSD) that is set aside by the manufacturer to hold the original image of your system.

WARNING:

- Using this feature will reinstall Windows to your system and configure it to the system’s factory default settings. All data on the hard disk drive (SSD) will be lost.
- Make sure that power is not interrupted during the recovery process. An unsuccessful recovery may result in Windows startup problems.

To restore your system to the factory default state:

1. Connect the AC adapter.
2. Run BIOS Setup Utility. Select **Advanced** → **Recovery Partition**. (See Chapter 5 for more information.)
3. Follow the onscreen instructions to complete the process.

Using the Driver Disc (Optional)

NOTE: You can download the latest drivers and utilities from Getac website at <http://www.getac.com> → **Support**.

The Driver disc contains drivers and utilities required for specific hardware in your computer.

Since your computer comes with drivers and utilities pre-installed, you normally do not need to use the Driver disc. In case you want to manually install Windows, you will have to install the drivers and utilities one by one after installing Windows.

To manually install drivers and utilities:

1. Start up the computer.
2. Skip this step if your model has a DVD drive.

Prepare an external CD/DVD drive (with USB connection). Connect the drive to your computer. Wait for the computer to recognize the drive.

3. Insert the Driver disc. Make sure you use the disc that matches the Windows version of your computer.
4. The autorun program should automatically start. You will see the installation menu. Click **NEXT** to go to the next page if there is more than one.
5. To install a driver or utility, just click the particular button and follow the onscreen instructions to complete the installation.

Appendix A

Specifications

NOTE: Specifications are subject to change without any prior notice.

Parts		Specifications
CPU		Comet Lake Platform - Intel® Core™ i7-1185G7 Qual Core Processor - Intel® Core™ i7-1165G7 Qual Core Processor - Intel® Core™ i5-1145G7 Qual Core Processor - Intel® Core™ i5-1135G7 Qual Core Processor - Intel® Core™ i3-1115G4 Dual Core Processor Up to 12MB cache
BIOS		Insyde, 32MB flash EEPROM, UEFI, supporting ACPI, TPM, Computrace, AMT42, WMI, and BIOS diagnostic
RAM		4/8/16/32GB DDR4 SO-DIMM, 3200MHz
Display	Panel	14-inch (16:9) wide TFT LCD, resolution up to 1366x768 WXGA or 1920x1080 FHD (option), dimmer mode, blackout mode, capacitive multi-touch - 10 point (option)
	Controller	UMA - Intel® UHD Graphics 620 Option: Nvidia GTX1050 MXM card (Discrete GPU models)
Audio	Features	High Definition audio
	Microphone	Integrated x 2, Mic Array
	Speaker	Speaker x 2
Keyboard		Standard keys with numeric pad keys, 12 function keys, special Fn (Function) key and Windows keys, with water-proof membrane or backlight (option)
Pointing device		Glide touchpad with multi-touch feature, capacitive type
Mass storage device	Main	PCIe SSD, M.2 type, 256GB/512GB/1TB, user-removable
	Second (option)	Can be one of the below: - SATA III SSD, M.2 type, 256GB/512GB/1TB, user-removable - PCIe SSD, M.2 type, 512GB/1TB, factory option
Optical drive (option)		SATA interface, Super-Multi DVD drive or Blu-ray DVD drive (option)
Card slots		MicroSDXC Smart Card ExpressCard/54 or PC card (option)

Parts		Specifications
I/O ports	Standard	USB 3.1 Gen 2 x 2, USB-C Thunderbolt 3, USB 2.0, RJ45, HDMI 2.0, combo audio (4-pole TRRS 3.5mm type), docking
	Configurable I/O options	One of the below configurations: <ul style="list-style-type: none"> - 2nd RJ45 + VGA + RS-232 - PowerShare USB 3.0 + VGA + RS-232 - 2nd RJ45 + DisplayPort + RS-232 - PowerShare USB 3.0 + DisplayPort + RS-232 - 2nd RJ45 + RS-232 + RS-232
	Optional	Tri antenna pass-through
LAN		Intel® Gigabit LAN Option: LAN 2
Wireless LAN + Bluetooth		Intel AX201 NGW M 2x2 802.11 AX + Bluetooth 5.1 combo
GPS (option)		UART
WWAN (option)		4G LTE or 5G NR, external accessible SIM card slot
Camera (option)		FHD Webcam, IR sensor (option)
Contactless smart card reader (option)		USB interface, supporting HF (13.56 MHz) and LF (125 KHz)
Barcode scanner (option)		1D and 2D
Security		Kensington lock TPM 2.0 Fingerprint scanner (option)
Power	AC adapter	Universal AC adapter, 90 W (Standard models) / 120 W (Discrete GPU models), input: 100-240 VAC, output: 19 V
	Battery pack	Main and second (option): Lithium-ion 18650 type, 6-cell, 3450mAh, 3.6V Third (option): Lithium-ion Prismatic type, 6-cell, 2100mAh, 3.7V
Dimension (WxDxH)		350.5 x 294.5 x 34.5 ~ 38.5 mm (13.8 x 11.59 x 1.36 ~ 1.52 inch)
Weight		2.23 ~ 2.45 kg (4.92 ~ 5.4 lb)

Appendix B

Regulatory Information

This appendix provides regulatory statements and safety notices on your computer.

NOTE: Marking labels located on the exterior of your computer indicate the regulations that your model complies with. Please check the marking labels and refer to the corresponding statements in this appendix. Some notices apply to specific models only.

On the Use of the System

Class B Regulations

USA

Federal Communications Commission Radio Frequency Interference Statement

NOTE:

This equipment has been tested and found to comply with the limits for a Class B digital device pursuant to Part 15 of the FCC Rules. These limits are designed to provide reasonable protection against harmful interference in a residential installation. This equipment generates, uses, and can radiate radio frequency energy and, if not installed and used in accordance with the instructions, may cause harmful interference to radio communications. However, there is no guarantee that interference will not occur in a particular installation. If this equipment does cause harmful interference to radio or television reception, which can be determined by turning the equipment off and on, the user is encouraged to try to correct the interference by one or more of the following measures:

- Reorient or relocate the receiving antenna.
- Increase the separation between the equipment and receiver.
- Connect the equipment into an outlet on a circuit different from that to which the receiver is connected.
- Consult the dealer or an experienced radio/TV technician for help.

Any changes or modifications not expressly approved by the manufacturer could void the user's authority to operate the equipment.

Please note:

The use of a non-shielded interface cable with this equipment is prohibited.

Company name: Getac USA

Address: 15495 Sand Canyon Rd., Suite 350 Irvine, CA 92618 USA

Phone: 949-681-2900

Canada

Canadian Department of Communications Radio Interference Regulations Class B Compliance Notice

This Class B digital apparatus meets all requirements of the Canada Interference-Causing equipment regulations.

Cet appareil numérique de Classe B respecte toutes les exigences du Règlement Canadien sur le matériel brouilleur.

This digital apparatus does not exceed the Class B limits for radio noise emissions from digital apparatus set out in the Radio Interference Regulations of the Canadian Department of Communications.

Le présent appareil numérique n'émet pas de bruits radioélectriques dépassant les limites applicables aux appareils numériques de la classe B prescrites dans le Règlement sur le brouillage radioélectrique édicté par le ministère des Communications du Canada.

Safety Notices

About the Battery

If the battery is mishandled, it may cause fire, smoke or an explosion and the battery's functionality will be seriously damaged. The safety instructions listed below must be followed.

Danger

- Do not immerse the battery with liquid such as water, sea water or soda.
- Do not charge/discharge or place the battery in high-temperature (more than 80 °C / 176 °F) locations, such as near a fire, heater, in a car in direct sunlight, etc.
- Do not use unauthorized chargers.
- Do not force a reverse-charge or a reverse-connection.
- Do not connect the battery with AC plug (outlet) or car plugs.
- Do not adapt the battery to unspecified applications.
- Do not short circuit the battery.

- Do not drop or subject the battery to impacts.
- Do not penetrate with a nail or strike with a hammer.
- Do not directly solder the battery.
- Do not disassemble the battery.
- Keep the battery away from an extremely low air pressure environment as it may result in an explosion or the leakage of flammable liquid or gas.

Warning

- Keep the battery away from infants.
- Stop using the battery if there are noticeable abnormalities such as abnormal smell, heat, deformities, or discoloration.
- Stop charging if the charging process cannot be finished.
- In case of a leaking battery, keep the battery away from flames and do not touch it.
- Pack the battery tightly during transport.

Caution

- Do not use the battery where static electricity (more than 100V) exists that might damage the protection circuit of the battery.
- When children are using the system, parents or adults must ensure that they are using the system and battery correctly.
- Keep the battery away from flammable materials during charging and discharging.
- In case lead wires or metal objects come out from the battery, you must seal and insulate them completely.

Caution Texts Concerning Lithium Batteries

DANISH

ADVARSEL! Lithiumbatteri – Eksplosionsfare ved fejlagtig håndtering. Udskiftning må kun ske med batteri af samme fabrikat og type. Levér det brugte batteri tilbage til leverandøren.

NORWEGIAN

ADVARSEL: Eksplosjonsfare ved feilaktig skifte av batteri. Benytt samme batteritype eller en tilsvarende type anbefalt av apparatfabrikanten. Brukte batterier kasseres i henhold til fabrikantens instruksjoner.

SWEDISH

VARNING: Explosionsfara vid felaktigt batteribyte. Använd samma batterityp eller en ekvivalent typ som rekommenderas av apparattillverkaren. Kassera använt batteri enligt fabrikantens instruktion.

FINNISH

VAROITUS: Paristo voi räjähtää, jos se on virheellisesti asennettu. Vaihda paristo ainoastaan valmistajan suosittellemaan tyyppiin. Hävitä käytetty paristo valmistajan ohjeiden mukaisesti.

ENGLISH

CAUTION: Danger of explosion if battery is incorrectly replaced. Replace only with the same or equivalent type recommended by the equipment manufacturer. Discard used batteries according to manufacturer's instructions.

DEUTSCH

VORSICHT: Explosionsgefahr bei unsachgemäßem Austausch der Batterie. Ersatz nur durch denselben oder einen vom Hersteller empfohlenen gleichwertigen Typ. Entsorgung gebrauchter Batterien nach Angaben des Herstellers.

FRENCH

ATTENTION: Il y a danger d'explosion s'il y a remplacement incorrect de la batterie. Remplacer uniquement avec une batterie du même type ou d'un type équivalent recommandé par le constructeur. Mettre au rebut les batteries usagées conformément aux instructions du fabricant.

Attention (for USA Users)

The product that you have purchased contains a rechargeable battery. The battery is recyclable. At the end of its useful life, under various state and local laws, it may be illegal to dispose of this battery into the municipal waste stream. Check with your local solid waste officials for details in your area for recycling options or proper disposal.

About the AC Adapter

- Use only the AC adapter supplied with your computer. Use of another type of AC adapter will result in malfunction and/or danger.
- If a ground/earth pin attachment plug on the AC power cord is provided, always plug the cord into a grounded/earthed outlet. Do not disable ground/earth pin of the plug/cord.
- Do not use the AC adapter in a high moisture environment. Never touch it when your hands or feet are wet.
- Allow adequate ventilation around the AC adapter when using it to operate the device or charge the battery. Do not cover the AC adapter with paper or other objects that will reduce cooling. Do not use the AC adapter while it is inside a carrying case.
- Connect the AC adapter to a proper power source. The voltage requirements are found on the product case and/or packaging.
- Do not use the AC adapter if the cord becomes damaged.
- Do not attempt to service the unit. There are no serviceable parts inside. Replace the unit if it is damaged or exposed to excess moisture.

Heat Related Concerns

Your device may become very warm during normal use. It complies with the user-accessible surface temperature limits defined by the International Standards for Safety. Still, sustained contact with warm surfaces for long periods of time may cause discomfort or injury. To reduce potential heat-related concerns, follow these guidelines:

- Keep your device and its AC adapter in a well-ventilated area when in use or charging. Allow for adequate air circulation under and around the device.
- Use common sense to avoid situations where your skin is in contact with your device or its AC adapter when it's operating or connected to a power source. For example, don't sleep with your device or its AC adapter, or place it under a blanket or pillow, and avoid contact between your body and your device when the AC adapter is connected to a power source. Take special care if you have a physical condition that affects your ability to detect heat against the body.

- If your device is used for long periods, its surface can become very warm. While the temperature may not feel hot to the touch, if you maintain physical contact with the device for a long time, for example if you rest the device on your lap, your skin might suffer a low-heat injury.
- If your device is on your lap and gets uncomfortably warm, remove it from your lap and place it on a stable work surface.
- Never place your device or AC adapter on furniture or any other surface that might be marred by exposure to heat since the base of your device and the surface of the AC adaptor may increase in temperature during normal use.

About the DC Fan

WARNING: Hazardous moving parts. Keep away from moving fan blades.

On the Use of the RF Device

USA and Canada Safety Requirements and Notices

IMPORTANT NOTE: To comply with FCC RF exposure compliance requirements, the antenna used for this transmitter must not be co-located or operating in conjunction with any other antenna or transmitter.

Radio Frequency Interference Requirements and SAR

This device meets the government's requirements for exposure to radio waves.

This device is designed and manufactured not to exceed the emission limits for exposure to radio frequency (RF) energy set by the Federal Communications Commission of the U.S. Government.

This device complies with FCC radiation exposure limits set forth for an uncontrolled environment.

EMC Requirements

This device uses, generates and radiates radio frequency energy. The radio frequency energy produced by this device is well below the maximum exposure allowed by the Federal Communications Commission (FCC).

This device complies with Part 15 of the FCC Rules. Operation is subject to the following two conditions:

- (1) This device may not cause harmful interference.
- (2) This device must accept any interference received, including interference that may cause undesired operation.

The FCC limits are designed to provide reasonable protection against harmful interference when the equipment is installed and used in accordance with the instruction manual and operated in a commercial environment. However, there is no guarantee that interference will not occur in a particular commercial installation, or if operated in a residential area.

If harmful interference with radio or television reception occurs when the device is turned on, the user must correct the situation at the user's own expense. The user is encouraged to try one or more of the following corrective measures:

- Reorient or relocate the receiving antenna.
- Increase the separation between the equipment and receiver.
- Connect the equipment into an outlet on a circuit different from that to which the receiver is connected.
- Consult the dealer or an experienced radio/TV technician for help.

CAUTION: The Part 15 radio device operates on a non-interference basis with other devices operating at this frequency. Any changes or modification to said product not expressly approved by the manufacturer could void the user's authority to operate this device.

Canada Radio Frequency Interference Requirements

To prevent radio interference to the licensed service, this device is intended to be operated indoors and away from windows to provide maximum shielding. Equipment (or its transmit antenna) that is installed outdoors is subject to licensing.

Pour empêcher que cet appareil cause du brouillage au service faisant l'objet d'une licence, il doit être utilisé à l'intérieur et devrait être placé loin des fenêtres afin de fournir un écran de blindage maximal. Si le matériel (ou son antenne d'émission) est installé à l'extérieur, il doit faire l'objet d'une licence.

CAN ICES-3(B)/NMB-3(B)

This device complies with Industry Canada's licence-exempt RSSs. Operation is subject to the following two conditions:

- (1) This device may not cause interference; and
- (2) This device must accept any interference, including interference that may cause undesired operation of the device.

Le présent appareil est conforme aux CNR d'Industrie Canada applicables aux appareils radio exempts de licence. L'exploitation est autorisée aux deux conditions suivantes:

- (1) l'appareil ne doit pas produire de brouillage, et
- (2) l'utilisateur de l'appareil doit accepter tout brouillage radioélectrique subi, même si le brouillage est susceptible d'en compromettre le fonctionnement.

European Union CE Marking and Compliance Notices

Statements of Compliance

English

This product follows the provisions of the European Directive 2014/53/EU.

Danish

Dette produkt er i overensstemmelse med det europæiske direktiv 2014/53/EU.

Dutch

Dit product is in navolging van de bepalingen van Europees Directief 2014/53/EU.

Finnish

Tämä tuote noudattaa EU-direktiivin 2014/53/EU määräyksiä.

French

Ce produit est conforme aux exigences de la Directive Européenne 2014/53/EU.

German

Dieses Produkt entspricht den Bestimmungen der Europäischen Richtlinie 2014/53/EU.

Greek

Το προϊόν αυτό πληροί τις προβλέψεις της Ευρωπαϊκής Οδηγίας 2014/53/EU.

Icelandic

Þessi vara stenst reglugerð Evrópska Efnahags Bandalagsins númer 2014/53/EU.

Italian

Questo prodotto è conforme alla Direttiva Europea 2014/53/EU.

Norwegian

Dette produktet er i henhold til bestemmelsene i det europeiske direktivet 2014/53/EU.

Portuguese

Este produto cumpre com as normas da Diretiva Europeia 2014/53/EU.

Spanish

Este producto cumple con las normas del Directivo Europeo 2014/53/EU.

Swedish

Denna produkt har tillverkats i enlighet med EG-direktiv 2014/53/EU.

Notices

CE Max power:

BT: 11.5 dbm

WiFi 5G: 17.41 dbm

WiFi 2.4G: 16.9 dbm

WWAN: 23.1 dbm

RFID 13.56MHz: -8.33 dBuA/m@10m

RFID 125KHz: -13.31 dBuA/m@10m

The device is restricted to indoor use only when operating in the 5150 to 5350 MHz frequency range.

	AT	BE	BG	HR	CY	CZ	DK
	EE	FI	FR	DE	EL	HU	IE
	IT	LV	LT	LU	MT	NL	PL
	PT	RO	SK	SI	ES	SE	UK

	<p>Waste Electrical and Electronic Equipment (WEEE)</p> <p>This symbol means that according to local laws and regulations your product and/or its battery shall be disposed of separately from household waste. When this product reaches its end of life, take it to a collection point designated by local authorities. Proper recycling of your product will protect human health and the environment.</p>
---	--

RF Exposure Information (SAR)

This device has been tested and meets applicable limits for Radio Frequency (RF) exposure.

Specific Absorption Rate (SAR) refers to the rate at which the body absorbs RF energy. SAR limits are 1.6 Watts per kilogram (over a volume containing a mass of 1 gram of tissue) in countries that follow the United States FCC limit and 2.0 W/kg (averaged over 10 grams of tissue) in countries that follow the Council of the European Union limit. Tests for SAR are conducted using standard operating positions with the device transmitting at its highest certified power level in all tested frequency bands.

This device was tested with a separation distance of 25 mm. Always keep this device away from your body to ensure exposure levels remain at or below the as-tested levels.

User Notification of Take-back Service

To Institutional (B2B) Users in United States:

Getac believes in providing our institutional customers with easy-to-use solutions to recycle your Getac-brand products for free. Getac understands the institutional customers will likely be recycling multiple items at once and as such. Getac wants to make the recycling process for these larger shipments as streamlined as possible. Getac works with recycling vendors with the highest standards for protecting our environment, ensuring worker safety, and complying with global environmental laws. Our commitment to recycling our old equipment grows out of our work to protect the environment in many ways.

Please see the product type below for information on Getac product, battery and packaging recycling in USA.

- **For Product Recycling:**
Your portable Getac products contain hazardous materials. While they pose no risk to you during normal use, they should never be disposed with other wastes. Getac provides a free take-back service for recycling your Getac products. Our electronics recycler will provide competitive bids for recycling non-Getac products as well.
- **For Battery Recycling:**
The batteries used to power your portable Getac products contain hazardous materials. While they pose no risk to you during normal use, they should never be disposed with other wastes. Getac provides a free take-back service for recycling your batteries from Getac products.
- **For Packaging Recycling:**
Getac has chosen the packaging materials used to transport our products carefully, to balance the requirements of shipping the product to you safely while minimizing the amount of material used. The materials used in our packaging are designed to be recycled locally.

If you have the above for recycling, please visit our website <https://us.getac.com/aboutgetac/environment.html>

ENERGY STAR



ENERGY STAR® is a government program that offers businesses and consumers energy-efficient solutions, making it easy to save money while protecting the environment for future generations.

Please reference ENERGY STAR® related information from <http://www.energystar.gov>.

As an ENERGY STAR® Partner, Getac Technology Corporation has determined that this product meets the ENERGY STAR® guidelines for energy efficiency.

An ENERGY STAR® qualified computer uses 70 % less electricity than computers without enabled power management features.

Earning the ENERGY STAR®

- When every home office is powered by equipment that has earned the ENERGY STAR®, the change will keep over 289 billion pounds of greenhouse gases out of the air.
- If left inactive, ENERGY STAR® qualified computers enter a low-power mode and may use 15 watts or less. New chip technologies make power management features more reliable, dependable, and user-friendly than even just a few years ago.
- Spending a large portion of time in low-power mode not only saves energy, but helps equipment run cooler and last longer.
- Businesses that use ENERGY STAR® enabled office equipment may realize additional savings on air conditioning and maintenance.

- Over its lifetime, ENERGY STAR® qualified equipment in a single home office (e.g., computer, monitor, printer, and fax) can save enough electricity to light an entire home for more than 4 years.
- Power management (“sleep settings”) on computers and monitors can result in much savings annually.

Remember, saving energy prevents pollution

Because most computer equipment is left on 24 hours a day, power management features are important for saving energy and are an easy way to reduce air pollution. By using less energy, these products help lower consumers’ utility bills, and prevent greenhouse gas emissions.

Getac Product Compliance

All Getac products with ENERGY STAR® logo comply with the ENERGY STAR® standard, and the power management feature is enabled by default. As recommended by the ENERGY STAR® program for optimal energy savings, the computer is automatically set to sleep after 15 minutes (in battery mode) and 30 minutes (in AC mode) of user inactivity. To wake up the computer, press the power button.

If you want to configure power management settings such as inactivity time and ways to initiate/end Sleep mode, go to **Power Options** by right-clicking the battery icon on the Windows taskbar and then selecting **Power Options** in the pop-up menu.

Please visit <http://www.energystar.gov/powermanagement> for detail information on power management and its benefits to the environment.

NOTE: The notebook models with hard disk drive(s) and/or the RFID module (optional) do not comply with ENERGY STAR®.

Battery Recycling

For the U.S. and Canada only:

To recycle the battery, please go to the RBRC Call2Recycle website or use the Call2Recycle Helpline at 800-822-8837.

Call2Recycle® is a product stewardship program providing no-cost battery and cellphone recycling solutions across the U.S. and Canada. Operated by Call2Recycle, Inc., a 501(c)4 nonprofit public service organization, the program is funded by battery and product manufacturers committed to responsible recycling. See more at: <http://www.call2recycle.org>



California Proposition 65

For California USA:

Proposition 65, a California law, requires warnings to be provided to California consumers when they might be exposed to chemical(s) identified by Proposition 65 as causing cancer and birth defects or other reproductive harm.

Almost all electronic products contain 1 or more of the chemicals listed under Proposition 65. This does not mean the products pose a significant risk of exposure. As the consumers have the right to know about the products they purchase, we are giving this warning on our packaging and user manual to keep our consumers well informed.



This product can expose you to chemicals including lead, TBBPA or formaldehyde, which are known to the State of California to cause cancer and birth defects or other reproductive harm. For more information go to www.P65Warnings.ca.gov

About Battery and External Enclosure Replacement

Battery

The batteries of your product include a battery pack and a button cell (or called RTC battery). Select models have more than one battery pack. All batteries are available from Getac authorized service centers.

The battery pack is user-replaceable. Replacement instructions can be found in "Replacing the Battery Pack" in Chapter 3. The button cell must be replaced by Getac authorized service centers.

Visit the website at <http://us.getac.com/support/support-select.html> for authorized service center information.

External Enclosure

The external enclosure of the product can be removed using screwdrivers. The external enclosure can then be reused or refurbished.

The enclosure consists of the bottom case and the LCD back over. See below for information on how to remove the two parts.

To remove the bottom case:

Remove the screws as indicated below. Detach the bottom case. 圖待改



To remove the LCD back over: 圖待改

Remove the screws as indicated below. Open the LCD back cover and the LCD frame.

