



A D T

FCC SAR Test Report

Report No. : SA120629C20
Applicant : Getac Technology Corporation.
Address : 5F., Building A, No. 209, Sec. 1, Nangang Rd., Nangang Dist, Taipei City 11568, Taiwan, R.O.C.
Product : PDA
FCC ID : 3G: QYLPHS8-PP, WLAN: QYLAPM6658
Brand : Getac
Model No. : PS336
Standards : FCC 47 CFR Part 2 (2.1093) / IEEE C95.1:1991 / IEEE 1528:2003
FCC OET Bulletin 65 Supplement C (Edition 01-01)
KDB 248227 D01 v01r02 / KDB 648474 D01 v01r05
KDB 941225 D01 v02 / KDB 941225 D03 v01
Date of Testing : Sep. 11, 2012 ~ Sep. 18, 2012

CERTIFICATION: The above equipment have been tested by **Bureau Veritas Consumer Products Services (H.K.) Ltd., Taoyuan Branch - Taiwan HwaYa Lab**, and found compliance with the requirement of the above standards. The test record, data evaluation & Equipment Under Test (EUT) configurations represented herein are true and accurate accounts of the measurements of the sample's SAR characteristics under the conditions specified in this report. It should not be reproduced except in full, without the written approval of our laboratory. The client should not use it to claim product certification, approval, or endorsement by TAF or any government agencies.

Prepared By :

Billy Chien / Specialist

Approved By :

Roy Wu / Manager



This report is for your exclusive use. Any copying or replication of this report to or for any other person or entity, or use of our name or trademark, is permitted only with our prior written permission. This report sets forth our findings solely with respect to the test samples identified herein. The results set forth in this report are not indicative or representative of the quality or characteristics of the lot from which a test sample was taken or any similar or identical product unless specifically and expressly noted. Our report includes all of the tests requested by you and the results thereof based upon the information that you provided to us. You have 60 days from date of issuance of this report to notify us of any material error or omission caused by our negligence, provided, however, that such notice shall be in writing and shall specifically address the issue you wish to raise. A failure to raise such issue within the prescribed time shall constitute your unqualified acceptance of the completeness of this report, the tests conducted and the correctness of the report contents. Unless specific mention, the uncertainty of measurement has been explicitly taken into account to declare the compliance or non-compliance to the specification.



Table of Contents

Release Control Record 3

1. Summary of Maximum SAR Value 4

2. Description of Equipment Under Test 5

3. SAR Measurement System 6

 3.1 Definition of Specific Absorption Rate (SAR)..... 6

 3.2 SPEAG DASY System 6

 3.2.1 Robot..... 7

 3.2.2 Probes..... 8

 3.2.3 Data Acquisition Electronics (DAE) 8

 3.2.4 Phantoms 9

 3.2.5 Device Holder..... 10

 3.2.6 System Validation Dipoles 10

 3.2.7 Tissue Simulating Liquids..... 11

 3.3 SAR System Verification 13

 3.4 SAR Measurement Procedure 14

 3.4.1 Area & Zoom Scan Procedure 14

 3.4.2 Volume Scan Procedure..... 14

 3.4.3 Power Drift Monitoring..... 14

 3.4.4 Spatial Peak SAR Evaluation 15

 3.4.5 SAR Averaged Methods 15

4. SAR Measurement Evaluation 16

 4.1 EUT Configuration and Setting..... 16

 4.2 EUT Testing Position 17

 4.3 Tissue Verification 20

 4.4 System Verification..... 20

 4.5 Conducted Power Results..... 21

 4.6 SAR Testing Results..... 23

 4.6.1 SAR Results for Head 23

 4.6.2 SAR Results for Body..... 23

 4.6.3 Simultaneous Multi-band Transmission Evaluation 24

5. Calibration of Test Equipment..... 25

6. Measurement Uncertainty 26

7. Information on the Testing Laboratories 27

Appendix A. SAR Plots of System Verification

Appendix B. SAR Plots of SAR Measurement

Appendix C. Calibration Certificate for Probe and Dipole

Appendix D. Photographs of EUT and Setup



Release Control Record

Issue No.	Reason for Change	Date Issued
R01	Original release	Oct. 12, 2012

1. Summary of Maximum SAR Value

Mode / Band	Test Position	SAR-1g (W/kg)
GSM850	Head	0.324
	Body Worn (1.5 cm Gap)	0.235
GSM1900	Head	0.290
	Body Worn (1.5 cm Gap)	0.263
WCDMA Band II	Head	0.374
	Body Worn (1.5 cm Gap)	0.366
WCDMA Band V	Head	0.300
	Body Worn (1.5 cm Gap)	0.238
WLAN 2.4GHz	Head	0.116
	Body Worn (1.5 cm Gap)	0.029
Bluetooth / RFID	Head	N/A
	Body Worn (1.5 cm Gap)	N/A

Note:

1. The SAR limit (**1.6 W/kg**) for general population/uncontrolled exposure is specified in FCC 47 CFR part 2 (2.1093) and ANSI/IEEE C95.1-1991.
2. Since the maximum power of Bluetooth / RFID is less than $2P_{Ref}$ and the maximum WWAN SAR is less than 1.2 W/kg, SAR testing for Bluetooth / RFID is not required.

FCC SAR Test Report

2. Description of Equipment Under Test

EUT Type	PDA
FCC ID	3G: QYLPHS8-PP, WLAN: QYLAPM6658
Brand Name	Getac
Model Name	PS336
HW Version	DVT
Tx Frequency Bands (Unit: MHz)	GSM850 : 824 ~ 849 GSM1900 : 1850 ~ 1910 WCDMA Band II : 1850 ~ 1910 WCDMA Band V : 824 ~ 849 WLAN : 2400 ~ 2483.5 Bluetooth : 2400 ~ 2483.5
Uplink Modulations	GSM & GPRS : GMSK EDGE : 8PSK WCDMA : QPSK 802.11b : DSSS 802.11g/n : OFDM Bluetooth : GFSK
Maximum AVG Conducted Power (Unit: dBm)	GSM850 : 32.92 GSM1900 : 29.69 WCDMA Band II : 23.18 WCDMA Band V : 23.55 802.11b : 13.02 802.11g : 10.25 802.11n HT20 : 10.11
Antenna Type	Fixed Internal Antenna
EUT Stage	Engineering Sample

Note:

- The above EUT information is declared by manufacturer and for more detailed features description please refers to the manufacturer's specifications or User's Manual.

List of Accessory:

AC Adapter	Brand Name	Asian Power Devices
	Model Name	WA-24112R
	Power Rating	I/P:100-240Vac, 50-60Hz, 7A; O/P: 12Vdc, 2A
	DC Power Cord Type	1.7 meter shielded cable with 1 ferrite core
USB Cable	Brand Name	NA
	Model Name	NA
	Signal Line Type	0.9 meter non-shielded cable without ferrite core
Docking	Brand Name	Getac
	Model Name	PS336 office docking
	Power Rating	I/P:12Vdc, 4.16A
AC cable	Brand Name	Asian Power Devices
	Model Name	DA-60N12
	Signal Line Type	1.1 meter non-shielded cable with 1 ferrite core

3. SAR Measurement System

3.1 Definition of Specific Absorption Rate (SAR)

SAR is related to the rate at which energy is absorbed per unit mass in an object exposed to a radio field. The SAR distribution in a biological body is complicated and is usually carried out by experimental techniques or numerical modeling. The standard recommends limits for two tiers of groups, occupational/controlled and general population/uncontrolled, based on a person's awareness and ability to exercise control over his or her exposure. In general, occupational/controlled exposure limits are higher than the limits for general population/uncontrolled.

The SAR definition is the time derivative (rate) of the incremental energy (dW) absorbed by (dissipated in) an incremental mass (dm) contained in a volume element (dv) of a given density (ρ). The equation description is as below:

$$\text{SAR} = \frac{d}{dt} \left(\frac{dW}{dm} \right) = \frac{d}{dt} \left(\frac{dW}{\rho dv} \right)$$

SAR is expressed in units of Watts per kilogram (W/kg)

SAR measurement can be related to the electrical field in the tissue by

$$\text{SAR} = \frac{\sigma |E|^2}{\rho}$$

Where: σ is the conductivity of the tissue, ρ is the mass density of the tissue and E is the RMS electrical field strength.

3.2 SPEAG DASY System

DASY system consists of high precision robot, probe alignment sensor, phantom, robot controller, controlled measurement server and near-field probe. The robot includes six axes that can move to the precision position of the DASY4/5 software defined. The DASY software can define the area that is detected by the probe. The robot is connected to controlled box. Controlled measurement server is connected to the controlled robot box. The DAE includes amplifier, signal multiplexing, AD converter, offset measurement and surface detection. It is connected to the Electro-optical coupler (ECO). The ECO performs the conversion from the optical into digital electric signal of the DAE and transfers data to the PC.

FCC SAR Test Report

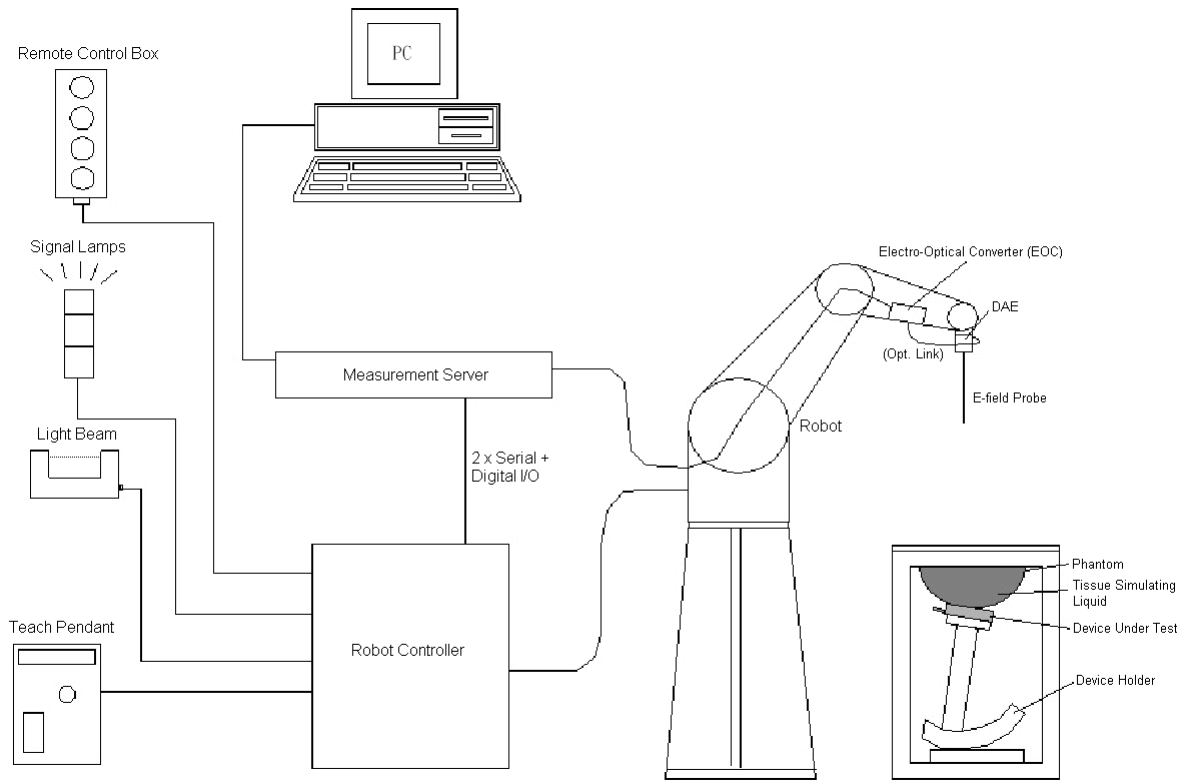

Fig-3.1 DASY System Setup

3.2.1 Robot

The DASY system uses the high precision robots from Stäubli SA (France). For the 6-axis controller system, the robot controller version (DASY4: CS7MB; DASY5: CS8c) from Stäubli is used. The Stäubli robot series have many features that are important for our application:

- High precision (repeatability ± 0.035 mm)
- High reliability (industrial design)
- Jerk-free straight movements
- Low ELF interference (the closed metallic construction shields against motor control fields)



Fig-3.2 DASY4





Fig-3.3 DASY5

FCC SAR Test Report

3.2.2 Probes

The SAR measurement is conducted with the dosimetric probe. The probe is specially designed and calibrated for use in liquid with high permittivity. The dosimetric probe has special calibration in liquid at different frequency.

Model	EX3DV4	
Construction	Symmetrical design with triangular core. Built-in shielding against static charges. PEEK enclosure material (resistant to organic solvents, e.g., DGBE).	
Frequency	10 MHz to 6 GHz Linearity: ± 0.2 dB	
Directivity	± 0.3 dB in HSL (rotation around probe axis) ± 0.5 dB in tissue material (rotation normal to probe axis)	
Dynamic Range	10 μ W/g to 100 mW/g Linearity: ± 0.2 dB (noise: typically < 1 μ W/g)	
Dimensions	Overall length: 337 mm (Tip: 20 mm) Tip diameter: 2.5 mm (Body: 12 mm) Typical distance from probe tip to dipole centers: 1 mm	

Model	ES3DV3	
Construction	Symmetrical design with triangular core. Interleaved sensors. Built-in shielding against static charges. PEEK enclosure material (resistant to organic solvents, e.g., DGBE).	
Frequency	10 MHz to 4 GHz Linearity: ± 0.2 dB	
Directivity	± 0.2 dB in HSL (rotation around probe axis) ± 0.3 dB in tissue material (rotation normal to probe axis)	
Dynamic Range	5 μ W/g to 100 mW/g Linearity: ± 0.2 dB	
Dimensions	Overall length: 337 mm (Tip: 20 mm) Tip diameter: 3.9 mm (Body: 12 mm) Distance from probe tip to dipole centers: 2.0 mm	

3.2.3 Data Acquisition Electronics (DAE)

Model	DAE3, DAE4	
Construction	Signal amplifier, multiplexer, A/D converter and control logic. Serial optical link for communication with DASY4/5 embedded system (fully remote controlled). Two step probe touch detector for mechanical surface detection and emergency robot stop.	
Measurement Range	-100 to +300 mV (16 bit resolution and two range settings: 4mV, 400mV)	
Input Offset Voltage	< 5 μ V (with auto zero)	
Input Bias Current	< 50 fA	
Dimensions	60 x 60 x 68 mm	

FCC SAR Test Report

3.2.4 Phantoms

Model	Twin SAM	
Construction	The shell corresponds to the specifications of the Specific Anthropomorphic Mannequin (SAM) phantom defined in IEEE 1528 and IEC 62209-1. It enables the dosimetric evaluation of left and right hand phone usage as well as body mounted usage at the flat phantom region. A cover prevents evaporation of the liquid. Reference markings on the phantom allow the complete setup of all predefined phantom positions and measurement grids by teaching three points with the robot.	
Material	Vinylester, glass fiber reinforced (VE-GF)	
Shell Thickness	2 ± 0.2 mm (6 ± 0.2 mm at ear point)	
Dimensions	Length: 1000 mm Width: 500 mm Height: adjustable feet	
Filling Volume	approx. 25 liters	

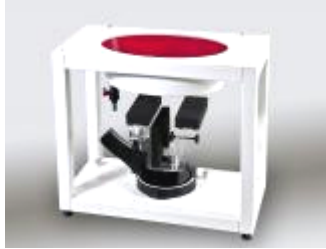
Model	ELI	
Construction	Phantom for compliance testing of handheld and body-mounted wireless devices in the frequency range of 30 MHz to 6 GHz. ELI is fully compatible with the IEC 62209-2 standard and all known tissue simulating liquids. ELI has been optimized regarding its performance and can be integrated into our standard phantom tables. A cover prevents evaporation of the liquid. Reference markings on the phantom allow installation of the complete setup, including all predefined phantom positions and measurement grids, by teaching three points. The phantom is compatible with all SPEAG dosimetric probes and dipoles.	
Material	Vinylester, glass fiber reinforced (VE-GF)	
Shell Thickness	2.0 ± 0.2 mm (bottom plate)	
Dimensions	Major axis: 600 mm Minor axis: 400 mm	
Filling Volume	approx. 30 liters	

FCC SAR Test Report

3.2.5 Device Holder

Model	Mounting Device	
Construction	In combination with the Twin SAM Phantom or ELI4, the Mounting Device enables the rotation of the mounted transmitter device in spherical coordinates. Rotation point is the ear opening point. Transmitter devices can be easily and accurately positioned according to IEC, IEEE, FCC or other specifications. The device holder can be locked for positioning at different phantom sections (left head, right head, flat).	
Material	POM	

Model	Laptop Extensions Kit	
Construction	Simple but effective and easy-to-use extension for Mounting Device that facilitates the testing of larger devices according to IEC 62209-2 (e.g., laptops, cameras, etc.). It is lightweight and fits easily on the upper part of the Mounting Device in place of the phone positioner.	
Material	POM, Acrylic glass, Foam	

3.2.6 System Validation Dipoles

Model	D-Serial	
Construction	Symmetrical dipole with 1/4 balun. Enables measurement of feed point impedance with NWA. Matched for use near flat phantoms filled with tissue simulating solutions.	
Frequency	750 MHz to 5800 MHz	
Return Loss	> 20 dB	
Power Capability	> 100 W (f < 1GHz), > 40 W (f > 1GHz)	

FCC SAR Test Report

3.2.7 Tissue Simulating Liquids

For SAR measurement of the field distribution inside the phantom, the phantom must be filled with homogeneous tissue simulating liquid to a depth of at least 15 cm. For head SAR testing, the liquid height from the ear reference point (ERP) of the phantom to the liquid top surface is larger than 15 cm. For body SAR testing, the liquid height from the center of the flat phantom to the liquid top surface is larger than 15 cm. The nominal dielectric values of the tissue simulating liquids in the phantom and the tolerance of 5% are listed in Table-3.1.

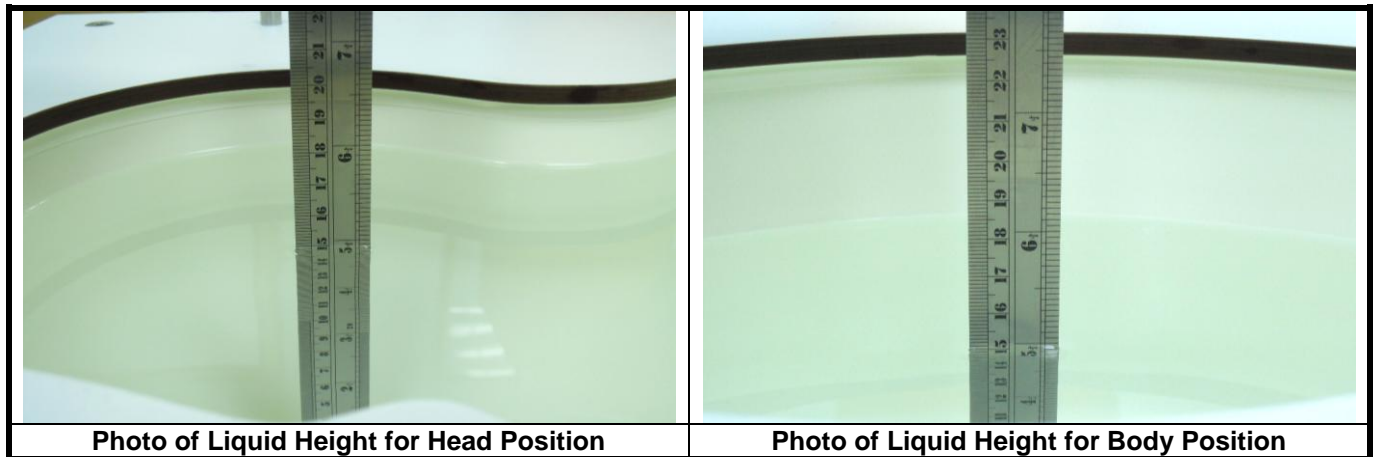

The dielectric properties of the head tissue simulating liquids are defined in IEEE 1528 and FCC OET 65 Supplement C Appendix C. For the body tissue simulating liquids, the dielectric properties are defined in FCC OET 65 Supplement C Appendix C. The dielectric properties of the tissue simulating liquids were verified prior to the SAR evaluation using an Agilent 85070D Dielectric Probe Kit and an Agilent Network Analyzer.

Table-3.1 Targets of Tissue Simulating Liquid

Frequency (MHz)	Target Permittivity	Range of $\pm 5\%$	Target Conductivity	Range of $\pm 5\%$
For Head				
835	41.5	39.4 ~ 43.6	0.90	0.86 ~ 0.95
1900	40.0	38.0 ~ 42.0	1.40	1.33 ~ 1.47
2450	39.2	37.2 ~ 41.2	1.80	1.71 ~ 1.89
For Body				
835	55.2	52.4 ~ 58.0	0.97	0.92 ~ 1.02
1900	53.3	50.6 ~ 56.0	1.52	1.44 ~ 1.60
2450	52.7	50.1 ~ 55.3	1.95	1.85 ~ 2.05



The following table gives the recipes for tissue simulating liquids.

Table-3.2 Recipes of Tissue Simulating Liquid

Tissue Type	Bactericide	DGBE	HEC	NaCl	Sucrose	Triton X-100	Water	Diethylene Glycol Mono-hexylether
H835	0.2	-	0.2	1.5	57.0	-	41.1	-
H1900	-	44.5	-	0.2	-	-	55.3	-
H2450	-	45.0	-	0.1	-	-	54.9	-
B835	0.2	-	0.2	0.9	48.5	-	50.2	-
B1900	-	29.5	-	0.3	-	-	70.2	-
B2450	-	31.4	-	0.1	-	-	68.5	-

3.3 SAR System Verification

The system check verifies that the system operates within its specifications. It is performed daily or before every SAR measurement. The system check uses normal SAR measurements in the flat section of the phantom with a matched dipole at a specified distance. The system verification setup is shown as below.

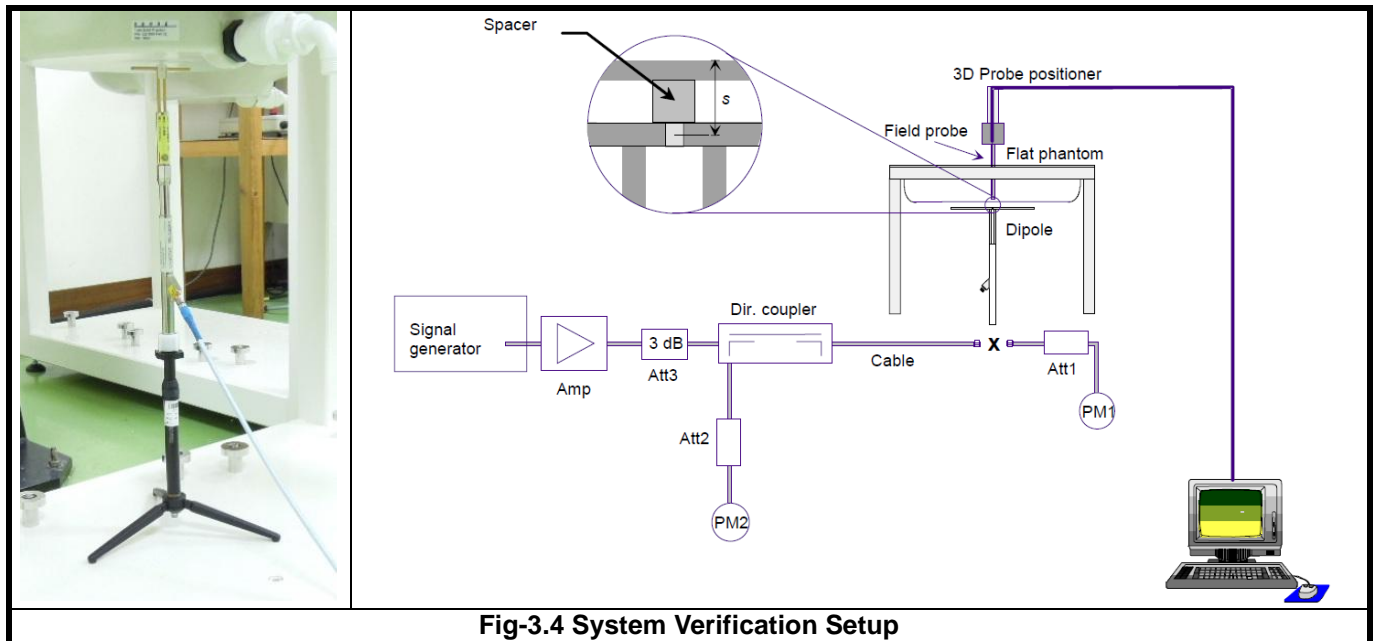

Fig-3.4 System Verification Setup

The validation dipole is placed beneath the flat phantom with the specific spacer in place. The distance spacer is touch the phantom surface with a light pressure at the reference marking and be oriented parallel to the long side of the phantom. The power meter PM1 measures the forward power at the location of the system check dipole connector. The signal generator is adjusted for the desired forward power (250 mW is used for 700 MHz to 3 GHz, 100 mW is used for 3.5 GHz to 6 GHz) at the dipole connector and the power meter PM2 is read at that level. After connecting the cable to the dipole, the signal generator is readjusted for the same reading at power meter PM2.

After system check testing, the SAR result will be normalized to 1W forward input power and compared with the reference SAR value derived from validation dipole certificate report. The deviation of system check should be within 10 %.

3.4 SAR Measurement Procedure

According to the SAR test standard, the recommended procedure for assessing the peak spatial-average SAR value consists of the following steps:

- (a) Power reference measurement
- (b) Area scan
- (c) Zoom scan
- (d) Power drift measurement

The SAR measurement procedures for each of test conditions are as follows:

- (a) Make EUT to transmit maximum output power
- (b) Measure conducted output power through RF cable
- (c) Place the EUT in the specific position of phantom
- (d) Perform SAR testing steps on the DASYS system
- (e) Record the SAR value

3.4.1 Area & Zoom Scan Procedure

First Area Scan is used to locate the approximate location(s) of the local peak SAR value(s). The measurement grid within an Area Scan is defined by the grid extent, grid step size and grid offset. Next, in order to determine the EM field distribution in a three-dimensional spatial extension, Zoom Scan is required. The Zoom Scan measures 5x5x7 points with step size 8, 8 and 5 mm for below 3 GHz, and 7x7x9 points with step size 4, 4 and 2.5 mm for above 5 GHz. The Zoom Scan is performed around the highest E-field value to determine the averaged SAR-distribution over 10 g.

3.4.2 Volume Scan Procedure

The volume scan is used for assess overlapping SAR distributions for antennas transmitting in different frequency bands. It is equivalent to an oversized zoom scan used in standalone measurements. The measurement volume will be used to enclose all the simultaneous transmitting antennas. For antennas transmitting simultaneously in different frequency bands, the volume scan is measured separately in each frequency band. In order to sum correctly to compute the 1g aggregate SAR, the EUT remain in the same test position for all measurements and all volume scan use the same spatial resolution and grid spacing. When all volume scan were completed, the software, SEMCAD postprocessor can combine and subsequently superpose these measurement data to calculating the multiband SAR.

3.4.3 Power Drift Monitoring

All SAR testing is under the EUT install full charged battery and transmit maximum output power. In DASYS measurement software, the power reference measurement and power drift measurement procedures are used for monitoring the power drift of EUT during SAR test. Both these procedures measure the field at a specified reference position before and after the SAR testing. The software will calculate the field difference in dB. If the power drift more than 5%, the SAR will be retested.

FCC SAR Test Report

3.4.4 Spatial Peak SAR Evaluation

The procedure for spatial peak SAR evaluation has been implemented according to the test standard. It can be conducted for 1g and 10g, as well as for user-specific masses. The DASY software includes all numerical procedures necessary to evaluate the spatial peak SAR value.

The base for the evaluation is a "cube" measurement. The measured volume must include the 1g and 10g cubes with the highest averaged SAR values. For that purpose, the center of the measured volume is aligned to the interpolated peak SAR value of a previously performed area scan.

The entire evaluation of the spatial peak values is performed within the post-processing engine (SEMCAD). The system always gives the maximum values for the 1g and 10g cubes. The algorithm to find the cube with highest averaged SAR is divided into the following stages:

- (a) Extraction of the measured data (grid and values) from the Zoom Scan
- (b) Calculation of the SAR value at every measurement point based on all stored data (A/D values and measurement parameters)
- (c) Generation of a high-resolution mesh within the measured volume
- (d) Interpolation of all measured values from the measurement grid to the high-resolution grid
- (e) Extrapolation of the entire 3-D field distribution to the phantom surface over the distance from sensor to surface
- (f) Calculation of the averaged SAR within masses of 1g and 10g

3.4.5 SAR Averaged Methods

In DASY, the interpolation and extrapolation are both based on the modified Quadratic Shepard's method. The interpolation scheme combines a least-square fitted function method and a weighted average method which are the two basic types of computational interpolation and approximation.

Extrapolation routines are used to obtain SAR values between the lowest measurement points and the inner phantom surface. The extrapolation distance is determined by the surface detection distance and the probe sensor offset. The uncertainty increases with the extrapolation distance. To keep the uncertainty within 1% for the 1 g and 10 g cubes, the extrapolation distance should not be larger than 5 mm.

4. SAR Measurement Evaluation

4.1 EUT Configuration and Setting

For WWAN SAR testing, the EUT was linked and controlled by base station emulator (Brand: Agilent, Model: E5515C). Communication between the EUT and the emulator was established by air link. The distance between the EUT and the communicating antenna of the emulator is larger than 50 cm and the output power radiated from the emulator antenna is at least 30 dB smaller than the output power of EUT. The EUT was set from the emulator to radiate maximum output power during SAR testing.

For GSM850, the power control level is set to 5. For GPRS850 (GMSK, CS1), the power control level is set to 5. For EDGE850 (GMSK: MCS1, 8PSK:MCS9), the power control level is set to 8. For GSM1900, the power control level is set to 0. For GPRS1900 (GMSK, CS1), the power control level is set to 0. For EDGE1900 (GMSK: MCS1, 8PSK:MCS9), the power control level is set to 2. SAR testing is performed on the maximum frame-averaged power mode.

For WCDMA, head and body SAR is tested under 12.2k RMC mode with power control set all up bits. SAR for AMR is not required since its power is less than 1/4 dB higher than RMC. SAR for HSDPA/HSUPA is not required since its power is less than 1/4 dB higher than RMC without HSDPA/HSUPA and SAR for 12.2 kbps RMC is less than 75% of the SAR limit (1.2 W/kg).

For WLAN SAR testing, the EUT has installed WLAN engineering testing software which can provide continuous transmitting RF signal. This RF signal utilized in SAR measurement has almost 100% duty cycle. The data rates for WLAN SAR testing were set in 1 Mbps for 802.11b due to the highest RF output power.

4.2 EUT Testing Position

This EUT was tested in **Right Cheek, Right Tilted, Left Cheek, Left Tilted, Front Face of EUT with phantom 1.5 cm gap**, and **Rear Face of EUT with phantom 1.5 cm gap** positions as illustrated below:

1. Define two imaginary lines on the handset

- (a) The vertical centerline passes through two points on the front side of the handset - the midpoint of the width w_t of the handset at the level of the acoustic output, and the midpoint of the width w_b of the bottom of the handset.
- (b) The horizontal line is perpendicular to the vertical centerline and passes through the center of the acoustic output. The horizontal line is also tangential to the face of the handset at point A.
- (c) The two lines intersect at point A. Note that for many handsets, point A coincides with the center of the acoustic output; however, the acoustic output may be located elsewhere on the horizontal line. Also note that the vertical centerline is not necessarily parallel to the front face of the handset, especially for clamshell handsets, handsets with flip covers, and other irregularly shaped handsets.

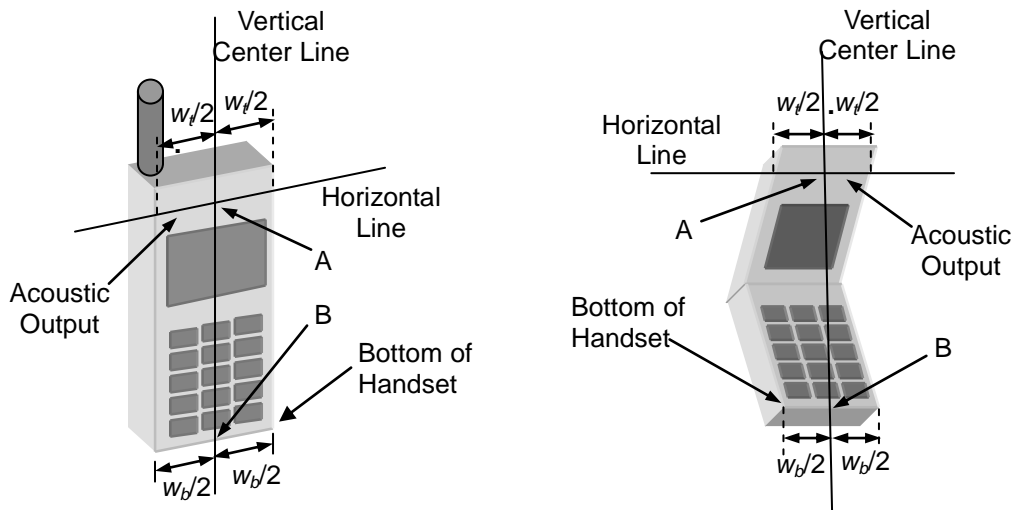

Fig-4.1 Illustration for Handset Vertical and Horizontal Reference Lines

FCC SAR Test Report

2. Cheek Position

- (a) To position the device with the vertical center line of the body of the device and the horizontal line crossing the center piece in a plane parallel to the sagittal plane of the phantom. While maintaining the device in this plane, align the vertical center line with the reference plane containing the three ear and mouth reference point (M: Mouth, RE: Right Ear, and LE: Left Ear) and align the center of the ear piece with the line RE-LE.
- (b) To move the device towards the phantom with the ear piece aligned with the line LE-RE until the phone touched the ear. While maintaining the device in the reference plane and maintaining the phone contact with the ear, move the bottom of the phone until any point on the front side is in contact with the cheek of the phantom or until contact with the ear is lost (see Fig-4.2).

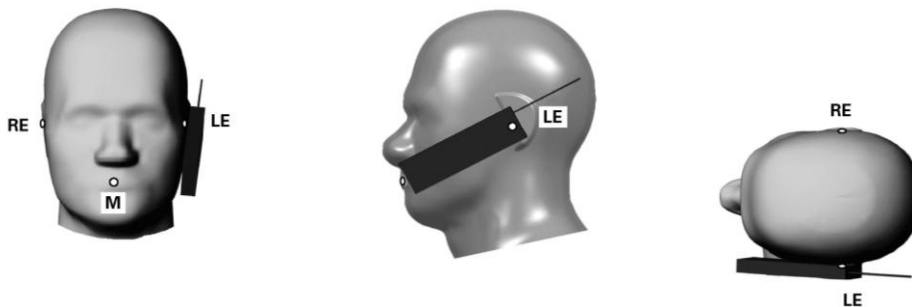

Fig-4.2 Illustration for Cheek Position

3. Tilted Position

- (a) To position the device in the “cheek” position described above.
- (b) While maintaining the device the reference plane described above and pivoting against the ear, moves it outward away from the mouth by an angle of 15 degrees or until contact with the ear is lost (see Fig-4.3).

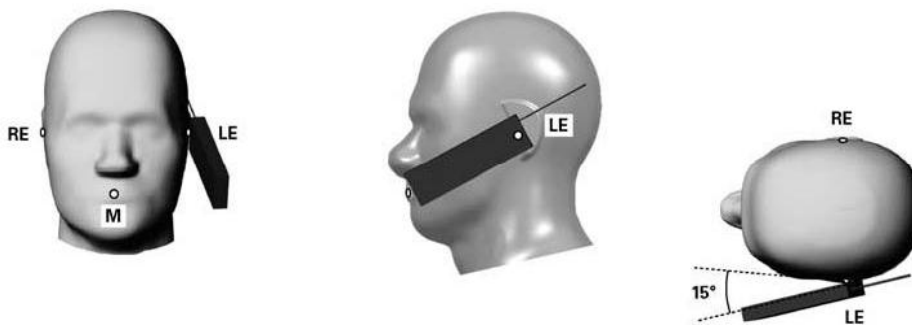
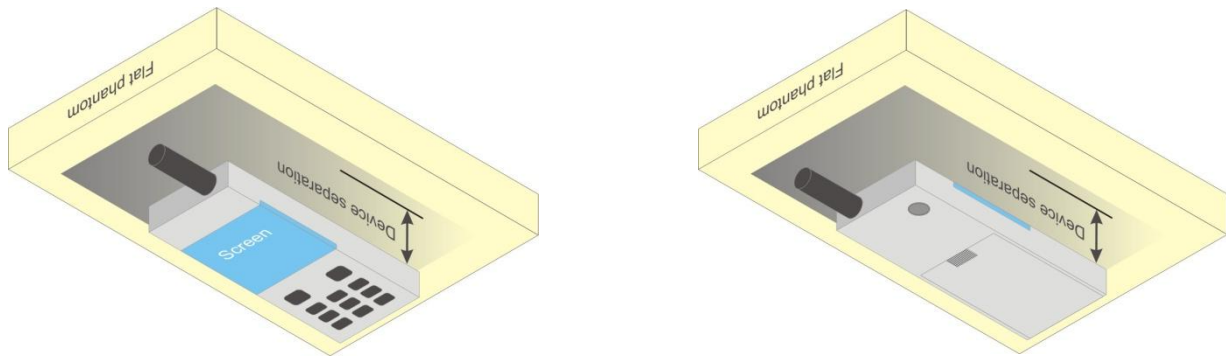

Fig-4.3 Illustration for Tilted Position

4. Body Worn Position

- (a) To position the EUT parallel to the phantom surface.
- (b) To adjust the EUT parallel to the flat phantom.
- (c) To adjust the distance between the EUT surface and the flat phantom to 1.5 cm.

**Fig-4.4 Illustration for Body Worn Position**

FCC SAR Test Report

4.3 Tissue Verification

The measuring results for tissue simulating liquid are shown as below.

Tissue Type	Frequency (MHz)	Liquid Temp. (°C)	Measured Conductivity (σ)	Measured Permittivity (ϵ_r)	Target Conductivity (σ)	Target Permittivity (ϵ_r)	Conductivity Deviation (%)	Permittivity Deviation (%)	Test Date
H835	835	21.2	0.916	42.748	0.90	41.5	1.78	3.01	Sep. 11, 2012
H835	835	21.5	0.909	42.343	0.90	41.5	1.00	2.03	Sep. 12, 2012
H1900	1900	21.6	1.436	39.743	1.40	40.0	2.57	-0.64	Sep. 12, 2012
H2450	2450	21.5	1.780	40.200	1.80	39.2	-1.11	2.55	Sep. 18, 2012
B835	835	20.1	0.980	55.843	0.97	55.2	1.03	1.16	Sep. 13, 2012
B1900	1900	20.2	1.545	52.799	1.52	53.3	1.64	-0.94	Sep. 13, 2012
B2450	2450	21.7	2.030	52.800	1.95	52.7	4.10	0.19	Sep. 17, 2012

Note:

The dielectric properties of the tissue simulating liquid must be measured within 24 hours before the SAR testing and within $\pm 5\%$ of the target values. Liquid temperature during the SAR testing must be within $\pm 2^\circ\text{C}$.

4.4 System Verification

The measuring results for system check are shown as below.

Test Date	Mode	Frequency (MHz)	1W Target SAR-1g (W/kg)	Measured SAR-1g (W/kg)	Normalized to 1W SAR-1g (W/kg)	Deviation (%)	Dipole S/N	Probe S/N	DAE S/N
Sep. 11, 2012	Head	835	9.46	2.45	9.80	3.59	4d021	3650	861
Sep. 12, 2012	Head	835	9.46	2.46	9.84	4.02	4d021	3650	861
Sep. 12, 2012	Head	1900	38.90	9.77	39.08	0.46	5d036	3650	861
Sep. 18, 2012	Head	2450	52.90	13.10	52.40	-0.95	737	3864	1277
Sep. 13, 2012	Body	835	9.60	2.42	9.68	0.83	4d021	3650	861
Sep. 13, 2012	Body	1900	38.90	9.31	37.24	-4.27	5d036	3650	861
Sep. 17, 2012	Body	2450	50.00	12.50	50.00	0.00	737	3864	1277

Note:

Comparing to the reference SAR value provided by SPEAG, the validation data should be within its specification of 10 %. The result indicates the system check can meet the variation criterion and the plots can be referred to Appendix A of this report.

4.5 Conducted Power Results

The measuring conducted power (Unit: dBm) are shown as below.

Band Channel Frequency (MHz)	GSM850			GSM1900		
	128	189	251	512	661	810
	824.2	836.4	848.8	1850.2	1880.0	1909.8
Maximum Burst-Averaged Output Power						
GSM (GMSK, 1 Uplink)	32.88	32.89	32.92	29.47	29.15	29.69
GPRS 8 (GMSK, 1 Uplink)	32.84	32.86	32.86	29.35	29.03	29.57
GPRS 10 (GMSK, 2 Uplink)	29.60	29.61	29.64	25.80	25.48	26.02
GPRS 11 (GMSK, 3 Uplink)	28.15	28.07	27.91	24.57	24.13	24.14
GPRS 12 (GMSK, 4 Uplink)	26.75	26.68	26.53	23.39	22.90	22.35
EDGE 8 (GMSK, 1 Uplink)	32.83	32.84	32.87	29.36	29.04	29.58
EDGE 10 (GMSK, 2 Uplink)	29.47	29.48	29.51	25.79	25.47	26.01
EDGE 11 (GMSK, 3 Uplink)	28.12	28.02	27.89	24.59	24.08	24.11
EDGE 12 (GMSK, 4 Uplink)	26.63	26.78	26.44	23.42	22.93	22.41
EDGE 8 (8PSK, 1 Uplink)	26.70	26.71	26.74	24.76	24.44	24.98
EDGE 10 (8PSK, 2 Uplink)	23.62	23.63	23.66	21.56	21.24	21.78
EDGE 11 (8PSK, 3 Uplink)	22.31	22.21	22.02	20.85	20.38	20.39
EDGE 12 (8PSK, 4 Uplink)	21.35	21.31	21.14	19.59	19.10	18.94
Maximum Frame-Averaged Output Power						
GSM (GMSK, 1 Uplink)	23.88	23.89	23.92	20.47	20.15	20.69
GPRS 8 (GMSK, 1 Uplink)	23.84	23.86	23.86	20.35	20.03	20.57
GPRS 10 (GMSK, 2 Uplink)	23.60	23.61	23.64	19.80	19.48	20.02
GPRS 11 (GMSK, 3 Uplink)	23.89	23.81	23.65	20.31	19.87	19.88
GPRS 12 (GMSK, 4 Uplink)	23.75	23.68	23.53	20.39	19.90	19.35
EDGE 8 (GMSK, 1 Uplink)	23.83	23.84	23.87	20.36	20.04	20.58
EDGE 10 (GMSK, 2 Uplink)	23.47	23.48	23.51	19.79	19.47	20.01
EDGE 11 (GMSK, 3 Uplink)	23.86	23.76	23.63	20.33	19.82	19.85
EDGE 12 (GMSK, 4 Uplink)	23.63	23.78	23.44	20.42	19.93	19.41
EDGE 8 (8PSK, 1 Uplink)	17.70	17.71	17.74	15.76	15.44	15.98
EDGE 10 (8PSK, 2 Uplink)	17.62	17.63	17.66	15.56	15.24	15.78

Note:

- SAR testing for GSM/GPRS/EDGE was performed on the maximum frame-averaged power mode.
- The frame-averaged power is linearly scaled the maximum burst-averaged power based on time slots. The calculated methods are shown as below:
 Frame-averaged power = Burst-averaged power (1 Uplink) – 9 dBm
 Frame-averaged power = Burst averaged power (2 Uplink) – 6 dBm
 Frame-averaged power = Burst averaged power (3 Uplink) – 4.26 dBm
 Frame-averaged power = Burst averaged power (4 Uplink) – 3 dBm



FCC SAR Test Report

A D T

Band	WCDMA Band II			WCDMA Band V		
Channel	9262	9400	9538	4132	4182	4233
Frequency (MHz)	1852.4	1880.0	1907.6	826.4	836.4	846.6
RMC 12.2K	23.11	23.18	23.13	23.54	23.55	23.51
HSDPA Subtest-1	23.09	23.16	23.11	23.41	23.42	23.38
HSDPA Subtest-2	23.07	23.14	23.09	23.40	23.41	23.37
HSDPA Subtest-3	22.66	22.73	22.68	22.85	22.86	22.82
HSDPA Subtest-4	22.61	22.68	22.63	22.98	22.99	22.95
HSUPA Subtest-1	23.05	23.10	23.07	23.39	23.42	23.34
HSUPA Subtest-2	21.01	21.08	21.04	21.28	21.35	21.27
HSUPA Subtest-3	22.00	22.10	22.04	22.35	22.40	22.34
HSUPA Subtest-4	21.00	21.09	21.06	21.27	21.37	21.27
HSUPA Subtest-5	22.98	23.05	23.01	23.27	23.33	23.25

Maximum Power Reduction (dB)						
HSDPA Subtest-1 Target MPR = 0	0.00	0.00	0.00	0.00	0.00	0.00
HSDPA Subtest-2 Target MPR = 0	0.02	0.02	0.02	0.01	0.01	0.01
HSDPA Subtest-3 Target MPR = 0.5	0.43	0.43	0.43	0.56	0.56	0.56
HSDPA Subtest-4 Target MPR = 0.5	0.48	0.48	0.48	0.43	0.43	0.43
HSUPA Subtest-1 Target MPR = 0	0.00	0.00	0.00	0.00	0.00	0.00
HSUPA Subtest-2 Target MPR = 2	2.04	2.02	2.03	2.11	2.07	2.07
HSUPA Subtest-3 Target MPR = 1	1.05	1.00	1.03	1.04	1.02	1.00
HSUPA Subtest-4 Target MPR = 2	2.05	2.01	2.01	2.12	2.05	2.07
HSUPA Subtest-5 Target MPR = 0	0.07	0.05	0.06	0.12	0.09	0.09

Band	802.11b			802.11g		
Channel	1	6	11	1	6	11
Frequency (MHz)	2412	2437	2462	2412	2437	2462
Average Power	8.42	11.13	13.02	6.78	9.20	10.25

Band	802.11n (HT20)		
Channel	1	6	11
Frequency (MHz)	2412	2437	2462
Average Power	6.33	9.12	10.11



FCC SAR Test Report

4.6 SAR Testing Results

4.6.1 SAR Results for Head

Plot No.	Band	Mode	Test Position	Channel	Conducted Power (dBm)	Power Drift (dB)	SAR-1g (W/kg)
1	GSM850	GSM	Right Cheek	251	32.92	0.04	0.324
2	GSM850	GSM	Right Tilted	251	32.92	0.01	0.247
3	GSM850	GSM	Left Cheek	251	32.92	0.00	0.267
4	GSM850	GSM	Left Tilted	251	32.92	0.01	0.177
5	GSM1900	GSM	Right Cheek	810	29.69	-0.17	0.290
6	GSM1900	GSM	Right Tilted	810	29.69	0.01	0.190
7	GSM1900	GSM	Left Cheek	810	29.69	0.19	0.165
8	GSM1900	GSM	Left Tilted	810	29.69	-0.12	0.121
13	WCDMA II	RMC12.2K	Right Cheek	9400	23.18	-0.12	0.374
14	WCDMA II	RMC12.2K	Right Tilted	9400	23.18	0.15	0.241
15	WCDMA II	RMC12.2K	Left Cheek	9400	23.18	-0.15	0.243
16	WCDMA II	RMC12.2K	Left Tilted	9400	23.18	0.01	0.160
9	WCDMA V	RMC12.2K	Right Cheek	4182	23.55	0.03	0.300
10	WCDMA V	RMC12.2K	Right Tilted	4182	23.55	0.03	0.218
11	WCDMA V	RMC12.2K	Left Cheek	4182	23.55	0.01	0.235
12	WCDMA V	RMC12.2K	Left Tilted	4182	23.55	-0.03	0.133
32	802.11b	-	Right Cheek	11	13.02	0.181	0.082
33	802.11b	-	Right Tilted	11	13.02	-0.175	0.025
34	802.11b	-	Left Cheek	11	13.02	0.112	0.116
35	802.11b	-	Left Tilted	11	13.02	0.183	0.021

Note:

- SAR is performed on the highest power channel. When the SAR value of highest power channel is less than 0.8 W/kg, SAR testing for optional channel is not required.
- SAR testing for 802.11g/n is not required because its maximum power is less than 1/4 dB higher than 802.11b.

4.6.2 SAR Results for Body

Plot No.	Band	Mode	Test Position	Separation Distance (cm)	Channel	Conducted Power (dBm)	Power Drift (dB)	SAR-1g (W/kg)
17	GSM850	GSM	Front Face	1.5	251	32.92	-0.10	0.1
18	GSM850	GSM	Rear Face	1.5	251	32.92	-0.04	0.235
19	GSM1900	GSM	Front Face	1.5	810	29.69	0.11	0.052
20	GSM1900	GSM	Rear Face	1.5	810	29.69	-0.02	0.263
23	WCDMA II	RMC12.2K	Front Face	1.5	9400	23.18	-0.08	0.077
24	WCDMA II	RMC12.2K	Rear Face	1.5	9400	23.18	0.03	0.366
21	WCDMA V	RMC12.2K	Front Face	1.5	4182	23.55	-0.04	0.083
22	WCDMA V	RMC12.2K	Rear Face	1.5	4182	23.55	-0.06	0.238
30	802.11b	-	Front Face	1.5	11	13.02	0.087	0.021
31	802.11b	-	Rear Face	1.5	11	13.02	0.15	0.029

Note:

- SAR is performed on the highest power channel. When the SAR value of highest power channel is less than 0.8 W/kg, SAR testing for optional channel is not required.
- SAR testing for 802.11g/n is not required because its maximum power is less than 1/4 dB higher than 802.11b.

Test Engineer : Sam Onn, and Hank Wu

4.6.3 Simultaneous Multi-band Transmission Evaluation

No.	Conditions (SAR1 + SAR2)	Mode	Position	Max. SAR1	Max. SAR2	SAR Summation	SPLSR
1	GSM850 + WLAN 2.4G	Head	Right Cheek	0.324	0.082	0.406	-
			Right Tilted	0.247	0.025	0.272	-
			Left Cheek	0.267	0.116	0.383	-
			Left Tilted	0.177	0.021	0.198	-
		Body-Worn	Front Face	0.1	0.021	0.121	-
			Rear Face	0.235	0.029	0.264	-
2	GSM1900 + WLAN 2.4G	Head	Right Cheek	0.29	0.082	0.372	-
			Right Tilted	0.19	0.025	0.215	-
			Left Cheek	0.165	0.116	0.281	-
			Left Tilted	0.121	0.021	0.142	-
		Body-Worn	Front Face	0.052	0.021	0.073	-
			Rear Face	0.263	0.029	0.292	-
3	WCDMA II + WLAN 2.4G	Head	Right Cheek	0.374	0.082	0.456	-
			Right Tilted	0.241	0.025	0.266	-
			Left Cheek	0.243	0.116	0.359	-
			Left Tilted	0.16	0.021	0.181	-
		Body-Worn	Front Face	0.077	0.021	0.098	-
			Rear Face	0.366	0.029	0.395	-
4	WCDMA V + WLAN 2.4G	Head	Right Cheek	0.3	0.082	0.382	-
			Right Tilted	0.218	0.025	0.243	-
			Left Cheek	0.235	0.116	0.351	-
			Left Tilted	0.133	0.021	0.154	-
		Body-Worn	Front Face	0.083	0.021	0.104	-
			Rear Face	0.238	0.029	0.267	-

Note:

1. The maximum SAR summation is calculated based on the same configuration and test position.

Summary:

According to KDB 648474, the simultaneous transmission SAR for WWAN and WLAN was not required, because the SAR summation is less than 1.6 W/kg. The BT/RFID standalone SAR, and WWAN/BT and WWAN/RFID simultaneous transmission SAR were not required, because the maximum output power of Bluetooth/RFID is less than P_{Ref}, and the closest separation distance of these antennas is less than 2.5 cm, and the maximum WWAN SAR is less than 1.2 W/kg.



5. Calibration of Test Equipment

Equipment	Manufacturer	Model	SN	Cal. Date	Cal. Interval
System Validation Kit	SPEAG	D835V2	4d021	Apr. 20, 2012	Annual
System Validation Kit	SPEAG	D1900V2	5d036	Jan. 26, 2012	Annual
System Validation Kit	SPEAG	D2450V2	737	Jan. 24, 2012	Annual
Dosimetric E-Field Probe	SPEAG	EX3DV4	3650	Oct. 26, 2011	Annual
Dosimetric E-Field Probe	SPEAG	EX3DV4	3864	Jul. 19, 2012	Annual
Data Acquisition Electronics	SPEAG	DAE4	861	Aug. 23, 2012	Annual
Data Acquisition Electronics	SPEAG	DAE4	1277	Jul. 19, 2012	Annual
SAM Phantom	SPEAG	QD000P40CD	TP-1202	N/A	N/A
SAM Phantom	SPEAG	QD000P40CD	TP-1485	N/A	N/A
SAM Phantom	SPEAG	QD000P40CD	TP-1652	N/A	N/A
Radio Communication Tester	Agilent	E5515C	MY50260642	Oct. 25, 2011	Biennial
ENA Series Network Analyzer	Agilent	E5071C	MY46214281	May 14, 2012	Annual
MXG Analog Signal Generator	Agilent	N5181A	MY50143868	May 06, 2012	Annual
Power Meter	Anritsu	ML2495A	1218009	May 07, 2012	Annual
Power Sensor	Anritsu	MA2411B	1207252	May 07, 2012	Annual
EXA Spectrum Analyzer	Agilent	N9010A	MY52100136	Apr. 23, 2012	Annual
Dielectric Probe Kit	Agilent	85070D	E2-020018	May 14, 2012	Annual
Thermometer	YFE	YF-160A	110600361	Feb. 21, 2012	Annual
Directional Coupler	Woken	0110A056020-10	11122702	Apr. 19, 2012	Annual
Power Amplifier	AR	5S1G4	0339656	Apr. 23, 2012	Annual
Power Amplifier	Mini-Circuit	ZVE-8G	001000422	Apr. 23, 2012	Annual
Attenuator	Woken	00800A1G01L-03	N/A	Apr. 19, 2012	Annual

6. Measurement Uncertainty

Error Description	Uncertainty Value (±%)	Probability Distribution	Divisor	Ci (1g)	Standard Uncertainty (1g)	Vi
Measurement System						
Probe Calibration	6.0	Normal	1	1	± 6.0 %	∞
Axial Isotropy	4.7	Rectangular	√3	0.7	± 1.9 %	∞
Hemispherical Isotropy	9.6	Rectangular	√3	0.7	± 3.9 %	∞
Boundary Effects	1.0	Rectangular	√3	1	± 0.6 %	∞
Linearity	4.7	Rectangular	√3	1	± 2.7 %	∞
System Detection Limits	1.0	Rectangular	√3	1	± 0.6 %	∞
Readout Electronics	0.6	Normal	1	1	± 0.6 %	∞
Response Time	0.0	Rectangular	√3	1	± 0.0 %	∞
Integration Time	1.7	Rectangular	√3	1	± 1.0 %	∞
RF Ambient Noise	3.0	Rectangular	√3	1	± 1.7 %	∞
RF Ambient Reflections	3.0	Rectangular	√3	1	± 1.7 %	∞
Probe Positioner	0.5	Rectangular	√3	1	± 0.3 %	∞
Probe Positioning	2.9	Rectangular	√3	1	± 1.7 %	∞
Max. SAR Eval.	2.3	Rectangular	√3	1	± 1.3 %	∞
Test Sample Related						
Device Positioning	3.9	Normal	1	1	± 3.9 %	31
Device Holder	2.7	Normal	1	1	± 2.7 %	19
Power Drift	5.0	Rectangular	√3	1	± 2.9 %	∞
Phantom and Setup						
Phantom Uncertainty	4.0	Rectangular	√3	1	± 2.3 %	∞
Liquid Conductivity (Target)	5.0	Rectangular	√3	0.64	± 1.8 %	∞
Liquid Conductivity (Meas.)	5.0	Normal	1	0.64	± 3.2 %	29
Liquid Permittivity (Target)	5.0	Rectangular	√3	0.6	± 1.7 %	∞
Liquid Permittivity (Meas.)	5.0	Normal	1	0.6	± 3.0 %	29
Combined Standard Uncertainty					± 11.7 %	
Expanded Uncertainty (K=2)					± 23.4 %	

Uncertainty budget for frequency range 300 MHz to 3 GHz



7. Information on the Testing Laboratories

We, Bureau Veritas Consumer Products Services (H.K.) Ltd., Taoyuan Branch, were founded in 1988 to provide our best service in EMC, Radio, Telecom and Safety consultation. Our laboratories are accredited and approved according to ISO/IEC 17025.

Copies of accreditation and authorization certificates of our laboratories obtained from approval agencies can be downloaded from our web site. If you have any comments, please feel free to contact us at the following:

Taiwan HwaYa EMC/RF/Safety/Telecom Lab:

Add: No. 19, Hwa Ya 2nd Rd, Wen Hwa Vil., Kwei Shan Hsiang, Taoyuan Hsien 333, Taiwan, R.O.C.

Tel: 886-3-318-3232

Fax: 886-3-327-0892

Taiwan LinKo EMC/RF Lab:

Add: No. 47, 14th Ling, Chia Pau Vil., Linkou Dist., New Taipei City 244, Taiwan, R.O.C.

Tel: 886-2-2605-2180

Fax: 886-2-2605-1924

Taiwan HsinChu EMC/RF Lab:

Add: No. 81-1, Lu Liao Keng, 9th Ling, Wu Lung Vil., Chiung Lin Township, Hsinchu County 307, Taiwan, R.O.C.

Tel: 886-3-593-5343

Fax: 886-3-593-5342

Email: service.adt@tw.bureauveritas.com

Web Site: www.bureauveritas-adt.com

The road map of all our labs can be found in our web site also.

---END---



Appendix A. SAR Plots of System Verification

The plots for system verification are shown as follows.

System Check_H835_120911

DUT: Dipole 835 MHz; Type: D835V2; SN: 4d021

Communication System: CW; Frequency: 835 MHz; Duty Cycle: 1:1

Medium: H835_0911 Medium parameters used: $f = 835 \text{ MHz}$; $\sigma = 0.916 \text{ mho/m}$; $\epsilon_r = 42.748$; $\rho = 1000 \text{ kg/m}^3$

Ambient Temperature : 22.1 °C; Liquid Temperature : 21.2 °C

DASY5 Configuration:

- Probe: EX3DV4 - SN3650; ConvF(8.87, 8.87, 8.87); Calibrated: 2011/10/26;
- Sensor-Surface: 2mm (Mechanical Surface Detection)
- Electronics: DAE4 Sn861; Calibrated: 2012/08/23
- Phantom: SAM Phantom_Left; Type: SAM V4.0; Serial: TP 1202
- Measurement SW: DASY52, Version 52.8 (2); SEMCAD X Version 14.6.6 (6824)

Pin=250mW/Area Scan (61x61x1): Measurement grid: dx=15mm, dy=15mm

Maximum value of SAR (interpolated) = 3.11 W/kg

Pin=250mW/Zoom Scan (5x5x7)/Cube 0: Measurement grid: dx=8mm, dy=8mm, dz=5mm

Reference Value = 56.334 V/m; Power Drift = -0.03 dB

Peak SAR (extrapolated) = 3.593 mW/g

SAR(1 g) = 2.45 mW/g; SAR(10 g) = 1.62 mW/g

Maximum value of SAR (measured) = 3.09 W/kg

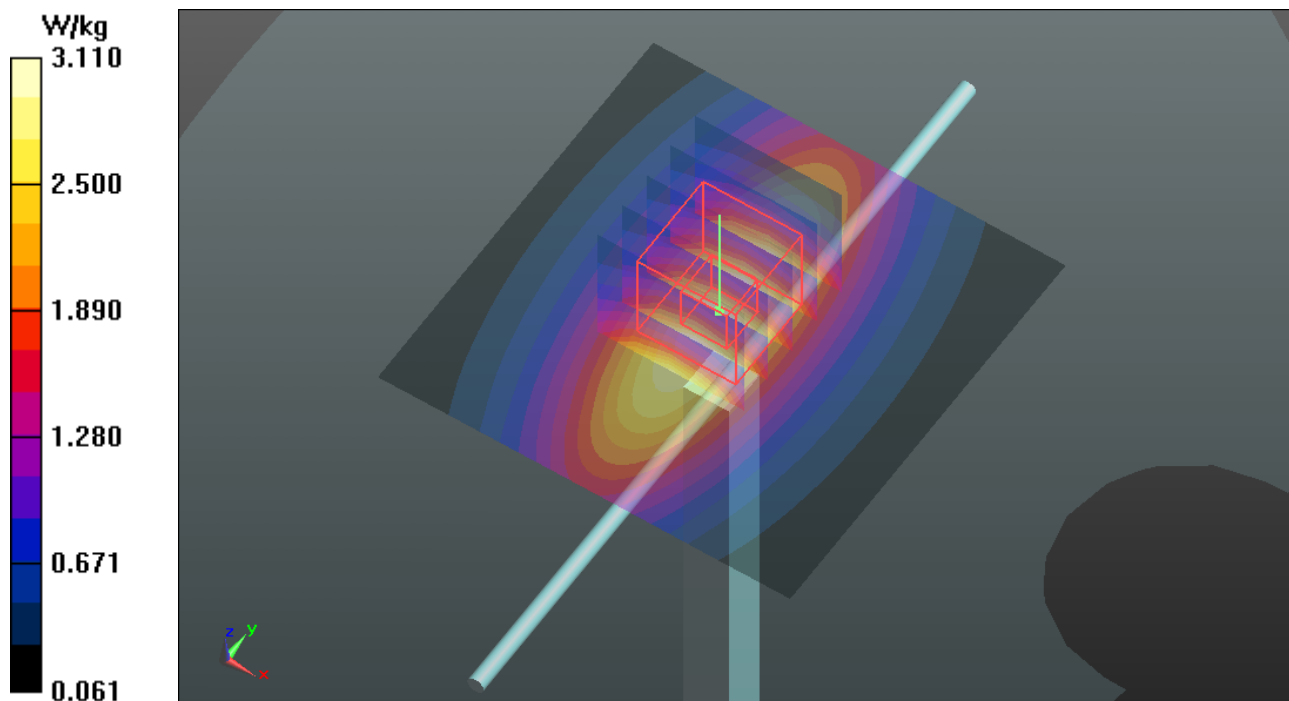

System Check_H835_120912

DUT: Dipole 835 MHz; Type: D835V2; SN: 4d021

Communication System: CW; Frequency: 835 MHz; Duty Cycle: 1:1

Medium: H835_0912 Medium parameters used: $f = 835$ MHz; $\sigma = 0.909$ mho/m; $\epsilon_r = 42.343$; $\rho = 1000$ kg/m³

Ambient Temperature : 22.2 °C ; Liquid Temperature : 21.5 °C

DASY5 Configuration:

- Probe: EX3DV4 - SN3650; ConvF(8.87, 8.87, 8.87); Calibrated: 2011/10/26;
- Sensor-Surface: 2mm (Mechanical Surface Detection)
- Electronics: DAE4 Sn861; Calibrated: 2012/08/23
- Phantom: SAM Phantom_Left; Type: SAM V4.0; Serial: TP 1202
- Measurement SW: DASY52, Version 52.8 (2); SEMCAD X Version 14.6.6 (6824)

Pin=250mW/Area Scan (61x61x1): Interpolated grid: dx=1.500 mm, dy=1.500 mm
Maximum value of SAR (interpolated) = 3.12 W/kg

Pin=250mW/Zoom Scan (5x5x7)/Cube 0: Measurement grid: dx=8mm, dy=8mm, dz=5mm
Reference Value = 56.654 V/m; Power Drift = -0.03 dB
Peak SAR (extrapolated) = 3.639 mW/g
SAR(1 g) = 2.46 mW/g; SAR(10 g) = 1.63 mW/g
Maximum value of SAR (measured) = 3.13 W/kg

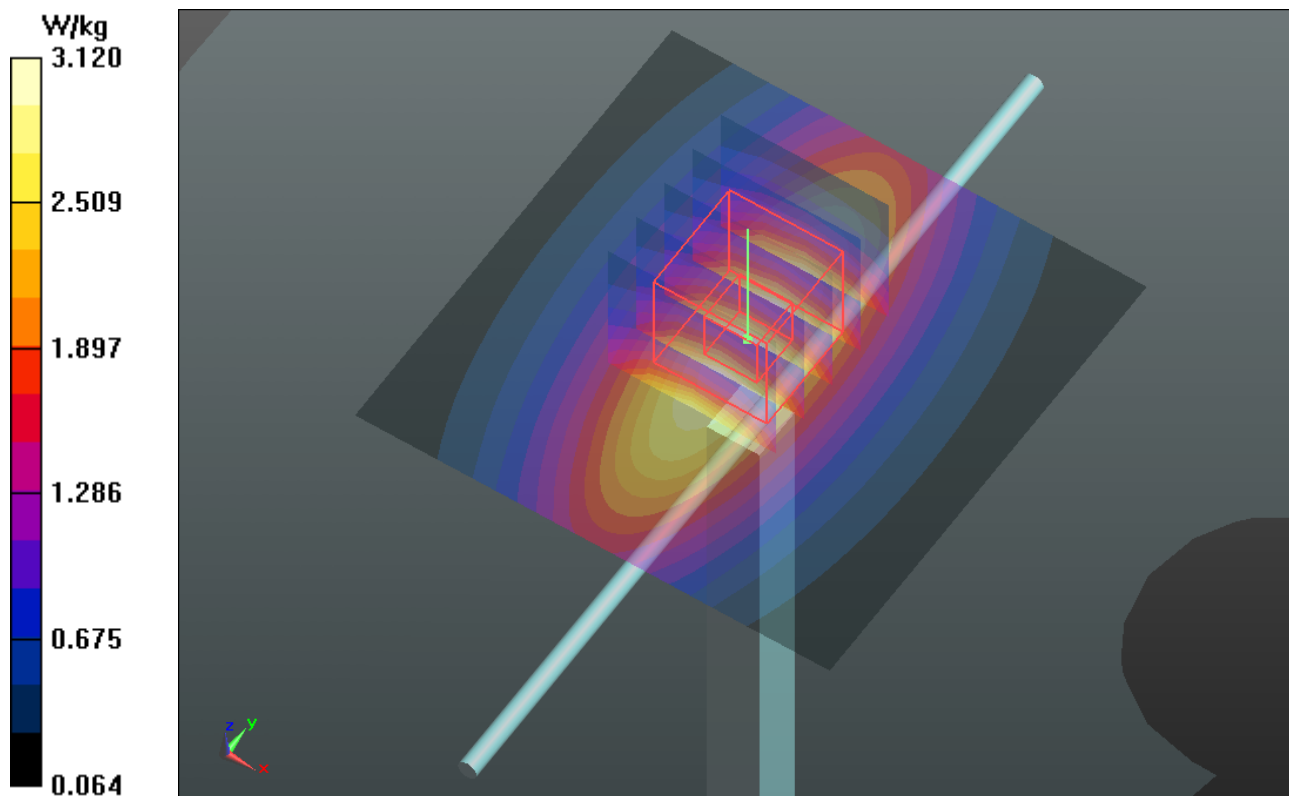

System Check_H1900_120912

DUT: Dipole 1900 MHz; Type: D1900V2; SN: 5d036

Communication System: CW; Frequency: 1900 MHz; Duty Cycle: 1:1

Medium: H1900_0912 Medium parameters used: $f = 1900$ MHz; $\sigma = 1.436$ mho/m; $\epsilon_r = 39.743$; $\rho = 1000$ kg/m³

Ambient Temperature : 22.3 °C ; Liquid Temperature : 21.6 °C

DASY5 Configuration:

- Probe: EX3DV4 - SN3650; ConvF(7.4, 7.4, 7.4); Calibrated: 2011/10/26;
- Sensor-Surface: 2mm (Mechanical Surface Detection)
- Electronics: DAE4 Sn861; Calibrated: 2012/08/23
- Phantom: SAM Phantom_Front; Type: SAM V4.0; Serial: TP 1485
- Measurement SW: DASY52, Version 52.8 (2); SEMCAD X Version 14.6.6 (6824)

Pin=250mW/Area Scan (61x61x1): Measurement grid: dx=15mm, dy=15mm

Maximum value of SAR (interpolated) = 14.5 W/kg

Pin=250mW/Zoom Scan (5x5x7)/Cube 0: Measurement grid: dx=8mm, dy=8mm, dz=5mm

Reference Value = 100.8 V/m; Power Drift = 0.02 dB

Peak SAR (extrapolated) = 18.644 mW/g

SAR(1 g) = 9.77 mW/g; SAR(10 g) = 5.02 mW/g

Maximum value of SAR (measured) = 14.2 W/kg

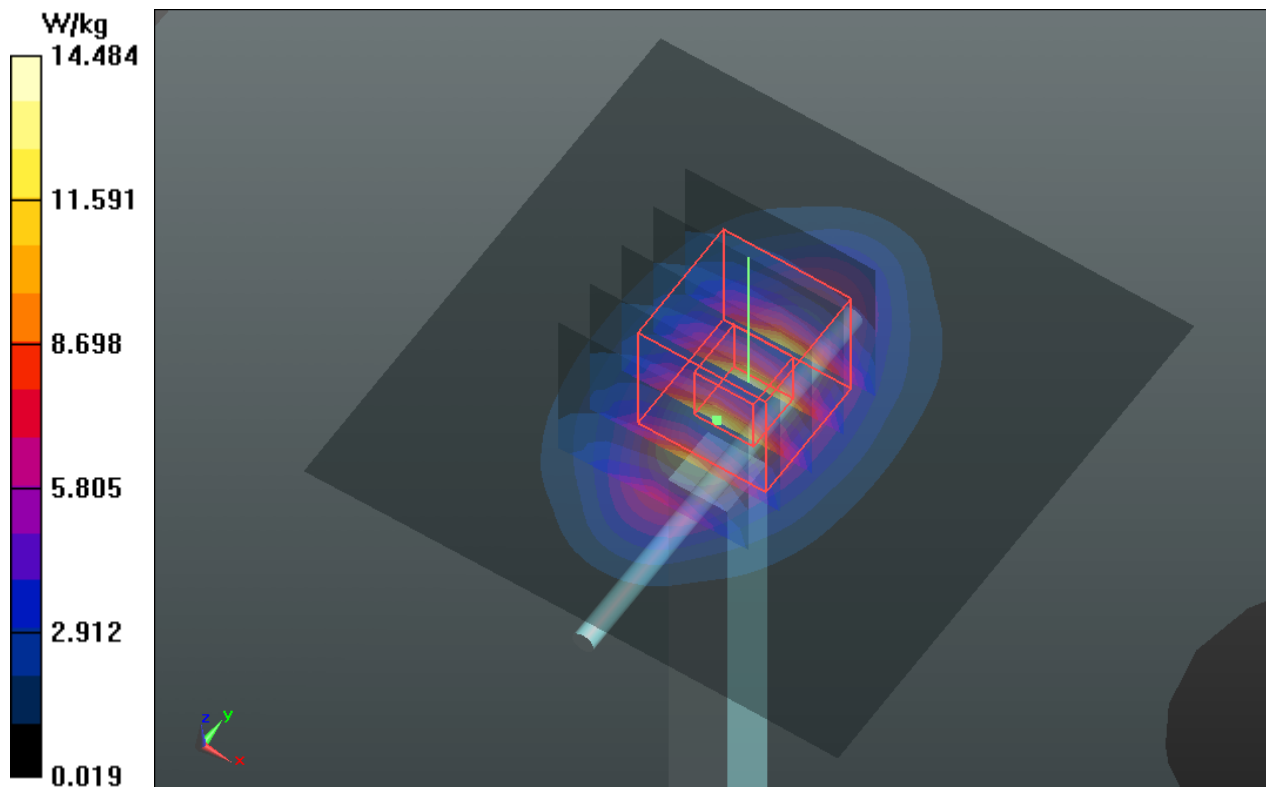

System Check_H2450_120918

DUT: Dipole 2450 MHz; Type: D2450V2; SN: 737

Communication System: CW; Frequency: 2450 MHz; Duty Cycle: 1:1

Medium: H2450_0918 Medium parameters used: $f = 2450$ MHz; $\sigma = 1.78$ mho/m; $\epsilon_r = 40.2$; $\rho = 1000$ kg/m³

Ambient Temperature : 22.3 °C ; Liquid Temperature : 21.5 °C

DASY4 Configuration:

- Probe: EX3DV4 - SN3864; ConvF(7.28, 7.28, 7.28); Calibrated: 2012/07/19
- Sensor-Surface: 2mm (Mechanical Surface Detection)
- Electronics: DAE4 Sn1277; Calibrated: 2012/07/19
- Phantom: SAM Phantom_Left; Type: SAM V4.0; Serial: TP 1652
- Measurement SW: DASY4, V4.7 Build 80; Postprocessing SW: SEMCAD, V1.8 Build 186

Pin=250mW/Area Scan (61x61x1): Measurement grid: dx=15mm, dy=15mm

Maximum value of SAR (interpolated) = 22.0 mW/g

Pin=250mW/Zoom Scan (5x5x7)/Cube 0: Measurement grid: dx=8mm, dy=8mm, dz=5mm

Reference Value = 109.2 V/m; Power Drift = 0.014 dB

Peak SAR (extrapolated) = 28.0 W/kg

SAR(1 g) = 13.1 mW/g; SAR(10 g) = 5.98 mW/g

Maximum value of SAR (measured) = 20.2 mW/g

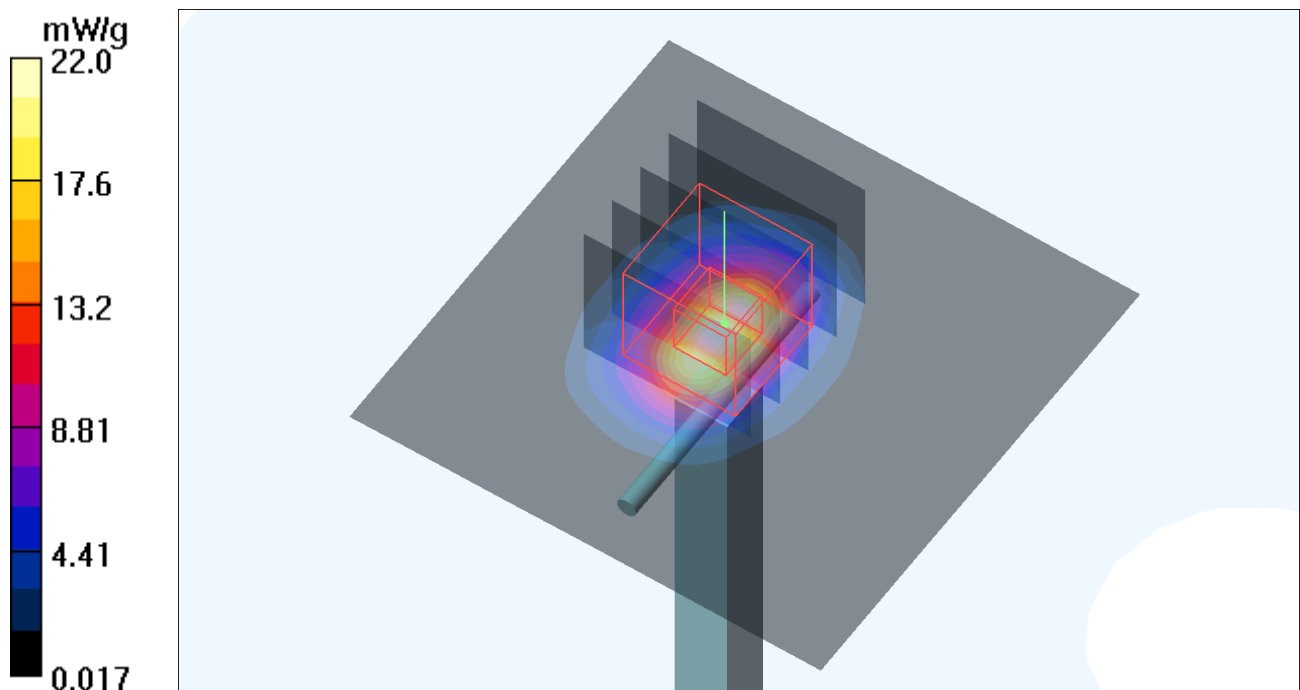

System Check_B835_120913

DUT: Dipole 835 MHz; Type: D835V2; SN: 4d021

Communication System: CW; Frequency: 835 MHz; Duty Cycle: 1:1

Medium: B835_0913 Medium parameters used: $f = 835$ MHz; $\sigma = 0.98$ mho/m; $\epsilon_r = 55.843$; $\rho = 1000$ kg/m³

Ambient Temperature : 21.5 °C ; Liquid Temperature : 20.1 °C

DASY5 Configuration:

- Probe: EX3DV4 - SN3650; ConvF(9.12, 9.12, 9.12); Calibrated: 2011/10/26;
- Sensor-Surface: 2mm (Mechanical Surface Detection)
- Electronics: DAE4 Sn861; Calibrated: 2012/08/23
- Phantom: SAM Phantom_Front; Type: SAM V4.0; Serial: TP 1485
- Measurement SW: DASY52, Version 52.8 (2); SEMCAD X Version 14.6.6 (6824)

Pin=250mW/Area Scan (61x61x1): Measurement grid: dx=15mm, dy=15mm

Maximum value of SAR (interpolated) = 3.06 W/kg

Pin=250mW/Zoom Scan (5x5x7)/Cube 0: Measurement grid: dx=8mm, dy=8mm, dz=5mm

Reference Value = 53.857 V/m; Power Drift = -0.01 dB

Peak SAR (extrapolated) = 3.581 mW/g

SAR(1 g) = 2.42 mW/g; SAR(10 g) = 1.6 mW/g

Maximum value of SAR (measured) = 3.07 W/kg

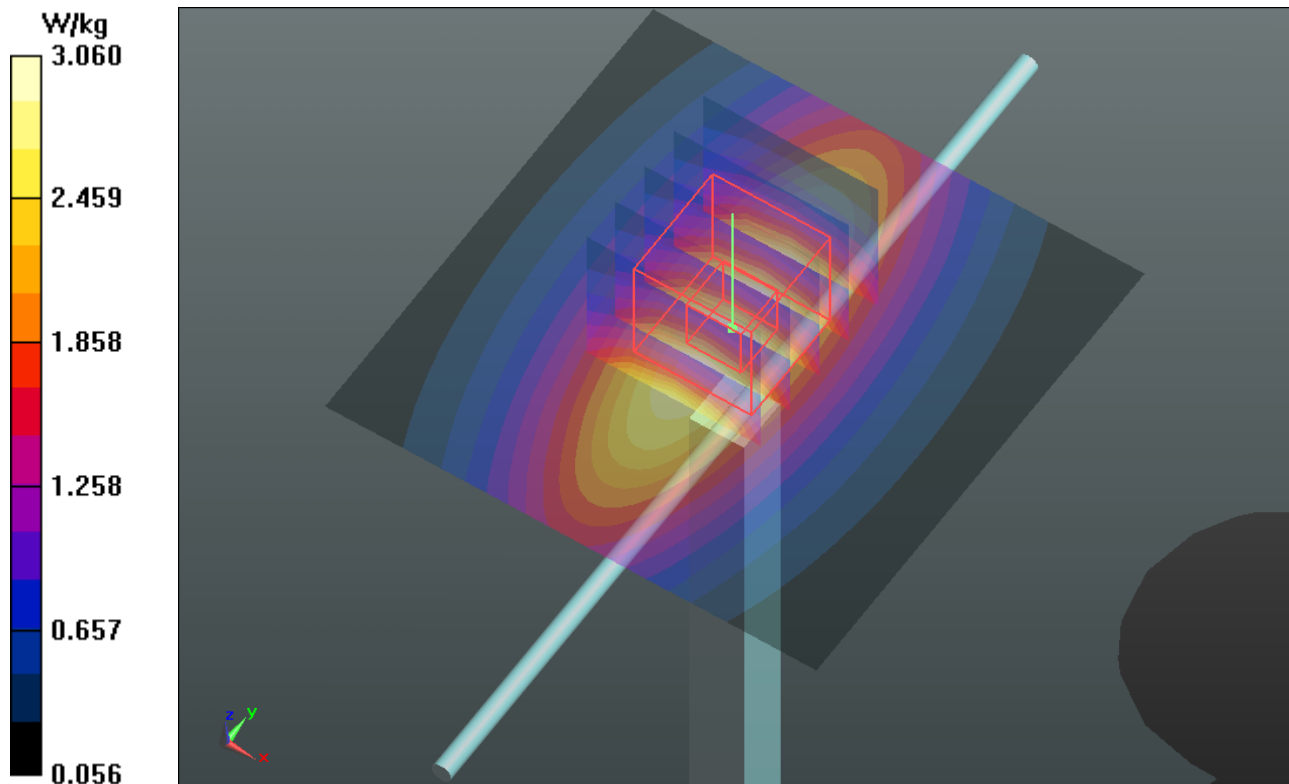

System Check_B1900_120913

DUT: Dipole 1900 MHz; Type: D1900V2; SN: 5d036

Communication System: CW; Frequency: 1900 MHz; Duty Cycle: 1:1

Medium: B1900_0913 Medium parameters used: $f = 1900$ MHz; $\sigma = 1.545$ mho/m; $\epsilon_r = 52.799$; $\rho = 1000$ kg/m³

Ambient Temperature : 21.8 °C ; Liquid Temperature : 20.2 °C

DASY5 Configuration:

- Probe: EX3DV4 - SN3650; ConvF(7.46, 7.46, 7.46); Calibrated: 2011/10/26;
- Sensor-Surface: 2mm (Mechanical Surface Detection)
- Electronics: DAE4 Sn861; Calibrated: 2012/08/23
- Phantom: SAM Phantom_Left; Type: SAM V4.0; Serial: TP 1202
- Measurement SW: DASY52, Version 52.8 (2); SEMCAD X Version 14.6.6 (6824)

Pin=250mW/Area Scan (61x61x1): Measurement grid: dx=15mm, dy=15mm

Maximum value of SAR (interpolated) = 13.6 W/kg

Pin=250mW/Zoom Scan (5x5x7)/Cube 0: Measurement grid: dx=8mm, dy=8mm, dz=5mm

Reference Value = 95.232 V/m; Power Drift = -0.01 dB

Peak SAR (extrapolated) = 16.865 mW/g

SAR(1 g) = 9.31 mW/g; SAR(10 g) = 4.82 mW/g

Maximum value of SAR (measured) = 13.2 W/kg

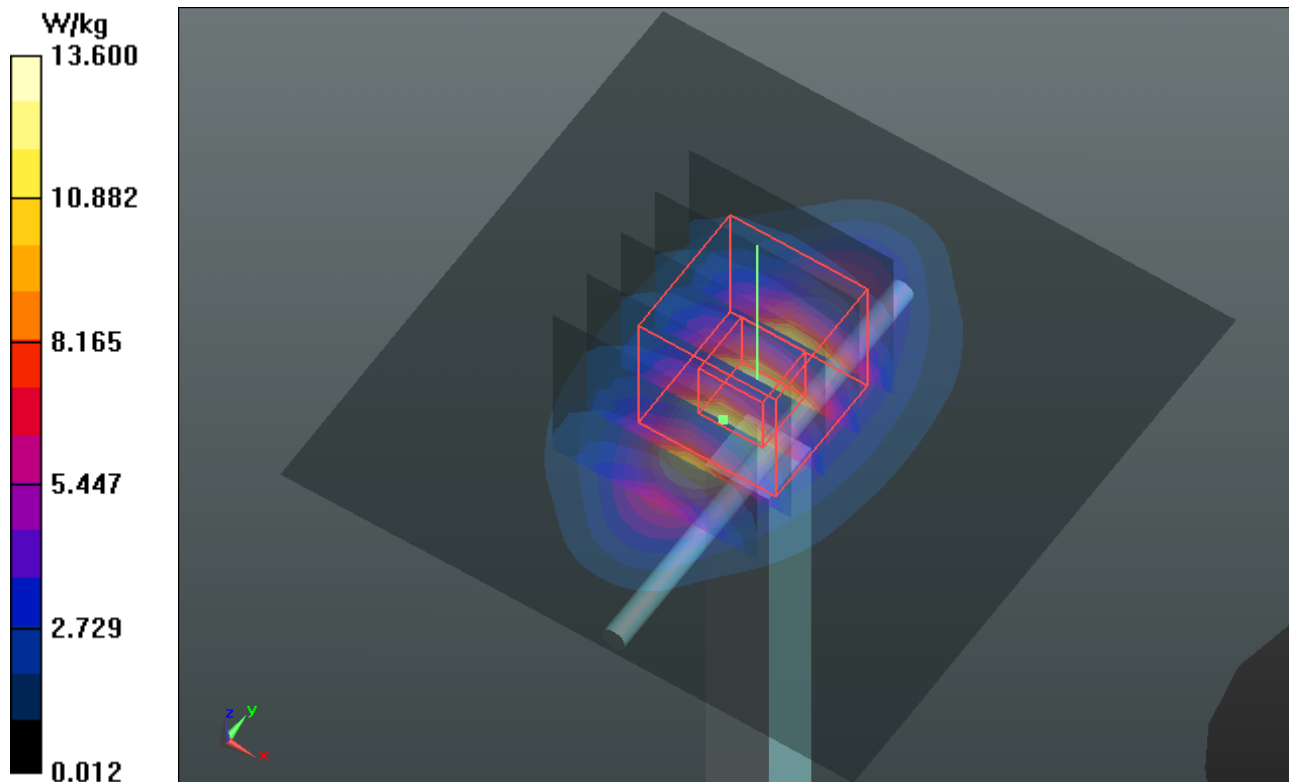

System Check_B2450_120917

DUT: Dipole 2450 MHz; Type: D2450V2; SN: 737

Communication System: CW; Frequency: 2450 MHz; Duty Cycle: 1:1

Medium: B2450_0917 Medium parameters used: $f = 2450$ MHz; $\sigma = 2.03$ mho/m; $\epsilon_r = 52.8$; $\rho = 1000$ kg/m³

Ambient Temperature : 22.4 °C ; Liquid Temperature : 21.7 °C

DASY4 Configuration:

- Probe: EX3DV4 - SN3864; ConvF(7.49, 7.49, 7.49); Calibrated: 2012/07/19
- Sensor-Surface: 2mm (Mechanical Surface Detection)
- Electronics: DAE4 Sn1277; Calibrated: 2012/07/19
- Phantom: SAM Phantom_Left; Type: SAM V4.0; Serial: TP 1652
- Measurement SW: DASY4, V4.7 Build 80; Postprocessing SW: SEMCAD, V1.8 Build 186

Pin=250mW/Area Scan (61x61x1): Measurement grid: dx=15mm, dy=15mm

Maximum value of SAR (interpolated) = 19.9 mW/g

Pin=250mW/Zoom Scan (5x5x7)/Cube 0: Measurement grid: dx=8mm, dy=8mm, dz=5mm

Reference Value = 98.3 V/m; Power Drift = -0.020 dB

Peak SAR (extrapolated) = 26.2 W/kg

SAR(1 g) = 12.5 mW/g; SAR(10 g) = 5.78 mW/g

Maximum value of SAR (measured) = 18.8 mW/g

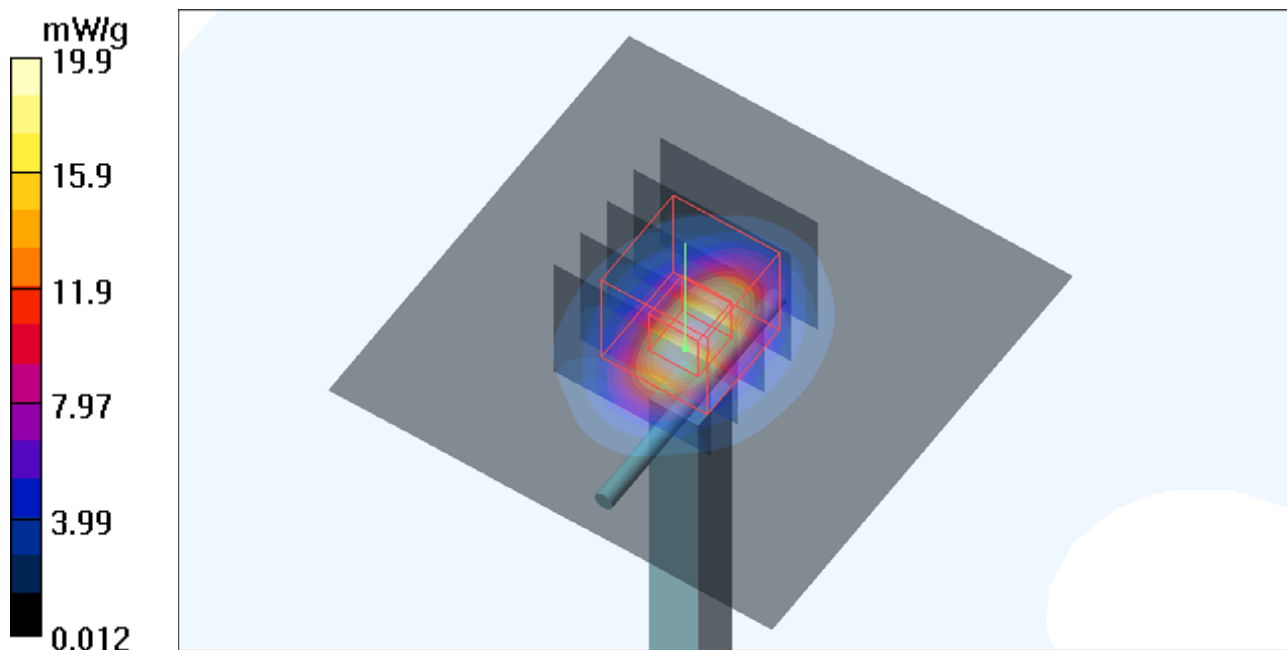



Appendix B. SAR Plots of SAR Measurement

The plots for SAR measurement are shown as follows.

P01 GSM850_GSM_Right Cheek_Ch251

DUT: 120629C20

Communication System: GSM; Frequency: 848.8 MHz; Duty Cycle: 1:8.30042

Medium: H835_0911 Medium parameters used: $f = 849$ MHz; $\sigma = 0.929$ mho/m; $\epsilon_r = 42.571$; $\rho = 1000$ kg/m³

Ambient Temperature : 22.1 °C; Liquid Temperature : 21.2 °C

DASY5 Configuration:

- Probe: EX3DV4 - SN3650; ConvF(8.87, 8.87, 8.87); Calibrated: 2011/10/26;
- Sensor-Surface: 2mm (Mechanical Surface Detection)
- Electronics: DAE4 Sn861; Calibrated: 2012/08/23
- Phantom: SAM Phantom_Left; Type: SAM V4.0; Serial: TP 1202
- Measurement SW: DASY52, Version 52.8 (2); SEMCAD X Version 14.6.6 (6824)

Ch251/Area Scan (71x111x1): Measurement grid: dx=20mm, dy=20mm

Maximum value of SAR (interpolated) = 0.415 W/kg

Ch251/Zoom Scan (5x5x7)/Cube 0: Measurement grid: dx=8mm, dy=8mm, dz=5mm

Reference Value = 13.531 V/m; Power Drift = 0.04 dB

Peak SAR (extrapolated) = 0.468 mW/g

SAR(1 g) = 0.324 mW/g; SAR(10 g) = 0.223 mW/g

Maximum value of SAR (measured) = 0.395 W/kg

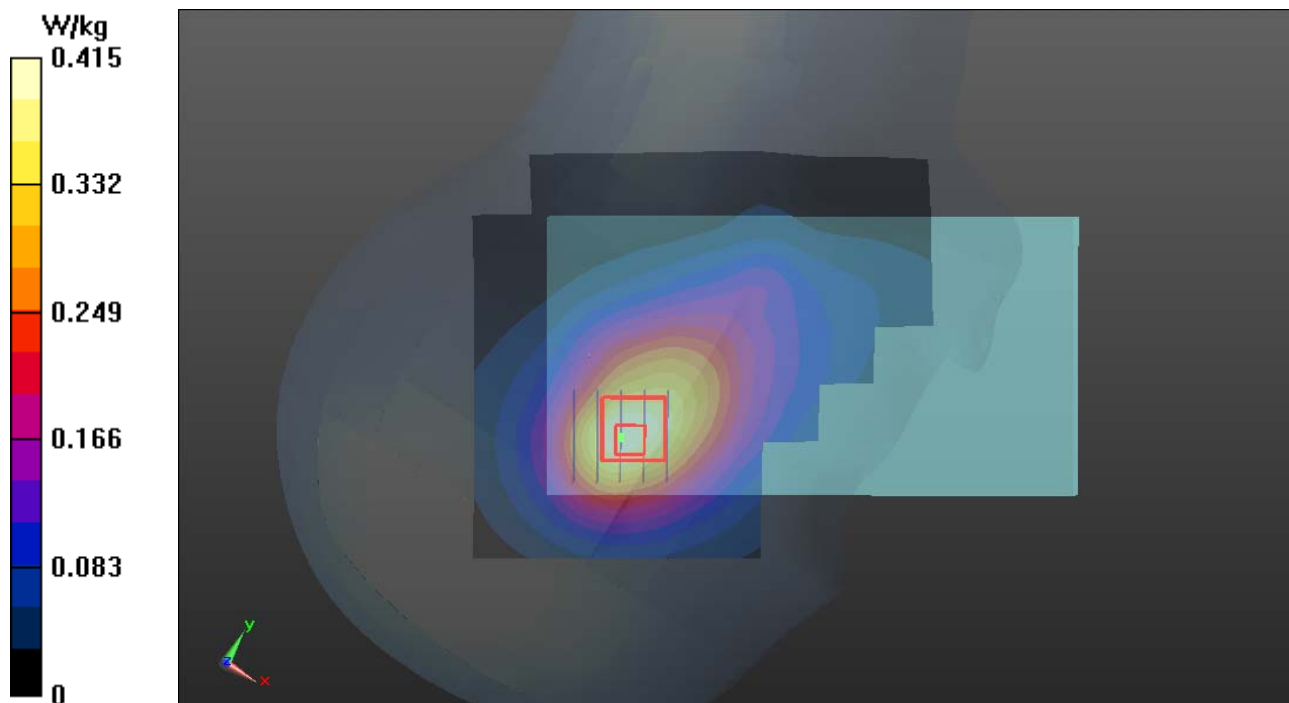

1g/10g Averaged SAR

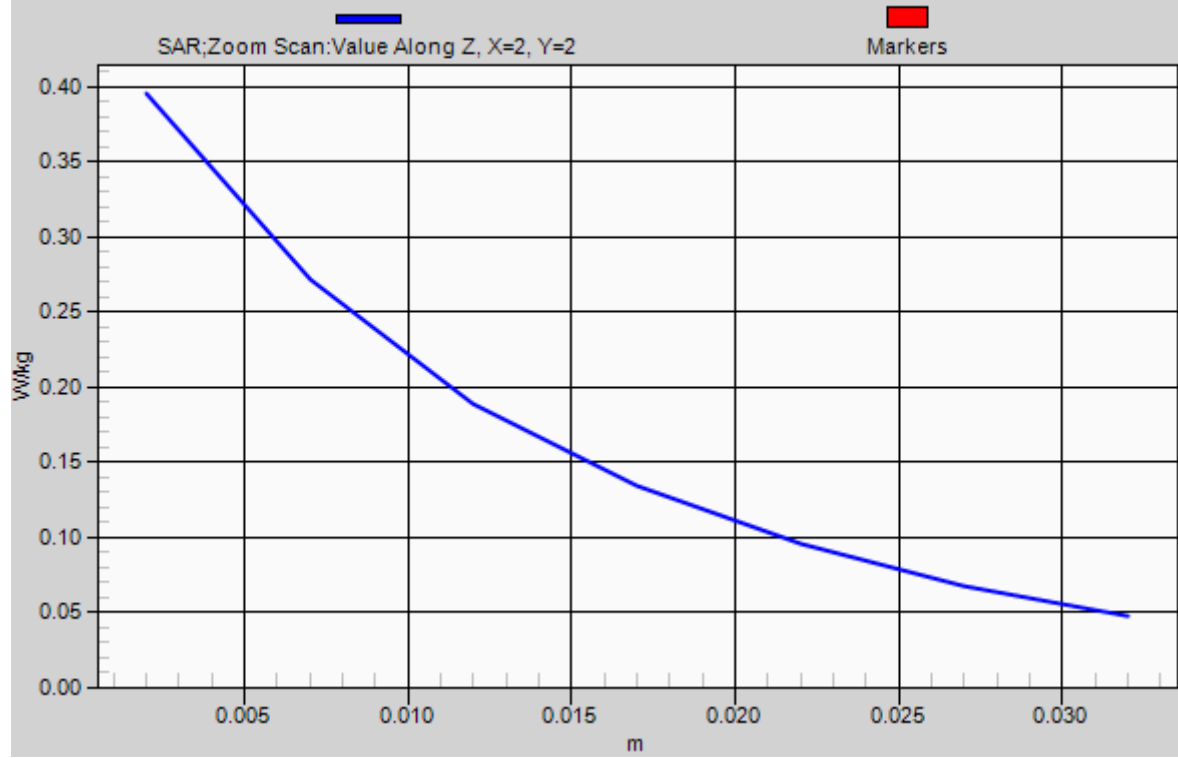

P02 GSM850_GSM_Right Tilted_Ch251

DUT: 120629C20

Communication System: GSM; Frequency: 848.8 MHz; Duty Cycle: 1:8.30042

Medium: H835_0911 Medium parameters used: $f = 849$ MHz; $\sigma = 0.929$ mho/m; $\epsilon_r = 42.571$; $\rho = 1000$ kg/m³

Ambient Temperature : 22.1 °C; Liquid Temperature : 21.2 °C

DASY5 Configuration:

- Probe: EX3DV4 - SN3650; ConvF(8.87, 8.87, 8.87); Calibrated: 2011/10/26;
- Sensor-Surface: 2mm (Mechanical Surface Detection)
- Electronics: DAE4 Sn861; Calibrated: 2012/08/23
- Phantom: SAM Phantom_Left; Type: SAM V4.0; Serial: TP 1202
- Measurement SW: DASY52, Version 52.8 (2); SEMCAD X Version 14.6.6 (6824)

Ch251/Area Scan (71x111x1): Measurement grid: dx=20mm, dy=20mm

Maximum value of SAR (interpolated) = 0.319 W/kg

Ch251/Zoom Scan (5x5x7)/Cube 0: Measurement grid: dx=8mm, dy=8mm, dz=5mm

Reference Value = 12.366 V/m; Power Drift = 0.01 dB

Peak SAR (extrapolated) = 0.359 mW/g

SAR(1 g) = 0.247 mW/g; SAR(10 g) = 0.166 mW/g

Maximum value of SAR (measured) = 0.303 W/kg

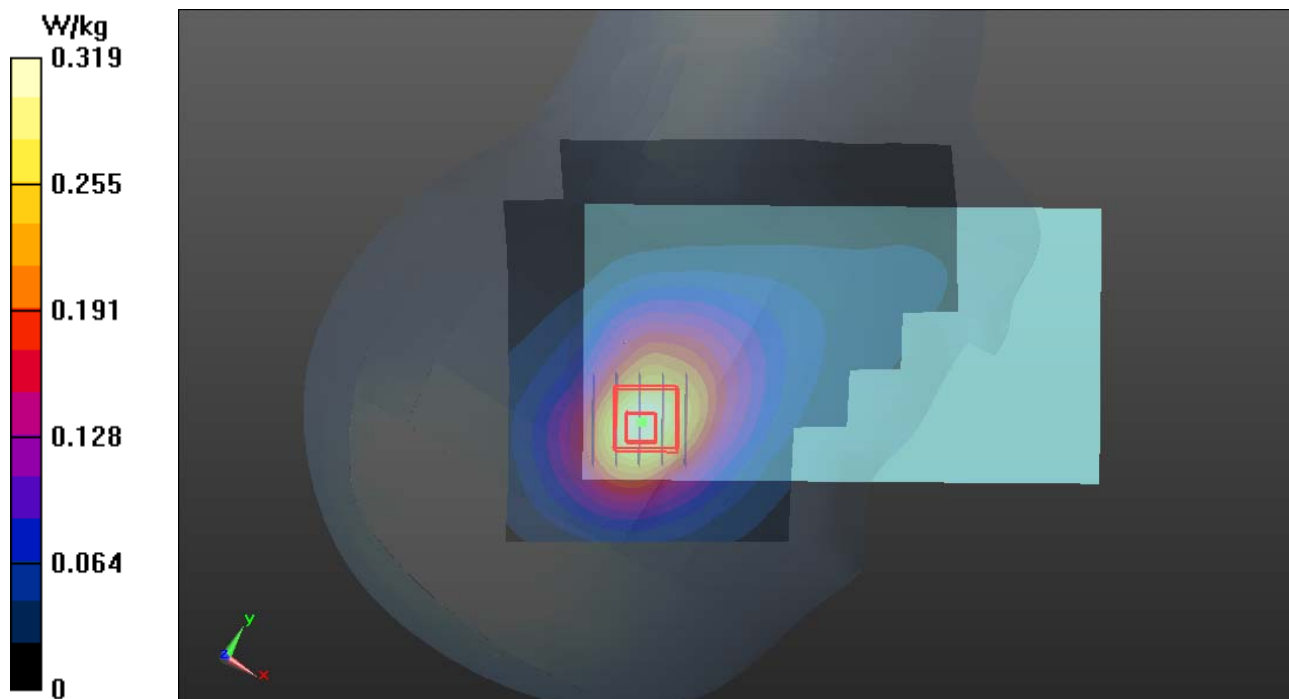

P03 GSM850_GSM_Left Cheek_Ch251

DUT: 120629C20

Communication System: GSM; Frequency: 848.8 MHz; Duty Cycle: 1:8.30042

Medium: H835_0911 Medium parameters used: $f = 849$ MHz; $\sigma = 0.929$ mho/m; $\epsilon_r = 42.571$; $\rho = 1000$ kg/m³

Ambient Temperature : 22.1 °C ; Liquid Temperature : 21.2 °C

DASY5 Configuration:

- Probe: EX3DV4 - SN3650; ConvF(8.87, 8.87, 8.87); Calibrated: 2011/10/26;
- Sensor-Surface: 2mm (Mechanical Surface Detection)
- Electronics: DAE4 Sn861; Calibrated: 2012/08/23
- Phantom: SAM Phantom_Left; Type: SAM V4.0; Serial: TP 1202
- Measurement SW: DASY52, Version 52.8 (2); SEMCAD X Version 14.6.6 (6824)

Ch251/Area Scan (71x111x1): Measurement grid: dx=20mm, dy=20mm

Maximum value of SAR (interpolated) = 0.331 W/kg

Ch251/Zoom Scan (5x5x7)/Cube 0: Measurement grid: dx=8mm, dy=8mm, dz=5mm

Reference Value = 16.352 V/m; Power Drift = 0.00 dB

Peak SAR (extrapolated) = 0.353 mW/g

SAR(1 g) = 0.267 mW/g; SAR(10 g) = 0.195 mW/g

Maximum value of SAR (measured) = 0.314 W/kg

Ch251/Zoom Scan (5x5x7)/Cube 1: Measurement grid: dx=8mm, dy=8mm, dz=5mm

Reference Value = 16.352 V/m; Power Drift = 0.00 dB

Peak SAR (extrapolated) = 0.232 mW/g

SAR(1 g) = 0.158 mW/g; SAR(10 g) = 0.106 mW/g

Maximum value of SAR (measured) = 0.211 W/kg

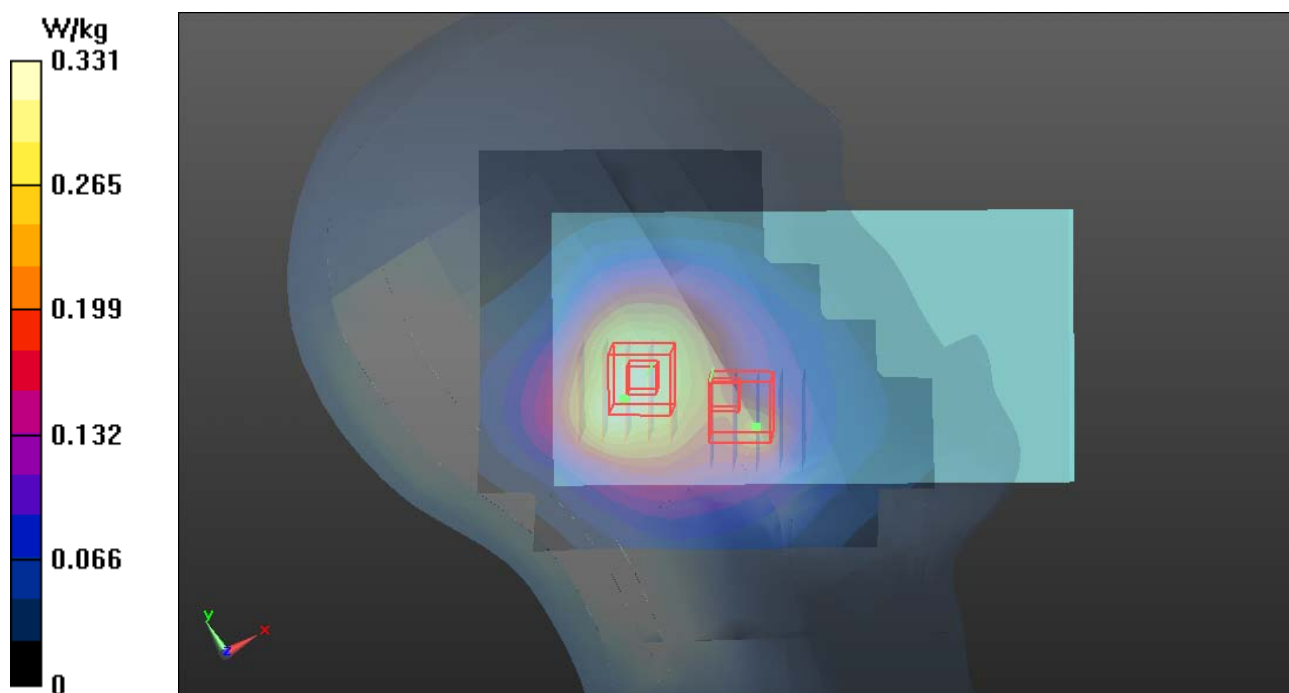

P04 GSM850_GSM_Left Tilted_Ch251

DUT: 120629C20

Communication System: GSM; Frequency: 848.8 MHz; Duty Cycle: 1:8.30042

Medium: H835_0911 Medium parameters used: $f = 849$ MHz; $\sigma = 0.929$ mho/m; $\epsilon_r = 42.571$; $\rho = 1000$ kg/m³

Ambient Temperature : 22.1 °C; Liquid Temperature : 21.2 °C

DASY5 Configuration:

- Probe: EX3DV4 - SN3650; ConvF(8.87, 8.87, 8.87); Calibrated: 2011/10/26;
- Sensor-Surface: 2mm (Mechanical Surface Detection)
- Electronics: DAE4 Sn861; Calibrated: 2012/08/23
- Phantom: SAM Phantom_Left; Type: SAM V4.0; Serial: TP 1202
- Measurement SW: DASY52, Version 52.8 (2); SEMCAD X Version 14.6.6 (6824)

Ch251/Area Scan (71x111x1): Measurement grid: dx=20mm, dy=20mm

Maximum value of SAR (interpolated) = 0.229 W/kg

Ch251/Zoom Scan (5x5x7)/Cube 0: Measurement grid: dx=8mm, dy=8mm, dz=5mm

Reference Value = 13.793 V/m; Power Drift = 0.01 dB

Peak SAR (extrapolated) = 0.244 mW/g

SAR(1 g) = 0.177 mW/g; SAR(10 g) = 0.125 mW/g

Maximum value of SAR (measured) = 0.211 W/kg

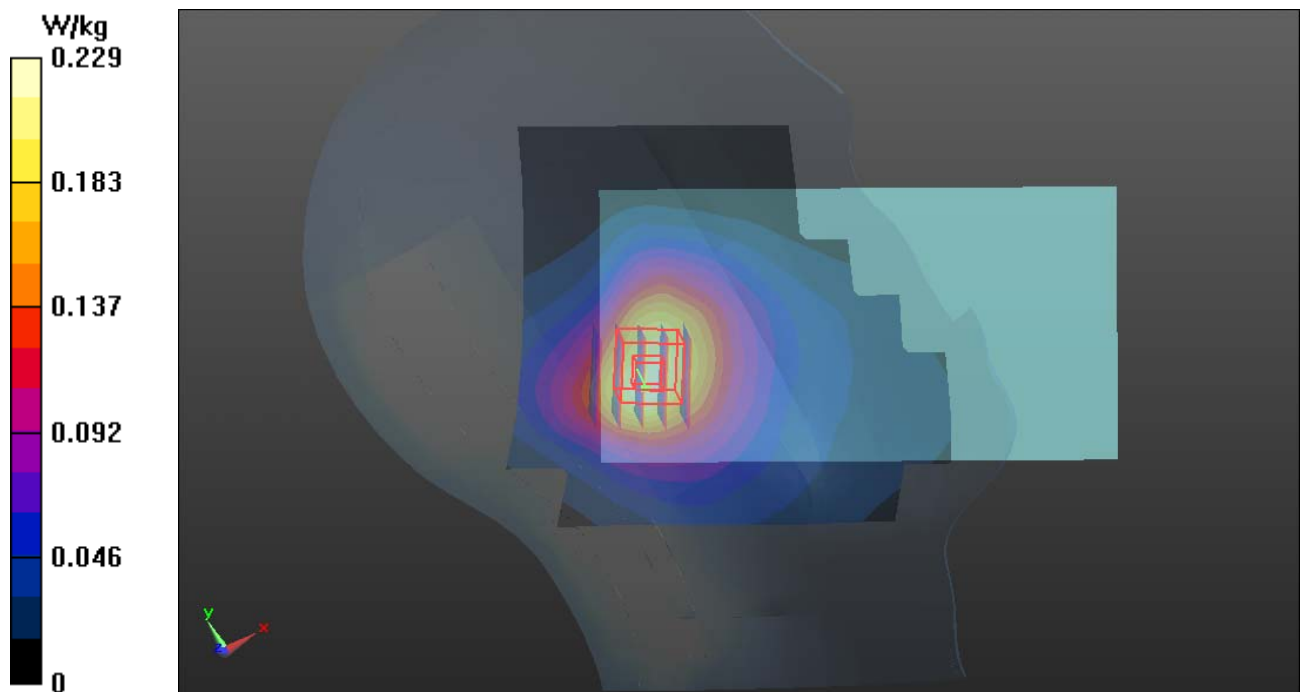

P05 GSM1900_GSM_Right Cheek_Ch810

DUT: 120629C20

Communication System: GSM; Frequency: 1909.8 MHz; Duty Cycle: 1:8.30042

Medium: H1900_0912 Medium parameters used: $f = 1910$ MHz; $\sigma = 1.446$ mho/m; $\epsilon_r = 39.704$; $\rho = 1000$ kg/m³

Ambient Temperature : 22.3 °C ; Liquid Temperature : 21.6 °C

DASY5 Configuration:

- Probe: EX3DV4 - SN3650; ConvF(7.4, 7.4, 7.4); Calibrated: 2011/10/26;
- Sensor-Surface: 2mm (Mechanical Surface Detection)
- Electronics: DAE4 Sn861; Calibrated: 2012/08/23
- Phantom: SAM Phantom_Front; Type: SAM V4.0; Serial: TP 1485
- Measurement SW: DASY52, Version 52.8 (2); SEMCAD X Version 14.6.6 (6824)

Ch810/Area Scan (71x111x1): Measurement grid: dx=20mm, dy=20mm

Maximum value of SAR (interpolated) = 0.413 W/kg

Ch810/Zoom Scan (5x5x7)/Cube 0: Measurement grid: dx=8mm, dy=8mm, dz=5mm

Reference Value = 7.575 V/m; Power Drift = -0.17 dB

Peak SAR (extrapolated) = 0.482 mW/g

SAR(1 g) = 0.290 mW/g; SAR(10 g) = 0.175 mW/g

Maximum value of SAR (measured) = 0.384 W/kg

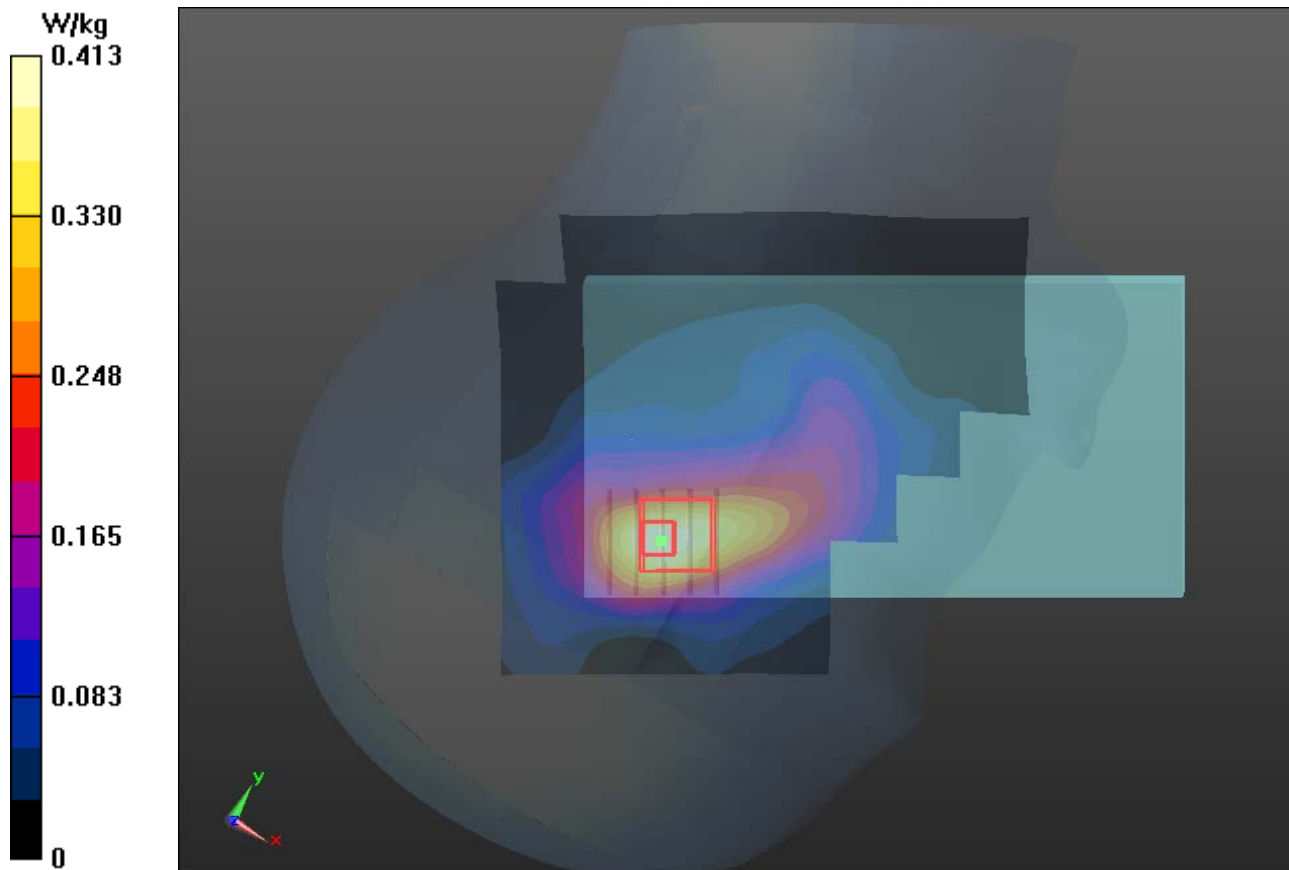

1g/10g Averaged SAR

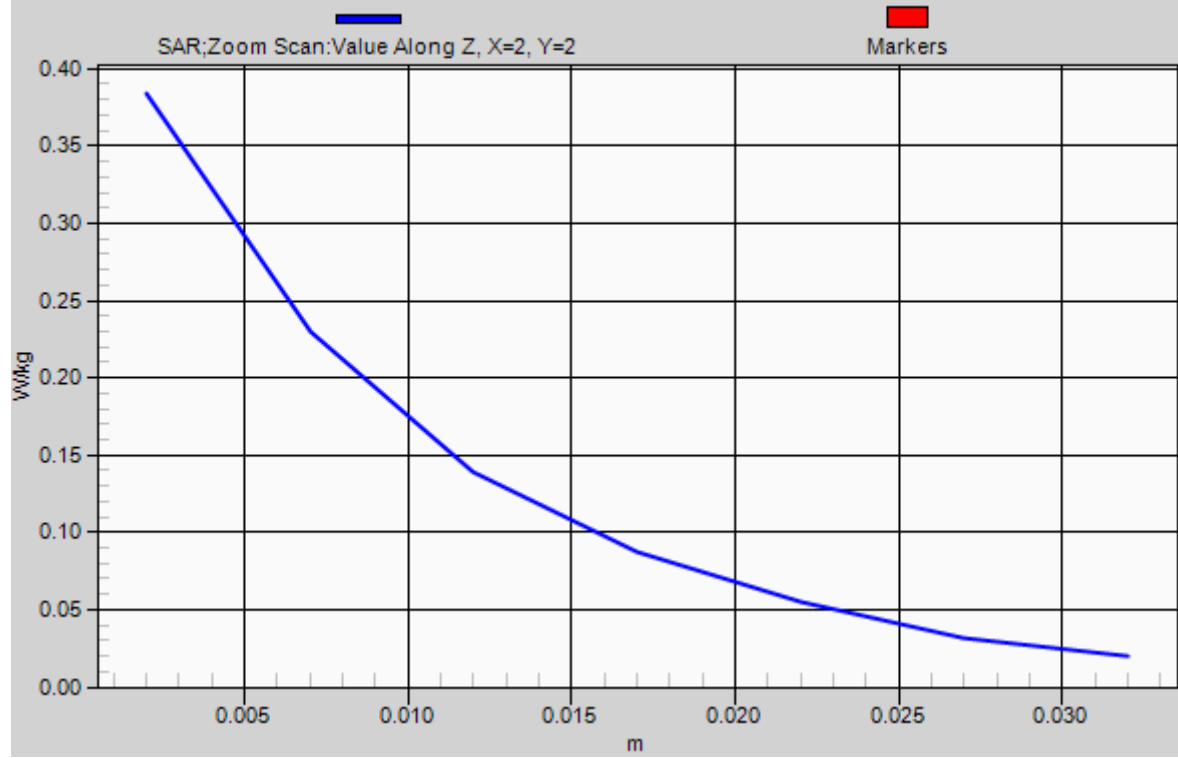

P06 GSM1900_GSM_Right Tilted_Ch810

DUT: 120629C20

Communication System: GSM; Frequency: 1909.8 MHz; Duty Cycle: 1:8.30042

Medium: H1900_0912 Medium parameters used: $f = 1910$ MHz; $\sigma = 1.446$ mho/m; $\epsilon_r = 39.704$; $\rho = 1000$ kg/m³

Ambient Temperature : 22.3 °C ; Liquid Temperature : 21.6 °C

DASY5 Configuration:

- Probe: EX3DV4 - SN3650; ConvF(7.4, 7.4, 7.4); Calibrated: 2011/10/26;
- Sensor-Surface: 2mm (Mechanical Surface Detection)
- Electronics: DAE4 Sn861; Calibrated: 2012/08/23
- Phantom: SAM Phantom_Front; Type: SAM V4.0; Serial: TP 1485
- Measurement SW: DASY52, Version 52.8 (2); SEMCAD X Version 14.6.6 (6824)

Ch810/Area Scan (71x111x1): Measurement grid: dx=20mm, dy=20mm

Maximum value of SAR (interpolated) = 0.255 W/kg

Ch810/Zoom Scan (5x5x7)/Cube 0: Measurement grid: dx=8mm, dy=8mm, dz=5mm

Reference Value = 8.261 V/m; Power Drift = 0.01 dB

Peak SAR (extrapolated) = 0.313 mW/g

SAR(1 g) = 0.190 mW/g; SAR(10 g) = 0.115 mW/g

Maximum value of SAR (measured) = 0.249 W/kg

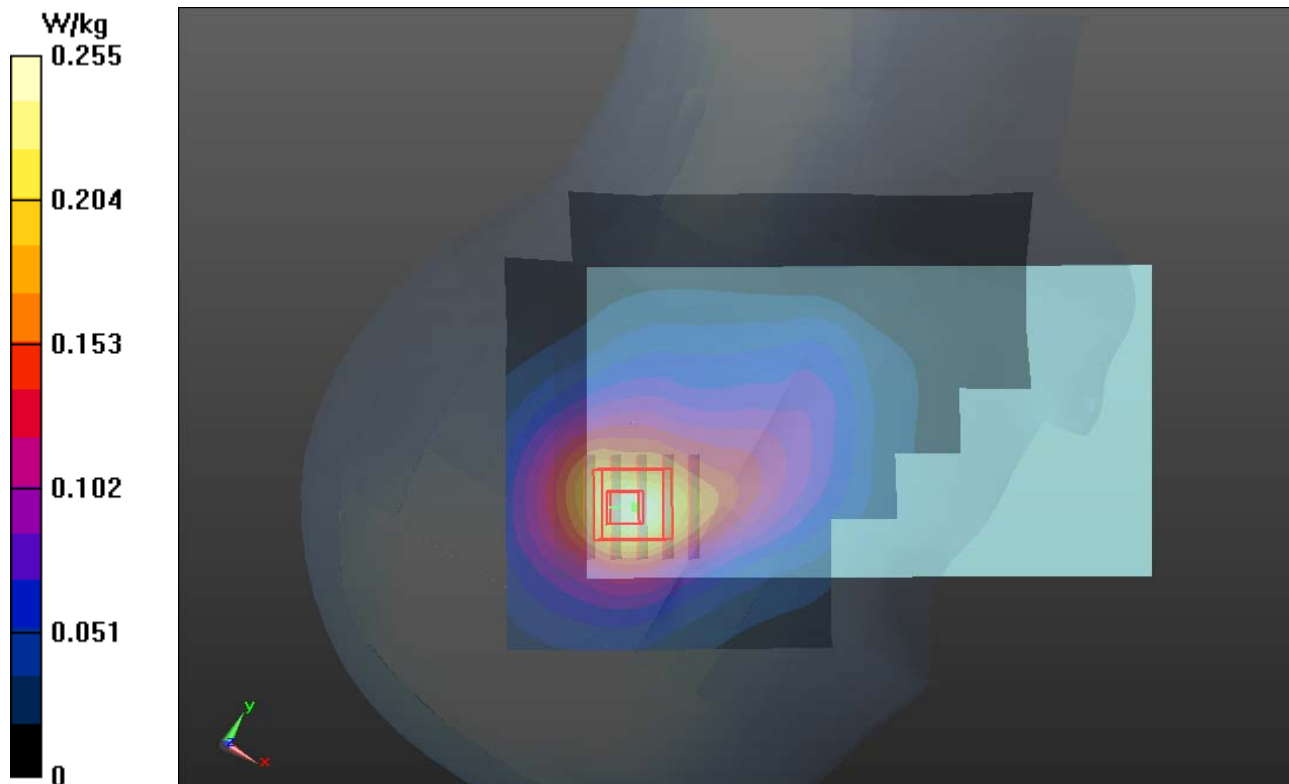

P07 GSM1900_GSM_Left Cheek_Ch810

DUT: 120629C20

Communication System: GSM; Frequency: 1909.8 MHz; Duty Cycle: 1:8.30042

Medium: H1900_0912 Medium parameters used: $f = 1910$ MHz; $\sigma = 1.446$ mho/m; $\epsilon_r = 39.704$; $\rho = 1000$ kg/m³

Ambient Temperature : 22.3 °C ; Liquid Temperature : 21.6 °C

DASY5 Configuration:

- Probe: EX3DV4 - SN3650; ConvF(7.4, 7.4, 7.4); Calibrated: 2011/10/26;
- Sensor-Surface: 2mm (Mechanical Surface Detection)
- Electronics: DAE4 Sn861; Calibrated: 2012/08/23
- Phantom: SAM Phantom_Front; Type: SAM V4.0; Serial: TP 1485
- Measurement SW: DASY52, Version 52.8 (2); SEMCAD X Version 14.6.6 (6824)

Ch810/Area Scan (71x111x1): Measurement grid: dx=20mm, dy=20mm

Maximum value of SAR (interpolated) = 0.220 W/kg

Ch810/Zoom Scan (5x5x7)/Cube 0: Measurement grid: dx=8mm, dy=8mm, dz=5mm

Reference Value = 7.656 V/m; Power Drift = 0.19 dB

Peak SAR (extrapolated) = 0.254 mW/g

SAR(1 g) = 0.165 mW/g; SAR(10 g) = 0.107 mW/g

Maximum value of SAR (measured) = 0.206 W/kg

Ch810/Zoom Scan (5x5x7)/Cube 1: Measurement grid: dx=8mm, dy=8mm, dz=5mm

Reference Value = 7.656 V/m; Power Drift = 0.19 dB

Peak SAR (extrapolated) = 0.214 mW/g

SAR(1 g) = 0.138 mW/g; SAR(10 g) = 0.087 mW/g

Maximum value of SAR (measured) = 0.181 W/kg

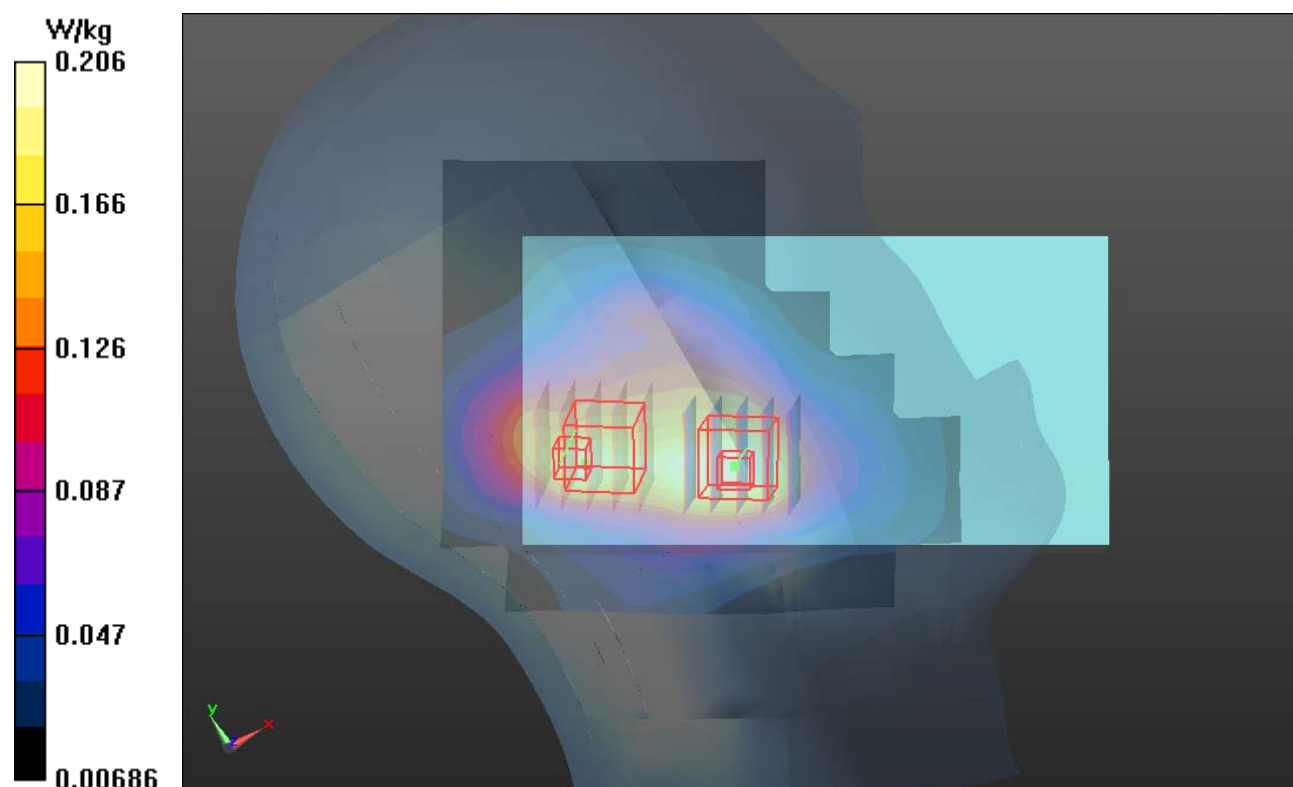

P08 GSM1900_GSM_Left Tilted_Ch810

DUT: 120629C20

Communication System: GSM; Frequency: 1909.8 MHz; Duty Cycle: 1:8.30042

Medium: H1900_0912 Medium parameters used: $f = 1910$ MHz; $\sigma = 1.446$ mho/m; $\epsilon_r = 39.704$; $\rho = 1000$ kg/m³

Ambient Temperature : 22.3 °C ; Liquid Temperature : 21.6 °C

DASY5 Configuration:

- Probe: EX3DV4 - SN3650; ConvF(7.4, 7.4, 7.4); Calibrated: 2011/10/26;
- Sensor-Surface: 2mm (Mechanical Surface Detection)
- Electronics: DAE4 Sn861; Calibrated: 2012/08/23
- Phantom: SAM Phantom_Front; Type: SAM V4.0; Serial: TP 1485
- Measurement SW: DASY52, Version 52.8 (2); SEMCAD X Version 14.6.6 (6824)

Ch810/Area Scan (71x111x1): Measurement grid: dx=20mm, dy=20mm

Maximum value of SAR (interpolated) = 0.163 W/kg

Ch810/Zoom Scan (5x5x7)/Cube 0: Measurement grid: dx=8mm, dy=8mm, dz=5mm

Reference Value = 8.943 V/m; Power Drift = -0.12 dB

Peak SAR (extrapolated) = 0.190 mW/g

SAR(1 g) = 0.121 mW/g; SAR(10 g) = 0.074 mW/g

Maximum value of SAR (measured) = 0.153 W/kg

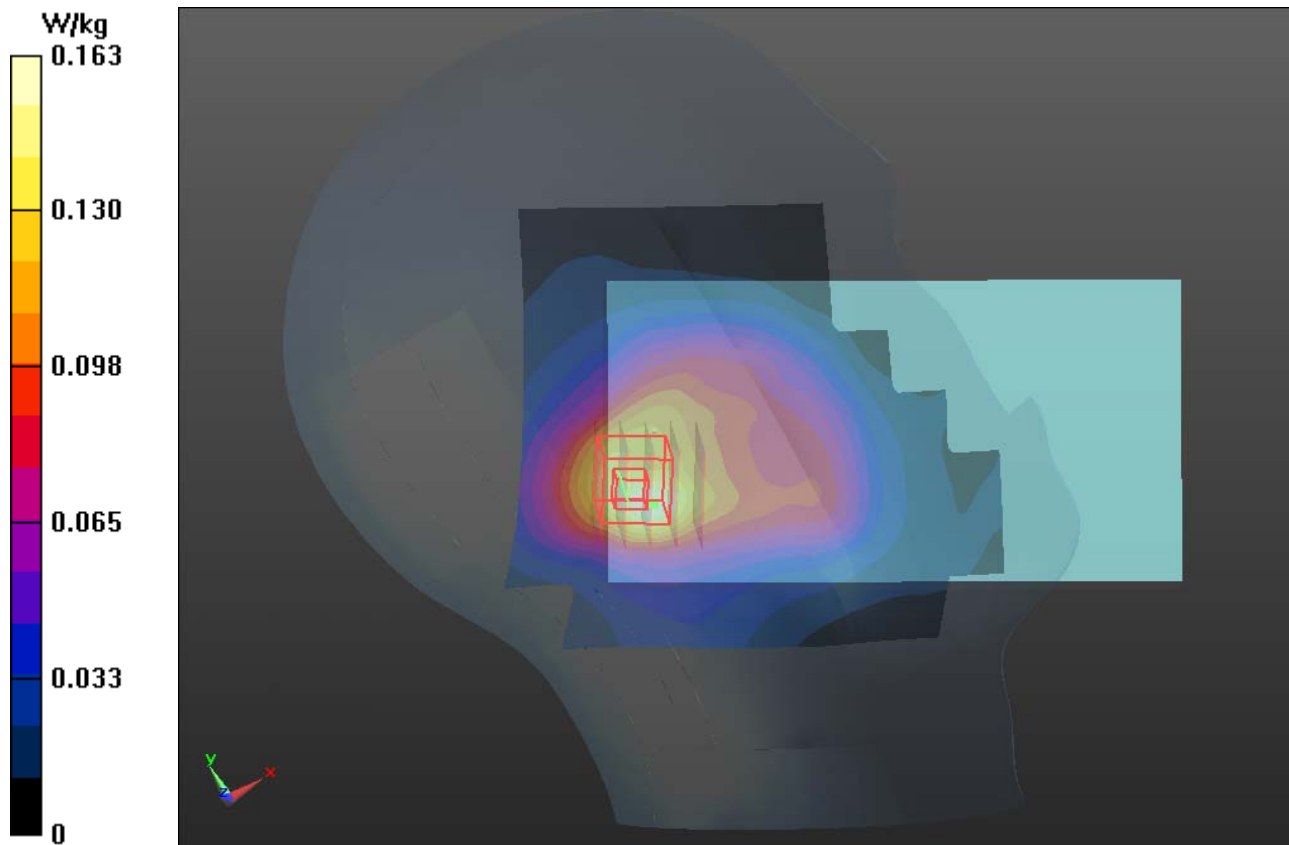

P09 WCDMA V_RMC12.2K_Right Cheek_Ch4182

DUT: 120629C20

Communication System: WCDMA; Frequency: 836.4 MHz; Duty Cycle: 1:1

Medium: H835_0912 Medium parameters used : $f = 836.4$ MHz; $\sigma = 0.91$ mho/m; $\epsilon_r = 42.324$; $\rho = 1000$ kg/m³

Ambient Temperature : 22.2 °C; Liquid Temperature : 21.5 °C

DASY5 Configuration:

- Probe: EX3DV4 - SN3650; ConvF(8.87, 8.87, 8.87); Calibrated: 2011/10/26;
- Sensor-Surface: 2mm (Mechanical Surface Detection)
- Electronics: DAE4 Sn861; Calibrated: 2012/08/23
- Phantom: SAM Phantom_Left; Type: SAM V4.0; Serial: TP 1202
- Measurement SW: DASY52, Version 52.8 (2); SEMCAD X Version 14.6.6 (6824)

Ch4182/Area Scan (71x111x1): Measurement grid: dx=20mm, dy=20mm

Maximum value of SAR (interpolated) = 0.391 W/kg

Ch4182/Zoom Scan (5x5x7)/Cube 0: Measurement grid: dx=8mm, dy=8mm, dz=5mm

Reference Value = 11.528 V/m; Power Drift = 0.03 dB

Peak SAR (extrapolated) = 0.447 mW/g

SAR(1 g) = 0.300 mW/g; SAR(10 g) = 0.205 mW/g

Maximum value of SAR (measured) = 0.372 W/kg

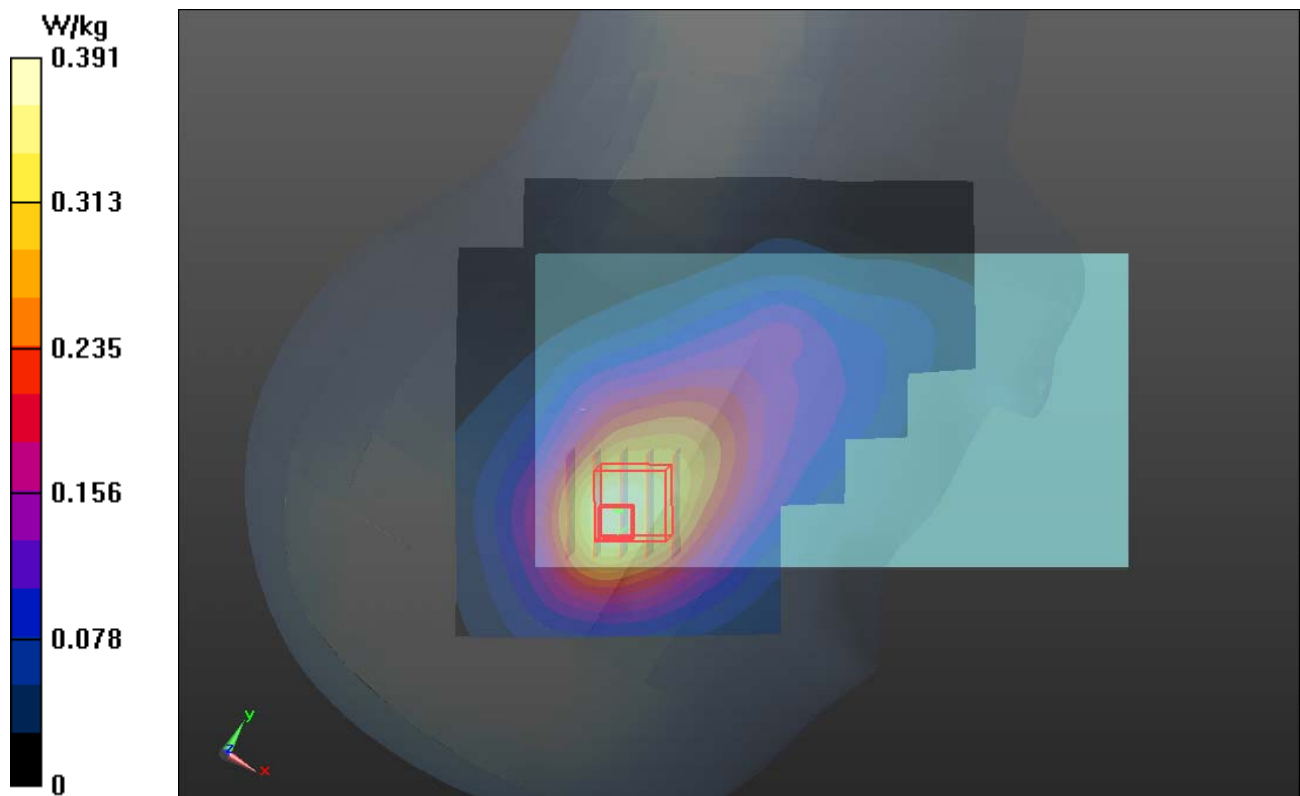

1g/10g Averaged SAR

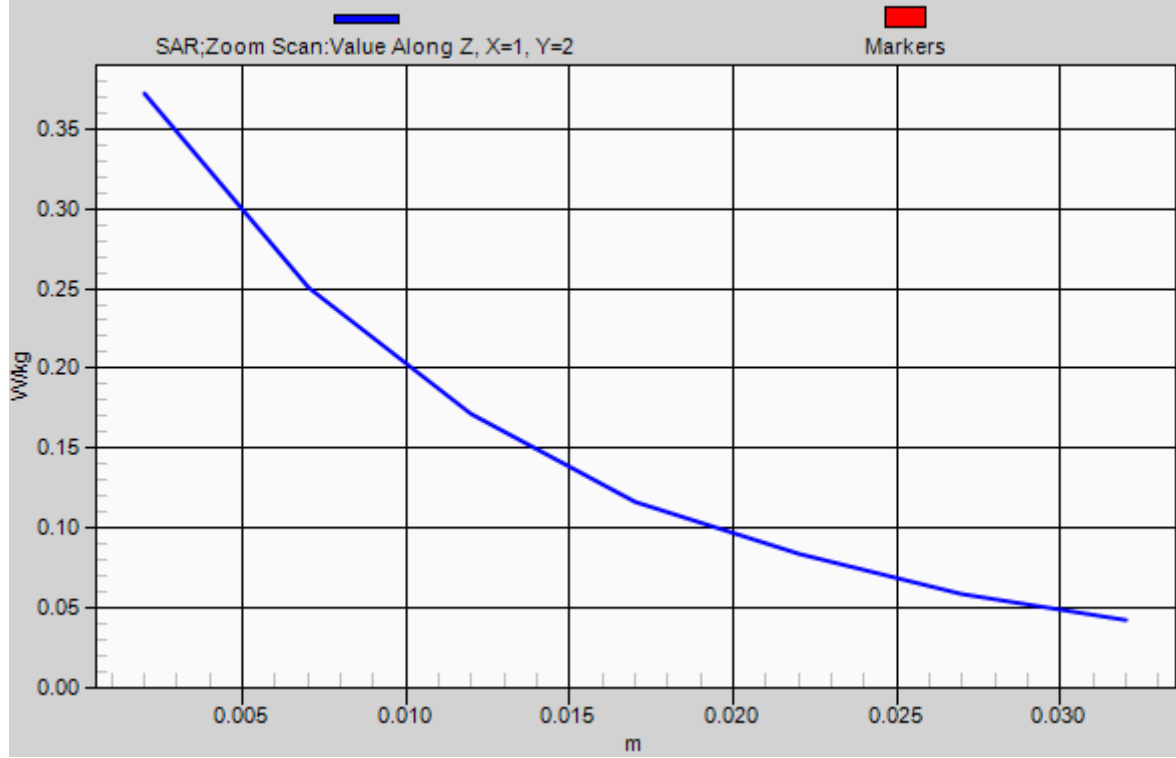

P10 WCDMA V_RMC12.2K_Right Tilted_Ch4182

DUT: 120629C20

Communication System: WCDMA; Frequency: 836.4 MHz; Duty Cycle: 1:1

Medium: H835_0912 Medium parameters used : $f = 836.4$ MHz; $\sigma = 0.91$ mho/m; $\epsilon_r = 42.324$; $\rho = 1000$ kg/m³

Ambient Temperature : 22.2 °C; Liquid Temperature : 21.5 °C

DASY5 Configuration:

- Probe: EX3DV4 - SN3650; ConvF(8.87, 8.87, 8.87); Calibrated: 2011/10/26;
- Sensor-Surface: 2mm (Mechanical Surface Detection)
- Electronics: DAE4 Sn861; Calibrated: 2012/08/23
- Phantom: SAM Phantom_Left; Type: SAM V4.0; Serial: TP 1202
- Measurement SW: DASY52, Version 52.8 (2); SEMCAD X Version 14.6.6 (6824)

Ch4182/Area Scan (71x111x1): Measurement grid: dx=20mm, dy=20mm

Maximum value of SAR (interpolated) = 0.272 W/kg

Ch4182/Zoom Scan (5x5x7)/Cube 0: Measurement grid: dx=8mm, dy=8mm, dz=5mm

Reference Value = 11.097 V/m; Power Drift = 0.03 dB

Peak SAR (extrapolated) = 0.320 mW/g

SAR(1 g) = 0.218 mW/g; SAR(10 g) = 0.144 mW/g

Maximum value of SAR (measured) = 0.267 W/kg

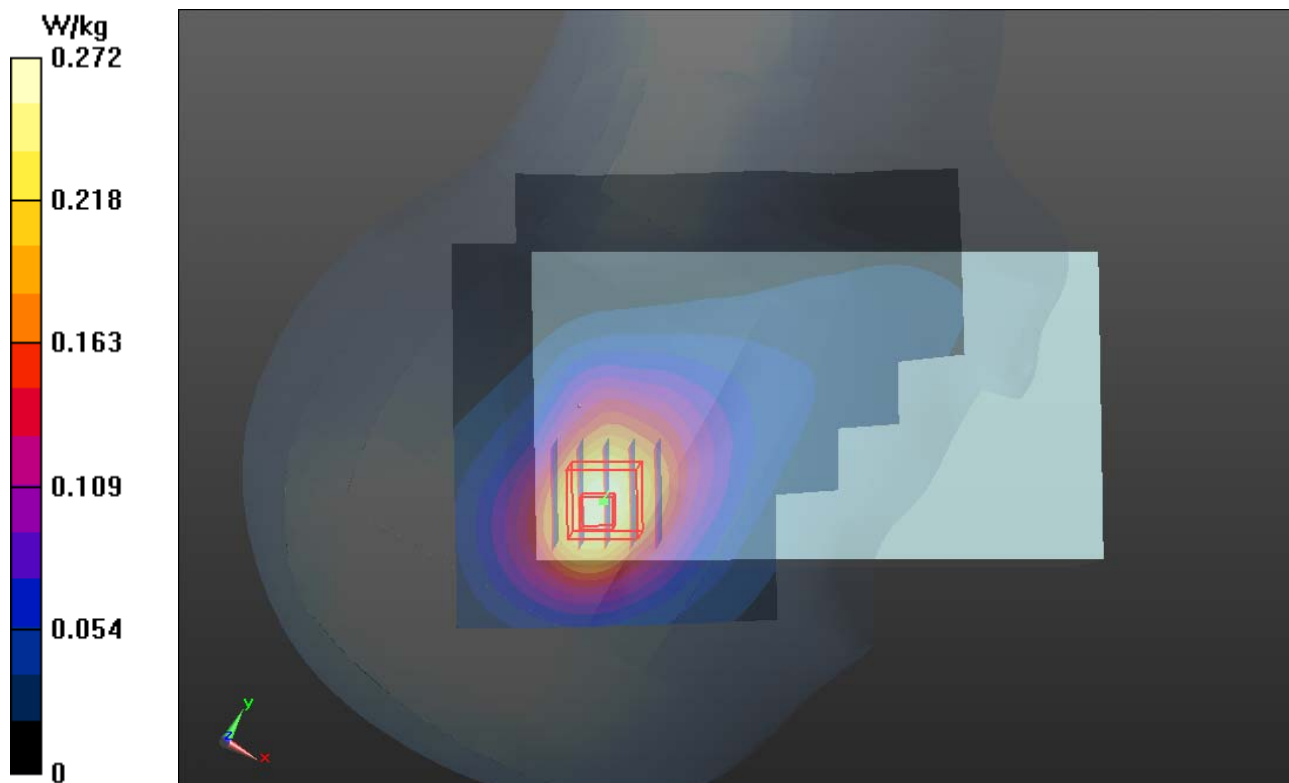

P11 WCDMA V_RMC12.2K_Left Cheek_Ch4182

DUT: 120629C20

Communication System: WCDMA; Frequency: 836.4 MHz; Duty Cycle: 1:1

Medium: H835_0912 Medium parameters used : $f = 836.4$ MHz; $\sigma = 0.91$ mho/m; $\epsilon_r = 42.324$; $\rho = 1000$ kg/m³

Ambient Temperature : 22.2 °C ; Liquid Temperature : 21.5 °C

DASY5 Configuration:

- Probe: EX3DV4 - SN3650; ConvF(8.87, 8.87, 8.87); Calibrated: 2011/10/26;
- Sensor-Surface: 2mm (Mechanical Surface Detection)
- Electronics: DAE4 Sn861; Calibrated: 2012/08/23
- Phantom: SAM Phantom_Left; Type: SAM V4.0; Serial: TP 1202
- Measurement SW: DASY52, Version 52.8 (2); SEMCAD X Version 14.6.6 (6824)

Ch4182/Area Scan (71x111x1): Measurement grid: dx=20mm, dy=20mm

Maximum value of SAR (interpolated) = 0.280 W/kg

Ch4182/Zoom Scan (5x5x7)/Cube 0: Measurement grid: dx=8mm, dy=8mm, dz=5mm

Reference Value = 14.380 V/m; Power Drift = 0.01 dB

Peak SAR (extrapolated) = 0.310 mW/g

SAR(1 g) = 0.235 mW/g; SAR(10 g) = 0.172 mW/g

Maximum value of SAR (measured) = 0.276 W/kg

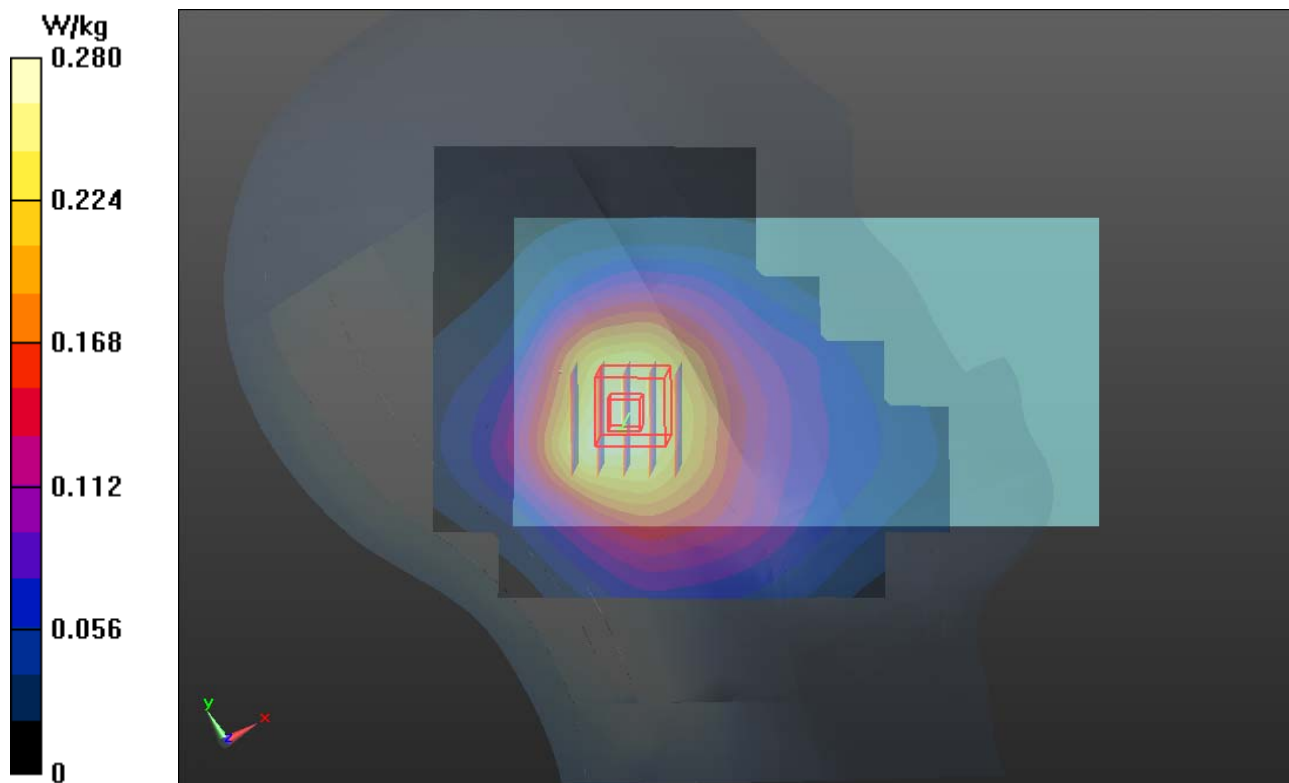

P12 WCDMA V_RMC12.2K_Left Tilted_Ch4182

DUT: 120629C20

Communication System: WCDMA; Frequency: 836.4 MHz; Duty Cycle: 1:1

Medium: H835_0912 Medium parameters used : $f = 836.4$ MHz; $\sigma = 0.91$ mho/m; $\epsilon_r = 42.324$; $\rho = 1000$ kg/m³

Ambient Temperature : 22.2 °C ; Liquid Temperature : 21.5 °C

DASY5 Configuration:

- Probe: EX3DV4 - SN3650; ConvF(8.87, 8.87, 8.87); Calibrated: 2011/10/26;
- Sensor-Surface: 2mm (Mechanical Surface Detection)
- Electronics: DAE4 Sn861; Calibrated: 2012/08/23
- Phantom: SAM Phantom_Left; Type: SAM V4.0; Serial: TP 1202
- Measurement SW: DASY52, Version 52.8 (2); SEMCAD X Version 14.6.6 (6824)

Ch4182/Area Scan (71x111x1): Measurement grid: dx=20mm, dy=20mm

Maximum value of SAR (interpolated) = 0.165 W/kg

Ch4182/Zoom Scan (5x5x7)/Cube 0: Measurement grid: dx=8mm, dy=8mm, dz=5mm

Reference Value = 11.171 V/m; Power Drift = -0.03 dB

Peak SAR (extrapolated) = 0.179 mW/g

SAR(1 g) = 0.133 mW/g; SAR(10 g) = 0.095 mW/g

Maximum value of SAR (measured) = 0.156 W/kg

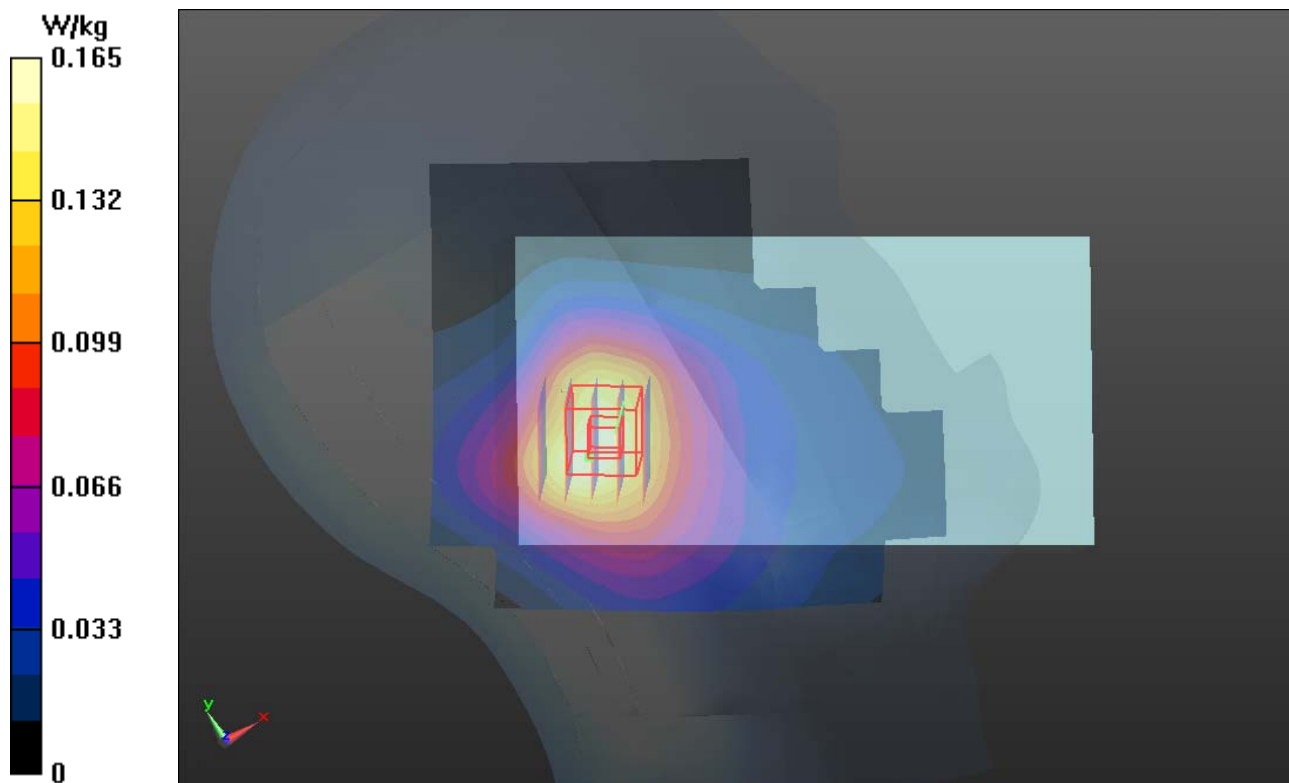

P13 WCDMA II_RMC12.2K_Right Cheek_Ch9400

DUT: 120629C20

Communication System: WCDMA; Frequency: 1880 MHz; Duty Cycle: 1:1

Medium: H1900_0912 Medium parameters used: $f = 1880$ MHz; $\sigma = 1.416$ mho/m; $\epsilon_r = 39.834$; $\rho = 1000$ kg/m³

Ambient Temperature : 22.3 °C ; Liquid Temperature : 21.6 °C

DASY5 Configuration:

- Probe: EX3DV4 - SN3650; ConvF(7.4, 7.4, 7.4); Calibrated: 2011/10/26;
- Sensor-Surface: 2mm (Mechanical Surface Detection)
- Electronics: DAE4 Sn861; Calibrated: 2012/08/23
- Phantom: SAM Phantom_Front; Type: SAM V4.0; Serial: TP 1485
- Measurement SW: DASY52, Version 52.8 (2); SEMCAD X Version 14.6.6 (6824)

Ch9400/Area Scan (71x111x1): Measurement grid: dx=20mm, dy=20mm

Maximum value of SAR (interpolated) = 0.523 W/kg

Ch9400/Zoom Scan (5x5x7)/Cube 0: Measurement grid: dx=8mm, dy=8mm, dz=5mm

Reference Value = 8.308 V/m; Power Drift = -0.12 dB

Peak SAR (extrapolated) = 0.619 mW/g

SAR(1 g) = 0.374 mW/g; SAR(10 g) = 0.226 mW/g

Maximum value of SAR (measured) = 0.497 W/kg

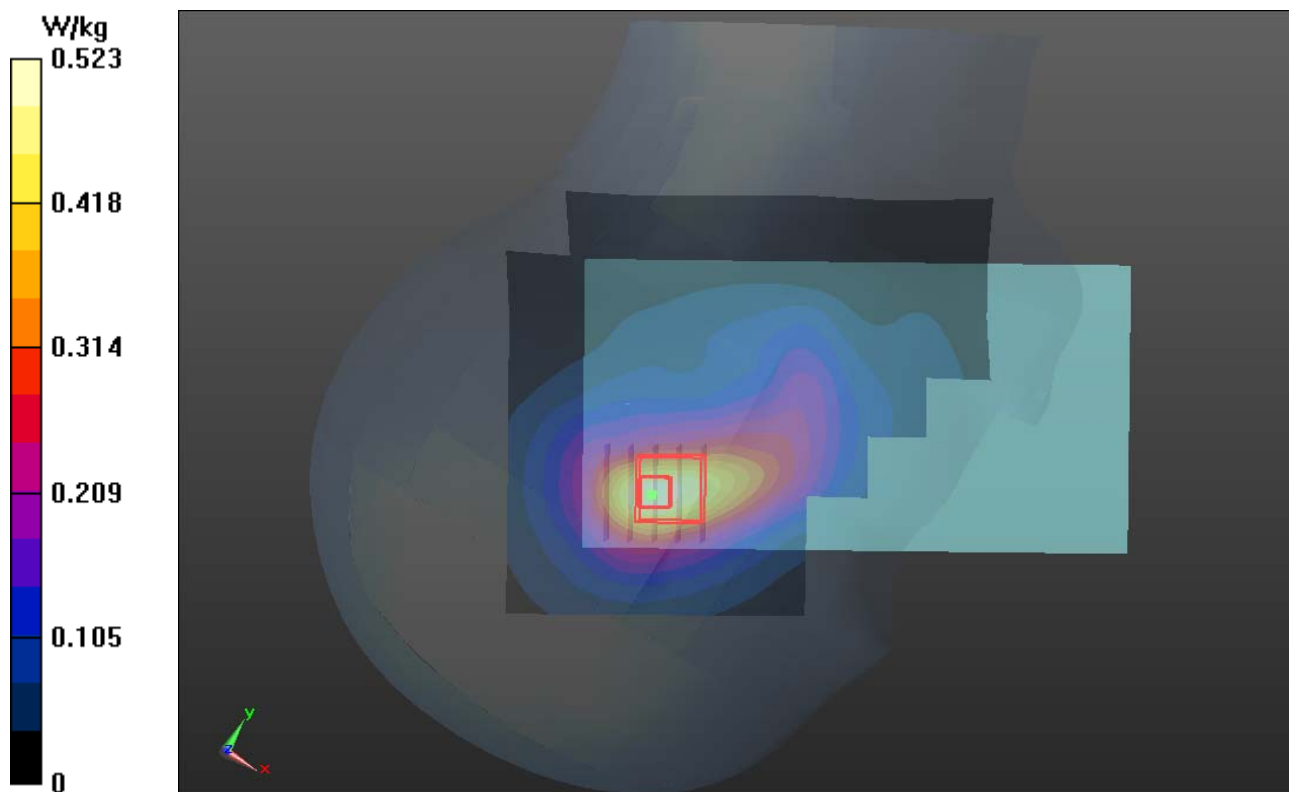

1g/10g Averaged SAR

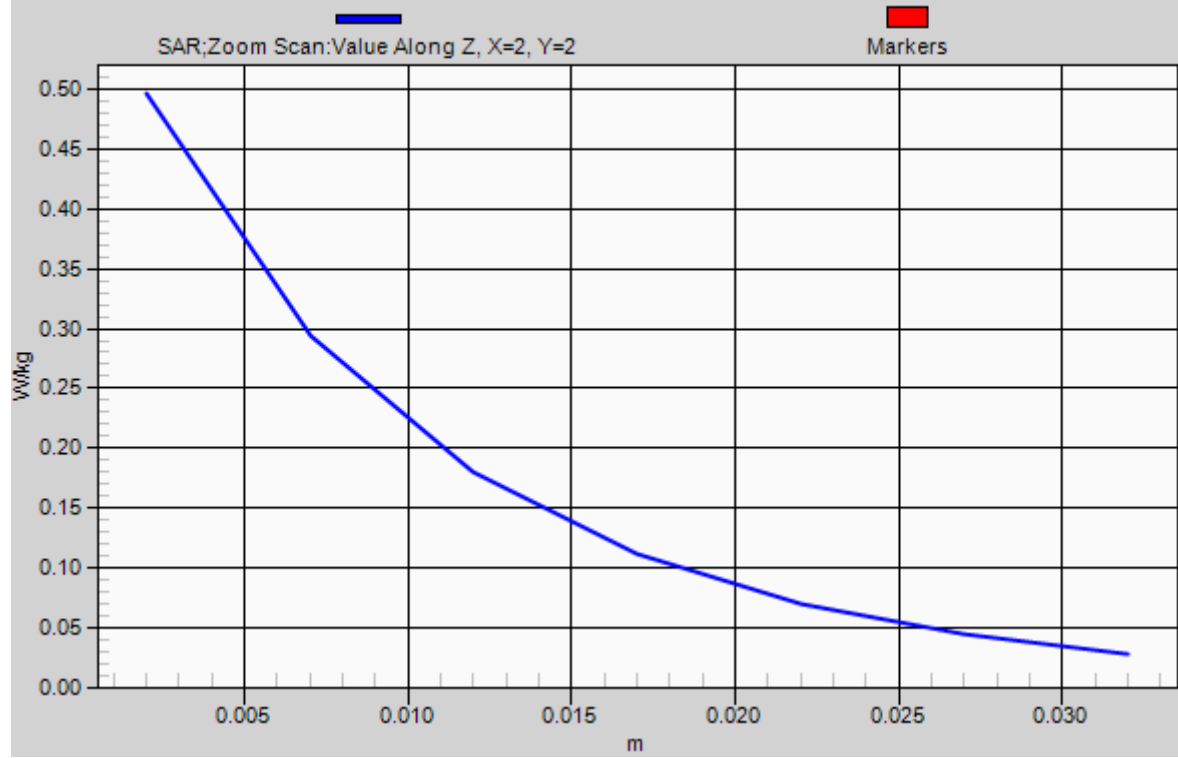

P14 WCDMA II_RMC12.2K_Right Tilted_Ch9400

DUT: 120629C20

Communication System: WCDMA; Frequency: 1880 MHz; Duty Cycle: 1:1

Medium: H1900_0912 Medium parameters used: $f = 1880$ MHz; $\sigma = 1.416$ mho/m; $\epsilon_r = 39.834$; $\rho = 1000$ kg/m³

Ambient Temperature : 22.3 °C ; Liquid Temperature : 21.6 °C

DASY5 Configuration:

- Probe: EX3DV4 - SN3650; ConvF(7.4, 7.4, 7.4); Calibrated: 2011/10/26;
- Sensor-Surface: 2mm (Mechanical Surface Detection)
- Electronics: DAE4 Sn861; Calibrated: 2012/08/23
- Phantom: SAM Phantom_Front; Type: SAM V4.0; Serial: TP 1485
- Measurement SW: DASY52, Version 52.8 (2); SEMCAD X Version 14.6.6 (6824)

Ch9400/Area Scan (71x111x1): Measurement grid: dx=20mm, dy=20mm

Maximum value of SAR (interpolated) = 0.330 W/kg

Ch9400/Zoom Scan (5x5x7)/Cube 0: Measurement grid: dx=8mm, dy=8mm, dz=5mm

Reference Value = 8.675 V/m; Power Drift = 0.15 dB

Peak SAR (extrapolated) = 0.390 mW/g

SAR(1 g) = 0.241 mW/g; SAR(10 g) = 0.145 mW/g

Maximum value of SAR (measured) = 0.314 W/kg

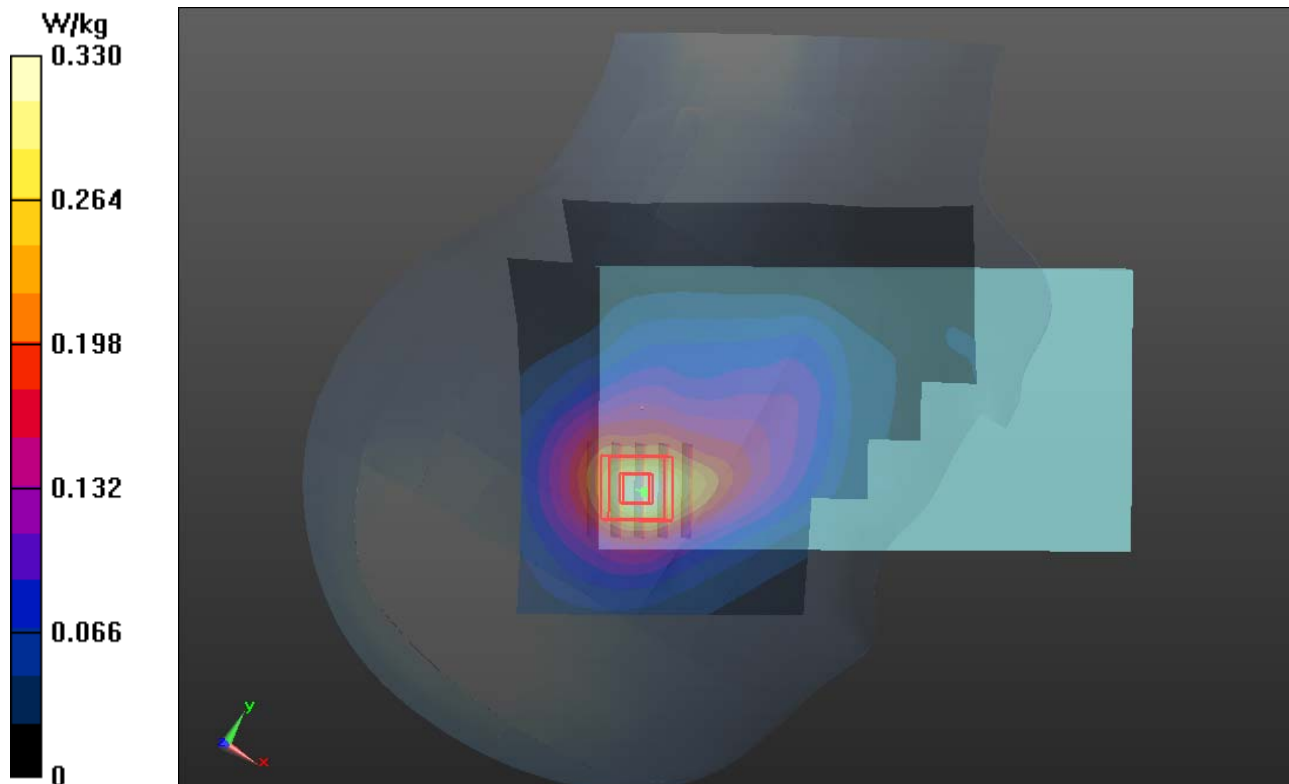

P15 WCDMA II_RMC12.2K_Left Cheek_Ch9400

DUT: 120629C20

Communication System: WCDMA; Frequency: 1880 MHz; Duty Cycle: 1:1

Medium: H1900_0912 Medium parameters used: $f = 1880$ MHz; $\sigma = 1.416$ mho/m; $\epsilon_r = 39.834$; $\rho = 1000$ kg/m³

Ambient Temperature : 22.3 °C ; Liquid Temperature : 21.6 °C

DASY5 Configuration:

- Probe: EX3DV4 - SN3650; ConvF(7.4, 7.4, 7.4); Calibrated: 2011/10/26;
- Sensor-Surface: 2mm (Mechanical Surface Detection)
- Electronics: DAE4 Sn861; Calibrated: 2012/08/23
- Phantom: SAM Phantom_Front; Type: SAM V4.0; Serial: TP 1485
- Measurement SW: DASY52, Version 52.8 (2); SEMCAD X Version 14.6.6 (6824)

Ch9400/Area Scan (71x111x1): Measurement grid: dx=20mm, dy=20mm

Maximum value of SAR (interpolated) = 0.325 W/kg

Ch9400/Zoom Scan (5x5x7)/Cube 0: Measurement grid: dx=8mm, dy=8mm, dz=5mm

Reference Value = 8.449 V/m; Power Drift = -0.15 dB

Peak SAR (extrapolated) = 0.362 mW/g

SAR(1 g) = 0.243 mW/g; SAR(10 g) = 0.158 mW/g

Maximum value of SAR (measured) = 0.308 W/kg

Ch9400/Zoom Scan (5x5x7)/Cube 1: Measurement grid: dx=8mm, dy=8mm, dz=5mm

Reference Value = 8.449 V/m; Power Drift = -0.15 dB

Peak SAR (extrapolated) = 0.258 mW/g

SAR(1 g) = 0.014 mW/g; SAR(10 g) = 0.00581 mW/g

Maximum value of SAR (measured) = 0.117 W/kg

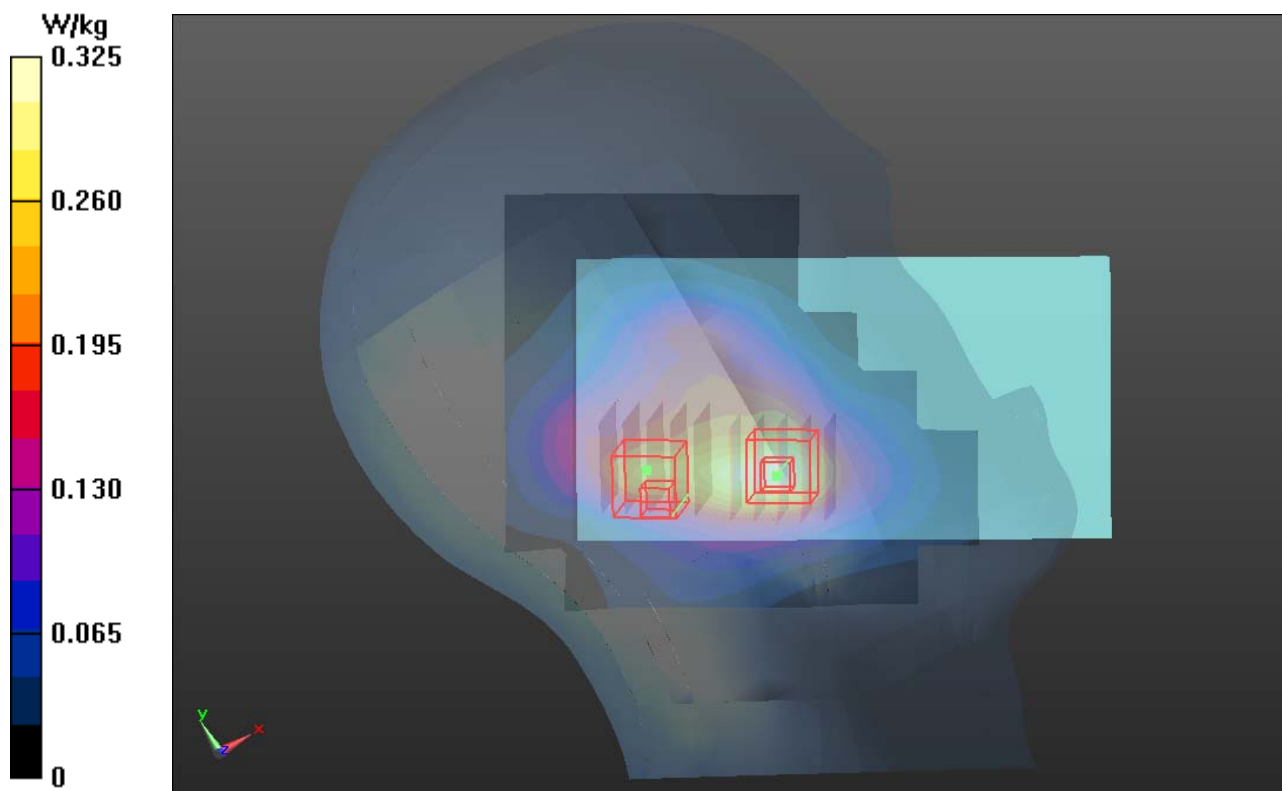

P16 WCDMA II_RMC12.2K_Left Tilted_Ch9400

DUT: 120629C20

Communication System: WCDMA; Frequency: 1880 MHz; Duty Cycle: 1:1

Medium: H1900_0912 Medium parameters used: $f = 1880$ MHz; $\sigma = 1.416$ mho/m; $\epsilon_r = 39.834$; $\rho = 1000$ kg/m³

Ambient Temperature : 22.3 °C ; Liquid Temperature : 21.6 °C

DASY5 Configuration:

- Probe: EX3DV4 - SN3650; ConvF(7.4, 7.4, 7.4); Calibrated: 2011/10/26;
- Sensor-Surface: 2mm (Mechanical Surface Detection)
- Electronics: DAE4 Sn861; Calibrated: 2012/08/23
- Phantom: SAM Phantom_Front; Type: SAM V4.0; Serial: TP 1485
- Measurement SW: DASY52, Version 52.8 (2); SEMCAD X Version 14.6.6 (6824)

Ch9400/Area Scan (71x111x1): Measurement grid: dx=20mm, dy=20mm

Maximum value of SAR (interpolated) = 0.412 W/kg

Ch9400/Zoom Scan (5x5x7)/Cube 0: Measurement grid: dx=8mm, dy=8mm, dz=5mm

Reference Value = 9.450 V/m; Power Drift = 0.01 dB

Peak SAR (extrapolated) = 0.252 mW/g

SAR(1 g) = 0.160 mW/g; SAR(10 g) = 0.099 mW/g

Maximum value of SAR (measured) = 0.208 W/kg

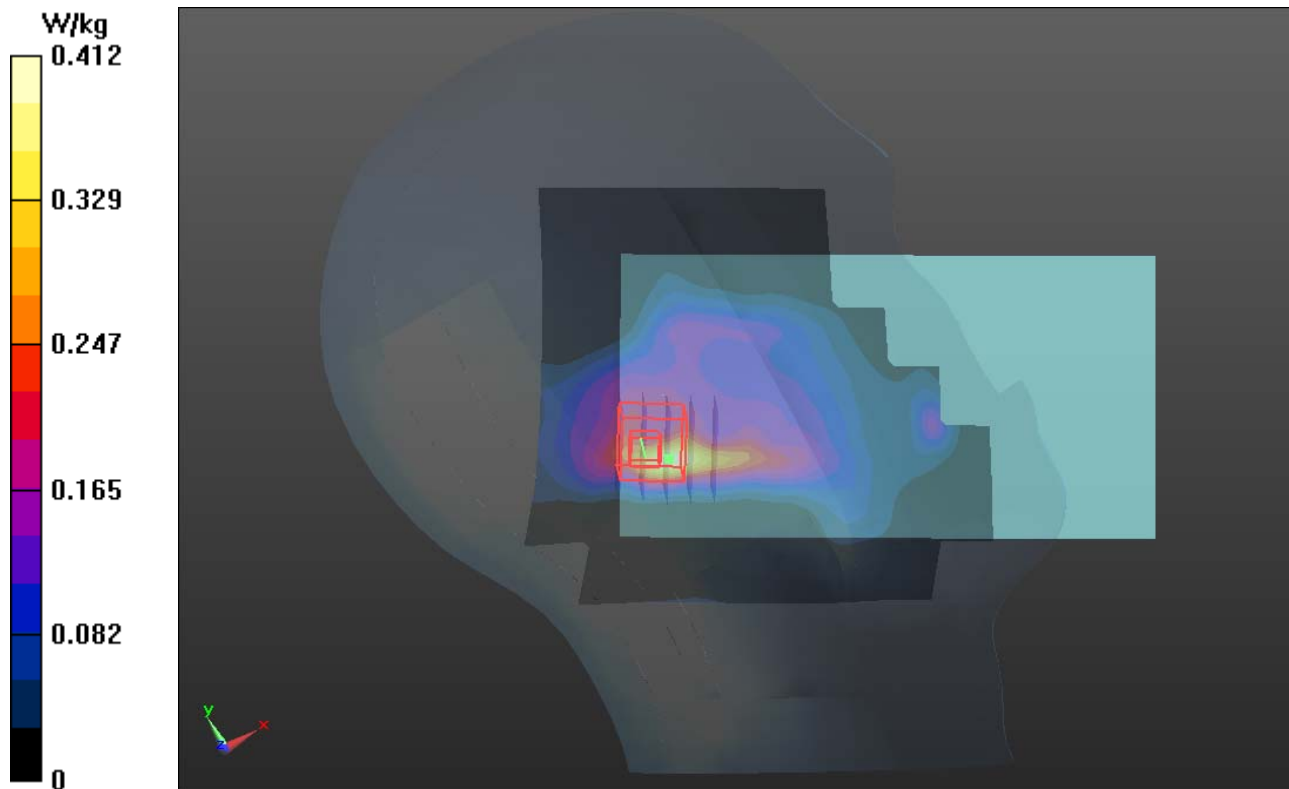

P32 802.11b_Right Cheek_Ch11_ANT 0

DUT: 120629C20

Communication System: 802.11b; Frequency: 2462 MHz; Duty Cycle: 1:1

Medium: H2450_0918 Medium parameters used: $f = 2462$ MHz; $\sigma = 1.8$ mho/m; $\epsilon_r = 40.2$; $\rho = 1000$ kg/m³

Ambient Temperature : 22.3 °C ; Liquid Temperature : 21.5 °C

DASY4 Configuration:

- Probe: EX3DV4 - SN3864; ConvF(7.28, 7.28, 7.28); Calibrated: 2012/07/19
- Sensor-Surface: 2mm (Mechanical Surface Detection)
- Electronics: DAE4 Sn1277; Calibrated: 2012/07/19
- Phantom: SAM Phantom_Left; Type: SAM V4.0; Serial: TP 1652
- Measurement SW: DASY4, V4.7 Build 80; Postprocessing SW: SEMCAD, V1.8 Build 186

Ch11/Area Scan (61x111x1): Measurement grid: dx=20mm, dy=20mm

Maximum value of SAR (interpolated) = 0.102 mW/g

Ch11/Zoom Scan (5x5x7)/Cube 0: Measurement grid: dx=8mm, dy=8mm, dz=5mm

Reference Value = 2.28 V/m; Power Drift = 0.181 dB

Peak SAR (extrapolated) = 0.154 W/kg

SAR(1 g) = 0.082 mW/g; SAR(10 g) = 0.044 mW/g

Maximum value of SAR (measured) = 0.117 mW/g

Ch11/Zoom Scan (5x5x7)/Cube 1: Measurement grid: dx=8mm, dy=8mm, dz=5mm

Reference Value = 2.28 V/m; Power Drift = 0.181 dB

Peak SAR (extrapolated) = 0.066 W/kg

SAR(1 g) = 0.038 mW/g; SAR(10 g) = 0.020 mW/g

Maximum value of SAR (measured) = 0.051 mW/g

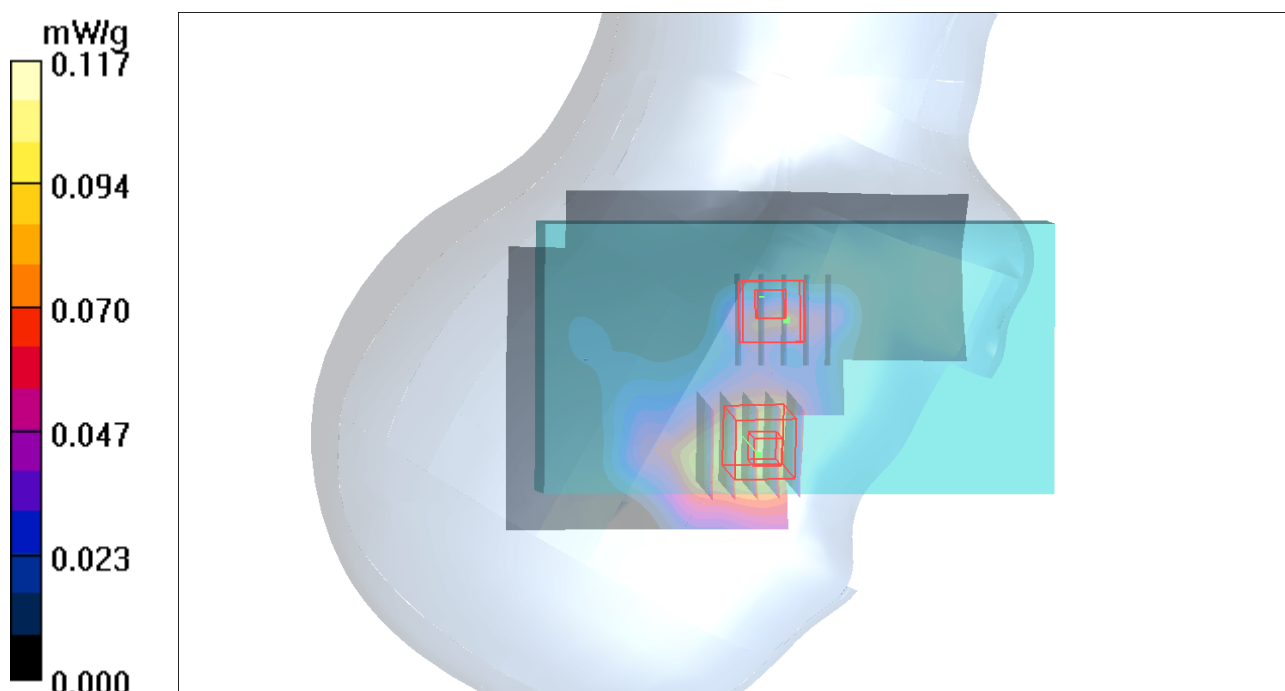

P33 802.11b_Right Tilted_Ch11_ANT 0

DUT: 120629C20

Communication System: 802.11b; Frequency: 2462 MHz; Duty Cycle: 1:1

Medium: H2450_0918 Medium parameters used: $f = 2462$ MHz; $\sigma = 1.8$ mho/m; $\epsilon_r = 40.2$; $\rho = 1000$ kg/m³

Ambient Temperature : 22.3 °C ; Liquid Temperature : 21.5 °C

DASY4 Configuration:

- Probe: EX3DV4 - SN3864; ConvF(7.28, 7.28, 7.28); Calibrated: 2012/07/19
- Sensor-Surface: 2mm (Mechanical Surface Detection)
- Electronics: DAE4 Sn1277; Calibrated: 2012/07/19
- Phantom: SAM Phantom_Left; Type: SAM V4.0; Serial: TP 1652
- Measurement SW: DASY4, V4.7 Build 80; Postprocessing SW: SEMCAD, V1.8 Build 186

Ch11/Area Scan (61x111x1): Measurement grid: dx=20mm, dy=20mm

Maximum value of SAR (interpolated) = 0.050 mW/g

Ch11/Zoom Scan (5x5x7)/Cube 0: Measurement grid: dx=8mm, dy=8mm, dz=5mm

Reference Value = 3.03 V/m; Power Drift = -0.175 dB

Peak SAR (extrapolated) = 0.035 W/kg

SAR(1 g) = 0.025 mW/g; SAR(10 g) = 0.011 mW/g

Maximum value of SAR (measured) = 0.033 mW/g

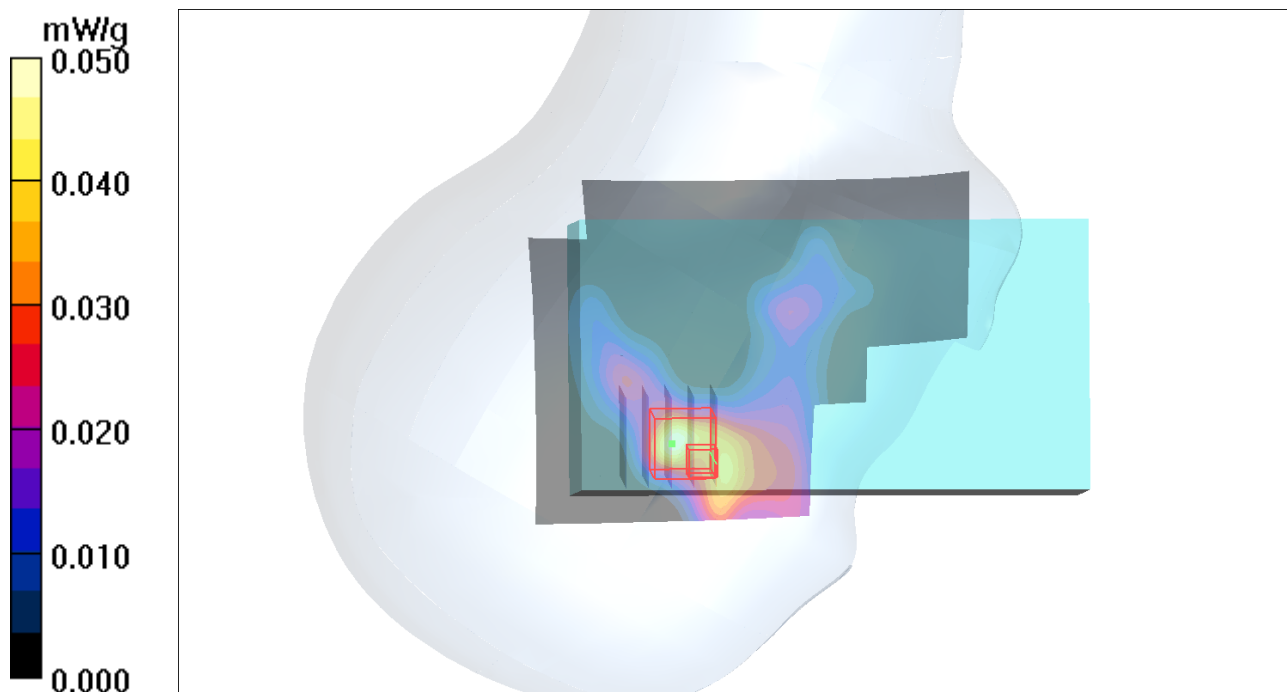

P34 802.11b_Left Cheek_Ch11_ANT 0

DUT: 120629C20

Communication System: 802.11b; Frequency: 2462 MHz; Duty Cycle: 1:1

Medium: H2450_0918 Medium parameters used: $f = 2462$ MHz; $\sigma = 1.8$ mho/m; $\epsilon_r = 40.2$; $\rho = 1000$ kg/m³

Ambient Temperature : 22.3 °C ; Liquid Temperature : 21.5 °C

DASY4 Configuration:

- Probe: EX3DV4 - SN3864; ConvF(7.28, 7.28, 7.28); Calibrated: 2012/07/19
- Sensor-Surface: 2mm (Mechanical Surface Detection)
- Electronics: DAE4 Sn1277; Calibrated: 2012/07/19
- Phantom: SAM Phantom_Left; Type: SAM V4.0; Serial: TP 1652
- Measurement SW: DASY4, V4.7 Build 80; Postprocessing SW: SEMCAD, V1.8 Build 186

Ch11/Area Scan (61x111x1): Measurement grid: dx=20mm, dy=20mm

Maximum value of SAR (interpolated) = 0.163 mW/g

Ch11/Zoom Scan (5x5x7)/Cube 0: Measurement grid: dx=8mm, dy=8mm, dz=5mm

Reference Value = 2.27 V/m; Power Drift = 0.112 dB

Peak SAR (extrapolated) = 0.207 W/kg

SAR(1 g) = 0.116 mW/g; SAR(10 g) = 0.059 mW/g

Maximum value of SAR (measured) = 0.161 mW/g

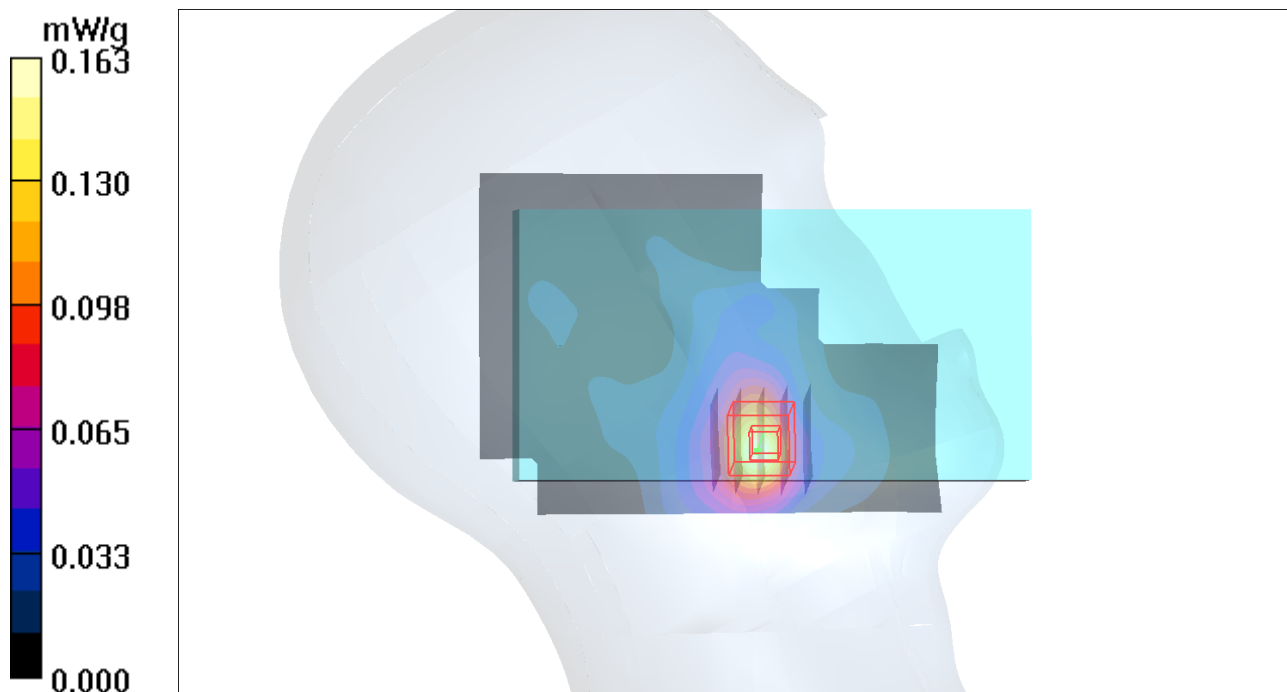

1g/10g Averaged SAR

SAR; Zoom Scan: Value Along Z, X=2, Y=2

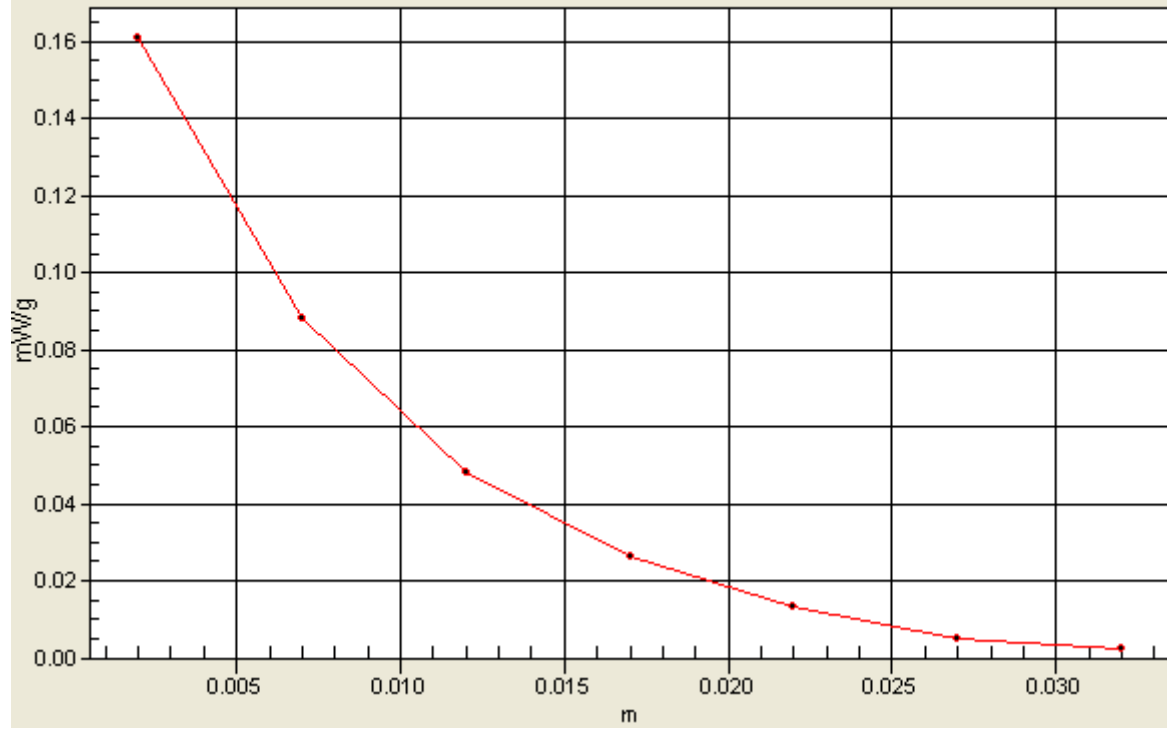

P35 802.11b_Left Tilted_Ch11_ANT 0

DUT: 120629C20

Communication System: 802.11b; Frequency: 2462 MHz; Duty Cycle: 1:1

Medium: H2450_0918 Medium parameters used: $f = 2462$ MHz; $\sigma = 1.8$ mho/m; $\epsilon_r = 40.2$; $\rho = 1000$ kg/m³

Ambient Temperature : 22.3 °C ; Liquid Temperature : 21.5 °C

DASY4 Configuration:

- Probe: EX3DV4 - SN3864; ConvF(7.28, 7.28, 7.28); Calibrated: 2012/07/19
- Sensor-Surface: 2mm (Mechanical Surface Detection)
- Electronics: DAE4 Sn1277; Calibrated: 2012/07/19
- Phantom: SAM Phantom_Left; Type: SAM V4.0; Serial: TP 1652
- Measurement SW: DASY4, V4.7 Build 80; Postprocessing SW: SEMCAD, V1.8 Build 186

Ch11/Area Scan (61x111x1): Measurement grid: dx=20mm, dy=20mm

Maximum value of SAR (interpolated) = 0.032 mW/g

Ch11/Zoom Scan (5x5x7)/Cube 0: Measurement grid: dx=8mm, dy=8mm, dz=5mm

Reference Value = 2.84 V/m; Power Drift = 0.183 dB

Peak SAR (extrapolated) = 0.043 W/kg

SAR(1 g) = 0.021 mW/g; SAR(10 g) = 0.00902 mW/g

Maximum value of SAR (measured) = 0.028 mW/g

Ch11/Zoom Scan (5x5x7)/Cube 1: Measurement grid: dx=8mm, dy=8mm, dz=5mm

Reference Value = 2.84 V/m; Power Drift = 0.183 dB

Peak SAR (extrapolated) = 0.026 W/kg

SAR(1 g) = 0.012 mW/g; SAR(10 g) = 0.00515 mW/g

Maximum value of SAR (measured) = 0.019 mW/g

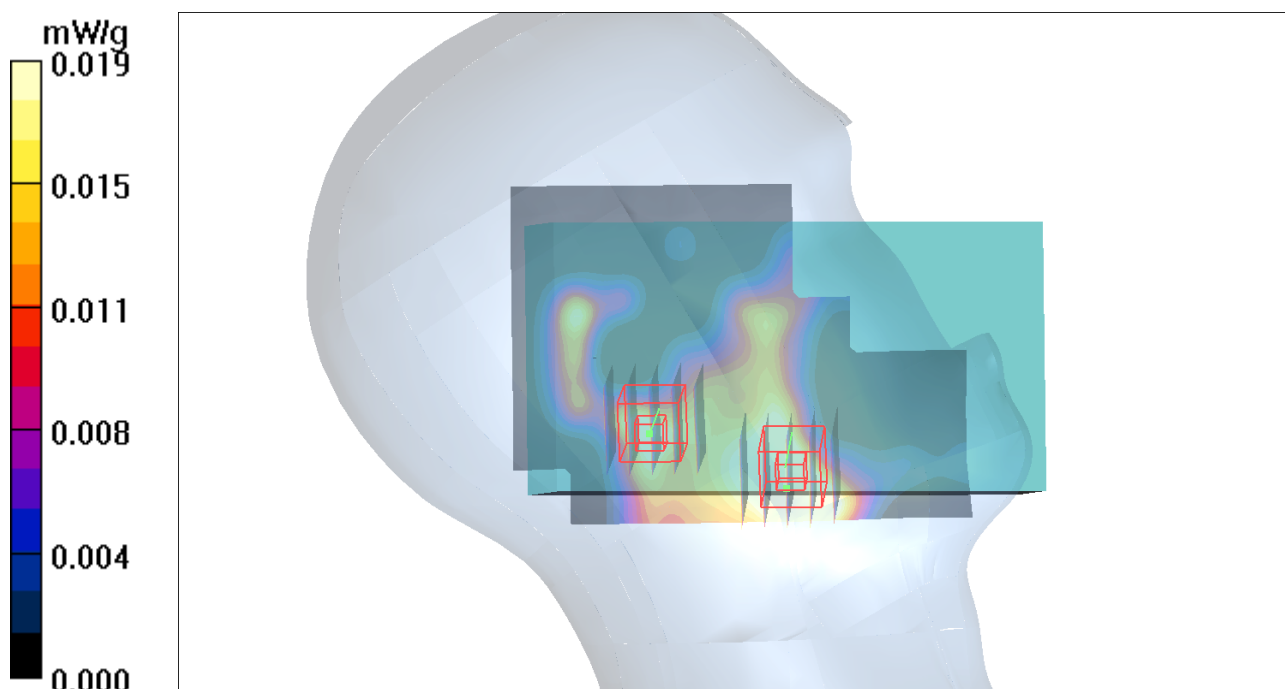

P17 GSM850_GSM_Front Face_1.5cm_Ch251

DUT: 120629C20

Communication System: GSM; Frequency: 848.8 MHz; Duty Cycle: 1:8.30042

Medium: B835_0913 Medium parameters used: $f = 849$ MHz; $\sigma = 0.993$ mho/m; $\epsilon_r = 55.705$; $\rho = 1000$ kg/m³

Ambient Temperature : 21.5 °C ; Liquid Temperature : 20.1 °C

DASY5 Configuration:

- Probe: EX3DV4 - SN3650; ConvF(9.12, 9.12, 9.12); Calibrated: 2011/10/26;
- Sensor-Surface: 2mm (Mechanical Surface Detection)
- Electronics: DAE4 Sn861; Calibrated: 2012/08/23
- Phantom: SAM Phantom_Front; Type: SAM V4.0; Serial: TP 1485
- Measurement SW: DASY52, Version 52.8 (2); SEMCAD X Version 14.6.6 (6824)

Ch251/Area Scan (71x111x1): Measurement grid: dx=20mm, dy=20mm

Maximum value of SAR (interpolated) = 0.117 W/kg

Ch251/Zoom Scan (5x5x7)/Cube 0: Measurement grid: dx=8mm, dy=8mm, dz=5mm

Reference Value = 7.555 V/m; Power Drift = -0.10 dB

Peak SAR (extrapolated) = 0.137 mW/g

SAR(1 g) = 0.100 mW/g; SAR(10 g) = 0.071 mW/g

Maximum value of SAR (measured) = 0.120 W/kg

Ch251/Zoom Scan (5x5x7)/Cube 1: Measurement grid: dx=8mm, dy=8mm, dz=5mm

Reference Value = 7.555 V/m; Power Drift = -0.10 dB

Peak SAR (extrapolated) = 0.082 mW/g

SAR(1 g) = 0.064 mW/g; SAR(10 g) = 0.049 mW/g

Maximum value of SAR (measured) = 0.0740 W/kg

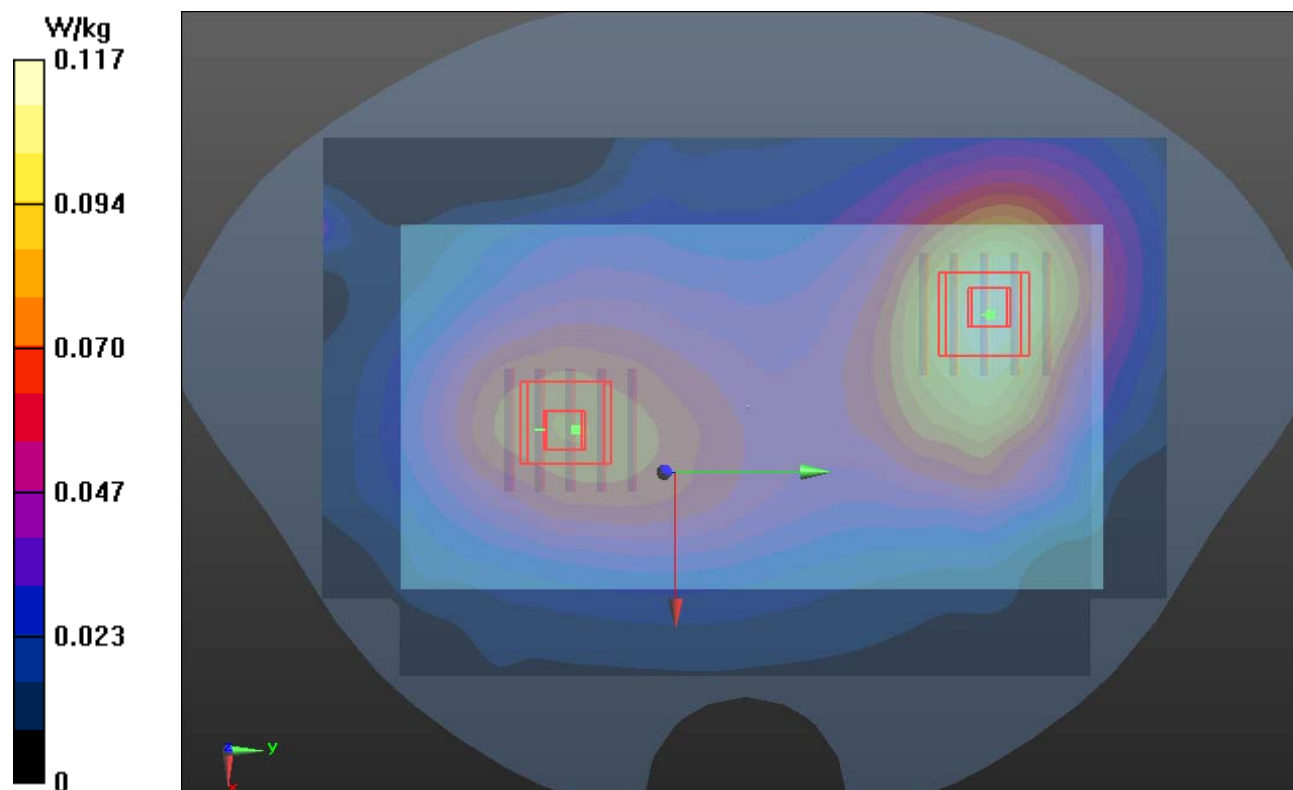

P18 GSM850_GSM_Rear Face_1.5cm_Ch251

DUT: 120629C20

Communication System: GSM; Frequency: 848.8 MHz; Duty Cycle: 1:8.30042

Medium: B835_0913 Medium parameters used: $f = 849$ MHz; $\sigma = 0.993$ mho/m; $\epsilon_r = 55.705$; $\rho = 1000$ kg/m³

Ambient Temperature : 21.5 °C ; Liquid Temperature : 20.1 °C

DASY5 Configuration:

- Probe: EX3DV4 - SN3650; ConvF(9.12, 9.12, 9.12); Calibrated: 2011/10/26;
- Sensor-Surface: 2mm (Mechanical Surface Detection)
- Electronics: DAE4 Sn861; Calibrated: 2012/08/23
- Phantom: SAM Phantom_Front; Type: SAM V4.0; Serial: TP 1485
- Measurement SW: DASY52, Version 52.8 (2); SEMCAD X Version 14.6.6 (6824)

Ch251/Area Scan (71x111x1): Measurement grid: dx=20mm, dy=20mm

Maximum value of SAR (interpolated) = 0.283 W/kg

Ch251/Zoom Scan (5x5x7)/Cube 0: Measurement grid: dx=8mm, dy=8mm, dz=5mm

Reference Value = 10.524 V/m; Power Drift = -0.04 dB

Peak SAR (extrapolated) = 0.320 mW/g

SAR(1 g) = 0.235 mW/g; SAR(10 g) = 0.167 mW/g

Maximum value of SAR (measured) = 0.283 W/kg

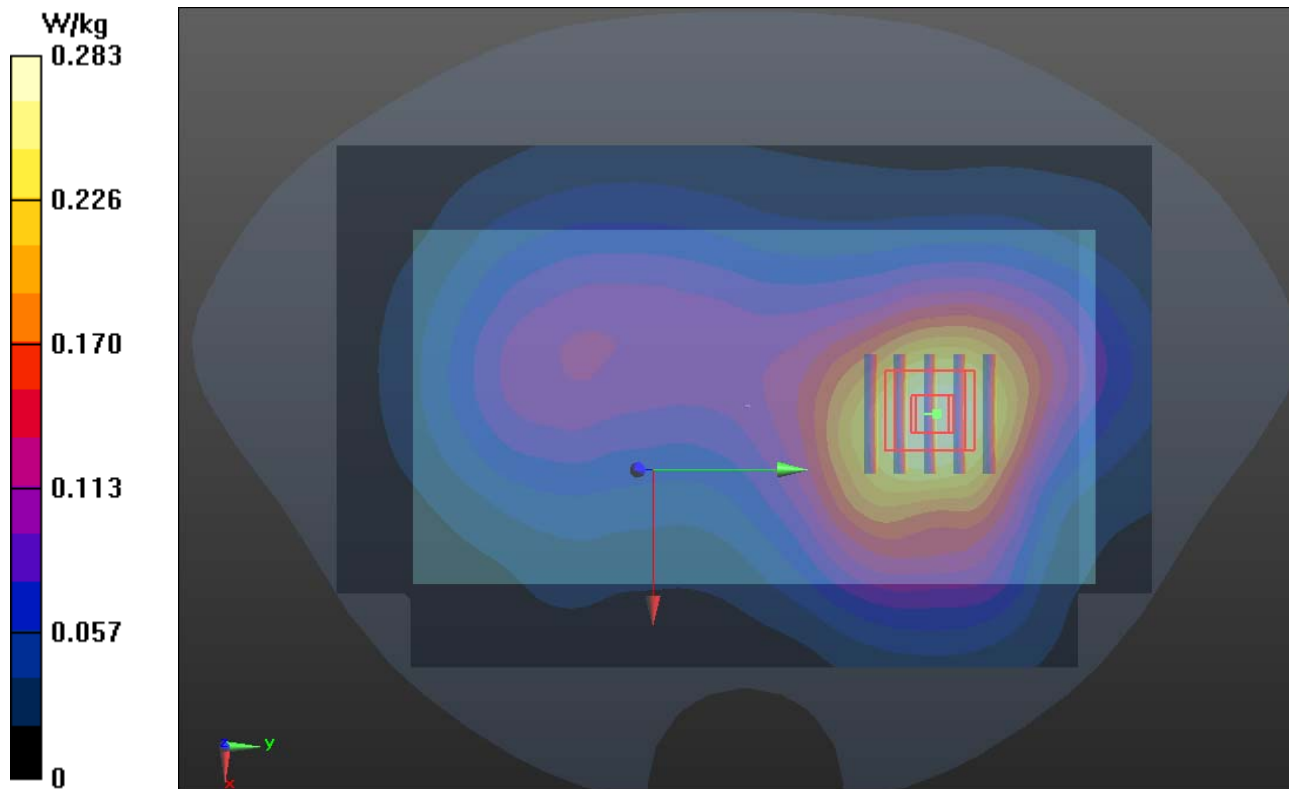

1g/10g Averaged SAR

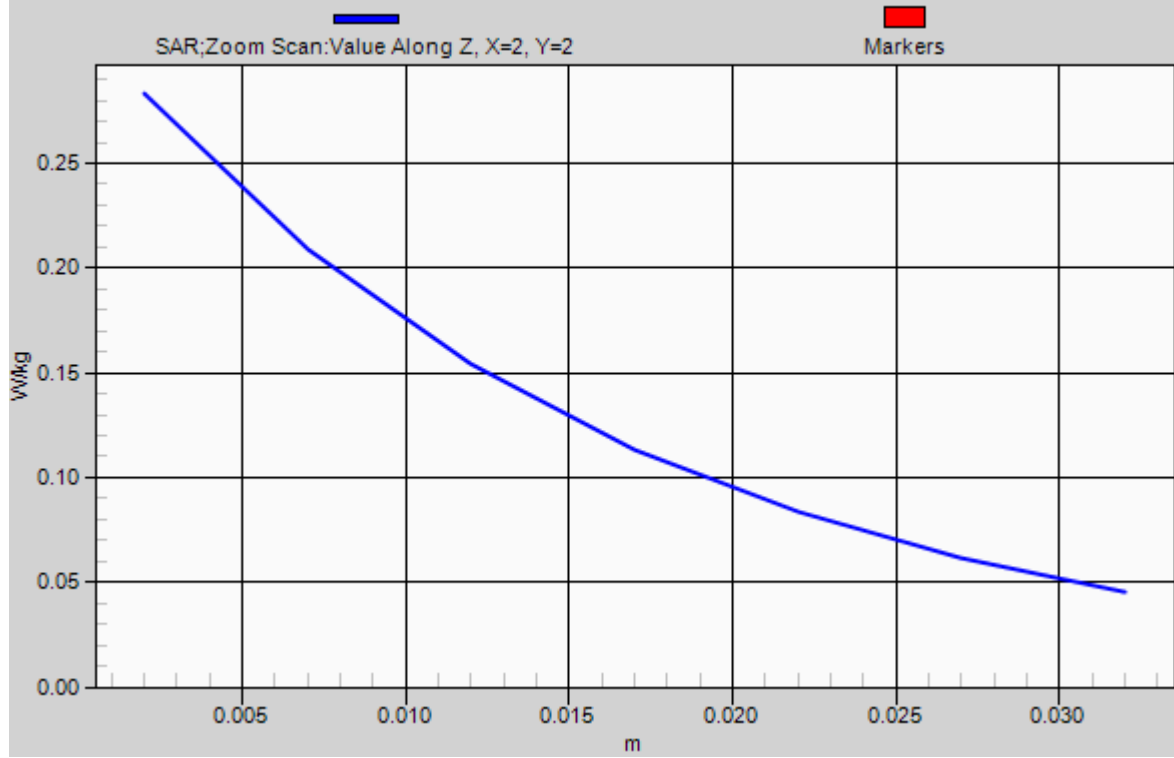

P19 GSM1900_GSM_Front Face_1.5cm_Ch810

DUT: 120629C20

Communication System: GSM; Frequency: 1909.8 MHz; Duty Cycle: 1:8.30042

Medium: B1900_0913 Medium parameters used: $f = 1910$ MHz; $\sigma = 1.555$ mho/m; $\epsilon_r = 52.797$; $\rho = 1000$ kg/m³

Ambient Temperature : 21.8 °C ; Liquid Temperature : 20.2 °C

DASY5 Configuration:

- Probe: EX3DV4 - SN3650; ConvF(7.46, 7.46, 7.46); Calibrated: 2011/10/26;
- Sensor-Surface: 2mm (Mechanical Surface Detection)
- Electronics: DAE4 Sn861; Calibrated: 2012/08/23
- Phantom: SAM Phantom_Left; Type: SAM V4.0; Serial: TP 1202
- Measurement SW: DASY52, Version 52.8 (2); SEMCAD X Version 14.6.6 (6824)

Ch810/Area Scan (71x111x1): Measurement grid: dx=20mm, dy=20mm

Maximum value of SAR (interpolated) = 0.0645 W/kg

Ch810/Zoom Scan (5x5x7)/Cube 0: Measurement grid: dx=8mm, dy=8mm, dz=5mm

Reference Value = 5.596 V/m; Power Drift = 0.11 dB

Peak SAR (extrapolated) = 0.079 mW/g

SAR(1 g) = 0.052 mW/g; SAR(10 g) = 0.035 mW/g

Maximum value of SAR (measured) = 0.0657 W/kg

Ch810/Zoom Scan (5x5x7)/Cube 1: Measurement grid: dx=8mm, dy=8mm, dz=5mm

Reference Value = 5.596 V/m; Power Drift = 0.11 dB

Peak SAR (extrapolated) = 0.075 mW/g

SAR(1 g) = 0.050 mW/g; SAR(10 g) = 0.033 mW/g

Maximum value of SAR (measured) = 0.0628 W/kg

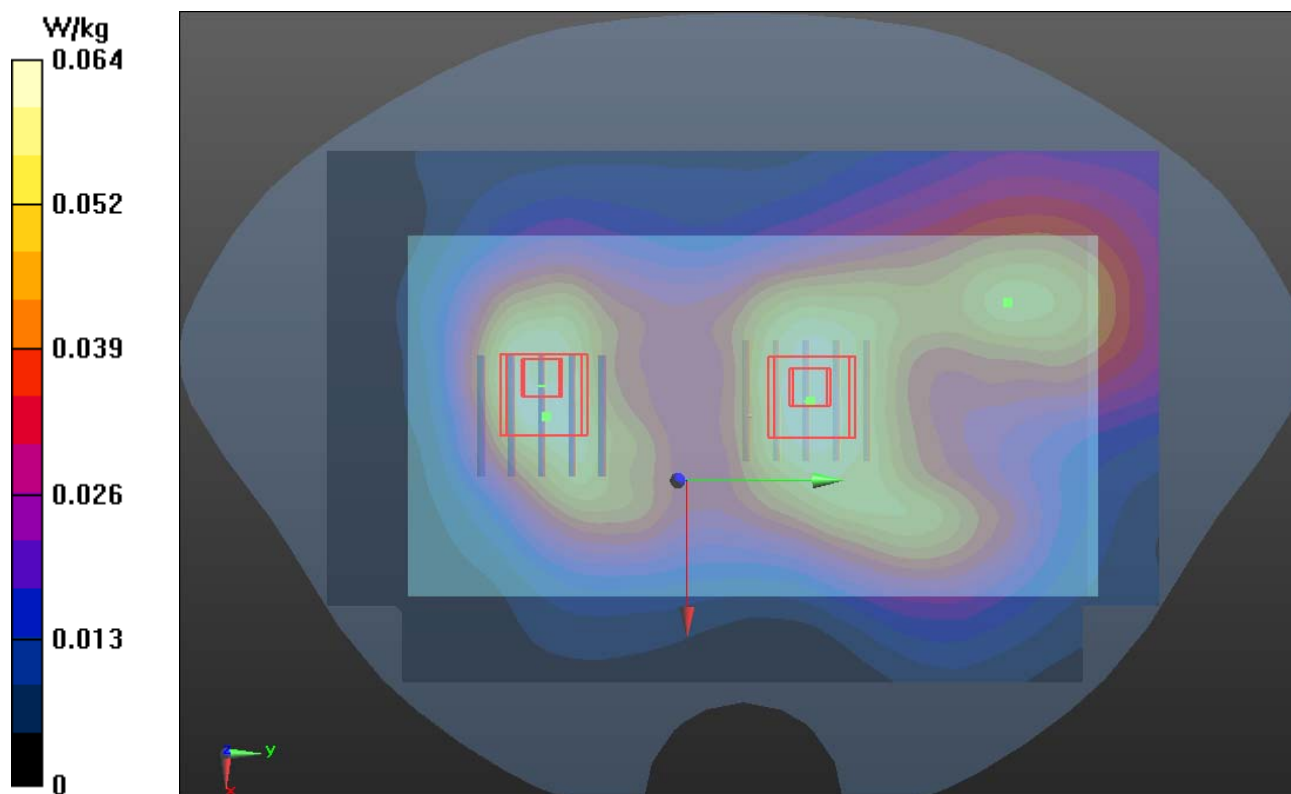

P20 GSM1900_GSM_Rear Face_1.5cm_Ch810

DUT: 120629C20

Communication System: GSM; Frequency: 1909.8 MHz; Duty Cycle: 1:8.30042

Medium: B1900_0913 Medium parameters used: $f = 1910$ MHz; $\sigma = 1.555$ mho/m; $\epsilon_r = 52.797$; $\rho = 1000$ kg/m³

Ambient Temperature : 21.8 °C ; Liquid Temperature : 20.2 °C

DASY5 Configuration:

- Probe: EX3DV4 - SN3650; ConvF(7.46, 7.46, 7.46); Calibrated: 2011/10/26;
- Sensor-Surface: 2mm (Mechanical Surface Detection)
- Electronics: DAE4 Sn861; Calibrated: 2012/08/23
- Phantom: SAM Phantom_Left; Type: SAM V4.0; Serial: TP 1202
- Measurement SW: DASY52, Version 52.8 (2); SEMCAD X Version 14.6.6 (6824)

Ch810/Area Scan (71x111x1): Measurement grid: dx=20mm, dy=20mm

Maximum value of SAR (interpolated) = 0.329 W/kg

Ch810/Zoom Scan (5x5x7)/Cube 0: Measurement grid: dx=8mm, dy=8mm, dz=5mm

Reference Value = 4.824 V/m; Power Drift = -0.02 dB

Peak SAR (extrapolated) = 0.412 mW/g

SAR(1 g) = 0.263 mW/g; SAR(10 g) = 0.158 mW/g

Maximum value of SAR (measured) = 0.340 W/kg

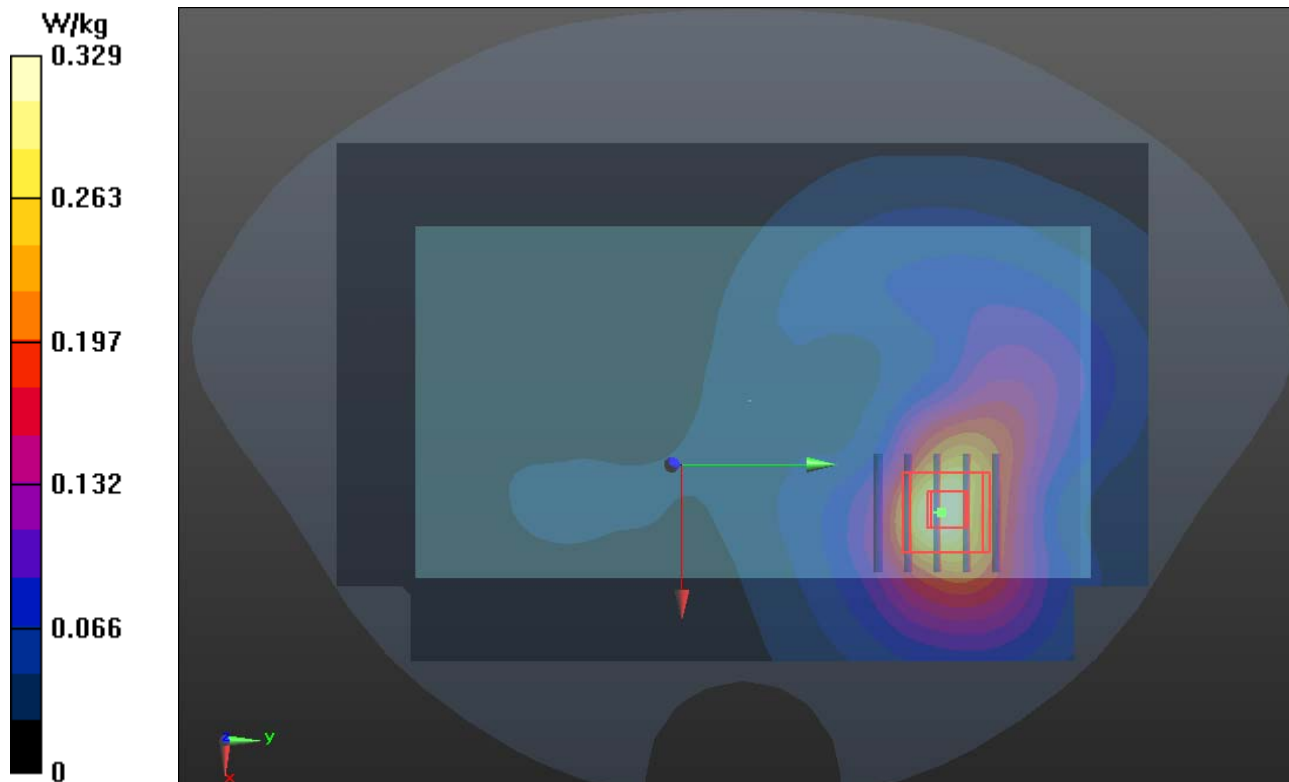

1g/10g Averaged SAR

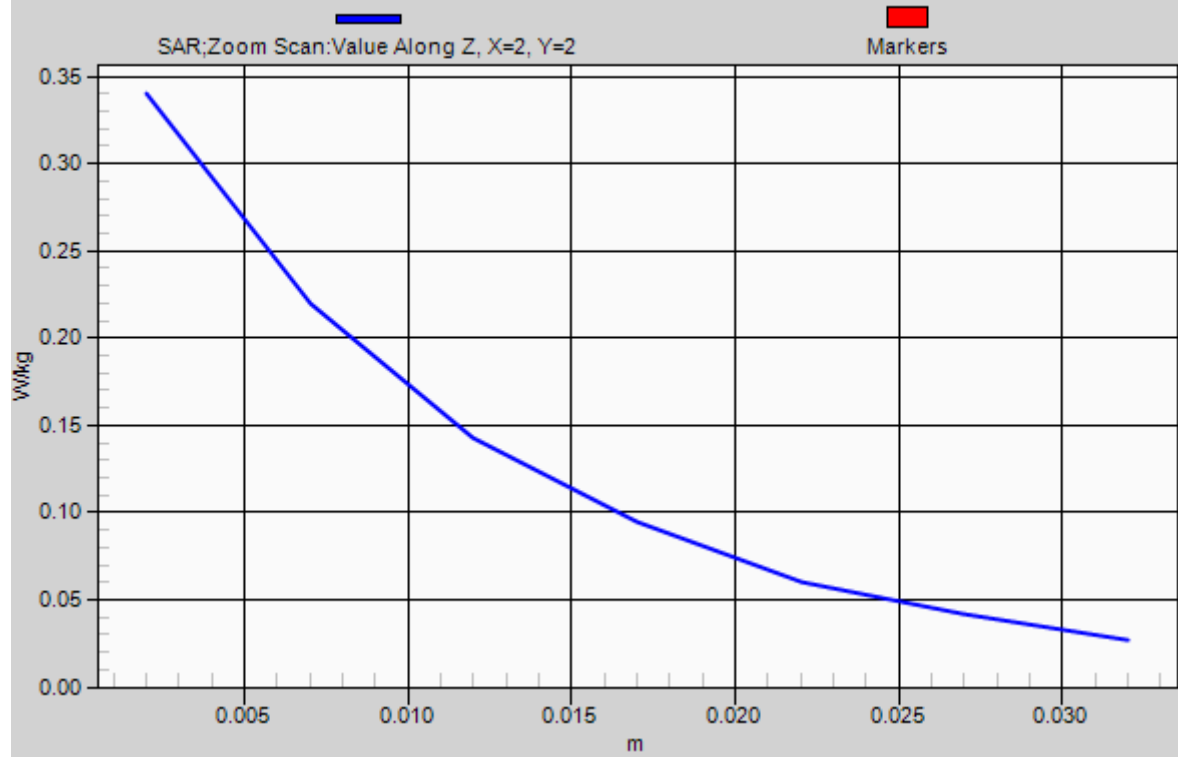

P21 WCDMA V_RMC12.2K_Front Face_1.5cm_Ch4182

DUT: 120629C20

Communication System: WCDMA; Frequency: 836.4 MHz; Duty Cycle: 1:1

Medium: B835_0913 Medium parameters used: $f = 836.4$ MHz; $\sigma = 0.981$ mho/m; $\epsilon_r = 55.83$; $\rho = 1000$ kg/m³

Ambient Temperature : 21.5 °C ; Liquid Temperature : 20.1 °C

DASY5 Configuration:

- Probe: EX3DV4 - SN3650; ConvF(9.12, 9.12, 9.12); Calibrated: 2011/10/26;
- Sensor-Surface: 2mm (Mechanical Surface Detection)
- Electronics: DAE4 Sn861; Calibrated: 2012/08/23
- Phantom: SAM Phantom_Front; Type: SAM V4.0; Serial: TP 1485
- Measurement SW: DASY52, Version 52.8 (2); SEMCAD X Version 14.6.6 (6824)

Ch4182/Area Scan (71x111x1): Measurement grid: dx=20mm, dy=20mm

Maximum value of SAR (interpolated) = 0.103 W/kg

Ch4182/Zoom Scan (5x5x7)/Cube 0: Measurement grid: dx=8mm, dy=8mm, dz=5mm

Reference Value = 7.293 V/m; Power Drift = -0.04 dB

Peak SAR (extrapolated) = 0.114 mW/g

SAR(1 g) = 0.083 mW/g; SAR(10 g) = 0.059 mW/g

Maximum value of SAR (measured) = 0.100 W/kg

Ch4182/Zoom Scan (5x5x7)/Cube 1: Measurement grid: dx=8mm, dy=8mm, dz=5mm

Reference Value = 7.293 V/m; Power Drift = -0.04 dB

Peak SAR (extrapolated) = 0.088 mW/g

SAR(1 g) = 0.068 mW/g; SAR(10 g) = 0.052 mW/g

Maximum value of SAR (measured) = 0.0789 W/kg

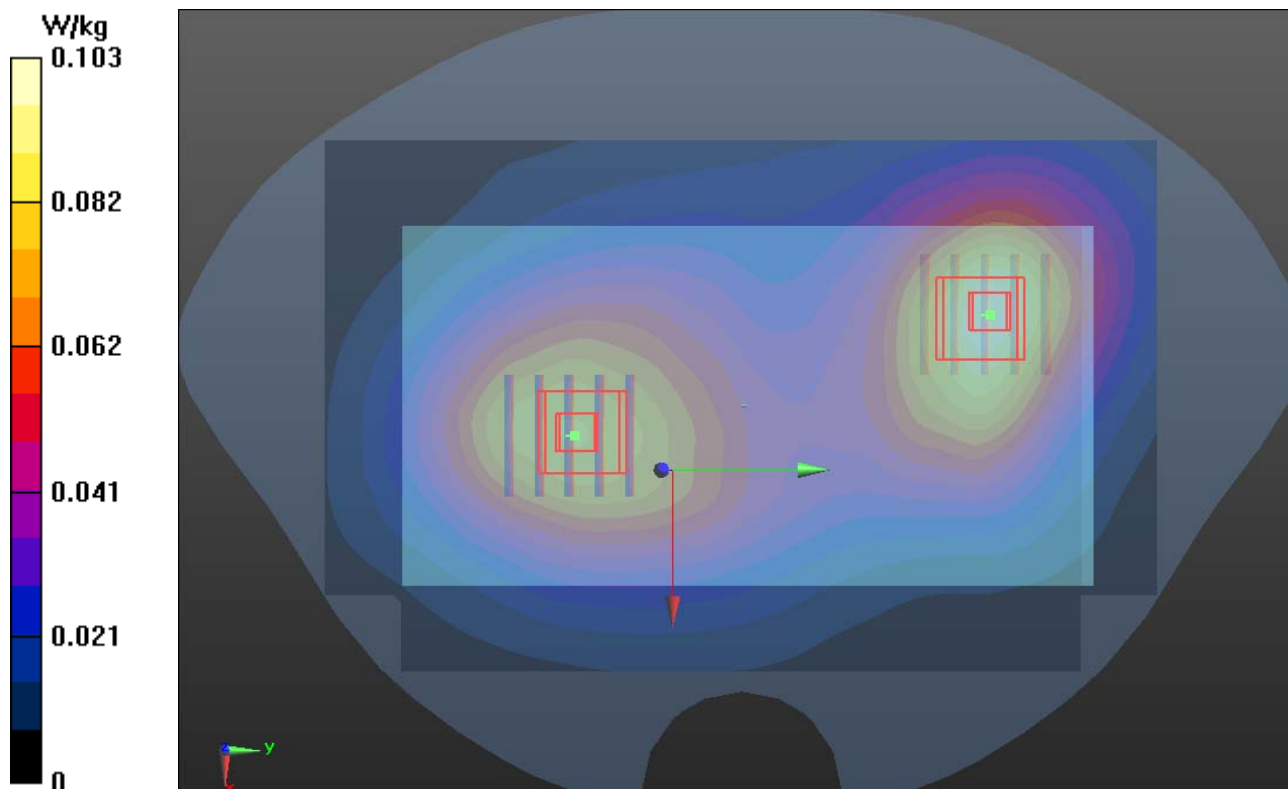

P22 WCDMA V_RMC12.2K_Rear Face_1.5cm_Ch4182

DUT: 120629C20

Communication System: WCDMA; Frequency: 836.4 MHz; Duty Cycle: 1:1

Medium: B835_0913 Medium parameters used: $f = 836.4$ MHz; $\sigma = 0.981$ mho/m; $\epsilon_r = 55.83$; $\rho = 1000$ kg/m³

Ambient Temperature : 21.5 °C ; Liquid Temperature : 20.1 °C

DASY5 Configuration:

- Probe: EX3DV4 - SN3650; ConvF(9.12, 9.12, 9.12); Calibrated: 2011/10/26;
- Sensor-Surface: 2mm (Mechanical Surface Detection)
- Electronics: DAE4 Sn861; Calibrated: 2012/08/23
- Phantom: SAM Phantom_Front; Type: SAM V4.0; Serial: TP 1485
- Measurement SW: DASY52, Version 52.8 (2); SEMCAD X Version 14.6.6 (6824)

Ch4182/Area Scan (71x111x1): Measurement grid: dx=20mm, dy=20mm

Maximum value of SAR (interpolated) = 0.280 W/kg

Ch4182/Zoom Scan (5x5x7)/Cube 0: Measurement grid: dx=8mm, dy=8mm, dz=5mm

Reference Value = 11.308 V/m; Power Drift = -0.06 dB

Peak SAR (extrapolated) = 0.324 mW/g

SAR(1 g) = 0.238 mW/g; SAR(10 g) = 0.169 mW/g

Maximum value of SAR (measured) = 0.285 W/kg

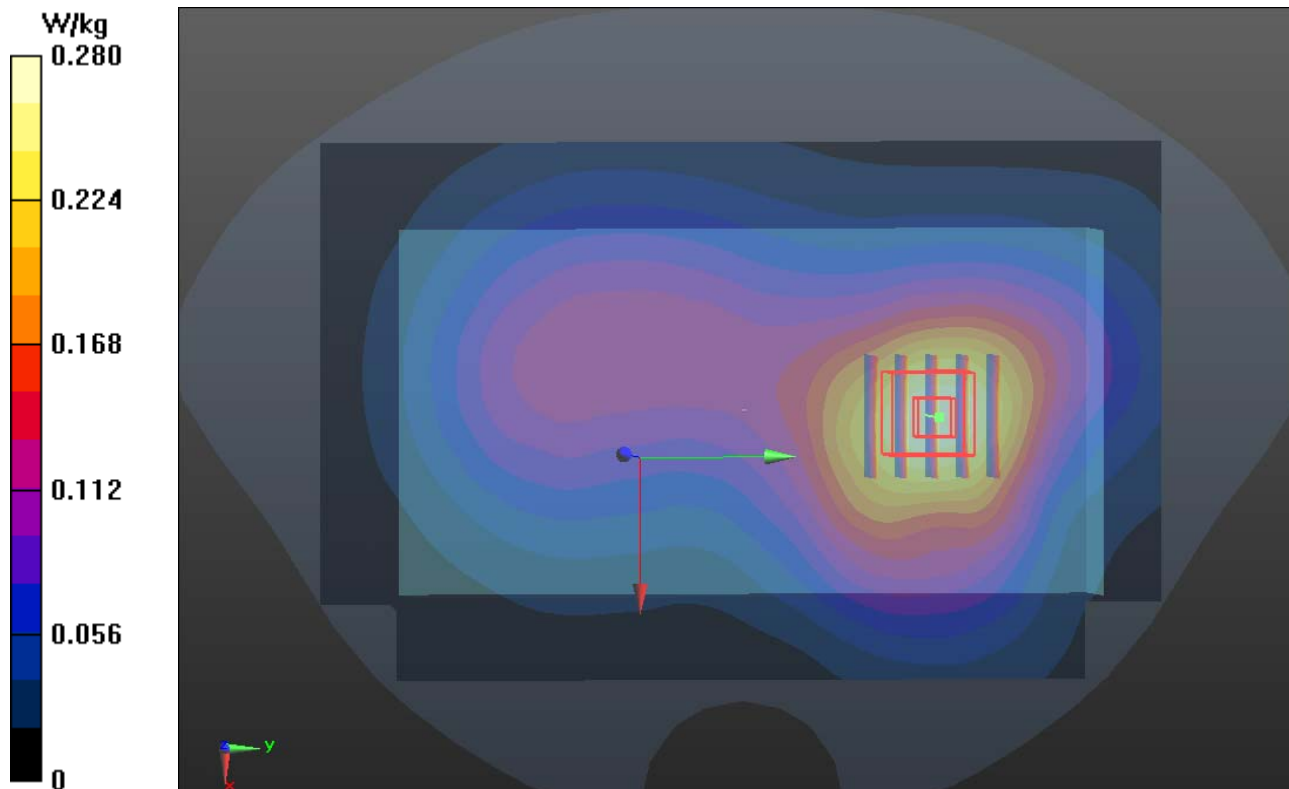

1g/10g Averaged SAR

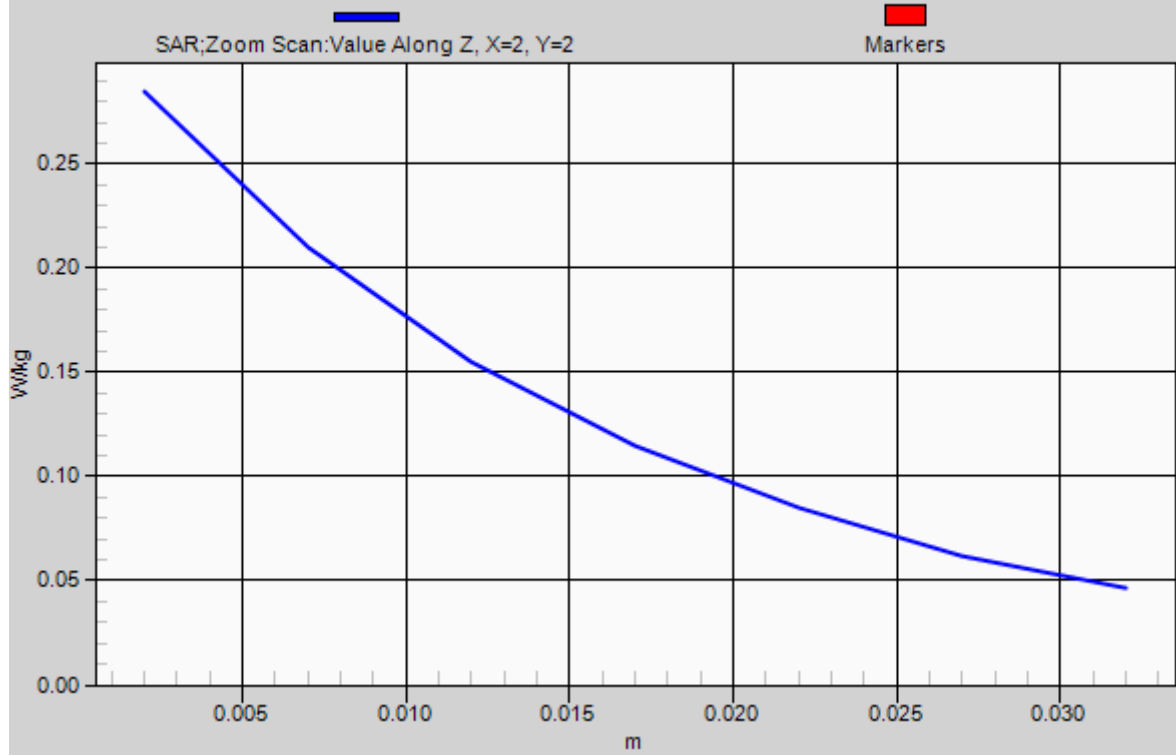

P23 WCDMA II_RMC12.2K_Front Face_1.5cm_Ch9400

DUT: 120629C20

Communication System: WCDMA; Frequency: 1880 MHz; Duty Cycle: 1:1

Medium: B1900_0913 Medium parameters used: $f = 1880$ MHz; $\sigma = 1.521$ mho/m; $\epsilon_r = 52.861$; $\rho = 1000$ kg/m³

Ambient Temperature : 21.8 °C ; Liquid Temperature : 20.2 °C

DASY5 Configuration:

- Probe: EX3DV4 - SN3650; ConvF(7.46, 7.46, 7.46); Calibrated: 2011/10/26;
- Sensor-Surface: 2mm (Mechanical Surface Detection)
- Electronics: DAE4 Sn861; Calibrated: 2012/08/23
- Phantom: SAM Phantom_Left; Type: SAM V4.0; Serial: TP 1202
- Measurement SW: DASY52, Version 52.8 (2); SEMCAD X Version 14.6.6 (6824)

Ch9400/Area Scan (71x111x1): Measurement grid: dx=20mm, dy=20mm

Maximum value of SAR (interpolated) = 0.0992 W/kg

Ch9400/Zoom Scan (5x5x7)/Cube 0: Measurement grid: dx=8mm, dy=8mm, dz=5mm

Reference Value = 7.238 V/m; Power Drift = -0.08 dB

Peak SAR (extrapolated) = 0.112 mW/g

SAR(1 g) = 0.077 mW/g; SAR(10 g) = 0.052 mW/g

Maximum value of SAR (measured) = 0.0951 W/kg

Ch9400/Zoom Scan (5x5x7)/Cube 1: Measurement grid: dx=8mm, dy=8mm, dz=5mm

Reference Value = 7.238 V/m; Power Drift = -0.08 dB

Peak SAR (extrapolated) = 0.098 mW/g

SAR(1 g) = 0.068 mW/g; SAR(10 g) = 0.046 mW/g

Maximum value of SAR (measured) = 0.0830 W/kg

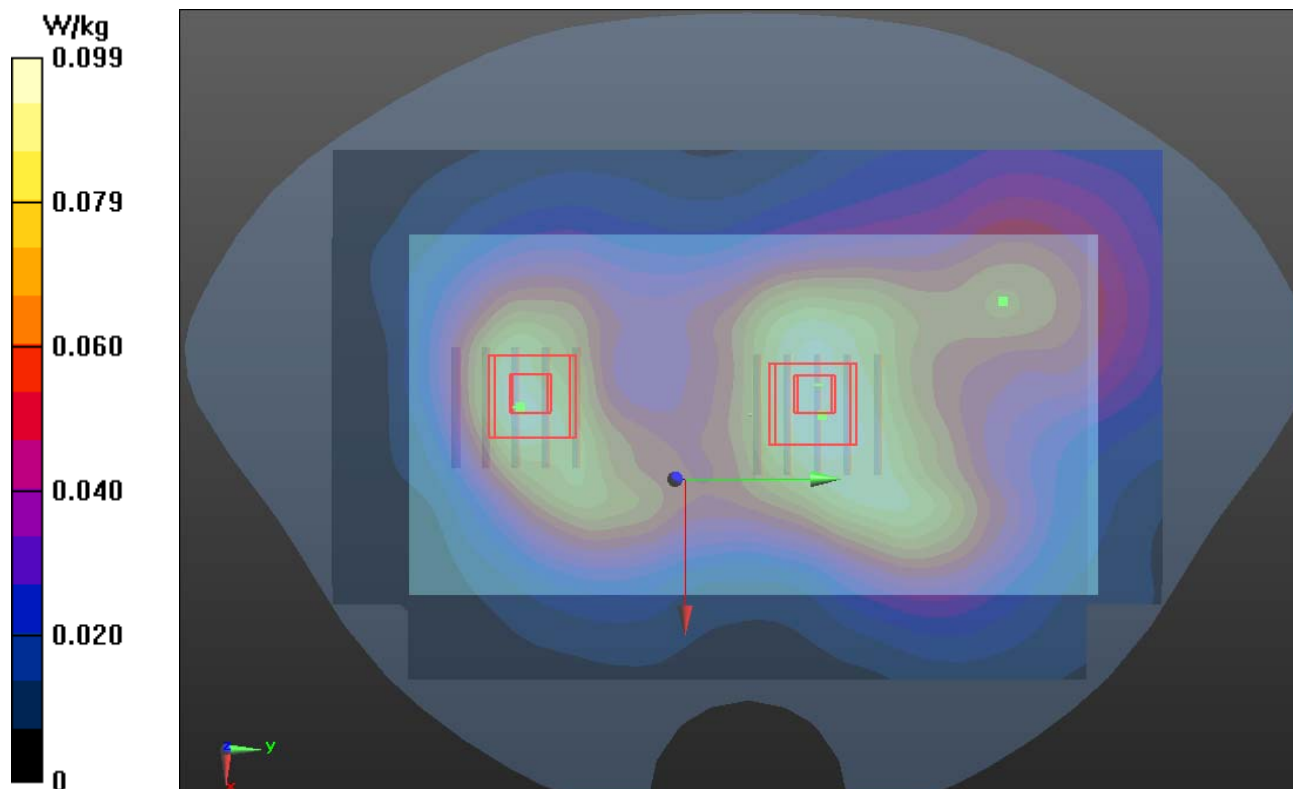

P24 WCDMA II_RMC12.2K_Rear Face_1.5cm_Ch9400

DUT: 120629C20

Communication System: WCDMA; Frequency: 1880 MHz; Duty Cycle: 1:1

Medium: B1900_0913 Medium parameters used: $f = 1880$ MHz; $\sigma = 1.521$ mho/m; $\epsilon_r = 52.861$; $\rho = 1000$ kg/m³

Ambient Temperature : 21.8 °C ; Liquid Temperature : 20.2 °C

DASY5 Configuration:

- Probe: EX3DV4 - SN3650; ConvF(7.46, 7.46, 7.46); Calibrated: 2011/10/26;
- Sensor-Surface: 2mm (Mechanical Surface Detection)
- Electronics: DAE4 Sn861; Calibrated: 2012/08/23
- Phantom: SAM Phantom_Left; Type: SAM V4.0; Serial: TP 1202
- Measurement SW: DASY52, Version 52.8 (2); SEMCAD X Version 14.6.6 (6824)

Ch9400/Area Scan (71x111x1): Measurement grid: dx=20mm, dy=20mm

Maximum value of SAR (interpolated) = 0.475 W/kg

Ch9400/Zoom Scan (5x5x7)/Cube 0: Measurement grid: dx=8mm, dy=8mm, dz=5mm

Reference Value = 6.751 V/m; Power Drift = 0.03 dB

Peak SAR (extrapolated) = 0.571 mW/g

SAR(1 g) = 0.366 mW/g; SAR(10 g) = 0.220 mW/g

Maximum value of SAR (measured) = 0.476 W/kg

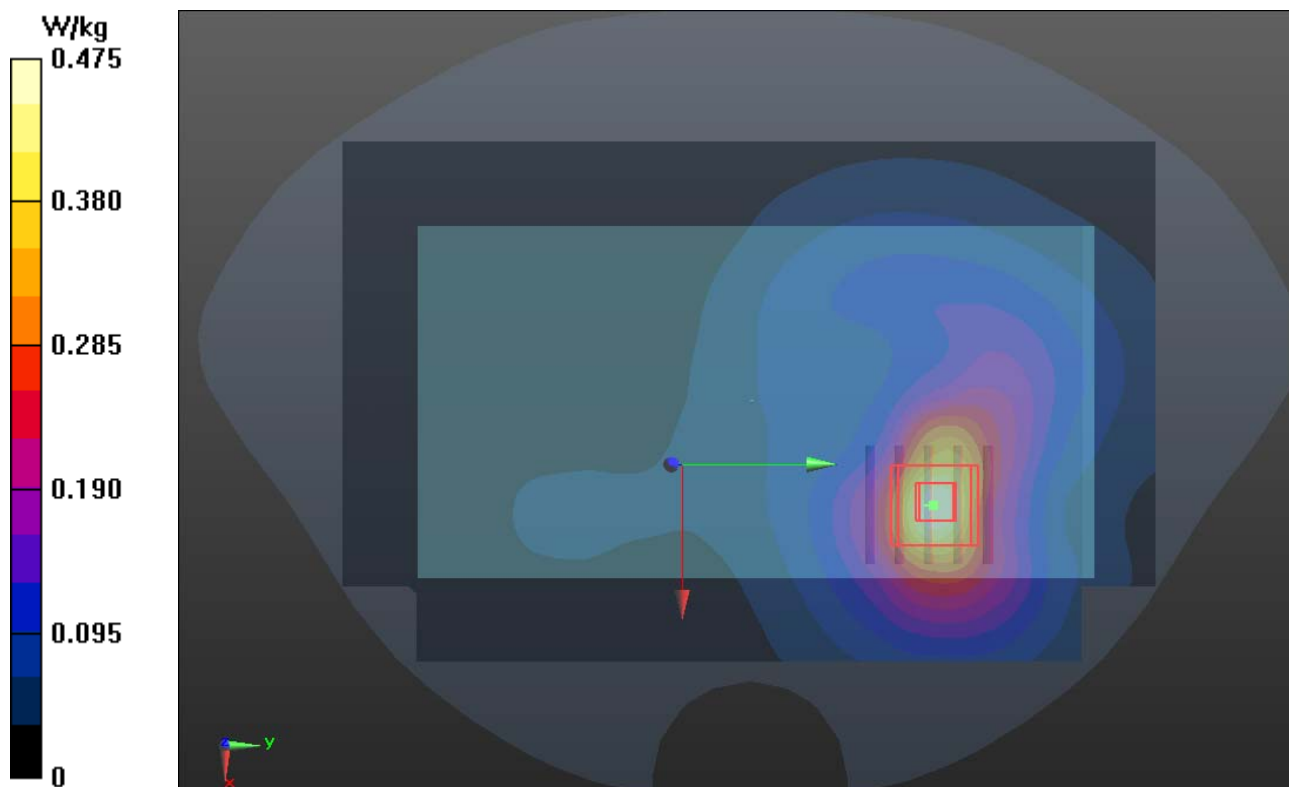

1g/10g Averaged SAR

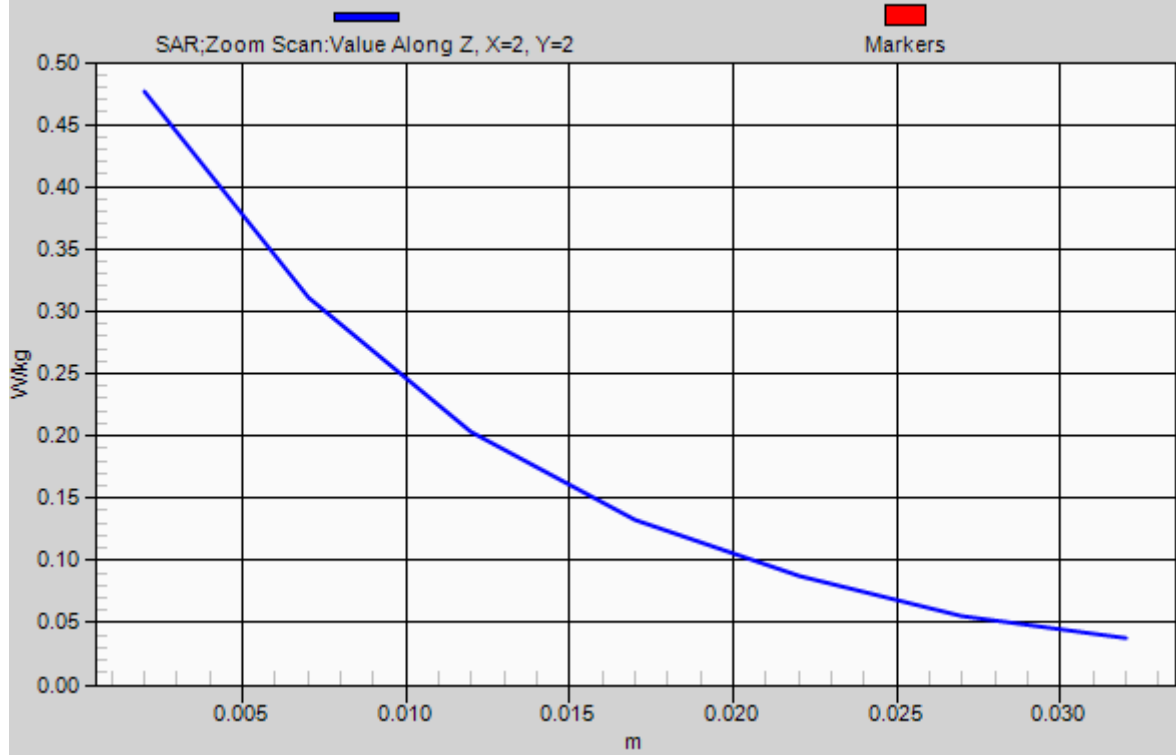

P30 802.11b_Front Face_1.5 cm_Ch11_ANT 0

DUT: 120629C20

Communication System: 802.11b; Frequency: 2462 MHz; Duty Cycle: 1:1

Medium: B2450_0917 Medium parameters used: $f = 2462$ MHz; $\sigma = 2.04$ mho/m; $\epsilon_r = 52.8$; $\rho = 1000$ kg/m³

Ambient Temperature : 22.4 °C ; Liquid Temperature : 21.7 °C

DASY4 Configuration:

- Probe: EX3DV4 - SN3864; ConvF(7.49, 7.49, 7.49); Calibrated: 2012/07/19
- Sensor-Surface: 2mm (Mechanical Surface Detection)
- Electronics: DAE4 Sn1277; Calibrated: 2012/07/19
- Phantom: SAM Phantom_Left; Type: SAM V4.0; Serial: TP 1652
- Measurement SW: DASY4, V4.7 Build 80; Postprocessing SW: SEMCAD, V1.8 Build 186

Ch11/Area Scan (71x111x1): Measurement grid: dx=20mm, dy=20mm

Maximum value of SAR (interpolated) = 0.060 mW/g

Ch11/Zoom Scan (5x5x7)/Cube 0: Measurement grid: dx=8mm, dy=8mm, dz=5mm

Reference Value = 2.64 V/m; Power Drift = 0.087 dB

Peak SAR (extrapolated) = 0.039 W/kg

SAR(1 g) = 0.021 mW/g; SAR(10 g) = 0.00892 mW/g

Maximum value of SAR (measured) = 0.031 mW/g

Ch11/Zoom Scan (5x5x7)/Cube 1: Measurement grid: dx=8mm, dy=8mm, dz=5mm

Reference Value = 2.64 V/m; Power Drift = 0.087 dB

Peak SAR (extrapolated) = 0.030 W/kg

SAR(1 g) = 0.016 mW/g; SAR(10 g) = 0.00725 mW/g

Maximum value of SAR (measured) = 0.023 mW/g

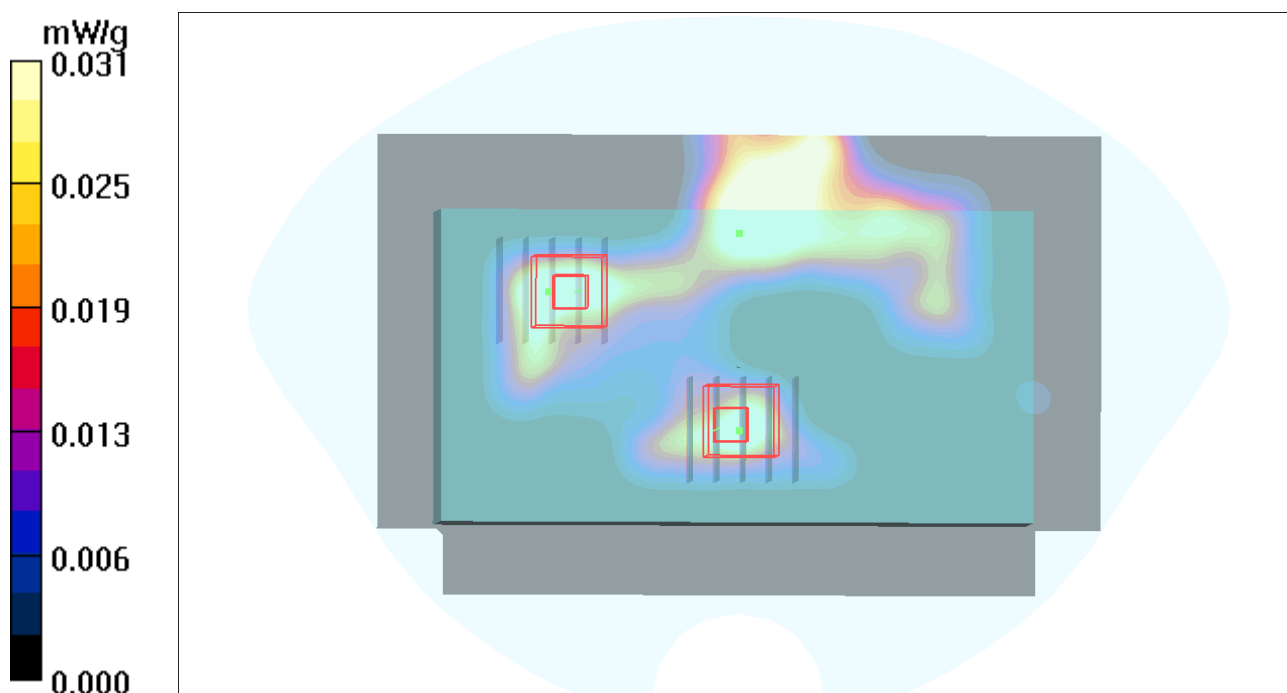

P31 802.11b_Rear Face_1.5 cm_Ch11_ANT 0

DUT: 120629C20

Communication System: 802.11b; Frequency: 2462 MHz; Duty Cycle: 1:1

Medium: B2450_0917 Medium parameters used: $f = 2462$ MHz; $\sigma = 2.04$ mho/m; $\epsilon_r = 52.8$; $\rho = 1000$ kg/m³

Ambient Temperature : 22.4 °C ; Liquid Temperature : 21.7 °C

DASY4 Configuration:

- Probe: EX3DV4 - SN3864; ConvF(7.49, 7.49, 7.49); Calibrated: 2012/07/19
- Sensor-Surface: 2mm (Mechanical Surface Detection)
- Electronics: DAE4 Sn1277; Calibrated: 2012/07/19
- Phantom: SAM Phantom_Left; Type: SAM V4.0; Serial: TP 1652
- Measurement SW: DASY4, V4.7 Build 80; Postprocessing SW: SEMCAD, V1.8 Build 186

Ch11/Area Scan (71x111x1): Measurement grid: dx=20mm, dy=20mm

Maximum value of SAR (interpolated) = 0.062 mW/g

Ch11/Zoom Scan (5x5x7)/Cube 0: Measurement grid: dx=8mm, dy=8mm, dz=5mm

Reference Value = 2.02 V/m; Power Drift = 0.15 dB

Peak SAR (extrapolated) = 0.054 W/kg

SAR(1 g) = 0.029 mW/g; SAR(10 g) = 0.014 mW/g

Maximum value of SAR (measured) = 0.044 mW/g

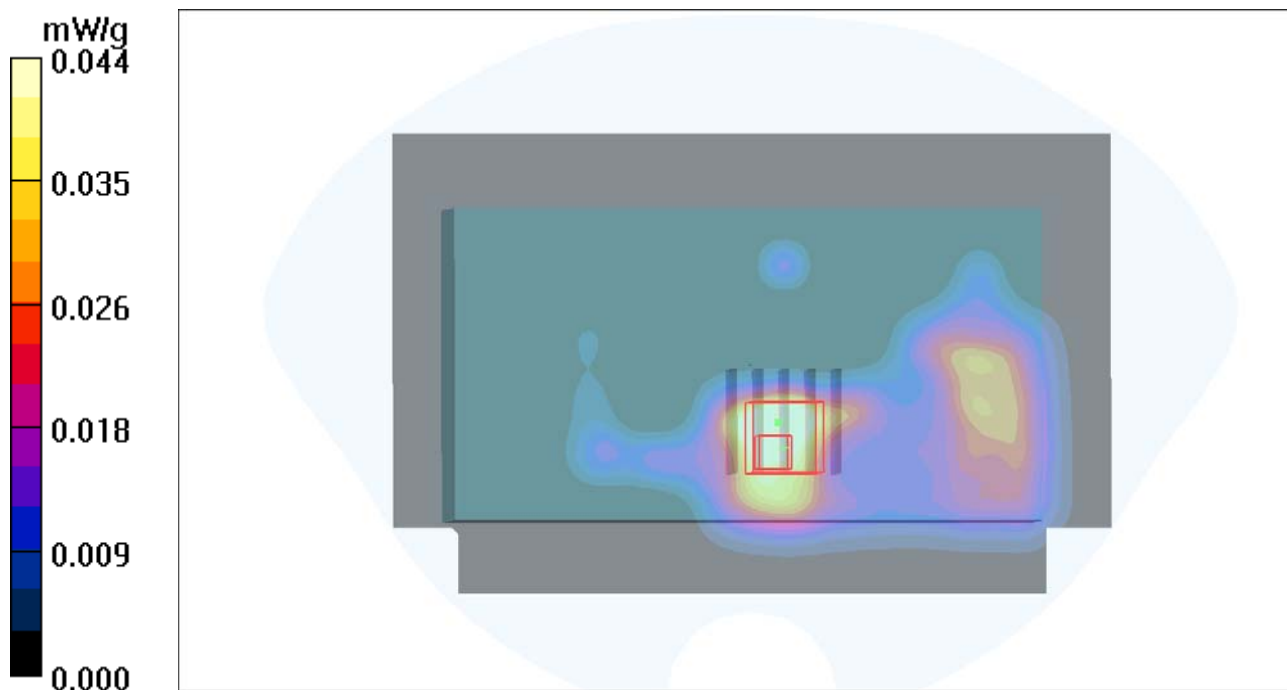

1g/10g Averaged SAR

SAR; Zoom Scan: Value Along Z, X=1, Y=2

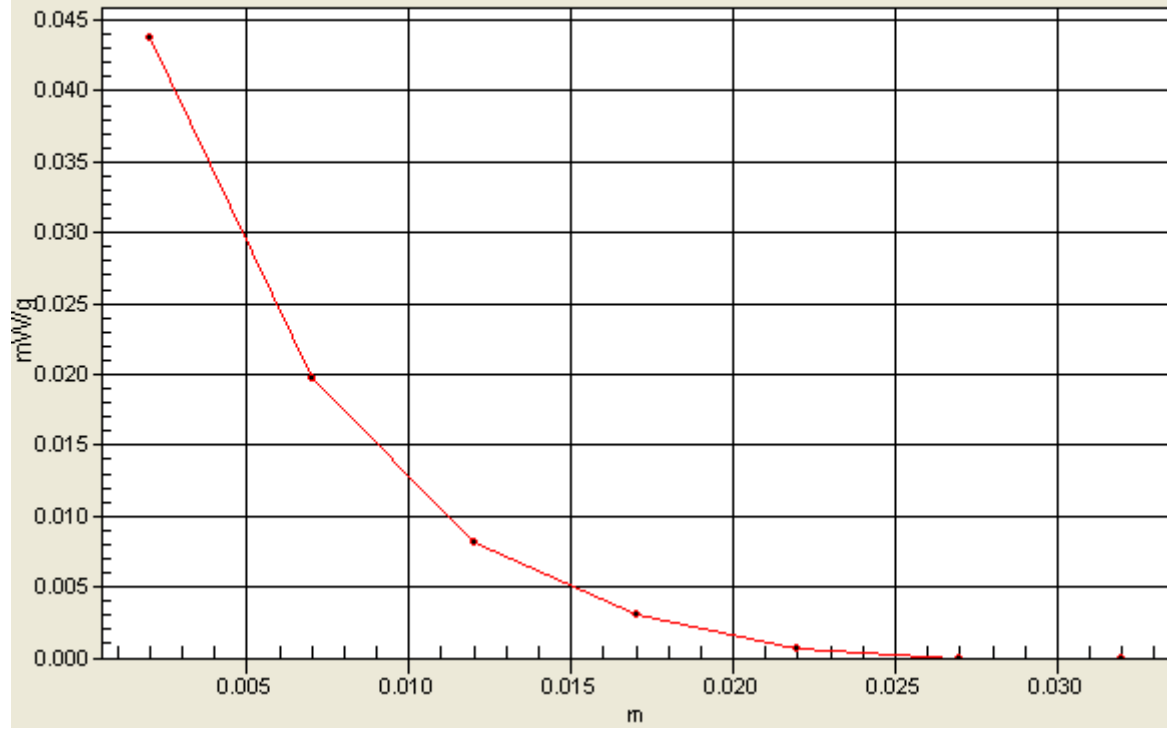



Appendix C. Calibration Certificate for Probe and Dipole

The SPEAG calibration certificates are shown as follows.



Accredited by the Swiss Accreditation Service (SAS)
The Swiss Accreditation Service is one of the signatories to the EA
Multilateral Agreement for the recognition of calibration certificates

Accreditation No.: **SCS 108**

Client **B.V. ADT (Auden)**

Certificate No: **D835V2-4d021_Apr12**

CALIBRATION CERTIFICATE

Object **D835V2 - SN: 4d021**

Calibration procedure(s) **QA CAL-05.v8
Calibration procedure for dipole validation kits above 700 MHz**

Calibration date: **April 20, 2012**

This calibration certificate documents the traceability to national standards, which realize the physical units of measurements (SI).
The measurements and the uncertainties with confidence probability are given on the following pages and are part of the certificate.

All calibrations have been conducted in the closed laboratory facility: environment temperature (22 ± 3)°C and humidity < 70%.

Calibration Equipment used (M&TE critical for calibration)

Primary Standards	ID #	Cal Date (Certificate No.)	Scheduled Calibration
Power meter EPM-442A	GB37480704	05-Oct-11 (No. 217-01451)	Oct-12
Power sensor HP 8481A	US37292783	05-Oct-11 (No. 217-01451)	Oct-12
Reference 20 dB Attenuator	SN: 5058 (20k)	27-Mar-12 (No. 217-01530)	Apr-13
Type-N mismatch combination	SN: 5047.2 / 06327	27-Mar-12 (No. 217-01533)	Apr-13
Reference Probe ES3DV3	SN: 3205	30-Dec-11 (No. ES3-3205_Dec11)	Dec-12
DAE4	SN: 601	04-Jul-11 (No. DAE4-601_Jul11)	Jul-12
Secondary Standards	ID #	Check Date (in house)	Scheduled Check
Power sensor HP 8481A	MY41092317	18-Oct-02 (in house check Oct-11)	In house check: Oct-13
RF generator R&S SMT-06	100005	04-Aug-99 (in house check Oct-11)	In house check: Oct-13
Network Analyzer HP 8753E	US37390585 S4206	18-Oct-01 (in house check Oct-11)	In house check: Oct-12

	Name	Function	Signature
Calibrated by:	Israe El-Naouq	Laboratory Technician	
Approved by:	Katja Pokovic	Technical Manager	

Issued: April 20, 2012

This calibration certificate shall not be reproduced except in full without written approval of the laboratory.



Accredited by the Swiss Accreditation Service (SAS)

Accreditation No.: **SCS 108**

The Swiss Accreditation Service is one of the signatories to the EA
Multilateral Agreement for the recognition of calibration certificates

Glossary:

TSL	tissue simulating liquid
ConvF	sensitivity in TSL / NORM x,y,z
N/A	not applicable or not measured

Calibration is Performed According to the Following Standards:

- IEEE Std 1528-2003, "IEEE Recommended Practice for Determining the Peak Spatial-Averaged Specific Absorption Rate (SAR) in the Human Head from Wireless Communications Devices: Measurement Techniques", December 2003
- IEC 62209-1, "Procedure to measure the Specific Absorption Rate (SAR) for hand-held devices used in close proximity to the ear (frequency range of 300 MHz to 3 GHz)", February 2005
- Federal Communications Commission Office of Engineering & Technology (FCC OET), "Evaluating Compliance with FCC Guidelines for Human Exposure to Radiofrequency Electromagnetic Fields; Additional Information for Evaluating Compliance of Mobile and Portable Devices with FCC Limits for Human Exposure to Radiofrequency Emissions", Supplement C (Edition 01-01) to Bulletin 65

Additional Documentation:

- DASY4/5 System Handbook

Methods Applied and Interpretation of Parameters:

- Measurement Conditions:** Further details are available from the Validation Report at the end of the certificate. All figures stated in the certificate are valid at the frequency indicated.
- Antenna Parameters with TSL:** The dipole is mounted with the spacer to position its feed point exactly below the center marking of the flat phantom section, with the arms oriented parallel to the body axis.
- Feed Point Impedance and Return Loss:** These parameters are measured with the dipole positioned under the liquid filled phantom. The impedance stated is transformed from the measurement at the SMA connector to the feed point. The Return Loss ensures low reflected power. No uncertainty required.
- Electrical Delay:** One-way delay between the SMA connector and the antenna feed point. No uncertainty required.
- SAR measured:** SAR measured at the stated antenna input power.
- SAR normalized:** SAR as measured, normalized to an input power of 1 W at the antenna connector.
- SAR for nominal TSL parameters:** The measured TSL parameters are used to calculate the nominal SAR result.

The reported uncertainty of measurement is stated as the standard uncertainty of measurement multiplied by the coverage factor $k=2$, which for a normal distribution corresponds to a coverage probability of approximately 95%.

Measurement Conditions

DASY system configuration, as far as not given on page 1.

DASY Version	DASY5	V52.8.1
Extrapolation	Advanced Extrapolation	
Phantom	Modular Flat Phantom	
Distance Dipole Center - TSL	15 mm	with Spacer
Zoom Scan Resolution	dx, dy, dz = 5 mm	
Frequency	835 MHz \pm 1 MHz	

Head TSL parameters

The following parameters and calculations were applied.

	Temperature	Permittivity	Conductivity
Nominal Head TSL parameters	22.0 °C	41.5	0.90 mho/m
Measured Head TSL parameters	(22.0 \pm 0.2) °C	41.1 \pm 6 %	0.90 mho/m \pm 6 %
Head TSL temperature change during test	< 0.5 °C	----	----

SAR result with Head TSL

SAR averaged over 1 cm³ (1 g) of Head TSL	Condition	
SAR measured	250 mW input power	2.37 mW / g
SAR for nominal Head TSL parameters	normalized to 1W	9.46 mW / g \pm 17.0 % (k=2)

SAR averaged over 10 cm³ (10 g) of Head TSL	condition	
SAR measured	250 mW input power	1.55 mW / g
SAR for nominal Head TSL parameters	normalized to 1W	6.19 mW / g \pm 16.5 % (k=2)

Body TSL parameters

The following parameters and calculations were applied.

	Temperature	Permittivity	Conductivity
Nominal Body TSL parameters	22.0 °C	55.2	0.97 mho/m
Measured Body TSL parameters	(22.0 \pm 0.2) °C	54.5 \pm 6 %	1.01 mho/m \pm 6 %
Body TSL temperature change during test	< 0.5 °C	----	----

SAR result with Body TSL

SAR averaged over 1 cm³ (1 g) of Body TSL	Condition	
SAR measured	250 mW input power	2.48 mW / g
SAR for nominal Body TSL parameters	normalized to 1W	9.60 mW / g \pm 17.0 % (k=2)

SAR averaged over 10 cm³ (10 g) of Body TSL	condition	
SAR measured	250 mW input power	1.63 mW / g
SAR for nominal Body TSL parameters	normalized to 1W	6.35 mW / g \pm 16.5 % (k=2)

Appendix

Antenna Parameters with Head TSL

Impedance, transformed to feed point	52.0 Ω - 2.1 j Ω
Return Loss	- 30.9 dB

Antenna Parameters with Body TSL

Impedance, transformed to feed point	47.7 Ω - 3.5 j Ω
Return Loss	- 27.4 dB

General Antenna Parameters and Design

Electrical Delay (one direction)	1.392 ns
----------------------------------	----------

After long term use with 100W radiated power, only a slight warming of the dipole near the feedpoint can be measured.

The dipole is made of standard semirigid coaxial cable. The center conductor of the feeding line is directly connected to the second arm of the dipole. The antenna is therefore short-circuited for DC-signals. On some of the dipoles, small end caps are added to the dipole arms in order to improve matching when loaded according to the position as explained in the "Measurement Conditions" paragraph. The SAR data are not affected by this change. The overall dipole length is still according to the Standard.

No excessive force must be applied to the dipole arms, because they might bend or the soldered connections near the feedpoint may be damaged.

Additional EUT Data

Manufactured by	SPEAG
Manufactured on	April 22, 2004

DASY5 Validation Report for Head TSL

Date: 20.04.2012

Test Laboratory: SPEAG, Zurich, Switzerland

DUT: Dipole 835 MHz; Type: D835V2; Serial: D835V2 - SN: 4d021

Communication System: CW; Frequency: 835 MHz

Medium parameters used: $f = 835$ MHz; $\sigma = 0.9$ mho/m; $\epsilon_r = 41.1$; $\rho = 1000$ kg/m³

Phantom section: Flat Section

Measurement Standard: DASY5 (IEEE/IEC/ANSI C63.19-2007)

DASY52 Configuration:

- Probe: ES3DV3 - SN3205; ConvF(6.07, 6.07, 6.07); Calibrated: 30.12.2011;
- Sensor-Surface: 3mm (Mechanical Surface Detection)
- Electronics: DAE4 Sn601; Calibrated: 04.07.2011
- Phantom: Flat Phantom 4.9L; Type: QD000P49AA; Serial: 1001
- DASY52 52.8.1(838); SEMCAD X 14.6.5(6469)

Dipole Calibration for Head Tissue/Pin=250 mW, d=15mm/Zoom Scan (7x7x7)/Cube 0:

Measurement grid: dx=5mm, dy=5mm, dz=5mm

Reference Value = 57.325 V/m; Power Drift = -0.00 dB

Peak SAR (extrapolated) = 3.488 mW/g

SAR(1 g) = 2.37 mW/g; SAR(10 g) = 1.55 mW/g

Maximum value of SAR (measured) = 2.76 mW/g

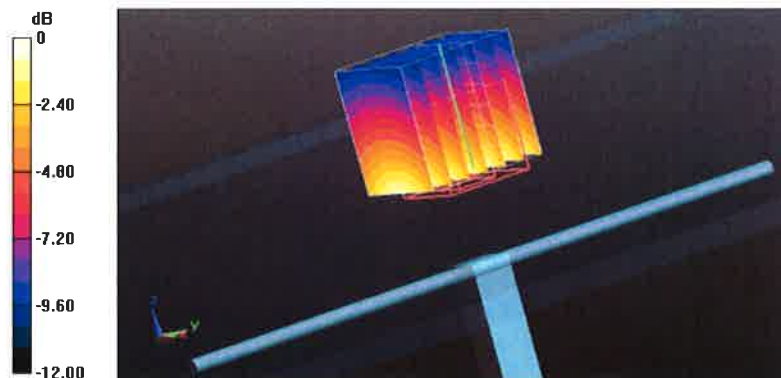

0 dB = 2.76 mW/g = 8.82 dB mW/g

Impedance Measurement Plot for Head TSL

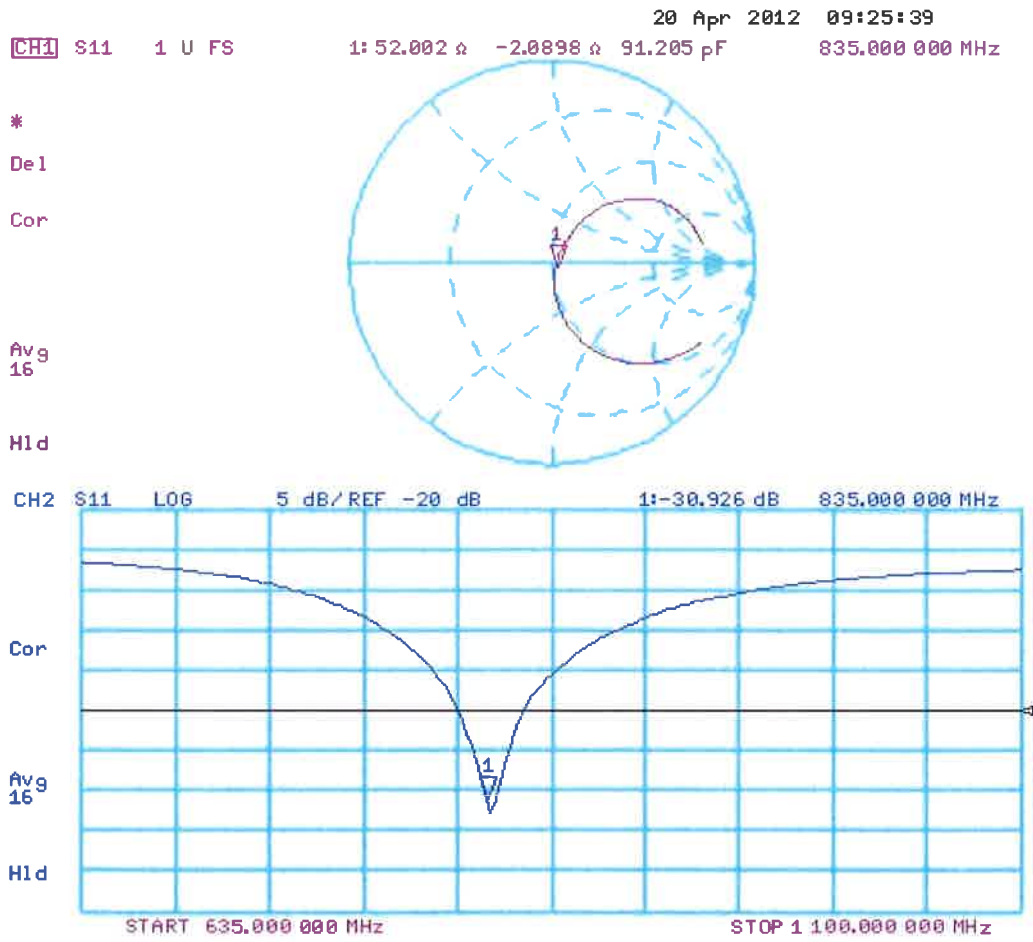

DASY5 Validation Report for Body TSL

Date: 19.04.2012

Test Laboratory: SPEAG, Zurich, Switzerland

DUT: Dipole 835 MHz; Type: D835V2; Serial: D835V2 - SN: 4d021

Communication System: CW; Frequency: 835 MHz

Medium parameters used: $f = 835$ MHz; $\sigma = 1.01$ mho/m; $\epsilon_r = 54.5$; $\rho = 1000$ kg/m³

Phantom section: Flat Section

Measurement Standard: DASY5 (IEEE/IEC/ANSI C63.19-2007)

DASY52 Configuration:

- Probe: ES3DV3 - SN3205; ConvF(6.02, 6.02, 6.02); Calibrated: 30.12.2011;
- Sensor-Surface: 3mm (Mechanical Surface Detection)
- Electronics: DAE4 Sn601; Calibrated: 04.07.2011
- Phantom: Flat Phantom 4.9L; Type: QD000P49AA; Serial: 1001
- DASY52 52.8.1(838); SEMCAD X 14.6.5(6469)

Dipole Calibration for Body Tissue/Pin=250 mW, d=15mm/Zoom Scan (7x7x7)/Cube 0:

Measurement grid: dx=5mm, dy=5mm, dz=5mm

Reference Value = 55.287 V/m; Power Drift = 0.01 dB

Peak SAR (extrapolated) = 3.590 mW/g

SAR(1 g) = 2.48 mW/g; SAR(10 g) = 1.63 mW/g

Maximum value of SAR (measured) = 2.88 mW/g

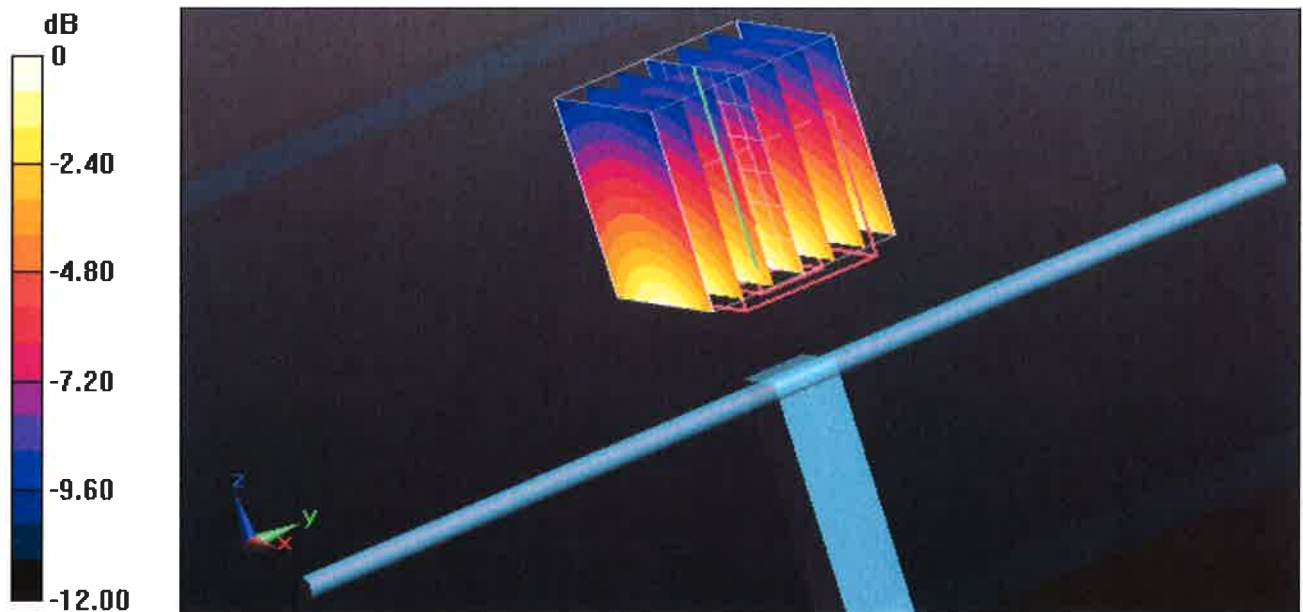

0 dB = 2.88 mW/g = 9.19 dB mW/g

Impedance Measurement Plot for Body TSL

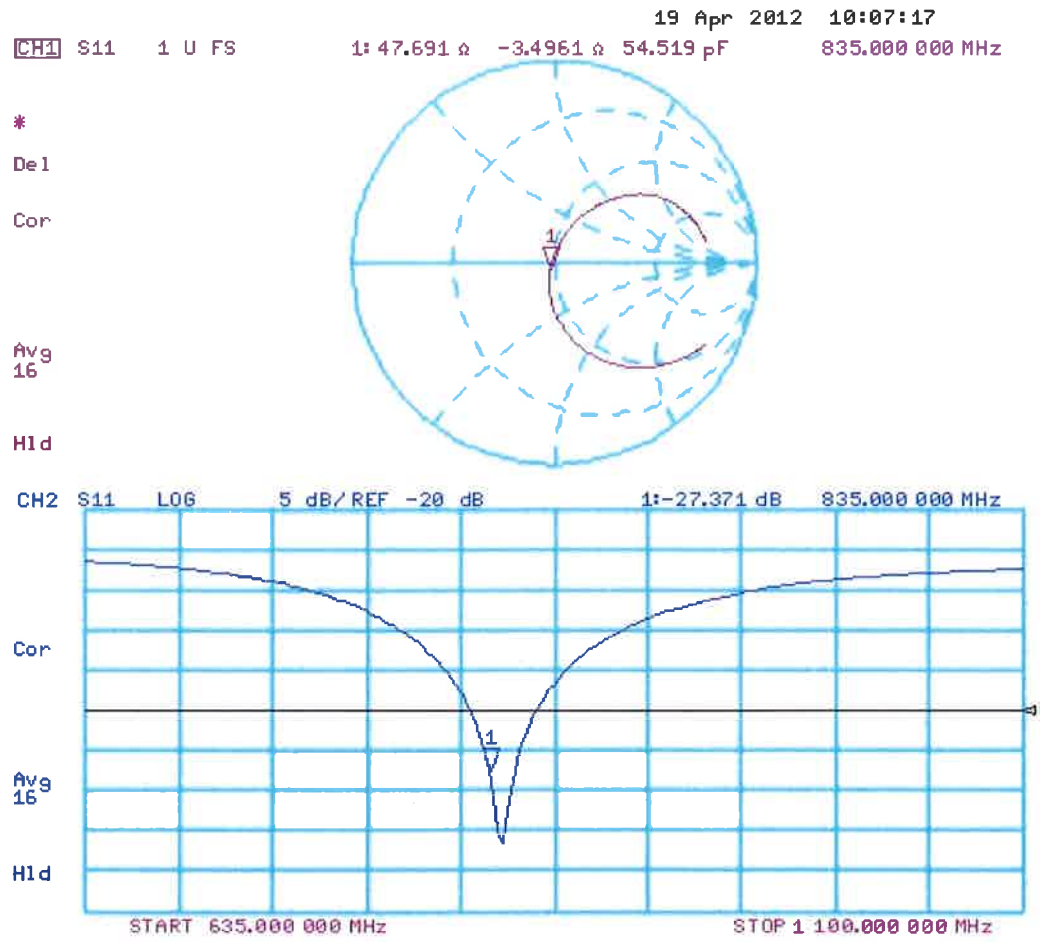



Accredited by the Swiss Accreditation Service (SAS)
The Swiss Accreditation Service is one of the signatories to the EA
Multilateral Agreement for the recognition of calibration certificates

Accreditation No.: **SCS 108**

Client **B.V.ADT (Auden)**

Certificate No: **D1900V2-5d036_Jan12**

CALIBRATION CERTIFICATE

Object **D1900V2 - SN: 5d036**

Calibration procedure(s) **QA CAL-05.v8
Calibration procedure for dipole validation kits above 700 MHz**

Calibration date: **January 26, 2012**

This calibration certificate documents the traceability to national standards, which realize the physical units of measurements (SI).
The measurements and the uncertainties with confidence probability are given on the following pages and are part of the certificate.

All calibrations have been conducted in the closed laboratory facility: environment temperature $(22 \pm 3)^\circ\text{C}$ and humidity $< 70\%$.

Calibration Equipment used (M&TE critical for calibration)

Primary Standards	ID #	Cal Date (Certificate No.)	Scheduled Calibration
Power meter EPM-442A	GB37480704	05-Oct-11 (No. 217-01451)	Oct-12
Power sensor HP 8481A	US37292783	05-Oct-11 (No. 217-01451)	Oct-12
Reference 20 dB Attenuator	SN: 5086 (20g)	29-Mar-11 (No. 217-01368)	Apr-12
Type-N mismatch combination	SN: 5047.2 / 06327	29-Mar-11 (No. 217-01371)	Apr-12
Reference Probe ES3DV3	SN: 3205	30-Dec-11 (No. ES3-3205_Dec11)	Dec-12
DAE4	SN: 601	04-Jul-11 (No. DAE4-601_Jul11)	Jul-12
Secondary Standards	ID #	Check Date (in house)	Scheduled Check
Power sensor HP 8481A	MY41092317	18-Oct-02 (in house check Oct-11)	In house check: Oct-13
RF generator R&S SMT-06	100005	04-Aug-99 (in house check Oct-11)	In house check: Oct-13
Network Analyzer HP 8753E	US37390585 S4206	18-Oct-01 (in house check Oct-11)	In house check: Oct-12

Calibrated by:	Name Dimce Iliev	Function Laboratory Technician	Signature
Approved by:	Name Katja Pokovic	Function Technical Manager	Signature

Issued: January 26, 2012

This calibration certificate shall not be reproduced except in full without written approval of the laboratory.



Accredited by the Swiss Accreditation Service (SAS)
The Swiss Accreditation Service is one of the signatories to the EA
Multilateral Agreement for the recognition of calibration certificates

Accreditation No.: **SCS 108**

Glossary:

TSL tissue simulating liquid
ConvF sensitivity in TSL / NORM x,y,z
N/A not applicable or not measured

Calibration is Performed According to the Following Standards:

- a) IEEE Std 1528-2003, "IEEE Recommended Practice for Determining the Peak Spatial-Averaged Specific Absorption Rate (SAR) in the Human Head from Wireless Communications Devices: Measurement Techniques", December 2003
- b) IEC 62209-1, "Procedure to measure the Specific Absorption Rate (SAR) for hand-held devices used in close proximity to the ear (frequency range of 300 MHz to 3 GHz)", February 2005
- c) Federal Communications Commission Office of Engineering & Technology (FCC OET), "Evaluating Compliance with FCC Guidelines for Human Exposure to Radiofrequency Electromagnetic Fields; Additional Information for Evaluating Compliance of Mobile and Portable Devices with FCC Limits for Human Exposure to Radiofrequency Emissions", Supplement C (Edition 01-01) to Bulletin 65

Additional Documentation:

- d) DASY4/5 System Handbook

Methods Applied and Interpretation of Parameters:

- *Measurement Conditions:* Further details are available from the Validation Report at the end of the certificate. All figures stated in the certificate are valid at the frequency indicated.
- *Antenna Parameters with TSL:* The dipole is mounted with the spacer to position its feed point exactly below the center marking of the flat phantom section, with the arms oriented parallel to the body axis.
- *Feed Point Impedance and Return Loss:* These parameters are measured with the dipole positioned under the liquid filled phantom. The impedance stated is transformed from the measurement at the SMA connector to the feed point. The Return Loss ensures low reflected power. No uncertainty required.
- *Electrical Delay:* One-way delay between the SMA connector and the antenna feed point. No uncertainty required.
- *SAR measured:* SAR measured at the stated antenna input power.
- *SAR normalized:* SAR as measured, normalized to an input power of 1 W at the antenna connector.
- *SAR for nominal TSL parameters:* The measured TSL parameters are used to calculate the nominal SAR result.

Measurement Conditions

DASY system configuration, as far as not given on page 1.

DASY Version	DASY5	V52.8.0
Extrapolation	Advanced Extrapolation	
Phantom	Modular Flat Phantom	
Distance Dipole Center - TSL	10 mm	with Spacer
Zoom Scan Resolution	dx, dy, dz = 5 mm	
Frequency	1900 MHz ± 1 MHz	

Head TSL parameters

The following parameters and calculations were applied.

	Temperature	Permittivity	Conductivity
Nominal Head TSL parameters	22.0 °C	40.0	1.40 mho/m
Measured Head TSL parameters	(22.0 ± 0.2) °C	40.8 ± 6 %	1.39 mho/m ± 6 %
Head TSL temperature change during test	< 0.5 °C	----	----

SAR result with Head TSL

SAR averaged over 1 cm ³ (1 g) of Head TSL	Condition	
SAR measured	250 mW input power	9.65 mW / g
SAR for nominal Head TSL parameters	normalized to 1W	38.9 mW / g ± 17.0 % (k=2)

SAR averaged over 10 cm ³ (10 g) of Head TSL	condition	
SAR measured	250 mW input power	5.05 mW / g
SAR for nominal Head TSL parameters	normalized to 1W	20.3 mW / g ± 16.5 % (k=2)

Body TSL parameters

The following parameters and calculations were applied.

	Temperature	Permittivity	Conductivity
Nominal Body TSL parameters	22.0 °C	53.3	1.52 mho/m
Measured Body TSL parameters	(22.0 ± 0.2) °C	52.9 ± 6 %	1.52 mho/m ± 6 %
Body TSL temperature change during test	< 0.5 °C	----	----

SAR result with Body TSL

SAR averaged over 1 cm ³ (1 g) of Body TSL	Condition	
SAR measured	250 mW input power	9.74 mW / g
SAR for nominal Body TSL parameters	normalized to 1W	38.9 mW / g ± 17.0 % (k=2)

SAR averaged over 10 cm ³ (10 g) of Body TSL	condition	
SAR measured	250 mW input power	5.10 mW / g
SAR for nominal Body TSL parameters	normalized to 1W	20.4 mW / g ± 16.5 % (k=2)

Appendix

Antenna Parameters with Head TSL

Impedance, transformed to feed point	50.0 Ω + 4.9 j Ω
Return Loss	- 26.1 dB

Antenna Parameters with Body TSL

Impedance, transformed to feed point	46.3 Ω + 5.6 j Ω
Return Loss	- 23.1 dB

General Antenna Parameters and Design

Electrical Delay (one direction)	1.195 ns
----------------------------------	----------

After long term use with 100W radiated power, only a slight warming of the dipole near the feedpoint can be measured.

The dipole is made of standard semirigid coaxial cable. The center conductor of the feeding line is directly connected to the second arm of the dipole. The antenna is therefore short-circuited for DC-signals. On some of the dipoles, small end caps are added to the dipole arms in order to improve matching when loaded according to the position as explained in the "Measurement Conditions" paragraph. The SAR data are not affected by this change. The overall dipole length is still according to the Standard.

No excessive force must be applied to the dipole arms, because they might bend or the soldered connections near the feedpoint may be damaged.

Additional EUT Data

Manufactured by	SPEAG
Manufactured on	May 08, 2003

DASY5 Validation Report for Head TSL

Date: 26.01.2012

Test Laboratory: SPEAG, Zurich, Switzerland

DUT: Dipole 1900 MHz; Type: D1900V2; Serial: D1900V2 - SN: 5d036

Communication System: CW; Frequency: 1900 MHz

Medium parameters used: $f = 1900$ MHz; $\sigma = 1.39$ mho/m; $\epsilon_r = 40.8$; $\rho = 1000$ kg/m³

Phantom section: Flat Section

Measurement Standard: DASY5 (IEEE/IEC/ANSI C63.19-2007)

DASY52 Configuration:

- Probe: ES3DV3 - SN3205; ConvF(5.01, 5.01, 5.01); Calibrated: 30.12.2011
- Sensor-Surface: 3mm (Mechanical Surface Detection)
- Electronics: DAE4 Sn601; Calibrated: 04.07.2011
- Phantom: Flat Phantom 5.0 (front); Type: QD000P50AA; Serial: 1001
- DASY52 52.8.0(692); SEMCAD X 14.6.4(4989)

Dipole Calibration for Head Tissue/Pin=250 mW, d=10mm/Zoom Scan (7x7x7)/Cube 0:

Measurement grid: dx=5mm, dy=5mm, dz=5mm

Reference Value = 96.850 V/m; Power Drift = 0.04 dB

Peak SAR (extrapolated) = 17.7040

SAR(1 g) = 9.65 mW/g; SAR(10 g) = 5.05 mW/g

Maximum value of SAR (measured) = 12.055 mW/g

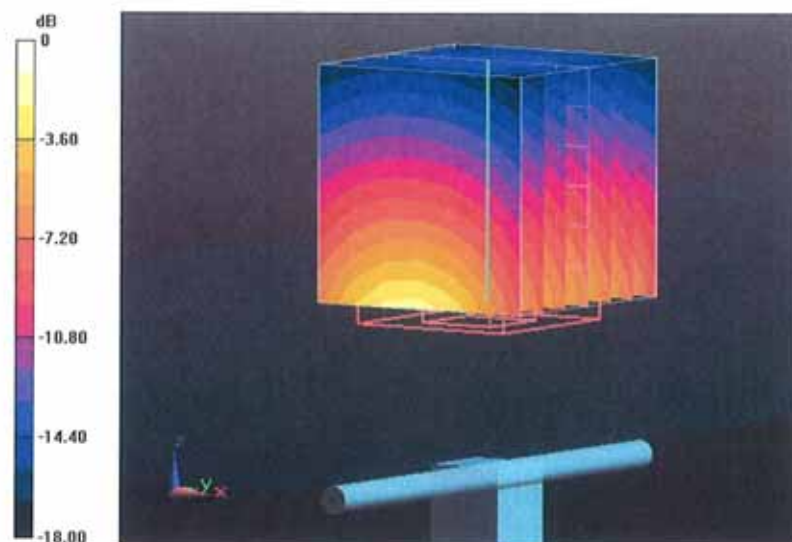

Impedance Measurement Plot for Head TSL

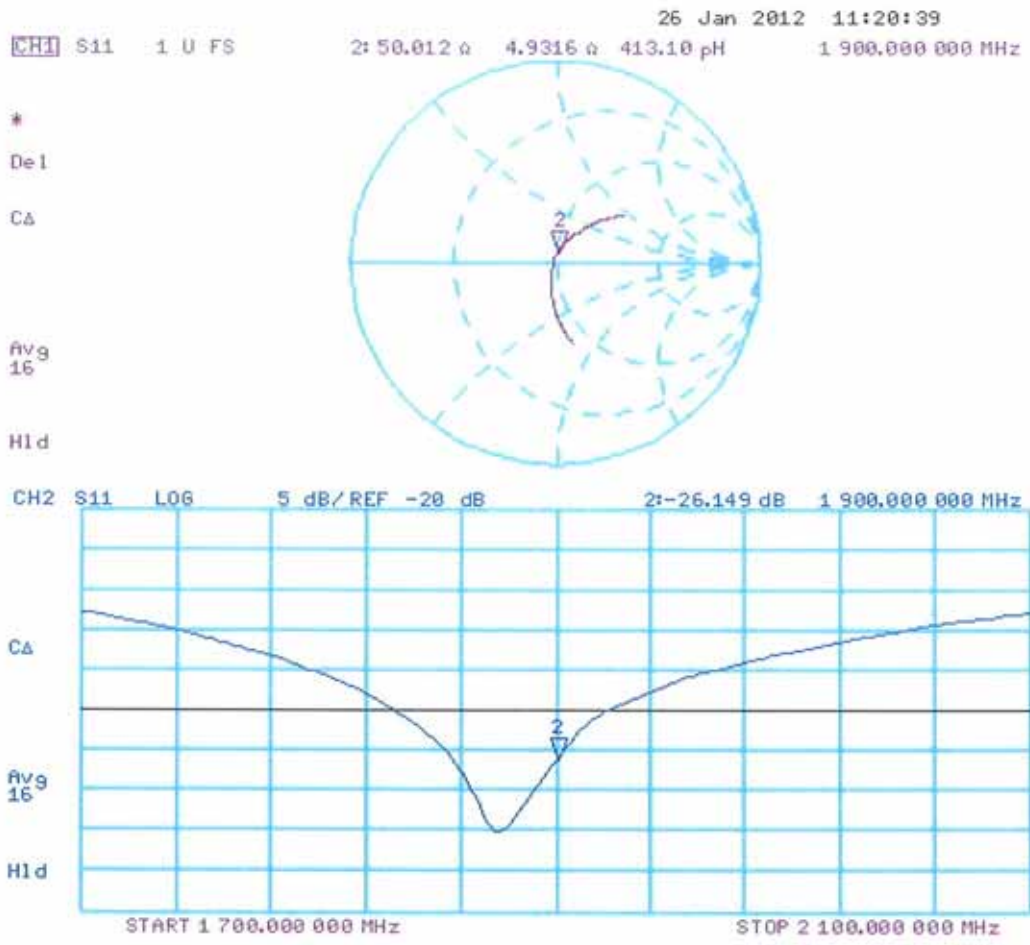

DASY5 Validation Report for Body TSL

Date: 26.01.2012

Test Laboratory: SPEAG, Zurich, Switzerland

DUT: Dipole 1900 MHz; Type: D1900V2; Serial: D1900V2 - SN: 5d036

Communication System: CW; Frequency: 1900 MHz

Medium parameters used: $f = 1900$ MHz; $\sigma = 1.52$ mho/m; $\epsilon_r = 52.9$; $\rho = 1000$ kg/m³

Phantom section: Flat Section

Measurement Standard: DASY5 (IEEE/IEC/ANSI C63.19-2007)

DASY52 Configuration:

- Probe: ES3DV3 - SN3205; ConvF(4.62, 4.62, 4.62); Calibrated: 30.12.2011
- Sensor-Surface: 3mm (Mechanical Surface Detection)
- Electronics: DAE4 Sn601; Calibrated: 04.07.2011
- Phantom: Flat Phantom 5.0 (back); Type: QD000P50AA; Serial: 1002
- DASY52 52.8.0(692); SEMCAD X 14.6.4(4989)

Dipole Calibration for Body Tissue/Pin=250 mW, d=10mm/Zoom Scan (7x7x7)/Cube 0:

Measurement grid: dx=5mm, dy=5mm, dz=5mm

Reference Value = 94.423 V/m; Power Drift = -0.0044 dB

Peak SAR (extrapolated) = 17.2700

SAR(1 g) = 9.74 mW/g; SAR(10 g) = 5.1 mW/g

Maximum value of SAR (measured) = 12.419 mW/g

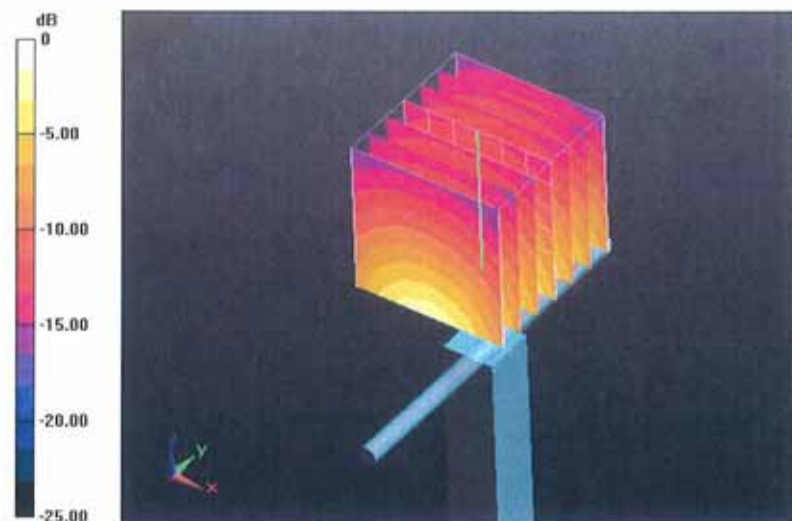

0 dB = 12.420mW/g = 21.88 dB mW/g

Impedance Measurement Plot for Body TSL

26 Jan 2012 11:19:41

CH1 S11 1 U FS 2: 46.256 Ω 5.6113 Ω 470.04 μ H 1 900.000 000 MHz

*
De1
CA

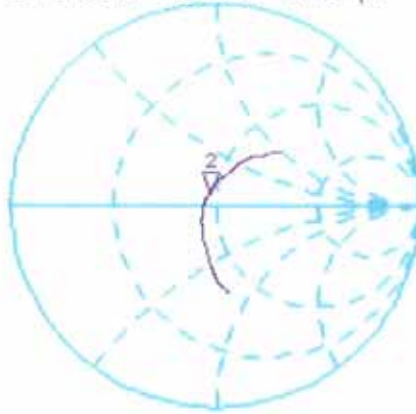

avg
16

HI d

CH2 S11 L06 5 dB/REF -20 dB 2:-23.096 dB 1 900.000 000 MHz

CA

avg
16

HI d

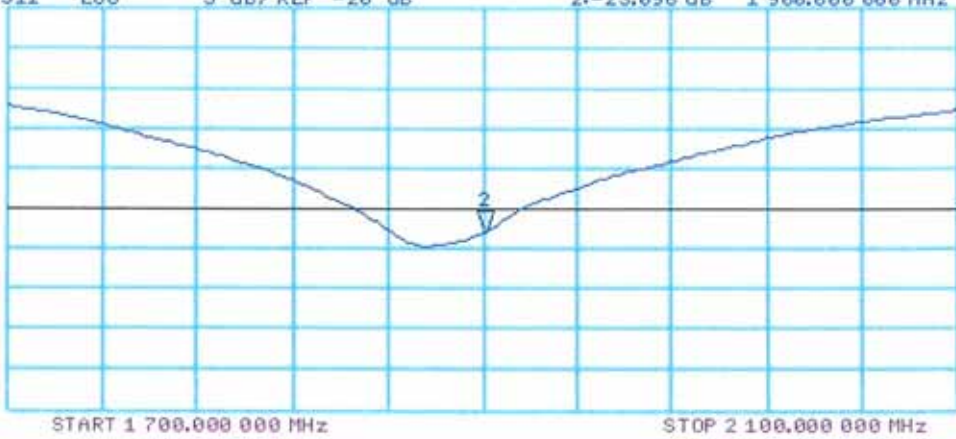



Accredited by the Swiss Accreditation Service (SAS)
The Swiss Accreditation Service is one of the signatories to the EA
Multilateral Agreement for the recognition of calibration certificates

Accreditation No.: **SCS 108**

Client **B.V.ADT (Auden)**

Certificate No: **D2450V2-737_Jan12**

CALIBRATION CERTIFICATE

Object **D2450V2 - SN: 737**

Calibration procedure(s) **QA CAL-05.v8
Calibration procedure for dipole validation kits above 700 MHz**

Calibration date: **January 24, 2012**

This calibration certificate documents the traceability to national standards, which realize the physical units of measurements (SI).
The measurements and the uncertainties with confidence probability are given on the following pages and are part of the certificate.

All calibrations have been conducted in the closed laboratory facility: environment temperature (22 ± 3)°C and humidity < 70%.

Calibration Equipment used (M&TE critical for calibration)

Primary Standards	ID #	Cal Date (Certificate No.)	Scheduled Calibration
Power meter EPM-442A	GB37480704	05-Oct-11 (No. 217-01451)	Oct-12
Power sensor HP 8481A	US37292783	05-Oct-11 (No. 217-01451)	Oct-12
Reference 20 dB Attenuator	SN: 5086 (20g)	29-Mar-11 (No. 217-01368)	Apr-12
Type-N mismatch combination	SN: 5047.2 / 06327	29-Mar-11 (No. 217-01371)	Apr-12
Reference Probe ES3DV3	SN: 3205	30-Dec-11 (No. ES3-3205_Dec11)	Dec-12
DAE4	SN: 601	04-Jul-11 (No. DAE4-601_Jul11)	Jul-12
Secondary Standards	ID #	Check Date (in house)	Scheduled Check
Power sensor HP 8481A	MY41092317	18-Oct-02 (in house check Oct-11)	In house check: Oct-13
RF generator R&S SMT-06	100005	04-Aug-99 (in house check Oct-11)	In house check: Oct-13
Network Analyzer HP 8753E	US37390585 S4206	18-Oct-01 (in house check Oct-11)	In house check: Oct-12

	Name	Function	Signature
Calibrated by:	Israe El-Naouq	Laboratory Technician	
Approved by:	Katja Pokovic	Technical Manager	

Issued: January 24, 2012

This calibration certificate shall not be reproduced except in full without written approval of the laboratory.



Accredited by the Swiss Accreditation Service (SAS)
The Swiss Accreditation Service is one of the signatories to the EA
Multilateral Agreement for the recognition of calibration certificates

Accreditation No.: **SCS 108**

Glossary:

TSL	tissue simulating liquid
ConvF	sensitivity in TSL / NORM x,y,z
N/A	not applicable or not measured

Calibration is Performed According to the Following Standards:

- IEEE Std 1528-2003, "IEEE Recommended Practice for Determining the Peak Spatial-Averaged Specific Absorption Rate (SAR) in the Human Head from Wireless Communications Devices: Measurement Techniques", December 2003
- IEC 62209-1, "Procedure to measure the Specific Absorption Rate (SAR) for hand-held devices used in close proximity to the ear (frequency range of 300 MHz to 3 GHz)", February 2005
- Federal Communications Commission Office of Engineering & Technology (FCC OET), "Evaluating Compliance with FCC Guidelines for Human Exposure to Radiofrequency Electromagnetic Fields; Additional Information for Evaluating Compliance of Mobile and Portable Devices with FCC Limits for Human Exposure to Radiofrequency Emissions", Supplement C (Edition 01-01) to Bulletin 65

Additional Documentation:

- DASY4/5 System Handbook

Methods Applied and Interpretation of Parameters:

- Measurement Conditions:* Further details are available from the Validation Report at the end of the certificate. All figures stated in the certificate are valid at the frequency indicated.
- Antenna Parameters with TSL:* The dipole is mounted with the spacer to position its feed point exactly below the center marking of the flat phantom section, with the arms oriented parallel to the body axis.
- Feed Point Impedance and Return Loss:* These parameters are measured with the dipole positioned under the liquid filled phantom. The impedance stated is transformed from the measurement at the SMA connector to the feed point. The Return Loss ensures low reflected power. No uncertainty required.
- Electrical Delay:* One-way delay between the SMA connector and the antenna feed point. No uncertainty required.
- SAR measured:* SAR measured at the stated antenna input power.
- SAR normalized:* SAR as measured, normalized to an input power of 1 W at the antenna connector.
- SAR for nominal TSL parameters:* The measured TSL parameters are used to calculate the nominal SAR result.

Measurement Conditions

DASY system configuration, as far as not given on page 1.

DASY Version	DASY5	V52.8.0
Extrapolation	Advanced Extrapolation	
Phantom	Modular Flat Phantom	
Distance Dipole Center - TSL	10 mm	with Spacer
Zoom Scan Resolution	dx, dy, dz = 5 mm	
Frequency	2450 MHz \pm 1 MHz	

Head TSL parameters

The following parameters and calculations were applied.

	Temperature	Permittivity	Conductivity
Nominal Head TSL parameters	22.0 °C	39.2	1.80 mho/m
Measured Head TSL parameters	(22.0 \pm 0.2) °C	39.2 \pm 6 %	1.85 mho/m \pm 6 %
Head TSL temperature change during test	< 0.5 °C	----	----

SAR result with Head TSL

SAR averaged over 1 cm ³ (1 g) of Head TSL	Condition	
SAR measured	250 mW input power	13.4 mW / g
SAR for nominal Head TSL parameters	normalized to 1W	52.9 mW / g \pm 17.0 % (k=2)

SAR averaged over 10 cm ³ (10 g) of Head TSL	condition	
SAR measured	250 mW input power	6.18 mW / g
SAR for nominal Head TSL parameters	normalized to 1W	24.5 mW / g \pm 16.5 % (k=2)

Body TSL parameters

The following parameters and calculations were applied.

	Temperature	Permittivity	Conductivity
Nominal Body TSL parameters	22.0 °C	52.7	1.95 mho/m
Measured Body TSL parameters	(22.0 \pm 0.2) °C	50.6 \pm 6 %	2.01 mho/m \pm 6 %
Body TSL temperature change during test	< 0.5 °C	----	----

SAR result with Body TSL

SAR averaged over 1 cm ³ (1 g) of Body TSL	Condition	
SAR measured	250 mW input power	12.8 mW / g
SAR for nominal Body TSL parameters	normalized to 1W	50.0 mW / g \pm 17.0 % (k=2)

SAR averaged over 10 cm ³ (10 g) of Body TSL	condition	
SAR measured	250 mW input power	5.91 mW / g
SAR for nominal Body TSL parameters	normalized to 1W	23.3 mW / g \pm 16.5 % (k=2)

Appendix

Antenna Parameters with Head TSL

Impedance, transformed to feed point	54.3 Ω + 4.3 j Ω
Return Loss	- 24.7 dB

Antenna Parameters with Body TSL

Impedance, transformed to feed point	50.6 Ω + 5.3 j Ω
Return Loss	- 25.6 dB

General Antenna Parameters and Design

Electrical Delay (one direction)	1.161 ns
----------------------------------	----------

After long term use with 100W radiated power, only a slight warming of the dipole near the feedpoint can be measured.

The dipole is made of standard semirigid coaxial cable. The center conductor of the feeding line is directly connected to the second arm of the dipole. The antenna is therefore short-circuited for DC-signals. On some of the dipoles, small end caps are added to the dipole arms in order to improve matching when loaded according to the position as explained in the "Measurement Conditions" paragraph. The SAR data are not affected by this change. The overall dipole length is still according to the Standard.

No excessive force must be applied to the dipole arms, because they might bend or the soldered connections near the feedpoint may be damaged.

Additional EUT Data

Manufactured by	SPEAG
Manufactured on	August 26, 2003

DASY5 Validation Report for Head TSL

Date: 24.01.2012

Test Laboratory: SPEAG, Zurich, Switzerland

DUT: Dipole 2450 MHz; Type: D2450V2; Serial: D2450V2 - SN: 737

Communication System: CW; Frequency: 2450 MHz

Medium parameters used: $f = 2450$ MHz; $\sigma = 1.85$ mho/m; $\epsilon_r = 39.2$; $\rho = 1000$ kg/m³

Phantom section: Flat Section

Measurement Standard: DASY5 (IEEE/IEC/ANSI C63.19-2007)

DASY52 Configuration:

- Probe: ES3DV3 - SN3205; ConvF(4.45, 4.45, 4.45); Calibrated: 30.12.2011
- Sensor-Surface: 3mm (Mechanical Surface Detection)
- Electronics: DAE4 Sn601; Calibrated: 04.07.2011
- Phantom: Flat Phantom 5.0 (front); Type: QD000P50AA; Serial: 1001
- DASY52 52.8.0(692); SEMCAD X 14.6.4(4989)

Dipole Calibration for Head Tissue/Pin=250 mW, d=10mm/Zoom Scan (7x7x7)/Cube 0:

Measurement grid: dx=5mm, dy=5mm, dz=5mm

Reference Value = 99.933 V/m; Power Drift = 0.08 dB

Peak SAR (extrapolated) = 27.6400

SAR(1 g) = 13.4 mW/g; SAR(10 g) = 6.18 mW/g

Maximum value of SAR (measured) = 17.183 mW/g

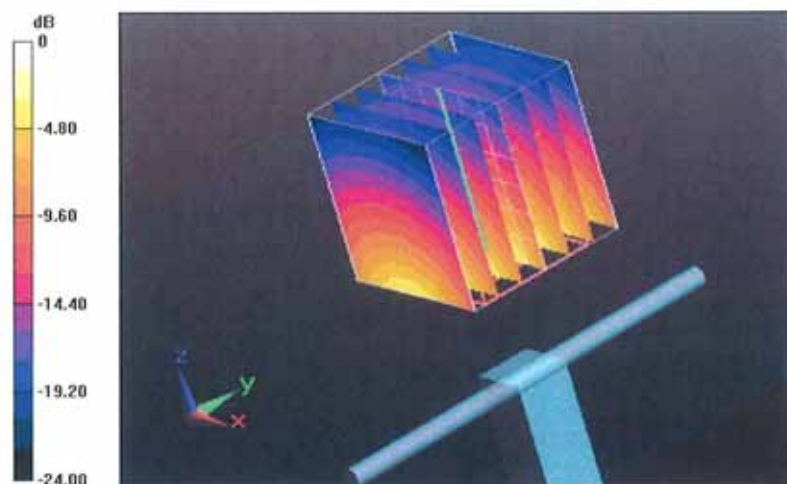

0 dB = 17.180mW/g = 24.70 dB mW/g

Impedance Measurement Plot for Head TSL

24 Jan 2012 11:02:13

CH1 S11 1 U FS

4: 54.291 \hat{u} 4.3184 \hat{u} 280.53 pF

2 450.000 000 MHz

*
De1

CA

avg
16

H1d

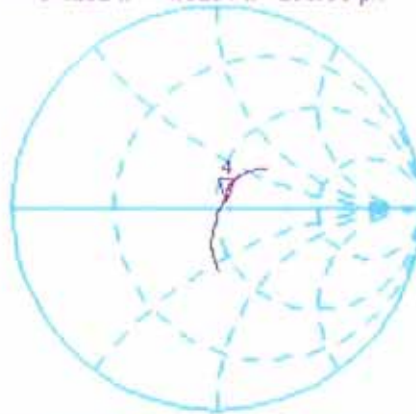

CH2 S11 LOG

5 dB/REF -20 dB

4i-24.678 dB

2 450.000 000 MHz

CA

avg
16

H1d

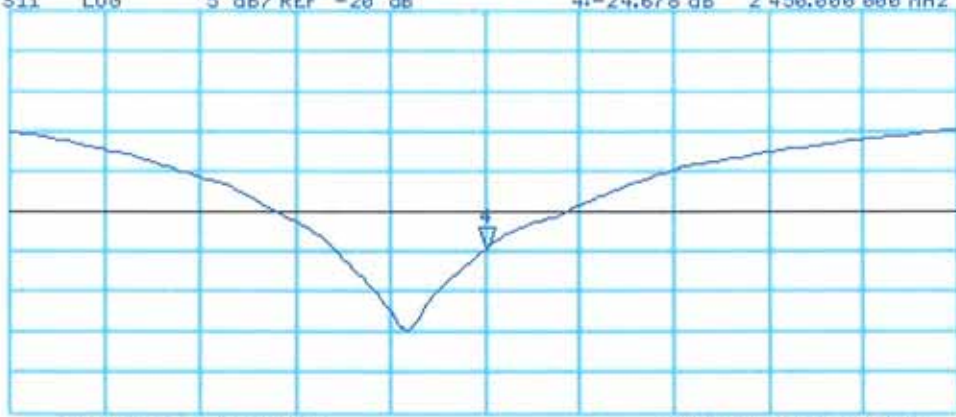

START 2 250.000 000 MHz

STOP 2 650.000 000 MHz

DASY5 Validation Report for Body TSL

Date: 23.01.2012

Test Laboratory: SPEAG, Zurich, Switzerland

DUT: Dipole 2450 MHz; Type: D2450V2; Serial: D2450V2 - SN: 737

Communication System: CW; Frequency: 2450 MHz

Medium parameters used: $f = 2450$ MHz; $\sigma = 2.01$ mho/m; $\epsilon_r = 50.6$; $\rho = 1000$ kg/m³

Phantom section: Flat Section

Measurement Standard: DASY5 (IEEE/IEC/ANSI C63.19-2007)

DASY52 Configuration:

- Probe: ES3DV3 - SN3205; ConvF(4.26, 4.26, 4.26); Calibrated: 30.12.2011
- Sensor-Surface: 3mm (Mechanical Surface Detection)
- Electronics: DAE4 Sn601; Calibrated: 04.07.2011
- Phantom: Flat Phantom 5.0 (back); Type: QD000P50AA; Serial: 1002
- DASY52 52.8.0(692); SEMCAD X 14.6.4(4989)

Dipole Calibration for Body Tissue/Pin=250 mW, d=10mm/Zoom Scan (7x7x7)/Cube 0:

Measurement grid: dx=5mm, dy=5mm, dz=5mm

Reference Value = 94.889 V/m; Power Drift = 0.03 dB

Peak SAR (extrapolated) = 26.6520

SAR(1 g) = 12.8 mW/g; SAR(10 g) = 5.91 mW/g

Maximum value of SAR (measured) = 17.026 mW/g

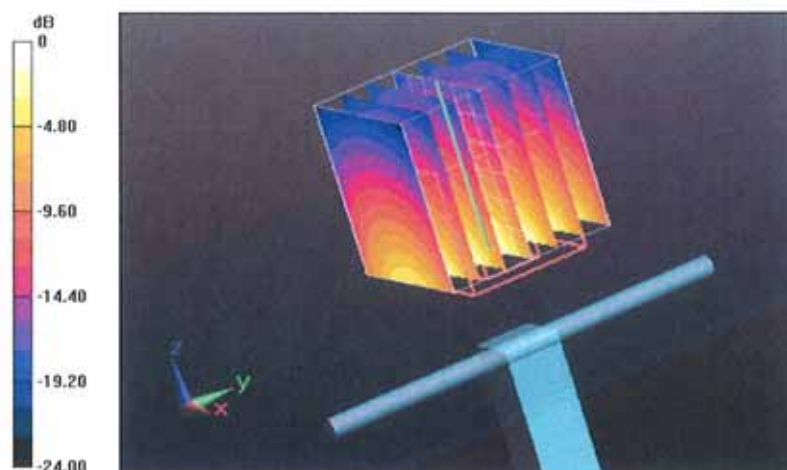

0 dB = 17.030mW/g = 24.62 dB mW/g

Impedance Measurement Plot for Body TSL

23 Jan 2012 11:06:18

CH1 S11 1 U FS

3: 50.611 Ω 5.2559 Ω 341.43 μH

2 450.000 000 MHz

*
De l
C Δ

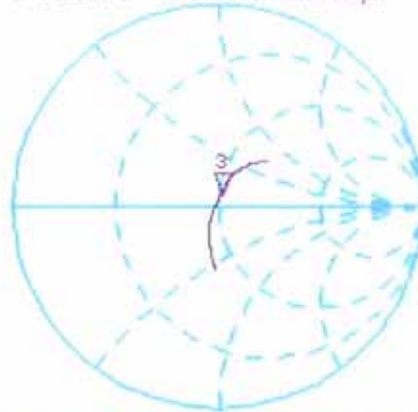

avg
16

H1 d

CH2 S11 LOG 5 dB/REF -20 dB 3:-25.587 dB 2 450.000 000 MHz

C Δ

avg
16

H1 d

START 2 250.000 000 MHz

STOP 2 650.000 000 MHz

**Calibration Laboratory of
Schmid & Partner
Engineering AG**
Zeughausstrasse 43, 8004 Zurich, Switzerland



S Schweizerischer Kalibrierdienst
C Service suisse d'étalonnage
S Servizio svizzero di taratura
S Swiss Calibration Service

Accredited by the Swiss Accreditation Service (SAS)
The Swiss Accreditation Service is one of the signatories to the EA
Multilateral Agreement for the recognition of calibration certificates

Accreditation No.: **SCS 108**

Client **B.V. ADT (Auden)**

Certificate No: **EX3-3650_Oct11**

CALIBRATION CERTIFICATE

Object **EX3DV4 - SN:3650**

Calibration procedure(s) **QA CAL-01.v8, QA CAL-14.v3, QA CAL-23.v4, QA CAL-25.v4
Calibration procedure for dosimetric E-field probes**

Calibration date: **October 26, 2011**

This calibration certificate documents the traceability to national standards, which realize the physical units of measurements (SI).
The measurements and the uncertainties with confidence probability are given on the following pages and are part of the certificate.

All calibrations have been conducted in the closed laboratory facility: environment temperature (22 ± 3)°C and humidity < 70%.

Calibration Equipment used (M&TE critical for calibration)

Primary Standards	ID	Cal Date (Certificate No.)	Scheduled Calibration
Power meter E4419B	GB41293874	31-Mar-11 (No. 217-01372)	Apr-12
Power sensor E4412A	MY41498087	31-Mar-11 (No. 217-01372)	Apr-12
Reference 3 dB Attenuator	SN: S5054 (3c)	29-Mar-11 (No. 217-01369)	Apr-12
Reference 20 dB Attenuator	SN: S5086 (20b)	29-Mar-11 (No. 217-01367)	Apr-12
Reference 30 dB Attenuator	SN: S5129 (30b)	29-Mar-11 (No. 217-01370)	Apr-12
Reference Probe ES3DV2	SN: 3013	29-Dec-10 (No. ES3-3013_Dec10)	Dec-11
DAE4	SN: 654	3-May-11 (No. DAE4-654_May11)	May-12
Secondary Standards	ID	Check Date (in house)	Scheduled Check
RF generator HP 8648C	US3642U01700	4-Aug-99 (in house check Apr-11)	In house check: Apr-13
Network Analyzer HP 8753E	US37390585	18-Oct-01 (in house check Oct-11)	In house check: Oct-12

	Name	Function	Signature
Calibrated by:	Jeton Kastrati	Laboratory Technician	
Approved by:	Katja Pokovic	Technical Manager	
			Issued: October 27, 2011

This calibration certificate shall not be reproduced except in full without written approval of the laboratory.



Accredited by the Swiss Accreditation Service (SAS)

Accreditation No.: **SCS 108**

The Swiss Accreditation Service is one of the signatories to the EA
Multilateral Agreement for the recognition of calibration certificates

Glossary:

TSL	tissue simulating liquid
NORM _{x,y,z}	sensitivity in free space
ConvF	sensitivity in TSL / NORM _{x,y,z}
DCP	diode compression point
CF	crest factor (1/duty_cycle) of the RF signal
A, B, C	modulation dependent linearization parameters
Polarization φ	φ rotation around probe axis
Polarization ϑ	ϑ rotation around an axis that is in the plane normal to probe axis (at measurement center), i.e., $\vartheta = 0$ is normal to probe axis

Calibration is Performed According to the Following Standards:

- IEEE Std 1528-2003, "IEEE Recommended Practice for Determining the Peak Spatial-Averaged Specific Absorption Rate (SAR) in the Human Head from Wireless Communications Devices: Measurement Techniques", December 2003
- IEC 62209-1, "Procedure to measure the Specific Absorption Rate (SAR) for hand-held devices used in close proximity to the ear (frequency range of 300 MHz to 3 GHz)", February 2005

Methods Applied and Interpretation of Parameters:

- NORM_{x,y,z}**: Assessed for E-field polarization $\vartheta = 0$ ($f \leq 900$ MHz in TEM-cell; $f > 1800$ MHz: R22 waveguide). NORM_{x,y,z} are only intermediate values, i.e., the uncertainties of NORM_{x,y,z} does not affect the E²-field uncertainty inside TSL (see below *ConvF*).
- NORM(f)_{x,y,z} = NORM_{x,y,z} * frequency_response** (see Frequency Response Chart). This linearization is implemented in DASY4 software versions later than 4.2. The uncertainty of the frequency response is included in the stated uncertainty of *ConvF*.
- DCP_{x,y,z}**: DCP are numerical linearization parameters assessed based on the data of power sweep with CW signal (no uncertainty required). DCP does not depend on frequency nor media.
- PAR**: PAR is the Peak to Average Ratio that is not calibrated but determined based on the signal characteristics
- A_{x,y,z}; B_{x,y,z}; C_{x,y,z}; VR_{x,y,z}**: A, B, C are numerical linearization parameters assessed based on the data of power sweep for specific modulation signal. The parameters do not depend on frequency nor media. VR is the maximum calibration range expressed in RMS voltage across the diode.
- ConvF and Boundary Effect Parameters**: Assessed in flat phantom using E-field (or Temperature Transfer Standard for $f \leq 800$ MHz) and inside waveguide using analytical field distributions based on power measurements for $f > 800$ MHz. The same setups are used for assessment of the parameters applied for boundary compensation (alpha, depth) of which typical uncertainty values are given. These parameters are used in DASY4 software to improve probe accuracy close to the boundary. The sensitivity in TSL corresponds to NORM_{x,y,z} * ConvF whereby the uncertainty corresponds to that given for ConvF. A frequency dependent ConvF is used in DASY version 4.4 and higher which allows extending the validity from ± 50 MHz to ± 100 MHz.
- Spherical isotropy (3D deviation from isotropy)**: in a field of low gradients realized using a flat phantom exposed by a patch antenna.
- Sensor Offset**: The sensor offset corresponds to the offset of virtual measurement center from the probe tip (on probe axis). No tolerance required.

Probe EX3DV4

SN:3650

Manufactured: March 18, 2008
Calibrated: October 26, 2011

Calibrated for DASYS/EASY Systems
(Note: non-compatible with DASYS2 system!)

DASY/EASY - Parameters of Probe: EX3DV4 - SN:3650

Basic Calibration Parameters

	Sensor X	Sensor Y	Sensor Z	Unc (k=2)
Norm ($\mu\text{V}/(\text{V}/\text{m})^2$) ^A	0.36	0.37	0.46	$\pm 10.1 \%$
DCP (mV) ^B	98.5	94.0	98.2	

Modulation Calibration Parameters

UID	Communication System Name	PAR		A dB	B dB	C dB	VR mV	Unc ^E (k=2)
10000	CW	0.00	X	0.00	0.00	1.00	94.9	$\pm 2.5 \%$
			Y	0.00	0.00	1.00	90.7	
			Z	0.00	0.00	1.00	114.0	

The reported uncertainty of measurement is stated as the standard uncertainty of measurement multiplied by the coverage factor $k=2$, which for a normal distribution corresponds to a coverage probability of approximately 95%.

^A The uncertainties of NormX,Y,Z do not affect the E^2 -field uncertainty inside TSL (see Pages 5 and 6).

^B Numerical linearization parameter: uncertainty not required.

^E Uncertainty is determined using the max. deviation from linear response applying rectangular distribution and is expressed for the square of the field value.

DASY/EASY - Parameters of Probe: EX3DV4 - SN:3650

Calibration Parameter Determined in Head Tissue Simulating Media

f (MHz) ^C	Relative Permittivity ^F	Conductivity (S/m) ^F	ConvF X	ConvF Y	ConvF Z	Alpha	Depth (mm)	Unct. (k=2)
750	41.9	0.89	9.20	9.20	9.20	0.79	0.69	± 12.0 %
835	41.5	0.90	8.87	8.87	8.87	0.79	0.69	± 12.0 %
1450	40.5	1.20	8.32	8.32	8.32	0.79	0.65	± 12.0 %
1750	40.1	1.37	7.92	7.92	7.92	0.70	0.63	± 12.0 %
1950	40.0	1.40	7.40	7.40	7.40	0.79	0.54	± 12.0 %
2450	39.2	1.80	6.80	6.80	6.80	0.59	0.62	± 12.0 %
2600	39.0	1.96	6.68	6.68	6.68	0.50	0.74	± 12.0 %
5200	36.0	4.66	5.05	5.05	5.05	0.35	1.80	± 13.1 %
5300	35.9	4.76	4.71	4.71	4.71	0.40	1.80	± 13.1 %
5500	35.6	4.96	4.56	4.56	4.56	0.45	1.80	± 13.1 %
5600	35.5	5.07	4.42	4.42	4.42	0.45	1.80	± 13.1 %
5800	35.3	5.27	4.30	4.30	4.30	0.50	1.80	± 13.1 %

^C Frequency validity of ± 100 MHz only applies for DASY v4.4 and higher (see Page 2), else it is restricted to ± 50 MHz. The uncertainty is the RSS of the ConvF uncertainty at calibration frequency and the uncertainty for the indicated frequency band.

^F At frequencies below 3 GHz, the validity of tissue parameters (ϵ and σ) can be relaxed to ± 10% if liquid compensation formula is applied to measured SAR values. At frequencies above 3 GHz, the validity of tissue parameters (ϵ and σ) is restricted to ± 5%. The uncertainty is the RSS of the ConvF uncertainty for indicated target tissue parameters.

DASY/EASY - Parameters of Probe: EX3DV4 - SN:3650

Calibration Parameter Determined in Body Tissue Simulating Media

f (MHz) ^C	Relative Permittivity ^F	Conductivity (S/m) ^F	ConvF X	ConvF Y	ConvF Z	Alpha	Depth (mm)	Unct. (k=2)
750	55.5	0.96	9.21	9.21	9.21	0.78	0.69	± 12.0 %
835	55.2	0.97	9.12	9.12	9.12	0.79	0.67	± 12.0 %
1450	54.0	1.30	8.09	8.09	8.09	0.79	0.63	± 12.0 %
1750	53.4	1.49	7.49	7.49	7.49	0.79	0.64	± 12.0 %
1950	53.3	1.52	7.46	7.46	7.46	0.79	0.65	± 12.0 %
2450	52.7	1.95	6.89	6.89	6.89	0.79	0.60	± 12.0 %
2600	52.5	2.16	6.79	6.79	6.79	0.72	0.58	± 12.0 %
5200	49.0	5.30	4.28	4.28	4.28	0.50	1.95	± 13.1 %
5300	48.9	5.42	4.11	4.11	4.11	0.50	1.95	± 13.1 %
5500	48.6	5.65	3.73	3.73	3.73	0.60	1.95	± 13.1 %
5600	48.5	5.77	3.57	3.57	3.57	0.60	1.95	± 13.1 %
5800	48.2	6.00	3.81	3.81	3.81	0.60	1.95	± 13.1 %

^C Frequency validity of ± 100 MHz only applies for DASY v4.4 and higher (see Page 2), else it is restricted to ± 50 MHz. The uncertainty is the RSS of the ConvF uncertainty at calibration frequency and the uncertainty for the indicated frequency band.

^F At frequencies below 3 GHz, the validity of tissue parameters (ϵ and σ) can be relaxed to ± 10% if liquid compensation formula is applied to measured SAR values. At frequencies above 3 GHz, the validity of tissue parameters (ϵ and σ) is restricted to ± 5%. The uncertainty is the RSS of the ConvF uncertainty for indicated target tissue parameters.

Frequency Response of E-Field (TEM-Cell:ifi110 EXX, Waveguide: R22)

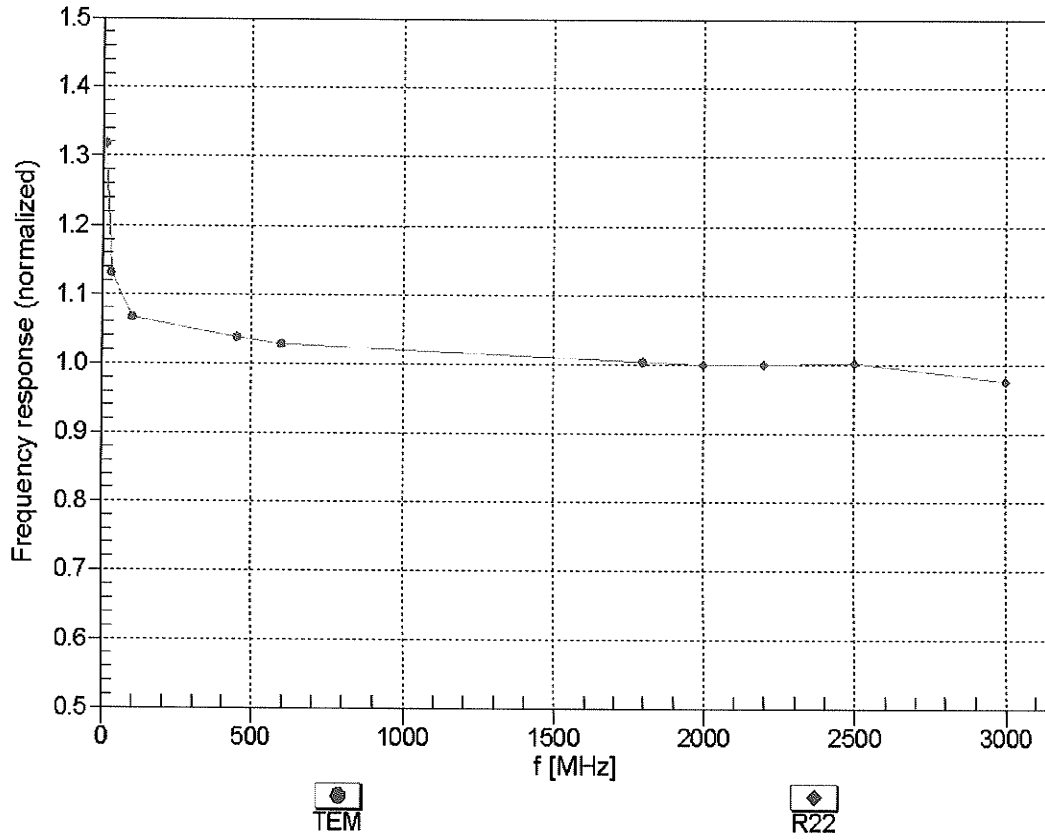

Uncertainty of Frequency Response of E-field: $\pm 6.3\%$ (k=2)

Receiving Pattern (ϕ), $\theta = 0^\circ$

f=600 MHz, TEM

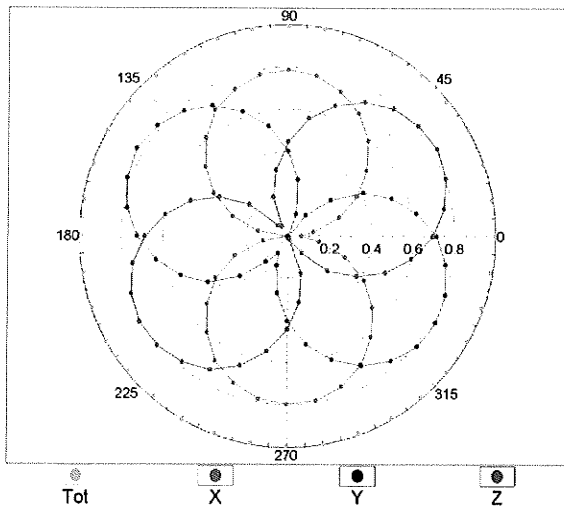

f=1800 MHz, R22

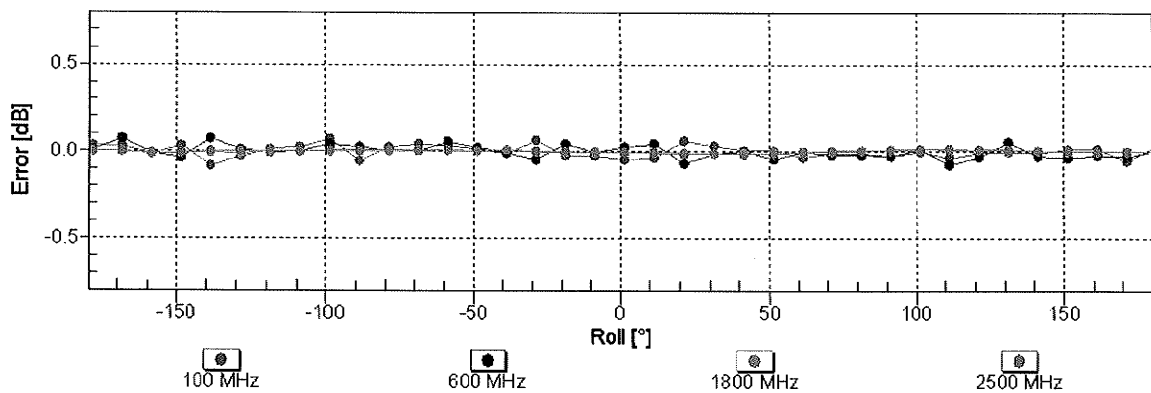
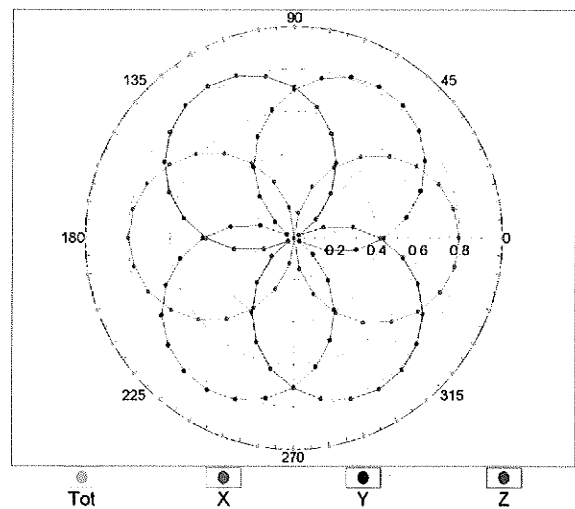

Uncertainty of Axial Isotropy Assessment: $\pm 0.5\%$ (k=2)

Dynamic Range $f(SAR_{head})$ (TEM cell, $f = 900$ MHz)

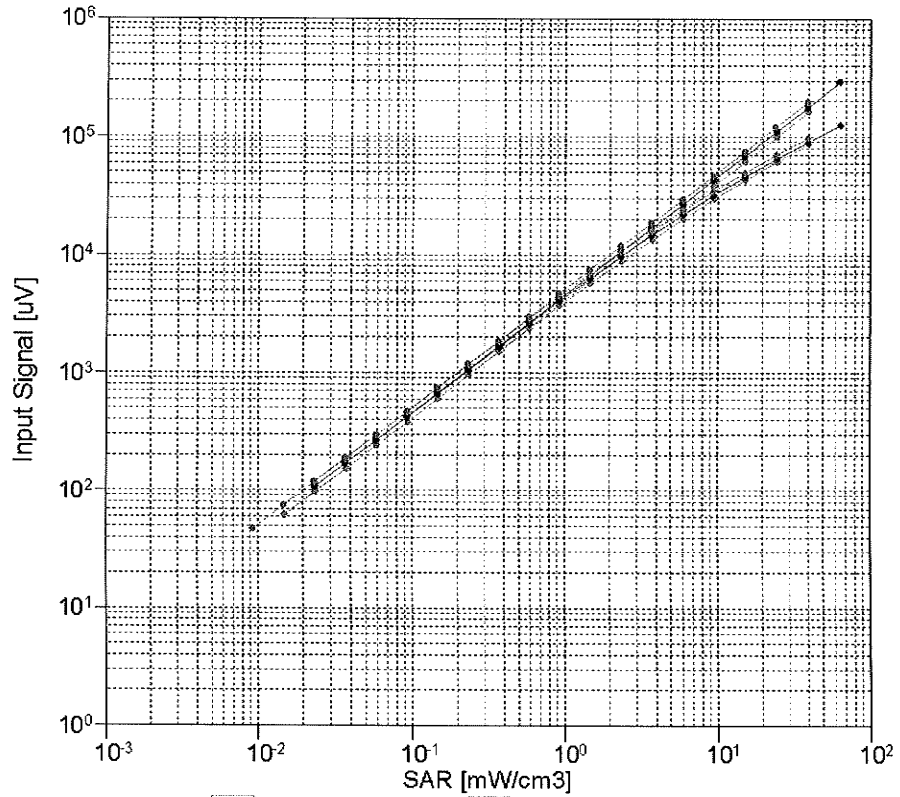

X compensated	X not compensated	Y compensated
Y not compensated	Z compensated	Z not compensated

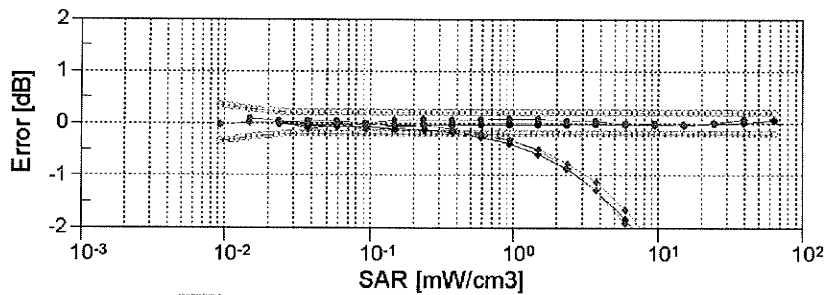

X compensated	X not compensated	Y compensated
Y not compensated	Z compensated	Z not compensated

Uncertainty of Linearity Assessment: $\pm 0.6\%$ ($k=2$)

Conversion Factor Assessment

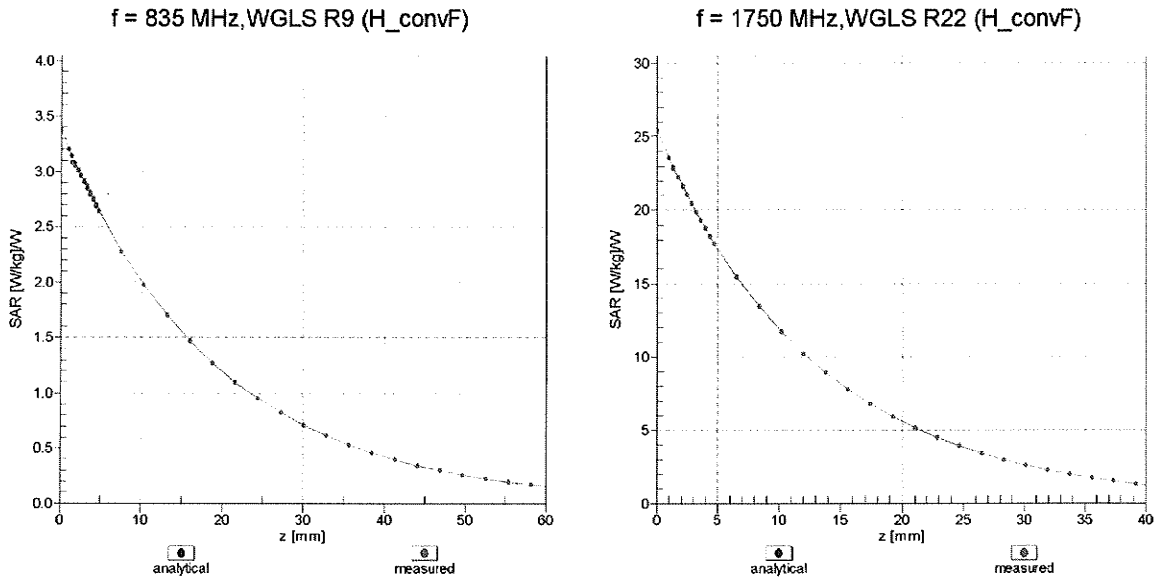

Deviation from Isotropy in Liquid

Error (ϕ, θ), f = 900 MHz

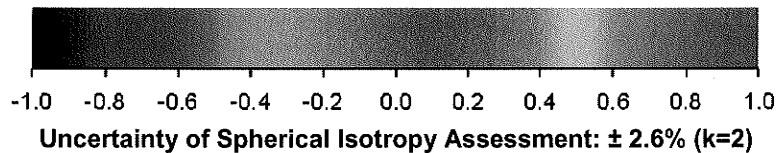
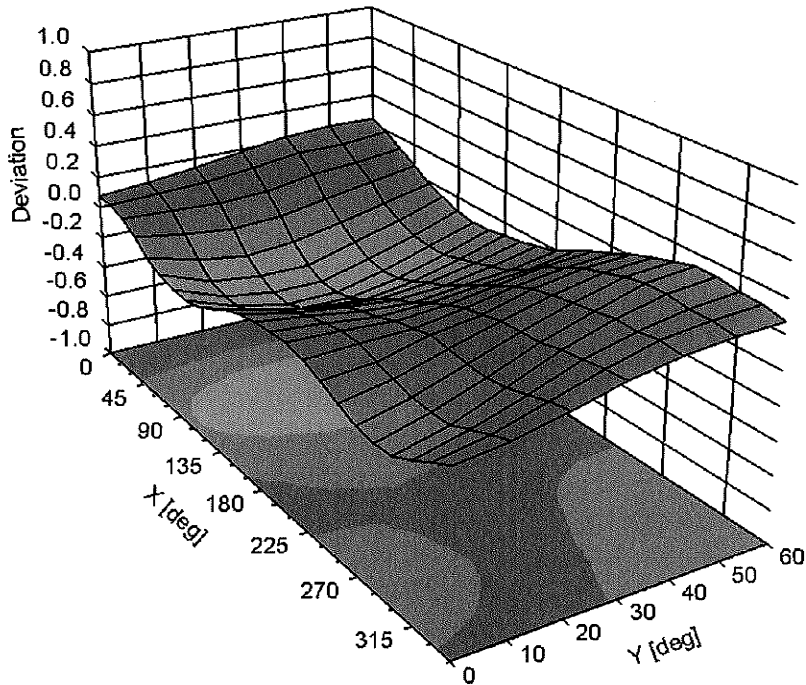

DASY/EASY - Parameters of Probe: EX3DV4 - SN:3650

Other Probe Parameters

Sensor Arrangement	Triangular
Connector Angle (°)	Not applicable
Mechanical Surface Detection Mode	enabled
Optical Surface Detection Mode	disabled
Probe Overall Length	337 mm
Probe Body Diameter	10 mm
Tip Length	9 mm
Tip Diameter	2.5 mm
Probe Tip to Sensor X Calibration Point	1 mm
Probe Tip to Sensor Y Calibration Point	1 mm
Probe Tip to Sensor Z Calibration Point	1 mm
Recommended Measurement Distance from Surface	2 mm



Accredited by the Swiss Accreditation Service (SAS)
The Swiss Accreditation Service is one of the signatories to the EA
Multilateral Agreement for the recognition of calibration certificates

Accreditation No.: **SCS 108**

Client **B.V. ADT (Auden)**

Certificate No: **EX3-3864_Jul12**

CALIBRATION CERTIFICATE

Object **EX3DV4 - SN:3864**

Calibration procedure(s) **QA CAL-01.v8, QA CAL-23.v4, QA CAL-25.v4
Calibration procedure for dosimetric E-field probes**

Calibration date: **July 19, 2012**

This calibration certificate documents the traceability to national standards, which realize the physical units of measurements (SI).
The measurements and the uncertainties with confidence probability are given on the following pages and are part of the certificate.

All calibrations have been conducted in the closed laboratory facility: environment temperature (22 ± 3)°C and humidity < 70%.

Calibration Equipment used (M&TE critical for calibration)

Primary Standards	ID	Cal Date (Certificate No.)	Scheduled Calibration
Power meter E4419B	GB41293874	29-Mar-12 (No. 217-01508)	Apr-13
Power sensor E4412A	MY41498087	29-Mar-12 (No. 217-01508)	Apr-13
Reference 3 dB Attenuator	SN: S5054 (3c)	27-Mar-12 (No. 217-01531)	Apr-13
Reference 20 dB Attenuator	SN: S5086 (20b)	27-Mar-12 (No. 217-01529)	Apr-13
Reference 30 dB Attenuator	SN: S5129 (30b)	27-Mar-12 (No. 217-01532)	Apr-13
Reference Probe ES3DV2	SN: 3013	29-Dec-11 (No. ES3-3013_Dec11)	Dec-12
DAE4	SN: 660	20-Jun-12 (No. DAE4-660_Jun12)	Jun-13
Secondary Standards	ID	Check Date (in house)	Scheduled Check
RF generator HP 8648C	US3642U01700	4-Aug-99 (in house check Apr-11)	In house check: Apr-13
Network Analyzer HP 8753E	US37390585	18-Oct-01 (in house check Oct-11)	In house check: Oct-12

Calibrated by:	Name Jeton Kastrat	Function Laboratory Technician	Signature
Approved by:	Name Katja Pokovic	Function Technical Manager	

Issued: July 20, 2012

This calibration certificate shall not be reproduced except in full without written approval of the laboratory.



Accredited by the Swiss Accreditation Service (SAS)

Accreditation No.: **SCS 108**

The Swiss Accreditation Service is one of the signatories to the EA
Multilateral Agreement for the recognition of calibration certificates

Glossary:

TSL	tissue simulating liquid
NORM _{x,y,z}	sensitivity in free space
ConvF	sensitivity in TSL / NORM _{x,y,z}
DCP	diode compression point
CF	crest factor (1/duty_cycle) of the RF signal
A, B, C	modulation dependent linearization parameters
Polarization φ	φ rotation around probe axis
Polarization ϑ	ϑ rotation around an axis that is in the plane normal to probe axis (at measurement center), i.e., $\vartheta = 0$ is normal to probe axis

Calibration is Performed According to the Following Standards:

- IEEE Std 1528-2003, "IEEE Recommended Practice for Determining the Peak Spatial-Averaged Specific Absorption Rate (SAR) in the Human Head from Wireless Communications Devices: Measurement Techniques", December 2003
- IEC 62209-1, "Procedure to measure the Specific Absorption Rate (SAR) for hand-held devices used in close proximity to the ear (frequency range of 300 MHz to 3 GHz)", February 2005

Methods Applied and Interpretation of Parameters:

- NORM_{x,y,z}**: Assessed for E-field polarization $\vartheta = 0$ ($f \leq 900$ MHz in TEM-cell; $f > 1800$ MHz: R22 waveguide). NORM_{x,y,z} are only intermediate values, i.e., the uncertainties of NORM_{x,y,z} does not affect the E²-field uncertainty inside TSL (see below *ConvF*).
- NORM(f)_{x,y,z} = NORM_{x,y,z} * frequency_response** (see Frequency Response Chart). This linearization is implemented in DASY4 software versions later than 4.2. The uncertainty of the frequency response is included in the stated uncertainty of *ConvF*.
- DCP_{x,y,z}**: DCP are numerical linearization parameters assessed based on the data of power sweep with CW signal (no uncertainty required). DCP does not depend on frequency nor media.
- PAR**: PAR is the Peak to Average Ratio that is not calibrated but determined based on the signal characteristics
- A_{x,y,z}; B_{x,y,z}; C_{x,y,z}; VR_{x,y,z}**: A, B, C are numerical linearization parameters assessed based on the data of power sweep for specific modulation signal. The parameters do not depend on frequency nor media. VR is the maximum calibration range expressed in RMS voltage across the diode.
- ConvF and Boundary Effect Parameters**: Assessed in flat phantom using E-field (or Temperature Transfer Standard for $f \leq 800$ MHz) and inside waveguide using analytical field distributions based on power measurements for $f > 800$ MHz. The same setups are used for assessment of the parameters applied for boundary compensation (alpha, depth) of which typical uncertainty values are given. These parameters are used in DASY4 software to improve probe accuracy close to the boundary. The sensitivity in TSL corresponds to NORM_{x,y,z} * ConvF whereby the uncertainty corresponds to that given for ConvF. A frequency dependent ConvF is used in DASY version 4.4 and higher which allows extending the validity from ± 50 MHz to ± 100 MHz.
- Spherical isotropy (3D deviation from isotropy)**: in a field of low gradients realized using a flat phantom exposed by a patch antenna.
- Sensor Offset**: The sensor offset corresponds to the offset of virtual measurement center from the probe tip (on probe axis). No tolerance required.

Probe EX3DV4

SN:3864

Manufactured: February 2, 2012
Calibrated: July 19, 2012

Calibrated for DASY/EASY Systems
(Note: non-compatible with DASY2 system!)

DASY/EASY - Parameters of Probe: EX3DV4 - SN:3864

Basic Calibration Parameters

	Sensor X	Sensor Y	Sensor Z	Unc (k=2)
Norm ($\mu\text{V}/(\text{V}/\text{m})^2$) ^A	0.47	0.44	0.49	$\pm 10.1 \%$
DCP (mV) ^B	97.6	98.0	97.9	

Modulation Calibration Parameters

UID	Communication System Name	PAR		A dB	B dB	C dB	VR mV	Unc ^E (k=2)
0	CW	0.00	X	0.00	0.00	1.00	154.8	$\pm 4.1 \%$
			Y	0.00	0.00	1.00	146.9	
			Z	0.00	0.00	1.00	162.0	

The reported uncertainty of measurement is stated as the standard uncertainty of measurement multiplied by the coverage factor $k=2$, which for a normal distribution corresponds to a coverage probability of approximately 95%.

^A The uncertainties of NormX,Y,Z do not affect the E^2 -field uncertainty inside TSL (see Pages 5 and 6).

^B Numerical linearization parameter: uncertainty not required.

^E Uncertainty is determined using the max. deviation from linear response applying rectangular distribution and is expressed for the square of the field value.

DASY/EASY - Parameters of Probe: EX3DV4 - SN:3864

Calibration Parameter Determined in Head Tissue Simulating Media

f (MHz) ^C	Relative Permittivity ^F	Conductivity (S/m) ^F	ConvF X	ConvF Y	ConvF Z	Alpha	Depth (mm)	Unct. (k=2)
835	41.5	0.90	9.80	9.80	9.80	0.58	0.65	± 12.0 %
1750	40.1	1.37	8.56	8.56	8.56	0.43	0.82	± 12.0 %
1900	40.0	1.40	8.13	8.13	8.13	0.42	0.79	± 12.0 %
2450	39.2	1.80	7.28	7.28	7.28	0.43	0.80	± 12.0 %

^C Frequency validity of ± 100 MHz only applies for DASY v4.4 and higher (see Page 2), else it is restricted to ± 50 MHz. The uncertainty is the RSS of the ConvF uncertainty at calibration frequency and the uncertainty for the indicated frequency band.

^F At frequencies below 3 GHz, the validity of tissue parameters (ϵ and σ) can be relaxed to ± 10% if liquid compensation formula is applied to measured SAR values. At frequencies above 3 GHz, the validity of tissue parameters (ϵ and σ) is restricted to ± 5%. The uncertainty is the RSS of the ConvF uncertainty for indicated target tissue parameters.

DASY/EASY - Parameters of Probe: EX3DV4 - SN:3864

Calibration Parameter Determined in Body Tissue Simulating Media

f (MHz) ^C	Relative Permittivity ^F	Conductivity (S/m) ^F	ConvF X	ConvF Y	ConvF Z	Alpha	Depth (mm)	Unct. (k=2)
835	55.2	0.97	9.94	9.94	9.94	0.58	0.72	± 12.0 %
1750	53.4	1.49	8.45	8.45	8.45	0.41	0.87	± 12.0 %
1900	53.3	1.52	7.88	7.88	7.88	0.48	0.77	± 12.0 %
2450	52.7	1.95	7.49	7.49	7.49	0.80	0.50	± 12.0 %

^C Frequency validity of ± 100 MHz only applies for DASY v4.4 and higher (see Page 2), else it is restricted to ± 50 MHz. The uncertainty is the RSS of the ConvF uncertainty at calibration frequency and the uncertainty for the indicated frequency band.

^F At frequencies below 3 GHz, the validity of tissue parameters (ϵ and σ) can be relaxed to ± 10% if liquid compensation formula is applied to measured SAR values. At frequencies above 3 GHz, the validity of tissue parameters (ϵ and σ) is restricted to ± 5%. The uncertainty is the RSS of the ConvF uncertainty for indicated target tissue parameters.

Frequency Response of E-Field (TEM-Cell:ifi110 EXX, Waveguide: R22)

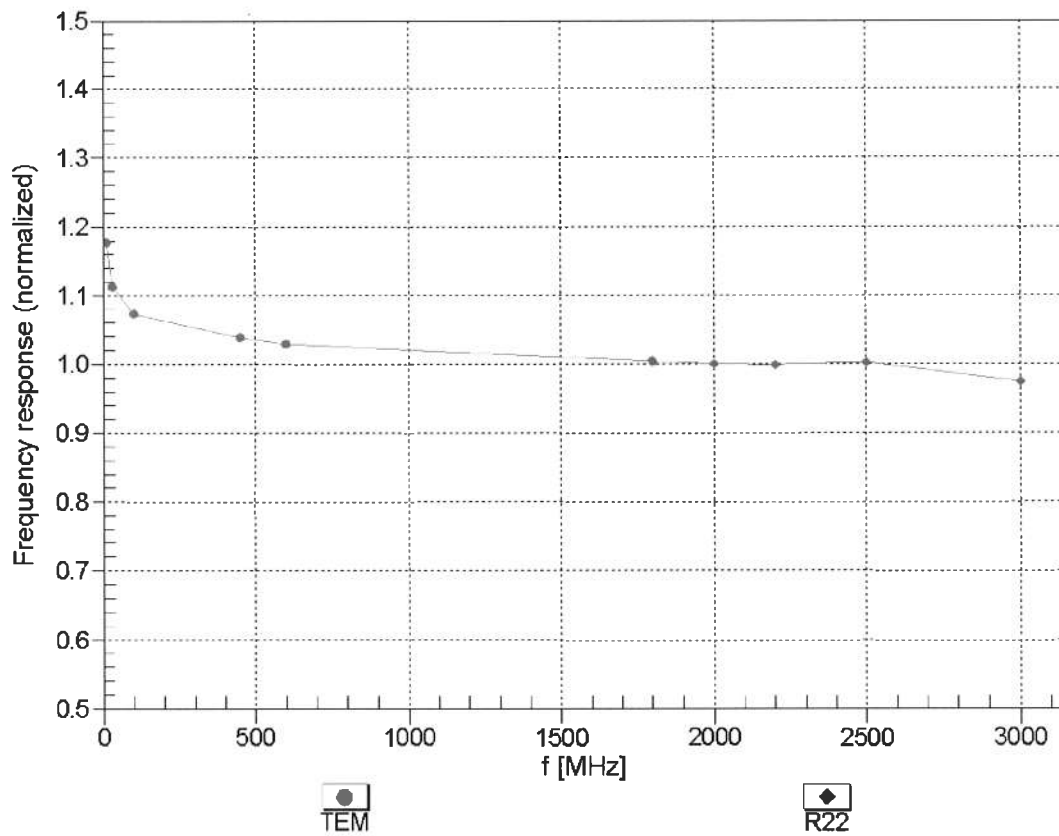

Uncertainty of Frequency Response of E-field: $\pm 6.3\%$ (k=2)

Receiving Pattern (ϕ), $\vartheta = 0^\circ$

f=600 MHz,TEM

f=1800 MHz,R22

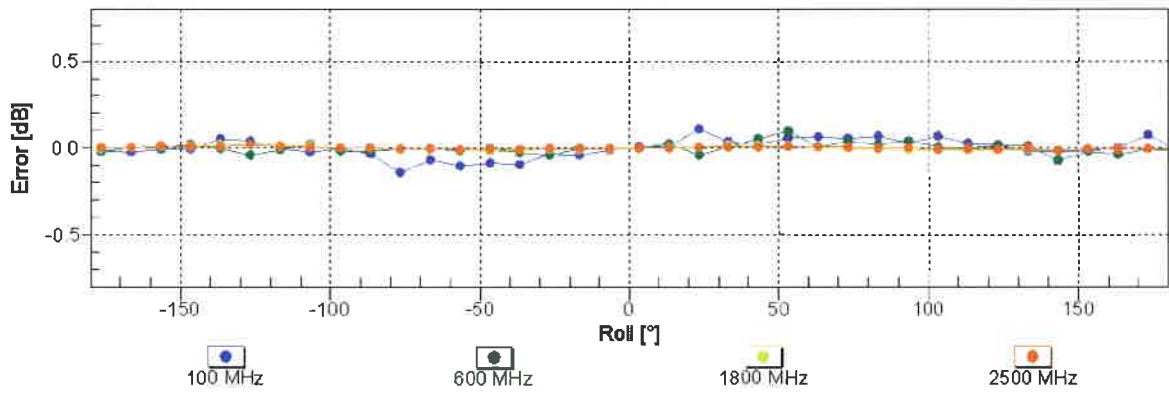
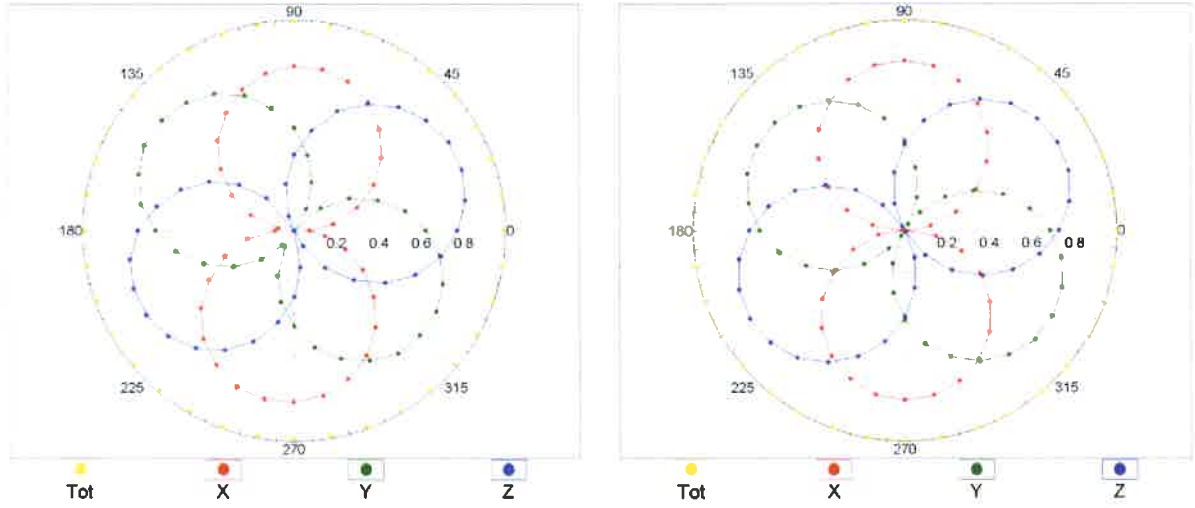

Uncertainty of Axial Isotropy Assessment: $\pm 0.5\%$ (k=2)

Dynamic Range f(SAR_{head}) (TEM cell , f = 900 MHz)

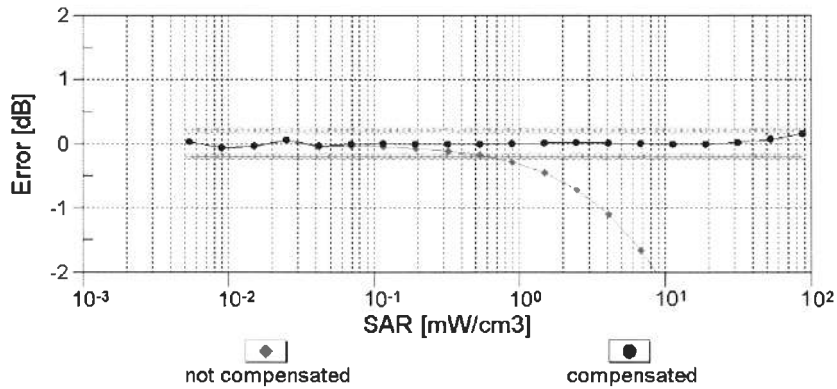
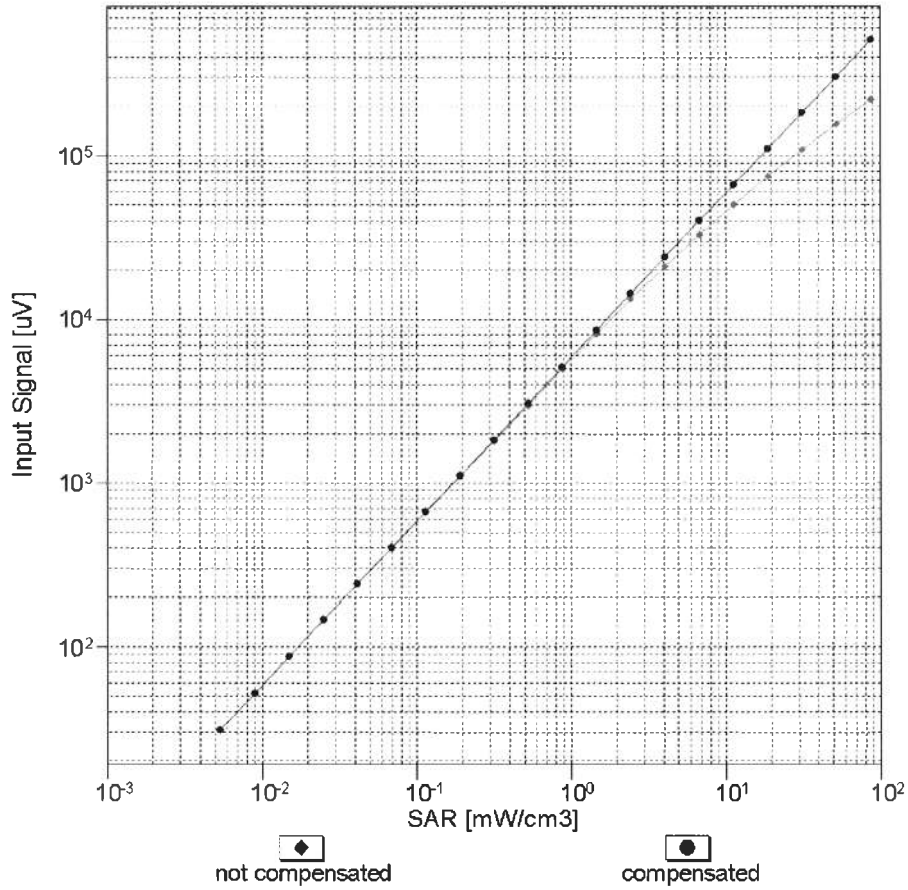

Uncertainty of Linearity Assessment: ± 0.6% (k=2)

Conversion Factor Assessment

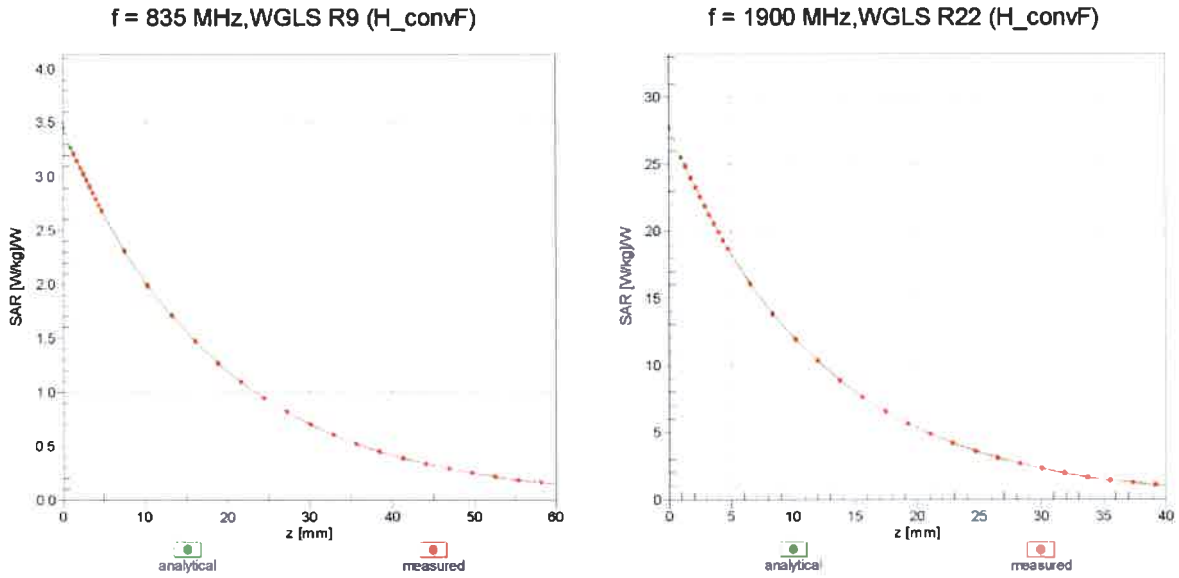

Deviation from Isotropy in Liquid Error (ϕ, ϑ), f = 900 MHz

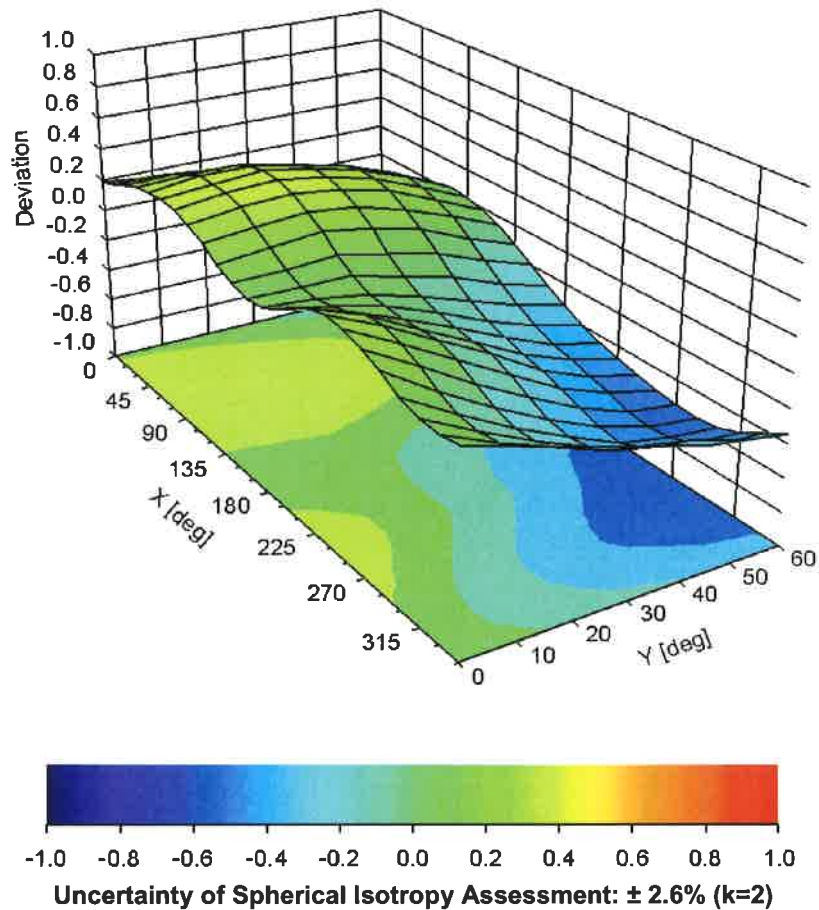

DASY/EASY - Parameters of Probe: EX3DV4 - SN:3864

Other Probe Parameters

Sensor Arrangement	Triangular
Connector Angle (°)	63.3
Mechanical Surface Detection Mode	enabled
Optical Surface Detection Mode	disabled
Probe Overall Length	337 mm
Probe Body Diameter	10 mm
Tip Length	9 mm
Tip Diameter	2.5 mm
Probe Tip to Sensor X Calibration Point	1 mm
Probe Tip to Sensor Y Calibration Point	1 mm
Probe Tip to Sensor Z Calibration Point	1 mm
Recommended Measurement Distance from Surface	2 mm



Appendix D. Photographs of EUT and Setup