

## RF Test Report

Applicant : Getac Technology Corporation  
Product Name : Radio Module  
Trade Name : Telit  
Model Number : LN920A12-WW  
Applicable Standard : FCC 47 CFR PART 22H  
FCC 47 CFR PART 24E  
FCC 47 CFR PART 27  
FCC 47 CFR PART 90S  
FCC 47 CFR PART 90R  
FCC 47 CFR PART 96  
ANSI C63.26 2015  
  
Received Date : Oct. 31, 2023  
Test Period : Dec. 27, 2023  
Issued Date : Mar. 06, 2024

### Issued by

Eurofins E&E Wireless Taiwan Co., Ltd.  
No. 140-1, Changan Street, Bade District,  
Taoyuan City 334025, Taiwan (R.O.C.)  
Tel : +886-3-2710188 / Fax : +886-3-2710190



Taiwan Accreditation Foundation accreditation number: 1330  
Frequency Range: 9 kHz to 325 GHz (Bade test site)  
Bade test site :  
Test Firm Registration Number: 226252  
Test Firm Designation Number: TW0010  
Wugu test site :  
Test Firm Registration Number: 191812  
Test Firm Designation Number: TW0034

### Note:

- 1.The test results are valid only for samples provided by customers and under the test conditions described in this report.
- 2.This report shall not be reproduced except in full, without the written approval of Eurofins E&E Wireless Taiwan Co., Ltd.
- 3.The relevant information is provided by customers in this test report. According to the correctness, appropriateness or completeness of the information provided by the customer, if there is any doubt or error in the information which affects the validity of the test results, the laboratory does not take the responsibility.

### Revision History

Rev.	Issued Date	Description	Revised by
00	Mar. 06, 2024	Initial Issue	Snow Wang

## Verification of Compliance

Applicant : Getac Technology Corporation  
 Product Name : Radio Module  
 Trade Name : Telit  
 Model Number : LN920A12-WW  
 FCC ID : QYLLN920ZX8  
 Applicable Standard : FCC 47 CFR PART 22H  
 FCC 47 CFR PART 24E  
 FCC 47 CFR PART 27  
 FCC 47 CFR PART 90S  
 FCC 47 CFR PART 90R  
 FCC 47 CFR PART 96  
 ANSI C63.26 2015

Test Result : Complied

Performing Lab. : Eurofins E&E Wireless Taiwan Co., Ltd.  
 No. 140-1, Changan Street, Bade District,  
 Taoyuan City 334025, Taiwan (R.O.C.)  
 Tel : +886-3-2710188 / Fax : +886-3-2710190  
Taiwan Accreditation Foundation accreditation number: 1330



Eurofins E&E Wireless Taiwan Co., Ltd. tested the above equipment in accordance with the requirements set forth in the above standards. All indications of Pass/Fail in this report are opinions expressed by Eurofins E&E Wireless Taiwan Co., Ltd. based on interpretations and/or observations of test results. The test results show that the equipment tested is capable of demonstrating compliance with the requirements as documented in this report.

Approved By : \_\_\_\_\_

## TABLE OF CONTENTS

<b>1</b>	<b>General Information</b> .....	<b>5</b>
1.1.	Summary of Test Result.....	5
1.2.	Testing Location.....	6
1.3.	Measurement Uncertainty.....	6
1.4.	Test Site Environment.....	6
<b>2</b>	<b>EUT Description</b> .....	<b>7</b>
2.1.	Mode of Operation.....	9
2.2.	EUT Test Step.....	9
2.3.	Configuration of Test System Details.....	9
2.4.	Test Instruments.....	10
<b>3</b>	<b>Measurement Procedure</b> .....	<b>12</b>
3.1.	Radiated Emission Test.....	12
<b>4</b>	<b>Test Results</b> .....	<b>14</b>
4.1.	Radiated Emission.....	14

### Appendix A. Test Setup Photographs

# 1 General Information

## 1.1. Summary of Test Result

FCC Rule	Description	Result
§2.1046	Conducted Output Average Power	N/A (Note 1)
§22.913 §24.232 §27. 50 §90.542(Part 90R) §90.635(Part 90S) §96.41(b)	Equivalent Isotropic Radiated Power / Equivalent Radiated Power	N/A (Note 1)
§2.1055 §22.355 §24.235 §27. 54	Frequency Stability	N/A (Note 1)
§2.1049	Emission Bandwidth & Occupied Bandwidth	N/A (Note 1)
§24.232 §27.50 §96.41(g)	Peak to average ratio	N/A (Note 1)
§2.1051 §22.917 §24.238 §27.53 §90.543(Part 90R) §96.41(e)	Band Edge	N/A (Note 1)
§2.1051 §22.917 §24.238 §27.53 §90.543(Part 90R) §96.41(e)	Conducted Spurious Emissions	N/A (Note 1)
§2.1053 §22.917 §24.238 §27.53 §90.543(Part 90R) §96.41(e)	Radiated Spurious Emissions	Pass (Note 2)

Note 1: No need for verification.

Note 2: Only verify the Simultaneous Transmission.

### Decision Rule

- Uncertainty is not included.
- Uncertainty is included.

## 1.2. Testing Location

Lab Name: Eurofins E&E Wireless Taiwan Co., Ltd.

Site Address:  No. 140-1, Changan Street, Bade District, Taoyuan City 334025, Taiwan (R.O.C.)

Site Address:  No. 2, Wuquan 5th Rd. Wugu Dist., New Taipei City, Taiwan (R.O.C.)

## 1.3. Measurement Uncertainty

Parameter	Uncertainty			
	96601-BD	96603-BD	96602-WG	96603-WG
Radiated Emission	4.9 dB	4.9 dB	4.9 dB	4.9 dB

## 1.4. Test Site Environment

Items	Required (IEC 68-1)	Interval(*)
Temperature (°C)	15-35	20-30
Humidity (%RH)	25-75	45-75

(\*)The measurement ambient temperature is within this range.

## 2 EUT Description

The product specifications of the EUT presented in the report are declared by the manufacturer who shall take full responsibility for the authenticity(except E.R.P. /E.I.R.P., Occupied Bandwidth, Emission Designator).

Applicant	Getac Technology Corporation 5F., Building A, No. 209, Sec. 1, Nangang Rd., Nangang Dist., Taipei City, 115018, Taiwan		
Product Name	Radio Module		
Trade Name	Telit		
Model Number	LN920A12-WW		
FCC ID	QYLLN920ZX8		
Host Information	Product Name: Tablet Trade Name: Getac Model Name: ZX80		
IMEI No.	358989890011010		
Operate Band	Frequency Range (MHz)	Modulation	Channel Bandwidth
LTE Band 2	UL: 1850 ~ 1910	QPSK, 16QAM, 64QAM, 256QAM	1.4 MHz, 3 MHz, 5 MHz, 10 MHz, 15 MHz, 20 MHz
	DL: 1930 ~ 1990		
LTE Band 4	UL: 1710 ~ 1755		1.4 MHz, 3 MHz, 5 MHz, 10 MHz, 15 MHz, 20 MHz
	DL: 2110 ~ 2155		
LTE Band 5	UL: 824 ~ 849		1.4 MHz, 3 MHz, 5 MHz, 10 MHz
	DL: 869 ~ 894		
LTE Band 7	UL: 2500 ~ 2570		5 MHz, 10 MHz, 15 MHz, 20 MHz
	DL: 2620 ~ 2690		
LTE Band 12	UL: 699 ~ 716		1.4 MHz, 3 MHz, 5 MHz, 10 MHz
	DL: 728 ~ 746		
LTE Band 13	UL: 777 ~ 787		5 MHz, 10 MHz
	DL: 746 ~ 756		
LTE Band 14	UL: 788 ~ 798		5 MHz, 10 MHz
	DL: 758 ~ 768		
LTE Band 25	UL: 1850 ~ 1915		1.4 MHz, 3 MHz, 5 MHz, 10 MHz, 15 MHz, 20 MHz
	DL: 1930 ~ 1995		
LTE Band 26(Part 22)	UL: 824 ~ 849	1.4 MHz, 3 MHz, 5 MHz, 10 MHz, 15 MHz	
	DL: 824 ~ 849		
LTE Band 26(Part 90S)	UL: 817 ~ 824	1.4 MHz, 3 MHz, 5 MHz, 10 MHz	
	DL: 817 ~ 824		
LTE Band 30(RX only)	DL: 2305 ~ 2315	5 MHz, 10 MHz	

LTE Band 38	UL/DL: 2570 ~ 2620	QPSK, 16QAM, 64QAM, 256QAM	5 MHz, 10 MHz, 15 MHz, 20 MHz
LTE Band 41	UL/DL: 2496 ~ 2690		5 MHz, 10 MHz, 15 MHz, 20 MHz
LTE Band 48	UL/DL: 3550 ~ 3700		5 MHz, 10 MHz, 15 MHz, 20 MHz
LTE Band 66	UL: 1710 ~ 1780		1.4 MHz, 3 MHz, 5 MHz, 10 MHz, 15 MHz, 20 MHz
	DL: 2110 ~ 2200		
LTE Band 71	UL: 663 ~ 698	5 MHz, 10 MHz, 15 MHz, 20 MHz	
	DL: 617 ~ 652		
Antenna information	Type	Max. Gain (dBi)	
	PIFA Antenan	LTE Band 2	2.3
		LTE Band 4	2.31
		LTE Band 5	0.96
		LTE Band 7	2.6
		LTE Band 12	1.31
		LTE Band 13	1.35
		LTE Band 14	1.43
		LTE Band 25	2.30
		LTE Band 26	1.01
		LTE Band 38	2.6
		LTE Band 41	2.61
		LTE Band 48	2.66
LTE Band 66	2.31		
LTE Band 71	0.77		
Operate Temp. Range	-10 ~ +50 °C		
EUT Power Rating	DC 12 V, 3 A		

EUT Modify Description :

Modify Description: Add host model: ZX80.  After our evaluation, the retest of Radiated Emissions Below 1GHz and Simultaneous Transmitter of Spurious Radiated are required. The other test data refer to the original report.
--



## 2.1. Mode of Operation

Eurofins has verified the construction and function in typical operation. All the test modes were carried out with the EUT in normal operation, which was shown in this test report and defined as:

Test Mode
Co-location

## 2.2. EUT Test Step

1	Setup the EUT shown on "Configuration of Test System Details".
2	Turn on the power of all equipment.
3	EUT run test program test.

## 2.3. Configuration of Test System Details

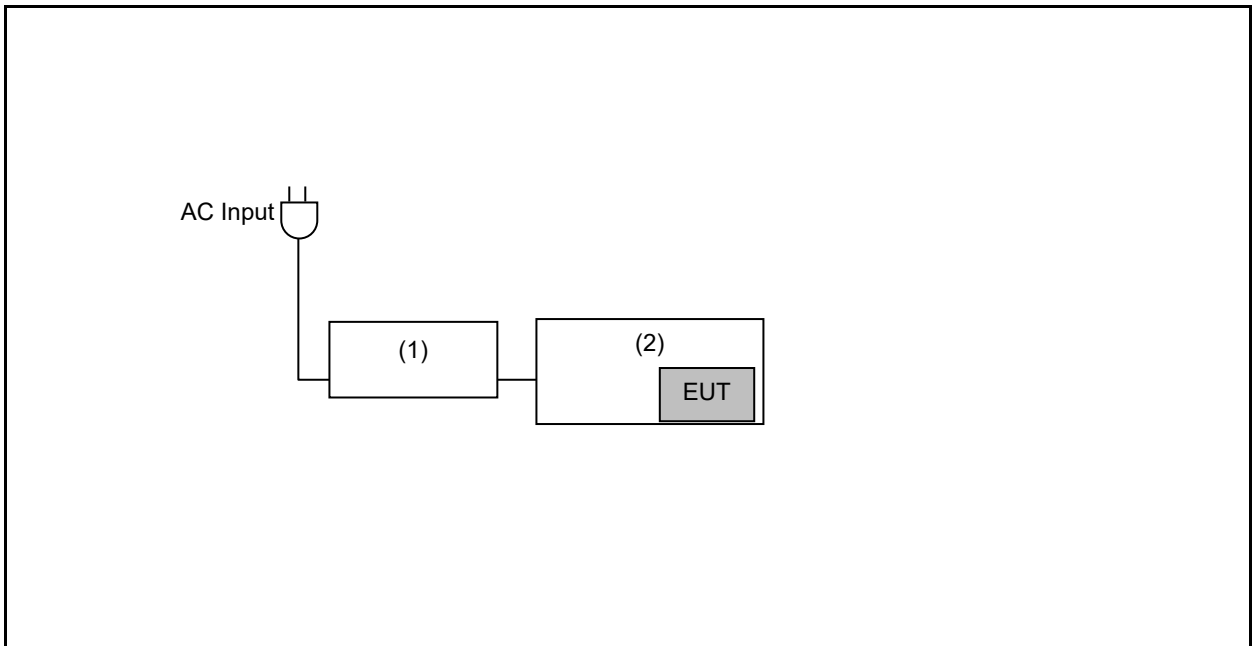

Devices Description					
	Product	Manufacturer	Model Number	Serial Number	Power Cord
(1)	Adapter	FSP	FSP065-D3MR3C	---	---
(2)	Tablet	Getac	ZX80	---	---

## 2.4. Test Instruments

For Radiated Emissions

Test Period: Dec. 27, 2023

Testing Engineer: Jason Yeh

Radiation test sites		Semi Anechoic Room 96603-WG				
Use	Equipment	Manufacturer	Model Number	Serial Number	Cal. Date	Cal. Period
<input checked="" type="checkbox"/>	LOOP Antenna (9 kHz~30 MHz)	Schwarzbeck Mess-Elektronik	FMZB 1513-60	00031	Feb. 21, 2023	1 year
<input checked="" type="checkbox"/>	Trilog Broadband Antenna (30 MHz~1 GHz)	Schwarzbeck Mess-Elektronik	VULB9168	1276	Feb. 09, 2023	1 year
<input checked="" type="checkbox"/>	Broadband Horn Antenna (1 GHz~18 GHz)	RF SPIN	DRH18-E	210307A18ES	Dec. 22, 2022	1 year
<input checked="" type="checkbox"/>	Broadband Horn Antenna (15 GHz~40 GHz)	Schwarzbeck Mess-Elektronik	BBHA9170	1133	Feb. 13, 2023	1 year
<input checked="" type="checkbox"/>	Spectrum Analyzer (2 Hz~50 GHz)	KEYSIGHT	N9030B	MY57153537	Apr. 18, 2023	1 year
<input checked="" type="checkbox"/>	Pre-Amplifier	EMCI	EMC001330	980859	Nov. 01, 2022	1 year
<input checked="" type="checkbox"/>	Pre-Amplifier	EMCI	EMC118A45SE	980818	Dec. 15, 2022	1 year
<input checked="" type="checkbox"/>	Pre-Amplifier	EMCI	EMC184045SE	980861	Dec. 15, 2022	1 year
<input checked="" type="checkbox"/>	Coaxial Cable (10 kHz~3000 MHz)	EMCI	EMCCFD400-NM-NM-2000	211009	Dec. 28, 2022	1 year
<input checked="" type="checkbox"/>	Coaxial Cable (10 kHz~3000 MHz)	EMCI	EMCCFD400-NM-NM-2000	211010	Dec. 28, 2022	1 year
<input checked="" type="checkbox"/>	Coaxial Cable (10 kHz~3000 MHz)	EMCI	EMCCFD400-NM-NM-6000	211018	Dec. 28, 2022	1 year
<input checked="" type="checkbox"/>	Coaxial Cable (1 GHz~18 GHz)	EMCI	EMC104-SM-SM-1000	211029	Dec. 28, 2022	1 year
<input checked="" type="checkbox"/>	Coaxial Cable (1 GHz~18 GHz)	EMCI	EMC104-SM-SM-2000	211033	Dec. 28, 2022	1 year
<input checked="" type="checkbox"/>	Coaxial Cable (1 GHz~18 GHz)	EMCI	EMC104-SM-SM-8000	211038	Dec. 28, 2022	1 year
<input checked="" type="checkbox"/>	Coaxial Cable (18GHz~40GHz)	EMCI	EMC101G-KM-KM-600	211211	Jan. 17, 2023	1 year

Note: N.C.R. = No Calibration Request

For Radiated Emissions  
 Test Period: Dec. 27, 2023  
 Testing Engineer: Jason Yeh

Radiation test sites		Semi Anechoic Room 96603-WG				
Use	Equipment	Manufacturer	Model Number	Serial Number	Cal. Date	Cal. Period
<input checked="" type="checkbox"/>	Coaxial Cable (18GHz~40GHz)	EMCI	EMC101G-KM- KM-2000	211210	Jan. 17, 2023	1 year
<input checked="" type="checkbox"/>	Coaxial Cable (18GHz~40GHz)	EMCI	EMC101G-KM- KM-6000	211209	Jan. 17, 2023	1 year
<input checked="" type="checkbox"/>	Highpass Filter	Warison	STI15-9796	001	Nov. 13, 2023	1 year
<input checked="" type="checkbox"/>	Highpass Filter	Warison	WFIL-H3000- 20000F	WR4BBFWC2B1	Nov. 13, 2023	1 year
<input checked="" type="checkbox"/>	Highpass Filter	Warison	WFIL-H8000- 26000F	001	Nov. 13, 2023	1 year
<input checked="" type="checkbox"/>	Software	R_RAM	V1.3	N/A	N.C.R.	---

Note: N.C.R. = No Calibration Request

### 3 Measurement Procedure

#### 3.1. Radiated Emission Test

■ Limit

The power of any emission outside a licensee's frequency block shall be attenuated below the transmitter power (P) by at least  $43 + 10 \log_{10}(P)$  dB. The limit of emission equal to -13 dBm

■ Setup

Below 1 GHz

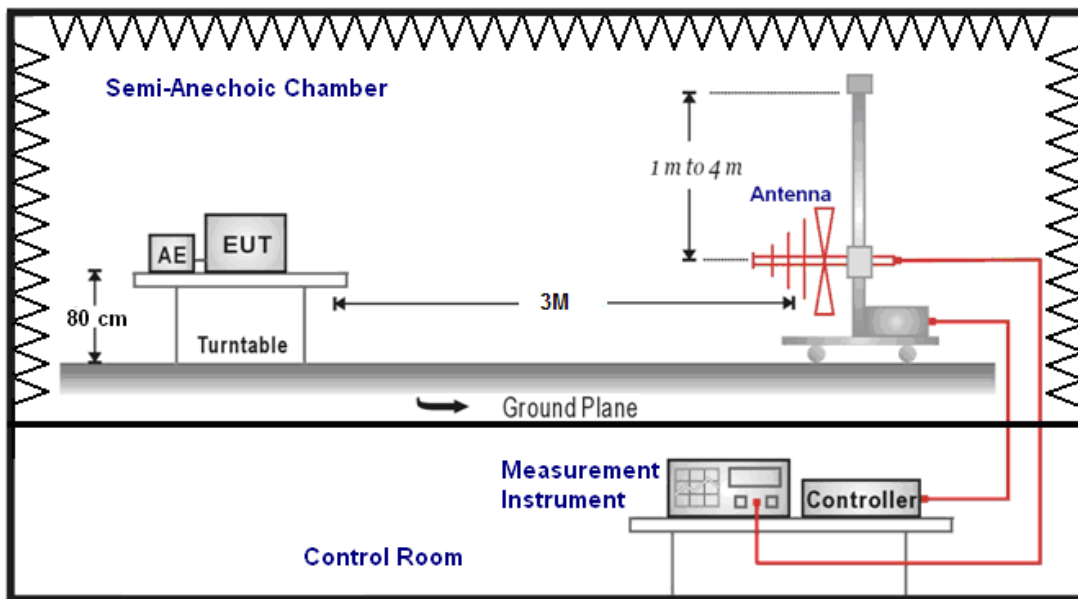

Above 1 GHz

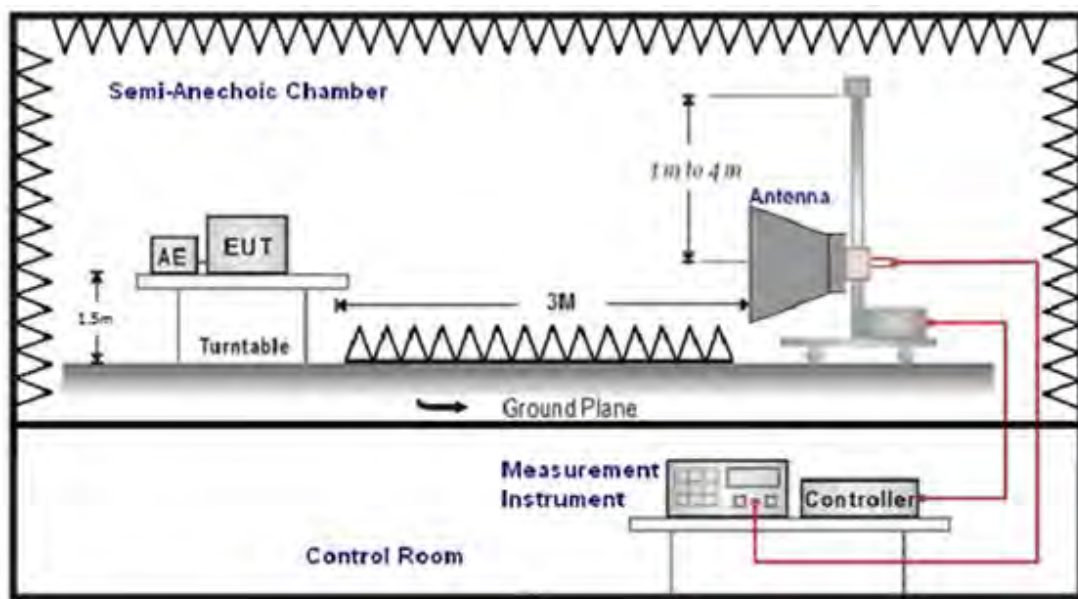

For Substituted Method Test Set-UP

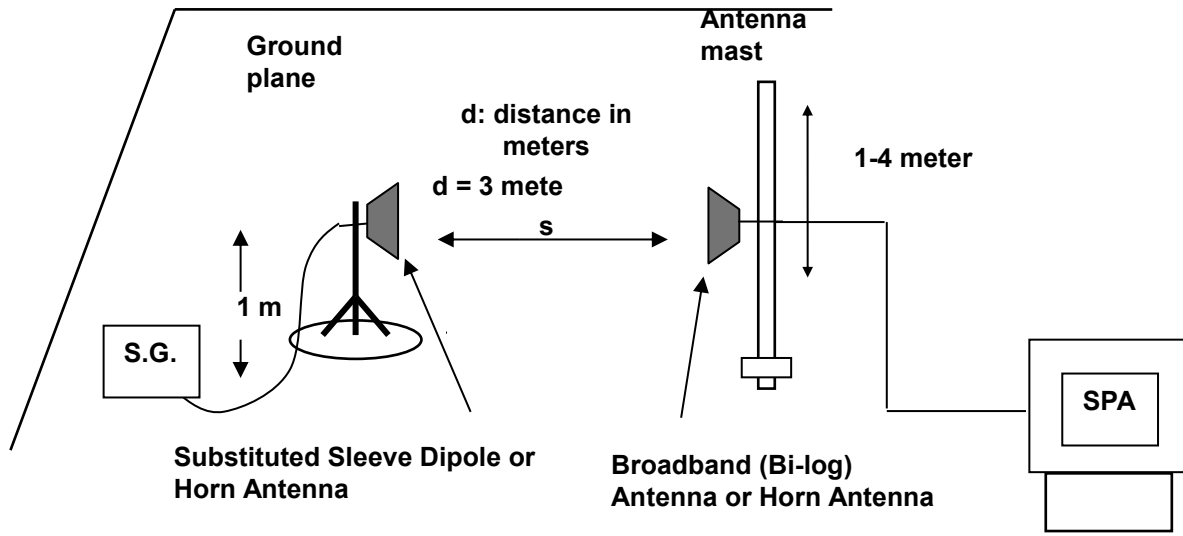

■ Test Procedure

- a. The EUT was set up for the maximum power with WWAN link data modulation. The power was measured with Spectrum Analyzer. All measurements were done at 3 channels (low, middle and high operational frequency range).
- b. Radiation Emission measurement. In the semi-anechoic chamber, EUT placed on the 0.8 m (1.5 m for above 1 GHz) height of Turn Table, rotated the table around 360 degrees to search the maximum radiation power and receiver antenna shall be rotated vertical and horizontal polarization and moved height from 1 m to 4 m to find the maximum polar radiated power. The “Read Value” is the spectrum reading the maximum power value.
- c. The substitution antenna (Note:1 & 2) is substituted for EUT at the same position and signals generator export the CW signal to the substitution antenna via a TX cable. Rotated the Turn Table and moved receiving antenna to find the maximum radiation power. Adjust output power level of S.G to get a Value of spectrum reading equal to “Read Value” of step a. Record the power level of S.G.
- d. E.I.R.P. = Output power level of S.G - TX cable loss + Antenna gain of substitution horn
- e. E.R.P. = E.I.R.P- 2.15 dB
- f. Measurement range 9 kHz - 10 th Harmonic

Note: 1. Below 1 GHz Substituted Method Test : Sleeve dipole antenna to Bi-Log Antenna

2. Above 1 GHz Substituted Method Test : Horn antenna to Horn Antenna

## 4 Test Results

### 4.1. Radiated Emission

Test Site:	96603-WG	Standard:	Part 22_24_27_90_96
Test Mode:	Normal Operation		
Polarization:	Horizontal		
Remark:			

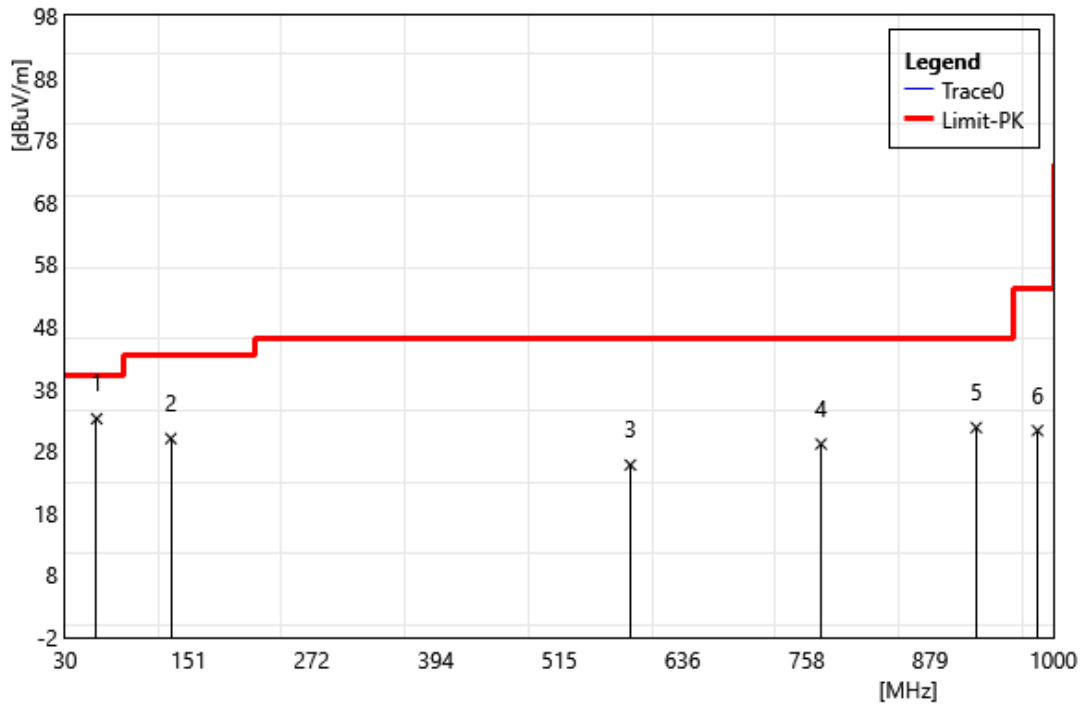

ID	Frequency MHz	Reading dBuV	Correct Factor dB/m	Result dBuV/m	Limit dBuV/m	Margin dB	Remark
1	61.04	46.05	-12.88	33.17	40.00	-6.83	QP
2	133.79	43.31	-13.33	29.98	43.50	-13.53	QP
3	584.84	31.23	-5.49	25.74	46.00	-20.26	QP
4	772.05	31.30	-2.19	29.11	46.00	-16.89	QP
5	924.34	31.96	-0.22	31.74	46.00	-14.26	QP
6	984.48	31.20	0.07	31.27	54.00	-22.73	QP

Test Site:	96603-WG	Standard:	Part 22_24_27_90_96
Test Mode:	Normal Operation		
Polarization:	Vertical		
Remark:			

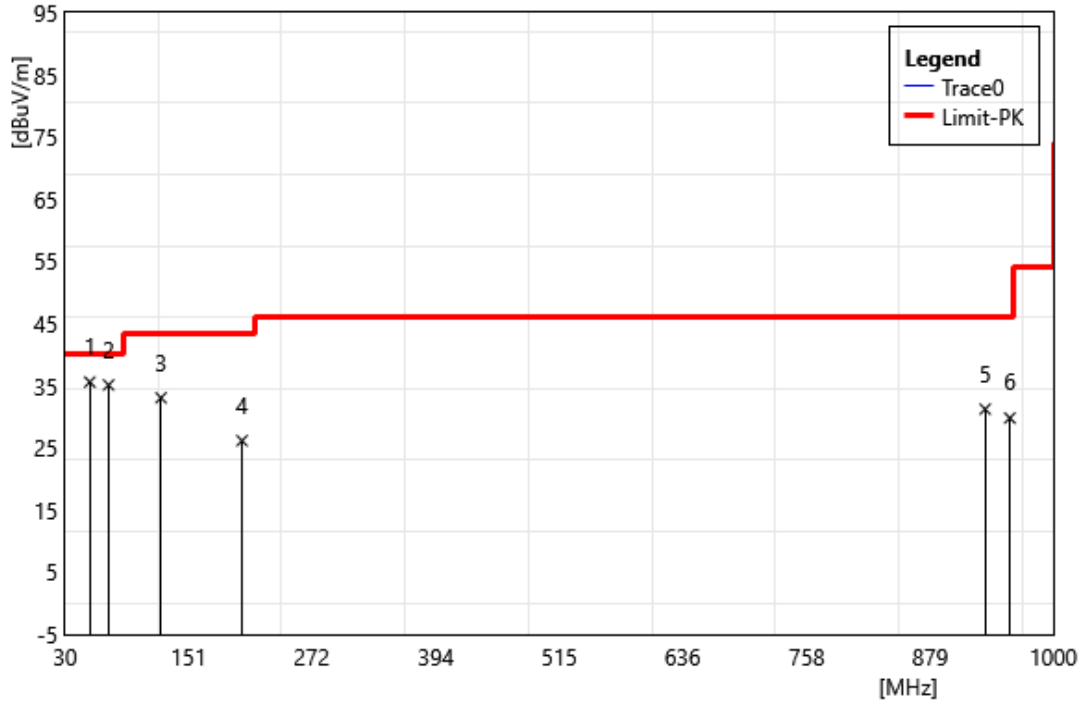

ID	Frequency MHz	Reading dBuV	Correct Factor dB/m	Result dBuV/m	Limit dBuV/m	Margin dB	Remark
1	54.25	47.91	-12.32	35.59	40.00	-4.41	QP
2	72.68	50.13	-15.01	35.12	40.00	-4.88	QP
3	124.09	47.26	-14.21	33.05	43.50	-10.45	QP
4	203.63	41.38	-15.22	26.16	43.50	-17.34	QP
5	933.07	31.23	0.00	31.23	46.00	-14.77	QP
6	957.32	29.56	0.25	29.81	46.00	-16.20	QP

Test Site:	96603-WG	Standard:	Part 22_24_27_90_96
Test Mode:	Co-location		
Polarization:	Horizontal		
Remark:	LTE+BT+2.4G		

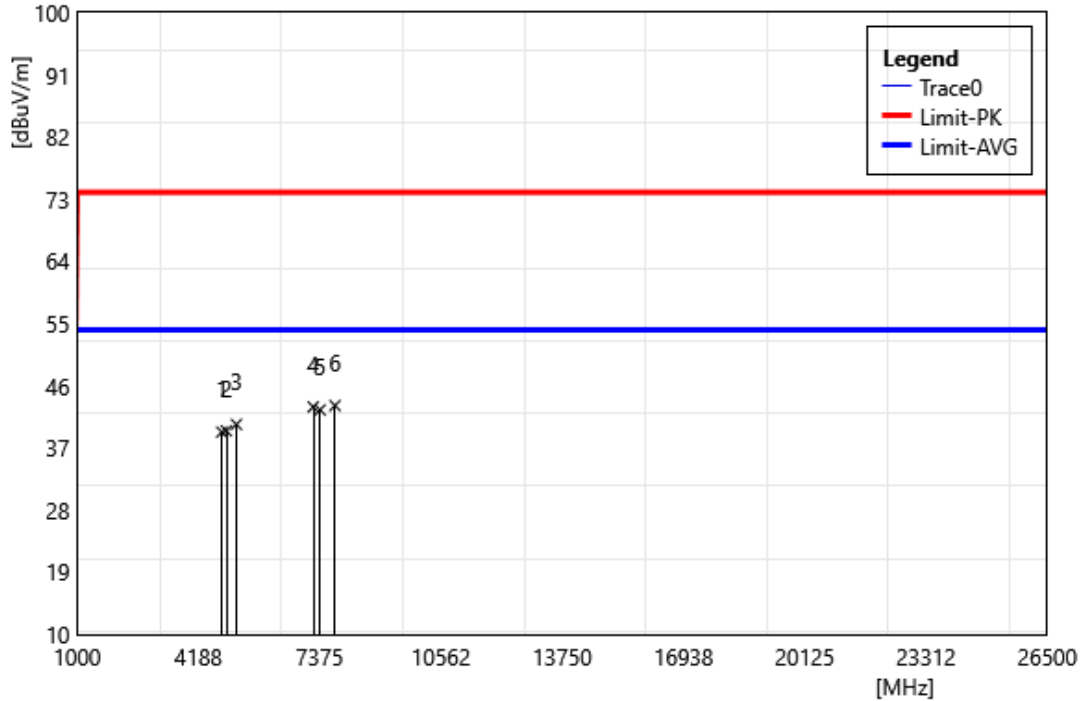

ID	Frequency MHz	Reading dBuV	Correct Factor dB/m	Result dBuV/m	Limit dBuV/m	Margin dB	Remark
1	4804.00	37.99	1.30	39.29	74.00	-34.71	PEAK
2	4924.00	38.00	1.47	39.47	74.00	-34.53	PEAK
3	5186.00	38.67	1.73	40.40	74.00	-33.60	PEAK
4	7206.00	36.38	6.56	42.94	74.00	-31.06	PEAK
5	7386.00	35.87	6.62	42.49	74.00	-31.51	PEAK
6	7779.00	36.52	6.60	43.12	74.00	-30.88	PEAK



Test Site:	96603-WG	Standard:	Part 22_24_27_90_96
Test Mode:	Co-location		
Polarization:	Vertical		
Remark:	LTE+BT+2.4G		

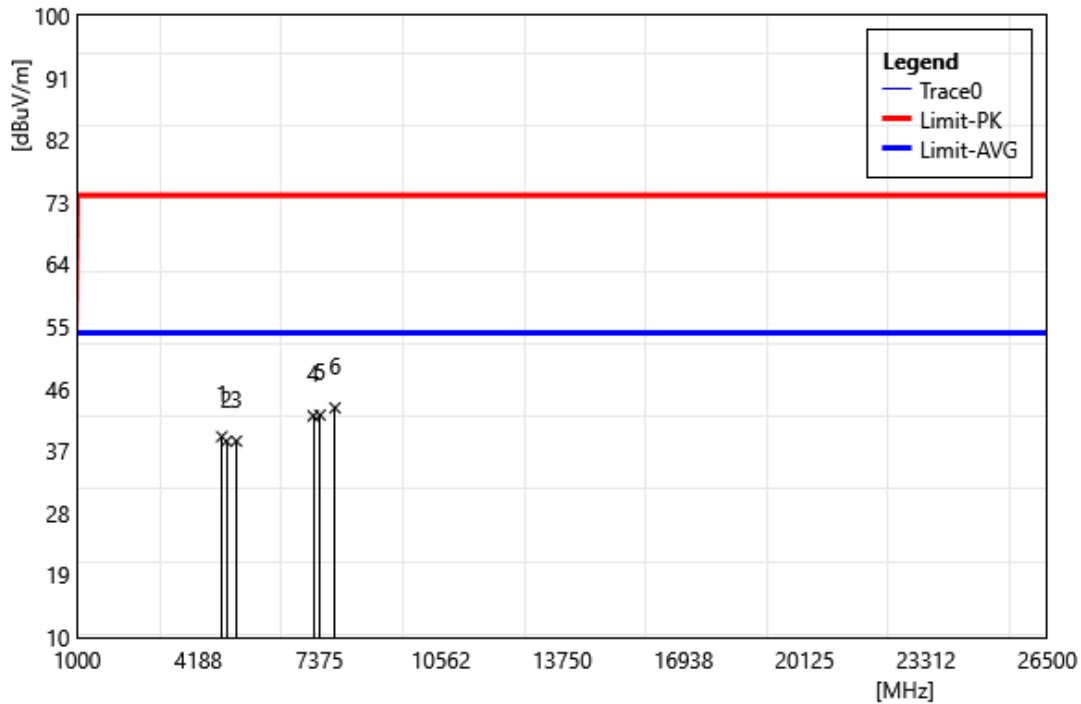

ID	Frequency MHz	Reading dBuV	Correct Factor dB/m	Result dBuV/m	Limit dBuV/m	Margin dB	Remark
1	4804.00	37.76	1.30	39.06	74.00	-34.94	PEAK
2	4924.00	36.92	1.47	38.39	74.00	-35.61	PEAK
3	5186.00	36.69	1.73	38.42	74.00	-35.58	PEAK
4	7206.00	35.51	6.56	42.07	74.00	-31.93	PEAK
5	7386.00	35.56	6.62	42.18	74.00	-31.82	PEAK
6	7779.00	36.64	6.60	43.24	74.00	-30.76	PEAK

Test Site:	96603-WG	Standard:	Part 22_24_27_90_96
Test Mode:	Co-location		
Polarization:	Horizontal		
Remark:	LTE+BT+5G		

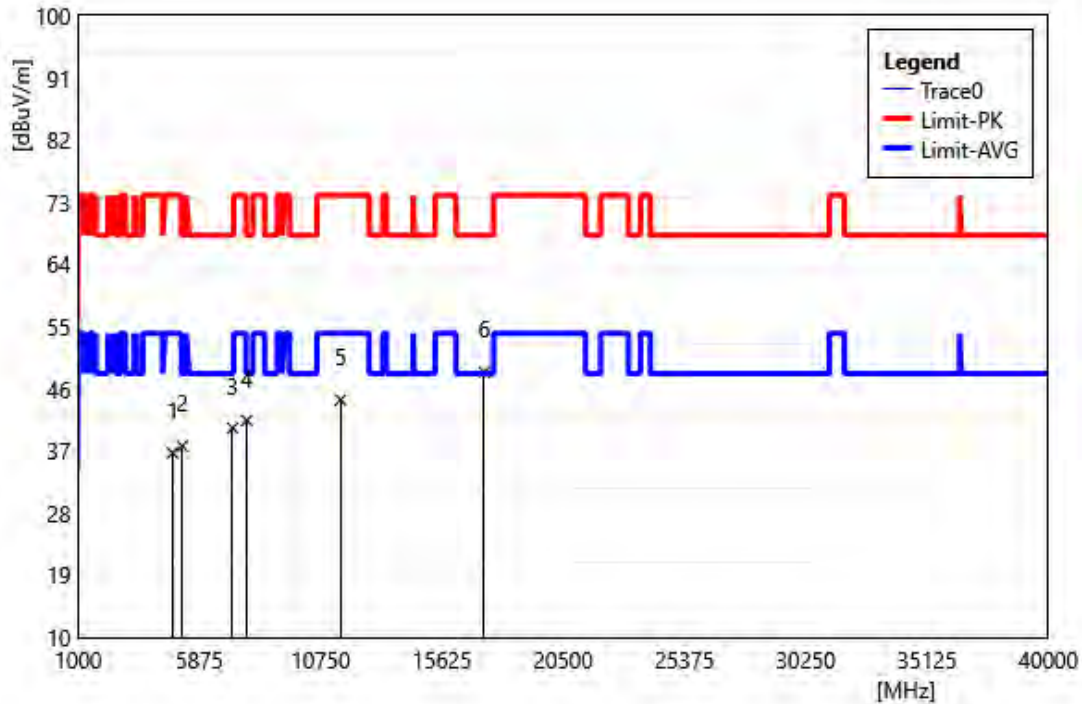

ID	Frequency MHz	Reading dBuV	Correct Factor dB/m	Result dBuV/m	Limit dBuV/m	Margin dB	Remark
1	4804.00	35.40	1.30	36.70	74.00	-37.30	PEAK
2	5186.00	35.98	1.73	37.71	68.20	-30.49	PEAK
3	7206.00	33.74	6.56	40.30	68.20	-27.90	PEAK
4	7779.00	34.78	6.60	41.38	68.20	-26.82	PEAK
5	11550.00	36.61	7.78	44.39	74.00	-29.61	PEAK
6	17325.00	41.25	7.16	48.41	68.20	-19.79	PEAK

Test Site:	96603-WG	Standard:	Part 22_24_27_90_96
Test Mode:	Co-location		
Polarization:	Vertical		
Remark:	LTE+BT+5G		

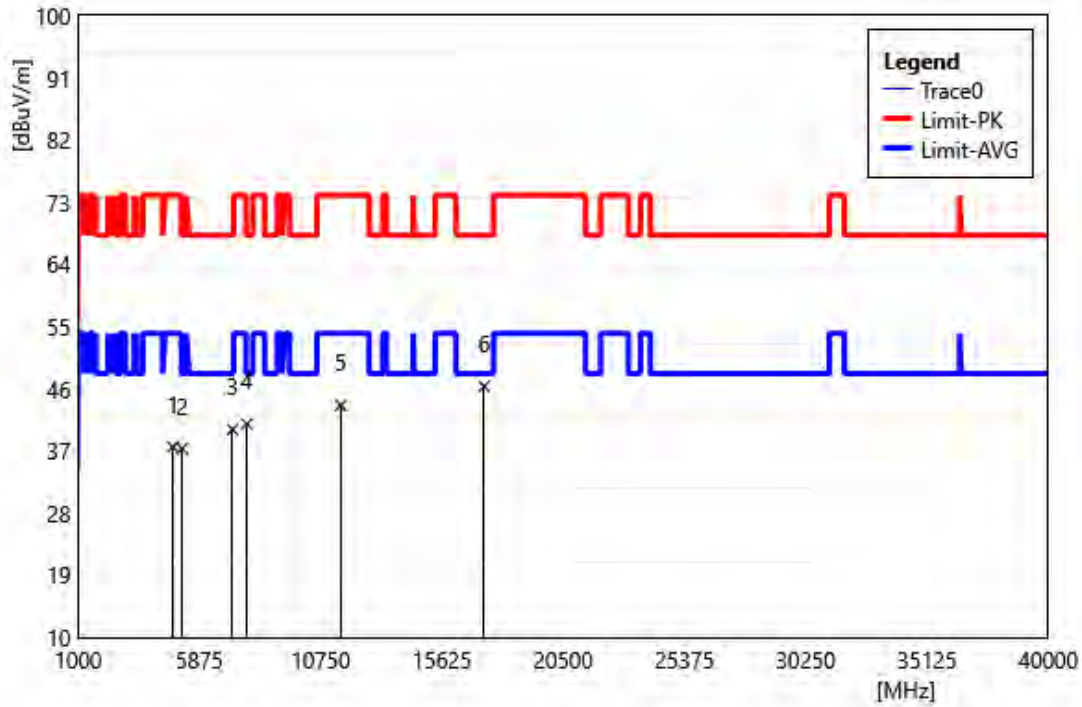

ID	Frequency MHz	Reading dBuV	Correct Factor dB/m	Result dBuV/m	Limit dBuV/m	Margin dB	Remark
1	4804.00	36.26	1.30	37.56	74.00	-36.44	PEAK
2	5186.00	35.61	1.73	37.34	68.20	-30.86	PEAK
3	7206.00	33.55	6.56	40.11	68.20	-28.09	PEAK
4	7779.00	34.29	6.60	40.89	68.20	-27.31	PEAK
5	11550.00	35.80	7.78	43.58	74.00	-30.42	PEAK
6	17325.00	39.19	7.16	46.35	68.20	-21.85	PEAK

Test Site:	96603-WG	Standard:	Part 22_24_27_90_96
Test Mode:	Co-location		
Polarization:	Horizontal		
Remark:	LTE+BT+6E		

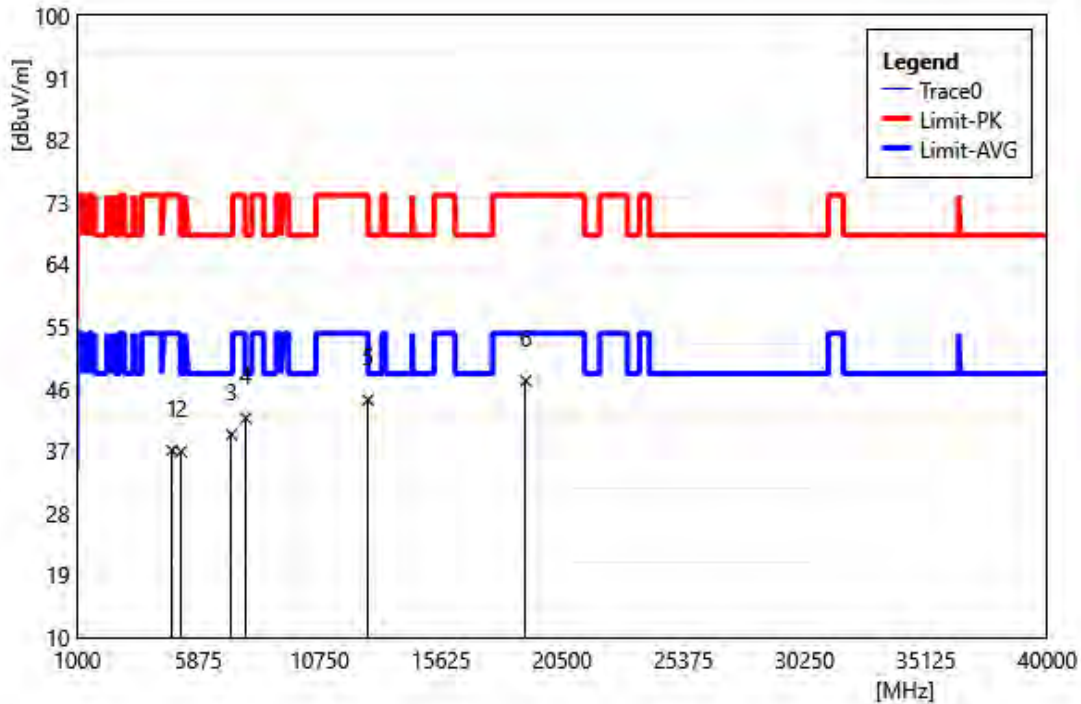

ID	Frequency MHz	Reading dBuV	Correct Factor dB/m	Result dBuV/m	Limit dBuV/m	Margin dB	Remark
1	4804.00	35.77	1.30	37.07	74.00	-36.93	PEAK
2	5186.00	35.18	1.73	36.91	68.20	-31.29	PEAK
3	7206.00	32.79	6.56	39.35	68.20	-28.85	PEAK
4	7779.00	35.15	6.60	41.75	68.20	-26.45	PEAK
5	12690.00	36.01	8.35	44.36	74.00	-29.64	PEAK
6	19035.00	38.65	8.49	47.14	74.00	-26.86	PEAK

Test Site:	96603-WG	Standard:	Part 22_24_27_90_96
Test Mode:	Co-location		
Polarization:	Vertical		
Remark:	LTE+BT+6E		

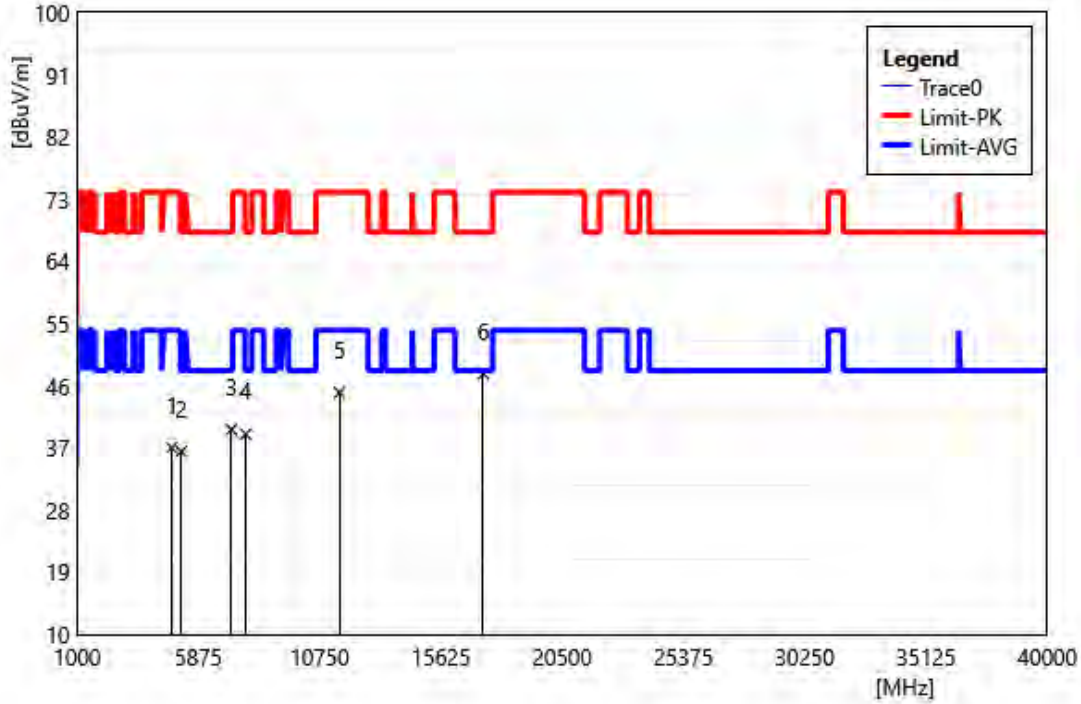

ID	Frequency MHz	Reading dBuV	Correct Factor dB/m	Result dBuV/m	Limit dBuV/m	Margin dB	Remark
1	4804.00	35.74	1.30	37.04	74.00	-36.96	PEAK
2	5186.00	34.72	1.73	36.45	68.20	-31.75	PEAK
3	7206.00	33.09	6.56	39.65	68.20	-28.55	PEAK
4	7779.00	32.38	6.60	38.98	68.20	-29.22	PEAK
5	11550.00	37.22	7.78	45.00	74.00	-29.00	PEAK
6	17325.00	40.57	7.16	47.73	68.20	-20.47	PEAK

--- END---