



FCC TEST REPORT (PART 22)

REPORT NO.: RF120412C30-1
MODEL NO.: Gobi3000
FCC ID: QYLG0BI3K
RECEIVED: Apr. 12, 2012
TESTED: Apr. 24 ~ May 22, 2012
ISSUED: Jun. 21, 2012

APPLICANT: Getac Technology Corporation.

ADDRESS: 5F., Building A, No. 209, Sec. 1, Nangang Rd.,
Nangang Dist, Taipei City 11568, Taiwan, R.O.C.

ISSUED BY: Bureau Veritas Consumer Products Services
(H.K.) Ltd., Taoyuan Branch

LAB ADDRESS: No. 47, 14th Ling, Chia Pau Vil., Lin Kou Dist.,
New Taipei City, Taiwan (R.O.C.)

TEST LOCATION: No. 19, Hwa Ya 2nd Rd, Wen Hwa Tsuen, Kwei
Shan Hsiang, Taoyuan Hsien 333, Taiwan, R.O.C.

This report should not be used by the client to claim product certification, approval, or endorsement by TAF or any government agencies.



This report is for your exclusive use. Any copying or replication of this report to or for any other person or entity, or use of our name or trademark, is permitted only with our prior written permission. This report sets forth our findings solely with respect to the test samples identified herein. The results set forth in this report are not indicative or representative of the quality or characteristics of the lot from which a test sample was taken or any similar or identical product unless specifically and expressly noted. Our report includes all of the tests requested by you and the results thereof based upon the information that you provided to us. You have 60 days from date of issuance of this report to notify us of any material error or omission caused by our negligence, provided, however, that such notice shall be in writing and shall specifically address the issue you wish to raise. A failure to raise such issue within the prescribed time shall constitute your unqualified acceptance of the completeness of this report, the tests conducted and the correctness of the report contents. Unless specific mention, the uncertainty of measurement has been explicitly taken into account to declare the compliance or non-compliance to the specification



TABLE OF CONTENTS

RELEASE CONTROL RECORD.....	3
1 CERTIFICATION	4
2 SUMMARY OF TEST RESULTS	5
2.1 MEASUREMENT UNCERTAINTY	5
2.2 TEST SITE AND INSTRUMENTS	6
3 GENERAL INFORMATION.....	7
3.1 GENERAL DESCRIPTION OF EUT	7
3.2 CONFIGURATION OF SYSTEM UNDER TEST	8
3.3 DESCRIPTION OF SUPPORT UNITS	8
3.4 TEST ITEM AND TEST CONFIGURATION.....	9
3.5 EUT OPERATING CONDITIONS	10
3.6 GENERAL DESCRIPTION OF APPLIED STANDARDS	10
4 TEST TYPES AND RESULTS.....	11
4.1 OUTPUT POWER MEASUREMENT	11
4.1.1 LIMITS OF OUTPUT POWER MEASUREMENT	11
4.1.2 TEST PROCEDURES	11
4.1.3 TEST SETUP.....	12
4.1.4 TEST RESULTS	13
4.2 FREQUENCY STABILITY MEASUREMENT.....	15
4.2.1 LIMITS OF FREQUENCY STABILITY MEASUREMENT	15
4.2.2 TEST PROCEDURE.....	15
4.2.3 TEST SETUP.....	15
4.2.4 TEST RESULTS	16
4.3 OCCUPIED BANDWIDTH MEASUREMENT	17
4.3.1 TEST PROCEDURES	17
4.3.2 TEST SETUP.....	17
4.3.3 TEST RESULTS	18
4.4 BAND EDGE MEASUREMENT.....	19
4.4.1 LIMITS OF BAND EDGE MEASUREMENT	19
4.4.2 TEST SETUP.....	19
4.4.3 TEST PROCEDURES	19
4.4.4 TEST RESULTS	20
4.5 CONDUCTED SPURIOUS EMISSIONS.....	22
4.5.1 LIMITS OF CONDUCTED SPURIOUS EMISSIONS MEASUREMENT	22
4.5.2 TEST PROCEDURE.....	22
4.5.3 TEST SETUP.....	22
4.5.4 TEST RESULTS	23
4.6 RADIATED EMISSION MEASUREMENT	27
4.6.1 LIMITS OF RADIATED EMISSION MEASUREMENT	27
4.6.2 TEST PROCEDURES	27
4.6.3 DEVIATION FROM TEST STANDARD	27
4.6.4 TEST SETUP.....	28
4.6.5 TEST RESULTS	29
5 PHOTOGRAPHS OF THE TEST CONFIGURATION.....	37
6 INFORMATION ON THE TESTING LABORATORIES	38
7 APPENDIX A – MODIFICATIONS RECORDERS FOR ENGINEERING CHANGES TO THE EUT BY THE LAB.....	39



A D T

RELEASE CONTROL RECORD

ISSUE NO.	REASON FOR CHANGE	DATE ISSUED
RF120412C30-1	Original release	Jun. 21, 2012



1 CERTIFICATION

PRODUCT: WWAN Module

MODEL: Gobi3000

BRAND: Sierra

APPLICANT: Getac Technology Corporation.

TESTED: Apr. 24 ~ May 22, 2012

TEST SAMPLE: ENGINEERING SAMPLE

STANDARDS: FCC Part 22, Subpart H

The above equipment (model: Gobi3000) has been tested by **Bureau Veritas Consumer Products Services (H.K.) Ltd., Taoyuan Branch**, and found compliance with the requirement of the above standards. The test record, data evaluation & Equipment Under Test (EUT) configurations represented herein are true and accurate accounts of the measurements of the sample's EMC characteristics under the conditions specified in this report.

PREPARED BY : Andrea Hsia , DATE : Jun. 21, 2012
Andrea Hsia / Specialist

APPROVED BY : Gary Chang , DATE : Jun. 21, 2012
Gary Chang / Technical Manager

2 SUMMARY OF TEST RESULTS

The EUT has been tested according to the following specifications:

APPLIED STANDARD: FCC Part 22 & Part 2			
STANDARD SECTION	TEST TYPE AND LIMIT	RESULT	REMARK
2.1046 22.913 (a)	Effective radiated power	PASS	Meet the requirement of limit.
2.1055 22.355	Frequency Stability	PASS	Meet the requirement of limit.
2.1049	Occupied Bandwidth	PASS	Meet the requirement of limit.
22.917	Band Edge Measurements	PASS	Meet the requirement of limit.
2.1051 22.917	Conducted Spurious Emissions	PASS	Meet the requirement of limit.
2.1053 22.917	Radiated Spurious Emissions	PASS	Meet the requirement of limit. Minimum passing margin is -11.69dB at 2509.20MHz.

2.1 MEASUREMENT UNCERTAINTY

Where relevant, the following measurement uncertainty levels have been estimated for tests performed on the EUT as specified in CISPR 16-4-2:

MEASUREMENT	FREQUENCY	UNCERTAINTY
Conducted emissions	150kHz~30MHz	2.44 dB
Radiated emissions	30MHz ~ 200MHz	2.93 dB
	200MHz ~1000MHz	2.95 dB
	1GHz ~ 18GHz	2.26 dB
	18GHz ~ 40GHz	1.94 dB

This uncertainty represents an expanded uncertainty expressed at approximately the 95% confidence level using a coverage factor of k=2.



2.2 TEST SITE AND INSTRUMENTS

DESCRIPTION & MANUFACTURER	MODEL NO.	SERIAL NO.	DATE OF CALIBRATION	DUE DATE OF CALIBRATION
Test Receiver Agilent	N9038A	MY51210203	Dec. 22, 2011	Dec. 21, 2012
Spectrum Analyzer ROHDE & SCHWARZ	FSU43	101261	Dec. 21, 2011	Dec. 20, 2012
BILOG Antenna SCHWARZBECK	VULB9168	9168-472	Dec. 20, 2011	Dec. 19, 2012
HORN Antenna SCHWARZBECK	BBHA 9120 D	9120D-969	Dec. 20, 2011	Dec. 19, 2012
HORN Antenna SCHWARZBECK	BBHA 9170	9170-480	Dec. 20, 2011	Dec. 19, 2012
Preamplifier EMCI	EMC 012645	980115	Dec. 30, 2011	Dec. 29, 2012
Preamplifier EMCI	EMC 330H	980112	Dec. 30, 2011	Dec. 29, 2012
RF signal cable HUBER+SUHNNER	SUCOFLEX 104	309219/4	Oct. 21, 2011	Oct. 20, 2012
RF signal cable HUBER+SUHNNER	SUCOFLEX 104	250130/4	Jan. 02, 2012	Jan. 01, 2013
RF signal cable Worken	RG-213	NA	Jan. 02, 2012	Jan. 01, 2013
Software	E3 6.120103	NA	NA	NA
Antenna Tower MF	MFA-440H	NA	NA	NA
Turn Table MF	MFT-201SS	NA	NA	NA
Antenna Tower & Turn Table Controller MF	MF-7802	NA	NA	NA
Mini-Circuits Power Splitter	ZN2PD-9G	NA	Mar. 23, 2012	Mar. 22, 2013
JFW 20dB attenuation	50HF-020-SMA	NA	NA	NA
Communications Tester-Wireless	E5515C	MY50266653	Sep. 28, 2011	Sep. 27, 2012

NOTE: 1. The calibration interval of the above test instruments is 12 months and the calibrations are traceable to NML/ROC and NIST/USA.

2. The test was performed in HwaYa Chamber 9.

3. The horn antenna and HP preamplifier (model: 8449B) are used only for the measurement of emission frequency above 1GHz if tested.

4. The FCC Site Registration No. is 460141.

5. The IC Site Registration No. is IC 7450F-4.



A D T

3 GENERAL INFORMATION

3.1 GENERAL DESCRIPTION OF EUT

EUT	WWAN Module
MODEL NO.	Gobi3000
NOMINAL VOLTAGE	3.3Vdc
MODULATION TYPE	GPRS: GMSK EDGE: 8PSK CDMA: QPSK WCDMA : BPSK
OPERATION TEMPERATURE RANGE	-40°C ~ 85°C
MULTI-SLOTS CLASS	10
WCDMA RELEASE VERSION	6
FREQUENCY RANGE	GPRS, EDGE: 824.2MHz ~ 848.8MHz CDMA: 824.7MHz ~ 848.31MHz WCDMA: 826.4MHz ~ 846.6MHz
MAX. ERP POWER	GPRS: 841.40mW EDGE: 214.29mW CDMA: 190.99mW WCDMA: 211.35mW
ANTENNA TYPE	PIFA antenna with 2.02dBi gain
I/O PORTS	Refer to user's manual
DATA CABLE	NA
ACCESSORY DEVICES	NA

NOTE:

1. The transmitter module is authorized for use in specific End-product (Tablet PC, Brand: Getac, Model: E110).
2. The above EUT information was declared by manufacturer and for more detailed features description, please refer to the manufacturer's specifications or User's Manual.

3.2 CONFIGURATION OF SYSTEM UNDER TEST FOR RADIATION EMISSION TEST

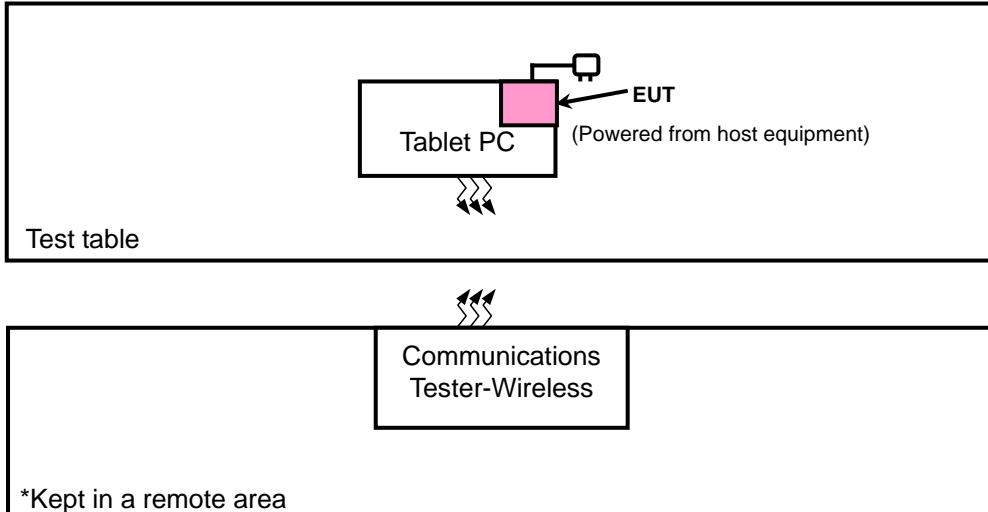

FOR E.R.P. TEST

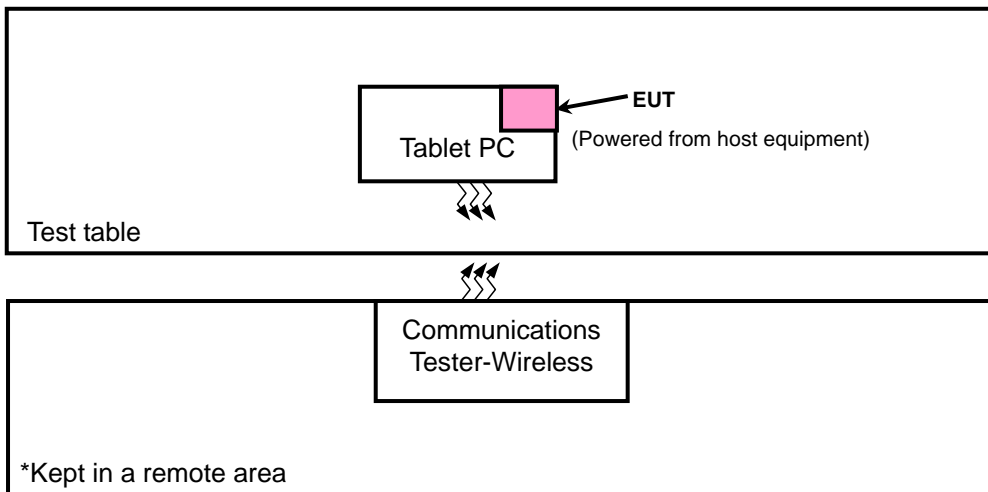

3.3 DESCRIPTION OF SUPPORT UNITS

The EUT has been tested as an independent unit together with other necessary accessories or support units. The following support units or accessories were used to form a representative test configuration during the tests.

NO.	PRODUCT	BRAND	MODEL NO.	SERIAL NO.	FCC ID
1	Tablet PC	Getac	E110	NA	NA

NO.	SIGNAL CABLE DESCRIPTION OF THE ABOVE SUPPORT UNITS
1	NA

NOTE:

1. All power cords of the above support units are non shielded (1.8m).
2. Item 1 was supplied from client.

3.4 TEST ITEM AND TEST CONFIGURATION

Pre-Scan has been conducted to determine the worst-case mode from all possible combinations between available modulations, data rates, XYZ axis and antenna ports.

The worst case was found when positioned on Y-plane. Following channel(s) was (were) selected for the final test as listed below:

FOR GPRS & EDGE:

TEST ITEM	AVAILABLE CHANNEL	TESTED CHANNEL	MODE
ERP	128 to 251	128, 189, 251	GPRS, EDGE
FREQUENCY STABILITY	128 to 251	189	GPRS, EDGE
OCCUPIED BANDWIDTH	128 to 251	128, 189, 251	GPRS, EDGE
BAND EDGE	128 to 251	128, 251	GPRS, EDGE
CONDCUDED EMISSION	128 to 251	189	GPRS, EDGE
RADIATED EMISSION	128 to 251	128	GPRS, EDGE

FOR CDMA:

TEST ITEM	AVAILABLE CHANNEL	TESTED CHANNEL	MODE
ERP	1013 to 777	1013, 384, 777	1xEVDO-0
FREQUENCY STABILITY	1013 to 777	384	1xEVDO-0
OCCUPIED BANDWIDTH	1013 to 777	1013, 384, 777	1xEVDO-0
BAND EDGE	1013 to 777	1013, 777	1xEVDO-0
CONDCUDED EMISSION	1013 to 777	384	1xEVDO-0
RADIATED EMISSION	1013 to 777	1013	1xEVDO-0

FOR WCDMA:

TEST ITEM	AVAILABLE CHANNEL	TESTED CHANNEL	MODE
ERP	4132 to 4233	4132, 4182, 4233	WCDMA
FREQUENCY STABILITY	4132 to 4233	4182	WCDMA
OCCUPIED BANDWIDTH	4132 to 4233	4132, 4182, 4233	WCDMA
BAND EDGE	4132 to 4233	4132, 4233	WCDMA
CONDCUDED EMISSION	4132 to 4233	4182	WCDMA
RADIATED EMISSION	4132 to 4233	4182	WCDMA

3.5 EUT OPERATING CONDITIONS

The EUT makes a call to the communication simulator. The communication simulator station system controlled a EUT to export maximum output power under transmission mode and specific channel frequency

3.6 GENERAL DESCRIPTION OF APPLIED STANDARDS

The EUT is a RF product. According to the specifications of the manufacturer, it must comply with the requirements of the following standards:

FCC 47 CFR Part 2

FCC 47 CFR Part 22

ANSI/TIA/EIA-603-C 2004

NOTE: All test items have been performed and recorded as per the above standards.

4 TEST TYPES AND RESULTS

4.1 OUTPUT POWER MEASUREMENT

4.1.1 LIMITS OF OUTPUT POWER MEASUREMENT

Mobile / Portable station are limited to 7 watts e.r.p”.

4.1.2 TEST PROCEDURES

EIRP / ERP MEASUREMENT:

- a. All measurements were done at low, middle and high operational frequency range. RBW and VBW is 1MHz for GPRS & EDGE and 5MHz for CDMA and WCDMA mode.
- b. Substitution method is used for E.I.R.P measurement. In the semi-anechoic chamber, EUT placed on the 0.8m height of Turn Table, rotated the table around 360 degrees to search the maximum radiation power and receiver antenna shall be rotated vertical and horizontal polarization and moved height from 1m to 4m to find the maximum polar radiated power. The “Read Value” is the spectrum reading the maximum power value.
- c. The substitution horn antenna is substituted for EUT at the same position and signals generator export the CW signal to the substitution antenna via a tx cable. Rotated the Turn Table and moved receiving antenna to find the maximum radiation power. Adjust output power level of S.G to get a Value of spectrum reading equal to “Read Value “ of step b. Record the power level of S.G
- d. $EIRP = \text{Output power level of S.G} - \text{TX cable loss} + \text{Antenna gain of substitution horn.}$
 $E.R.P \text{ power can be calculated form E.I.R.P power by subtracting the gain of dipole, } E.R.P \text{ power} = E.I.P.R \text{ power} - 2.15\text{dBi.}$

CONDUCTED POWER MEASUREMENT:

The EUT was set up for the maximum power with GPRS, EDGE, CDMA & WCDMA link data modulation and link up with simulator. Set the EUT to transmit under low, middle and high channel and record the power level shown on simulator.

4.1.3 TEST SETUP

EIRP / ERP MEASUREMENT:

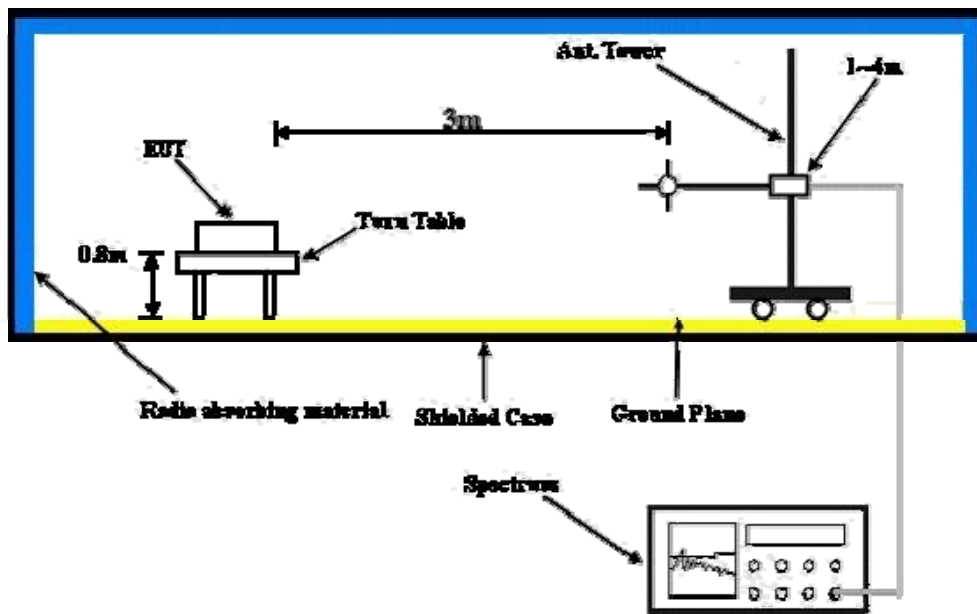

For the actual test configuration, please refer to the attached file (Test Setup Photo).

CONDUCTED POWER MEASUREMENT:

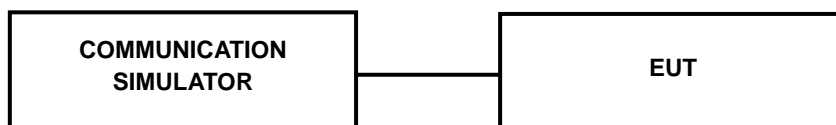

For the actual test configuration, please refer to the attached file (Test Setup Photo).



4.1.4 TEST RESULTS

CONDUCTED OUTPUT POWER (dBm)

Band	GPRS850		
Channel	128	190	251
Frequency (MHz)	824.2	836.6	848.8
GPRS 8	31.21	31.12	31.25
GPRS 10	31.10	31.02	31.16
EDGE 8 (MCS9)	24.84	24.85	24.85
EDGE 10 (MCS9)	24.76	24.77	24.77

Band	CDMA2000		
Channel	1013	384	777
Frequency (MHz)	824.7	836.52	848.31
RC1+SO55	23.93	23.85	23.74
RC3+SO55	23.91	23.83	23.76
RC3+SO32(+ F-SCH)	23.90	23.83	23.75
RC3+SO32(+SCH)	23.92	23.84	23.77
RTAP 153.6	24.10	23.98	23.90
RETAP 4096	24.09	24.05	24.01

Band	WCDMA V		
Channel	4132	4182	4233
Frequency (MHz)	826.4	836.4	846.6
RMC 12.2K	23.93	23.92	24.01
HSDPA Subtest-1	22.95	23.08	23.30
HSDPA Subtest-2	22.94	22.99	23.11
HSDPA Subtest-3	22.62	22.63	22.70
HSDPA Subtest-4	22.51	22.49	22.47
HSUPA Subtest-1	22.65	22.74	23.07
HSUPA Subtest-2	21.50	21.73	21.68
HSUPA Subtest-3	21.54	21.66	21.66
HSUPA Subtest-4	21.92	21.99	21.86
HSUPA Subtest-5	23.22	23.01	23.28



A D T

ERP POWER (dBm)

FOR GPRS:

Plane	Channel	Frequency (MHz)	LVL (dBm)	Correction Factor(dB)	ERP(dBm)	ERP (mW)	Polarization (H/V)
Y	128	824.2	-1.33	32.62	29.14	820.35	H
	189	836.4	-1.26	32.52	29.11	814.70	H
	251	848.8	-1.25	32.65	29.25	841.40	H
	128	824.2	-3.52	32.76	27.09	511.68	V
	189	836.4	-3.12	32.39	27.12	515.23	V
	251	848.8	-3.25	32.54	27.14	517.61	V

FOR EDGE:

Plane	Channel	Frequency (MHz)	LVL (dBm)	Correction Factor(dB)	ERP(dBm)	ERP (mW)	Polarization (H/V)
Y	128	824.2	-7.26	32.62	23.21	209.41	H
	189	836.4	-7.14	32.52	23.23	210.38	H
	251	848.8	-7.19	32.65	23.31	214.29	H
	128	824.2	-9.56	32.76	21.05	127.35	V
	189	836.4	-9.01	32.39	21.23	132.74	V
	251	848.8	-8.52	32.54	21.87	153.82	V

FOR CDMA: 1xEVDO-0

Plane	Channel	Frequency (MHz)	LVL (dBm)	Correction Factor(dB)	ERP(dBm)	ERP (mW)	Polarization (H/V)
Y	1013	824.7	-7.66	32.62	22.81	190.99	H
	384	836.52	-7.86	32.52	22.51	178.24	H
	777	848.31	-7.69	32.65	22.81	190.99	H
	1013	824.7	-12.06	32.76	18.55	71.61	V
	384	836.52	-12.20	32.39	18.04	63.68	V
	777	848.31	-12.26	32.54	18.13	65.01	V

FOR WCDMA:

Plane	Channel	Frequency (MHz)	LVL (dBm)	Correction Factor(dB)	ERP(dBm)	ERP (mW)	Polarization (H/V)
Y	4132	826.4	-7.48	32.62	22.99	199.07	H
	4182	836.4	-7.12	32.52	23.25	211.35	H
	4233	846.6	-7.49	32.65	23.01	199.99	H
	4132	826.4	-12.49	32.76	18.12	64.86	V
	4182	836.4	-12.01	32.39	18.23	66.53	V
	4233	846.6	-12.20	32.54	18.19	65.92	V

4.2 FREQUENCY STABILITY MEASUREMENT

4.2.1 LIMITS OF FREQUENCY STABILITY MEASUREMENT

1.5 ppm is for base and fixed station. 2.5 ppm is for mobile station.

4.2.2 TEST PROCEDURE

- Device is placed at the oven room. The oven room could control the temperatures and humidity. Power warm up is at least 15 min and power applied should perform before recording frequency error.
- EUT is connected the external power supply to control the DC input power. The test voltage range is from minimum to maximum working voltage. Each step shall be record the frequency error rate.
- The temperature range step is 10 degrees in this test items. All temperature levels shall be hold the $\pm 0.5^{\circ}\text{C}$ during the measurement testing. The each temperature step shall be at least 0.5 hours, consider the EUT could be test under the stability condition.

NOTE: The frequency error was recorded frequency error from the communication simulator.

4.2.3 TEST SETUP

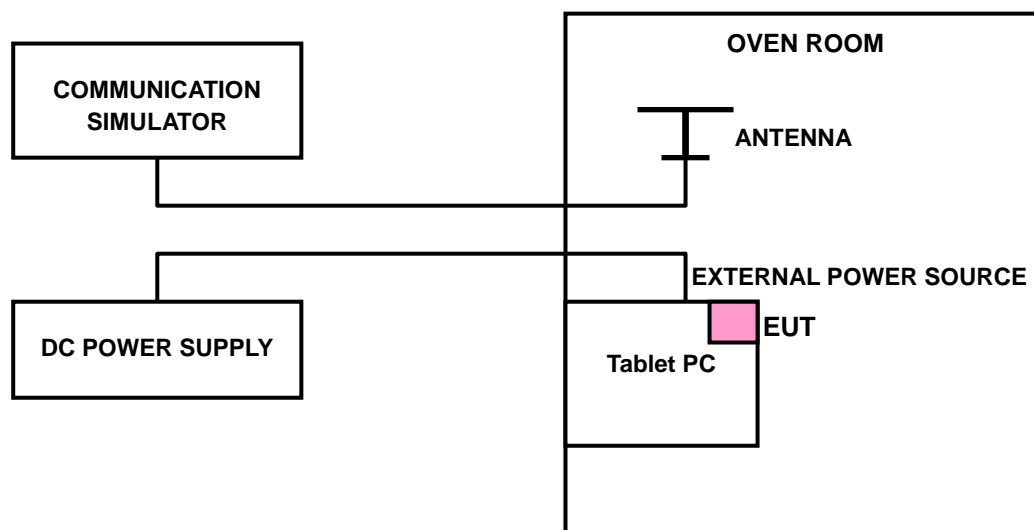

4.2.4 TEST RESULTS

FREQUENCY ERROR VS. VOLTAGE

VOLTAGE (Volts)	FREQUENCY ERROR (ppm)				LIMIT (ppm)
	GPRS	EDGE	CDMA 1xEVDO-0	WCDMA	
19	-0.03	0.02	0.00	-0.08	2.5
18	-0.02	0.02	0.00	-0.08	2.5
20	-0.02	0.02	0.00	-0.08	2.5

NOTE: The applicant defined the normal working voltage of the battery is from 18Vdc to 20Vdc.

FREQUENCY ERROR vs. TEMPERATURE.

TEMP. (°C)	FREQUENCY ERROR (ppm)				LIMIT (ppm)
	GPRS	EDGE	CDMA 1xEVDO-0	WCDMA	
-20	-0.02	0.02	0.00	-0.09	2.5
-10	-0.02	0.02	0.00	-0.08	2.5
0	-0.02	0.02	0.00	-0.09	2.5
10	-0.02	0.02	0.00	-0.08	2.5
20	-0.02	0.02	0.00	-0.08	2.5
30	-0.02	0.02	0.00	-0.08	2.5
40	-0.02	0.02	0.00	-0.09	2.5
50	-0.02	0.02	0.00	-0.09	2.5

4.3 OCCUPIED BANDWIDTH MEASUREMENT

4.3.1 TEST PROCEDURES

The EUT makes a call to the communication simulator. All measurements were done at low, middle and high operational frequency range. The communication simulator station system controlled a EUT to export maximum output power under transmission mode and specific channel frequency. Use OBW measurement function of Spectrum analyzer to measure 99 % occupied bandwidth.

4.3.2 TEST SETUP

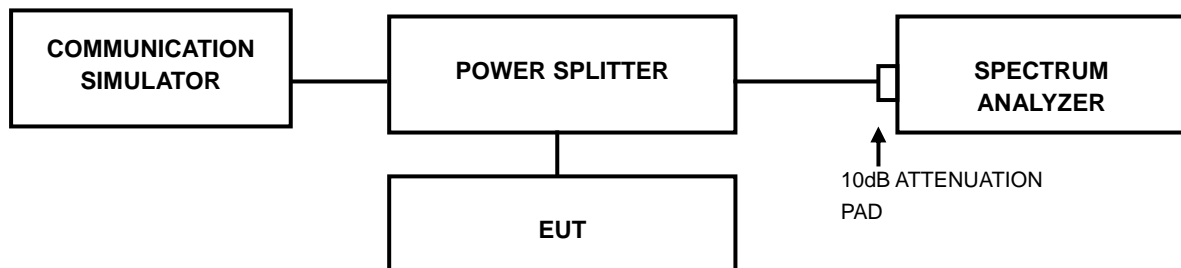



A D T

4.3.3 TEST RESULTS

CHANNEL	FREQUENCY (MHz)	GPRS		CHANNEL	FREQUENCY (MHz)	EDGE	
		99% OCCUPIED BANDWIDTH (kHz)	26dB BANDWIDTH (kHz)			99% OCCUPIED BANDWIDTH (kHz)	26dB BANDWIDTH (kHz)
128	824.2	243.55	299.50	128	824.2	246.25	305.80
189	836.4	241.69	299.50	189	836.4	240.26	302.40
251	848.8	243.48	299.20	251	848.8	245.27	313.10

CHANNEL	FREQUENCY (MHz)	CDMA 1XEVD0-0		CHANNEL	FREQUENCY (MHz)	WCDMA	
		99% OCCUPIED BANDWIDTH (MHz)	26dB BANDWIDTH (MHz)			99% OCCUPIED BANDWIDTH (MHz)	26dB BANDWIDTH (MHz)
1013	824.70	1.2729	1.424	4132	826.4	4.1368	4.643
384	836.52	1.2730	1.418	4182	836.4	4.1420	4.628
777	848.31	1.2767	1.420	4233	846.6	4.1287	4.640

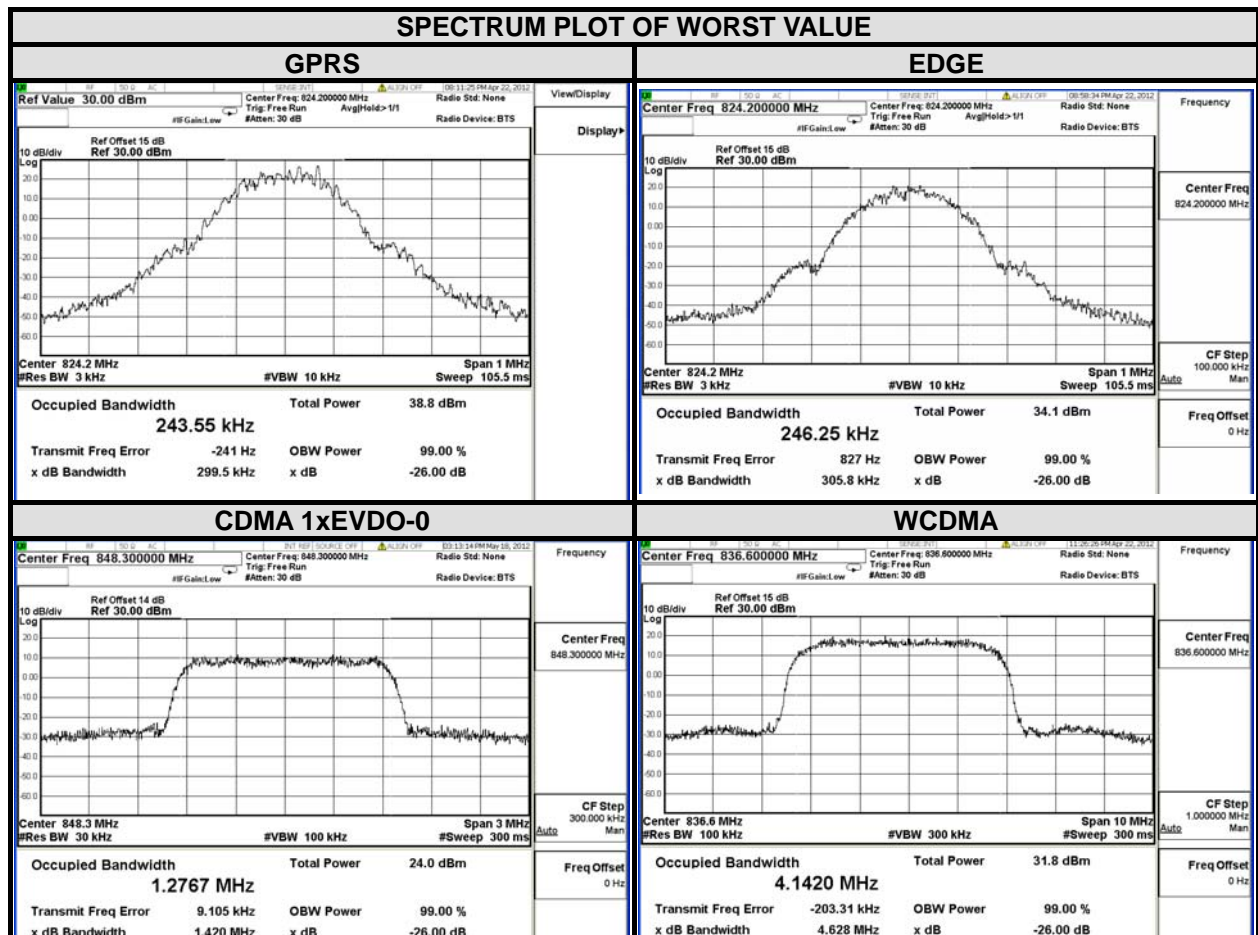

4.4 BAND EDGE MEASUREMENT

4.4.1 LIMITS OF BAND EDGE MEASUREMENT

Power of any emission outside of the authorized operating frequency ranges must be attenuated below the transmitting power (P) by a factor of at least $43 + 10 \log(P)$ dB. In the 1 MHz bands immediately outside and adjacent to the frequency block a resolution bandwidth of at least one percent of the emission bandwidth of the fundamental emission of the transmitter may be employed.

4.4.2 TEST SETUP

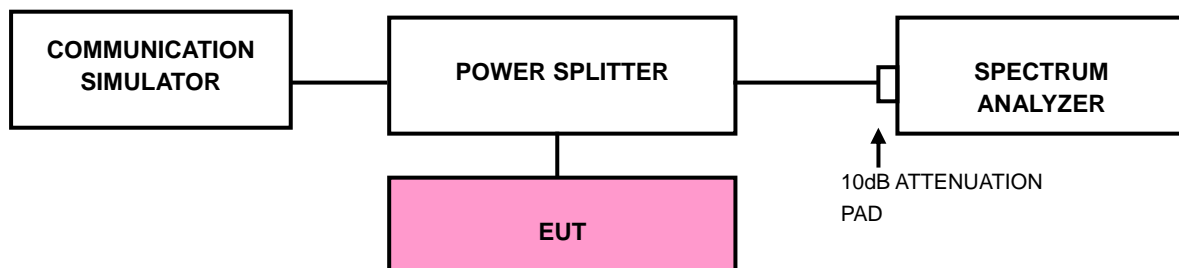

4.4.3 TEST PROCEDURES

- All measurements were done at low and high operational frequency range.
- The center frequency of spectrum is the band edge frequency and span is 1.5 MHz. RB & VB of the spectrum is 3kHz (GPRS/ EDGE).
- The center frequency of spectrum is the band edge frequency and span is 3MHz. RB of the spectrum is 13kHz and VB of the spectrum is 51kHz (CDMA).
- The center frequency of spectrum is the band edge frequency and span is 10MHz. RB of the spectrum is 100kHz and VB of the spectrum is 300kHz (WCDMA).
- Record the max trace plot into the test report.



A D T

4.4.4 TEST RESULTS

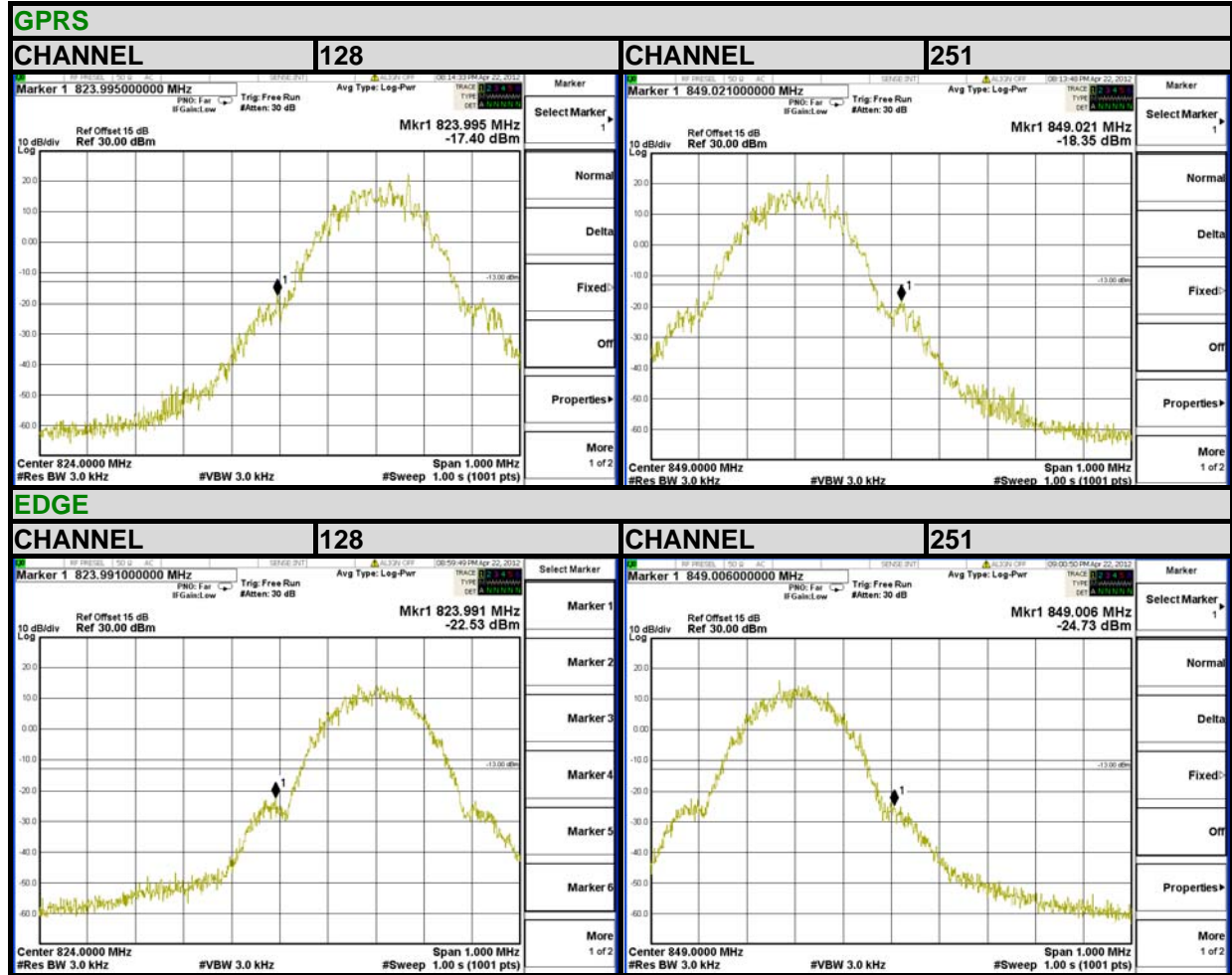



A D T

CDMA: 1xEVDO-0

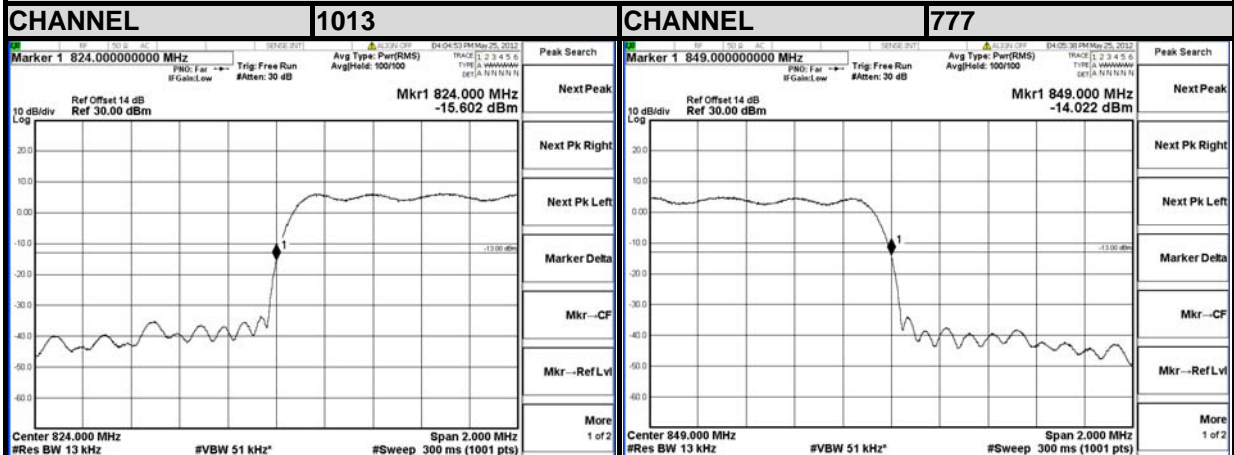

WCDMA

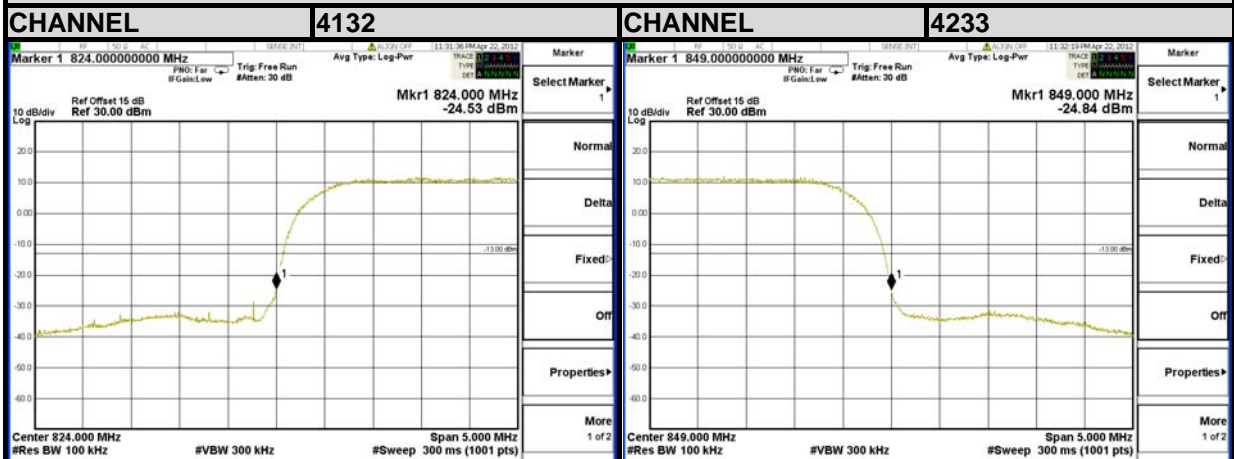

4.5 CONDUCTED SPURIOUS EMISSIONS

4.5.1 LIMITS OF CONDUCTED SPURIOUS EMISSIONS MEASUREMENT

The power of any emission outside of the authorized operating frequency ranges must be attenuated below the transmitting power (P) by a factor of at least $43 + 10 \log(P)$ dB. The emission limit equal to -13dBm .

4.5.2 TEST PROCEDURE

- a. The EUT makes a phone call to the communication simulator. All measurements were done at low, middle and high operational frequency range.
- b. Measuring frequency range is from 30MHz to 9GHz. 10dB attenuation pad is connected with spectrum. RBW=1MHz and VBW=3MHz is used for conducted emission measurement.

4.5.3 TEST SETUP

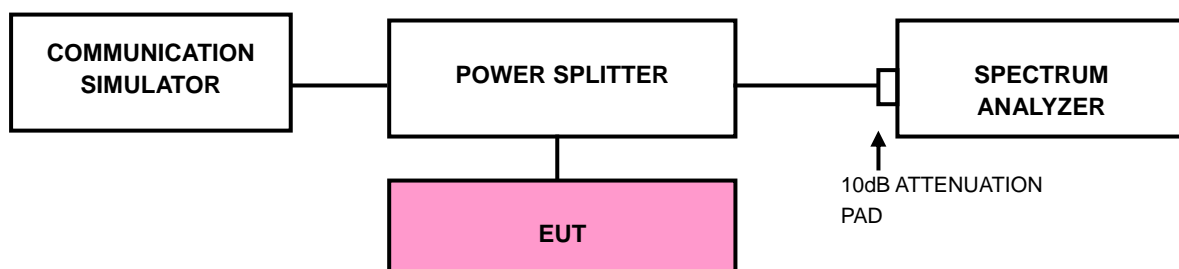

4.5.4 TEST RESULTS

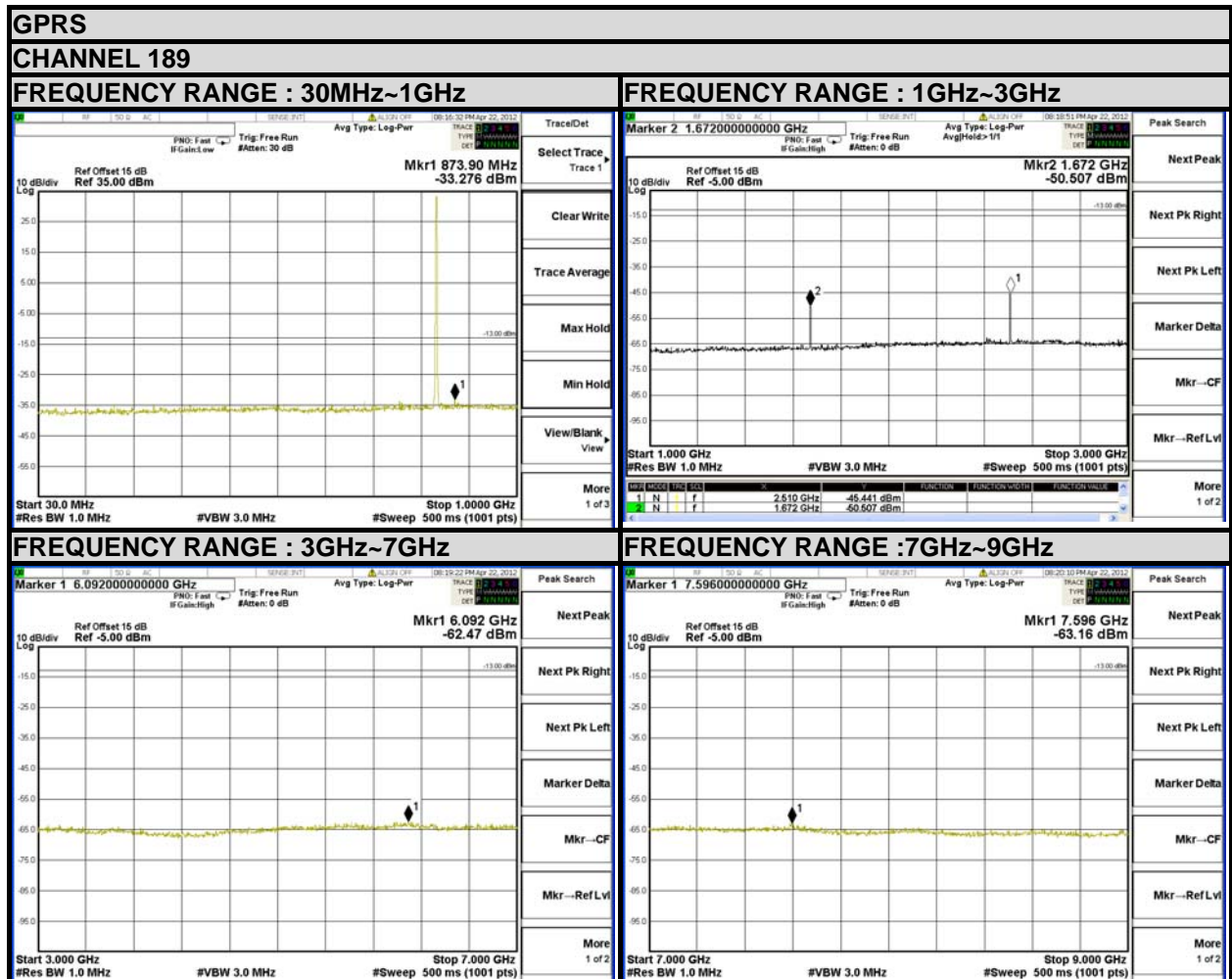



A D T

EDGE

CHANNEL 189

FREQUENCY RANGE : 30MHz~1GHz

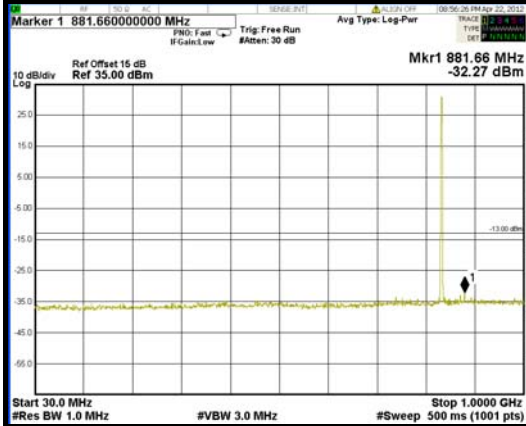

FREQUENCY RANGE : 1GHz~3GHz

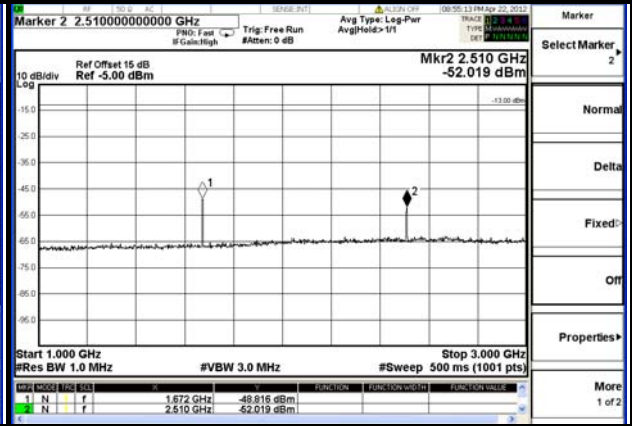

FREQUENCY RANGE : 3GHz~7GHz

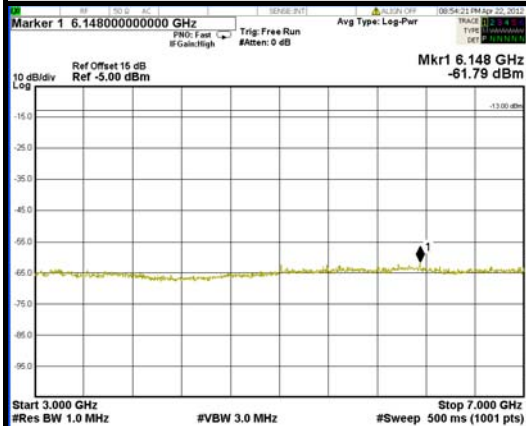

FREQUENCY RANGE : 7GHz~9GHz

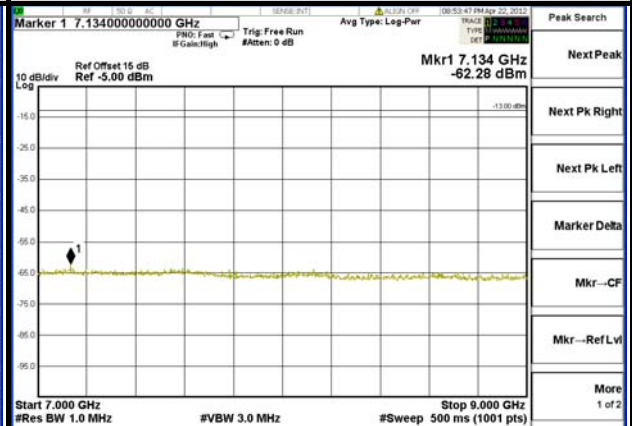



A D T

CDMA: 1xEVDO-0

CHANNEL 384

FREQUENCY RANGE : 30MHz~1GHz

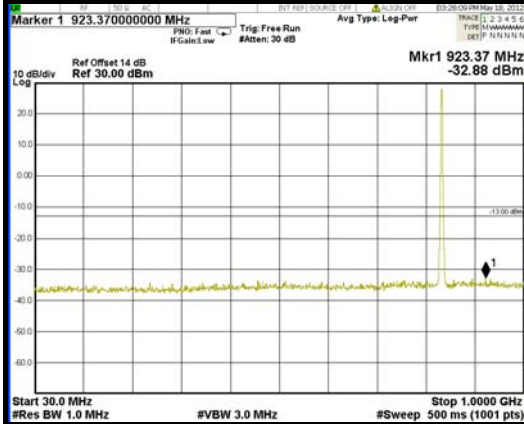

FREQUENCY RANGE : 1GHz~3GHz



FREQUENCY RANGE : 3GHz~7GHz

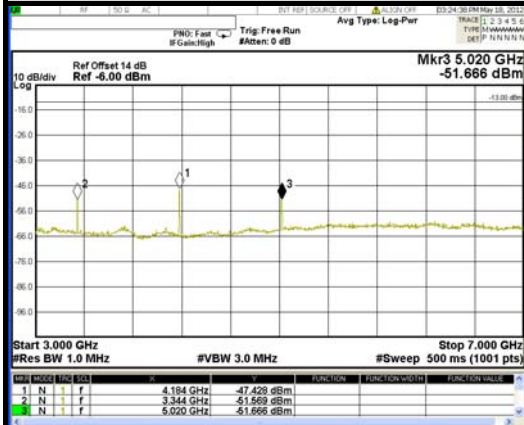

FREQUENCY RANGE : 7GHz~9GHz

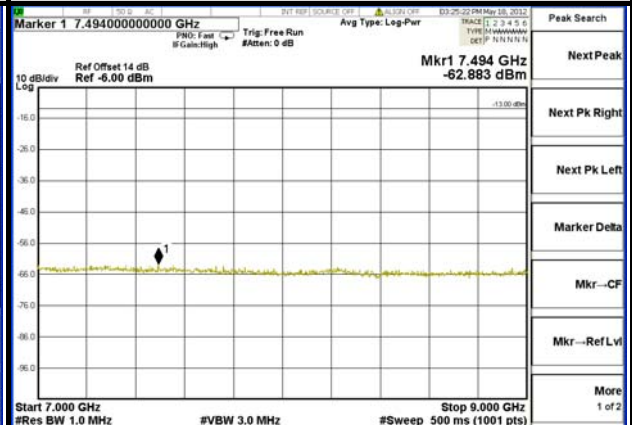



A D T

WCDMA

CHANNEL 4182

FREQUENCY RANGE : 30MHz~1GHz



FREQUENCY RANGE : 1GHz~3GHz

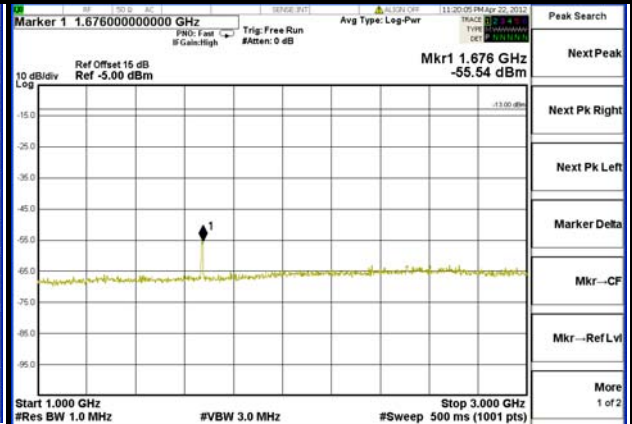

FREQUENCY RANGE : 3GHz~7GHz

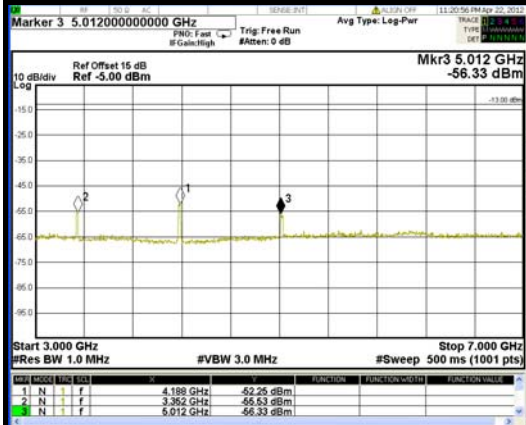

FREQUENCY RANGE : 7GHz~9GHz

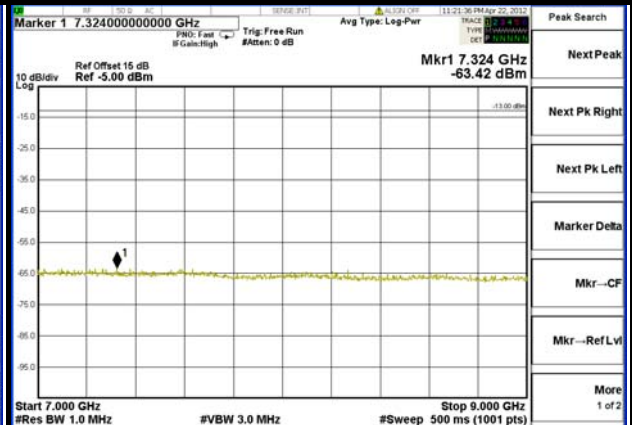

4.6 RADIATED EMISSION MEASUREMENT

4.6.1 LIMITS OF RADIATED EMISSION MEASUREMENT

The power of any emission outside of the authorized operating frequency ranges must be attenuated below the transmitting power (P) by a factor of at least $43 + 10 \log(P)$ dB. The emission limit equal to -13dBm .

4.6.2 TEST PROCEDURES

- a. Substitution method is used for E.I.R.P measurement. In the semi-anechoic chamber, EUT placed on the 0.8m height of Turn Table, rotated the table around 360 degrees to search the maximum radiation power and receiver antenna shall be rotated vertical and horizontal polarization and moved height from 1m to 4m to find the maximum polar radiated power. The “Read Value” is the spectrum reading the maximum power value.
- b. The substitution horn antenna is substituted for EUT at the same position and signals generator export the CW signal to the substitution antenna via a TX cable. Rotated the Turn Table and moved receiving antenna to find the maximum radiation power. Adjust output power level of S.G to get a Value of spectrum reading equal to “Read Value” of step a. Record the power level of S.G
- c. $\text{EIRP} = \text{Output power level of S.G} - \text{TX cable loss} + \text{Antenna gain of substitution horn}$.
- d. E.R.P power can be calculated form E.I.R.P power by subtracting the gain of dipole, $\text{E.R.P power} = \text{E.I.P.R power} - 2.15\text{dBi}$.

NOTE: The resolution bandwidth and video bandwidth of test receiver/spectrum analyzer is 1MHz/3MHz.

4.6.3 DEVIATION FROM TEST STANDARD

No deviation

4.6.4 TEST SETUP

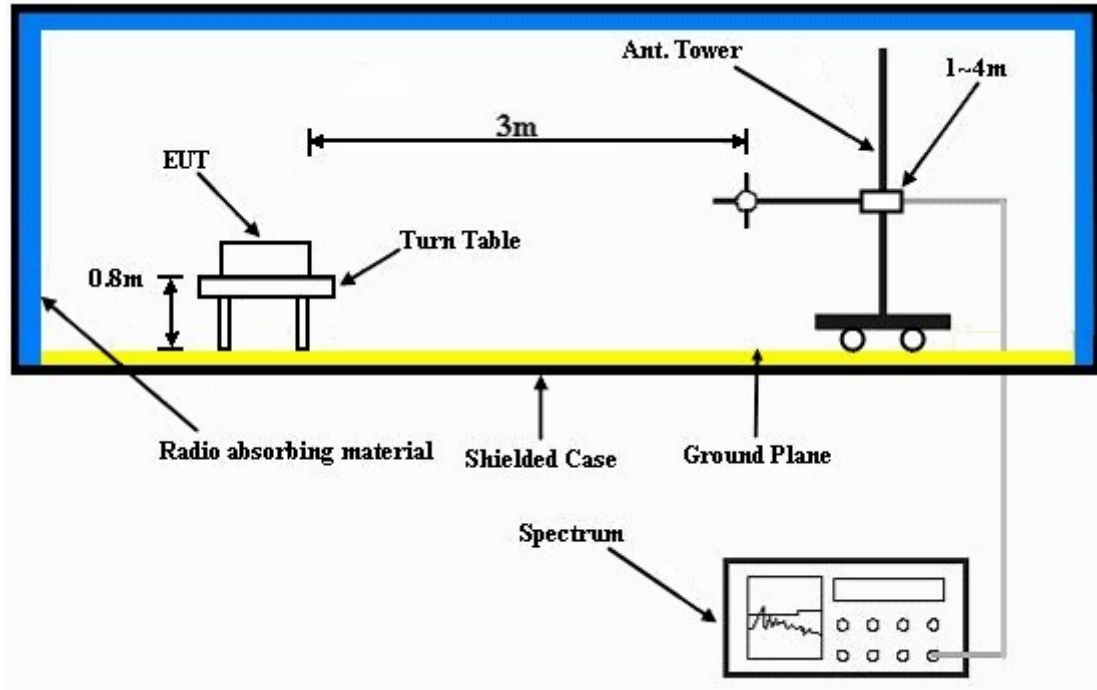

For the actual test configuration, please refer to the attached file (Test Setup Photo).

4.6.5 TEST RESULTS

FOR GPRS:



Bureau Veritas Consumer Products Services Ltd., Taoyuan Branch

A D T

Data: 9

Date: 2012-04-24

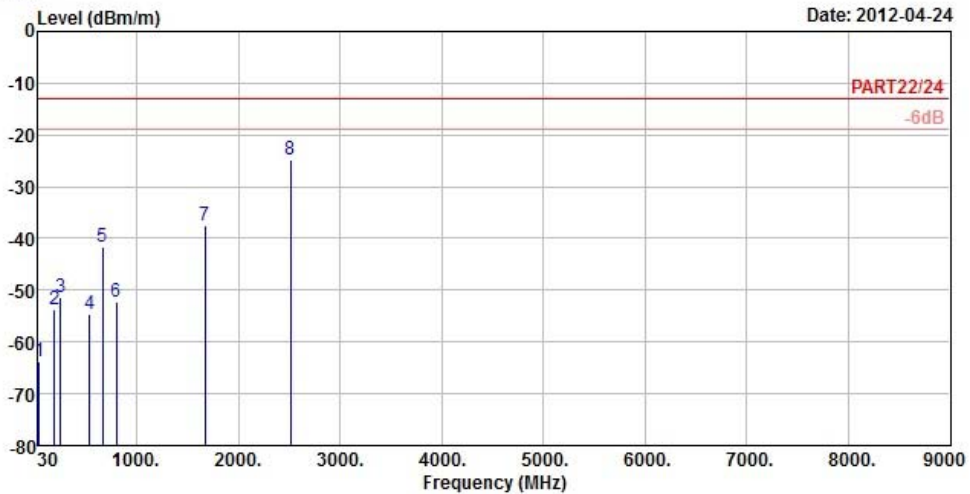

Site : 966 Chamber 5
 Condition : PART22/24 3m EIRP_RSE_1G~19G_3 HORIZONTAL
 Brand/Model: E110
 Remark : GPRS850 Link
 Tested by : Kay Wu
 Temperature : 25°C
 Humidity : 65%
 Plane : Y

	Freq	Level	Read Level	Limit Line	Over Limit	Factor	Remark
	MHz	dBm/m	dBm	dBm/m	dB	dB/m	
1	38.91	-63.62	-61.88	-13.00	-50.62	-1.74	Peak
2	186.87	-53.59	-47.12	-13.00	-40.59	-6.47	Peak
3	246.54	-51.50	-45.65	-13.00	-38.50	-5.85	Peak
4	533.10	-54.74	-52.55	-13.00	-41.74	-2.19	Peak
5	666.10	-41.75	-42.59	-13.00	-28.75	0.84	Peak
6	798.40	-52.40	-54.52	-13.00	-39.40	2.12	Peak
7	1672.80	-37.62	-24.80	-13.00	-24.62	-12.82	Peak
8 pp	2509.20	-24.69	-15.52	-13.00	-11.69	-9.17	Peak



A D T



Bureau Veritas Consumer Products Services Ltd., Taoyuan Branch

A D T

Data: 10

Date: 2012-04-24

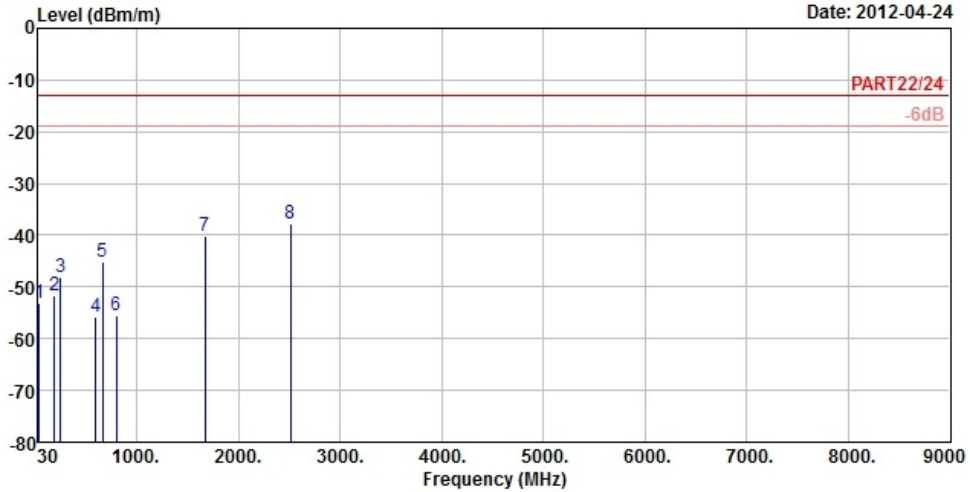

Site : 966 Chamber 5
 Condition : PART22/24 3m EIRP_RSE_1G~19G_3 VERTICAL
 Brand/Model: E110
 Remark : GPRS850 Link
 Tested by : Kay Wu
 Temperature : 25°C
 Humidity : 65%
 Plane : Y

	Freq	Level	Read Level	Limit Line	Over Limit	Factor	Remark
	MHz	dBm/m	dBm	dBm/m	dB	dB/m	
1	39.45	-53.26	-51.73	-13.00	-40.26	-1.53	Peak
2	186.60	-51.63	-45.28	-13.00	-38.63	-6.35	Peak
3	246.54	-48.07	-42.22	-13.00	-35.07	-5.85	Peak
4	597.50	-55.87	-55.44	-13.00	-42.87	-0.43	Peak
5	664.70	-45.18	-45.98	-13.00	-32.18	0.80	Peak
6	797.70	-55.41	-57.52	-13.00	-42.41	2.11	Peak
7	1672.80	-40.01	-27.19	-13.00	-27.01	-12.82	Peak
8 pp	2509.20	-37.68	-28.51	-13.00	-24.68	-9.17	Peak



A D T

FOR EDGE:



Bureau Veritas Consumer Products Services Ltd., Taoyuan Branch

A D T

Data: 9

Date: 2012-04-24

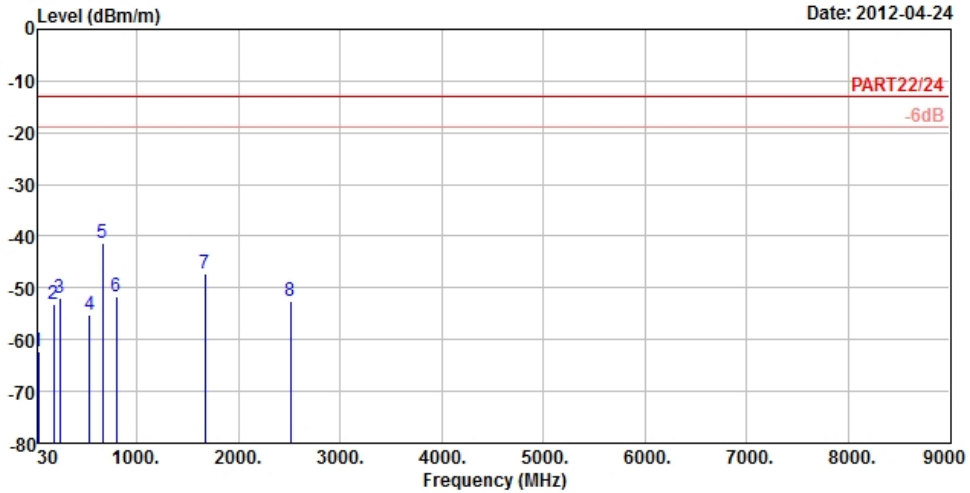

Site : 966 Chamber 5
 Condition : PART22/24 3m EIRP_RSE_1G~19G_3 HORIZONTAL
 Brand/Model: E110
 Remark : EDGE850 Link
 Tested by : Kay Wu
 Temperature : 25°C
 Humidity : 65%
 Plane : Y

	Freq	Level	Read Level	Limit Line	Over Limit	Factor	Remark
	MHz	dBm/m	dBm	dBm/m	dB	dB/m	
1	33.24	-62.40	-61.29	-13.00	-49.40	-1.11	Peak
2	186.06	-53.11	-46.76	-13.00	-40.11	-6.35	Peak
3	245.46	-51.91	-46.01	-13.00	-38.91	-5.90	Peak
4	533.10	-55.13	-52.94	-13.00	-42.13	-2.19	Peak
5 pp	664.70	-41.41	-42.21	-13.00	-28.41	0.80	Peak
6	798.40	-51.59	-53.71	-13.00	-38.59	2.12	Peak
7	1672.80	-47.28	-34.46	-13.00	-34.28	-12.82	Peak
8	2509.20	-52.52	-43.35	-13.00	-39.52	-9.17	Peak



A D T



Bureau Veritas Consumer Products Services Ltd., Taoyuan Branch

A D T

Data: 10

Date: 2012-04-24

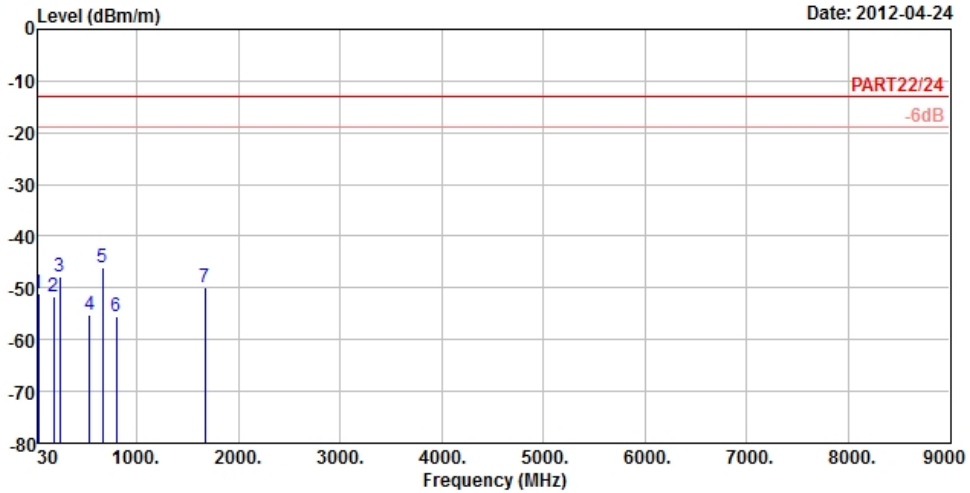

Site : 966 Chamber 5
 Condition : PART22/24 3m EIRP_RSE_1G~19G_3 VERTICAL
 Brand/Model: E110
 Remark : EDGE850 Link
 Tested by : Kay Wu
 Temperature : 25°C
 Humidity : 65%
 Plane : Y

	Freq	Level	Read Level	Limit Line	Over Limit	Factor	Remark
	MHz	dBm/m	dBm	dBm/m	dB	dB/m	
1	31.08	-50.95	-51.29	-13.00	-37.95	0.34	Peak
2	180.12	-51.76	-46.09	-13.00	-38.76	-5.67	Peak
3	245.19	-47.73	-41.83	-13.00	-34.73	-5.90	Peak
4	533.10	-55.10	-52.91	-13.00	-42.10	-2.19	Peak
5 pp	664.70	-46.06	-46.86	-13.00	-33.06	0.80	Peak
6	797.70	-55.42	-57.53	-13.00	-42.42	2.11	Peak
7	1672.80	-49.92	-37.10	-13.00	-36.92	-12.82	Peak



A D T

FOR CDMA: 1xEVDO-0



Bureau Veritas Consumer Products Services Ltd., Taoyuan Branch

A D T

Data: 9

Date: 2012-05-22

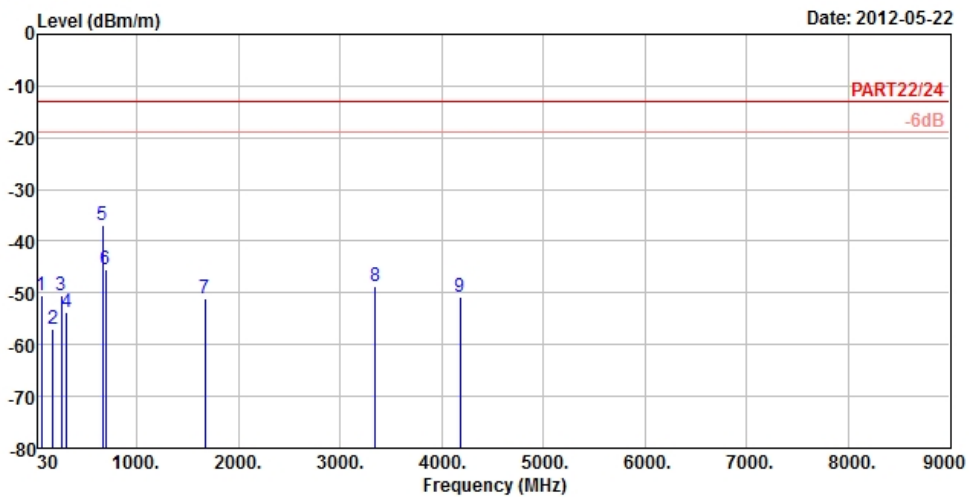

Site : 966 Chamber 5
 Condition : PART22/24 3m EIRP_RSE_1G~19G_3 HORIZONTAL
 Brand/Model: E110
 Remark : 1xEVDO-0 Link
 Tested by : Kay Wu
 Temperature : 25°C
 Humidity : 65%
 Plane : Y

	Freq	Level	Read Level	Limit Line	Over Limit	Factor	Remark
	MHz	dBm/m	dBm	dBm/m	dB	dB/m	
1	65.10	-50.35	-42.63	-13.00	-37.35	-7.72	Peak
2	173.91	-57.10	-50.33	-13.00	-44.10	-6.77	Peak
3	260.31	-50.54	-44.72	-13.00	-37.54	-5.82	Peak
4	313.30	-53.77	-47.49	-13.00	-40.77	-6.28	Peak
5 pp	666.10	-36.79	-37.63	-13.00	-23.79	0.84	Peak
6	692.00	-45.37	-46.66	-13.00	-32.37	1.29	Peak
7	1672.80	-51.02	-38.20	-13.00	-38.02	-12.82	Peak
8	3345.60	-48.83	-41.02	-13.00	-35.83	-7.81	Peak
9	4182.00	-50.85	-45.27	-13.00	-37.85	-5.58	Peak



A D T



Bureau Veritas Consumer Products Services Ltd., Taoyuan Branch

A D T

Data: 10

Date: 2012-05-22

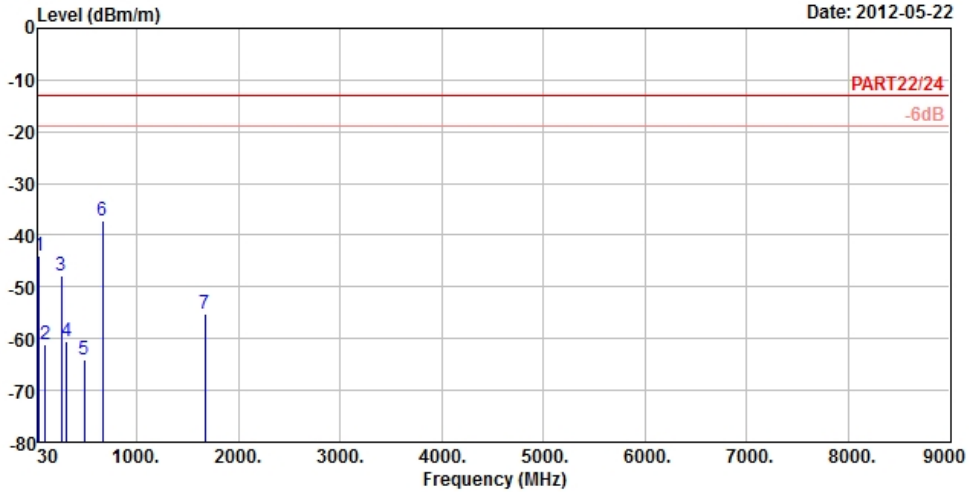

Site : 966 Chamber 5
 Condition : PART22/24 3m EIRP_RSE_1G~19G_3 VERTICAL
 Brand/Model: E110
 Remark : 1xEVDO-0 Link
 Tested by : Kay Wu
 Temperature : 25°C
 Humidity : 65%
 Plane : Y

	Freq	Level	Read Level	Limit Line	Over Limit	Factor	Remark
	MHz	dBm/m	dBm	dBm/m	dB	dB/m	
1	38.37	-44.02	-42.28	-13.00	-31.02	-1.74	Peak
2	101.55	-61.11	-50.67	-13.00	-48.11	-10.44	Peak
3	259.77	-47.78	-41.96	-13.00	-34.78	-5.82	Peak
4	314.00	-60.63	-54.36	-13.00	-47.63	-6.27	Peak
5	486.90	-64.13	-60.70	-13.00	-51.13	-3.43	Peak
6 pp	663.30	-37.21	-38.00	-13.00	-24.21	0.79	Peak
7	1672.00	-55.29	-42.47	-13.00	-42.29	-12.82	Peak



A D T

FOR WCDMA:



Bureau Veritas Consumer Products Services Ltd., Taoyuan Branch

A D T

Data: 9

Date: 2012-04-25

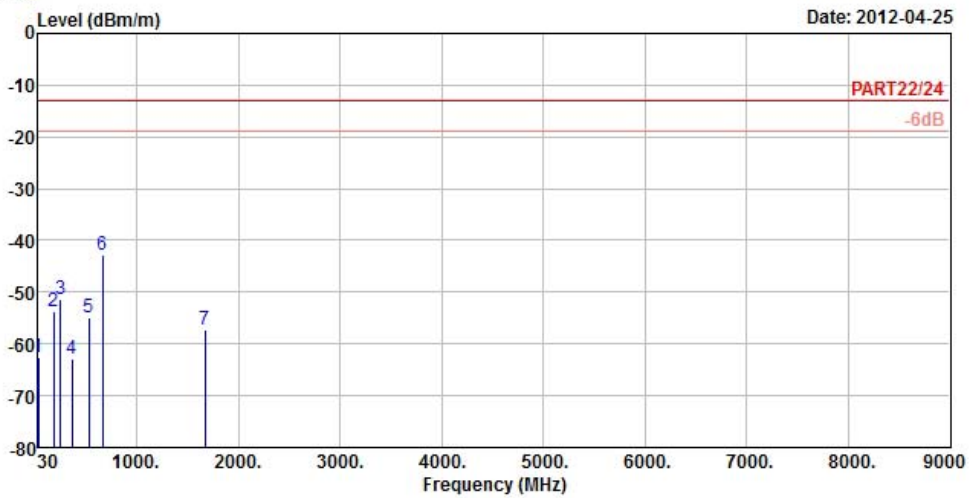

Site : 966 Chamber 5
 Condition : PART22/24 3m EIRP_RSE_1G~19G_3 HORIZONTAL
 Brand/Model: E110
 Remark : Band V Link
 Tested by : Kay Wu
 Temperature : 25°C
 Humidity : 65%
 Plane : Y

	Read	Limit	Over				
	Freq	Level	Level	Line	Limit	Factor	Remark
	MHz	dBm/m	dBm	dBm/m	dB	dB/m	
1	33.51	-62.47	-60.63	-13.00	-49.47	-1.84	Peak
2	186.33	-53.58	-47.23	-13.00	-40.58	-6.35	Peak
3	247.08	-51.41	-45.60	-13.00	-38.41	-5.81	Peak
4	359.50	-62.74	-56.81	-13.00	-49.74	-5.93	Peak
5	531.00	-54.98	-52.71	-13.00	-41.98	-2.27	Peak
6 pp	664.70	-42.66	-43.46	-13.00	-29.66	0.80	Peak
7	1672.80	-57.24	-44.42	-13.00	-44.24	-12.82	Peak



A D T



Bureau Veritas Consumer Products Services Ltd., Taoyuan Branch

A D T

Data: 10

Date: 2012-04-25

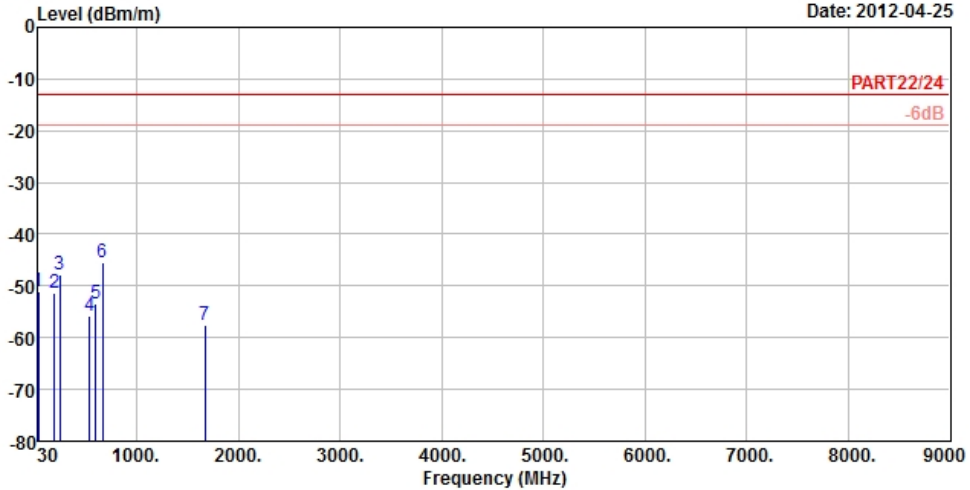

Site : 966 Chamber 5
 Condition : PART22/24 3m EIRP_RSE_1G~19G_3 VERTICAL
 Brand/Model: E110
 Remark : Band V Link
 Tested by : Kay Wu
 Temperature : 25°C
 Humidity : 65%
 Plane : Y

	Freq	Level	Read Level	Limit Line	Over Limit	Factor	Remark
	MHz	dBm/m	dBm	dBm/m	dB	dB/m	
1	30.81	-50.93	-51.27	-13.00	-37.93	0.34	Peak
2	186.60	-51.49	-45.14	-13.00	-38.49	-6.35	Peak
3	243.57	-47.83	-41.84	-13.00	-34.83	-5.99	Peak
4	533.10	-55.78	-53.59	-13.00	-42.78	-2.19	Peak
5	598.90	-53.41	-53.01	-13.00	-40.41	-0.40	Peak
6 pp	666.10	-45.54	-46.38	-13.00	-32.54	0.84	Peak
7	1672.80	-57.43	-44.61	-13.00	-44.43	-12.82	Peak



A D T

5 PHOTOGRAPHS OF THE TEST CONFIGURATION

Please refer to the attached file (Test Setup Photo).



A D T

6 INFORMATION ON THE TESTING LABORATORIES

We, Bureau Veritas Consumer Products Services (H.K.) Ltd., Taoyuan Branch, were founded in 1988 to provide our best service in EMC, Radio, Telecom and Safety consultation. Our laboratories are accredited and approved according to ISO/IEC 17025.

If you have any comments, please feel free to contact us at the following:

Linko EMC/RF Lab:

Tel: 886-2-26052180

Fax: 886-2-26051924

Hsin Chu EMC/RF Lab:

Tel: 886-3-5935343

Fax: 886-3-5935342

Hwa Ya EMC/RF/Safety/Telecom Lab:

Tel: 886-3-3183232

Fax: 886-3-3270892

Email: service.adt@tw.bureauveritas.com

Web Site: www.adt.com.tw

The address and road map of all our labs can be found in our web site also.



A D T

7 APPENDIX A – MODIFICATIONS RECORDERS FOR ENGINEERING CHANGES TO THE EUT BY THE LAB

No any modifications are made to the EUT by the lab during the test.

---END---