

RF Test Report

Applicant : Getac Technology Corporation
 Product Name : Wireless Module
 Trade Name : Getac
 Model Number : EM9190U
 Applicable Standard : FCC 47 CFR PART 22H
 FCC 47 CFR PART 24E
 FCC 47 CFR PART 27L
 ANSI C63.26 2015
 Received Date : May 22, 2023
 Test Period : Jun. 14 ~ Jun. 20, 2023
 Issued Date : Jul. 19, 2023

Issued by

Eurofins E&E Wireless Taiwan Co., Ltd.
 No. 140-1, Changan Street, Bade District,
 Taoyuan City 334025, Taiwan (R.O.C.)
 Tel : +886-3-2710188 / Fax : +886-3-2710190



Taiwan Accreditation Foundation accreditation number: 1330

Frequency Range : 9 kHz to 40 GHz

Test Firm MRA designation number: TW0010 (Bade test site)

Test Firm MRA designation number: TW0034 (Wugu test site)

Note:

1. The test results are valid only for samples provided by customers and under the test conditions described in this report.
2. This report shall not be reproduced except in full, without the written approval of Eurofins E&E Wireless Taiwan Co., Ltd.
3. The relevant information is provided by customers in this test report. According to the correctness, appropriateness or completeness of the information provided by the customer, if there is any doubt or error in the information which affects the validity of the test results, the laboratory does not take the responsibility.

Revision History

Version	Issued Date	Revisions	Revised By
00	Jul. 19, 2023	Initial Issue	Snow Wang

Verification of Compliance

Applicant : Getac Technology Corporation

Product Name : Wireless Module

Trade Name : Getac

Model Number : EM9190U

FCC ID : QYLEM9190U

Applicable Standard : FCC 47 CFR PART 22H
FCC 47 CFR PART 24E
FCC 47 CFR PART 27L
ANSI C63.26 2015

Test Result : Complied

Performing Lab. : Eurofins E&E Wireless Taiwan Co., Ltd.
No. 140-1, Changan Street, Bade District,
Taoyuan City 334025, Taiwan (R.O.C.)
Tel : +886-3-2710188 / Fax : +886-3-2710190
Taiwan Accreditation Foundation accreditation number: 1330



Eurofins E&E Wireless Taiwan Co., Ltd. tested the above equipment in accordance with the requirements set forth in the above standards. All indications of Pass/Fail in this report are opinions expressed by Eurofins E&E Wireless Taiwan Co., Ltd. based on interpretations and/or observations of test results. The test results show that the equipment tested is capable of demonstrating compliance with the requirements as documented in this report.

Approved By : _____

TABLE OF CONTENTS

1	General Information	5
1.1.	EUT Description	5
1.2.	Testing Location	5
1.3.	Mode of Operation.....	6
1.4.	EUT Test Step	7
1.5.	Configuration of Test System Details.....	7
1.6.	Test Instruments	8
1.7.	Test Site Environment.....	10
1.8.	Measurement Uncertainty	10
1.9.	Summary of Test Result	11
2	Measurement Procedure.....	12
2.1.	Field Strength of Spurious Radiation Test	12
3	Test Results	15
3.1.	Field Strength of Spurious Radiation	15

Appendix A. Test Setup Photographs

1 General Information

1.1. EUT Description

Applicant	Getac Technology Corporation 5F.,Building A,No.209,Sec.1 Nangang.,Rd., Taipei City, 11568, Taiwan			
Product Name	Wireless Module			
Trade Name	Getac			
Model Number	EM9190U			
FCC ID	QYLEM9190U			
Host Information	Product Name: Tablet Trade Name: Getac Model Name: UX10, UX10G3, UX10-301, UX10-321, UX10-Ex, UX10Y(Y= 10 characters, Y can be 0 to 9, A to Z, a to z, "/", "\", "-", "_ " or blank for marketing purpose) (All models are electrically identical, different model names are for marketing purpose.)			
IMEI No.	351891305000595			
Mode	Band	UL Frequency (MHz)	DL Frequency (MHz)	Modulation
WCDMA(RMC12.2K)/	II	1852.4 ~ 1907.6	1932.4 ~ 1987.6	QPSK, BPSK
	V	826.4 ~ 846.6	871.4 ~ 891.6	QPSK, BPSK
	IV	1712.4 ~ 1752.6	2112.4 ~ 2152.6	QPSK, BPSK
Antenna information	Type		Max. Gain (dBi)	
	PIFA Antenan		WCDMA Band II	2.5
			WCDMA Band V	0.8
WCDMA Band IV			3.0	
Operate Temp. Range	-40 ~ +85 °C			
EUT Power Rating	DC 3.3V			

EUT Modify Description :

Modify Description:
Add host model: UX10, UX10G3, UX10-301, UX10-321, UX10-Ex, UX10Y(Y= 10 characters, Y can be 0 to 9, A to Z, a to z, "/", "\", "-", "_ " or blank for marketing purpose).

After our evaluation, the retest of Simultaneous Transmitter of Spurious Radiated is required.
The other test data refer to the original report.

1.2. Testing Location

Lab Name: Eurofins E&E Wireless Taiwan Co., Ltd.

Site Address: No. 140-1, Changan Street, Bade District, Taoyuan City 334025, Taiwan (R.O.C.)

Site Address: No. 2, Wuquan 5th Rd. Wugu Dist., New Taipei City, Taiwan (R.O.C.)

1.3. Mode of Operation

Eurofins has verified the construction and function in typical operation. All the test modes were carried out with the EUT in normal operation, which was shown in this test report and defined as:

Test Mode
WCDMA Band IV Link Mode

Note: Regards to the frequency band operation: the lowest, middle and highest frequency of channel were selected to perform the test, then shown on this report.

By preliminary testing and verifying three axis (X, Y and Z) position of EUT transmitted status, it was found that "Y axis" position was the worst, then the final test was executed the worst condition and test data were recorded in this report.

1.4. EUT Test Step

1	Setup the EUT shown on “Configuration of Test System Details”.
2	Turn on the power of all equipment.

1.5. Configuration of Test System Details

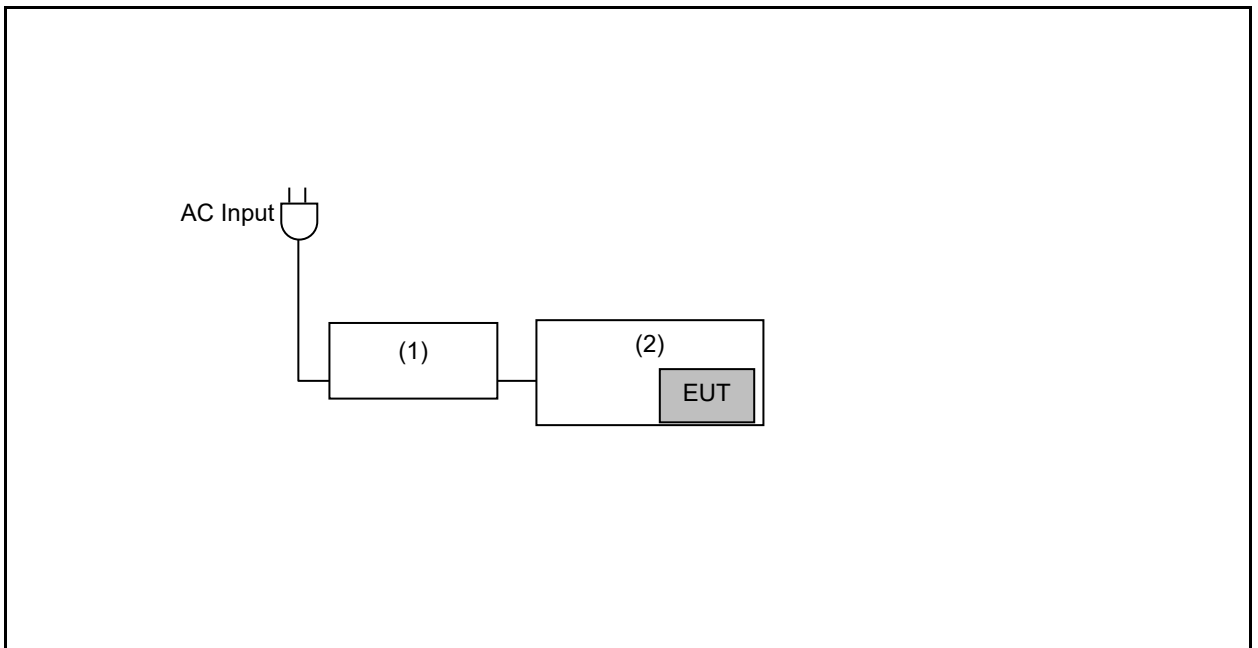

Devices Description					
	Product	Manufacturer	Model Number	Serial Number	Power Cord
(1)	Adapter	FSP	FSP065-RBBN3	---	---
(2)	Tablet	Getac	UX10G3	---	---

1.6. Test Instruments

For Radiated Emissions

Test Period: Jun. 14 ~ Jun. 20, 2023

Testing Engineer: Marin Lee

Radiation test sites		Semi Anechoic Room				
Use	Equipment	Manufacturer	Model Number	Serial Number	Cal. Date	Cal. Period
<input checked="" type="checkbox"/>	LOOP Antenna (9 kHz~30 MHz)	Schwarzbeck Mess-Elektronik	FMZB 1513-60	00031	Feb. 21, 2023	1 year
<input checked="" type="checkbox"/>	Trilog Broadband Antenna (30 MHz~1 GHz)	Schwarzbeck Mess-Elektronik	VULB9168	01276	Feb. 09, 2023	1 year
<input checked="" type="checkbox"/>	Broadband Horn Antenna (1 GHz~18 GHz)	RF SPIN	DRH18-E	210305A18ES	Feb. 21, 2023	1 year
<input checked="" type="checkbox"/>	Broadband Horn Antenna (15 GHz~40 GHz)	Schwarzbeck Mess-Elektronik	BBHA9170	01133	Feb. 13, 2023	1 year
<input checked="" type="checkbox"/>	Spectrum Analyzer (10 Hz~44 GHz)	KEYSIGHT	N9020B	MY60112362	Feb. 16, 2023	1 year
<input checked="" type="checkbox"/>	UXM 5G Wireless Test Platform	KEYSIGHT	E7515B	MY59020225	Mar. 1, 2023	1 year
<input checked="" type="checkbox"/>	Radio Communication Analyzer	Anritsu	MT821C	6272459653	Oct. 4, 2022	1 year
<input checked="" type="checkbox"/>	Pre-Amplifier	Agilent	8447D	2944A10961	Jul. 07, 2022	1 year
<input checked="" type="checkbox"/>	Pre-Amplifier	EMCI	EMC118A45SE	980822	Nov. 22, 2022	1 year
<input checked="" type="checkbox"/>	Coaxial Cable (10 kHz~3000 MHz)	EMCI	EMCCFD400-NM-NM-2000	211006	Nov. 14, 2022	1 year
<input checked="" type="checkbox"/>	Coaxial Cable (10 kHz~3000 MHz)	EMCI	EMCCFD400-NM-NM-2000	211007	Nov. 14, 2022	1 year
<input checked="" type="checkbox"/>	Coaxial Cable (10 kHz~3000 MHz)	EMCI	EMCCFD400-NM-NM-6000	211015	Nov. 14, 2022	1 year
<input checked="" type="checkbox"/>	Coaxial Cable (1 GHz~18 GHz)	EMCI	EMC104-SM-SM-1000	211026	Nov. 14, 2022	1 year
<input checked="" type="checkbox"/>	Coaxial Cable (1 GHz~18 GHz)	EMCI	EMC104-SM-SM-2000	211035	Nov. 14, 2022	1 year
<input checked="" type="checkbox"/>	Coaxial Cable (1 GHz~18 GHz)	EMCI	EMC104-SM-SM-8000	211036	Nov. 14, 2022	1 year

For Radiated Emissions
 Test Period: Jun. 14 ~ Jun. 20, 2023
 Testing Engineer: Marin Lee

Radiation test sites		Semi Anechoic Room				
Use	Equipment	Manufacturer	Model Number	Serial Number	Cal. Date	Cal. Period
<input checked="" type="checkbox"/>	Coaxial Cable (18 GHz~40 GHz)	EMCI	EMC101G-KM- KM-600	211211	Jan. 19, 2023	1 year
<input checked="" type="checkbox"/>	Coaxial Cable (18 GHz~40 GHz)	EMCI	EMC101G-KM- KM-2000	211210	Jan. 19, 2023	1 year
<input checked="" type="checkbox"/>	Coaxial Cable (18 GHz~40 GHz)	EMCI	EMC101G-KM- KM-6000	211209	Jan. 19, 2023	1 year
<input checked="" type="checkbox"/>	Highpass Filter	Warison	WFIL-H3000- 20000F	WR4BBFWC2B1	Nov. 14, 2022	1 year
<input checked="" type="checkbox"/>	Highpass Filter	Warison	WFIL-H8000- 26000F	001	Nov. 14, 2022	1 year
<input checked="" type="checkbox"/>	Software	R_RAM	V1.3	N/A	N.C.R.	---

Note: N.C.R. = No Calibration Request

1.7. Test Site Environment

Items	Required (IEC 60068-1)	Actual
Temperature (°C)	15-35	20-30
Humidity (%RH)	25-75	45-75

1.8. Measurement Uncertainty

Parameter	Uncertainty
Radiated Emission	5.0 dB

1.9. Summary of Test Result

FCC Rule	Description	Result
§2.1046	Conducted Output Power	N/A (Note 1)
§22.913(a)(5)	Effective Radiated Power	N/A (Note 1)
§24.232(c) §27.50(d)(4)	Equivalent Isotropic Radiated Power	N/A (Note 1)
§24.232(d) §27.50 KDB 971168 D01 (5.7.1)	Peak to average ratio	N/A (Note 1)
§2.1049 §22.917(a) §24.238(a) §27.53(g)	Emission Bandwidth & Occupied Bandwidth	N/A (Note 1)
§2.1051 §22.917(a) §24.238(a) §27.53(h)	Band Edge Measurement	N/A (Note 1)
§2.1051 §22.917(a) §24.238(a) §27.53(h)	Conducted Spurious Emission	N/A (Note 1)
§2.1053 §22.917(a) §24.238(a) §27.53(h)	Field Strength of Spurious Radiation	Pass (Note 2)
§2.1055 §22.355 §24.235 §27.54	Frequency Stability for Temperature & Voltage	N/A (Note 1)

Note 1: No need for verification.

Note 2: Only verify the Simultaneous Transmission.

Decision Rule

- Uncertainty is not included.
- Uncertainty is included.

2 Measurement Procedure

2.1. Field Strength of Spurious Radiation Test

■ Limit

The power of any emission outside of the authorized operating frequency ranges must be attenuated below the transmitting power (P) by a factor of at least $43 + 10 \log(P)$ dB.

It is measured by means of a calibrated spectrum analyzer and scanned from 30 MHz up to a frequency including its 10th harmonic.

■ Setup

Below 1 GHz

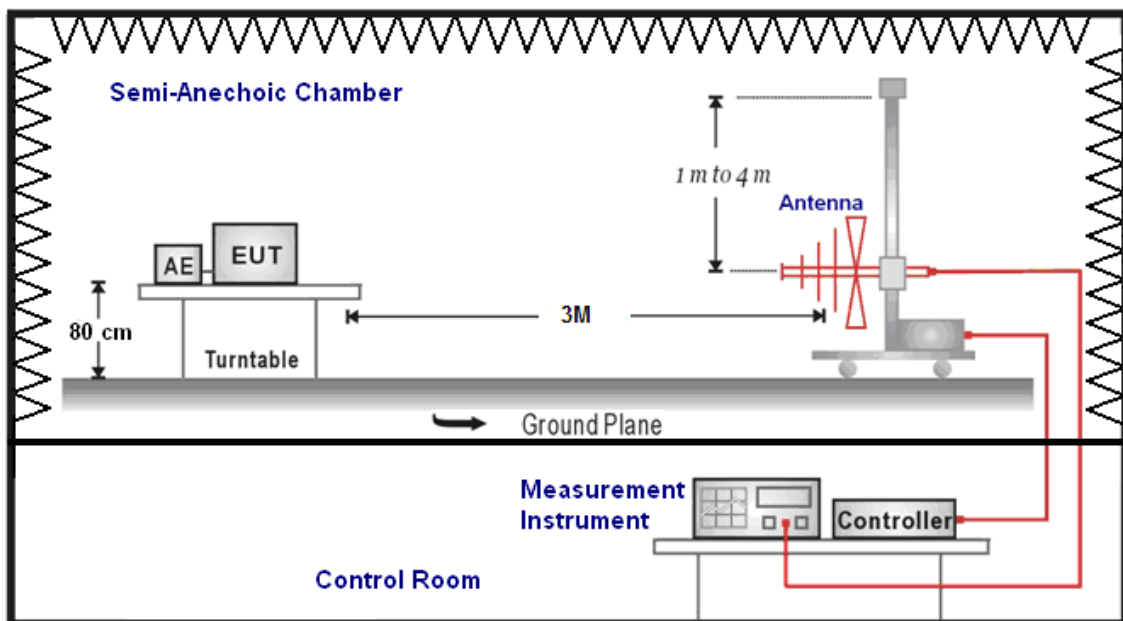

Above 1 GHz

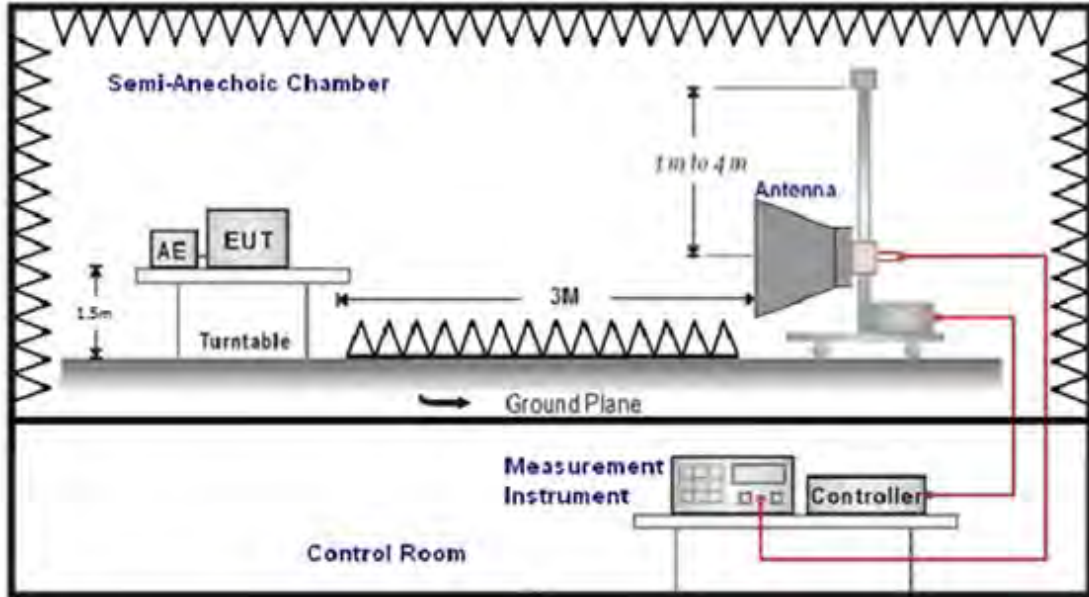

For Substituted Method Test Set-UP

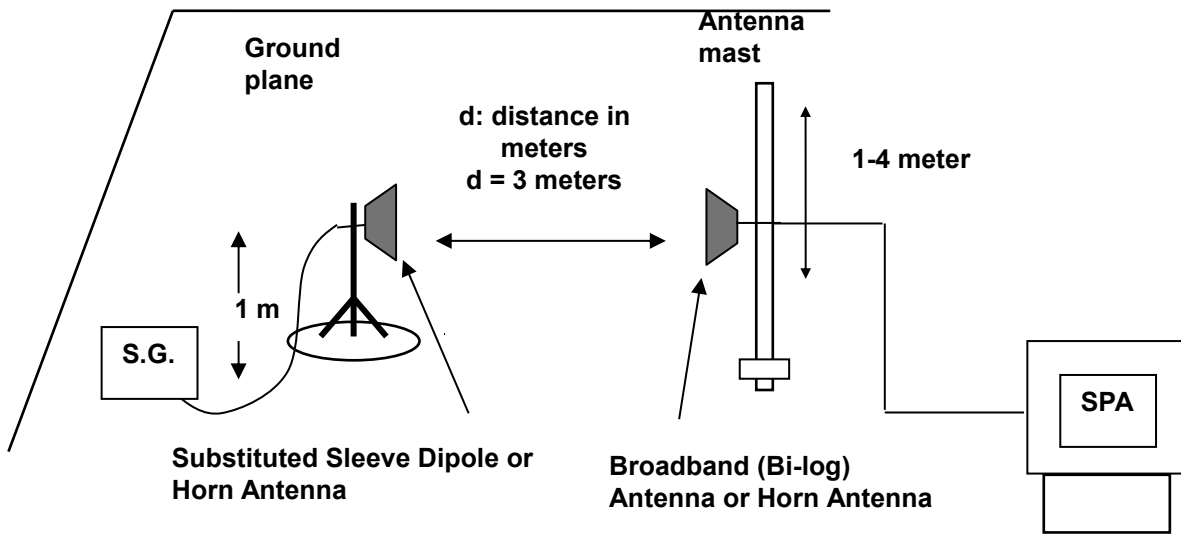

■ **Test Procedure**

- a. The EUT was set up for the maximum power with wwan link data modulation. The power was measured with Spectrum Analyzer. All measurements were done at 3 channels (low, middle and high operational frequency range).
- b. E.I.R.P power measurement. In the semi-anechoic chamber, EUT placed on the 0.8 m (1.5 m for above 1 GHz) height of Turn Table, rotated the table around 360 degrees to search the maximum radiation power and receiver antenna shall be rotated vertical and horizontal polarization and moved height from 1 m to 4 m to find the maximum polar radiated power. The "Read Value" is the spectrum reading the maximum power value.
- c. The substitution antenna (Note:1 & 2) is substituted for EUT at the same position and signals generator export the CW signal to the substitution antenna via a TX cable. Rotated the Turn Table and moved receiving antenna to find the maximum radiation power. Adjust output power level of S.G to get a Value of spectrum reading equal to "Read Value" of step a. Record the power level of S.G.
- d. E.I.R.P. = Output power level of S.G - TX cable loss + Antenna gain of substitution horn
- e. E.R.P. = E.I.R.P.- 2.15 dB
- f. Measurement range 9 kHz - 10 th Harmonic

Note: 1. Below 1 GHz Substituted Method Test : Sleeve dipole antenna to Bi-Log Antenna
 2. Above 1 GHz Substituted Method Test : Horn antenna to Horn Antenna

3 Test Results

3.1. Field Strength of Spurious Radiation

Test Site:	96602	Standard:	Part 22/24/27
Test Mode:	3G + BT + wifi 2.4G		
Polarization:	Horizontal		
ReMark:			

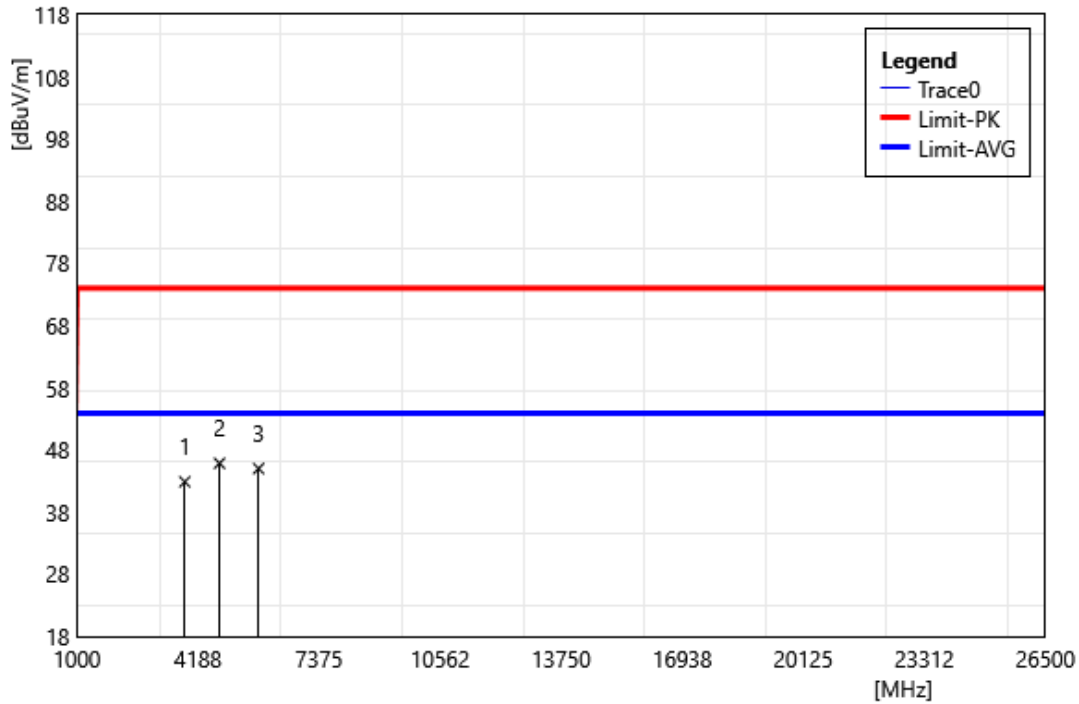

ID	Frequency MHz	Reading dBuV	Correct Factor dB/m	Result dBuV/m	Limit dBuV/m	Margin dB	ReMark
1	3839.16	80.79	-37.91	42.88	74.00	-31.12	PEAK
2	4755.24	97.68	-51.83	45.85	74.00	-28.15	PEAK
3	5783.22	115.64	-70.64	45.00	74.00	-29.00	PEAK

Test Site:	96602	Standard:	Part 22/24/27
Test Mode:	3G + BT + wifi 2.4G		
Polarization:	Vertical		
ReMark:			

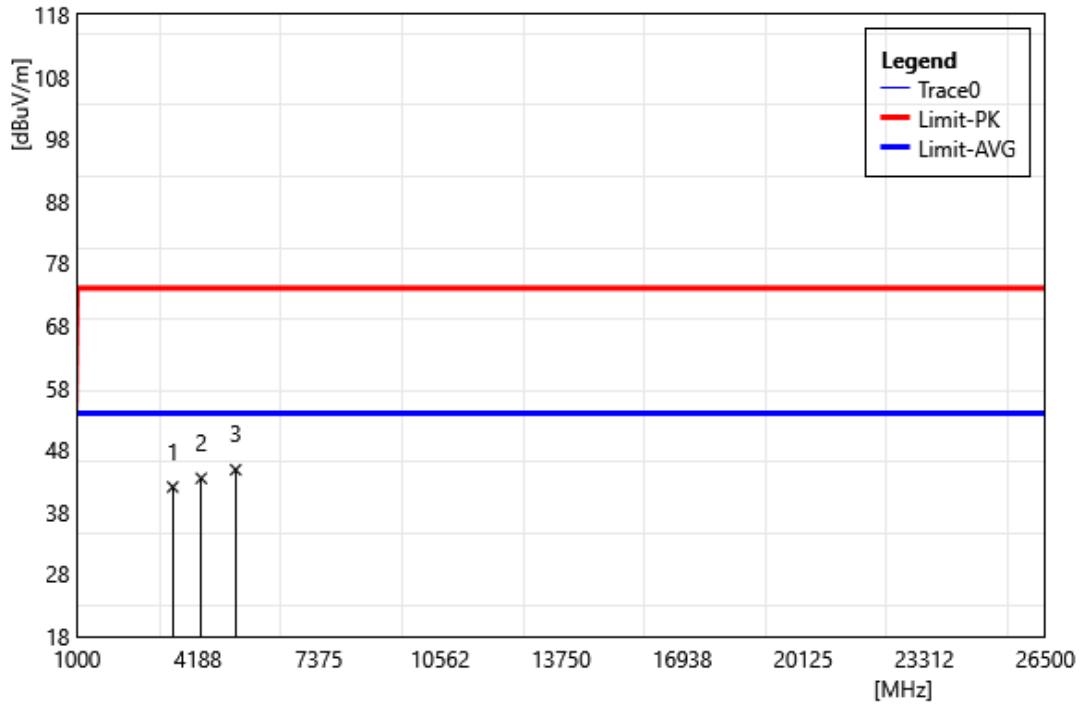

ID	Frequency MHz	Reading dBuV	Correct Factor dB/m	Result dBuV/m	Limit dBuV/m	Margin dB	ReMark
1	3524.48	75.66	-33.63	42.03	74.00	-31.97	PEAK
2	4272.73	89.31	-45.87	43.44	74.00	-30.56	PEAK
3	5181.82	105.02	-60.22	44.80	74.00	-29.20	PEAK

Test Site:	96602	Standard:	Part 22/24/27
Test Mode:	3G + BT + wifi 5G		
Polarization:	Horizontal		
ReMark:			

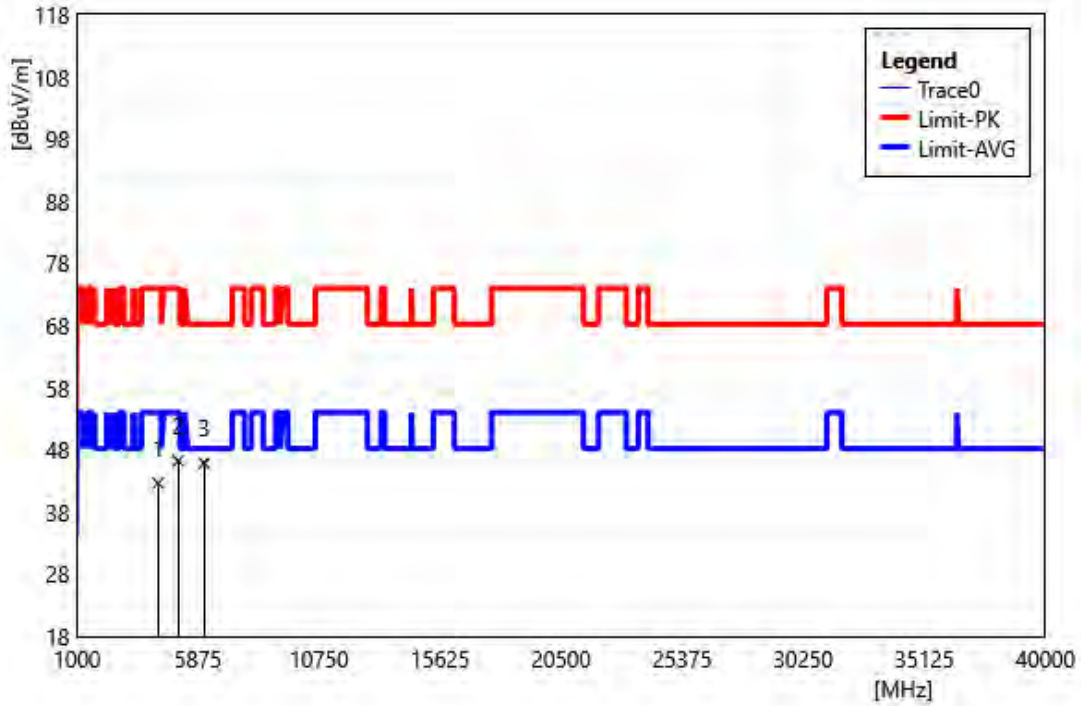

ID	Frequency MHz	Reading dBuV	Correct Factor dB/m	Result dBuV/m	Limit dBuV/m	Margin dB	ReMark
1	4265.73	43.09	-0.44	42.65	74.00	-31.35	PEAK
2	5083.92	43.81	2.41	46.22	74.00	-27.78	PEAK
3	6118.88	41.68	4.20	45.88	68.20	-22.32	PEAK

Test Site:	96602	Standard:	Part 22/24/27
Test Mode:	3G + BT + wifi 5G		
Polarization:	Vertical		
ReMark:			

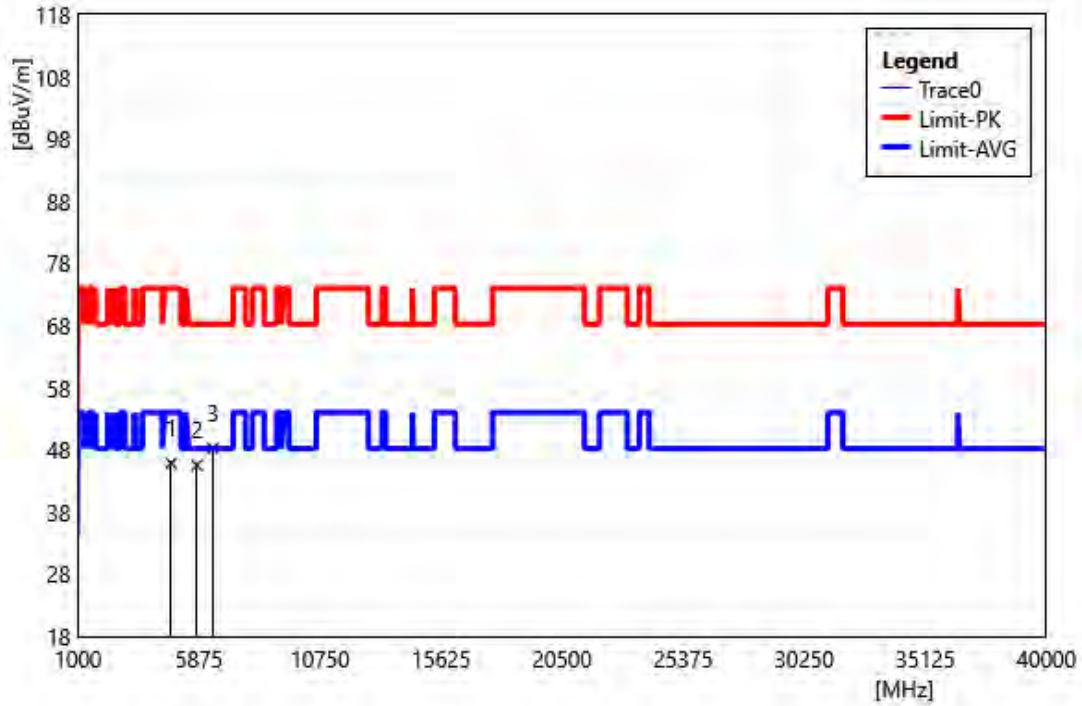

ID	Frequency MHz	Reading dBuV	Correct Factor dB/m	Result dBuV/m	Limit dBuV/m	Margin dB	ReMark
1	4755.24	43.14	2.71	45.85	74.00	-28.15	PEAK
2	5790.21	41.95	3.58	45.53	68.20	-22.67	PEAK
3	6433.57	41.22	7.07	48.29	68.20	-19.91	PEAK

Test Site:	96602	Standard:	Part 22/24/27
Test Mode:	3G + BT + wifi 6E		
Polarization:	Horizontal		
ReMark:			

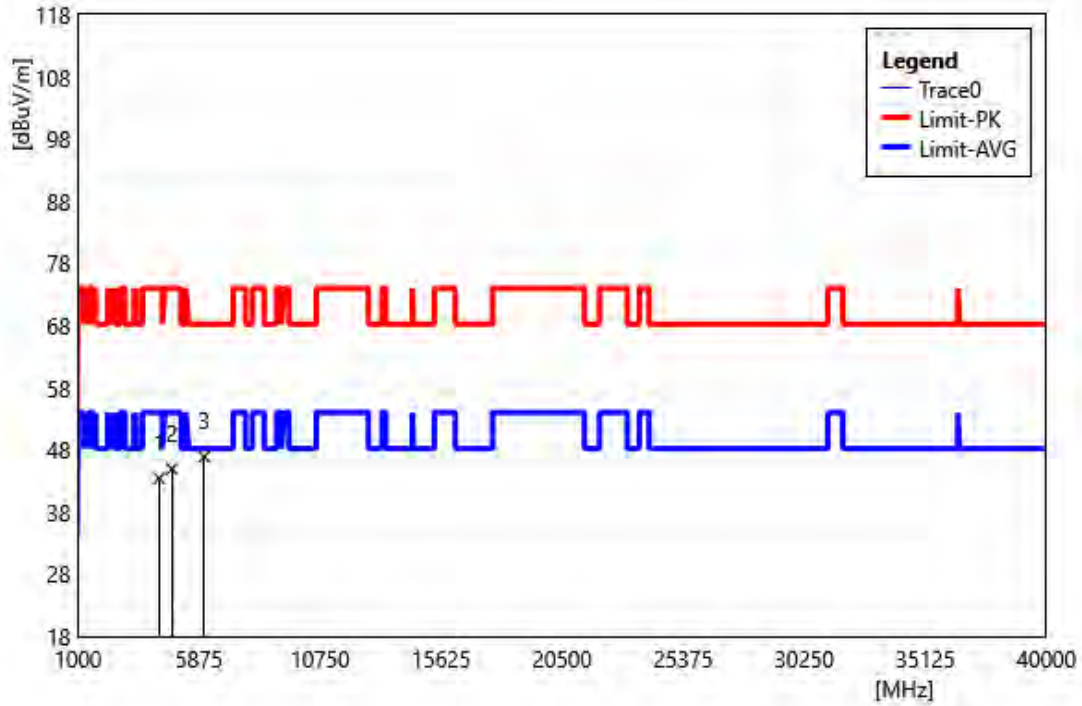

ID	Frequency MHz	Reading dBuV	Correct Factor dB/m	Result dBuV/m	Limit dBuV/m	Margin dB	ReMark
1	4272.73	43.84	-0.40	43.44	74.00	-30.56	PEAK
2	4783.22	42.86	2.08	44.94	74.00	-29.06	PEAK
3	6083.92	42.72	4.18	46.90	68.20	-21.30	PEAK

Test Site:	96602	Standard:	Part 22/24/27
Test Mode:	3G + BT + wifi 6E		
Polarization:	Vertical		
ReMark:			

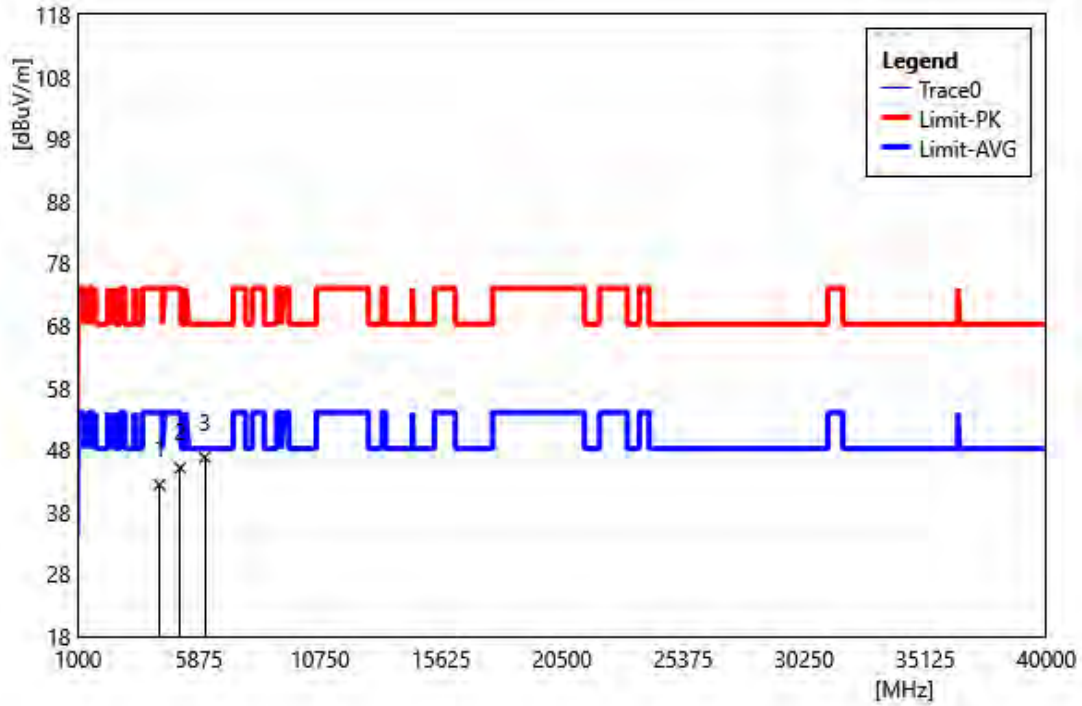

ID	Frequency MHz	Reading dBuV	Correct Factor dB/m	Result dBuV/m	Limit dBuV/m	Margin dB	ReMark
1	4286.71	42.74	-0.34	42.40	74.00	-31.60	PEAK
2	5118.88	42.58	2.50	45.08	74.00	-28.92	PEAK
3	6111.89	42.61	4.17	46.78	68.20	-21.42	PEAK

--- END---