

Getac

F110 Series

USER MANUAL

October 2023

Trademarks

The Bluetooth® word mark and logos are registered trademarks owned by

Bluetooth SIG, Inc.

Thunderbolt is a trademark of Intel Corporation or its subsidiaries.

All other brand and product names are trademarks or registered trademarks of their respective companies.

Disclaimer

Specifications and manuals are subject to change without notice. Getac assumes no liability for damage incurred directly or indirectly from errors, omissions, or discrepancies between the device and the manuals.

Note

For the latest version of the manual, please visit the Getac website at www.getac.com.

Table of Contents

Chapter 1	Getting Started	1
	Getting the Tablet PC Running	2
	Unpacking	2
	Installing the Battery Packs.....	3
	Installing the Micro-SIM Card (Optional).....	4
	Connecting to AC Power	5
	Using the Tether.....	6
	Turning On and Off the Tablet PC	8
	Taking a Look at the Tablet PC.....	9
	Front Components	9
	Rear Components	12
	Right-Side Components	13
	Left-Side Components	14
	Top Components.....	16
	Bottom Components	17
Chapter 2	Operating Your Tablet PC	18
	Navigating on the Screen	19
	Using the Touchscreen	19
	Using the Dual Mode Display (Optional).....	23
	Using Network and Wireless Connections	24
	Using the LAN (Optional)	24
	Using the WLAN.....	25

	Using the Bluetooth Feature	26
	Using the WWAN Feature (Optional).....	27
	Using the Fingerprint Scanner (Optional).....	29
	Using the Barcode Scanner (Optional)	31
	Notes	32
Chapter 3	Managing Power	33
	AC Adapter	34
	Battery Pack	36
	Charging the Battery Pack	36
	Initializing the Battery Pack.....	37
	Checking the Battery Level	37
	Battery Low Signals and Actions	38
	Replacing the Battery Pack.....	39
	Power-Saving Tips	43
Appendix A	Specifications	44
Appendix B	Regulatory Information	48
	Safety Notices	49
	About the Battery	49
	About the AC Adapter	52
	Heat Related Concerns.....	53
	North America	54
	USA.....	54
	Canada.....	58
	User Notification of Take-back Service.....	59
	Europe Marking and Compliance Notices.....	61
	Statements of Compliance	61
	Restriction of Hazardous Substances (RoHS) Directive.....	64
	About F110-Ex	65
	Special Conditions for Safe Use	65

Anti-Explosion Protective Covers.....	65
Use of Accessories	66
ENERGY STAR.....	67
About Battery and External Enclosure Replacement.....	68
Battery.....	68
External Enclosure	68

Chapter 1

Getting Started





This chapter first tells you step by step how to get the Tablet PC up and running. Then, you will find a section briefly introducing the external components of the Tablet PC.

CAUTION: Safety instructions are provided in related sections throughout the User Manual. Please read the manual and any accompanying document(s) before starting to use the product.

Getting the Tablet PC Running

Unpacking

After unpacking the shipping carton, you should find these standard items:

● F110 Tablet PC	
● AC adapter 	● AC power cord 
● Battery pack x 2 	● Stylus 
● Document(s)	● Tether 
	● Driver disc (optional)

Inspect all the items. If any item is damage or missing, notify your dealer immediately.

NOTE: Specific models do not have the AC adapter and power cord as standard items. To purchase the AC adapter kit for your model, contact a Getac authorized distributor. (Check <https://www.getac.com/en/contact/> for contact information.)

Installing the Battery Packs

Your Tablet PC has two battery compartments for two battery packs; each is installed in the same way.

1. With the battery pack correctly oriented, attach its connector side to the battery compartment at an angle (❶) and then press down the other side (❷).

NOTE: If you have the high-capacity battery model, the battery pack looks different from the one shown here. The removal/installation method is the same.



2. Slide the battery latch toward the locked position (🔒).

CAUTION: Make sure the battery latch is correctly locked, not revealing the underneath red part.



Correct



Incorrect (revealing red part)

Installing the Micro-SIM Card (Optional)

1. Locate the micro-SIM card slot. Slide the protective cover to the unlocked position and open the cover.



2. Remove one screw to detach the small metal plate that covers the micro-SIM card slot.

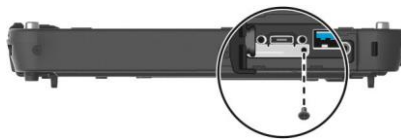

3. Noting the orientation, insert the micro-SIM card all the way into the slot.

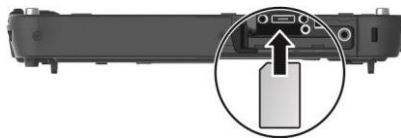

NOTE: To remove the micro-SIM card, just push in the card to release it and then pull it out.

4. Close the cover.

Connecting to AC Power

CAUTION: Use only the AC adapter included with your Tablet PC. Using other AC adapters may damage the Tablet PC.

NOTE:

- The battery pack is shipped to you in power saving mode that protects it from charging/discharging. It will get out of the mode to be ready for use when you install the battery pack and connect AC power to the Tablet PC for the very first time.
- When the AC adapter is connected, it also charges the battery pack. For information on using battery power, see Chapter 3.

You must use AC power when starting up the Tablet PC for the very first time.

1. Plug the DC cord of the AC adapter to the power connector of the Tablet PC (❶).
2. Plug the female end of the AC power cord to the AC adapter and the male end to an electrical outlet (❷).

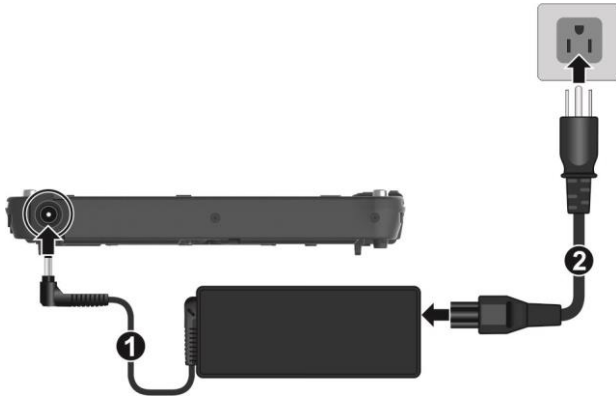

NOTE: The power cord type varies with countries. The look of your power cord and electrical outlet might not match the one shown in this document.

3. Power is being supplied from the electrical outlet to the AC adapter and onto your Tablet PC. Now, you are ready to turn on the Tablet PC.

Using the Tether

A tether is provided for attaching the stylus to your Tablet PC.

1. Thread one of the tether's loops through the hole of the stylus (1). Then, insert the other loop through the first loop (2) and pull the tether tight.

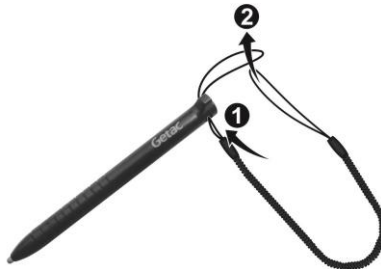

2. Insert the other loop to the tether hole on the Tablet PC (❶). Then, insert the stylus through the loop (❷) and pull it tight.

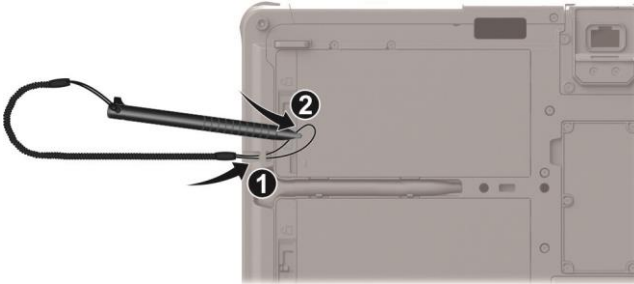

3. When storing the stylus in the holder, note the orientation of the stylus. There is a protruding part at the end of the stylus. This part should not point toward the holder.

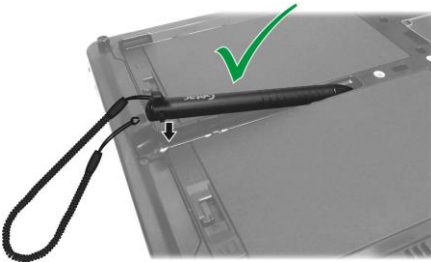

To take the stylus out of the holder, you can either pull the tether or, as shown below, insert your finger to the space at the end of the stylus and pry it up.



Turning On and Off the Tablet PC



Turning On

Press the power button (). The Windows operating system should start.

NOTE: Tapping the screen during startup may invoke a pre-boot menu (unless the default settings have been changed). If the menu appears, simply select Continue.

Turning Off

When you finish a working session, you can stop the system by turning off the power or leaving it in Sleep or Hibernation mode:

To...	Do this...
Power off (Shutdown)	Tap Start →  Power → Shut down.
Sleep	Press the power button.* -or- Tap Start →  Power → Sleep.
Hibernate	By default, this option is not shown in the Start menu. If you want to use the feature, set up accordingly in Windows settings.

* “Sleep” is the default setting of the power button. You may change what the power button does in Windows settings.

Taking a Look at the Tablet PC

NOTE: Depending on the model you purchased, the appearance of your Tablet PC may not be exactly the same as those shown in this manual.

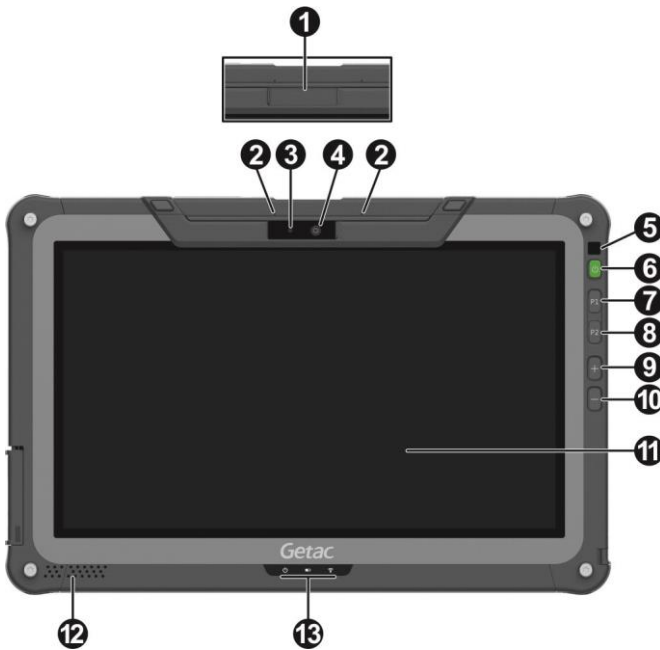

CAUTION: You need to open the protective covers to access the connectors. When not using a connector, make sure to close the cover completely for water- and dust-proof integrity. (Engage the locking mechanism if existing.)

Front Components



Ref	Component	Description
1	Camera cover (optional)	Covers the camera lens. Slide the cover to open or close it. The cover provides privacy protection.

Ref	Component	Description	
②	Microphone	Receives sound and voice to record voice.	
③	IR sensor (optional)	<p>Detects the infrared energy of objects to form an image. The sensor flashes red light when in use.</p> <p>The near infrared (IR) imaging capability allows you to use Windows Hello face authentication.</p>	
④	Camera lens (optional)	Allows you to use the camera function. When the camera lens is in use, the indicator beside it lights up.	
⑤	Light sensor	Senses the ambient light for automatic adjustments of the display backlight.	
⑥	Power button	Turns the power on or off. (The default “off” state is “Sleep mode.”)	
⑦	P1 button	Trigger	Serves as the trigger button for the barcode scanner if your model has the option.
		Camera	<p>Starts the G-Camera application and serves as the shutter release button.</p> <p>This is the default function for models without the barcode scanner.</p>
⑧	P2 button	Opens or closes the OSD Control Panel.	
		<p>When pressed longer: Serves as the Ctrl+Alt+Del keyboard keys.</p>	
⑨	Plus button	Increases the sound volume.	
⑩	Minus button	Decreases the sound volume.	

Ref	Component	Description
11	Touchscreen	Displays and receives information for the Tablet PC.
12	Speaker	Sends out sound and voice from your Tablet PC.
13	 Power	Lights blue when the power is on.
		Blinks blue when the system is in Sleep mode.
	 Battery	Lights amber when the battery is being charged.
		Lights green when battery charging is completed.
		Blinks green to indicate the battery's built-in high temperature protection mechanism is activated.
		CAUTION: Do not remove the battery during this period.
		Blinks red (once per second) when the battery's capacity is below 10%.
		Blinks red rapidly (once per 0.5 second) when there is a thermal protection problem. Ask for repair service in case this happens.
	Blinks amber when the battery charging is in an abnormal state. Replace the battery in case this happens.	
	 Airplane mode	Lights blue when the RF (Radio Frequency) radio of any RF feature (WLAN/Bluetooth/WWAN) is on. If Airplane mode is switched on, the light turns off.

NOTE:

- The hardware buttons (except the power button) can be re-defined using G-Manager.
- Some of the hardware buttons provide keyboard key functions on “POST/BIOS Setup/Non-ACPI” occasions. (See “Button Functions on Special Occasions” in Appendix A for information.)

Rear Components

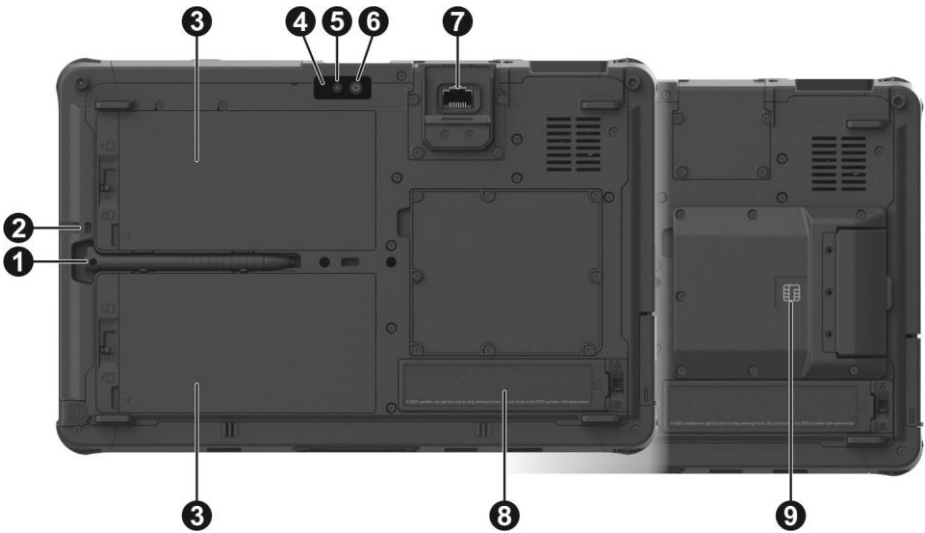

Ref	Component	Description
①	Stylus	Serves as the input device by tapping on the touchscreen to make selections and enter information.
②	Tether hole	Stylus can be tethered to this hole.
③	Battery pack	Supplies power to your Tablet PC when external power is not connected.

		NOTE: If you have the high-capacity battery model, the battery pack looks different from the one shown here.
4	Camera indicator (optional)	Lights up when the camera lens beside it is in use.
5	Flash (optional)	Provides extra light when taking pictures.
6	Camera lens (optional)	Allows you to use the camera function.
7	RJ45 connector (optional)	Connects the LAN cable. NOTE: This option comes together with the RS-232 serial port (located at the top side).
8	SSD module	Contains the solid-state drive, which is the mass storage device of your Tablet PC. CAUTION: This device is not hot-swappable. Do not remove it without turning off the system first.
9	Smart card reader (optional)	Accepts a smart card for additional security feature.

Right-Side Components

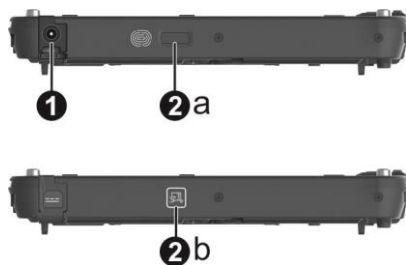

Ref	Component	Description
①	Power connector	Connects the AC adapter.
②	Select models have one of the below components.	
a	Fingerprint scanner	Serves as the fingerprint verification, preventing unauthorized access to your Tablet PC.
b	RFID reader	Reads data from RFID tags.

Left-Side Components

For covers with an arrowhead icon, push the cover toward one side to unlock and the other side to lock. The arrowhead points to the side for unlocking.

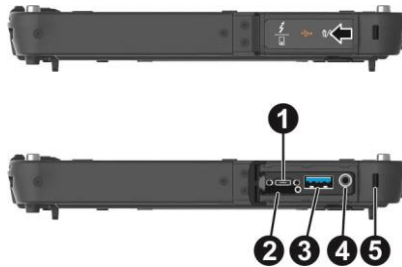

Ref	Component	Description
①	USB-C Thunderbolt™ 4 port	Connects to devices that support Thunderbolt or USB-C connection.
②	Micro-SIM card slot (optional)	Accepts a micro-SIM card for models having the WWAN module. NOTE: The slot still exists but cannot be used for models without the WWAN module.

Ref	Component	Description
③	USB 3.2 Gen 2 port	Connects a USB device.
④	Combo audio connector	<p>Connects a set of headphones or external speakers with amplifier.</p> <hr/> <p>Supports a headset microphone with 4-pole TRRS 3.5mm jack.</p>
⑤	Kensington lock	Locks the Tablet PC to a stationary object for security.

Top Components

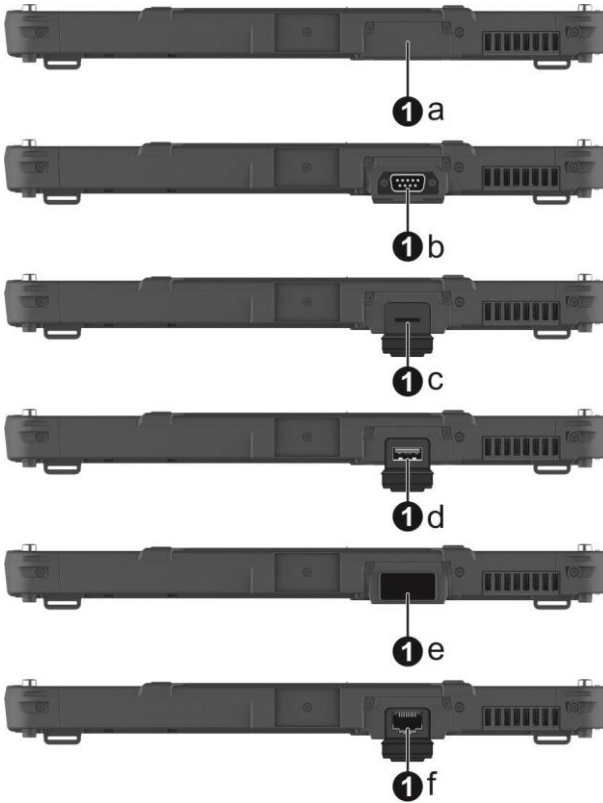

Ref	Component	Description
1	a	None
	Or can be one of the below components depending on your model:	
b	RS-232 serial port	Connects a serial device. NOTE: This option comes together with the RJ45 connector (located at the rear side).

Ref	Component	Description
c	MicroSD card slot	Accepts a microSD card for removable storage media.
d	USB 2.0 port	Connects a USB device.
e	Barcode scanner lens	Scans and reads barcodes.
f	RJ45 connector	Connects the LAN cable.

Bottom Components

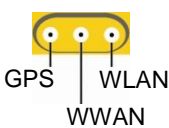

Ref	Component	Description
1	Antenna pass-through (optional)	Connects to the docking station for using external GPS /WWAN/WLAN antenna. <div style="text-align: center; margin-top: 10px;">  <p>The diagram shows a yellow rectangular connector with three circular ports. The left port is labeled 'GPS', the middle port is labeled 'WWAN', and the right port is labeled 'WLAN'.</p> </div>
2	Docking connector	Connects to the docking station (available as an option).

Chapter 2

Operating Your Tablet PC

This chapter provides information about the use of the Tablet PC.

If you are new to computers, reading this chapter will help you learn the operating basics. If you are already a computer user, you may choose to read only the parts containing information unique to your Tablet PC.

CAUTION:

- Do not expose your skin to the product when operating it in a very hot or cold environment.
- The product can get uncomfortably warm when you use it in high temperatures. As a safety precaution in such a circumstance, do not place the product on your lap or touch it with your bare hands for extended periods of time. Prolonged body contact can cause discomfort and potentially a burn.
- When the product is placed flat on a table top for work, the back surface can get hot after long working hours. Take precautions if you need to carry the product around while it is hot to the touch. Depending on your model, a carrying handle or strap may be available as an option. You can use the handle or strap to carry the product.

Navigating on the Screen

The screen of your Tablet PC is touch-sensitive. You can control the location of the cursor/pointer on the screen using the included stylus or your finger to communicate with the Tablet PC.

CAUTION: Do not use a sharp object such as a ballpoint pen or pencil on the touchscreen. Doing so may damage the touchscreen surface. Use the included stylus or your finger.

NOTE: An optical film has been attached to the screen before shipment. The film is a consumable, which will be worn out by possible scratches. You can purchase a new one when replacement is required.

Using the Touchscreen

Your Tablet PC has a capacitive touchscreen, which responds to objects that have conductive properties, such as fingertips and a capacitive-tipped stylus.

You can change the touchscreen sensitivity settings to suit your scenario.

Double-tap the Touch Screen Mode shortcut on Windows desktop to open the settings menu and select one of the options (as shown below).



Select this mode when liquids, such as raindrops, are falling on the screen and should be rejected as input. Works best with fingertips.



Has a higher sensitivity to allow use with gloves (referring to warm gloves or work gloves, not referring to touchscreen-capable gloves).



Enables simultaneous use with Getac stylus or finger touch. (You must use the stylus supplied with your model.)

NOTE:

- In high temperatures (above 60 °C / 140 °F), set the mode to Finger instead of Glove or Stylus mode.
- If liquid is spilled on the touchscreen causing a wet area, the area will stop responding to any inputs. For the area to function again, you must dry it.



The following table shows how you use the touchscreen to obtain equivalent mouse functions.

Term/Action	Equivalent Mouse Function
Tap: Touch the screen once.	Click/Point
Double-tap: Touch the screen twice rapidly.	Double-click
Tap and hold: Tap and hold until a popup menu appears.	Right-click
Drag: Hold the stylus (or finger) on the screen and drag across the screen until reaching your destination.	Drag

Using Multi-touch Gestures

You can interact with your Tablet PC by placing two fingers on the screen. The movement of the fingers across the screen creates “gestures,” which send commands to the Tablet PC.

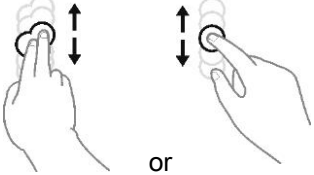
Here are the multi-touch gestures that you can use:

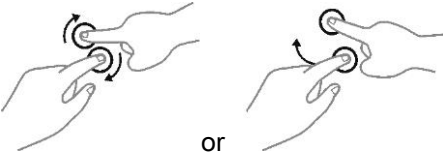
Gestures	Actions (○ = finger down; ◉ = finger up)	Descriptions
Pan (Scroll)	 <p style="text-align: center;">or</p> <p>Drag 1 or 2 fingers up or down.</p>	Use panning to see another part of a page that has scroll bars.
Zoom (Pinch)	 <p>Move two fingers apart/toward each other.</p>	Use zooming to make an item (a photo for example) on the screen larger or smaller. The gesture works in applications that support mouse wheel zooming.
Rotate	 <p style="text-align: center;">or</p> <p>Move two fingers in opposing directions.</p> <p>-or-</p> <p>Use one finger to pivot around another.</p>	Use rotating to move a picture or other item on the screen in a circular direction (clockwise or counter-clockwise). The gesture works in applications that support the specific gesture.

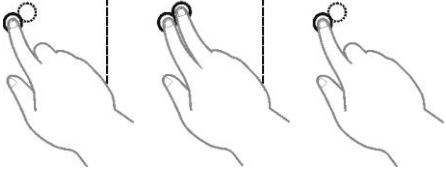
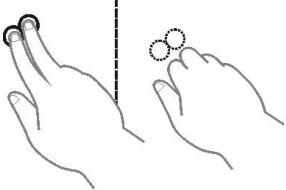
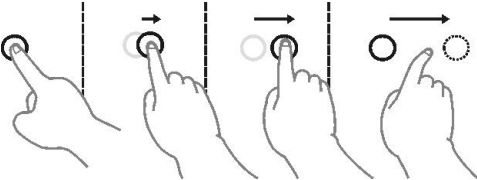
Gestures	Actions (○ = finger down; ◉ = finger up)	Descriptions
Press and Tap	 <p data-bbox="247 437 619 512">Press on target and tap using a second finger.</p>	Use press and tap to access the shortcut menu.
Two-finger Tap	 <p data-bbox="247 751 659 874">Tap two fingers at the same time (where the target is in the midpoint between the fingers).</p>	The function is defined by applications that support the specific gesture.
Flicks	 <p data-bbox="247 1091 628 1166">Make quick drag gestures in the desired direction.</p>	Flick left or right to navigate back and forward in a browser and other applications. The gesture works in most applications that support back and forward.

Using the Dual Mode Display (Optional)

Dual mode display (if your model has the feature) incorporates both touchscreen and digitizer functions.

The display is set to Touchscreen mode by default. Touchscreen mode provides all the functionalities that an ordinary touchscreen has. When the Tablet PC receives signals from the digitizer pen, the display automatically switches to Digitizer mode.

You can move the cursor by bringing the digitizer pen close to the screen, without actually touching the screen's surface. The digitizer pen has a shortcut button that functions as the right-click of a mouse.



Using Network and Wireless Connections

Using the LAN (Optional)

To connect the network cable to the LAN module (if your model has the feature, connect one end of the LAN cable to the RJ45 connector on the Tablet PC and the other end to the network hub.

The location of the connector depends on your model.

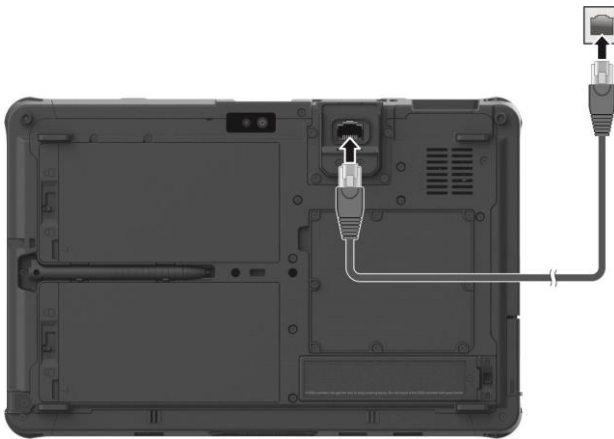

or



Using the WLAN

The WLAN (Wireless Local Area Network) module supports IEEE 802.11ax.

Turning On/Off the WLAN Radio

To turn on the WLAN radio:

Select the network icon in the lower right of the taskbar. Then, select the Wi-Fi button.

To turn off the WLAN radio:

You can turn off the WLAN radio the same way you turn it on.

If you want to quickly turn off all wireless radio, simply switch on Airplane mode. You can control the Airplane mode using one of the below methods.

- Select the network icon in the lower right of the taskbar. Then, select the Airplane mode button.
- Use the Airplane Mode button in the OSD Control Panel.

Connecting to a WLAN Network

1. Make sure that the WLAN function is enabled (as described above).
2. Tap the network icon  in the lower right of the task bar.
3. In the list of available wireless networks, tap a network, and then tap **Connect**.

4. Some networks require a network security key or passphrase. To connect to one of those networks, ask your network administrator or Internet service provider (ISP) for the security key or passphrase.

For more information on setting a wireless network connection, refer to Windows online help.

Using the Bluetooth Feature

The Bluetooth technology allows short-range wireless communications between devices without requiring a cable connection. Data can be transmitted through walls, pockets and briefcases as long as two devices are within range.

Turning On/Off the Bluetooth Radio

To turn on the Bluetooth radio:

Go to Settings → Devices → Bluetooth & other devices (for Windows 10) or **Settings → Bluetooth & devices** (for Windows 11). Slide the Bluetooth switch to the On position.

To turn off the Bluetooth radio:

You can turn off the Bluetooth radio the same way you turn it on.

If you want to quickly turn off all wireless radio, simply switch on Airplane mode.

You can control the Airplane mode using one of the below methods.

- Select the network icon in the lower right of the taskbar. Then, select the Airplane mode button.
- Use the Airplane Mode button in the OSD Control Panel.

Connecting to another Bluetooth Device

1. Make sure that the Bluetooth function is enabled (as described above).
2. Make sure that the target Bluetooth device is turned on, discoverable and within close range. (See the documentation that came with the Bluetooth device.)
3. Windows 10: Go to Settings → Devices → Bluetooth & other devices → Add Bluetooth or other device → Bluetooth.

Windows 11: Go to **Settings** → **Bluetooth & devices** → **Add device** → **Bluetooth**.

4. Select the device you want to connect from the search results.
5. Depending on the type of Bluetooth device that you want to connect to, you will need to enter the pertinent information.

For detailed information on using the Bluetooth feature, see Windows' online Help.

Using the WWAN Feature (Optional)

A WWAN (Wireless Wide Area Network) uses mobile telecommunication cellular network technologies to transfer data. The WWAN module of your Tablet PC supports 4G LTE or 5G.

NOTE:

- Your model only supports data transmission. Voice transmission is not supported.
- For instructions on installing the micro-SIM card, see “Installing the Micro-SIM Card (Optional)” in Chapter 1.

Turning On/Off the WWAN Radio

To turn on the WWAN radio:

Select the network icon in the lower right of the taskbar. Then, select the Cellular button.

To turn off the WWAN radio:

You can turn off the WWAN radio the same way you turn it on.

If you want to quickly turn off all wireless radio, simply switch on Airplane mode.

You can control the Airplane mode using one of the below methods.

- Select the network icon in the lower right of the taskbar. Then, select the Airplane mode button.
- Use the Airplane Mode button in the OSD Control Panel.

Setting up a WWAN Connection

Go to Settings → Network & Internet → Cellular. (For detailed information on cellular settings in Windows, see Microsoft Support website.)

NOTE: When using the LTE GPS tracking function, make sure that the SIM card is inserted and the mobile network is enabled.

Using the Fingerprint Scanner (Optional)

WARNING:

- We shall not be liable for any loss or damage whatsoever resulting from your use of the fingerprint scanner or neglect of fingerprint scanner use, or any data loss resulting from such developments as fingerprint authentication malfunctioning.
- It is not recommended that you use the fingerprint scanner in a below-freezing temperature. The moisture on your finger can freeze to the scanner's metal surface when you touch it, resulting in a failed operation. Besides, touching freezing metal with your finger can cause frostbite.

The fingerprint scanner (if your model has the feature) provides a strong authentication mechanism based on fingerprint recognition.

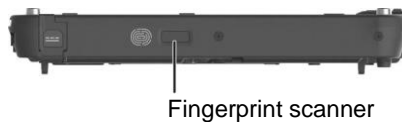

NOTE:

- You can enroll a fingerprint only after creating a password for the Windows user account.
- The fingerprint logon process can take a while. This is because the system has to check hardware devices and security configuration before initiating the fingerprint scanner.

To enroll your fingerprint:

1. Go to Settings → Accounts → Sign-in options.

2. Select the fingerprint option.
3. Follow the onscreen instructions to complete.

Using the Barcode Scanner (Optional)

NOTE: For enhanced applications and customization of the module, you can use the Barcode Manager program. (For detailed information on the program, see the program's online help.)

If your model has the barcode scanner module, you can scan and decode most common 1D and 2D symbologies.

To read barcodes:

1. Start your processing software and open a new or existing file. Place the insertion point (or called cursor) where you want the data to be entered.
2. Press the Trigger button (P1) on your Tablet PC. (The button function is configured by G-Manager.)
3. Aim the scan beam at the barcode. (The scan beam projected from the lens varies with models.)

Adjust the lens' distance from the barcode, shorter for a smaller barcode and farther for a larger one.

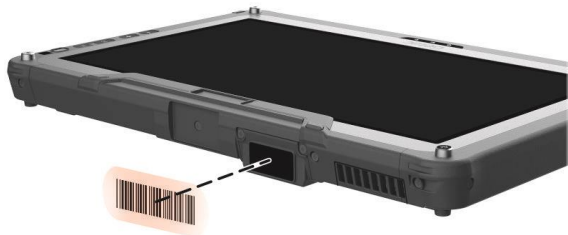

NOTE: Improper ambient light and scanning angle can affect the scanning results.

CAUTION: When or immediately after using the barcode scanner for a long time, do not touch the lens area as the area might be hot.

4. Upon a successful scan, the system beeps and the decoded barcode data is entered.

Notes



- Pulse repetition rate: 57.67 Hz
- Scan angle: 360° tilt; ±60° pitch; ±60° skew

Chapter 3

Managing Power

Your Tablet PC operates either on external AC power or on internal battery power.

This chapter tells you how you can effectively manage power. To maintain optimal battery performance, it is important that you use the battery in the proper way.

AC Adapter

CAUTION:

- The AC adapter is designed for use with your Tablet PC only. Connecting the AC adapter to another device can damage the adapter.
- The AC power cord supplied with your Tablet PC is for use in the country where you purchased your Tablet PC. If you plan to go overseas with the Tablet PC, consult your dealer for the appropriate power cord.
- When you disconnect the AC adapter, disconnect from the electrical outlet first and then from the Tablet PC. A reverse procedure may damage the AC adapter or Tablet PC.
- When unplugging the connector, always hold the plug head. Never pull on the cord.

The AC adapter serves as a converter from AC (Alternating Current) to DC (Direct Current) power because your Tablet PC runs on DC power, but an electrical outlet usually provides AC power. It also charges the battery pack when connected to AC power.

The adapter operates on any voltage in the range of 100 V – 240 V AC.

Battery Pack

Your Tablet PC has two battery packs. The battery pack is the internal power source for the Tablet PC. It is rechargeable using the AC adapter.

CAUTION: Always keep both battery packs installed, especially when the Tablet PC is running on battery power. A battery pack can be removed only when it is not being charged/discharged or if you are hot-swapping the battery pack.

Charging the Battery Pack

NOTE:

- Charging will not start if the battery's temperature is outside the allowed range, which is between 0 °C (32 °F) and 50 °C (122 °F). Once the battery's temperature meets the requirements, charging automatically resumes.
- During charging, do not disconnect the AC adapter before the battery has been fully charged; otherwise, you will get a prematurely charged battery.
- The battery has a high temperature protection mechanism which limits the maximum charge of the battery to 80% of its total capacity in the event of high temperature conditions. In such conditions, the battery will be regarded as fully charged at 80% capacity.
- The battery level may automatically lessen due to the self-discharge process, even when the battery pack is fully charged. This happens no matter if the battery pack is installed in the Tablet PC.

To charge the battery pack, connect the AC adapter to the Tablet PC and an electrical outlet. The Battery Indicator () on the Tablet PC glows amber to indicate that charging is in progress. You are advised to keep the Tablet PC power off while the battery is being charged. When the battery is fully charged, the Battery Charge Indicator glows green.

The two battery packs are charged in parallel. The charging time is approximately 5 hours (for the standard battery packs) and 6 hours (for the high-capacity battery packs) when the power is off.

CAUTION: After the Tablet PC has been fully recharged, do not immediately disconnect and reconnect the AC adapter to charge it again. Doing so may damage the battery.

Initializing the Battery Pack

You need to initialize a new battery pack before using it for the first time or when the actual operating time of a battery pack is much less than expected. Initializing is the process of fully charging, discharging, and then charging. It can take several hours.

The G-Manager program provides a tool called “Battery Recalibration” for the purpose. (See “錯誤! 找不到參照來源。” in Chapter 6.)

Checking the Battery Level

NOTE: Any battery level indication is an estimated result. The actual operating time can be different from the estimated time, depending on how you are using the Tablet PC.

The operating time of a fully charged battery pack depends on how you are using the Tablet PC. When your applications often access peripherals, you will experience a shorter operating time.

The two battery packs are discharged in parallel.

By Operating System

You can check the approximate battery level using the battery meter function of the operating system. To read the battery level in Windows, tap the battery icon on the taskbar.

By Gas Gauge

On the exterior side of the battery pack is a gas gauge for displaying the estimated battery charge.





When the battery pack is not installed in the Tablet PC and you want to know the battery charge, you can press the push-button to see the number of LEDs that light up. Each LED represents 20% charge.

Battery Low Signals and Actions

The battery icon changes appearance to display the current state of the battery.

Battery Icon	Battery Level	Description
	Discharging	The icon shows the charge remaining in 10-percent increments until the charge reaches the low-battery level.

Battery Icon	Battery Level	Description
	Low	The battery charge has reached the low-battery level.
	Critically low	The battery charge has reached the critical battery level. By default, Windows will display a notification and put your Tablet PC into Hibernation.

When the battery is low, the Tablet PC's Battery Indicator () also blinks red to alert you to take actions.

Always respond to low-battery by connecting the AC adapter, placing your Tablet PC in Hibernation mode, or turning off the Tablet PC.

Replacing the Battery Pack

CAUTION:

- There is danger of explosion if the battery is incorrectly replaced. Replace the battery only with the Tablet PC manufacturer's battery packs. Discard used batteries according to the dealer's instructions.

- Do not attempt to disassemble the battery pack.
- A battery pack can get hot due to long working hours. Do not touch a hot battery pack with bare hands. After removing a battery pack, put it in a well-ventilated area.

NOTE:

- You can hot swap one battery pack while the other one is supplying the power. The appropriate temperature range for hot swapping the battery pack is between -21°C (-5.8 °F) and 45 °C (113 °F).
- If you have the high-capacity battery model, the battery pack looks different from the one shown here. The removal/installation method is the same.

To replace the battery pack, follow these steps:

1. Skip this step if you are hot swapping the battery pack.

Turn off the Tablet PC and disconnect the AC adapter. After turning off the Tablet PC, allow a cool-down time of at least 5 minutes before removing the battery pack.

2. Locate the battery pack you want to remove.
3. Slide the battery latch toward the right (❶) and then upwards (❷) to release the battery pack.

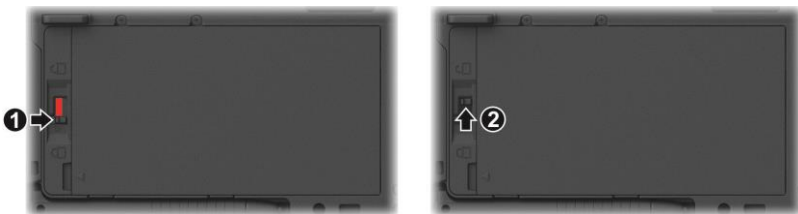

4. Remove the battery pack from its compartment.



5. Fit another battery pack into place. With the battery pack correctly oriented, attach its connector side to the battery compartment at an angle (❶) and then press down the other side (❷).



6. Slide the battery latch toward the locked position (🔒).

CAUTION: Make sure the battery latch is correctly locked, not revealing the underneath red part.



Correct



Incorrect (revealing red part)

Power-Saving Tips

Aside from enabling your Tablet PC's power saving mode, you can do your part to maximize the battery's operating time by following these suggestions.

- Do not disable Power Management.
- Decrease the LCD brightness to the lowest comfortable level.
- Shorten the length of time before Windows turn off the display.
- When not using a connected device, disconnect it.
- Turn off the wireless radio if you are not using the wireless module (such as WLAN, Bluetooth, or WWAN).
- Turn off the Tablet PC when you are not using it.

Appendix A

Specifications

NOTE: Specifications are subject to change without any prior notice.

Parts		Specifications
CPU		13th Gen platform - Intel® Core™ i5-1345U (vPro) - Intel® Core™ i7-1355U (vPro) - Intel® Core™ i7-1365U (vPro)
BIOS		Insyde, Flash EEPROM, UEFI, supporting TPM, vPro, NIST, Absolute DDS, HDD Security Erasure, BIOS self-diagnostic, Device Guard & Credential Guard, MAC Pass through, ACPI, AMT12, and WMI
RAM		8/16/32GB DDR5 SO-DIMM
Video	Controller	Intel® UHD Graphics
	Display Panel	11.6-inch (16:9) TFT LCD, FHD 1920x1080, dimmer mode, blackout mode, sunlight readable, 1200 Nits standard brightness, anti-glare
Touchscreen		Capacitive, multi-touch, 10 points
Audio	Features	High Definition audio
	Speaker	Integrated x 1
	Microphone	Integrated x 2, Mic Array
Mass storage device		PCIe SSD (Solid-State Drive), 256GB/512GB/1TB/2TB, user removable

Parts		Specifications
I/O ports	Standard	USB 3.2 Gen 2, USB-C Thunderbolt 4, combo audio (4-pole TRRS 3.5mm type), Docking
	Optional	One of the below: RS-232 + RJ45 / USB 2.0 / barcode scanner / microSD / RJ45
Card readers		Smart Card (option) MicroSD (option) HF RFID (option)
Barcode scanner (option)		1D and 2D
LAN (option)		Intel® Ethernet Connection I219-LM, Giga LAN
Wireless LAN + Bluetooth		Intel® WiFi 6E AX211 + Bluetooth 5.3 combo
WWAN (option)		4G LTE or 5G
GPS (option)		Discrete GPS
Camera (option)		Front: 5MP resolution, IR sensor (option) Rear: 8MP resolution, autofocus, LED, video capture
Security		Kensington lock TPM 2.0 Fingerprint scanner (option)
Power	AC adapter	Universal 65 W; input: 100-240 V AC, 50/60 Hz; output: 19 V
	Battery pack x 2	Standard: Lithium-ion Prismatic type, 3-cell
High capacity: Lithium-ion Prismatic type, 6-cell		
Dimension (LxWxD)		314 x 207 x 25 mm (12.36 × 8.15 × 0.98 inches)
Weight		1.55 kg (3.3 lb)
Environmental	Temperature*	Operating: -29 °C to 63 °C (-20 °F to 145 °F) Storage: -51 °C to 71 °C (-60 °F to 160 °F)

Parts		Specifications
	Humidity	95% relative humidity, non-condensing
	Drop**	1.8 m (6 ft) drop resistant

Table Notes:

* When using the computer with AC power, a low temperature down to -29 °C (-20°F) and the temperature range for MIL-STD-810 are supported. When using the computer with only battery power in a temperature down to -21 °C (-6 °F), it is advised that the system be booted in a warm environment, if possible, before being taken into an extreme cold environment for work.

** Drop test results vary with different computer configurations and also vary if optional accessories are attached.

Button Functions on Special Occasions

On “POST/BIOS Setup/Non-ACPI” occasions, the four hardware buttons provide keyboard key functions as described below.

Button	Function
P1	Tab + F12
P2	Enter
	Esc (when pressed longer)
+	↑ Up

Button	Function
-	↓ Down

Appendix B

Regulatory Information

This appendix provides regulatory statements and safety notices on your Tablet PC.

NOTE: Marking labels located on the exterior of your Tablet PC indicate the regulations that your model complies with. Please check the marking labels and refer to the corresponding statements in this appendix. Some notices apply to specific models only.

Safety Notices

About the Battery

If the battery is mishandled, it may cause fire, smoke or an explosion and the battery's functionality will be seriously damaged. The safety instructions listed below must be followed.

Danger

- Do not immerse the battery with liquid such as water, sea water or soda.
- Do not charge/discharge or place the battery in high-temperature (more than 80 °C / 176 °F) locations, such as near a fire, heater, in a car in direct sunlight, etc.
- Do not use unauthorized chargers.
- Do not force a reverse-charge or a reverse-connection.
- Do not connect the battery with AC plug (outlet) or car plugs.
- Do not adapt the battery to unspecified applications.
- Do not short circuit the battery.
- Do not drop or subject the battery to impacts.
- Do not penetrate with a nail or strike with a hammer.
- Do not directly solder the battery.
- Do not disassemble the battery.
- Keep the battery away from an extremely low air pressure environment as it may result in an explosion or the leakage of flammable liquid or gas.

Warning

- Keep the battery away from infants.
- Stop using the battery if there are noticeable abnormalities such as abnormal smell, heat, deformities, or discoloration.
- Stop charging if the charging process cannot be finished.
- In case of a leaking battery, keep the battery away from flames and do not touch it.
- Pack the battery tightly during transport.

Caution

- Do not use the battery where static electricity (more than 100V) exists that might damage the protection circuit of the battery.
- When children are using the system, parents or adults must ensure that they are using the system and battery correctly.
- Keep the battery away from flammable materials during charging and discharging.
- In case lead wires or metal objects come out from the battery, you must seal and insulate them completely.

Caution Texts Concerning Lithium Batteries

DANISH

ADVARSEL! Lithiumbatteri – Eksplosionsfare ved fejlagtig håndtering.

Udskiftning må kun ske med batteri af samme fabrikat og type. Levér det brugte batteri tilbage til leverandøren.

NORWEGIAN

ADVARSEL: Eksplosjonsfare ved feilaktig skifte av batteri. Benytt samme batteritype eller en tilsvarende type anbefalt av apparatfabrikanten. Brukte batterier kasseres i henhold til fabrikantens instruksjoner.

SWEDISH

VARNING: Explosionsfara vid felaktigt batteribyte. Använd samma batterityp eller en ekvivalent typ som rekommenderas av apparattillverkaren. Kassera använt batteri enligt fabrikantens instruktion.

FINNISH

VAROITUS: Paristo voi räjähtää, jos se on virheellisesti asennettu. Vaihda paristo ainoastaan valmistajan suosittelemaan tyyppiin. Hävitä käytetty paristo valmistajan ohjeiden mukaisesti.

ENGLISH

CAUTION: Danger of explosion if battery is incorrectly replaced. Replace only with the same or equivalent type recommended by the equipment manufacturer. Discard used batteries according to manufacturer's instructions.

DEUTSCH

VORSICHT: Explosionsgefahr bei unsachgemäßem Austausch der Batterie. Ersatz nur durch denselben oder einen vom Hersteller empfohlenen gleichwertigen Typ. Entsorgung gebrauchter Batterien nach Angaben des Herstellers.

FRENCH

ATTENTION: Il y a danger d'explosion s'il y a remplacement incorrect de la batterie. Remplacer uniquement avec une batterie du même type ou d'un type équivalent recommandé par le constructeur. Mettre au rebut les batteries usagées conformément aux instructions du fabricant.

Attention (for USA Users)

The product that you have purchased contains a rechargeable battery. The battery is recyclable. At the end of its useful life, under various state and local laws, it may be illegal to dispose of this battery into the municipal waste stream. Check with your local solid waste officials for details in your area for recycling options or proper disposal.

About the AC Adapter

- Use only the AC adapter supplied with your computer. Use of another type of AC adapter will result in malfunction and/or danger.
- If a ground/earth pin attachment plug on the AC power cord is provided, always plug the cord into a grounded/earthed outlet. Do not disable ground/earth pin of the plug/cord.
- Do not use the adapter in a high moisture environment. Never touch the adapter when your hands or feet are wet.
- Allow adequate ventilation around the adapter when using it to operate the device or charge the battery. Do not cover the AC adapter with paper or other objects that will reduce cooling. Do not use the AC adapter while it is inside a carrying case.
- Connect the adapter to a proper power source. The voltage requirements are found on the product case and/or packaging.
- Do not use the adapter if the cord becomes damaged.
- Do not attempt to service the unit. There are no serviceable parts inside. Replace the unit if it is damaged or exposed to excess moisture.

Heat Related Concerns

Your device may become very warm during normal use. It complies with the user-accessible surface temperature limits defined by the International Standards for Safety. Still, sustained contact with warm surfaces for long periods of time may cause discomfort or injury. To reduce potential heat-related concerns, follow these guidelines:

- Keep your device and its AC adapter in a well-ventilated area when in use or charging. Allow for adequate air circulation under and around the device.
- Use common sense to avoid situations where your skin is in contact with your device or its AC adapter when it's operating or connected to a power source. For example, don't sleep with your device or its AC adapter, or place it under a blanket or pillow, and avoid contact between your body and your device when the AC adapter is connected to a power source. Take special care if you have a physical condition that affects your ability to detect heat against the body.
- If your device is used for long periods, its surface can become very warm. While the temperature may not feel hot to the touch, if you maintain physical contact with the device for a long time, for example if you rest the device on your lap, your skin might suffer a low-heat injury.
- If your device is on your lap and gets uncomfortably warm, remove it from your lap and place it on a stable work surface.
- Never place your device or AC adapter on furniture or any other surface that might be marred by exposure to heat since the base of your device and the surface of the AC adaptor may increase in temperature during normal use.

North America

USA

Federal Communications Commission Radio Frequency Interference Statement

NOTE:

This equipment has been tested and found to comply with the limits for a Class B digital device pursuant to Part 15 of the FCC Rules. These limits are designed to provide reasonable protection against harmful interference in a residential installation. This equipment generates, uses, and can radiate radio frequency energy and, if not installed and used in accordance with the instructions, may cause harmful interference to radio communications. However, there is no guarantee that interference will not occur in a particular installation. If this equipment does cause harmful interference to radio or television reception, which can be determined by turning the equipment off and on, the user is encouraged to try to correct the interference by one or more of the following measures:

- Reorient or relocate the receiving antenna.
- Increase the separation between the equipment and receiver.
- Connect the equipment into an outlet on a circuit different from that to which the receiver is connected.
- Consult the dealer or an experienced radio/TV technician for help.

Any changes or modifications not expressly approved by the manufacturer could void the user's authority to operate the equipment.

Please note:

The use of a non-shielded interface cable with this equipment is prohibited.

Operation of transmitters in the 5.925-7.125 GHz band is prohibited for control of or communications with unmanned aircraft systems.

This device complies with Part 15 of the FCC Rules. Operation is subject to the following two conditions:

- (1) This device may not cause harmful interference.
- (2) This device must accept any interference received, including interference that may cause undesired operation.



Company name	Getac Inc.
Address	15495 Sand Canyon Rd., Suite 350 Irvine, CA 92618 USA
Phone	+1-949-681-2900

ANSI Warning

Equipment approved for ANSI/UL121201 AND CSA C22.2 NO. 213, Nonincendive Electrical Equipment for use in Class I, Division 2, Group A, B, C, and D.

Ambient temperature: -29 °C to 60 °C

EXPLOSION HARZARD WARNINGS:

- External connections/hubs through the connectors as mentioned (DC power supply port, headphone/microphone combo jack, USB port, USB Type C port, docking port, RS-232 port, microSD card reader, LAN port, smart card reader, antenna pass-through, micro-SIM slot) are NOT to be used in a

hazardous location. When used with a docking station (such as the office dock, keyboard dock, or vehicle dock), the docking/undocking of the equipment must be conducted outside the hazardous area.

Docking/undocking in a hazardous area is prohibited.

- The tablet is to be only powered from the battery pack while in hazardous locations. Power adapter is NOT certified to use in hazardous locations and NOT to be used in hazardous locations.
- The battery must only be changed in an area known to be non-hazardous.
- DO NOT disconnect equipment unless power has been switched off or the area is known to be non-hazardous.
- DO NOT remove or replace a user-removable item (such as the battery pack, micro-SIM card, smart card, etc.) while the circuit is live unless the area is free of ignitable concentrations.
- Replace the battery with battery model BP3S1P2680B or BP3S2P2100S-02, manufactured by Getac Technology Corporation only. Use of another battery may present a risk of fire or explosion.

California Proposition 65

For California USA:

Proposition 65, a California law, requires warnings to be provided to California consumers when they might be exposed to chemical(s) identified by Proposition 65 as causing cancer and birth defects or other reproductive harm.

Almost all electronic products contain 1 or more of the chemicals listed under Proposition 65. This does not mean the products pose a significant risk of exposure. As the consumers have the right to know about the products they

purchase, we are giving this warning on our packaging and user manual to keep our consumers well informed.



This product can expose you to chemicals including lead, TBBPA or formaldehyde, which are known to the State of California to cause cancer and birth defects or other reproductive harm. For more information go to www.P65Warnings.ca.gov

Canada

Canadian ICES-003

CAN ICES-3(B)/NMB-3(B)

This device contains licence-exempt transmitter(s)/receiver(s) that comply with Innovation, Science and Economic Development Canada's licence-exempt RSS(s). Operation is subject to the following two conditions: (1) This device may not cause interference. (2) This device must accept any interference, including interference that may cause undesired operation of the device.

L'émetteur/récepteur exempt de licence contenu dans le présent appareil est conforme aux CNR d'Innovation, Sciences et Développement économique Canada applicables aux appareils radio exempts de licence. L'exploitation est autorisée aux deux conditions suivantes : 1) L'appareil ne doit pas produire de brouillage; 2) L'appareil doit accepter tout brouillage radioélectrique subi, même si le brouillage est susceptible d'en compromettre le fonctionnement.

The device could automatically discontinue transmission in case of absence of information to transmit, or operational failure. Note that this is not intended to prohibit transmission of control or signaling information or the use of repetitive codes where required by the technology.

L'appareil peut interrompre automatiquement la transmission en cas d'absence d'informations à transmettre ou de panne opérationnelle. Notez que ceci n'est pas destiné à interdire la transmission d'informations de contrôle ou de signalisation ou l'utilisation de codes répétitifs lorsque cela est requis par la technologie.

The device for operation in the band 5150–5250 MHz is only for indoor use to reduce the potential for harmful interference to co-channel mobile satellite systems.

l'appareil fonctionnant dans la bande 5150-5250 MHz est réservé à une utilisation en intérieur afin de réduire les risques de brouillage préjudiciable pour les systèmes mobiles par satellite dans le même canal.

Devices shall not be used for control of or communications with unmanned aircraft systems.

Les dispositifs ne doivent pas être utilisés pour commander des systèmes d'aéronef sans pilote ni pour communiquer avec de tels systèmes.

User Notification of Take-back Service

To customers in United States and Canada:

Getac believes in providing our customers with easy-to-use solutions to recycle your Getac-brand products for free. Getac understands the customers will likely be recycling multiple items at once and as such. Getac wants to make the recycling process for these larger shipments as streamlined as possible. Getac works with recycling vendors with the highest standards for protecting our environment, ensuring worker safety, and complying with global environmental laws. Our commitment to recycling our old equipment grows out of our work to protect the environment in many ways. For more information, see the Getac Web site at <https://www.getac.com/us/environmental-certifications/>.

Please see the product type below for information on Getac product, battery and packaging recycling in USA and Canada.

- For Product Recycling:

If you have a Getac computer that needs to go to a recycling house, Getac

can help you. Just contact us at (866) 394 – 3822 or by email at GUSA.RecycleProgram@getac.com to obtain a prepaid shipping label at no charge to you, pack up your equipment in a box of your choice and send it off.

- For Battery Recycling:

The batteries used to power your portable Getac products contain hazardous materials. While they pose no risk to you during normal use, they should never be disposed with other wastes. Getac provides a free take-back service for recycling your batteries from Getac products. To recycle the battery, please contact us at (866) 394 – 3822 or by email at GUSA.RecycleProgram@getac.com.

- For Packaging Recycling:

Getac has chosen the packaging materials used to transport our products carefully, to balance the requirements of shipping the product to you safely while minimizing the amount of material used. Our packaging for notebooks and tablets is recyclable and manufactured using elemental chlorine-free processes. They contain 90 percent (by weight) recycled content. Your packaging materials can be recycled at your local recycling center. Or, if you would like Getac to recycle your packaging, please contact us at (866) 394 – 3822 and we will make arrangements for you.

If you have the above for recycling, please visit our website

<https://www.getac.com/us/environmental-certifications/>

Europe Marking and Compliance Notices

Statements of Compliance

English

Getac hereby declares that this product complies with the EU Directive 2014/53/EU. The full text of the EU declaration of conformity is available at:

<https://support.getac.com/Portal/Page/809>

Getac declares that this device is in compliance with Radio Equipment Regulations 2017. The full text of the UK declaration of conformity is available at the following internet address: <https://support.getac.com/Portal/Page/809>

Deutsch

Getac erklärt hiermit, dass Gerät mit den grundlegenden Anforderungen und anderen relevanten Bestimmungen der Richtlinie 2014/53/EU übereinstimmt. Der gesamte Text der EU Konformitätserklärung ist verfügbar unter:

<https://support.getac.com/Portal/Page/846>

Español

Por la presente, Getac declara que el producto cumple con la Directiva de la UE 2014/53/UE. El texto completo de la declaración UE de conformidad se encuentra a continuación.

<https://support.getac.com/Portal/Page/866>

Français

Getac déclare par la présente que cet appareil est conforme aux critères essentiels et autres clauses pertinentes de la directive 2014/53/EU. La déclaration de conformité de l'UE peut être téléchargée à partir du site internet

suivant :

<https://support.getac.com/Portal/Page/879>

Italiano

Getac con la presente dichiara che questo dispositivo è conforme ai requisiti essenziali e alle altre disposizioni pertinenti con la direttiva 2014/53/EU. Il testo completo della dichiarazione di conformità UE è disponibile all'indirizzo:

<https://support.getac.com/Portal/Page/892>

Notices

Max power:

WLAN 2400-2483.5 MHz: 20 dBm

WLAN 5150-5725 MHz: 23 dBm

WLAN 5725-5850 MHz: 13.979 dBm

WLAN 5945-6425 MHz: LPI: 23 dBm, VLP: 14 dBm

BT 2400-2483.5 MHz: 20 dBm

NFC 13.56MHz: -4.16 dBuA/m@10m

Digitizer 509KHz: -32.09 dBuA/m@10m

WWAN: 25 dBm

The device is restricted to indoor use only when operating in the 5150 to 5350 MHz and 5945 to 6425 MHz frequency range.

	BE	BG	CZ	DK	DE	EE
	IE	EL	ES	FR	HR	IT
	CY	LV	LT	LU	HU	MT
	NL	AT	PL	PT	RO	SI
	SK	FI	SE	NO	IS	LI

	CH	TR	UK (NI)			
--	----	----	---------	--	--	--

Restriction or Requirement in the UK: 5150 to 5350 MHz and 5925 to 6425 MHz indoor-use only.



	<p>Waste Electrical and Electronic Equipment (WEEE)</p> <p>This symbol means that according to local laws and regulations your product shall be disposed of separately from household waste. When this product reaches its end of life, take it to a collection point designated by local authorities. Proper recycling of your product will protect human health and the environment.</p>
---	---

	<p>Battery Directive — Information for Users</p> <p>In the European Union, this label indicates that the batteries in this product should be collected separately and not be disposed of with household waste. Substances in batteries can have a potential impact on health and environment and you have a role in recycling waste batteries thus contributing to the protection, preservation, and improvement of the quality of the environment.</p>
---	--

Restriction of Hazardous Substances (RoHS) Directive

EU RoHS

Getac products meet the requirements of Directive 2011/65/EU on the restriction of the use of certain hazardous substances in electrical and electronic equipment. For more information about RoHS, go to:

<https://www.getac.com/us/environment/>



Company name	Getac Technology GmbH.
Address	Kanzlerstrasse 4 40472 Dusseldorf, Germany
Phone	+49 (0) 211-984819-0



Company name	Getac UK Ltd.
Address	Getac House, Stafford Park 12, Telford, Shropshire, TF3 3BJ, UK
Phone	+44 (0) 1952-207-222

About F110-Ex

F110-Ex is suitable for use in potentially explosive atmospheres (zone 2 and zone 22).

Follow the instructions in this section if you have the F110-Ex model (with certification model name as F110-Exc).

Special Conditions for Safe Use

- Ambient temperature range: -21 °C to +60 °C
- Usage only in controlled environment with suitably reduced pollution.
- The device shall be protected against excessive UV-light.
- The impact test according to IEC 60079-0 was performed with reduced height. The device shall be protected against mechanical impact.
- The connection interfaces shall never be used in hazardous areas.
- The battery shall never be changed, charged or removed in hazardous areas.
- The device shall never be used next to strong charge generating processes.
- Use only rechargeable Li-ion battery of type BP3S1P2680B or BP3S2P2100S-02.

Anti-Explosion Protective Covers

All covers must be correctly installed in potentially explosive atmospheres. The bottom I/O cover must be secured to F110-Ex with two thumb screws.



While not in an Ex-hazardous area, you can remove this cover in order to access any connector behind it.

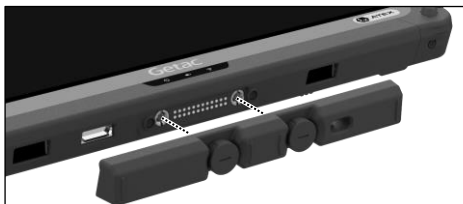

Use of Accessories

F110-Ex can be used with the following accessories provided by Getac:

- Shoulder strap
- Hand strap
- Shoulder harness strap
- Capacitive hard tip stylus and tether
- Digitizer pen and tether (select models only)

ENERGY STAR



ENERGY STAR® is a government program that offers businesses and consumers energy-efficient solutions, making it easy to save money while protecting the environment for future generations.

Please reference ENERGY STAR® related information from <http://www.energystar.gov>.

As an ENERGY STAR® Partner, Getac Technology Corporation has determined that this product meets the ENERGY STAR® guidelines for energy efficiency.

All Getac products with ENERGY STAR® logo comply with the ENERGY STAR® standard, and the power management feature is enabled by default. Getac's ENERGY STAR® qualified products are listed on the EPA website.

<https://www.energystar.gov/products>

About Battery and External Enclosure Replacement

Battery

The batteries of your product include two battery packs and a button cell (or called RTC battery). All batteries are available from Getac authorized service centers.

The battery pack is user-replaceable. Replacement instructions can be found in “Replacing the Battery Pack” in Chapter 3.

The button cell must be replaced by Getac authorized service centers.

Visit the website at <http://us.getac.com/support/support-select.html> for authorized service center information.

External Enclosure

The external enclosure of the product can be removed using screwdrivers. The external enclosure can then be reused or refurbished.