



FCC RF Test Report

APPLICANT : Sierra Wireless, Inc.
EQUIPMENT : Wireless Module
BRAND NAME : AirPrime
MODEL NAME : EM9190
FCC ID : N7NEM91
STANDARD : 47 CFR Part 2, 24, 27
CLASSIFICATION : PCS Licensed Transmitter (PCB)
TEST DATE(S) : Nov. 18, 2021 ~ Jan. 06, 2022

We, Sporton International Inc. (ShenZhen), would like to declare that the tested sample has been evaluated in accordance with the procedures given in ANSI C63.26-2015 and shown compliance with the applicable technical standards.

The test results in this report apply exclusively to the tested model / sample. Without written approval of Sporton International Inc. (ShenZhen), the test report shall not be reproduced except in full.

Reviewed by: Derreck Chen / Supervisor

Approved by: Eric Shih / Manager



Sporton International Inc. (ShenZhen)

1/F, 2/F, Bldg 5, Shiling Industrial Zone, Xinwei Village, Xili, Nanshan, Shenzhen, 518055

People's Republic of China



TABLE OF CONTENTS

REVISION HISTORY...3
SUMMARY OF TEST RESULT...4
1 GENERAL DESCRIPTION...5
1.1 Applicant...5
1.2 Manufacturer...5
1.3 Product Feature of Equipment Under Test...5
1.4 Product Specification of Equipment Under Test...5
1.5 Modification of EUT...6
1.6 Maximum Conducted Power and Emission Designator...6
1.7 Testing Location...8
1.8 Test Software...8
1.9 Applicable Standards...9
2 TEST CONFIGURATION OF EQUIPMENT UNDER TEST...10
2.1 Test Mode...10
2.2 Connection Diagram of Test System...12
2.3 Support Unit used in test configuration and system...13
2.4 Measurement Results Explanation Example...13
2.5 Frequency List of Low/Middle/High Channels...14
3 CONDUCTED TEST ITEMS...17
3.1 Measuring Instruments...17
3.2 Test Setup...17
3.3 Test Result of Conducted Test...17
3.4 Conducted Output Power...18
3.5 Peak-to-Average Ratio...19
3.6 Occupied Bandwidth...20
3.7 Conducted Band Edge...21
3.8 Conducted Spurious Emission...23
3.9 Frequency Stability...24
4 RADIATED TEST ITEMS...25
4.1 Measuring Instruments...25
4.2 Test Setup...25
4.3 Test Result of Radiated Test...26
4.4 Radiated Spurious Emission...27
5 LIST OF MEASURING EQUIPMENT...28
6 UNCERTAINTY OF EVALUATION...29
APPENDIX A. TEST RESULTS OF CONDUCTED TEST
APPENDIX B. TEST RESULTS OF RADIATED TEST
APPENDIX C. TEST SETUP PHOTOGRAPHS



REVISION HISTORY

REPORT NO.	VERSION	DESCRIPTION	ISSUED DATE
FG1N1001D	Rev. 01	Initial issue of report	Feb. 17, 2022



SUMMARY OF TEST RESULT

Report Section	FCC Rule	Description	Limit	Result	Remark
3.4	§2.1046	Conducted Output Power	Reporting Only	-	-
3.5	§24.232(d) §27.50(j)(4)	Peak-to-Average Ratio	<13 dB	PASS	-
3.6	§2.1049	Occupied Bandwidth	Reporting Only	PASS	-
3.7	§2.1051 §24.238(a) §27.53(h) §27.53(g) §27.53(l)(2)	Conducted Band Edge Measurement (5G NR n12) (5G NR n25) (5G NR n66) (5G NR n77/n78)	< 43+10log ₁₀ (P[Watts])	PASS	-
	§27.53(m)(4)	Conducted Band Edge Measurement (5G NR n7, n41)	§27.53(m)(4)		
3.8	§2.1051 §24.238(a) §27.53(h) §27.53(g) §27.53(l)(2)	Conducted Spurious Emission (5G NR n12) (5G NR n25) (5G NR n66) (5G NR n77/n78)	< 43+10log ₁₀ (P[Watts])	PASS	-
	§2.1051 §27.53(m)(4)	Conducted Spurious Emission (5G NR n7, n41)	< 55+10log ₁₀ (P[Watts])		
3.9	§2.1055 §24.235 §27.54	Frequency Stability Temperature & Voltage	Within Authorized Band	PASS	-
4.4	§2.1053 §24.238(a) §27.53(h) §27.53(g) §27.53(l)(2)	Radiated Spurious Emission (5G NR n12) (5G NR n25) (5G NR n66) (5G NR n77/n78)	< 43+10log ₁₀ (P[Watts])	PASS	Under limit 27.12 dB at 10040.000 MHz
	§2.1053 §27.53(m)(4)	Radiated Spurious Emission (5G NR n7, n41)	< 55+10log ₁₀ (P[Watts])		

Declaration of Conformity:

The test results with all measurement uncertainty excluded are presented in accordance with the regulation limits or requirements declared by manufacturers.

Comments and Explanations:

The declared of product specification for EUT presented in the report are provided by the manufacturer, and the manufacturer takes all the responsibilities for the accuracy of product specification.



1 General Description

1.1 Applicant

Sierra Wireless, Inc.
13811 Wireless Way, Richmond, BC, Canada V6A 3A4

1.2 Manufacturer

Sierra Wireless, Inc.
13811 Wireless Way, Richmond, BC, Canada V6A 3A4

1.3 Product Feature of Equipment Under Test

Product Feature	
Equipment	Wireless Module
Brand Name	AirPrime
Model Name	EM9190
FCC ID	N7NEM91
IMEI Code	Conducted : 351735110008640 Radiation : N/A
HW Version	1.0
SW Version	00.15.01.00
EUT Stage	Identical Prototype

Remark: This is a variant report for EM9190. The change note could be referred to the EM9190_Operational Description of Product Equality Declaration which is exhibit separately. Based on the similarity between current and previous project, only the related test cases from original test report (Sporton Report Number FG021501G) were verified for the differences.

1.4 Product Specification of Equipment Under Test

Standards-related Product Specification	
Tx Frequency	5G NR n7 : 2500 MHz ~ 2570 MHz 5G NR n12 : 699 MHz ~ 716 MHz 5G NR n25 : 1850 MHz ~ 1915 MHz 5G NR n41 : 2496 MHz ~ 2690 MHz 5G NR n66 : 1710 MHz ~ 1780 MHz 5G NR n77: 3300 MHz ~ 4200 MHz 5G NR n78: 3300 MHz ~ 3800 MHz
Rx Frequency	5G NR n7 : 2620 MHz ~ 2690 MHz 5G NR n12 : 729 MHz ~ 746 MHz 5G NR n25 : 1930 MHz ~ 1995 MHz 5G NR n41 : 2496 MHz ~ 2690 MHz 5G NR n66 : 2110 MHz~ 2200 MHz 5G NR n77: 3300 MHz ~ 4200 MHz 5G NR n78: 3300 MHz ~ 3800 MHz
Bandwidth	n7/n25: 5MHz / 10MHz / 15MHz / 20MHz n12: 5MHz / 10MHz / 15MHz n41/n77/n78: 20MHz / 30MHz / 40MHz / 50MHz / 60MHz / 70MHz /



	80MHz / 90MHz / 100MHz n66: 5MHz / 10MHz / 15MHz / 20MHz / 30MHz / 40MHz
SCS	n7, n12, n25, n66: 15KHz n41/n77/n78 : 30KHz
Maximum Output Power to Antenna	EN-DC_5A_n7A: 23.42 dBm EN-DC_2A_n12A: 23.30 dBm EN-DC_12A_n25A: 23.47 dBm EN-DC_4A_n41A: 23.46 dBm EN-DC_13A_n66A: 23.88 dBm EN-DC_5A_n77A: 23.22 dBm
Type of Modulation	CP-OFDM: QPSK / 16QAM / 64QAM / 256QAM DFT-s-OFDM: PI/2 BPSK / QPSK / 16QAM / 64QAM / 256QAM

Remark:

1. 5G NR bands supports SA and NSA mode, only NSA mode was required to be tested. For NSA mode of all 5G NR, we only show the combination of the maximum power among all NSA combinations in the report.
2. For modulation of CP-OFDM and DFT-s-OFDM, the maximum power of CP-OFDM is lower than DFT-s-OFDM modulation, therefore, we chose higher power (DFT-s-OFDM modulation) to perform all tests and show in the report.
3. The EN-DC mode combination could be referred to the product spec.
4. 5G NR n77 overlaps the entire frequency range of 5G NR n78. Therefore, the test results provided in this report covers n77 as well as n78.

1.5 Modification of EUT

No modifications are made to the EUT during all test items.

1.6 Maximum Conducted Power and Emission Designator

5G NR n7 (EN DC_5A-n7A)		PI/2 BPSK / QPSK		16QAM / 64QAM / 256QAM	
BW (MHz)	Frequency Range (MHz)	Maximum Conducted power (W)	Emission Designator (99%OBW)	Maximum Conducted power (W)	Emission Designator (99%OBW)
5	2502.5 ~ 2567.5	0.2188	4M48G7D	0.1675	4M47W7D
10	2505.0 ~ 2565.0	0.2193	9M29G7D	0.1702	9M30W7D
15	2507.5 ~ 2562.5	0.2183	14M1G7D	0.1726	14M1W7D
20	2510.0 ~ 2560.0	0.2198	18M9G7D	0.1722	19M0W7D



5G NR n12 (EN DC_2A-n12A)		PI/2 BPSK / QPSK		16QAM / 64QAM / 256QAM	
BW (MHz)	Frequency Range (MHz)	Maximum Conducted power (W)	Emission Designator (99%OBW)	Maximum Conducted power (W)	Emission Designator (99%OBW)
5	701.5 ~ 713.5	0.2099	4M48G7D	0.1641	4M48W7D
10	704.0 ~ 711.0	0.2037	9M27G7D	0.1611	9M29W7D
15	706.5 ~ 708.5	0.2138	14M1G7D	0.1663	14M1W7D

5G NR n25 (EN DC_12A-n25A)		PI/2 BPSK / QPSK		16QAM / 64QAM / 256QAM	
BW (MHz)	Frequency Range (MHz)	Maximum Conducted power (W)	Emission Designator (99%OBW)	Maximum Conducted power (W)	Emission Designator (99%OBW)
5	1852.5 ~ 1912.5	0.2173	4M49G7D	0.1698	4M47W7D
10	1855.0 ~ 1910.0	0.2173	9M27G7D	0.1706	9M29W7D
15	1857.5 ~ 1907.5	0.2203	14M1G7D	0.1746	14M1W7D
20	1860.0 ~ 1905.0	0.2223	18M9G7D	0.1778	18M9W7D

5G NR n41 (EN DC_4A-n41A)		PI/2 BPSK / QPSK		16QAM / 64QAM / 256QAM	
BW (MHz)	Frequency Range (MHz)	Maximum Conducted power (W)	Emission Designator (99%OBW)	Maximum Conducted power (W)	Emission Designator (99%OBW)
20	2506.02 ~ 2679.99	0.1950	18M2G7D	0.1563	18M2W7D
30	2511.00 ~ 2674.98	0.2178	27M8G7D	0.1734	27M8W7D
40	2516.01 ~ 2670.00	0.2218	37M8G7D	0.1758	37M8W7D
50	2521.02 ~ 2664.99	0.2109	47M4G7D	0.1663	47M4W7D
60	2526.00 ~ 2659.98	0.2094	57M9G7D	0.1667	57M8W7D
70	2531.01 ~ 2655.00	0.2094	67M3G7D	0.1690	67M4W7D
80	2536.02 ~ 2649.99	0.2075	77M4G7D	0.1675	77M3W7D
90	2541.00 ~ 2644.98	0.2109	87M3G7D	0.1644	87M5W7D
100	2546.01 ~ 2640.00	0.2173	97M2G7D	0.1714	97M5W7D

5G NR n66 (EN DC_13A-n66A)		PI/2 BPSK / QPSK		16QAM / 64QAM / 256QAM	
BW (MHz)	Frequency Range (MHz)	Maximum Conducted power (W)	Emission Designator (99%OBW)	Maximum Conducted power (W)	Emission Designator (99%OBW)
5	1712.5 ~ 1777.5	0.2084	4M48G7D	0.1629	4M47W7D
10	1715.0 ~ 1775.0	0.2128	9M28G7D	0.1698	9M28W7D
15	1717.5 ~ 1772.5	0.2148	14M1G7D	0.1667	14M1W7D
20	1720.0 ~ 1770.0	0.2148	18M9G7D	0.1750	18M9W7D
30	1725.0 ~ 1765.0	0.2438	28M6G7D	0.1914	28M6W7D
40	1730.0 ~ 1760.0	0.2443	38M5G7D	0.1901	38M5W7D



5G NR n77 (EN DC_5A-n77A)		PI/2 BPSK / QPSK		16QAM / 64QAM / 256QAM	
BW (MHz)	Frequency Range (MHz)	Maximum Conducted power (W)	Emission Designator (99%OBW)	Maximum Conducted power (W)	Emission Designator (99%OBW)
20	3710.01 ~ 3969.99	0.1968	18M2G7D	0.1607	18M2W7D
30	3715.02 ~ 3964.98	0.2099	27M9G7D	0.1671	27M9W7D
40	3720.00 ~ 3960.00	0.2084	37M9G7D	0.1679	37M9W7D
50	3725.01 ~ 3954.99	0.1968	47M5G7D	0.1535	47M5W7D
60	3730.02 ~ 3949.98	0.1936	57M9G7D	0.1545	57M9W7D
70	3735.00 ~ 3945.00	0.1945	67M5G7D	0.1538	67M6W7D
80	3740.01 ~ 3939.99	0.1968	77M5G7D	0.1524	77M6W7D
90	3745.02 ~ 3934.98	0.1941	87M5G7D	0.1535	87M6W7D
100	3750.00 ~ 3930.00	0.1968	97M5G7D	0.1607	97M6W7D

Note: All modulations have been tested, only the worst test results of PSK & QAM are shown in the report.

1.7 Testing Location

Sporton International Inc. (Shenzhen) is accredited to ISO/IEC 17025:2017 by American Association for Laboratory Accreditation with Certificate Number 5145.01.

Test Firm	Sporton International Inc. (Shenzhen)		
Test Site Location	1/F, 2/F, Bldg 5, Shiling Industrial Zone, Xinwei Village, Xili, Nanshan, Shenzhen, 518055 People's Republic of China TEL: +86-755-86379589 FAX: +86-755-86379595		
Test Site No.	Sporton Site No.	FCC Designation No.	FCC Test Firm Registration No.
	TH01-SZ	CN1256	421272

Test Firm	Sporton International Inc. (Shenzhen)		
Test Site Location	101, 1st Floor, Block B, Building 1, No. 2, Tengfeng 4th Road, Fenghuang Community, Fuyong Street, Baoan District, Shenzhen City Guangdong Province China 518103 TEL: +86-755-33202398		
Test Site No.	Sporton Site No.	FCC Designation No.	FCC Test Firm Registration No.
	03CH03-SZ	CN1256	421272

1.8 Test Software

Item	Site	Manufacturer	Name	Version
1.	03CH03-SZ	AUDIX	E3	6.2009-8-24



1.9 Applicable Standards

According to the specifications of the manufacturer, the EUT must comply with the requirements of the following standards:

- ♦ 47 CFR Part 2, 22, 24, 27
- ♦ ANSI C63.26-2015
- ♦ FCC KDB 971168 D01 Power Meas License Digital Systems v03r01
- ♦ FCC KDB 412172 D01 Determining ERP and EIRP v01r01

Remark: All test items were verified and recorded according to the standards and without any deviation during the test.



2 Test Configuration of Equipment Under Test

2.1 Test Mode

Antenna port conducted and radiated test items are performed according to KDB 971168 D01 Power Meas License Digital Systems v03r01 with maximum output power.

For radiated measurement, pre-scanned in three orthogonal panels, X, Y, Z. The worst cases (Y plane) were recorded in this report.

The device is investigated from 30MHz to 10 times of fundamental signal for radiated spurious emission test under different RB size/offset and modulations in exploratory test. Subsequently, only the worst case emissions are reported.

Test Cases	Band	Bandwidth (MHz)	Modulation	RB #	Test Channel
		eg. 5M, 10M, 15M, 20M	eg. QPSK, 16QAM, 64QAM	1RB, Partial RB, Full RB	L/M/H
Max. Output Power	5G n7	5M, 10M, 15M, 20M	PI/2 BPSK, QPSK, 16QAM, 64QAM, 256QAM	1RB, Partial RB, Full RB	L, M, H
	5G n12	5M, 10M, 15M	PI/2 BPSK, QPSK, 16QAM, 64QAM, 256QAM	1RB, Partial RB, Full RB	L, M, H
	5G n25	5M, 10M, 15M, 20M	PI/2 BPSK, QPSK, 16QAM, 64QAM, 256QAM	1RB, Partial RB, Full RB	L, M, H
	5G n41	20M, 30M, 40M, 50M, 60M, 70M, 80M, 90M, 100M	PI/2 BPSK, QPSK, 16QAM, 64QAM, 256QAM	1RB, Partial RB, Full RB	L, M, H
	5G n66	5M, 10M, 15M, 20M, 30M, 40M	PI/2 BPSK, QPSK, 16QAM, 64QAM, 256QAM	1RB, Partial RB, Full RB	L, M, H
	5G n77	20M, 30M, 40M, 50M, 60M, 70M, 80M, 90M, 100M	PI/2 BPSK, QPSK, 16QAM, 64QAM, 256QAM	1RB, Partial RB, Full RB	L, M, H
Peak-to-Average Ratio	5G n7	20M	PI/2 BPSK, QPSK	1RB, Full RB	L, M, H
	5G n12	10M	PI/2 BPSK, QPSK	1RB, Full RB	L, M, H
	5G n25	20M	PI/2 BPSK, QPSK	1RB, Full RB	L, M, H
	5G n41	20M	PI/2 BPSK, QPSK	1RB, Full RB	L, M, H
	5G n66	20M	PI/2 BPSK, QPSK	1RB, Full RB	L, M, H
	5G n77	20M	PI/2 BPSK, QPSK	1RB, Full RB	L, M, H



Test Cases	Band	Bandwidth (MHz)	Modulation	RB #	Test Channel
		eg. 5M, 10M, 15M, 20M	eg. QPSK, 16QAM, 64QAM	1RB, Partial RB, Full RB	L/M/H
26dB and 99% Bandwidth	5G n7	5M, 10M, 15M, 20M	PI/2 BPSK, QPSK, 16QAM, 64QAM, 256QAM	Full RB	M
	5G n12	5M, 10M, 15M	PI/2 BPSK, QPSK, 16QAM, 64QAM, 256QAM	Full RB	M
	5G n25	5M, 10M, 15M, 20M	PI/2 BPSK, QPSK, 16QAM, 64QAM, 256QAM	Full RB	M
	5G n41	20M, 30M, 40M, 50M, 60M, 70M, 80M, 90M, 100M	PI/2 BPSK, QPSK, 16QAM, 64QAM, 256QAM	Full RB	M
	5G n66	5M, 10M, 15M, 20M, 30M, 40M	PI/2 BPSK, QPSK, 16QAM, 64QAM, 256QAM	Full RB	M
	5G n77	20M, 30M, 40M, 50M, 60M, 70M, 80M, 90M, 100M	PI/2 BPSK, QPSK, 16QAM, 64QAM, 256QAM	Full RB	M
Conducted Band Edge	5G n7	5M, 10M, 20M	PI/2 BPSK, QPSK	1RB, Full RB	L, H
	5G n12	5M, 10M, 15M	PI/2 BPSK, QPSK	1RB, Full RB	L, H
	5G n25	5M, 10M, 20M	PI/2 BPSK, QPSK	1RB, Full RB	L, H
	5G n41	20M, 60M, 100M	PI/2 BPSK, QPSK	1RB, Full RB	L, H
	5G n66	5M, 20M, 40M	PI/2 BPSK, QPSK	1RB, Full RB	L, H
	5G n77	20M, 60M, 100M	PI/2 BPSK, QPSK	1RB, Full RB	L, H
Conducted Spurious Emission	5G n7	5M, 10M, 20M	PI/2 BPSK, QPSK	1RB	L, M, H
	5G n12	5M, 10M, 15M	PI/2 BPSK, QPSK	1RB	L, M, H
	5G n25	5M, 10M, 20M	PI/2 BPSK, QPSK	1RB	L, M, H
	5G n41	20M, 60M, 100M	PI/2 BPSK, QPSK	1RB	L, M, H
	5G n66	5M, 20M, 40M	PI/2 BPSK, QPSK	1RB	L, M, H
	5G n77	20M, 60M, 100M	PI/2 BPSK, QPSK	1RB	L, M, H



Test Cases	Band	Bandwidth (MHz)	Modulation	RB #	Test Channel
		eg. 5M, 10M, 15M, 20M	eg. QPSK, 16QAM, 64QAM	1RB, Partial RB, Full RB	L/M/H
Frequency Stability	5G n7	20M	QPSK	Full RB	M
	5G n12	10M	QPSK	Full RB	M
	5G n25	20M	QPSK	Full RB	M
	5G n41	20M	QPSK	Full RB	M
	5G n66	20M	QPSK	Full RB	M
	5G n77	20M	QPSK	Full RB	M
Radiated Spurious Emission	5G n7	Worst case from maximum power			M
	5G n12	Worst case from maximum power			M
	5G n25	Worst case from maximum power			M
	5G n41	Worst case from maximum power			M
	5G n66	Worst case from maximum power			M
	5G n77	Worst case from maximum power			M

Note:

1. The device is investigated from 30MHz to 10 times of fundamental signal for radiated spurious emission test under different RB size/offset and modulations in exploratory test. Subsequently, only the worst case emissions are reported.
2. Based on engineering evaluation, only the worst modulations test results are shown in the report.
3. Frequency Stability: Normal Voltage =3.3 V.; Low Voltage =3.135 V.; High Voltage =4.4 V

2.2 Connection Diagram of Test System

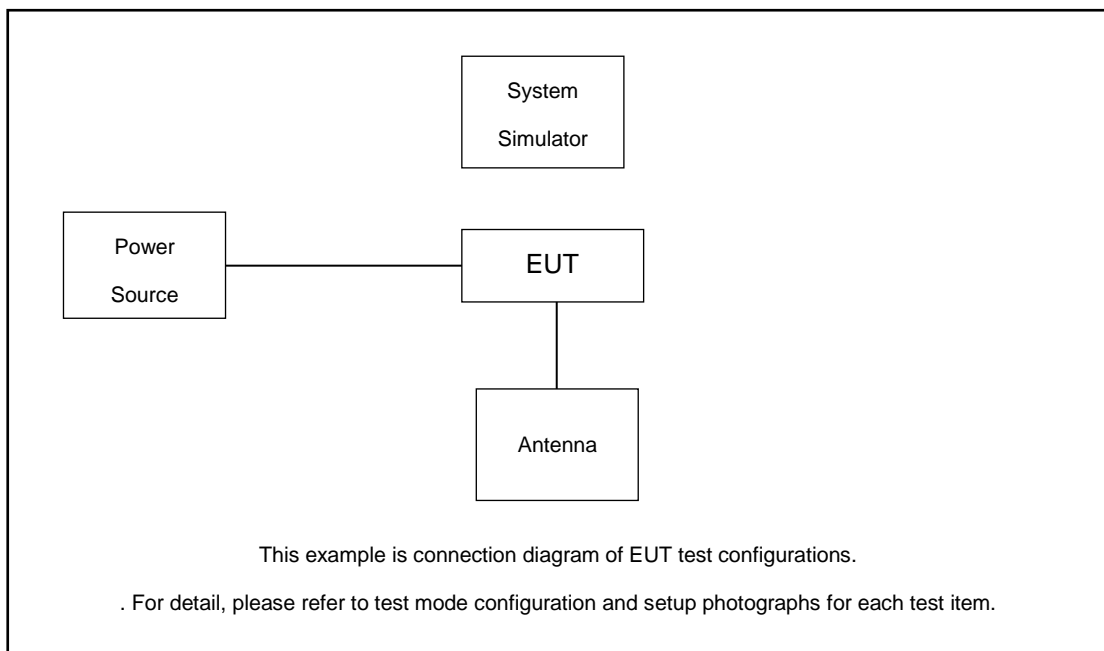



2.3 Support Unit used in test configuration and system

Item	Equipment	Trade Name	Model No.	FCC ID	Data Cable	Power Cord
1.	DC Power Supply	GW	GPS-3030D	N/A	N/A	Unshielded, 1.8 m
2.	LTE Base Station	Anritsu	MT8821C	N/A	N/A	Unshielded, 1.8 m
3.	NR Base Station	Anritsu	MT8000A	N/A	N/A	Unshielded, 1.8 m
4.	WWAN Antenna	N/A	N/A	N/A	N/A	N/A

2.4 Measurement Results Explanation Example

For all conducted test items:

The offset level is set in the spectrum analyzer to compensate the RF cable loss and attenuator factor between EUT conducted output port and spectrum analyzer. With the offset compensation, the spectrum analyzer reading level is exactly the EUT RF output level.

The spectrum analyzer offset is derived from RF cable loss and attenuator factor.

$$\text{Offset} = \text{RF cable loss} + \text{attenuator factor}.$$

Following shows an offset computation example with cable loss 4.98 dB and 10dB attenuator.

Example :

$$\begin{aligned} \text{Offset(dB)} &= \text{RF cable loss(dB)} + \text{attenuator factor(dB)}. \\ &= 4.98 + 10 = 14.98 \text{ (dB)} \end{aligned}$$



2.5 Frequency List of Low/Middle/High Channels

5G NR n7 Channel and Frequency List				
BW [MHz]	Channel/Frequency(MHz)	Lowest	Middle	Highest
20	Channel	526000	531000	536000
	Frequency	2510	2535	2560
15	Channel	525500	531000	536500
	Frequency	2507.5	2535	2562.5
10	Channel	525000	531000	537000
	Frequency	2505	2535	2565
5	Channel	524500	531000	537500
	Frequency	2502.5	2535	2567.5

5G NR n12 Channel and Frequency List				
BW [MHz]	Channel/Frequency(MHz)	Lowest	Middle	Highest
15	Channel	147300	147500	147700
	Frequency	706.5	707.5	708.5
10	Channel	146800	147500	148200
	Frequency	704	707.5	711
5	Channel	146300	147500	148700
	Frequency	701.5	707.5	713.5

5G NR n25 Channel and Frequency List				
BW [MHz]	Channel/Frequency(MHz)	Lowest	Middle	Highest
20	Channel	388000	392500	397000
	Frequency	1860	1882.5	1905
15	Channel	387500	392500	397500
	Frequency	1857.5	1882.5	1907.5
10	Channel	387000	392500	398000
	Frequency	1855	1882.5	1910
5	Channel	386500	392500	398500
	Frequency	1852.5	1882.5	1912.5



5G NR n41 Channel and Frequency List				
BW [MHz]	Channel/Frequency(MHz)	Lowest	Middle	Highest
100	Channel	509202	518598	528000
	Frequency	2546.01	2592.99	2640
90	Channel	508200	518598	528996
	Frequency	2541	2592.99	2644.98
80	Channel	507204	518598	529998
	Frequency	2536.02	2592.99	2649.99
70	Channel	506202	518598	531000
	Frequency	2531.01	2592.99	2655
60	Channel	505200	518598	531996
	Frequency	2526	2592.99	2659.98
50	Channel	504204	518598	532998
	Frequency	2521.02	2592.99	2664.99
40	Channel	503202	518598	534000
	Frequency	2516.01	2592.99	2670
30	Channel	502200	518598	534996
	Frequency	2511	2592.99	2674.98
20	Channel	501204	518598	535998
	Frequency	2506.02	2592.99	2679.99

5G NR n66 Channel and Frequency List				
BW [MHz]	Channel/Frequency(MHz)	Lowest	Middle	Highest
40	Channel	426000	429000	432000
	Frequency	1730	1745	1760
30	Channel	425000	429000	433000
	Frequency	1725	1745	1765
20	Channel	424000	429000	434000
	Frequency	1720	1745	1770
15	Channel	423500	429000	434500
	Frequency	1717.5	1745	1772.5
10	Channel	423000	429000	435000
	Frequency	1715	1745	1775
5	Channel	422500	429000	435500
	Frequency	1712.5	1745	1777.5



5G NR n77 Channel and Frequency List				
BW [MHz]	Channel/Frequency(MHz)	Lowest	Middle	Highest
100	Channel	650000	656000	662000
	Frequency	3750	3840	3930
90	Channel	649668	656000	662332
	Frequency	3745.02	3840	3934.98
80	Channel	649334	656000	662666
	Frequency	3740.01	3840	3939.99
70	Channel	649000	656000	663000
	Frequency	3735	3840	3945
60	Channel	648668	656000	663332
	Frequency	3730.02	3840	3949.98
50	Channel	648334	656000	663666
	Frequency	3725.01	3840	3954.99
40	Channel	648000	656000	664000
	Frequency	3720	3840	3960
30	Channel	647668	656000	664332
	Frequency	3715.02	3840	3964.98
20	Channel	647334	656000	664666
	Frequency	3710.01	3840	3969.99

3 Conducted Test Items

3.1 Measuring Instruments

See list of measuring instruments of this test report.

3.2 Test Setup

3.2.1 Conducted Output Power



3.2.2 Peak-to-Average Ratio, Occupied Bandwidth ,Conducted Band-Edge and Conducted Spurious Emission



3.2.3 Frequency Stability

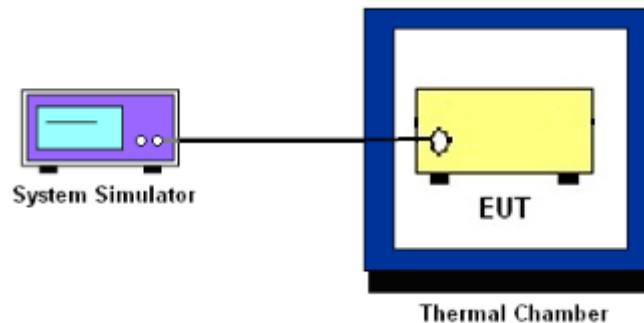

3.3 Test Result of Conducted Test

Please refer to Appendix A.



3.4 Conducted Output Power

3.4.1 Description of the Conducted Output Power Measurement

A system simulator was used to establish communication with the EUT. Its parameters were set to force the EUT transmitting at maximum output power. The measured power in the radio frequency on the transmitter output terminals shall be reported.

3.4.2 Test Procedures

1. The testing follows ANSI C63.26 Section 5.2
2. The transmitter output port was connected to the system simulator.
3. Set EUT at maximum power through the system simulator.
4. Select lowest, middle, and highest channels for each band and different modulation.
5. Measure and record the power level from the system simulator.



3.5 Peak-to-Average Ratio

3.5.1 Description of the PAR Measurement

Power Complementary Cumulative Distribution Function (CCDF) curves provide a means for characterizing the power peaks of a digitally modulated signal on a statistical basis. A CCDF curve depicts the probability of the peak signal amplitude exceeding the average power level. Most contemporary measurement instrumentation include the capability to produce CCDF curves for an input signal provided that the instrument's resolution bandwidth can be set wide enough to accommodate the entire input signal bandwidth. In measuring transmissions in this band using an average power technique, the peak-to-average ratio (PAR) of the transmission may not exceed 13 dB.

3.5.2 Test Procedures

1. The testing follows ANSI C63.26 Section 5.2.3.4 (CCDF).
2. The EUT was connected to spectrum and system simulator via a power divider.
3. Set the CCDF (Complementary Cumulative Distribution Function) option in spectrum analyzer.
4. The highest RF powers were measured and recorded the maximum PAPR level associated with a probability of 0.1 %.
5. Record the deviation as Peak to Average Ratio.



3.6 Occupied Bandwidth

3.6.1 Description of Occupied Bandwidth Measurement

The occupied bandwidth is the width of a frequency band such that, below the lower and above the upper frequency limits, the mean powers emitted are each equal to a specified percentage 0.5% of the total mean transmitted power.

The 26 dB emission bandwidth is defined as the frequency range between two points, one above and one below the carrier frequency, at which the spectral density of the emission is attenuated 26 dB below the maximum in-band spectral density of the modulated signal. Spectral density (power per unit bandwidth) is to be measured with a detector of resolution bandwidth equal to approximately 1.0% of the emission bandwidth.

3.6.2 Test Procedures

1. The testing follows ANSI C63.26 Section 5.4
2. The EUT was connected to spectrum analyzer and system simulator via a power divider.
3. The spectrum analyzer center frequency is set to the nominal EUT channel center frequency. The span range for the spectrum analyzer shall be between two and five times the anticipated OBW.
4. The nominal resolution bandwidth (RBW) shall be in the range of 1 to 5 % of the anticipated OBW, and the VBW shall be at least 3 times the RBW.
5. Set the detection mode to peak, and the trace mode to max hold.
6. Determine the reference value: Set the EUT to transmit a modulated signal. Allow the trace to stabilize. Set the spectrum analyzer marker to the highest level of the displayed trace.
(this is the reference value)
7. Determine the “-26 dB down amplitude” as equal to (Reference Value – X).
8. Place two markers, one at the lowest and the other at the highest frequency of the envelope of the spectral display such that each marker is at or slightly below the “-X dB down amplitude” determined in step 6. If a marker is below this “-X dB down amplitude” value it shall be placed as close as possible to this value. The OBW is the positive frequency difference between the two markers.
9. Use the 99 % power bandwidth function of the spectrum analyzer and report the measured bandwidth.



3.7 Conducted Band Edge

3.7.1 Description of Conducted Band Edge Measurement

24.238 (a)

For operations in the 1850-1910 and 1930-1990 MHz band, the FCC limit is $43 + 10\log_{10}(P[\text{Watts}])$ dB below the transmitter power $P(\text{Watts})$ in a 1MHz bandwidth. However, in the 1 MHz bands immediately outside and adjacent to the frequency block a resolution bandwidth of at least one percent of the emission bandwidth of the fundamental emission of the transmitter may be employed.

27.53 (h)

For operations in the 1710 – 1755 MHz band, the FCC limit is $43 + 10\log_{10}(P[\text{Watts}])$ dB below the transmitter power $P(\text{Watts})$ in a 1 MHz bandwidth. However, in the 1MHz bands immediately outside and adjacent to the licensee's frequency block, a resolution bandwidth of at least one percent of the emission bandwidth of the fundamental emission of the transmitter may be employed.

27.53 (g)

For operations in the 600MHz band and 698 -746 MHz band, the FCC limit is $43 + 10\log_{10}(P[\text{Watts}])$ dB below the transmitter power $P(\text{Watts})$ in a 100 kHz bandwidth. However, in the 100 kilohertz bands immediately outside and adjacent to a licensee's frequency block, a resolution bandwidth of at least 30 kHz may be employed.

27.53(m)(4)

For mobile digital stations, the attenuation factor shall be not less than $40 + 10 \log (P)$ dB on all frequencies between the channel edge and 5 megahertz from the channel edge, $43 + 10 \log (P)$ dB on all frequencies between 5 megahertz and X megahertz from the channel edge, and $55 + 10 \log (P)$ dB on all frequencies more than X megahertz from the channel edge, where X is the greater of 6 megahertz or the actual emission bandwidth as defined in paragraph (m)(6) of this section. In addition, the attenuation factor shall not be less that $43 + 10 \log (P)$ dB on all frequencies between 2490.5 MHz and 2496 MHz and $55 + 10 \log (P)$ dB at or below 2490.5 MHz. Mobile Satellite Service licensees operating on frequencies below 2495 MHz may also submit a documented interference complaint against BRS licensees operating on channel BRS Channel 1 on the same terms and conditions as adjacent channel BRS or EBS licensees.



27.53(l)(2)

For mobile operations in the 3700-3980 MHz band, the conducted power of any emission outside the licensee's authorized bandwidth shall not exceed -13 dBm/MHz. Compliance with this paragraph is based on the use of measurement instrumentation employing a resolution bandwidth of 1 megahertz or greater. However, in the 1 megahertz bands immediately outside and adjacent to the licensee's frequency block, the minimum resolution bandwidth for the measurement shall be either one percent of the emission bandwidth of the fundamental emission of the transmitter or 350 kHz. In the bands between 1 and 5 MHz removed from the licensee's frequency block, the minimum resolution bandwidth for the measurement shall be 500 kHz.

3.7.2 Test Procedures

1. The testing follows ANSI C63.26 section 5.7
2. The EUT was connected to spectrum analyzer and system simulator via a power divider.
3. The band edges of low and high channels for the highest RF powers were measured.
4. Set RBW \geq 1% EBW in the 1MHz band immediately outside and adjacent to the band edge.
5. Beyond the 1 MHz band from the band edge, RBW=1MHz was used.
6. Set spectrum analyzer with RMS detector.
7. The RF fundamental frequency should be excluded against the limit line in the operating frequency band.
8. Checked that all the results comply with the emission limit line.

Example:

$$\begin{aligned} &\text{The limit line is derived from } 43 + 10\log(P)\text{dB below the transmitter power } P(\text{Watts}) \\ &= P(\text{W}) - [43 + 10\log(P)] \text{ (dB)} \\ &= [30 + 10\log(P)] \text{ (dBm)} - [43 + 10\log(P)] \text{ (dB)} = -13\text{dBm}. \end{aligned}$$

9. For 5G NR n7/n41, the other 40 dB, and 55 dB have additionally applied same calculation above.
10. When using the integration method, the starting frequency of the integration shall be centered at one-half of the RBW away from the band edge.



3.8 Conducted Spurious Emission

3.8.1 Description of Conducted Spurious Emission Measurement

The power of any emission outside of the authorized operating frequency ranges must be lower than the transmitter power (P) by a factor of at least $43 + 10 \log (P)$ dB.

For 5G NR n7/n41:

The power of any emission outside of the authorized operating frequency ranges must be lower than the transmitter power (P) by a factor of at least $55 + 10 \log (P)$ dB.

It is measured by means of a calibrated spectrum analyzer and scanned from 30 MHz up to a frequency including its 10th harmonic.

3.8.2 Test Procedures

1. The testing follows ANSI C63.26 section 5.7
2. The EUT was connected to spectrum analyzer and system simulator via a power divider.
3. The RF output of EUT was connected to the spectrum analyzer by RF cable and attenuator. The path loss was compensated to the results for each measurement.
4. The middle channel for the highest RF power within the transmitting frequency was measured.
5. The conducted spurious emission for the whole frequency range was taken.
6. Make the measurement with the spectrum analyzer's RBW = 1MHz, VBW = 3MHz.
7. Set spectrum analyzer with RMS detector.
8. Taking the record of maximum spurious emission.
9. The RF fundamental frequency should be excluded against the limit line in the operating frequency band.
10. The limit line is derived from $43 + 10\log(P)$ dB below the transmitter power P(Watts)
 $= P(W) - [43 + 10\log(P)]$ (dB)
 $= [30 + 10\log(P)]$ (dBm) - $[43 + 10\log(P)]$ (dB)
 $= -13$ dBm.
11. For 5G NR n7/n41
The limit line is derived from $55 + 10\log(P)$ dB below the transmitter power P(Watts)
 $= P(W) - [55 + 10\log(P)]$ (dB)
 $= [30 + 10\log(P)]$ (dBm) - $[55 + 10\log(P)]$ (dB)
 $= -25$ dBm.



3.9 Frequency Stability

3.9.1 Description of Frequency Stability Measurement

The frequency stability shall be measured by variation of ambient temperature and variation of primary supply voltage to ensure that the fundamental emission stays within the authorized frequency block. The frequency stability of the transmitter shall be maintained within $\pm 0.00025\%$ ($\pm 2.5\text{ppm}$) of the center frequency.

3.9.2 Test Procedures for Temperature Variation

1. The testing follows ANSI C63.26 section 5.6.4
2. The EUT was set up in the thermal chamber and connected with the system simulator.
3. With power OFF, the temperature was decreased to -30°C and the EUT was stabilized before testing. Power was applied and the maximum change in frequency was recorded within one minute.
4. With power OFF, the temperature was raised in 10°C step up to 50°C . The EUT was stabilized at each step for at least half an hour. Power was applied and the maximum frequency change was recorded within one minute.

3.9.3 Test Procedures for Voltage Variation

1. The testing follows ANSI C63.26 section 5.6.5
2. The EUT was placed in a temperature chamber at $20\pm 5^{\circ}\text{C}$ and connected with the system simulator.
3. The power supply voltage to the EUT was varied from 85% to 115% of the nominal value for other than hand carried battery equipment.
4. For hand carried, battery powered equipment, reduce the primary ac or dc supply voltage to the battery operating end point, which shall be specified by the manufacturer.
5. The variation in frequency was measured for the worst case.

4 Radiated Test Items

4.1 Measuring Instruments

See list of measuring instruments of this test report.

4.2 Test Setup

4.2.1 For radiated test below 30MHz

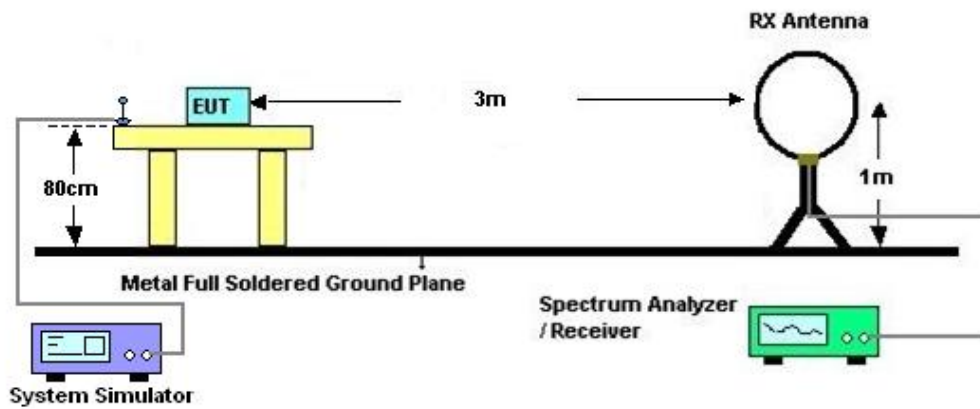

4.2.2 For radiated test from 30MHz to 1GHz

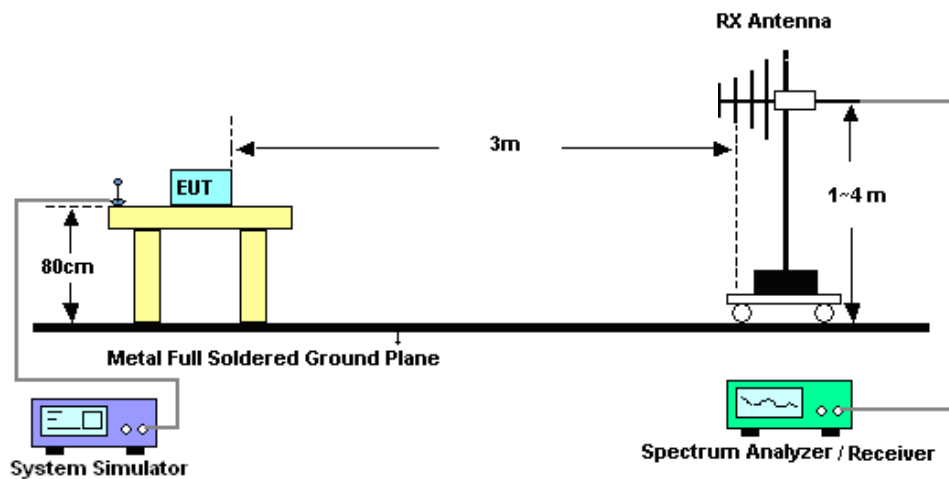

4.2.3 For radiated test above 1GHz

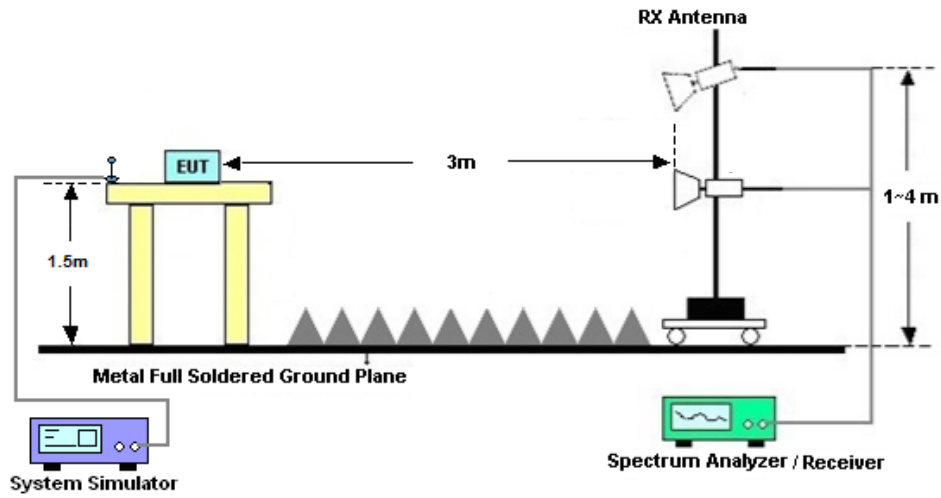

4.3 Test Result of Radiated Test

The low frequency, which started from 9 kHz to 30MHz, was pre-scanned and the result which was 20dB lower than the limit line was not reported.

Please refer to Appendix B.



4.4 Radiated Spurious Emission

4.4.1 Description of Radiated Spurious Emission

The radiated spurious emission was measured by substitution method according to ANSI C63.26. The power of any emission outside of the authorized operating frequency ranges must be attenuated below the transmitter power (P) by a factor of at least $43 + 10 \log (P)$ dB.

For 5G NR n7/n41

The power of any emission outside of the authorized operating frequency ranges must be attenuated below the transmitter power (P) by a factor of at least $55 + 10 \log (P)$ dB.

The spectrum is scanned from 30 MHz up to a frequency including its 10th harmonic.

4.4.2 Test Procedures

1. The testing follows ANSI C63.26 Section 5.5
2. The EUT was placed on a turntable with 0.8 meter height for frequency below 1GHz and 1.5 meter height for frequency above 1GHz respectively above ground.
3. The EUT was set 3 meters from the receiving antenna mounted on the antenna tower.
4. The table was rotated 360 degrees to determine the position of the highest spurious emission.
5. The height of the receiving antenna is varied between 1m to 4m to search the maximum spurious emission for both horizontal and vertical polarizations.
6. During the measurement, the system simulator parameters were set to force the EUT transmitting at maximum output power.
7. Make the measurement with the spectrum analyzer's RBW = 1MHz, VBW = 3MHz, taking the record of maximum spurious emission.
8. A horn antenna was substituted in place of the EUT and was driven by a signal generator.
9. Tune the output power of signal generator to the same emission level with EUT maximum spurious emission.
10. $EIRP (dBm) = S.G. Power - Tx Cable Loss + Tx Antenna Gain$
11. $ERP (dBm) = EIRP - 2.15$
12. The RF fundamental frequency should be excluded against the limit line in the operating frequency band.

The limit line is derived from $43 + 10\log(P)$ dB below the transmitter power P(Watts)
 $= P(W) - [43 + 10\log(P)] (dB)$
 $= [30 + 10\log(P)] (dBm) - [43 + 10\log(P)] (dB)$
 $= -13dBm.$

13. For 5G NR n7/n41:

The limit line is derived from $55 + 10\log(P)$ dB below the transmitter power P(Watts)The limit line is derived from $55 + 10\log(P)$ dB below the transmitter power P(Watts)



5 List of Measuring Equipment

Instrument	Manufacturer	Model No.	Serial No.	Characteristics	Calibration Date	Test Date	Due Date	Remark
Spectrum Analyzer	R&S	FSV40	101078	10Hz~40GHz	Apr. 08, 2021	Nov. 18, 2021~ Dec. 29, 2021	Apr. 07, 2022	Conducted (TH01-SZ)
Power Divider	TOJOIN	PS-2SM-04 265	60.06.020.007 7	0.4GHz~26.5GHz	Dec. 26, 2020	Nov. 18, 2021~ Dec. 29, 2021	Dec. 25, 2021	Conducted (TH01-SZ)
Power Divider	TOJOIN	PS-2SM-04 265	60.06.020.007 7	0.4GHz~26.5GHz	Dec. 25, 2021		Dec. 24, 2022	Conducted (TH01-SZ)
Thermal Chamber	Ten Billion Hongzhangroup	LP-150U	H2014081803	-40~+150°C	Jul. 14, 2021	Nov. 18, 2021~ Dec. 29, 2021	Jul. 13, 2022	Conducted (TH01-SZ)
EMI Test Receiver&SA	KEYSIGHT	N9038A	MY54450083	20Hz~8.4GHz	Apr. 07, 2021	Jan. 05, 2022~ Jan. 06, 2022	Apr. 06, 2022	Radiation (03CH03-SZ)
Loop Antenna	R&S	HFH2-Z2	100354	9kHz~30MHz	Jun. 22, 2021	Jan. 05, 2022~ Jan. 06, 2022	Jun. 21, 2022	Radiation (03CH03-SZ)
EXA Spectrum Analyzer	KEYSIGHT	N9010A	MY55150246	10Hz~44GHz;	Apr. 07, 2021	Jan. 05, 2022~ Jan. 06, 2022	Apr. 06, 2022	Radiation (03CH03-SZ)
Bilog Antenna	TeseQ	CBL6112D	35408	30MHz~2GHz	Jun. 22, 2021	Jan. 05, 2022~ Jan. 06, 2022	Jun. 21, 2022	Radiation (03CH03-SZ)
Double Ridge Horn Antenna	SCHWARZBECK	BBHA9120D	9120D-1355	1GHz~18GHz	Apr. 25, 2021	Jan. 05, 2022~ Jan. 06, 2022	Apr. 24, 2022	Radiation (03CH03-SZ)
Amplifier	Burgeon	BPA-530	102211	0.01Hz ~3000MHz	Oct. 22, 2021	Jan. 05, 2022~ Jan. 06, 2022	Oct. 21, 2022	Radiation (03CH03-SZ)
HF Amplifier	MITEQ	TTA1840-35 -HG	1871923	18GHz~40GHz	Oct. 22, 2021	Jan. 05, 2022~ Jan. 06, 2022	Oct. 21, 2022	Radiation (03CH03-SZ)
SHF-EHF Horn	com-power	AH-840	101071	18Ghz-40GHz	Apr. 11, 2021	Jan. 05, 2022~ Jan. 06, 2022	Apr. 10, 2022	Radiation (03CH03-SZ)
Amplifier	Agilent Technologies	83017A	MY39501302	500MHz~26.5GHz	Dec. 30, 2021	Jan. 05, 2022~ Jan. 06, 2022	Dec. 29, 2022	Radiation (03CH03-SZ)
AC Power Source	Chroma	61601	616010001985	N/A	NCR	Jan. 05, 2022~ Jan. 06, 2022	NCR	Radiation (03CH03-SZ)
Turn Table	EM	EM1000	N/A	0~360 degree	NCR	Jan. 05, 2022~ Jan. 06, 2022	NCR	Radiation (03CH03-SZ)
Antenna Mast	EM	EM1000	N/A	1 m~4 m	NCR	Jan. 05, 2022~ Jan. 06, 2022	NCR	Radiation (03CH03-SZ)

NCR: No Calibration Required



6 Uncertainty of Evaluation

The measurement uncertainties shown below were calculated in accordance with the requirements of ANSI 63.26-2015. All the measurement uncertainty value were shown with a coverage K=2 to indicate 95% level of confidence. The measurement data show herein meets or exceeds the CISPR measurement uncertainty values specified in CISPR 16-4-2 and can be compared directly to specified limit to determine compliance.

Uncertainty of Radiated Emission Measurement (30 MHz ~ 1000 MHz)

Measuring Uncertainty for a Level of Confidence of 95% (U = 2Uc(y))	3.0dB
---	-------

Uncertainty of Radiated Emission Measurement (1 GHz ~ 18 GHz)

Measuring Uncertainty for a Level of Confidence of 95% (U = 2Uc(y))	3.6dB
---	-------

Uncertainty of Radiated Emission Measurement (18 GHz ~ 40 GHz)

Measuring Uncertainty for a Level of Confidence of 95% (U = 2Uc(y))	3.8dB
---	-------

----- THE END -----



Appendix A. Test Results of Conducted Test

Test Engineer :	Jung Guo	Temperature :	24~26°C
		Relative Humidity :	50~53%



Software Version: 21.02.121001

FR1 N7

LTE Band: 5, LTE BW: 10M, LTE ARFCN: Mid

Transmitter Conducted Output Power

NR Band	SCS (kHz)	Bandwidth (MHz)	Arfcn	Freq (MHz)	Modulation	RB	Conducted Power(dBm)
7	15	5	524500	2502.5	DFT-s-OFDM PI/2 BPSK	12@6	23.39
7	15	5	524500	2502.5	DFT-s-OFDM PI/2 BPSK	1@1	23.33
7	15	5	524500	2502.5	DFT-s-OFDM PI/2 BPSK	1@23	23.4
7	15	5	524500	2502.5	DFT-s-OFDM QPSK	12@6	23.36
7	15	5	524500	2502.5	DFT-s-OFDM QPSK	1@1	23.32
7	15	5	524500	2502.5	DFT-s-OFDM QPSK	1@23	23.37
7	15	5	524500	2502.5	DFT-s-OFDM 16 QAM	12@6	22.24
7	15	5	524500	2502.5	DFT-s-OFDM 16 QAM	1@1	22.15
7	15	5	524500	2502.5	DFT-s-OFDM 16 QAM	1@23	22.16
7	15	5	524500	2502.5	DFT-s-OFDM 64 QAM	12@6	20.76
7	15	5	524500	2502.5	DFT-s-OFDM 64 QAM	1@1	20.78
7	15	5	524500	2502.5	DFT-s-OFDM 64 QAM	1@23	20.68
7	15	5	524500	2502.5	DFT-s-OFDM 256 QAM	12@6	18.71
7	15	5	524500	2502.5	DFT-s-OFDM 256 QAM	1@1	18.81
7	15	5	524500	2502.5	DFT-s-OFDM 256 QAM	1@23	18.8
7	15	5	524500	2502.5	CP-OFDM QPSK	13@6	21.74
7	15	5	524500	2502.5	CP-OFDM QPSK	1@1	21.74
7	15	5	524500	2502.5	CP-OFDM QPSK	1@23	21.69
7	15	5	531000	2535	DFT-s-OFDM PI/2 BPSK	12@6	22.99
7	15	5	531000	2535	DFT-s-OFDM PI/2 BPSK	1@1	23
7	15	5	531000	2535	DFT-s-OFDM PI/2 BPSK	1@23	22.94
7	15	5	531000	2535	DFT-s-OFDM QPSK	12@6	22.96
7	15	5	531000	2535	DFT-s-OFDM QPSK	1@1	22.97
7	15	5	531000	2535	DFT-s-OFDM QPSK	1@23	22.9
7	15	5	531000	2535	DFT-s-OFDM 16 QAM	12@6	22
7	15	5	531000	2535	DFT-s-OFDM	1@1	22.09



					16 QAM		
7	15	5	531000	2535	DFT-s-OFDM 16 QAM	1@23	21.81
7	15	5	531000	2535	DFT-s-OFDM 64 QAM	12@6	20.47
7	15	5	531000	2535	DFT-s-OFDM 64 QAM	1@1	20.54
7	15	5	531000	2535	DFT-s-OFDM 64 QAM	1@23	20.38
7	15	5	531000	2535	DFT-s-OFDM 256 QAM	12@6	18.45
7	15	5	531000	2535	DFT-s-OFDM 256 QAM	1@1	18.65
7	15	5	531000	2535	DFT-s-OFDM 256 QAM	1@23	18.63
7	15	5	531000	2535	CP-OFDM QPSK	13@6	21.46
7	15	5	531000	2535	CP-OFDM QPSK	1@1	21.57
7	15	5	531000	2535	CP-OFDM QPSK	1@23	21.47
7	15	5	537500	2567.5	DFT-s-OFDM PI/2 BPSK	12@6	22.89
7	15	5	537500	2567.5	DFT-s-OFDM PI/2 BPSK	1@1	22.85
7	15	5	537500	2567.5	DFT-s-OFDM PI/2 BPSK	1@23	22.92
7	15	5	537500	2567.5	DFT-s-OFDM QPSK	12@6	22.92
7	15	5	537500	2567.5	DFT-s-OFDM QPSK	1@1	22.88
7	15	5	537500	2567.5	DFT-s-OFDM QPSK	1@23	22.9
7	15	5	537500	2567.5	DFT-s-OFDM 16 QAM	12@6	21.89
7	15	5	537500	2567.5	DFT-s-OFDM 16 QAM	1@1	21.84
7	15	5	537500	2567.5	DFT-s-OFDM 16 QAM	1@23	21.68
7	15	5	537500	2567.5	DFT-s-OFDM 64 QAM	12@6	20.38
7	15	5	537500	2567.5	DFT-s-OFDM 64 QAM	1@1	20.43
7	15	5	537500	2567.5	DFT-s-OFDM 64 QAM	1@23	20.31
7	15	5	537500	2567.5	DFT-s-OFDM 256 QAM	12@6	18.36
7	15	5	537500	2567.5	DFT-s-OFDM 256 QAM	1@1	18.6
7	15	5	537500	2567.5	DFT-s-OFDM 256 QAM	1@23	18.41
7	15	5	537500	2567.5	CP-OFDM QPSK	13@6	21.43
7	15	5	537500	2567.5	CP-OFDM QPSK	1@1	21.42
7	15	5	537500	2567.5	CP-OFDM QPSK	1@23	21.42
7	15	10	525000	2505	DFT-s-OFDM PI/2 BPSK	25@12	23.41
7	15	10	525000	2505	DFT-s-OFDM PI/2 BPSK	1@1	23.29
7	15	10	525000	2505	DFT-s-OFDM PI/2 BPSK	1@50	23.33
7	15	10	525000	2505	DFT-s-OFDM	25@12	23.38



					QPSK		
7	15	10	525000	2505	DFT-s-OFDM QPSK	1@1	23.29
7	15	10	525000	2505	DFT-s-OFDM QPSK	1@50	23.27
7	15	10	525000	2505	DFT-s-OFDM 16 QAM	25@12	22.3
7	15	10	525000	2505	DFT-s-OFDM 16 QAM	1@1	22.31
7	15	10	525000	2505	DFT-s-OFDM 16 QAM	1@50	22.24
7	15	10	525000	2505	DFT-s-OFDM 64 QAM	25@12	20.87
7	15	10	525000	2505	DFT-s-OFDM 64 QAM	1@1	20.86
7	15	10	525000	2505	DFT-s-OFDM 64 QAM	1@50	20.73
7	15	10	525000	2505	DFT-s-OFDM 256 QAM	25@12	18.87
7	15	10	525000	2505	DFT-s-OFDM 256 QAM	1@1	18.87
7	15	10	525000	2505	DFT-s-OFDM 256 QAM	1@50	18.76
7	15	10	525000	2505	CP-OFDM QPSK	26@13	21.87
7	15	10	525000	2505	CP-OFDM QPSK	1@1	21.81
7	15	10	525000	2505	CP-OFDM QPSK	1@50	21.8
7	15	10	531000	2535	DFT-s-OFDM PI/2 BPSK	25@12	23.1
7	15	10	531000	2535	DFT-s-OFDM PI/2 BPSK	1@1	23.07
7	15	10	531000	2535	DFT-s-OFDM PI/2 BPSK	1@50	22.94
7	15	10	531000	2535	DFT-s-OFDM QPSK	25@12	23
7	15	10	531000	2535	DFT-s-OFDM QPSK	1@1	23.05
7	15	10	531000	2535	DFT-s-OFDM QPSK	1@50	22.91
7	15	10	531000	2535	DFT-s-OFDM 16 QAM	25@12	21.91
7	15	10	531000	2535	DFT-s-OFDM 16 QAM	1@1	22.04
7	15	10	531000	2535	DFT-s-OFDM 16 QAM	1@50	21.91
7	15	10	531000	2535	DFT-s-OFDM 64 QAM	25@12	20.4
7	15	10	531000	2535	DFT-s-OFDM 64 QAM	1@1	20.5
7	15	10	531000	2535	DFT-s-OFDM 64 QAM	1@50	20.46
7	15	10	531000	2535	DFT-s-OFDM 256 QAM	25@12	18.48
7	15	10	531000	2535	DFT-s-OFDM 256 QAM	1@1	18.54
7	15	10	531000	2535	DFT-s-OFDM 256 QAM	1@50	18.62
7	15	10	531000	2535	CP-OFDM QPSK	26@13	21.42
7	15	10	531000	2535	CP-OFDM QPSK	1@1	21.45
7	15	10	531000	2535	CP-OFDM	1@50	21.48



					QPSK		
7	15	10	537000	2565	DFT-s-OFDM PI/2 BPSK	25@12	23.01
7	15	10	537000	2565	DFT-s-OFDM PI/2 BPSK	1@1	22.9
7	15	10	537000	2565	DFT-s-OFDM PI/2 BPSK	1@50	22.85
7	15	10	537000	2565	DFT-s-OFDM QPSK	25@12	22.96
7	15	10	537000	2565	DFT-s-OFDM QPSK	1@1	22.87
7	15	10	537000	2565	DFT-s-OFDM QPSK	1@50	22.8
7	15	10	537000	2565	DFT-s-OFDM 16 QAM	25@12	21.88
7	15	10	537000	2565	DFT-s-OFDM 16 QAM	1@1	21.86
7	15	10	537000	2565	DFT-s-OFDM 16 QAM	1@50	21.91
7	15	10	537000	2565	DFT-s-OFDM 64 QAM	25@12	20.4
7	15	10	537000	2565	DFT-s-OFDM 64 QAM	1@1	20.38
7	15	10	537000	2565	DFT-s-OFDM 64 QAM	1@50	20.29
7	15	10	537000	2565	DFT-s-OFDM 256 QAM	25@12	18.41
7	15	10	537000	2565	DFT-s-OFDM 256 QAM	1@1	18.51
7	15	10	537000	2565	DFT-s-OFDM 256 QAM	1@50	18.45
7	15	10	537000	2565	CP-OFDM QPSK	26@13	21.39
7	15	10	537000	2565	CP-OFDM QPSK	1@1	21.37
7	15	10	537000	2565	CP-OFDM QPSK	1@50	21.38
7	15	15	525500	2507.5	DFT-s-OFDM PI/2 BPSK	36@18	23.35
7	15	15	525500	2507.5	DFT-s-OFDM PI/2 BPSK	1@1	23.37
7	15	15	525500	2507.5	DFT-s-OFDM PI/2 BPSK	1@77	23.39
7	15	15	525500	2507.5	DFT-s-OFDM QPSK	36@18	23.34
7	15	15	525500	2507.5	DFT-s-OFDM QPSK	1@1	23.34
7	15	15	525500	2507.5	DFT-s-OFDM QPSK	1@77	23.29
7	15	15	525500	2507.5	DFT-s-OFDM 16 QAM	36@18	22.34
7	15	15	525500	2507.5	DFT-s-OFDM 16 QAM	1@1	22.37
7	15	15	525500	2507.5	DFT-s-OFDM 16 QAM	1@77	22.29
7	15	15	525500	2507.5	DFT-s-OFDM 64 QAM	36@18	20.81
7	15	15	525500	2507.5	DFT-s-OFDM 64 QAM	1@1	20.88
7	15	15	525500	2507.5	DFT-s-OFDM 64 QAM	1@77	20.74
7	15	15	525500	2507.5	DFT-s-OFDM 256 QAM	36@18	18.8
7	15	15	525500	2507.5	DFT-s-OFDM	1@1	18.97



					256 QAM		
7	15	15	525500	2507.5	DFT-s-OFDM 256 QAM	1@77	18.88
7	15	15	525500	2507.5	CP-OFDM QPSK	39@19	21.82
7	15	15	525500	2507.5	CP-OFDM QPSK	1@1	21.97
7	15	15	525500	2507.5	CP-OFDM QPSK	1@77	21.7
7	15	15	531000	2535	DFT-s-OFDM PI/2 BPSK	36@18	23.08
7	15	15	531000	2535	DFT-s-OFDM PI/2 BPSK	1@1	23.18
7	15	15	531000	2535	DFT-s-OFDM PI/2 BPSK	1@77	23.05
7	15	15	531000	2535	DFT-s-OFDM QPSK	36@18	23.05
7	15	15	531000	2535	DFT-s-OFDM QPSK	1@1	23.18
7	15	15	531000	2535	DFT-s-OFDM QPSK	1@77	22.94
7	15	15	531000	2535	DFT-s-OFDM 16 QAM	36@18	22.06
7	15	15	531000	2535	DFT-s-OFDM 16 QAM	1@1	22.15
7	15	15	531000	2535	DFT-s-OFDM 16 QAM	1@77	21.88
7	15	15	531000	2535	DFT-s-OFDM 64 QAM	36@18	20.57
7	15	15	531000	2535	DFT-s-OFDM 64 QAM	1@1	20.68
7	15	15	531000	2535	DFT-s-OFDM 64 QAM	1@77	20.55
7	15	15	531000	2535	DFT-s-OFDM 256 QAM	36@18	18.55
7	15	15	531000	2535	DFT-s-OFDM 256 QAM	1@1	18.79
7	15	15	531000	2535	DFT-s-OFDM 256 QAM	1@77	18.45
7	15	15	531000	2535	CP-OFDM QPSK	39@19	21.55
7	15	15	531000	2535	CP-OFDM QPSK	1@1	21.67
7	15	15	531000	2535	CP-OFDM QPSK	1@77	21.43
7	15	15	536500	2562.5	DFT-s-OFDM PI/2 BPSK	36@18	22.94
7	15	15	536500	2562.5	DFT-s-OFDM PI/2 BPSK	1@1	22.96
7	15	15	536500	2562.5	DFT-s-OFDM PI/2 BPSK	1@77	22.98
7	15	15	536500	2562.5	DFT-s-OFDM QPSK	36@18	22.94
7	15	15	536500	2562.5	DFT-s-OFDM QPSK	1@1	22.92
7	15	15	536500	2562.5	DFT-s-OFDM QPSK	1@77	22.87
7	15	15	536500	2562.5	DFT-s-OFDM 16 QAM	36@18	21.95
7	15	15	536500	2562.5	DFT-s-OFDM 16 QAM	1@1	21.95
7	15	15	536500	2562.5	DFT-s-OFDM 16 QAM	1@77	22.02
7	15	15	536500	2562.5	DFT-s-OFDM	36@18	20.43



					64 QAM		
7	15	15	536500	2562.5	DFT-s-OFDM 64 QAM	1@1	20.34
7	15	15	536500	2562.5	DFT-s-OFDM 64 QAM	1@77	20.37
7	15	15	536500	2562.5	DFT-s-OFDM 256 QAM	36@18	18.45
7	15	15	536500	2562.5	DFT-s-OFDM 256 QAM	1@1	18.47
7	15	15	536500	2562.5	DFT-s-OFDM 256 QAM	1@77	18.37
7	15	15	536500	2562.5	CP-OFDM QPSK	39@19	21.42
7	15	15	536500	2562.5	CP-OFDM QPSK	1@1	21.4
7	15	15	536500	2562.5	CP-OFDM QPSK	1@77	21.16
7	15	20	526000	2510	DFT-s-OFDM PI/2 BPSK	50@25	23.38
7	15	20	526000	2510	DFT-s-OFDM PI/2 BPSK	1@1	23.4
7	15	20	526000	2510	DFT-s-OFDM PI/2 BPSK	1@104	23.31
7	15	20	526000	2510	DFT-s-OFDM QPSK	50@25	23.42
7	15	20	526000	2510	DFT-s-OFDM QPSK	1@1	23.34
7	15	20	526000	2510	DFT-s-OFDM QPSK	1@104	23.31
7	15	20	526000	2510	DFT-s-OFDM 16 QAM	50@25	22.31
7	15	20	526000	2510	DFT-s-OFDM 16 QAM	1@1	22.36
7	15	20	526000	2510	DFT-s-OFDM 16 QAM	1@104	22.26
7	15	20	526000	2510	DFT-s-OFDM 64 QAM	50@25	20.81
7	15	20	526000	2510	DFT-s-OFDM 64 QAM	1@1	20.79
7	15	20	526000	2510	DFT-s-OFDM 64 QAM	1@104	20.7
7	15	20	526000	2510	DFT-s-OFDM 256 QAM	50@25	18.85
7	15	20	526000	2510	DFT-s-OFDM 256 QAM	1@1	18.83
7	15	20	526000	2510	DFT-s-OFDM 256 QAM	1@104	18.82
7	15	20	526000	2510	CP-OFDM QPSK	53@26	21.83
7	15	20	526000	2510	CP-OFDM QPSK	1@1	21.99
7	15	20	526000	2510	CP-OFDM QPSK	1@104	21.79
7	15	20	531000	2535	DFT-s-OFDM PI/2 BPSK	50@25	23.1
7	15	20	531000	2535	DFT-s-OFDM PI/2 BPSK	1@1	23.21
7	15	20	531000	2535	DFT-s-OFDM PI/2 BPSK	1@104	23.05
7	15	20	531000	2535	DFT-s-OFDM QPSK	50@25	23.12
7	15	20	531000	2535	DFT-s-OFDM QPSK	1@1	23.17
7	15	20	531000	2535	DFT-s-OFDM	1@104	22.98



					QPSK		
7	15	20	531000	2535	DFT-s-OFDM 16 QAM	50@25	22.03
7	15	20	531000	2535	DFT-s-OFDM 16 QAM	1@1	22.23
7	15	20	531000	2535	DFT-s-OFDM 16 QAM	1@104	21.9
7	15	20	531000	2535	DFT-s-OFDM 64 QAM	50@25	20.59
7	15	20	531000	2535	DFT-s-OFDM 64 QAM	1@1	20.7
7	15	20	531000	2535	DFT-s-OFDM 64 QAM	1@104	20.4
7	15	20	531000	2535	DFT-s-OFDM 256 QAM	50@25	18.55
7	15	20	531000	2535	DFT-s-OFDM 256 QAM	1@1	18.72
7	15	20	531000	2535	DFT-s-OFDM 256 QAM	1@104	18.49
7	15	20	531000	2535	CP-OFDM QPSK	53@26	21.56
7	15	20	531000	2535	CP-OFDM QPSK	1@1	21.69
7	15	20	531000	2535	CP-OFDM QPSK	1@104	21.51
7	15	20	536000	2560	DFT-s-OFDM PI/2 BPSK	50@25	22.99
7	15	20	536000	2560	DFT-s-OFDM PI/2 BPSK	1@1	22.95
7	15	20	536000	2560	DFT-s-OFDM PI/2 BPSK	1@104	22.9
7	15	20	536000	2560	DFT-s-OFDM QPSK	50@25	22.99
7	15	20	536000	2560	DFT-s-OFDM QPSK	1@1	22.9
7	15	20	536000	2560	DFT-s-OFDM QPSK	1@104	22.89
7	15	20	536000	2560	DFT-s-OFDM 16 QAM	50@25	21.95
7	15	20	536000	2560	DFT-s-OFDM 16 QAM	1@1	22.04
7	15	20	536000	2560	DFT-s-OFDM 16 QAM	1@104	21.83
7	15	20	536000	2560	DFT-s-OFDM 64 QAM	50@25	20.42
7	15	20	536000	2560	DFT-s-OFDM 64 QAM	1@1	20.51
7	15	20	536000	2560	DFT-s-OFDM 64 QAM	1@104	20.34
7	15	20	536000	2560	DFT-s-OFDM 256 QAM	50@25	18.46
7	15	20	536000	2560	DFT-s-OFDM 256 QAM	1@1	18.26
7	15	20	536000	2560	DFT-s-OFDM 256 QAM	1@104	18.36
7	15	20	536000	2560	CP-OFDM QPSK	53@26	21.44
7	15	20	536000	2560	CP-OFDM QPSK	1@1	21.45
7	15	20	536000	2560	CP-OFDM QPSK	1@104	21.33



Frequency Stability

NR Band	SCS (kHz)	Bandwidth (MHz)	Arfcn	Freq (MHz)	Modulation	RB	Deviation (ppm)	Verdict	Environment
7	15	20	531000	2535.0	DFT-s-OFDM QPSK	100@0	0.0481	PASS	NV
7	15	20	531000	2535.0	DFT-s-OFDM QPSK	100@0	0.0477	PASS	LV
7	15	20	531000	2535.0	DFT-s-OFDM QPSK	100@0	0.0413	PASS	HV
7	15	20	531000	2535.0	DFT-s-OFDM QPSK	100@0	0.0491	PASS	-30°C
7	15	20	531000	2535.0	DFT-s-OFDM QPSK	100@0	0.0422	PASS	-20°C
7	15	20	531000	2535.0	DFT-s-OFDM QPSK	100@0	0.0492	PASS	-10°C
7	15	20	531000	2535.0	DFT-s-OFDM QPSK	100@0	0.0286	PASS	0°C
7	15	20	531000	2535.0	DFT-s-OFDM QPSK	100@0	0.0545	PASS	10°C
7	15	20	531000	2535.0	DFT-s-OFDM QPSK	100@0	0.0035	PASS	20°C
7	15	20	531000	2535.0	DFT-s-OFDM QPSK	100@0	0.0439	PASS	30°C
7	15	20	531000	2535.0	DFT-s-OFDM QPSK	100@0	0.0517	PASS	40°C
7	15	20	531000	2535.0	DFT-s-OFDM QPSK	100@0	0.0043	PASS	50°C



Peak to Average Ratio

NR Band	SCS (kHz)	Bandwidth (MHz)	Arfcn	Freq (MHz)	Modulation	RB	Result (dB)	Limit (dB)	Verdict
7	15	20	526000	2510.0	DFT-s-OFDM PI/2 BPSK	100@0	4.06	13	PASS
7	15	20	526000	2510.0	DFT-s-OFDM PI/2 BPSK	1@0	3.8	13	PASS
7	15	20	526000	2510.0	DFT-s-OFDM QPSK	100@0	4.54	13	PASS
7	15	20	526000	2510.0	DFT-s-OFDM QPSK	1@0	3.93	13	PASS
7	15	20	531000	2535.0	DFT-s-OFDM PI/2 BPSK	100@0	3.87	13	PASS
7	15	20	531000	2535.0	DFT-s-OFDM PI/2 BPSK	1@0	3.73	13	PASS
7	15	20	531000	2535.0	DFT-s-OFDM QPSK	100@0	4.55	13	PASS
7	15	20	531000	2535.0	DFT-s-OFDM QPSK	1@0	3.73	13	PASS
7	15	20	536000	2560.0	DFT-s-OFDM PI/2 BPSK	100@0	3.81	13	PASS
7	15	20	536000	2560.0	DFT-s-OFDM PI/2 BPSK	1@0	3.72	13	PASS
7	15	20	536000	2560.0	DFT-s-OFDM QPSK	100@0	4.41	13	PASS
7	15	20	536000	2560.0	DFT-s-OFDM QPSK	1@0	3.9	13	PASS



B5_N7(20M)_DFT-s-OFDM_PI_2-BPSK_Outer_Full_Low_CH

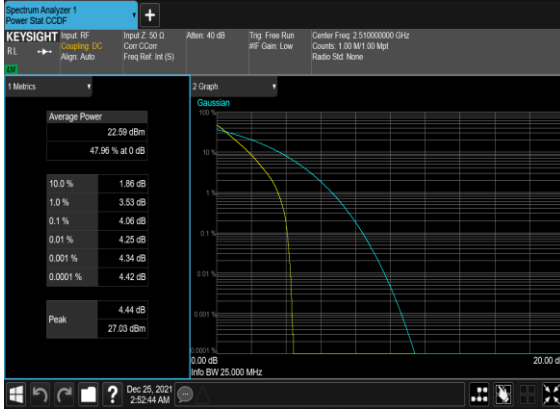

B5_N7(20M)_DFT-s-OFDM_PI_2-BPSK_Edge_1RB_Left_Low_CH

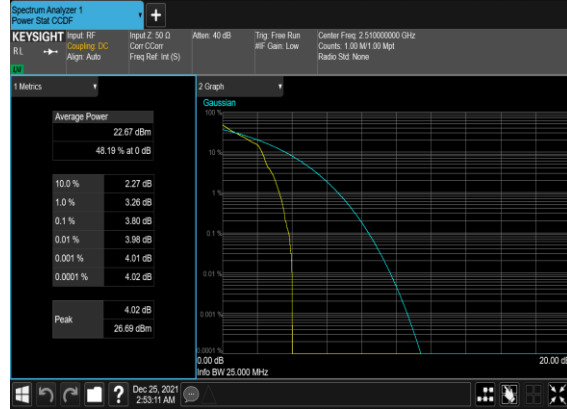

B5_N7(20M)_DFT-s-OFDM_QPSK_Outer_Full_Low_CH



B5_N7(20M)_DFT-s-OFDM_QPSK_Edge_1RB_Left_Low_CH





B5_N7(20M)_DFT-s-OFDM_PI_2-BPSK_Outer_Full_Mid_CH



B5_N7(20M)_DFT-s-OFDM_PI_2-BPSK_Edge_1RB_Left_Mid_CH

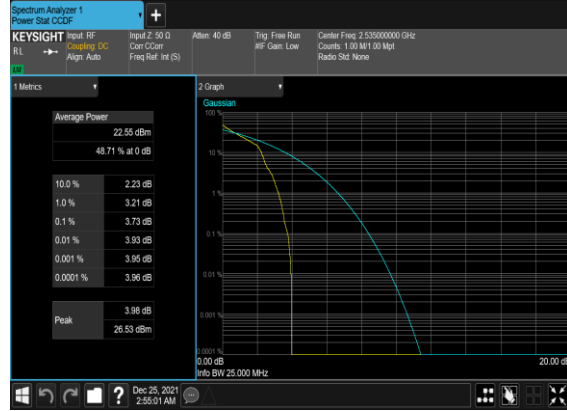

B5_N7(20M)_DFT-s-OFDM_QPSK_Outer_Full_Mid_CH



B5_N7(20M)_DFT-s-OFDM_QPSK_Edge_1RB_Left_Mid_CH

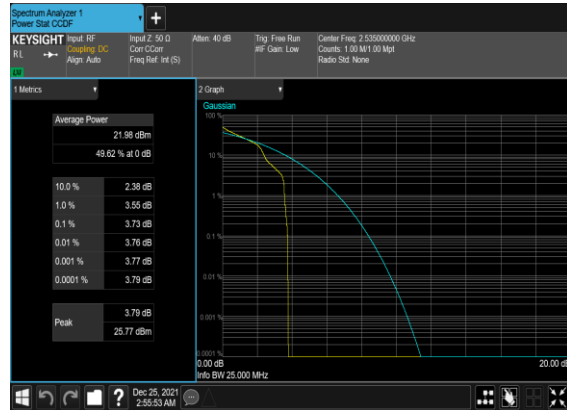



B5_N7(20M)_DFT-s-OFDM_PI_2-BPSK_Outer_Full_High_CH



B5_N7(20M)_DFT-s-OFDM_PI_2-BPSK_Edge_1RB_Left_High_CH

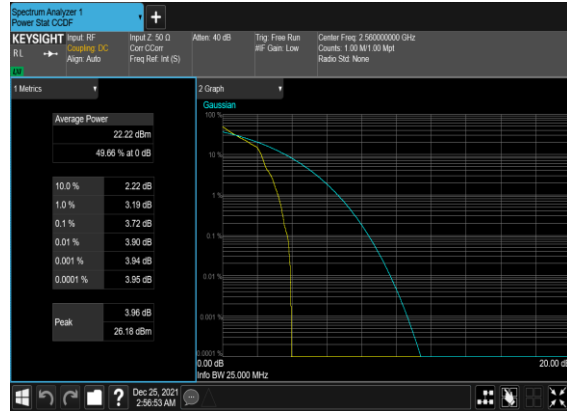

B5_N7(20M)_DFT-s-OFDM_QPSK_Outer_Full_High_CH



B5_N7(20M)_DFT-s-OFDM_QPSK_Edge_1RB_Left_High_CH





Occupied Bandwidth

NR Band	SCS (kHz)	Bandwidth (MHz)	Arfcn	Freq (MHz)	Modulation	RB	OBW (MHz)	26dB OBW (MHz)
7	15	5	531000	2535.0	DFT-s-OFDM PI/2 BPSK	25@0	4.4745	4.905
7	15	5	531000	2535.0	DFT-s-OFDM QPSK	25@0	4.4785	4.95
7	15	5	531000	2535.0	CP-OFDM QPSK	25@0	4.4673	5.04
7	15	5	531000	2535.0	CP-OFDM 16 QAM	25@0	4.4676	4.928
7	15	5	531000	2535.0	CP-OFDM 64 QAM	25@0	4.4719	5.02
7	15	5	531000	2535.0	CP-OFDM 256 QAM	25@0	4.4743	5.19
7	15	10	531000	2535.0	DFT-s-OFDM PI/2 BPSK	50@0	8.9389	9.492
7	15	10	531000	2535.0	DFT-s-OFDM QPSK	50@0	8.9187	9.504
7	15	10	531000	2535.0	CP-OFDM QPSK	52@0	9.2878	9.929
7	15	10	531000	2535.0	CP-OFDM 16 QAM	52@0	9.2769	9.918
7	15	10	531000	2535.0	CP-OFDM 64 QAM	52@0	9.299	10.09
7	15	10	531000	2535.0	CP-OFDM 256 QAM	52@0	9.2827	9.921
7	15	15	531000	2535.0	DFT-s-OFDM PI/2 BPSK	75@0	13.413	14.1
7	15	15	531000	2535.0	DFT-s-OFDM QPSK	75@0	13.396	14.15
7	15	15	531000	2535.0	CP-OFDM QPSK	79@0	14.099	14.9
7	15	15	531000	2535.0	CP-OFDM 16 QAM	79@0	14.105	14.84
7	15	15	531000	2535.0	CP-OFDM 64 QAM	79@0	14.126	14.89
7	15	15	531000	2535.0	CP-OFDM 256 QAM	79@0	14.109	14.87
7	15	20	531000	2535.0	DFT-s-OFDM PI/2 BPSK	100@0	17.833	18.62
7	15	20	531000	2535.0	DFT-s-OFDM QPSK	100@0	17.851	18.68
7	15	20	531000	2535.0	CP-OFDM QPSK	106@0	18.922	19.8
7	15	20	531000	2535.0	CP-OFDM 16 QAM	106@0	18.921	19.8
7	15	20	531000	2535.0	CP-OFDM 64 QAM	106@0	18.946	19.79
7	15	20	531000	2535.0	CP-OFDM 256 QAM	106@0	18.88	19.71



B5_N7(5M)_DFT-s-OFDM_PI_2-
BPSK_Outer_Full_Mid_CH

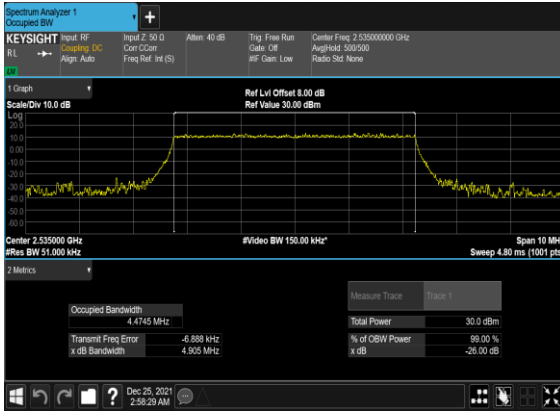

B5_N7(5M)_DFT-s-
OFDM_QPSK_Outer_Full_Mid_CH

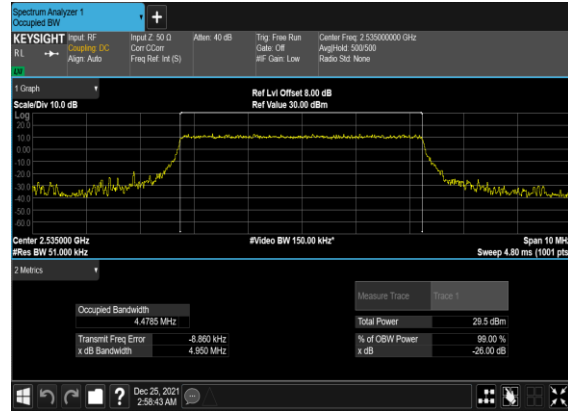

B5_N7(5M)_CP-
OFDM_QPSK_Outer_Full_Mid_CH

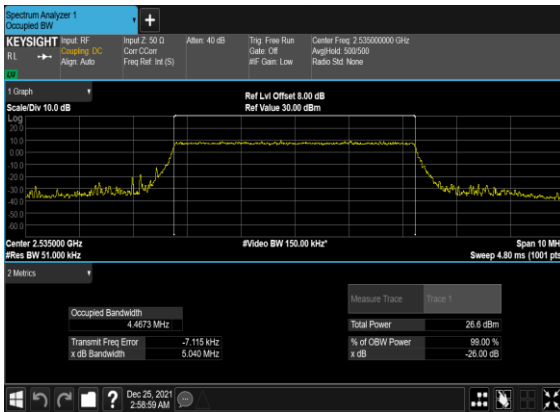

B5_N7(5M)_CP-OFDM_16
QAM_Outer_Full_Mid_CH

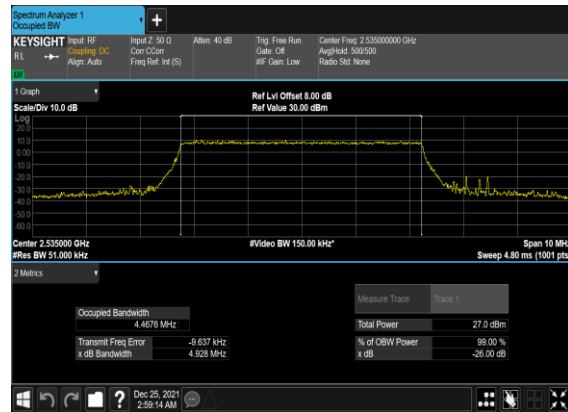



B5_N7(5M)_CP-OFDM_64 QAM_Outer_Full_Mid_CH



B5_N7(5M)_CP-OFDM_256 QAM_Outer_Full_Mid_CH

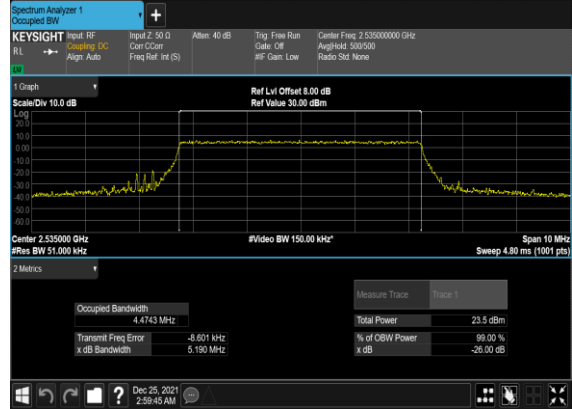

B5_N7(10M)_DFT-s-OFDM_PI_2-BPSK_Outer_Full_Mid_CH

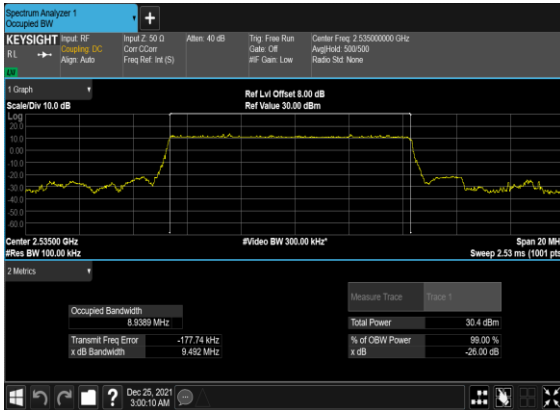

B5_N7(10M)_DFT-s-OFDM_QPSK_Outer_Full_Mid_CH





B5_N7(10M)_CP-OFDM_QPSK_Outer_Full_Mid_CH

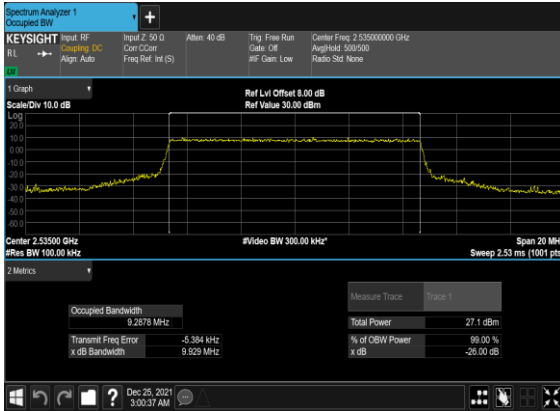

B5_N7(10M)_CP-OFDM_16QAM_Outer_Full_Mid_CH

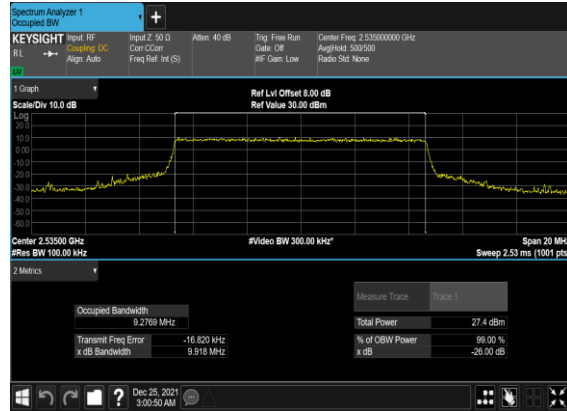

B5_N7(10M)_CP-OFDM_64QAM_Outer_Full_Mid_CH

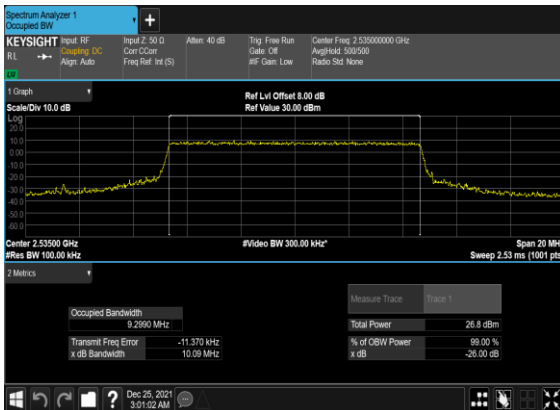

B5_N7(10M)_CP-OFDM_256QAM_Outer_Full_Mid_CH

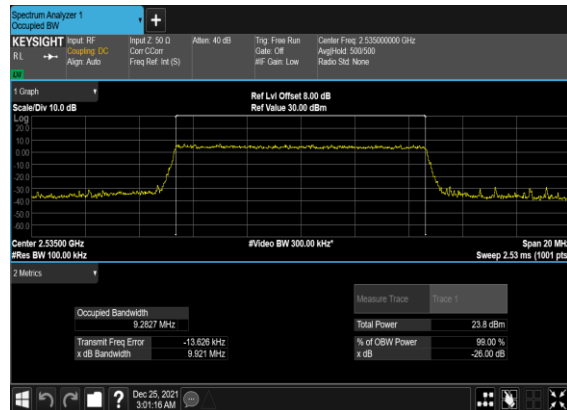



B5_N7(15M)_DFT-s-OFDM_PI_2-
BPSK_Outer_Full_Mid_CH

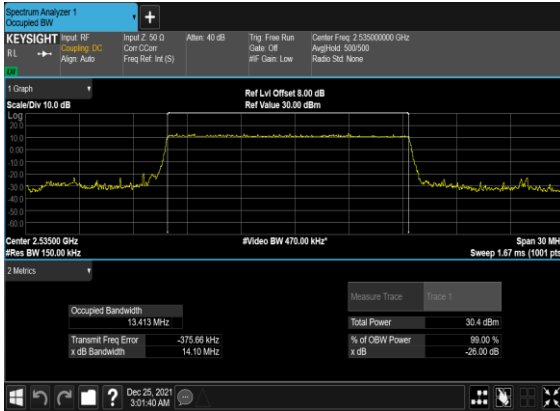

B5_N7(15M)_DFT-s-
OFDM_QPSK_Outer_Full_Mid_CH

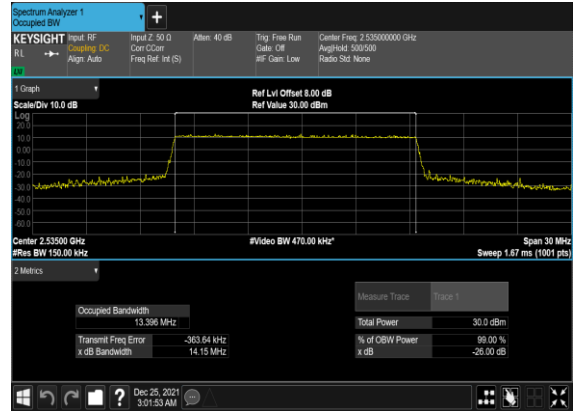

B5_N7(15M)_CP-
OFDM_QPSK_Outer_Full_Mid_CH

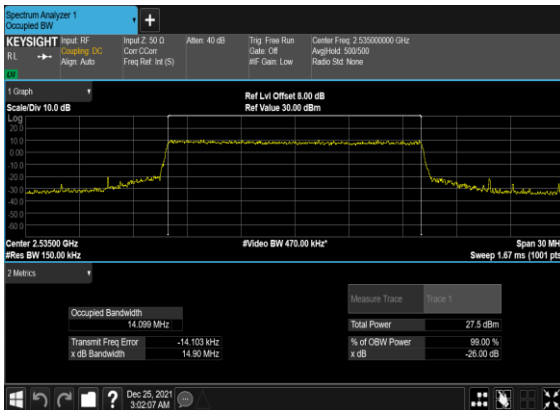

B5_N7(15M)_CP-OFDM_16
QAM_Outer_Full_Mid_CH

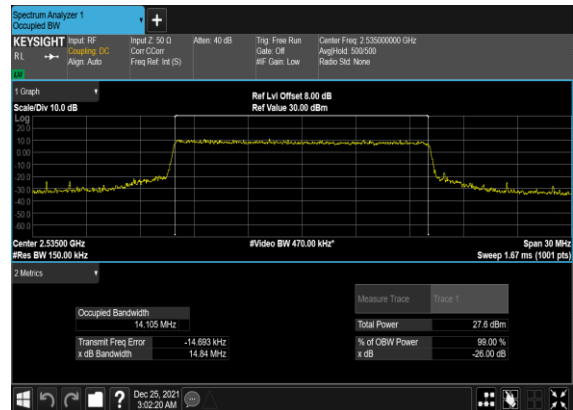



B5_N7(15M)_CP-OFDM_64
QAM_Outer_Full_Mid_CH

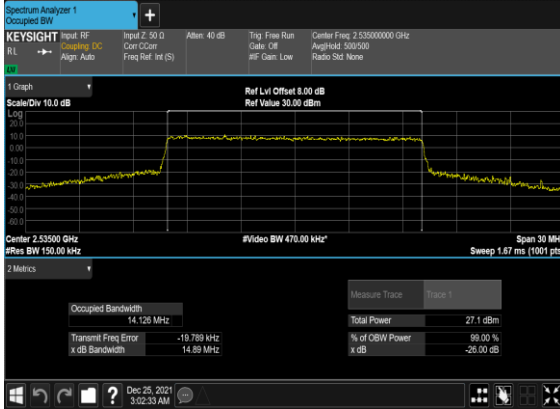

B5_N7(15M)_CP-OFDM_256
QAM_Outer_Full_Mid_CH

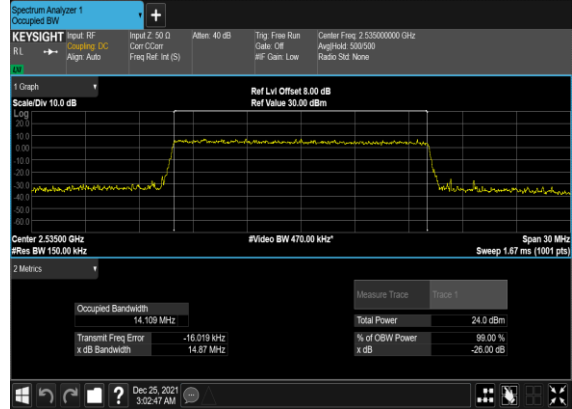

B5_N7(20M)_DFT-s-OFDM_PI_2-
BPSK_Outer_Full_Mid_CH

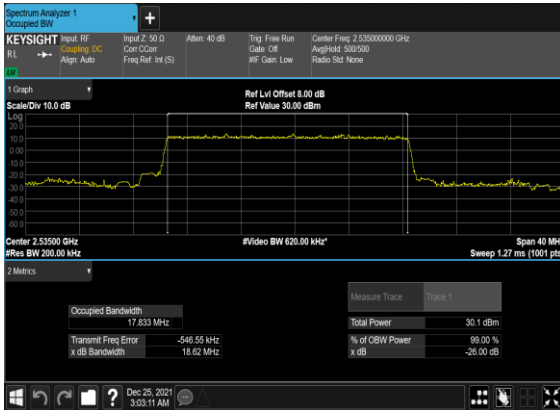

B5_N7(20M)_DFT-s-
OFDM_QPSK_Outer_Full_Mid_CH

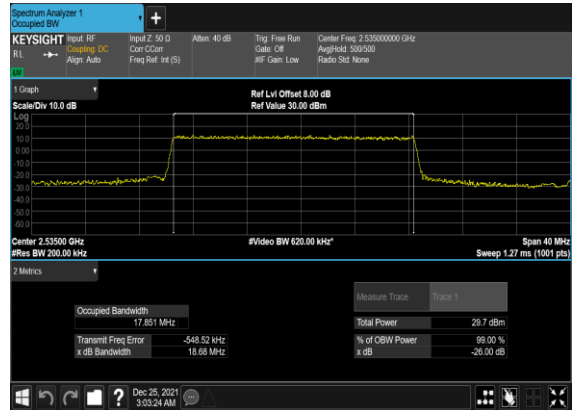



B5_N7(20M)_CP-OFDM_QPSK_Outer_Full_Mid_CH

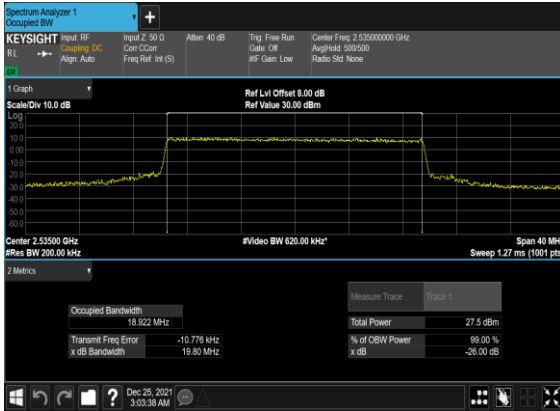

B5_N7(20M)_CP-OFDM_16QAM_Outer_Full_Mid_CH

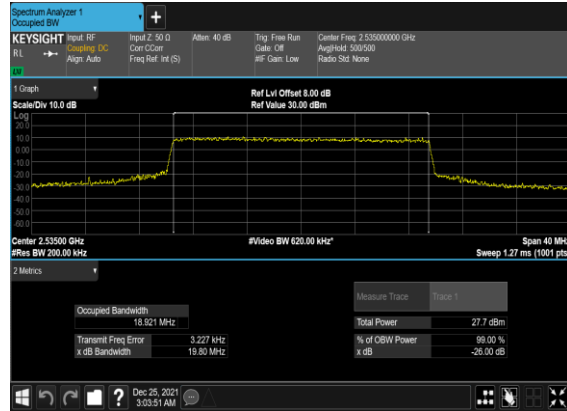

B5_N7(20M)_CP-OFDM_64QAM_Outer_Full_Mid_CH

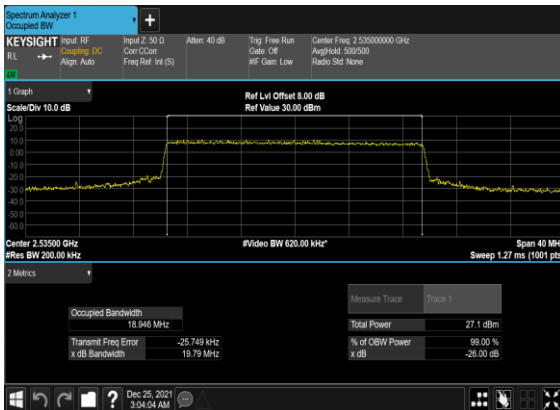

B5_N7(20M)_CP-OFDM_256QAM_Outer_Full_Mid_CH

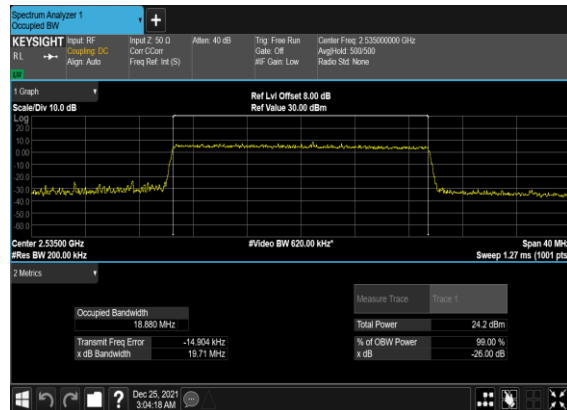



Conducted Spurious Emissions

NR Band	SCS (kHz)	Bandwidth (MHz)	Arfcn	Freq (MHz)	Modulation	RB	Result	Verdict
7	15	5	524500	2502.5	DFT-s-OFDM BPSK	1@0	see graph	---
7	15	5	524500	2502.5	DFT-s-OFDM BPSK	1@0	see graph	PASS
7	15	5	524500	2502.5	DFT-s-OFDM BPSK	1@0	see graph	PASS
7	15	5	524500	2502.5	DFT-s-OFDM QPSK	1@0	see graph	---
7	15	5	524500	2502.5	DFT-s-OFDM QPSK	1@0	see graph	PASS
7	15	5	524500	2502.5	DFT-s-OFDM QPSK	1@0	see graph	PASS
7	15	5	531000	2535.0	DFT-s-OFDM BPSK	1@0	see graph	---
7	15	5	531000	2535.0	DFT-s-OFDM BPSK	1@0	see graph	PASS
7	15	5	531000	2535.0	DFT-s-OFDM BPSK	1@0	see graph	PASS
7	15	5	531000	2535.0	DFT-s-OFDM QPSK	1@0	see graph	---
7	15	5	531000	2535.0	DFT-s-OFDM QPSK	1@0	see graph	PASS
7	15	5	531000	2535.0	DFT-s-OFDM QPSK	1@0	see graph	PASS
7	15	5	537500	2567.5	DFT-s-OFDM BPSK	1@0	see graph	---
7	15	5	537500	2567.5	DFT-s-OFDM BPSK	1@0	see graph	PASS
7	15	5	537500	2567.5	DFT-s-OFDM BPSK	1@0	see graph	PASS
7	15	5	537500	2567.5	DFT-s-OFDM QPSK	1@0	see graph	---
7	15	5	537500	2567.5	DFT-s-OFDM QPSK	1@0	see graph	PASS
7	15	5	537500	2567.5	DFT-s-OFDM QPSK	1@0	see graph	PASS
7	15	10	525000	2505.0	DFT-s-OFDM BPSK	1@0	see graph	---
7	15	10	525000	2505.0	DFT-s-OFDM BPSK	1@0	see graph	PASS
7	15	10	525000	2505.0	DFT-s-OFDM BPSK	1@0	see graph	PASS
7	15	10	525000	2505.0	DFT-s-OFDM QPSK	1@0	see graph	---
7	15	10	525000	2505.0	DFT-s-OFDM QPSK	1@0	see graph	PASS
7	15	10	525000	2505.0	DFT-s-OFDM QPSK	1@0	see graph	PASS
7	15	10	531000	2535.0	DFT-s-OFDM BPSK	1@0	see graph	---
7	15	10	531000	2535.0	DFT-s-OFDM BPSK	1@0	see graph	PASS
7	15	10	531000	2535.0	DFT-s-OFDM BPSK	1@0	see graph	PASS
7	15	10	531000	2535.0	DFT-s-OFDM QPSK	1@0	see graph	---
7	15	10	531000	2535.0	DFT-s-OFDM QPSK	1@0	see graph	PASS
7	15	10	531000	2535.0	DFT-s-OFDM QPSK	1@0	see graph	PASS



QPSK								
7	15	10	537000	2565.0	DFT-s-OFDM BPSK	1@0	see graph	---
7	15	10	537000	2565.0	DFT-s-OFDM BPSK	1@0	see graph	PASS
7	15	10	537000	2565.0	DFT-s-OFDM BPSK	1@0	see graph	PASS
7	15	10	537000	2565.0	DFT-s-OFDM QPSK	1@0	see graph	---
7	15	10	537000	2565.0	DFT-s-OFDM QPSK	1@0	see graph	PASS
7	15	10	537000	2565.0	DFT-s-OFDM QPSK	1@0	see graph	PASS
7	15	20	526000	2510.0	DFT-s-OFDM BPSK	1@0	see graph	---
7	15	20	526000	2510.0	DFT-s-OFDM BPSK	1@0	see graph	PASS
7	15	20	526000	2510.0	DFT-s-OFDM BPSK	1@0	see graph	PASS
7	15	20	526000	2510.0	DFT-s-OFDM QPSK	1@0	see graph	---
7	15	20	526000	2510.0	DFT-s-OFDM QPSK	1@0	see graph	PASS
7	15	20	526000	2510.0	DFT-s-OFDM QPSK	1@0	see graph	PASS
7	15	20	531000	2535.0	DFT-s-OFDM BPSK	1@0	see graph	---
7	15	20	531000	2535.0	DFT-s-OFDM BPSK	1@0	see graph	PASS
7	15	20	531000	2535.0	DFT-s-OFDM BPSK	1@0	see graph	PASS
7	15	20	531000	2535.0	DFT-s-OFDM QPSK	1@0	see graph	---
7	15	20	531000	2535.0	DFT-s-OFDM QPSK	1@0	see graph	PASS
7	15	20	531000	2535.0	DFT-s-OFDM QPSK	1@0	see graph	PASS
7	15	20	536000	2560.0	DFT-s-OFDM BPSK	1@0	see graph	---
7	15	20	536000	2560.0	DFT-s-OFDM BPSK	1@0	see graph	PASS
7	15	20	536000	2560.0	DFT-s-OFDM BPSK	1@0	see graph	PASS
7	15	20	536000	2560.0	DFT-s-OFDM QPSK	1@0	see graph	---
7	15	20	536000	2560.0	DFT-s-OFDM QPSK	1@0	see graph	PASS
7	15	20	536000	2560.0	DFT-s-OFDM QPSK	1@0	see graph	PASS



B5_N7(5M)_DFT-s-OFDM_BPSK_Edge_1RB_Left_Low_CH

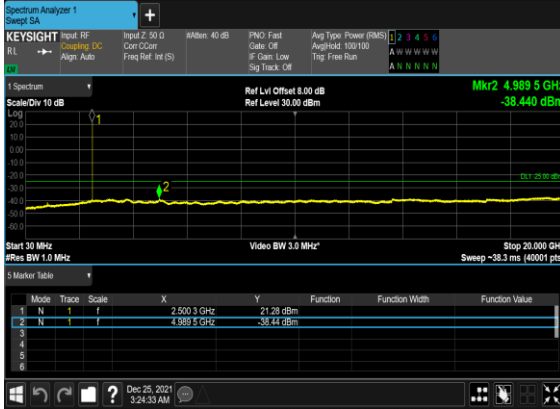

B5_N7(5M)_DFT-s-OFDM_BPSK_Edge_1RB_Left_Low_CH

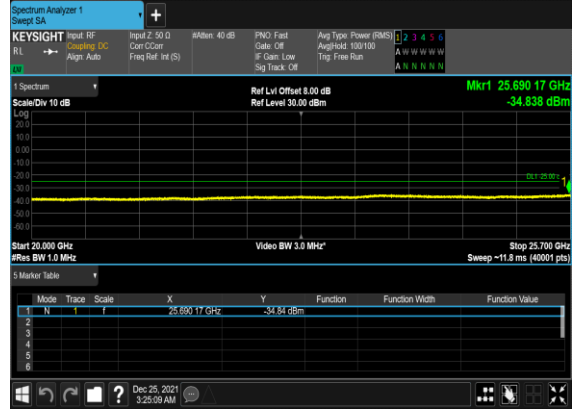

B5_N7(5M)_DFT-s-OFDM_QPSK_Edge_1RB_Left_Low_CH

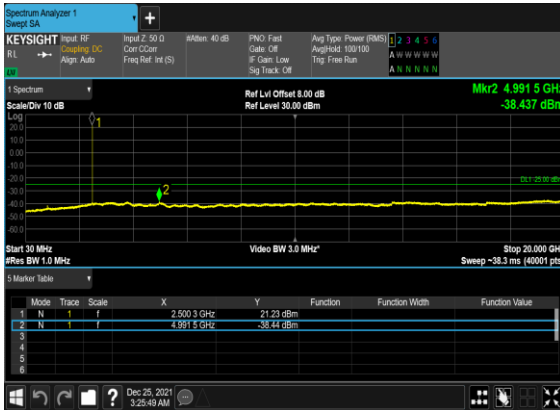

B5_N7(5M)_DFT-s-OFDM_QPSK_Edge_1RB_Left_Low_CH

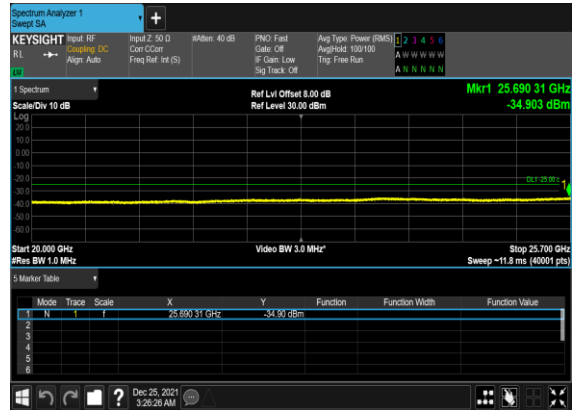



B5_N7(5M)_DFT-s-OFDM_BPSK_Edge_1RB_Left_Mid_CH



B5_N7(5M)_DFT-s-OFDM_BPSK_Edge_1RB_Left_Mid_CH

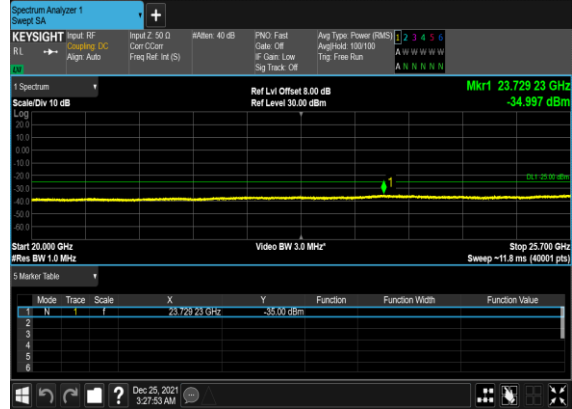

B5_N7(5M)_DFT-s-OFDM_QPSK_Edge_1RB_Left_Mid_CH

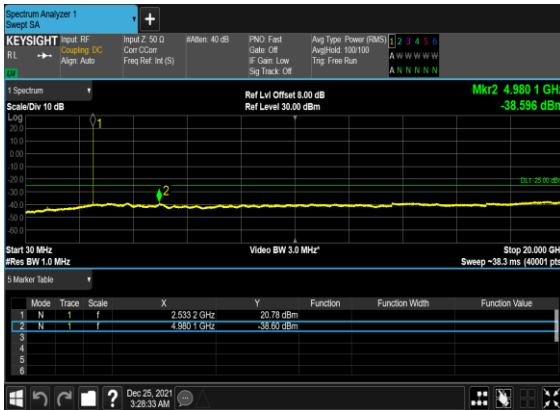

B5_N7(5M)_DFT-s-OFDM_QPSK_Edge_1RB_Left_Mid_CH

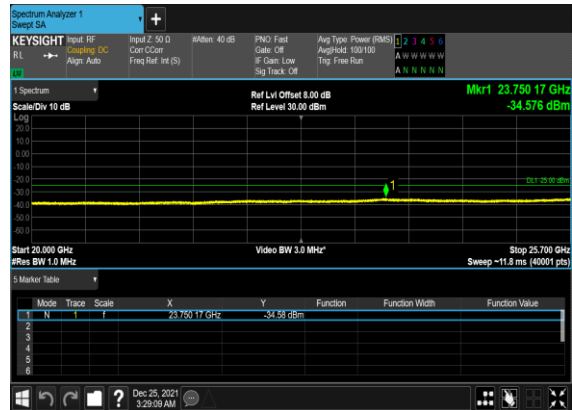



B5_N7(5M)_DFT-s-OFDM_BPSK_Edge_1RB_Left_High_CH



B5_N7(5M)_DFT-s-OFDM_BPSK_Edge_1RB_Left_High_CH

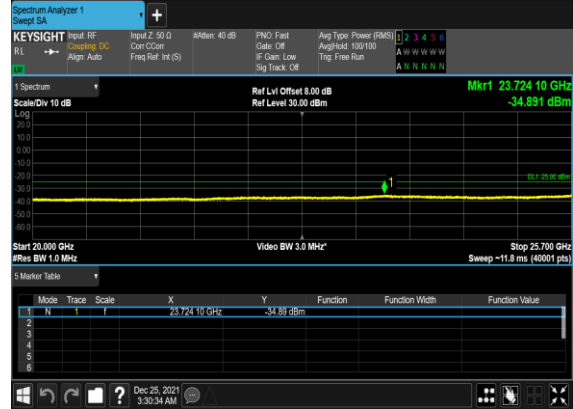

B5_N7(5M)_DFT-s-OFDM_QPSK_Edge_1RB_Left_High_CH

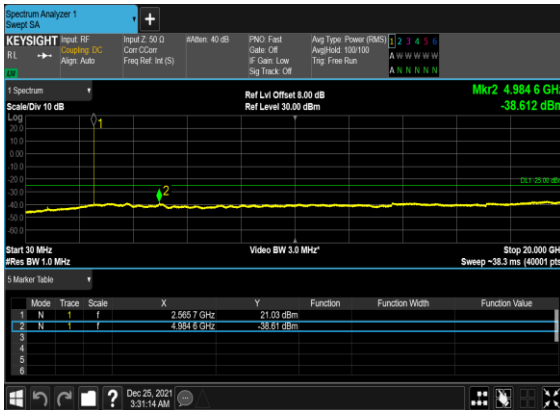

B5_N7(5M)_DFT-s-OFDM_QPSK_Edge_1RB_Left_High_CH

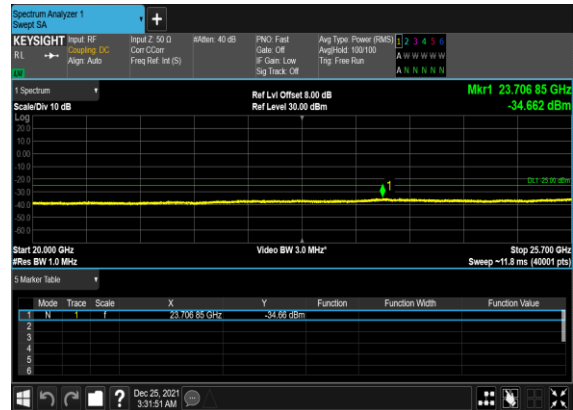



B5_N7(10M)_DFT-s-OFDM_BPSK_Edge_1RB_Left_Low_CH



B5_N7(10M)_DFT-s-OFDM_BPSK_Edge_1RB_Left_Low_CH

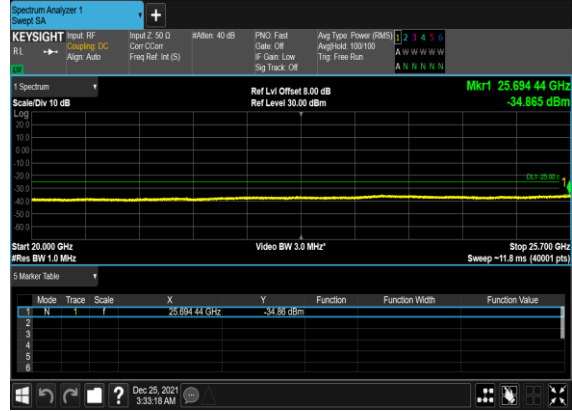

B5_N7(10M)_DFT-s-OFDM_QPSK_Edge_1RB_Left_Low_CH

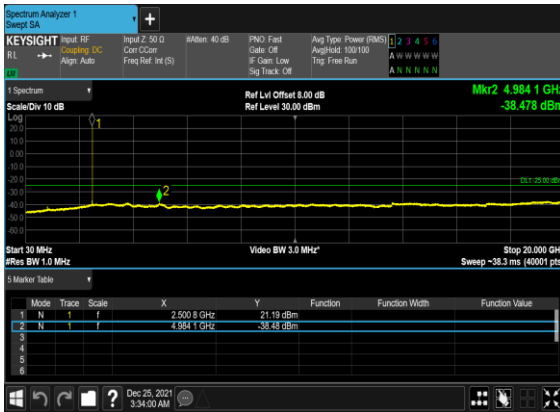

B5_N7(10M)_DFT-s-OFDM_QPSK_Edge_1RB_Left_Low_CH

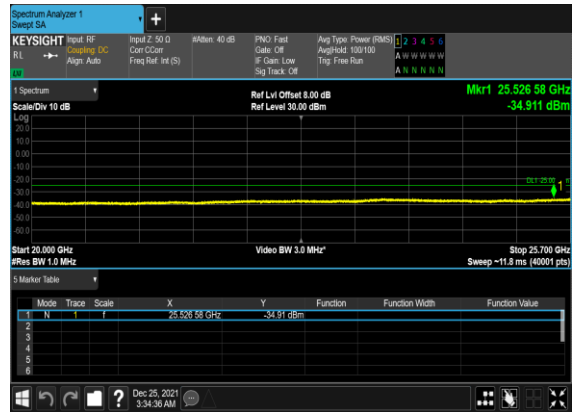



B5_N7(10M)_DFT-s-OFDM_BPSK_Edge_1RB_Left_Mid_CH



B5_N7(10M)_DFT-s-OFDM_BPSK_Edge_1RB_Left_Mid_CH

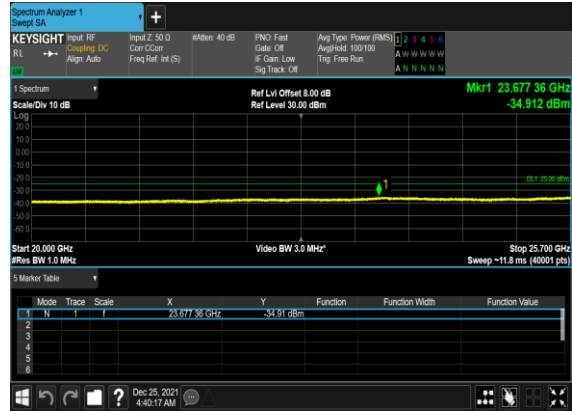

B5_N7(10M)_DFT-s-OFDM_QPSK_Edge_1RB_Left_Mid_CH

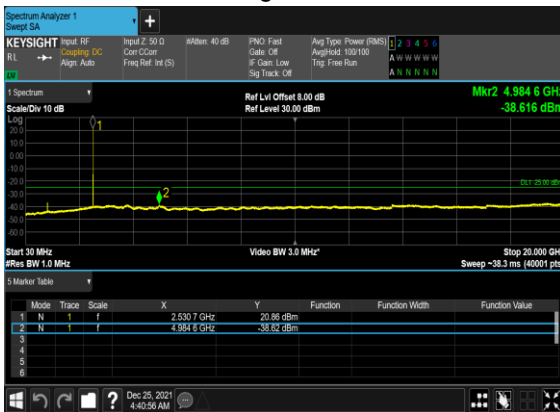

B5_N7(10M)_DFT-s-OFDM_QPSK_Edge_1RB_Left_Mid_CH

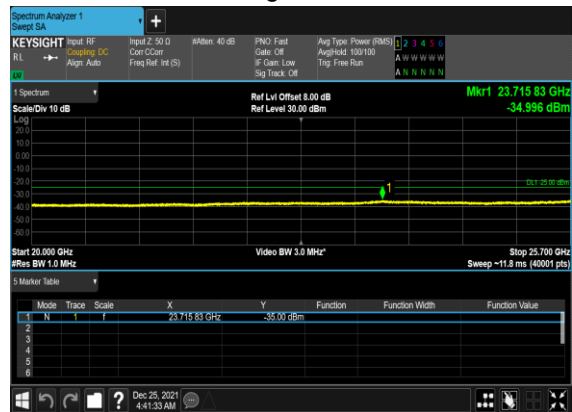



B5_N7(10M)_DFT-s-OFDM_BPSK_Edge_1RB_Left_High_CH



B5_N7(10M)_DFT-s-OFDM_BPSK_Edge_1RB_Left_High_CH



B5_N7(10M)_DFT-s-OFDM_QPSK_Edge_1RB_Left_High_CH

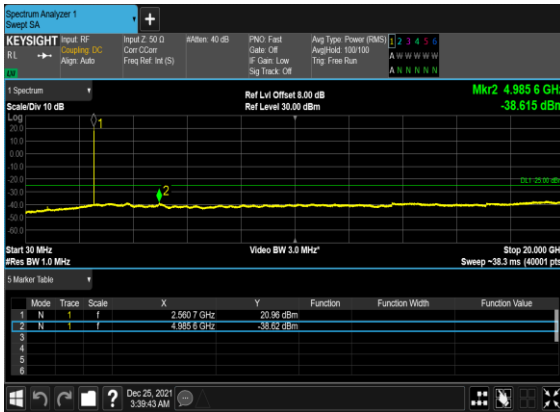

B5_N7(10M)_DFT-s-OFDM_QPSK_Edge_1RB_Left_High_CH

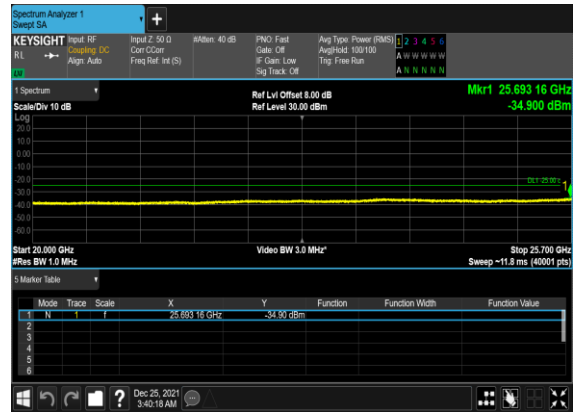



B5_N7(20M)_DFT-s-OFDM_BPSK_Edge_1RB_Left_Low_CH

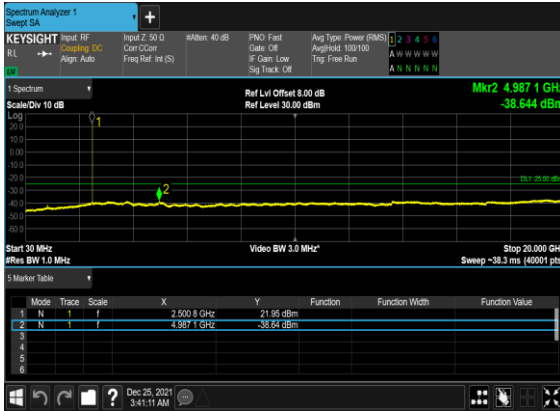

B5_N7(20M)_DFT-s-OFDM_BPSK_Edge_1RB_Left_Low_CH

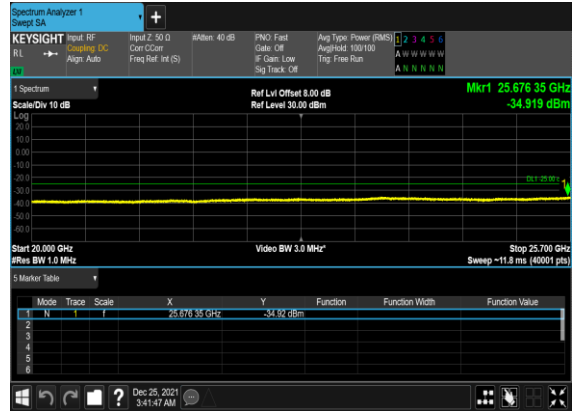

B5_N7(20M)_DFT-s-OFDM_QPSK_Edge_1RB_Left_Low_CH

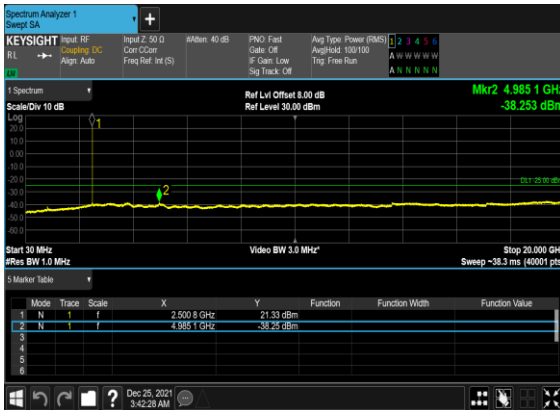

B5_N7(20M)_DFT-s-OFDM_QPSK_Edge_1RB_Left_Low_CH

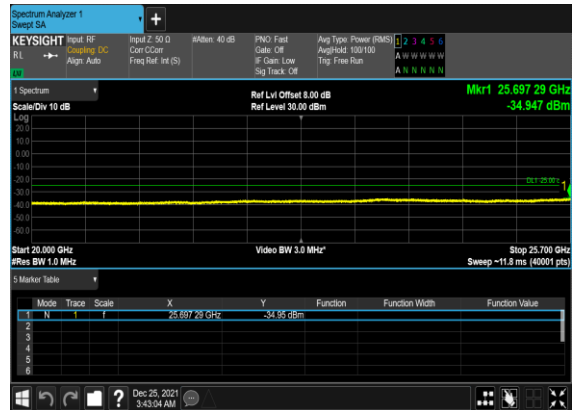



B5_N7(20M)_DFT-s-OFDM_BPSK_Edge_1RB_Left_Mid_CH

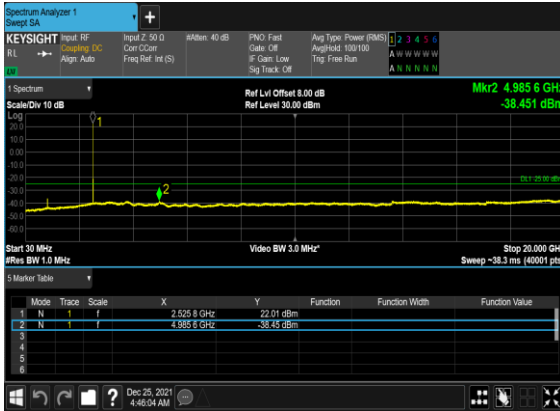

B5_N7(20M)_DFT-s-OFDM_BPSK_Edge_1RB_Left_Mid_CH

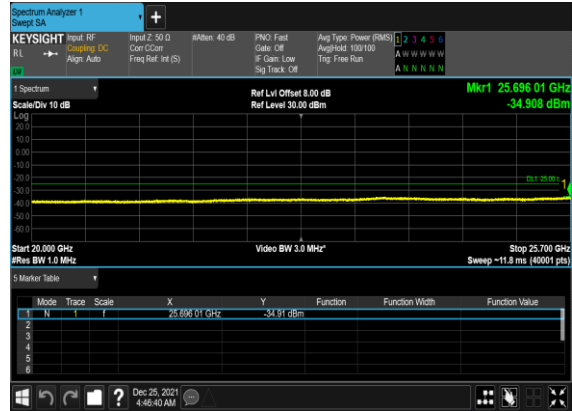

B5_N7(20M)_DFT-s-OFDM_QPSK_Edge_1RB_Left_Mid_CH

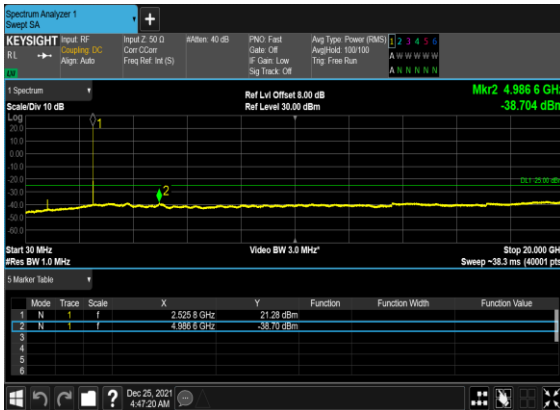

B5_N7(20M)_DFT-s-OFDM_QPSK_Edge_1RB_Left_Mid_CH

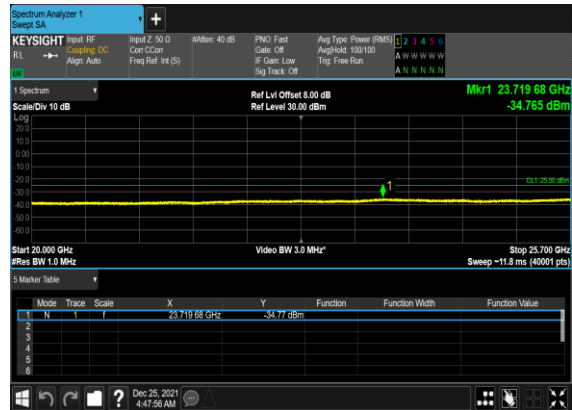



B5_N7(20M)_DFT-s-OFDM_BPSK_Edge_1RB_Left_High_CH



B5_N7(20M)_DFT-s-OFDM_BPSK_Edge_1RB_Left_High_CH

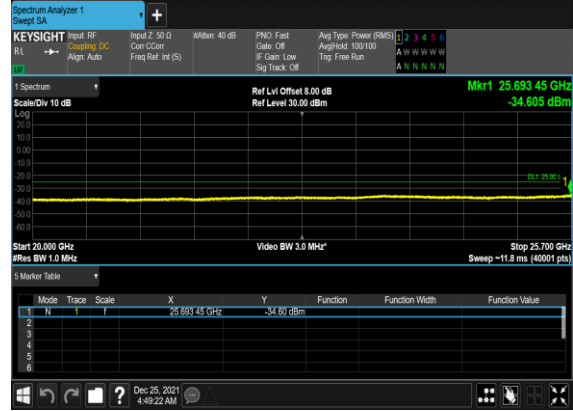

B5_N7(20M)_DFT-s-OFDM_QPSK_Edge_1RB_Left_High_CH

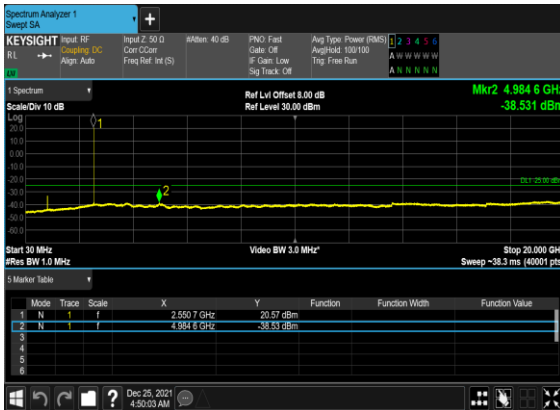

B5_N7(20M)_DFT-s-OFDM_QPSK_Edge_1RB_Left_High_CH

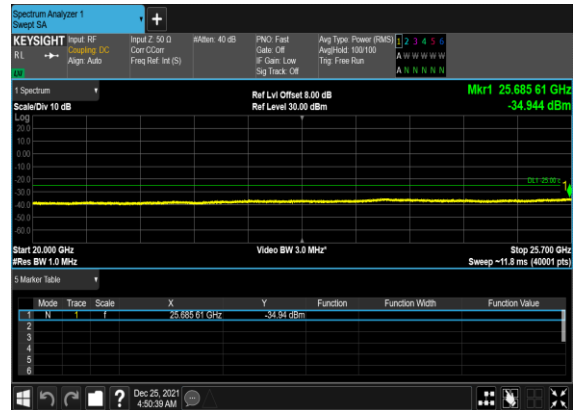



Conducted Band Edge

NR Band	SCS (kHz)	Bandwidth (MHz)	Arfcn	Freq (MHz)	Modulation	RB	Result	Verdict
7	15	5	524500	2502.5	DFT-s-OFDM BPSK	1@0	see graph	PASS
7	15	5	524500	2502.5	DFT-s-OFDM QPSK	1@0	see graph	PASS
7	15	5	524500	2502.5	DFT-s-OFDM BPSK	25@0	see graph	PASS
7	15	5	524500	2502.5	DFT-s-OFDM QPSK	25@0	see graph	PASS
7	15	5	537500	2567.5	DFT-s-OFDM BPSK	1@24	see graph	PASS
7	15	5	537500	2567.5	DFT-s-OFDM QPSK	1@24	see graph	PASS
7	15	5	537500	2567.5	DFT-s-OFDM BPSK	25@0	see graph	PASS
7	15	5	537500	2567.5	DFT-s-OFDM QPSK	25@0	see graph	PASS
7	15	10	525000	2505.0	DFT-s-OFDM BPSK	1@0	see graph	PASS
7	15	10	525000	2505.0	DFT-s-OFDM QPSK	1@0	see graph	PASS
7	15	10	525000	2505.0	DFT-s-OFDM BPSK	50@0	see graph	PASS
7	15	10	525000	2505.0	DFT-s-OFDM QPSK	50@0	see graph	PASS
7	15	10	537000	2565.0	DFT-s-OFDM BPSK	1@51	see graph	PASS
7	15	10	537000	2565.0	DFT-s-OFDM QPSK	1@51	see graph	PASS
7	15	10	537000	2565.0	DFT-s-OFDM BPSK	50@0	see graph	PASS
7	15	10	537000	2565.0	DFT-s-OFDM QPSK	50@0	see graph	PASS
7	15	20	526000	2510.0	DFT-s-OFDM BPSK	1@0	see graph	PASS
7	15	20	526000	2510.0	DFT-s-OFDM QPSK	1@0	see graph	PASS
7	15	20	526000	2510.0	DFT-s-OFDM BPSK	100@0	see graph	PASS
7	15	20	526000	2510.0	DFT-s-OFDM QPSK	100@0	see graph	PASS
7	15	20	536000	2560.0	DFT-s-OFDM BPSK	1@105	see graph	PASS
7	15	20	536000	2560.0	DFT-s-OFDM QPSK	1@105	see graph	PASS
7	15	20	536000	2560.0	DFT-s-OFDM BPSK	100@0	see graph	PASS
7	15	20	536000	2560.0	DFT-s-OFDM QPSK	100@0	see graph	PASS



B5_N7(5M)_DFT-s-OFDM_BPSK_Edge_1RB_Left_Low_CH



B5_N7(5M)_DFT-s-OFDM_QPSK_Edge_1RB_Left_Low_CH



B5_N7(5M)_DFT-s-OFDM_BPSK_Outer_Full_Low_CH

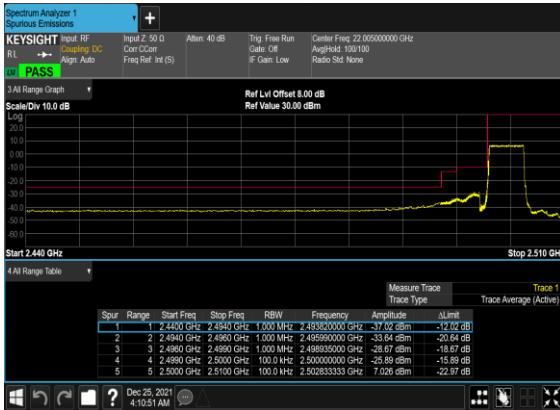

B5_N7(5M)_DFT-s-OFDM_QPSK_Outer_Full_Low_CH

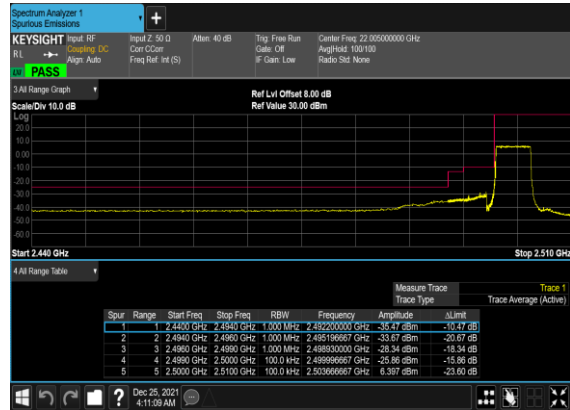



B5_N7(5M)_DFT-s-OFDM_BPSK_Edge_1RB_Right_High_CH

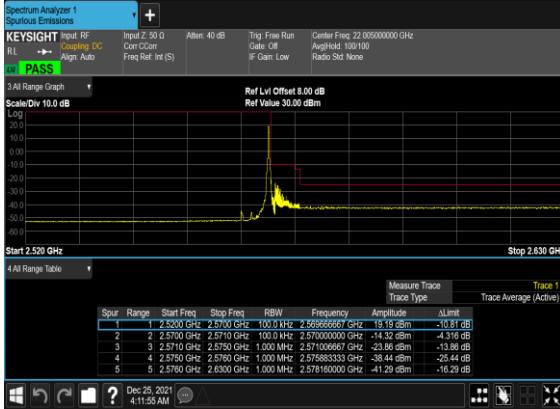

B5_N7(5M)_DFT-s-OFDM_QPSK_Edge_1RB_Right_High_CH

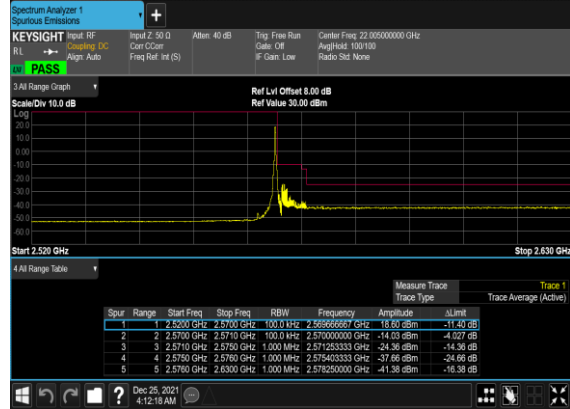

B5_N7(5M)_DFT-s-OFDM_BPSK_Outer_Full_High_CH

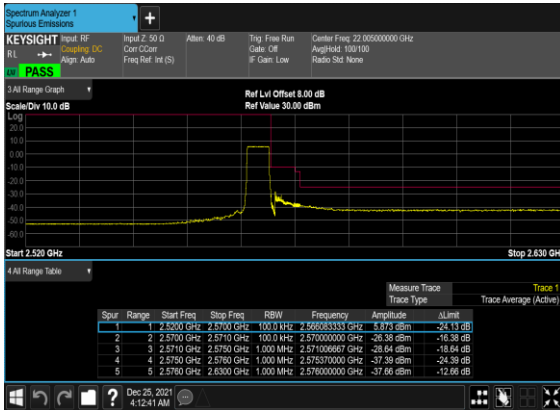

B5_N7(5M)_DFT-s-OFDM_QPSK_Outer_Full_High_CH

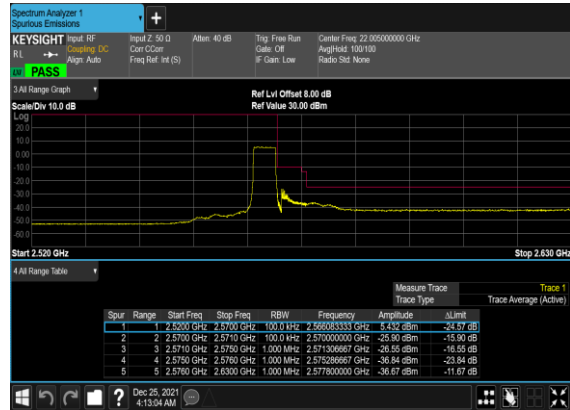



B5_N7(10M)_DFT-s-OFDM_BPSK_Edge_1RB_Left_Low_CH

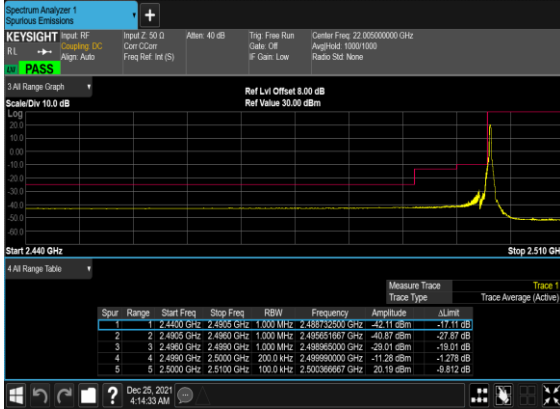

B5_N7(10M)_DFT-s-OFDM_QPSK_Edge_1RB_Left_Low_CH

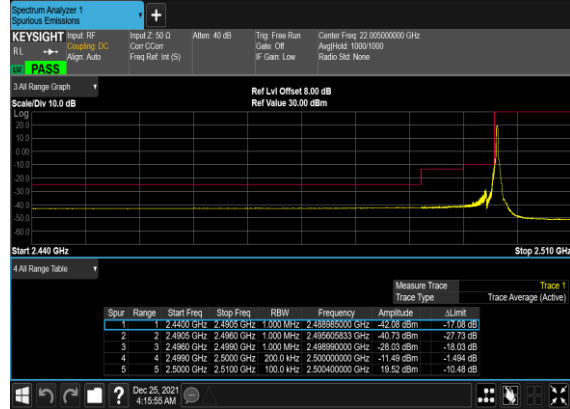

B5_N7(10M)_DFT-s-OFDM_BPSK_Outer_Full_Low_CH

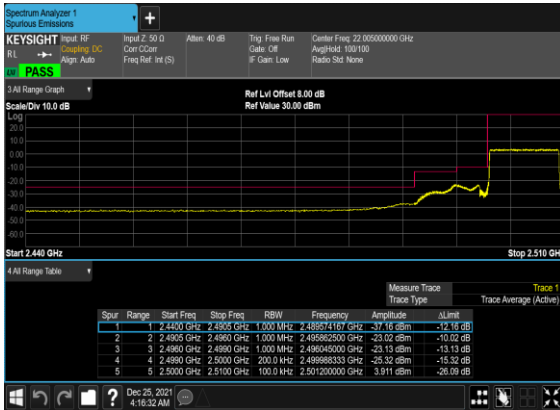

B5_N7(10M)_DFT-s-OFDM_QPSK_Outer_Full_Low_CH

