

## FCC Test Report

### (PART 90)

**Report No.:** RFBASM-WTW-P20120917-8

**FCC ID:** QYLEM7511K

**Test Model:** EM7511

**Received Date:** Dec. 29, 2020

**Test Date:** Jan. 22 ~ Jan. 26, 2021

**Issued Date:** Jun. 09, 2021

**Applicant:** Getac Technology Corporation.

**Address:** 5F., Building A, No. 209, Sec.1, Nangang Rd., Nangang Dist., Taipei City  
11568, Taiwan, R.O.C.

**Issued By:** Bureau Veritas Consumer Products Services (H.K.) Ltd., Taoyuan Branch  
Lin Kou Laboratories

**Lab Address:** No. 47-2, 14th Ling, Chia Pau Vil., Lin Kou Dist., New Taipei City, Taiwan

**Test Location (1):** No.19, Hwa Ya 2nd Rd., Wen Hwa Vil., Kwei Shan Dist., Taoyuan City  
33383, Taiwan

**Test Location (2):** B2F., No.215, Sec. 3, Beixin Rd., Xindian Dist., New Taipei City 231,  
Taiwan

**FCC Registration /** 788550 / TW0003

**Designation Number:** 427177 / TW0011



This report is for your exclusive use. Any copying or replication of this report to or for any other person or entity, or use of our name or trademark, is permitted only with our prior written permission. This report sets forth our findings solely with respect to the test samples identified herein. The results set forth in this report are not indicative or representative of the quality or characteristics of the lot from which a test sample was taken or any similar or identical product unless specifically and expressly noted. Our report includes all of the tests requested by you and the results thereof based upon the information that you provided to us. You have 60 days from date of issuance of this report to notify us of any material error or omission caused by our negligence, provided, however, that such notice shall be in writing and shall specifically address the issue you wish to raise. A failure to raise such issue within the prescribed time shall constitute your unqualified acceptance of the completeness of this report, the tests conducted and the correctness of the report contents. Unless specific mention, the uncertainty of measurement has been explicitly taken into account to declare the compliance or non-compliance to the specification.

## Table of Contents

<b>Release Control Record .....</b>	<b>3</b>
<b>1 Certificate of Conformity .....</b>	<b>4</b>
<b>2 Summary of Test Results.....</b>	<b>5</b>
2.1 Measurement Uncertainty.....	6
2.2 Test Site and Instruments .....	7
<b>3 General Information .....</b>	<b>8</b>
3.1 General Description of EUT .....	8
3.2 Configuration of System under Test.....	10
3.2.1 Description of Support Units .....	10
3.3 Test Mode Applicability and Tested Channel Detail .....	11
3.4 EUT Operating Conditions .....	12
3.5 General Description of Applied Standards.....	12
<b>4 Test Types and Results .....</b>	<b>13</b>
4.1 Output Power Measurement.....	13
4.1.1 Limits of Output Power Measurement .....	13
4.1.2 Test Procedures.....	13
4.1.3 Test Setup.....	14
4.1.4 Test Results .....	15
4.2 Radiated Emission Measurement.....	19
4.2.1 Limits of Radiated Emission Measurement .....	19
4.2.2 Test Procedure .....	19
4.2.3 Deviation from Test Standard .....	19
4.2.4 Test Setup.....	20
4.2.5 Test Results .....	21
<b>5 Pictures of Test Arrangements.....</b>	<b>43</b>
<b>Appendix – Information of the Testing Laboratories .....</b>	<b>44</b>

### Release Control Record

Issue No.	Description	Date Issued
RFBASM-WTW-P20120917-8	Original Release	Jun. 09, 2021

## 1 Certificate of Conformity

**Product:** Wireless Modules

**Brand:** Sierra Wireless, Inc.

**Test Model:** EM7511

**Sample Status:** Mass product

**Applicant:** Getac Technology Corporation.

**Test Date:** Jan. 22 ~ Jan. 26, 2021

**Standards:** FCC Part 90, Subpart I, S, R  
FCC Part 2

The above equipment has been tested by **Bureau Veritas Consumer Products Services (H.K.) Ltd., Taoyuan Branch**, and found compliance with the requirement of the above standards. The test record, data evaluation & Equipment Under Test (EUT) configurations represented herein are true and accurate accounts of the measurements of the sample's RF characteristics under the conditions specified in this report.

**Prepared by :** Gina Liu, **Date:** Jun. 09, 2021  
Gina Liu / Specialist

**Approved by :** Dylan Chiou, **Date:** Jun. 09, 2021  
Dylan Chiou / Project Engineer

## 2 Summary of Test Results

Applied Standard: FCC Part 90 & Part 2 (LTE 14)			
FCC Clause	Test Item	Result	Remarks
2.1046 90.542 (a)(7)	Effective Radiated Power	Pass	Meet the requirement of limit.
2.1047	Modulation Characteristics	N/A	Refer to Note
2.1055 90.539 (e)	Frequency Stability	N/A	Refer to Note
2.1049	Occupied Bandwidth	N/A	Refer to Note
90.210 (n)	Emission Masks	N/A	Refer to Note
2.1053 90.543 (e)(2)(3)	Band Edge Measurements	N/A	Refer to Note
2.1051 90.543 (e)(3)	Conducted Spurious Emissions	N/A	Refer to Note
2.1053 90.543 (e)(3) & (f)	Radiated Spurious Emissions	Pass	Meet the requirement of limit. Minimum passing margin is -11.42 dB at 1586.00 MHz.

Applied Standard: FCC Part 90 & Part 2 (LTE 26)			
FCC Clause	Test Item	Result	Remarks
2.1046 90.635 (b)	Effective Radiated Power	Pass	Meet the requirement of limit.
2.1047	Modulation Characteristics	N/A	Refer to Note
2.1055 90.213	Frequency Stability	N/A	Refer to Note
2.1049 90.209	Occupied Bandwidth	N/A	Refer to Note
2.1051 90.210	Emission Masks	N/A	Refer to Note
2.1051 90.691	Conducted Spurious Emissions	N/A	Refer to Note
2.1053 90.691	Radiated Spurious Emissions	Pass	Meet the requirement of limit. Minimum passing margin is -34.03 dB at 2457.00 MHz.

Note:

1. This report is a partial report, only test item of Effective Radiated Power & Radiated Emissions were performed for this report. Other testing data please refer to TTL report no.: FG830505, FG791919D for module (Brand: Sierra, Model: EM7511).
2. Determining compliance based on the results of the compliance measurement, not taking into account measurement instrumentation uncertainty.

## 2.1 Measurement Uncertainty

Where relevant, the following measurement uncertainty levels have been estimated for tests performed on the EUT as specified in CISPR 16-4-2:

Measurement	Frequency	Expanded Uncertainty (k=2) ( $\pm$ )
Radiated Emissions up to 1 GHz	9 kHz ~ 30 MHz	3.0400 dB
	30 MHz ~ 200 MHz	2.0153 dB
	200 MHz ~ 1000 MHz	2.0224 dB
Radiated Emissions above 1 GHz	1 GHz ~ 18 GHz	1.0121 dB
	18 GHz ~ 40 GHz	1.1508 dB

## 2.2 Test Site and Instruments

Description & Manufacturer	Model No.	Serial No.	Date of Calibration	Due Date of Calibration
Test Receiver Agilent Technologies	N9038A	MY52260177	Aug. 24, 2020	Aug. 23, 2021
Spectrum Analyzer ROHDE & SCHWARZ	FSU43	101261	Apr. 16, 2020	Apr. 15, 2021
HORN Antenna ETS-Lindgren	3117	00143293	Nov. 22, 2020	Nov. 21, 2021
BILOG Antenna SCHWARZBECK	VULB 9168	9168-616	Nov. 09, 2020	Nov. 08, 2021
HORN Antenna SCHWARZBECK	BBHA 9170	9170-480	Nov. 22, 2020	Nov. 21, 2021
Fixed Attenuator Mini-Circuits	MDCS18N-10	MDCS18N-10-01	Apr. 14, 2020	Apr. 13, 2021
MXG Vector signal generator Agilent	N5182B	MY53050430	Nov. 25, 2020	Nov. 24, 2021
Preamplifier Agilent	310N	187226	Jun. 17, 2020	Jun. 16, 2021
Preamplifier Agilent	83017A	MY39501357	Jun. 17, 2020	Jun. 16, 2021
Preamplifier EMCI	EMC 184045	980116	Oct. 07, 2020	Oct. 06, 2021
RF signal cable ETS-LINDGREN	5D-FB	Cable-CH1-01(RFC-SMS-100-SMS-120+RFC-SMS-100-SMS-400)	Jun. 17, 2020	Jun. 16, 2021
RF signal cable ETS-LINDGREN	8D-FB	Cable-CH1-02(RFC-SMS-100-SMS-24)	Jun. 17, 2020	Jun. 17, 2021
Boresight Antenna Fixture	FBA-01	FBA-SIP01	NA	NA
Software BV ADT	E3 8.130425b	NA	NA	NA
Antenna Tower MF	NA	NA	NA	NA
Turn Table MF	NA	NA	NA	NA
Antenna Tower & Turn Table Controller MF	MF-7802	NA	NA	NA
Radio Communication Analyzer Anritsu	MT8820C	6201010284	Dec. 28, 2020	Dec. 27, 2021

- Note: 1. The calibration interval of the above test instruments is 12 months and the calibrations are traceable to NML/ROC and NIST/USA.  
 2. The test was performed in HsinTien Chamber 1.  
 3. The horn antenna and preamplifier (model: 83017A) are used only for the measurement of emission frequency above 1 GHz if tested.

### 3 General Information

#### 3.1 General Description of EUT

<b>Product</b>	Wireless Modules	
<b>Brand</b>	Sierra Wireless, Inc.	
<b>Test Model</b>	EM7511	
<b>Status of EUT</b>	Mass product	
<b>Power Supply Rating</b>	19 Vdc (adapter) 11.1 Vdc (battery)	
<b>Modulation Type</b>	LTE	QPSK, 16QAM, 64QAM
<b>Frequency Range</b>	LTE Band 14 (Channel Bandwidth: 5 MHz)	790.5 ~ 795.5 MHz
	LTE Band 14 (Channel Bandwidth: 10 MHz)	793 MHz
	LTE Band 26 (Channel Bandwidth: 1.4 MHz)	814.7 ~ 823.3 MHz
	LTE Band 26 (Channel Bandwidth: 3 MHz)	815.5 ~ 822.5 MHz
	LTE Band 26 (Channel Bandwidth: 5 MHz)	816.5 ~ 821.5 MHz
	LTE Band 26 (Channel Bandwidth: 10 MHz)	819 MHz
<b>Max. ERP Power</b>	LTE Band 14 (Channel Bandwidth: 5 MHz)	143.02 mW
	LTE Band 14 (Channel Bandwidth: 10 MHz)	144.78 mW
	LTE Band 26 (Channel Bandwidth: 1.4 MHz)	173.38 mW
	LTE Band 26 (Channel Bandwidth: 3 MHz)	172.19 mW
	LTE Band 26 (Channel Bandwidth: 5 MHz)	178.32 mW
	LTE Band 26 (Channel Bandwidth: 10 MHz)	174.58 mW
<b>Antenna Type</b>	LTE Band 14: PIFA Antenna with 0.59 dBi gain LTE Band 26: PIFA Antenna with 1.08 dBi gain	
<b>Accessory Device</b>	Refer to Note as below	
<b>Data Cable Supplied</b>	Refer to Note as below	

Note:

1. The EUT is authorized for use in specific End-product. Please refer to below for more details.

Product	Brand	Model	Description
Tablet	Getac	K120	For marketing purpose
		K120G2	
		K120Y (Y= 10 characters, Y can be 0-9, a-z, A-Z, "-", "_", or blank for marketing purpose and no impact safety related critical components and constructions)	



2. The End-product contains following accessory devices.

Product	Brand	Model	Description
Adapter	Chicony	A15-090P1A	INPUT: 100-240Vac, 1.2A max, 50-60Hz OUTPUT: 19.0Vdc, 4.74A, 90W
Battery	Getac	BP3S1P2100S-01	Rating: 11.1Vdc 2040mAh, 23Wh Typical Capacity: 2100mAh, 24Wh
Earphone	N/A	N/A	--
USB Cable	N/A	N/A	--
LCD Panel	Innolux	N125HCE-HN1	FHD
Camera	Foxlink	FN20FF-679H	FHD
	Foxlink	FN80AF-443H-2	8M
	FOXLINK	FO20FF-790H	FHD
WiFi & BT Module	Intel	AX201NGW	--
WWAN Module	Sierra	EM7511	--

3. The above Antenna information is declared by manufacturer and for more detailed features description, please refer to the manufacturer's specifications, the laboratory shall not be held responsible.
4. The above EUT information is declared by manufacturer and for more detailed features description, please refers to the manufacturer's specifications or user's manual.

### 3.2 Configuration of System under Test

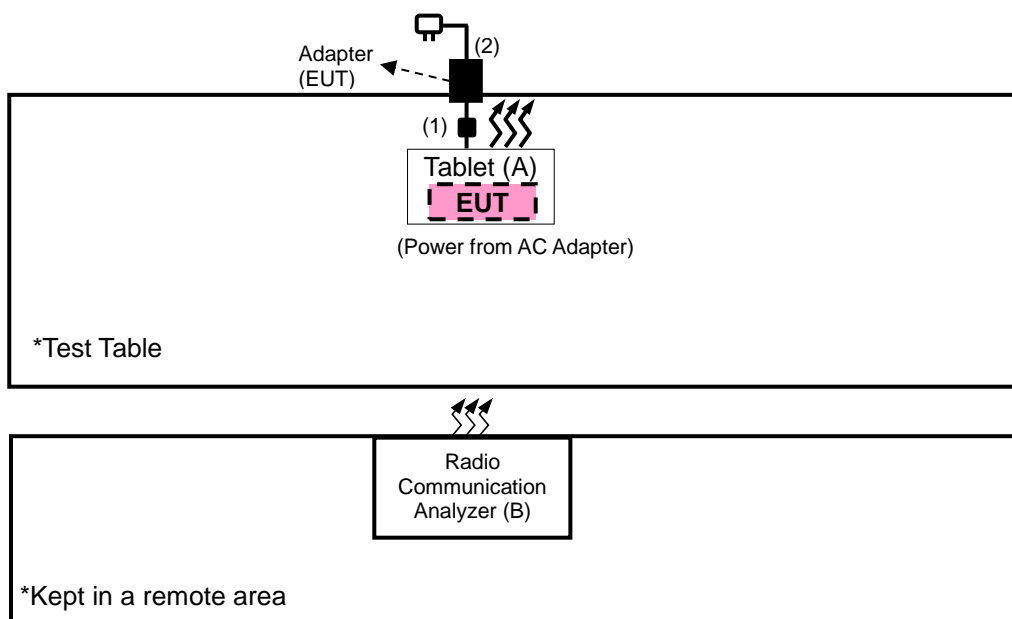

#### 3.2.1 Description of Support Units

The EUT has been tested as an independent unit together with other necessary accessories or support units. The following support units or accessories were used to form a representative test configuration during the tests.

ID	Product	Brand	Model No.	Serial No.	FCC ID	Remarks
A.	Tablet	K120	N/A	N/A	N/A	Provided by Client
B.	Radio Communication Analyzer	Anritsu	MT8820C	6201010284	N/A	-

ID	Cable Descriptions	Qty.	Length (m)	Shielding (Yes/No)	Cores (Qty.)	Remarks
1.	DC Cable	1	1.5	N	1	Accessory of the EUT
2.	AC Power Cable	1	1.7	N	0	Accessory of the EUT

Note:

1. All power cords of the above support units are non-shielded (1.8m).
2. Item B acted as communication partner to transfer data.

### 3.3 Test Mode Applicability and Tested Channel Detail

Pre-Scan has been conducted to determine the worst-case mode from all possible combinations between available modulations, data rates, XYZ axis, and antenna ports

The worst case was found when positioned as the table below. Following channel(s) was (were) selected for the final test as listed below:

Band	ERP	Radiated Emission
LTE Band 14	X-plane	Z-axis
LTE Band 26	Z-plane	X-axis

#### LTE Band 14

EUT Configure Mode	Test Item	Available Channel	Tested Channel	Channel Bandwidth	Modulation	Mode
-	ERP	23305 to 23355	23305, 23330, 23355	5 MHz	QPSK, 16QAM, 64QAM	1 RB / 0 RB Offset
		23330	23330	10 MHz	QPSK, 16QAM, 64QAM	1 RB / 0 RB Offset
-	Radiated Emission	23305 to 23355	23305, 23330, 23355	5 MHz	QPSK	1 RB / 0 RB Offset
		23330	23330	10 MHz	QPSK	1 RB / 0 RB Offset

#### Note:

1. This device was tested under all bandwidths, RB configurations and modulations. The worst case was found in QPSK modulation.
2. For radiated emission above 1 GHz, according to 3GPP 36.521 Section 6.6.3.1.4, choose the lowest, 5 MHz & highest channel bandwidth for final test.
3. For radiated emissions below 1 GHz, select the worst radiated emission channel for final testing.

#### LTE Band 26

EUT Configure Mode	Test Item	Available Channel	Tested Channel	Channel Bandwidth	Modulation	Mode
-	ERP	26697 to 26783	26697, 26740, 26783	1.4 MHz	QPSK, 16QAM, 64QAM	1 RB / 0 RB Offset
		26705 to 26775	26705, 26740, 26775	3 MHz	QPSK, 16QAM, 64QAM	1 RB / 0 RB Offset
		26715 to 26765	26715, 26740, 26765	5 MHz	QPSK, 16QAM, 64QAM	1 RB / 0 RB Offset
		26740	26740	10 MHz	QPSK, 16QAM, 64QAM	1 RB / 0 RB Offset
-	Radiated Emission	26697 to 26783	26697, 26740, 26783	1.4 MHz	QPSK	1 RB / 0 RB Offset
		26715 to 26765	26715, 26740, 26765	5 MHz	QPSK	1 RB / 0 RB Offset
		26740	26740	10 MHz	QPSK	1 RB / 0 RB Offset

#### Note:

1. This device was tested under all bandwidths, RB configurations and modulations. The worst case was found in QPSK modulation.
2. For radiated emission above 1 GHz, according to 3GPP 36.521 Section 6.6.3.1.4, choose the lowest, 5 MHz & highest channel bandwidth for final test.
3. For radiated emissions below 1 GHz, select the worst radiated emission channel for final testing.

**Test Condition:**

Test Item	Environmental Conditions	Input Power	Tested By
ERP	25 deg. C, 65 % RH	120 Vac, 60 Hz	Charles Hsiao
Radiated Emission	25 deg. C, 65 % RH	120 Vac, 60 Hz	Charles Hsiao

**3.4 EUT Operating Conditions**

The EUT makes a call to the communication simulator. The communication simulator station system controlled a EUT to export maximum output power under transmission mode and specific channel frequency

**3.5 General Description of Applied Standards**

The EUT is a RF Product. According to the specifications of the manufacturer, it must comply with the requirements of the following standards:

**Test Standard:**

**FCC 47 CFR Part 2**

**FCC 47 CFR Part 90**

**ANSI 63.26-2015**

**Note:** All test items have been performed and recorded as per the above standards.

**References Test Guidance:**

**KDB 971168 D01 Power Meas License Digital Systems v03r01**

**KDB 971168 D02 Misc Rev Approv License Devices v02r01**

**ANSI/TIA/EIA-603-E 2016**

**Note:** All test items have been performed as a reference to the above KDB test guidance.

## 4 Test Types and Results

### 4.1 Output Power Measurement

#### 4.1.1 Limits of Output Power Measurement

##### LTE Band 14

Portable stations (hand-held devices) transmitting in the 758-768 MHz band and the 788-798 MHz band are limited to 3 watts ERP.

##### LTE Band 26

The maximum output power of the transmitter for mobile stations is 100 watts (20 dBw) ERP.

#### 4.1.2 Test Procedures

##### **EIRP / ERP Measurement:**

- a. All measurements were done at low, middle and high operational frequency range. RBW and VBW is 10 MHz for LTE mode.
- b. Substitution method is used for E.I.R.P measurement. In the semi-anechoic chamber, EUT placed on the 0.8 m (below or equal 1 GHz) and/or 1.5 m (above 1 GHz) height of Turn Table, rotated the table around 360 degrees to search the maximum radiation power and receiver antenna shall be rotated vertical and horizontal polarization and moved height from 1 m to 4 m to find the maximum polar radiated power. The "Read Value" is the spectrum reading the maximum power value.
- c. The substitution horn antenna is substituted for EUT at the same position and signals generator export the CW signal to the substitution antenna via a tx cable. Rotated the Turn Table and moved receiving antenna to find the maximum radiation power. Adjust output power level of S.G to get a Value of spectrum reading equal to "Read Value" of step b. Record the power level of S.G.
- d.  $EIRP = \text{Output power level of S.G} - \text{TX cable loss} + \text{Antenna gain of substitution horn}$ . E.R.P power can be calculated form E.I.R.P power by subtracting the gain of dipole,  $E.R.P \text{ power} = E.I.P.R \text{ power} - 2.15 \text{ dB}$ .

##### **Conducted Power Measurement:**

- a. The EUT was set up for the maximum power with LTE link data modulation and link up with simulator.
- b. Set the EUT to transmit under low, middle and high channel and record the power level shown on simulator.

4.1.3 Test Setup

**EIRP / ERP Measurement:**

**<Radiated Emission below or equal 1 GHz>**

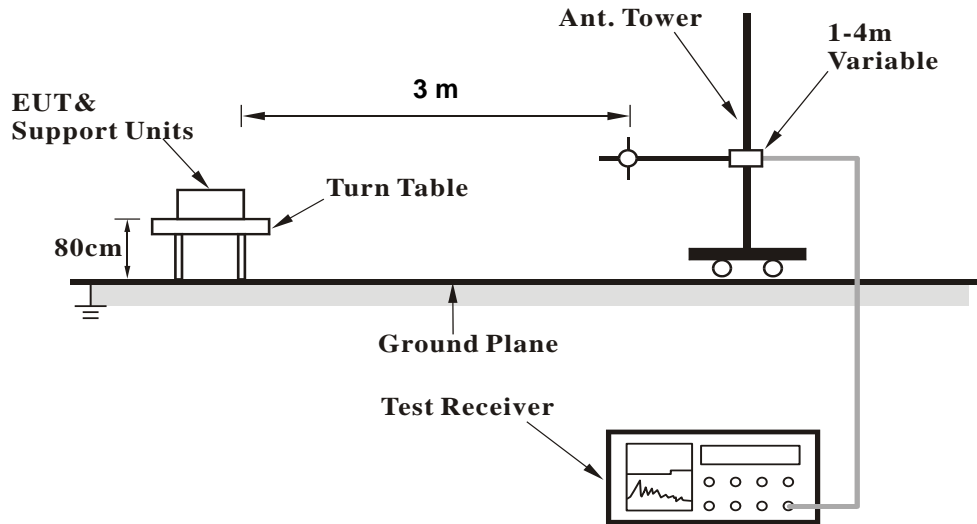

**<Radiated Emission above 1 GHz>**

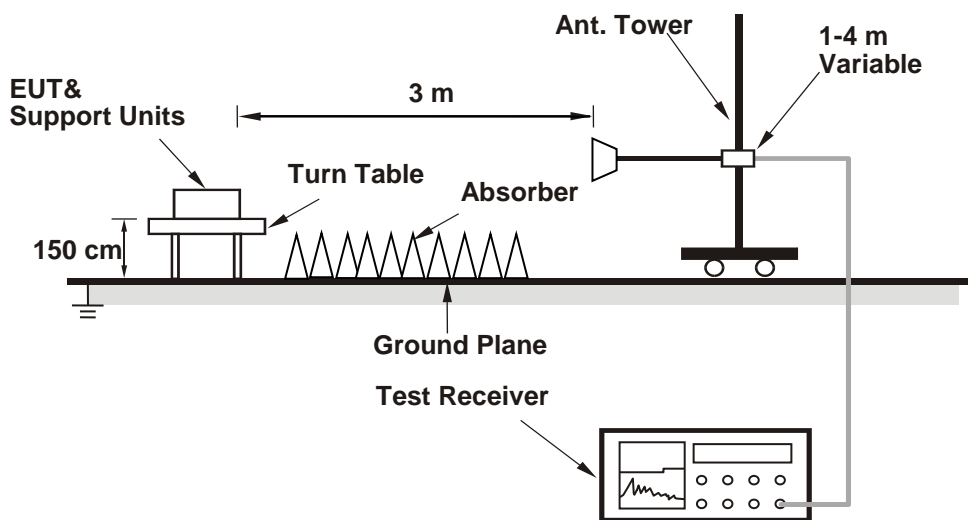

For the actual test configuration, please refer to the attached file (Test Setup Photo).

4.1.4 Test Results

**ERP Power (dBm)**

LTE Band 14							
Channel Bandwidth: 5 MHz / QPSK							
Plane	Channel	Frequency (MHz)	Reading (dBm)	Correction Factor (dB)	ERP (dBm)	ERP (mW)	Polarization (H/V)
X	23305	790.5	-9.77	32.771	20.85	121.65	H
	23330	793.0	-9.21	32.741	21.38	137.44	
	23355	795.5	-9.15	32.854	21.55	143.02	
	23305	790.5	-12.81	32.5	17.54	56.75	V
	23330	793.0	-13.41	32.52	16.96	49.66	
	23355	795.5	-13.29	32.62	17.18	52.24	
Channel Bandwidth: 5 MHz / 16QAM							
X	23305	790.5	-10.66	32.771	19.96	99.11	H
	23330	793.0	-9.96	32.741	20.63	115.64	
	23355	795.5	-10.85	32.854	19.85	96.69	
	23305	790.5	-13.65	32.5	16.70	46.77	V
	23330	793.0	-13.83	32.52	16.54	45.08	
	23355	795.5	-13.62	32.62	16.85	48.42	
Channel Bandwidth: 5 MHz / 64QAM							
X	23305	790.5	-11.40	32.771	19.22	83.58	H
	23330	793.0	-11.72	32.741	18.87	77.11	
	23355	795.5	-11.16	32.854	19.54	90.03	
	23305	790.5	-15.41	32.5	14.94	31.19	V
	23330	793.0	-15.01	32.52	15.36	34.36	
	23355	795.5	-15.01	32.62	15.46	35.16	

Note: ERP (dBm) = Reading (dBm) + Correction Factor (dB) – 2.15

LTE Band 14							
Channel Bandwidth: 10 MHz / QPSK							
Plane	Channel	Frequency (MHz)	Reading (dBm)	Correction Factor (dB)	ERP (dBm)	ERP (mW)	Polarization (H/V)
X	23330	793.0	-8.98	32.737	21.61	144.78	H
	23330	793.0	-12.73	32.52	17.64	58.08	V
Channel Bandwidth: 10 MHz / 16QAM							
X	23330	793.0	-9.99	32.737	20.60	114.74	H
	23330	793.0	-13.70	32.52	16.67	46.45	V
Channel Bandwidth: 10 MHz / 64QAM							
X	23330	793.0	-10.83	32.737	19.76	94.56	H
	23330	793.0	-15.38	32.52	14.99	31.55	V

Note: ERP (dBm) = Reading (dBm) + Correction Factor (dB) – 2.15

LTE Band 26							
Channel Bandwidth: 1.4 MHz / QPSK							
Plane	Channel	Frequency (MHz)	Reading (dBm)	Correction Factor (dB)	ERP (dBm)	ERP (mW)	Polarization (H/V)
Z	26697	814.7	-6.84	31.208	22.22	166.65	H
	26740	819.0	-6.76	31.3	22.39	173.38	
	26783	823.3	-6.82	31.222	22.25	167.96	
	26697	814.7	-11.21	31.504	18.14	65.22	V
	26740	819.0	-10.76	31.117	18.21	66.18	
	26783	823.3	-11.35	31.922	18.42	69.53	
Channel Bandwidth: 1.4 MHz / 16QAM							
Z	26697	814.7	-7.83	31.208	21.23	132.68	H
	26740	819.0	-7.75	31.3	21.40	138.04	
	26783	823.3	-7.64	31.222	21.43	139.06	
	26697	814.7	-12.15	31.504	17.20	52.53	V
	26740	819.0	-11.79	31.117	17.18	52.20	
	26783	823.3	-12.40	31.922	17.37	54.60	
Channel Bandwidth: 1.4 MHz / 64QAM							
Z	26697	814.7	-8.91	31.208	20.15	103.47	H
	26740	819.0	-8.90	31.3	20.25	105.93	
	26783	823.3	-8.79	31.222	20.28	106.71	
	26697	814.7	-13.04	31.504	16.31	42.80	V
	26740	819.0	-12.63	31.117	16.34	43.02	
	26783	823.3	-13.28	31.922	16.49	44.59	

Note: ERP (dBm) = Reading (dBm) + Correction Factor (dB) – 2.15



LTE Band 26							
Channel Bandwidth: 3 MHz / QPSK							
Plane	Channel	Frequency (MHz)	Reading (dBm)	Correction Factor (dB)	ERP (dBm)	ERP (mW)	Polarization (H/V)
Z	26705	815.5	-6.89	31.208	22.17	164.74	H
	26740	819.0	-6.79	31.3	22.36	172.19	
	26775	822.5	-6.76	31.222	22.31	170.29	
	26705	815.5	-11.11	31.504	18.24	66.74	V
	26740	819.0	-10.69	31.117	18.28	67.25	
	26775	822.5	-11.45	31.922	18.32	67.95	
Channel Bandwidth: 3 MHz / 16QAM							
Z	26705	815.5	-7.84	31.208	21.22	132.37	H
	26740	819.0	-7.75	31.3	21.40	138.04	
	26775	822.5	-7.69	31.222	21.38	137.47	
	26705	815.5	-12.02	31.504	17.33	54.13	V
	26740	819.0	-11.73	31.117	17.24	52.93	
	26775	822.5	-12.23	31.922	17.54	56.78	
Channel Bandwidth: 3 MHz / 64QAM							
Z	26705	815.5	-8.80	31.208	20.26	106.12	H
	26740	819.0	-8.86	31.3	20.29	106.91	
	26775	822.5	-8.75	31.222	20.32	107.70	
	26705	815.5	-13.16	31.504	16.19	41.63	V
	26740	819.0	-12.70	31.117	16.27	42.34	
	26775	822.5	-13.27	31.922	16.50	44.69	

Note: ERP (dBm) = Reading (dBm) + Correction Factor (dB) – 2.15

LTE Band 26							
Channel Bandwidth: 5 MHz / QPSK							
Plane	Channel	Frequency (MHz)	Reading (dBm)	Correction Factor (dB)	ERP (dBm)	ERP (mW)	Polarization (H/V)
Z	26715	816.5	-6.84	31.208	22.22	166.65	H
	26740	819.0	-6.87	31.3	22.28	169.04	
	26765	821.5	-6.56	31.222	22.51	178.32	
	26715	816.5	-10.97	31.504	18.38	68.93	V
	26740	819.0	-10.52	31.117	18.45	69.94	
	26765	821.5	-11.22	31.922	18.55	71.65	
Channel Bandwidth: 5 MHz / 16QAM							
Z	26715	816.5	-7.91	31.208	21.15	130.26	H
	26740	819.0	-7.86	31.3	21.29	134.59	
	26765	821.5	-7.58	31.222	21.49	140.99	
	26715	816.5	-12.17	31.504	17.18	52.29	V
	26740	819.0	-11.53	31.117	17.44	55.42	
	26765	821.5	-12.18	31.922	17.59	57.44	
Channel Bandwidth: 5 MHz / 64QAM							
Z	26715	816.5	-8.75	31.208	20.31	107.35	H
	26740	819.0	-8.83	31.3	20.32	107.65	
	26765	821.5	-8.55	31.222	20.52	112.77	
	26715	816.5	-13.06	31.504	16.29	42.60	V
	26740	819.0	-12.57	31.117	16.40	43.62	
	26765	821.5	-13.32	31.922	16.45	44.18	

Note: ERP (dBm) = Reading (dBm) + Correction Factor (dB) – 2.15

LTE Band 26							
Channel Bandwidth: 10 MHz / QPSK							
Plane	Channel	Frequency (MHz)	Reading (dBm)	Correction Factor (dB)	ERP (dBm)	ERP (mW)	Polarization (H/V)
Z	26740	819.0	-6.73	31.3	22.42	174.58	H
	26740	819.0	-10.48	31.117	18.49	70.58	V
Channel Bandwidth: 10 MHz / 16QAM							
Z	26740	819.0	-7.76	31.3	21.39	137.72	H
	26740	819.0	-11.62	31.117	17.35	54.29	V
Channel Bandwidth: 10 MHz / 64QAM							
Z	26740	819.0	-8.67	31.3	20.48	111.69	H
	26740	819.0	-12.52	31.117	16.45	44.13	V

Note: ERP (dBm) = Reading (dBm) + Correction Factor (dB) – 2.15

## 4.2 Radiated Emission Measurement

### 4.2.1 Limits of Radiated Emission Measurement

- (1) The power of any emission outside a licensee's frequency block shall be attenuated below the transmitter power (P) by at least  $43 + 10 \log (P)$  dB. The limit of emission is equal to -13 dBm.
- (2) For operations in the 758-775 MHz and 788-805 MHz bands, all emissions including harmonics in the band 1559-1610 MHz shall be limited to -70 dBW/MHz equivalent isotropically radiated power (EIRP) for wideband signals, and -80 dBW EIRP for discrete emissions of less than 700 Hz bandwidth.

### 4.2.2 Test Procedure

- a. Substitution method is used for E.I.R.P measurement. In the semi-anechoic chamber, EUT placed on the 0.8 m (below or equal 1 GHz) and/or 1.5 m (above 1 GHz) height of Turn Table, rotated the table around 360 degrees to search the maximum radiation power and receiver antenna shall be rotated vertical and horizontal polarization and moved height from 1 m to 4 m to find the maximum polar radiated power. The "Read Value" is the spectrum reading the maximum power value.
- b.  $EIRP = \text{Output power level of S.G} - \text{TX cable loss} + \text{Antenna gain of substitution horn}$ .
- c. E.R.P power can be calculated form E.I.R.P power by subtracting the gain of dipole,  $E.R.P \text{ power} = E.I.R.P \text{ power} - 2.15 \text{ dB}$ .

#### NOTE:

1. The resolution bandwidth and video bandwidth of test receiver/spectrum analyzer is 1 MHz/3 MHz.
2. The emission levels were against the limit of frequency range 9 kHz ~ 30 MHz:

The amplitude of spurious emissions attenuated more than 20 dB below the permissible value is not required to be report.

### 4.2.3 Deviation from Test Standard

No deviation.

4.2.4 Test Setup

<Radiated Emission below or equal 1 GHz>

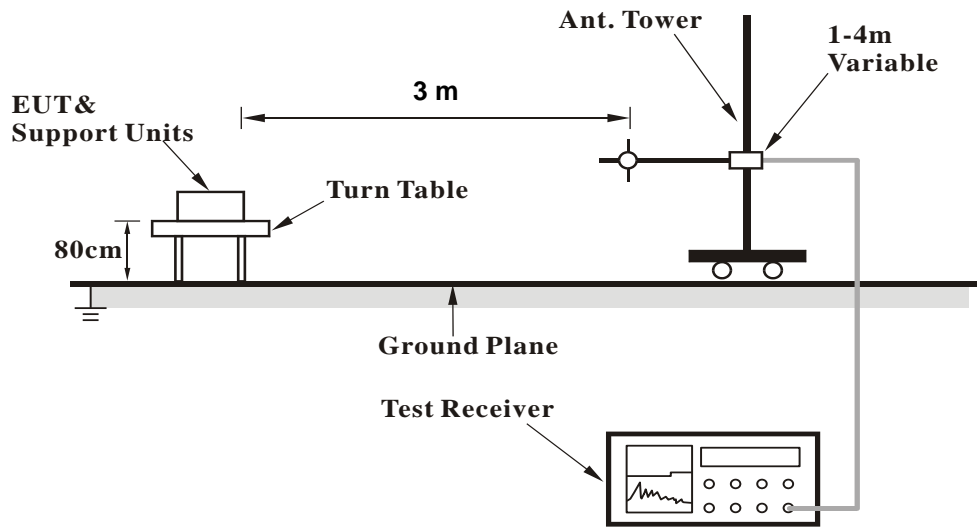

<Radiated Emission above 1 GHz>

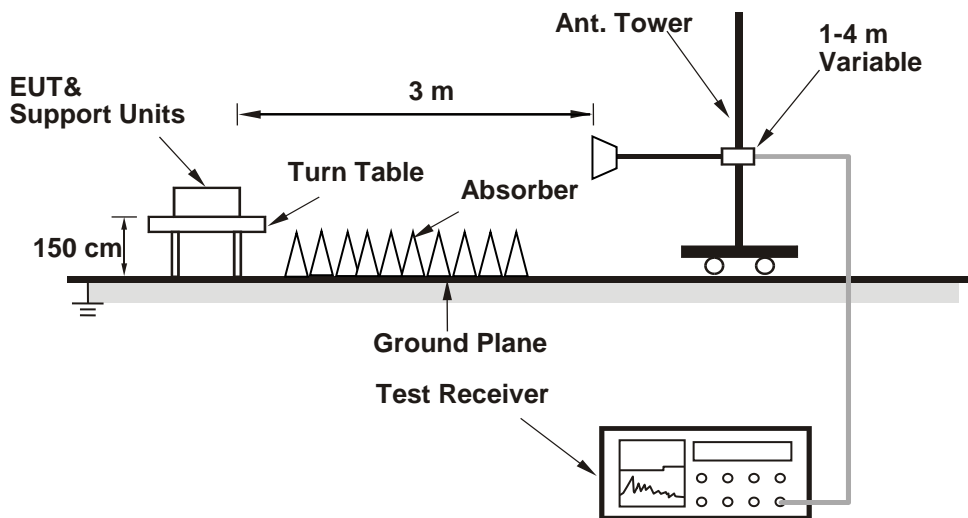

For the actual test configuration, please refer to the attached file (Test Setup Photo).

4.2.5 Test Results

LTE Band 14  
 Channel Bandwidth: 5 MHz / QPSK  
 Low Channel



Bureau Veritas Consumer Products Services Ltd., Taoyuan Branch

A D T

Data: 5

Date: 2021-01-22

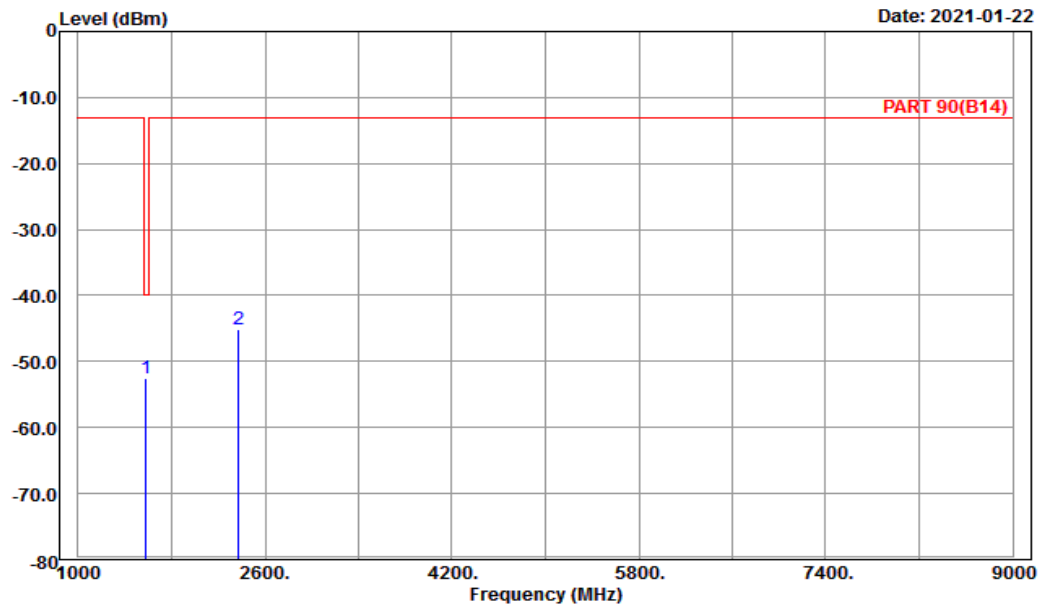

Site : 966 chamber 1  
 Condition: PART 90(B14) Horizontal  
 Remark : LTE\_Band 14\_Link\_L-Ch  
 Tested by: Charles Hsiao

	Freq	Level	Read Level	Factor	Limit Line	Over Limit	Remark
	MHz	dBm	dBm	dB	dBm	dB	
1 pp	1581.00	-52.45	-59.49	7.04	-40.00	-12.45	Peak
2	2371.50	-45.07	-56.02	10.95	-13.00	-32.07	Peak



Bureau Veritas Consumer Products Services Ltd., Taoyuan Branch

A D T

Data: 6

Date: 2021-01-22

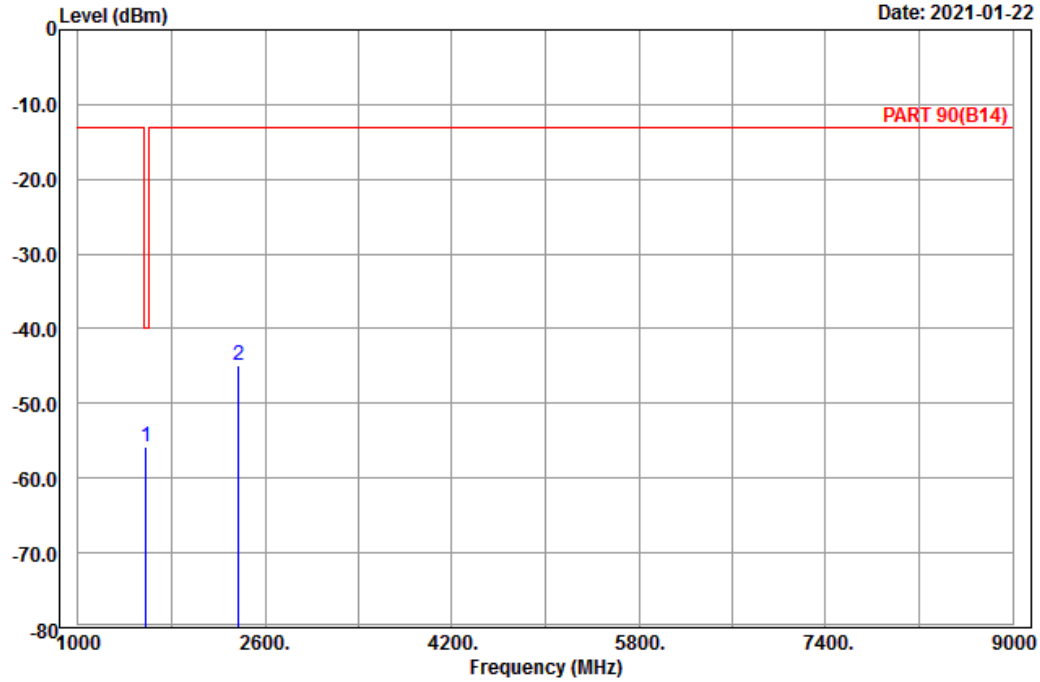

Site : 966 chamber 1  
 Condition: PART 90(B14) Vertical  
 Remark : LTE\_Band 14\_Link\_L-Ch  
 Tested by: Charles Hsiao

	Freq	Level	Read Level	Factor	Limit Line	Over Limit	Remark
	MHz	dBm	dBm	dB	dBm	dB	
1 pp	1581.00	-55.74	-62.78	7.04	-40.00	-15.74	Peak
2	2371.50	-44.97	-55.92	10.95	-13.00	-31.97	Peak

Middle Channel



Bureau Veritas Consumer Products Services Ltd., Taoyuan Branch

A D T

Data: 5

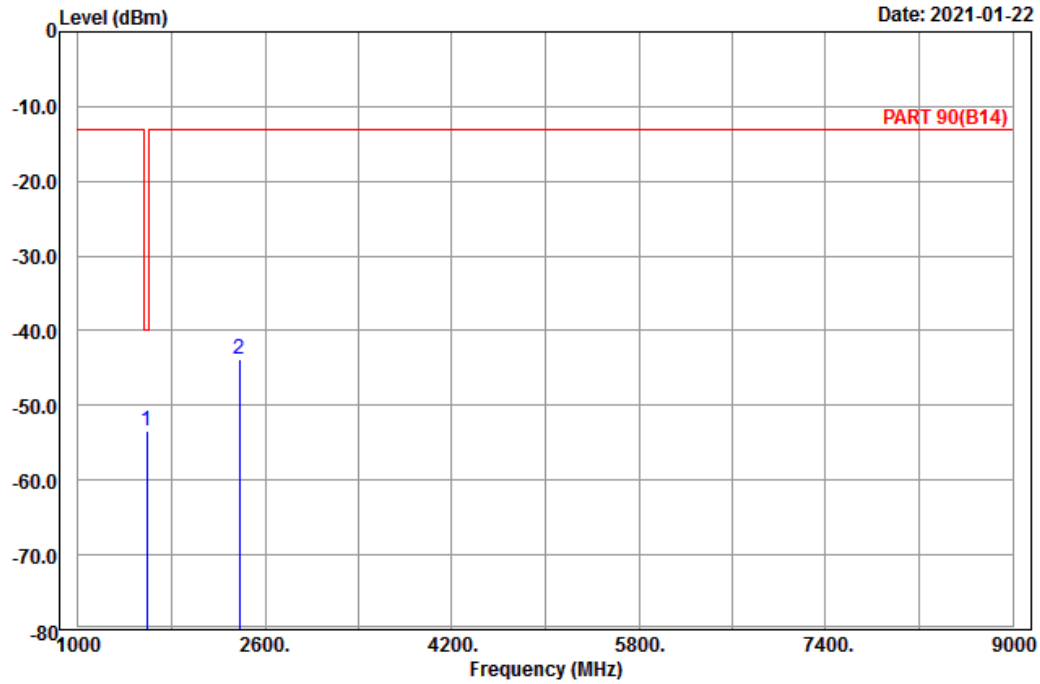

Site : 966 chamber 1  
 Condition: PART 90(B14) Horizontal  
 Remark : LTE\_Band 14\_Link\_M-Ch  
 Tested by: Charles Hsiao

	Freq	Level	Read Level	Factor	Limit Line	Over Limit	Remark
	MHz	dBm	dBm	dB	dBm	dB	
1 pp	1586.00	-53.43	-60.64	7.21	-40.00	-13.43	Peak
2	2379.00	-43.88	-54.84	10.96	-13.00	-30.88	Peak



Bureau Veritas Consumer Products Services Ltd., Taoyuan Branch

A D T

Data: 6

Date: 2021-01-22

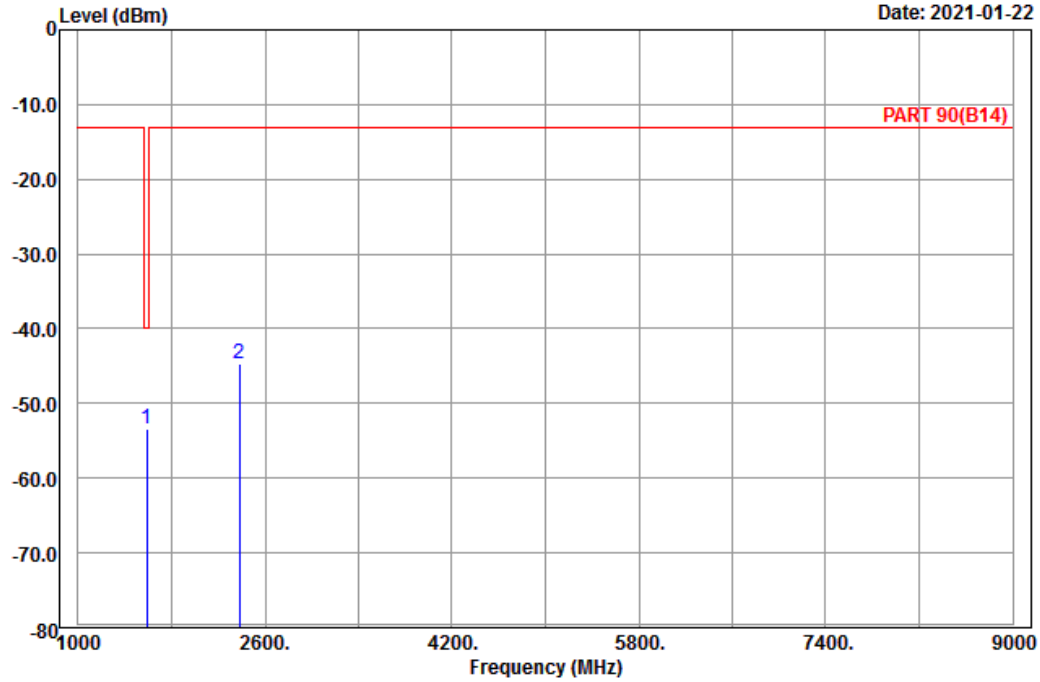

Site : 966 chamber 1  
 Condition: PART 90(B14) Vertical  
 Remark : LTE\_Band 14\_Link\_M-Ch  
 Tested by: Charles Hsiao

	Freq	Level	Read Level	Factor	Limit Line	Over Limit	Remark
	MHz	dBm	dBm	dB	dBm	dB	
1 pp	1586.00	-53.30	-60.51	7.21	-40.00	-13.30	Peak
2	2379.00	-44.64	-55.60	10.96	-13.00	-31.64	Peak



High Channel



Bureau Veritas Consumer Products Services Ltd., Taoyuan Branch

A D T

Data: 5

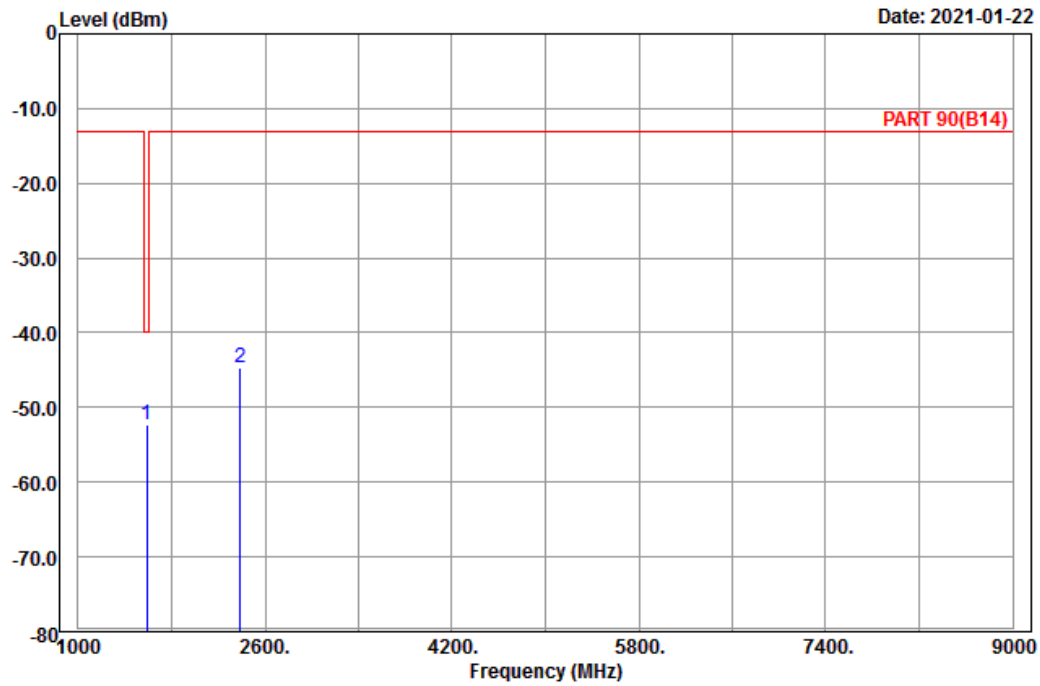

Site : 966 chamber 1  
 Condition: PART 90(B14) Horizontal  
 Remark : LTE\_Band 14\_Link\_H-Ch  
 Tested by: Charles Hsiao

	Freq	Level	Read Level	Factor	Limit Line	Over Limit	Remark
	MHz	dBm	dBm	dB	dBm	dB	
1 pp	1591.00	-52.26	-59.47	7.21	-40.00	-12.26	Peak
2	2386.50	-44.64	-55.60	10.96	-13.00	-31.64	Peak



Bureau Veritas Consumer Products Services Ltd., Taoyuan Branch

A D T

Data: 6

Date: 2021-01-22

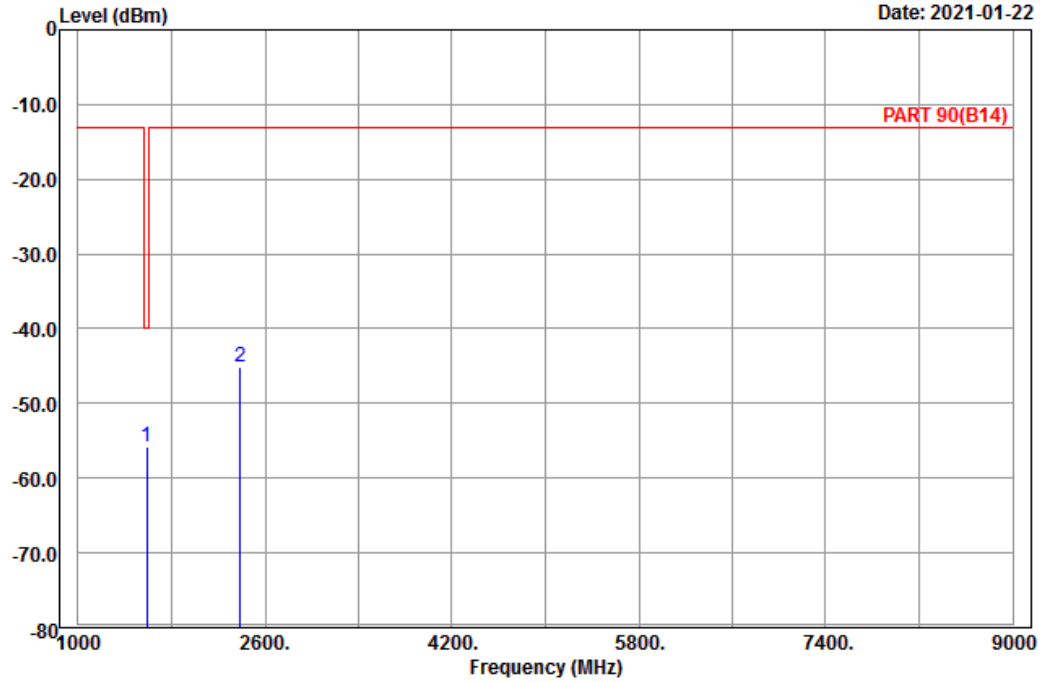

Site : 966 chamber 1  
 Condition: PART 90(B14) Vertical  
 Remark : LTE\_Band 14\_Link\_H-Ch  
 Tested by: Charles Hsiao

	Freq	Level	Read Level	Factor	Limit Line	Over Limit	Remark
	MHz	dBm	dBm	dB	dBm	dB	
1 pp	1591.00	-55.78	-62.99	7.21	-40.00	-15.78	Peak
2	2386.50	-45.07	-56.03	10.96	-13.00	-32.07	Peak

Channel Bandwidth: 10 MHz / QPSK  
Middle Channel



Bureau Veritas Consumer Products Services Ltd., Taoyuan Branch

A D T

Data: 9

Date: 2021-01-22

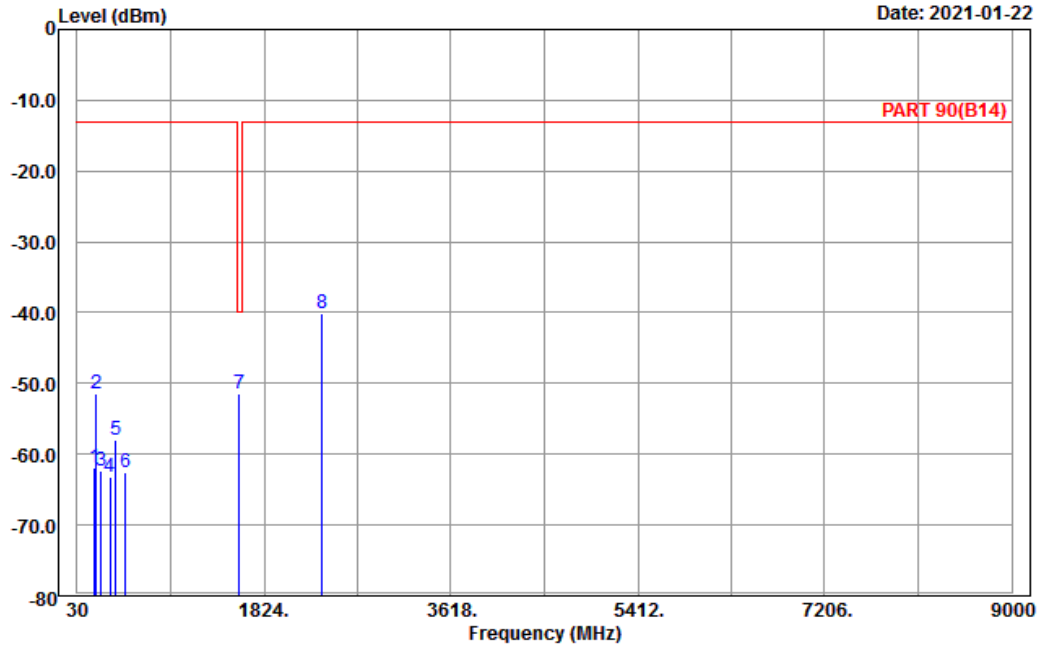

Site : 966 chamber 1  
Condition: PART 90(B14) Horizontal  
Remark : LTE\_Band 14\_Link\_M-Ch  
Tested by: Charles Hsiao

	Freq	Level	Read Level	Factor	Limit	Over Limit	Remark
	MHz	dBm	dBm	dB	dBm	dB	
1	197.67	-61.85	-55.76	-6.09	-13.00	-48.85	Peak
2	211.17	-51.51	-45.48	-6.03	-13.00	-38.51	Peak
3	261.12	-62.43	-56.83	-5.60	-13.00	-49.43	Peak
4	348.30	-63.17	-57.77	-5.40	-13.00	-50.17	Peak
5	398.70	-58.00	-55.21	-2.79	-13.00	-45.00	Peak
6	491.80	-62.54	-57.51	-5.03	-13.00	-49.54	Peak
7 pp	1586.00	-51.42	-58.63	7.21	-40.00	-11.42	Peak
8	2379.00	-40.10	-51.06	10.96	-13.00	-27.10	Peak



Bureau Veritas Consumer Products Services Ltd., Taoyuan Branch

A D T

Data: 10

Date: 2021-01-22

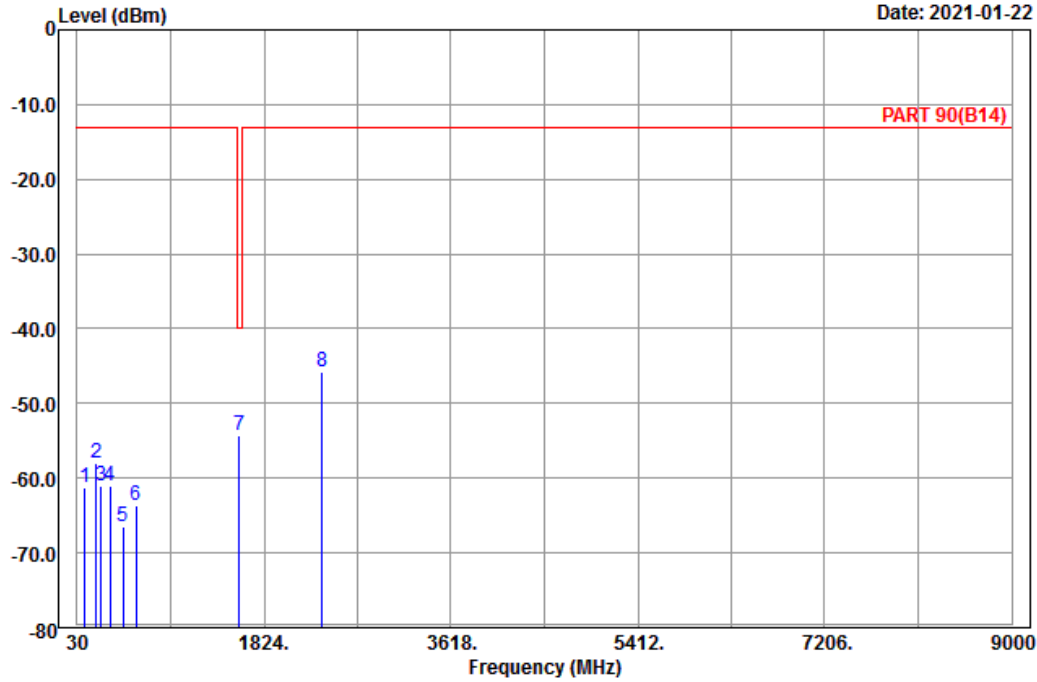

Site : 966 chamber 1  
 Condition: PART 90(B14) Vertical  
 Remark : LTE\_Band 14\_Link\_M-Ch  
 Tested by: Charles Hsiao

	Freq	Level	Read Level	Factor	Limit Line	Over Limit	Remark
	MHz	dBm	dBm	dB	dBm	dB	
1	101.01	-61.26	-51.26	-10.00	-13.00	-48.26	Peak
2	209.82	-58.01	-51.96	-6.05	-13.00	-45.01	Peak
3	262.20	-60.97	-55.36	-5.61	-13.00	-47.97	Peak
4	349.70	-60.95	-55.57	-5.38	-13.00	-47.95	Peak
5	469.40	-66.41	-62.01	-4.40	-13.00	-53.41	Peak
6	594.70	-63.71	-63.90	0.19	-13.00	-50.71	Peak
7 pp	1586.00	-54.29	-61.50	7.21	-40.00	-14.29	Peak
8	2379.00	-45.81	-56.77	10.96	-13.00	-32.81	Peak

LTE Band 26  
 Channel Bandwidth: 1.4 MHz / QPSK  
 Low Channel



Bureau Veritas Consumer Products Services Ltd., Taoyuan Branch

A D T

Data: 3

Date: 2021-01-26

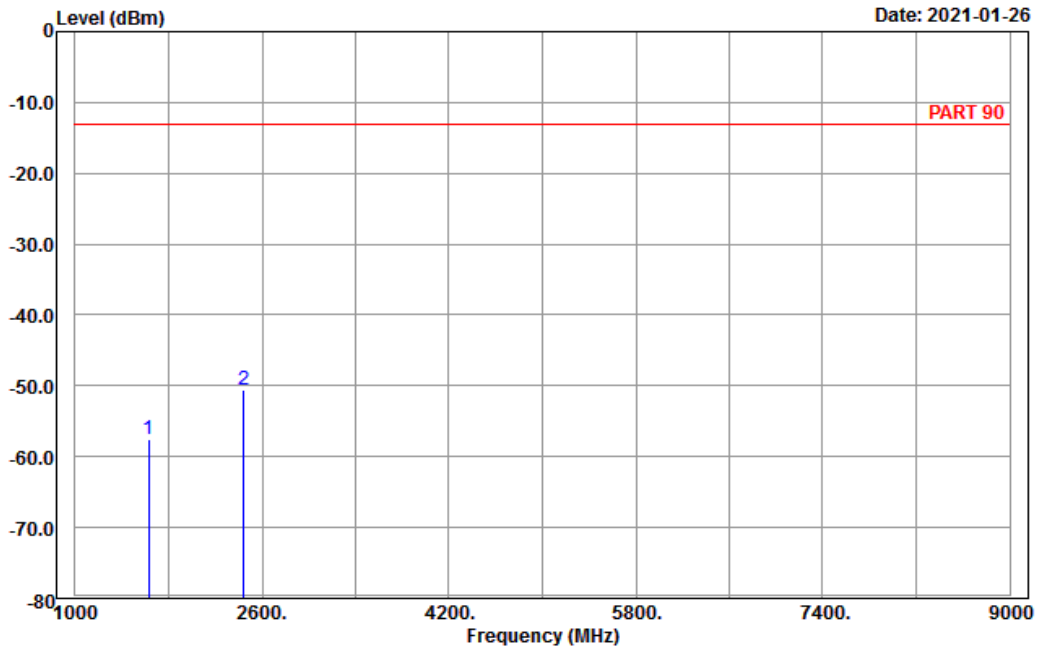

Site : 966 chamber 1  
 Condition: PART 90 Horizontal  
 Remark : LTE\_Band 26\_Link\_L-Ch  
 Tested by: Charles Hsiao

	Freq	Level	Read Level	Factor	Limit Line	Over Limit	Remark
	MHz	dBm	dBm	dB	dBm	dB	
1	1629.40	-57.50	-65.06	7.56	-13.00	-44.50	Peak
2 pp	2444.10	-50.57	-61.57	11.00	-13.00	-37.57	Peak



Bureau Veritas Consumer Products Services Ltd., Taoyuan Branch

A D T

Data: 4

Date: 2021-01-26

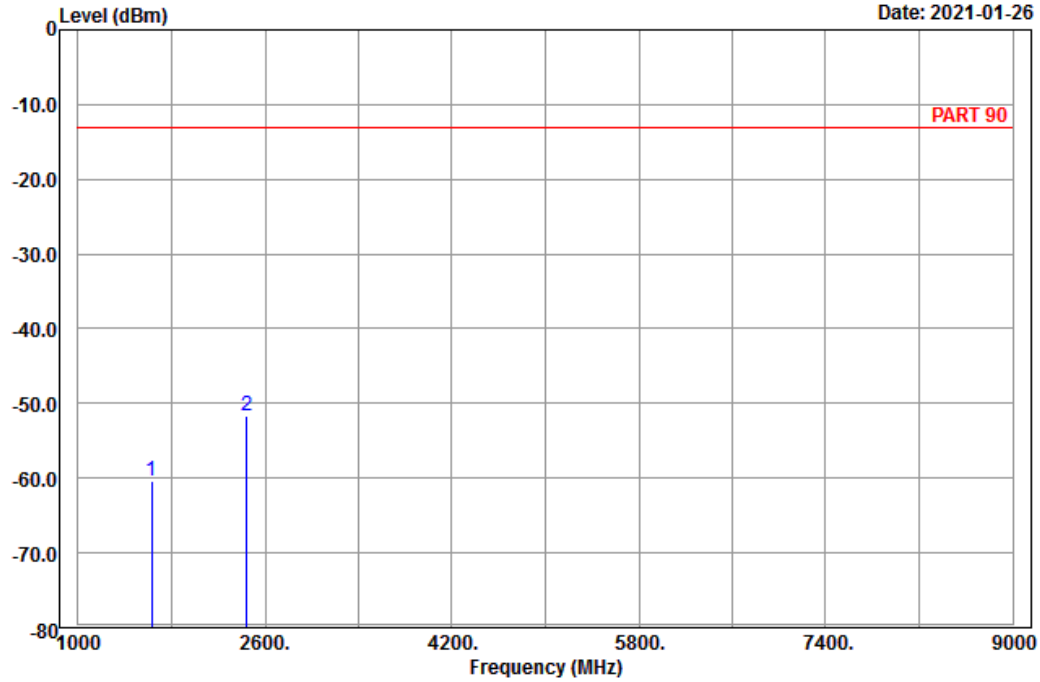

Site : 966 chamber 1  
 Condition: PART 90 Vertical  
 Remark : LTE\_Band 26\_Link\_L-Ch  
 Tested by: Charles Hsiao

	Freq	Level	Read Level	Factor	Limit Line	Over Limit	Remark
	MHz	dBm	dBm	dB	dBm	dB	
1	1629.40	-60.39	-67.95	7.56	-13.00	-47.39	Peak
2	pp 2444.10	-51.68	-62.68	11.00	-13.00	-38.68	Peak

Middle Channel



Bureau Veritas Consumer Products Services Ltd., Taoyuan Branch

A D T

Data: 3

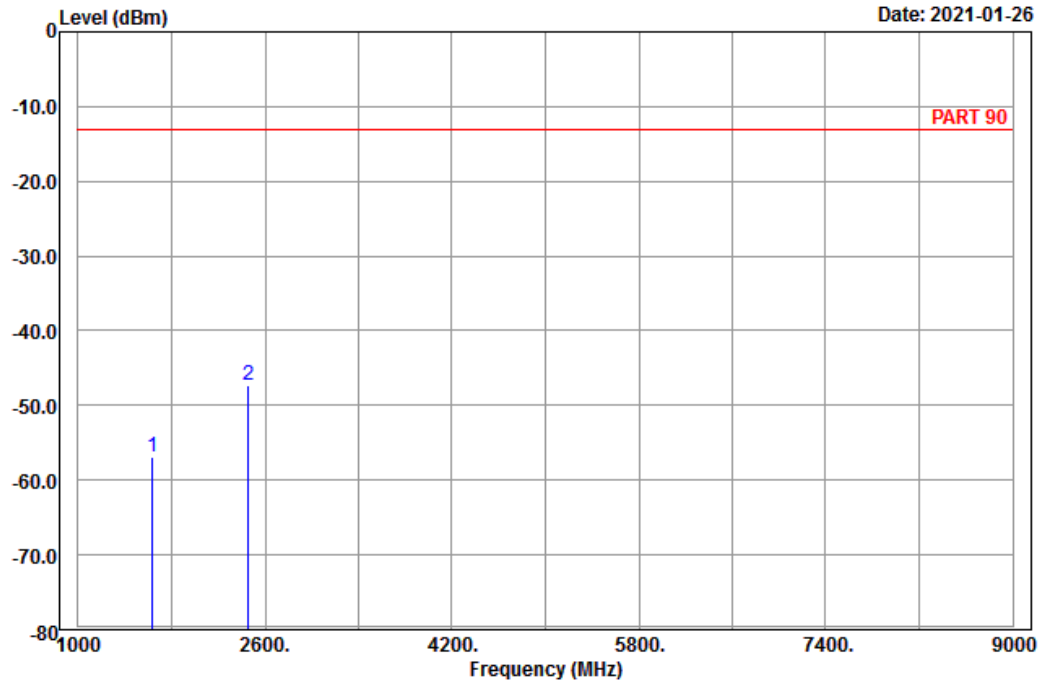

Site : 966 chamber 1  
 Condition: PART 90 Horizontal  
 Remark : LTE\_Band 26\_Link\_M-Ch  
 Tested by: Charles Hsiao

	Freq	Level	Read Level	Factor	Limit Line	Over Limit	Remark
	MHz	dBm	dBm	dB	dBm	dB	
1	1638.00	-56.96	-64.52	7.56	-13.00	-43.96	Peak
2 pp	2457.00	-47.29	-58.31	11.02	-13.00	-34.29	Peak



Bureau Veritas Consumer Products Services Ltd., Taoyuan Branch

A D T

Data: 4

Date: 2021-01-26

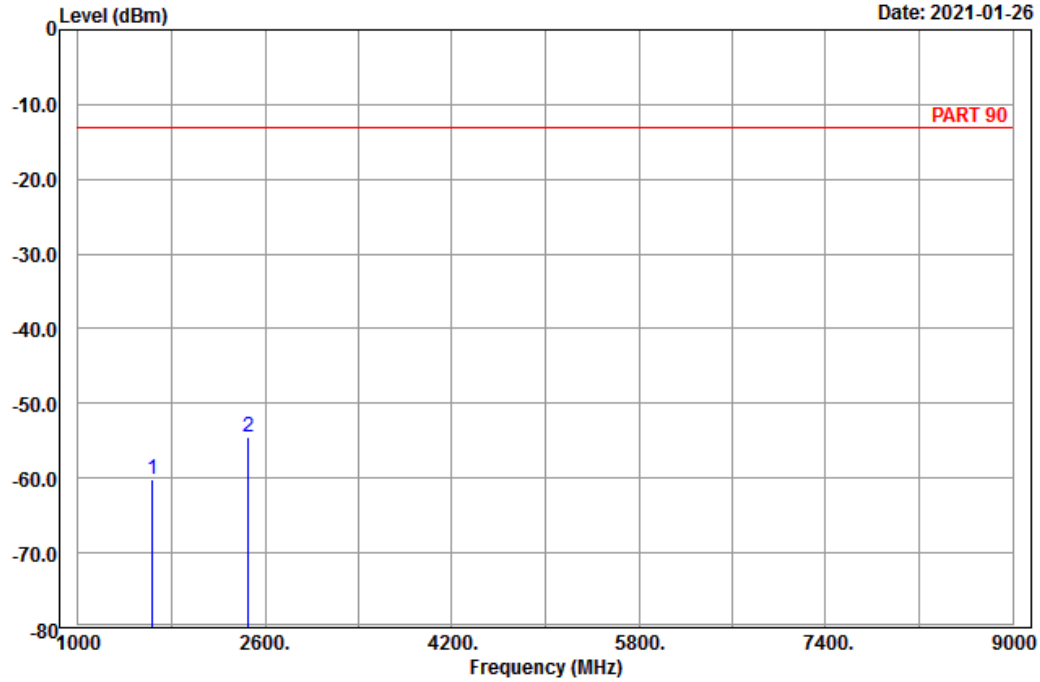

Site : 966 chamber 1  
 Condition: PART 90 Vertical  
 Remark : LTE\_Band 26\_Link\_M-Ch  
 Tested by: Charles Hsiao

	Freq	Level	Read Level	Factor	Limit Line	Over Limit	Remark
	MHz	dBm	dBm	dB	dBm	dB	
1	1638.00	-60.24	-67.80	7.56	-13.00	-47.24	Peak
2	2457.00	-54.60	-65.62	11.02	-13.00	-41.60	Peak



# High Channel



Bureau Veritas Consumer Products Services Ltd., Taoyuan Branch

A D T

Data: 3

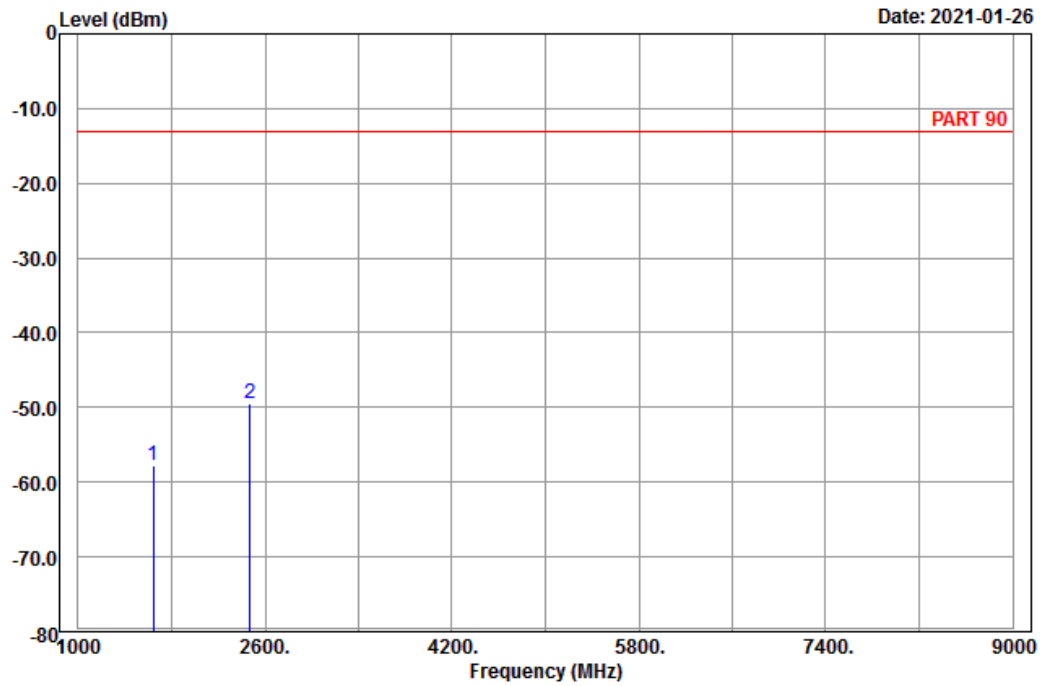

Site : 966 chamber 1  
 Condition: PART 90 Horizontal  
 Remark : LTE\_Band 26\_Link\_H-Ch  
 Tested by: Charles Hsiao

	Freq	Level	Read Level	Factor	Limit Line	Over Limit	Remark
	MHz	dBm	dBm	dB	dBm	dB	
1	1646.60	-57.67	-65.40	7.73	-13.00	-44.67	Peak
2	2469.90	-49.57	-60.60	11.03	-13.00	-36.57	Peak



Bureau Veritas Consumer Products Services Ltd., Taoyuan Branch

A D T

Data: 4

Date: 2021-01-26

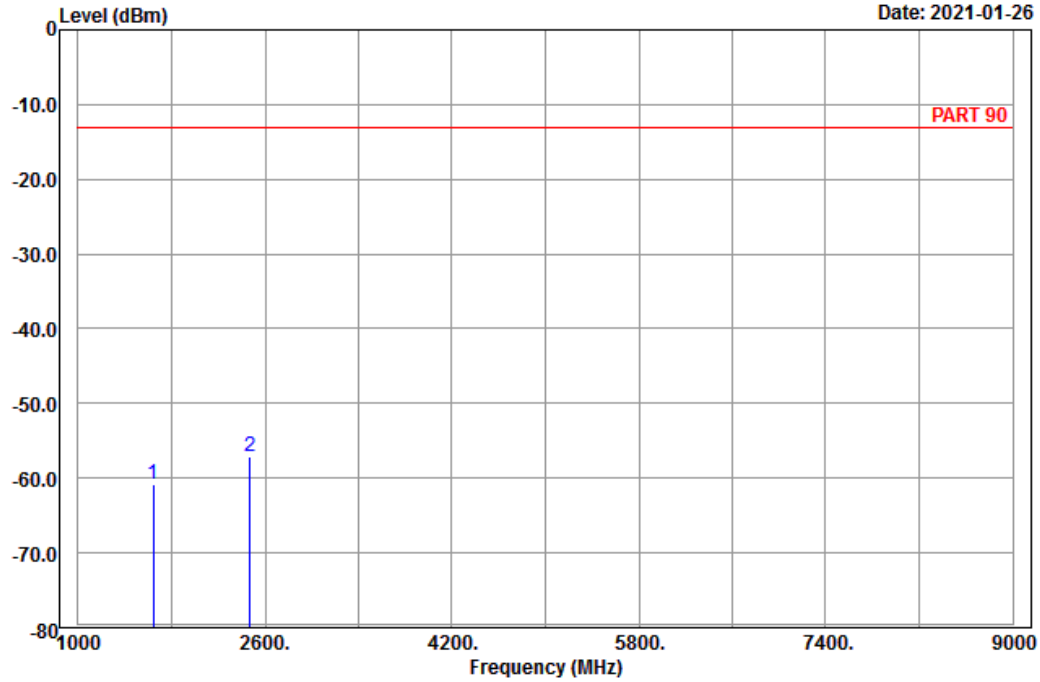

Site : 966 chamber 1  
 Condition: PART 90 Vertical  
 Remark : LTE\_Band 26\_Link\_H-Ch  
 Tested by: Charles Hsiao

	Freq	Level	Read Level	Factor	Limit Line	Over Limit	Remark
	MHz	dBm	dBm	dB	dBm	dB	
1	1646.60	-60.86	-68.59	7.73	-13.00	-47.86	Peak
2	2469.90	-57.01	-68.04	11.03	-13.00	-44.01	Peak

Channel Bandwidth: 5 MHz / QPSK  
Low Channel



Bureau Veritas Consumer Products Services Ltd., Taoyuan Branch

A D T

Data: 5

Date: 2021-01-22

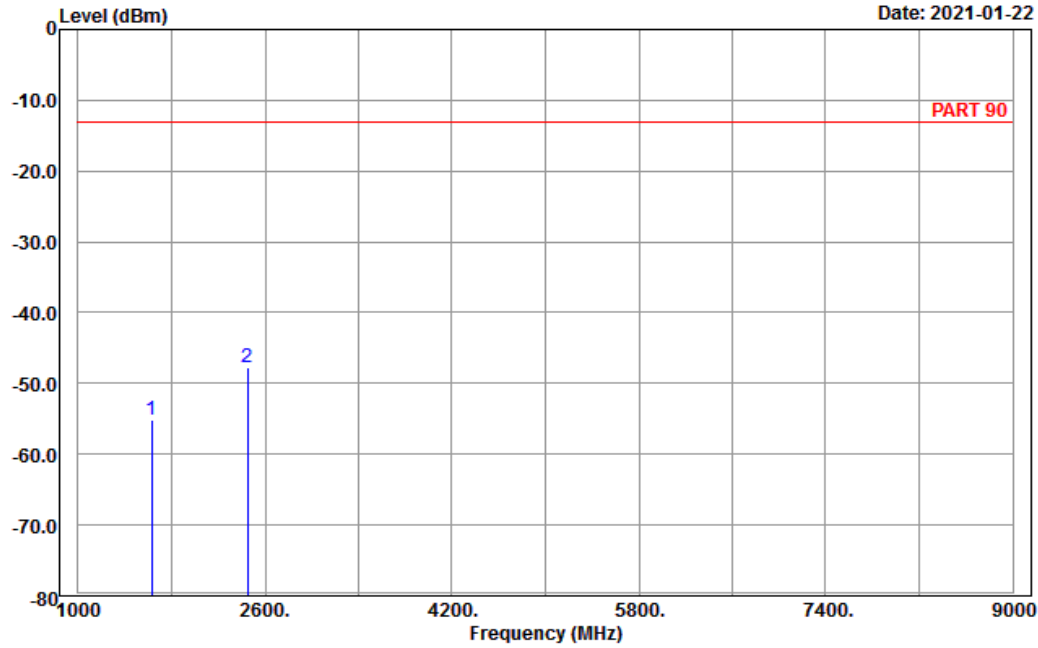

Site : 966 chamber 1  
Condition: PART 90 Horizontal  
Remark : LTE\_Band 26\_Link\_L-Ch  
Tested by: Charles Hsiao

	Read	Limit	Over				
Freq	Level	Level	Factor	Line	Limit	Remark	
MHz	dBm	dBm	dB	dBm	dB		
1	1633.00	-55.22	-62.78	7.56	-13.00	-42.22	Peak
2 pp	2449.50	-47.70	-58.72	11.02	-13.00	-34.70	Peak



Bureau Veritas Consumer Products Services Ltd., Taoyuan Branch

A D T

Data: 6

Date: 2021-01-22

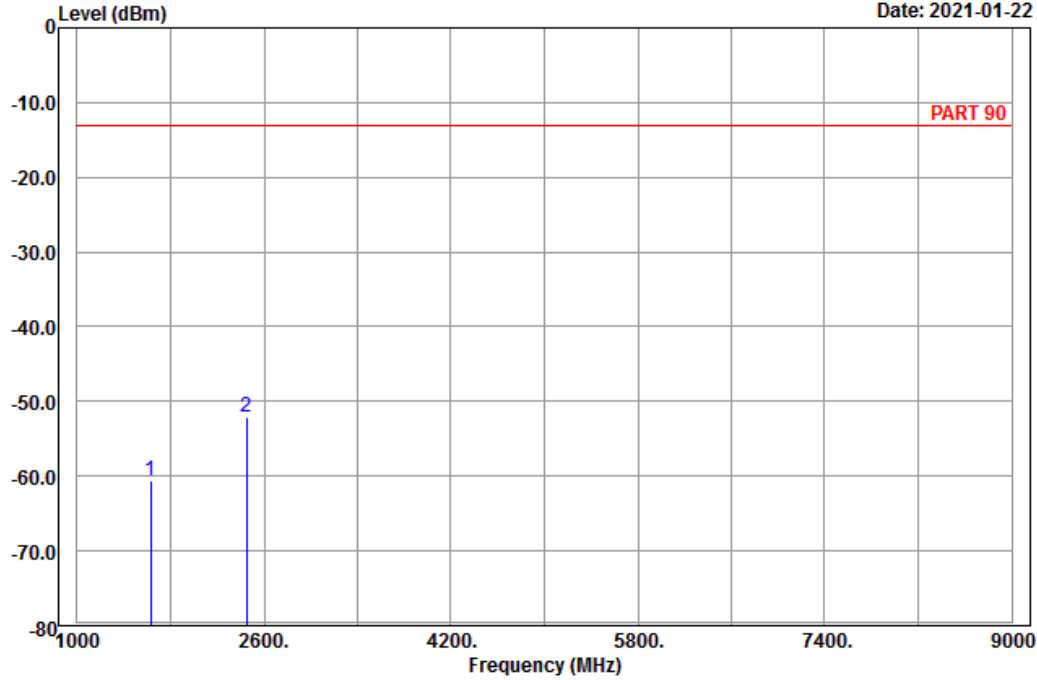

Site : 966 chamber 1  
 Condition: PART 90 Vertical  
 Remark : LTE\_Band 26\_Link\_L-Ch  
 Tested by: Charles Hsiao

	Freq	Level	Read Level	Factor	Limit Line	Over Limit	Remark
	MHz	dBm	dBm	dB	dBm	dB	
1	1633.00	-60.67	-68.23	7.56	-13.00	-47.67	Peak
2	pp 2449.50	-52.17	-63.19	11.02	-13.00	-39.17	Peak

Middle Channel



Bureau Veritas Consumer Products Services Ltd., Taoyuan Branch

A D T

Data: 6

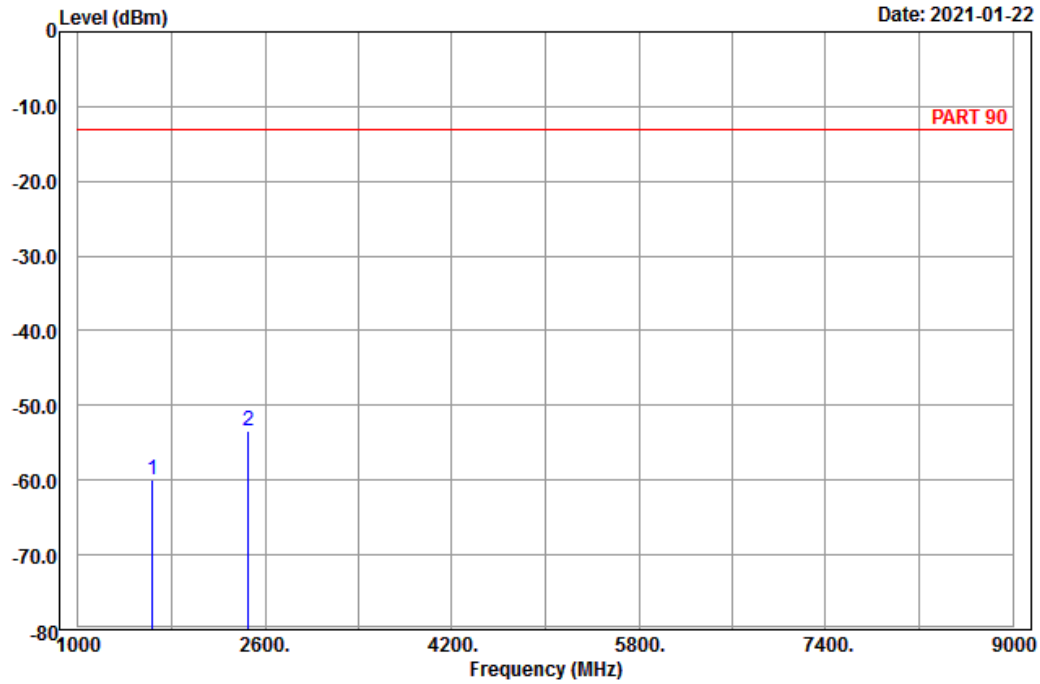

Site : 966 chamber 1  
 Condition: PART 90 Vertical  
 Remark : LTE\_Band 26\_Link\_M-Ch  
 Tested by: Charles Hsiao

	Read	Limit	Over			
Freq	Level	Level	Factor	Line	Limit	Remark
MHz	dBm	dBm	dB	dBm	dB	
1	1638.00	-59.88	-67.44	7.56	-13.00	-46.88 Peak
2 pp	2457.00	-53.35	-64.37	11.02	-13.00	-40.35 Peak



Bureau Veritas Consumer Products Services Ltd., Taoyuan Branch

A D T

Data: 5

Date: 2021-01-22

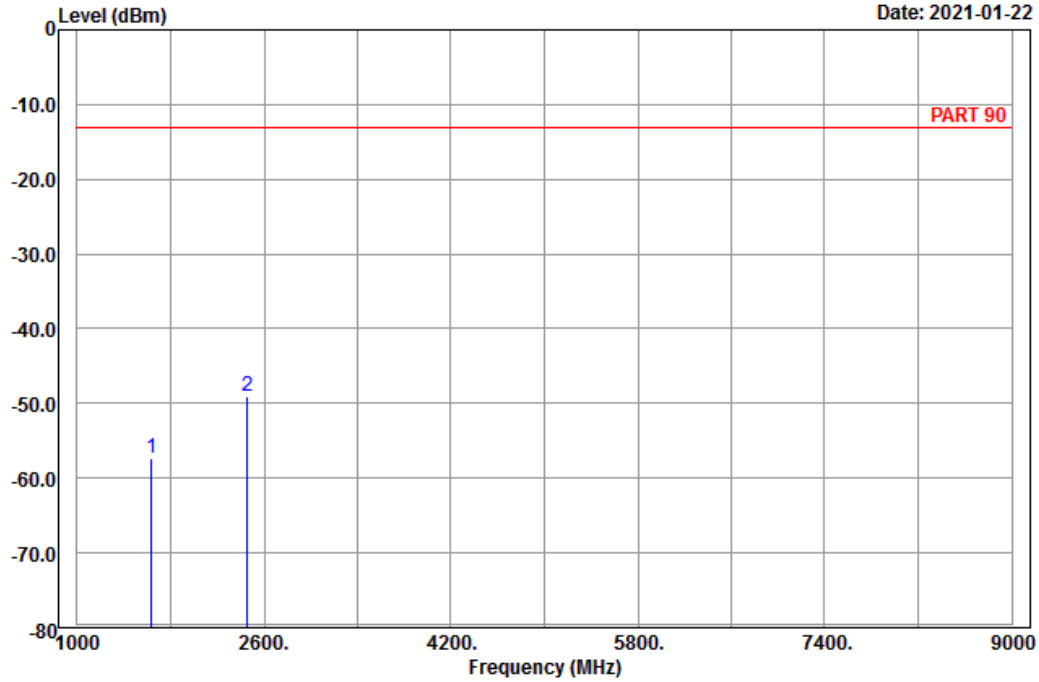

Site : 966 chamber 1  
 Condition: PART 90 Horizontal  
 Remark : LTE\_Band 26\_Link\_M-Ch  
 Tested by: Charles Hsiao

	Freq	Level	Read Level	Factor	Limit Line	Over Limit	Remark
	MHz	dBm	dBm	dB	dBm	dB	
1	1638.00	-57.36	-64.92	7.56	-13.00	-44.36	Peak
2	2457.00	-49.12	-60.14	11.02	-13.00	-36.12	Peak

# High Channel



Bureau Veritas Consumer Products Services Ltd., Taoyuan Branch

A D T

Data: 5

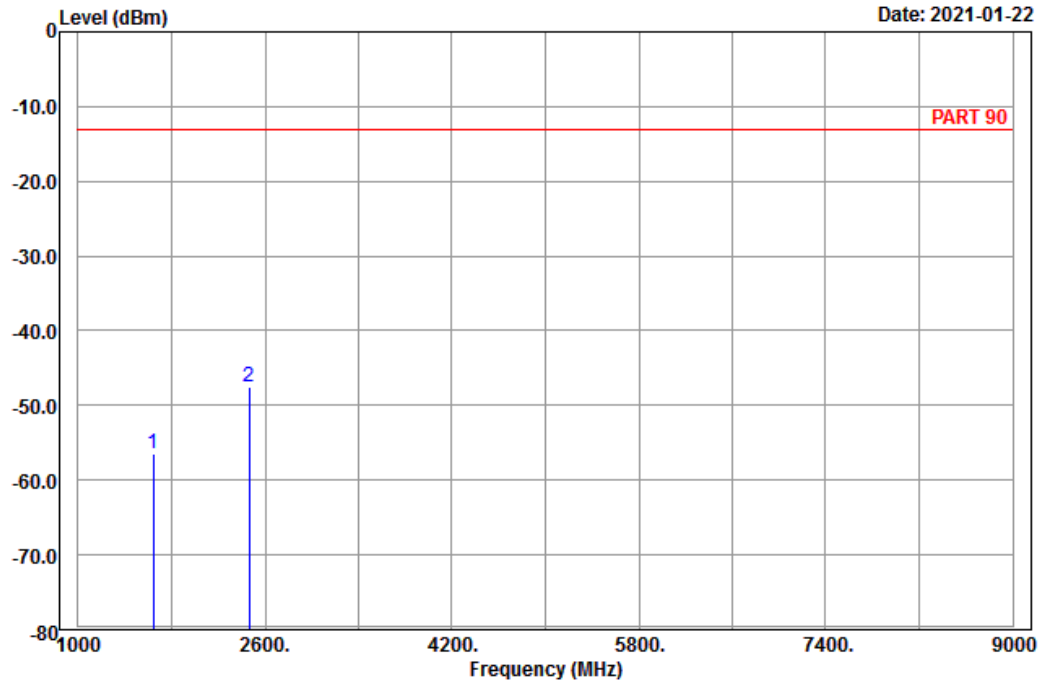

Site : 966 chamber 1  
 Condition: PART 90 Horizontal  
 Remark : LTE\_Band 26\_Link\_H-Ch  
 Tested by: Charles Hsiao

	Freq	Level	Read Level	Factor	Limit Line	Over Limit	Remark
	MHz	dBm	dBm	dB	dBm	dB	
1	1643.00	-56.50	-64.23	7.73	-13.00	-43.50	Peak
2 pp	2464.50	-47.60	-58.62	11.02	-13.00	-34.60	Peak



Bureau Veritas Consumer Products Services Ltd., Taoyuan Branch

A D T

Data: 6

Date: 2021-01-22

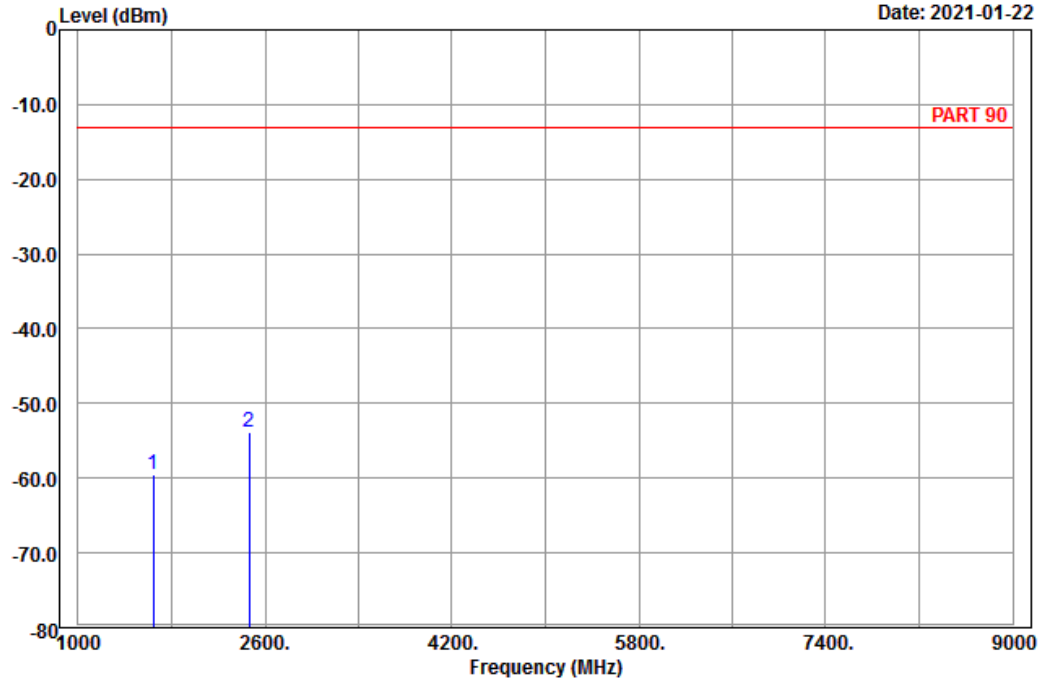

Site : 966 chamber 1  
 Condition: PART 90 Vertical  
 Remark : LTE\_Band 26\_Link\_H-Ch  
 Tested by: Charles Hsiao

	Freq	Level	Read Level	Factor	Limit Line	Over Limit	Remark
	MHz	dBm	dBm	dB	dBm	dB	
1	1643.00	-59.55	-67.28	7.73	-13.00	-46.55	Peak
2	2464.50	-53.84	-64.86	11.02	-13.00	-40.84	Peak



Channel Bandwidth: 10 MHz / QPSK  
Middle Channel



Bureau Veritas Consumer Products Services Ltd., Taoyuan Branch

A D T

Data: 9

Date: 2021-01-22

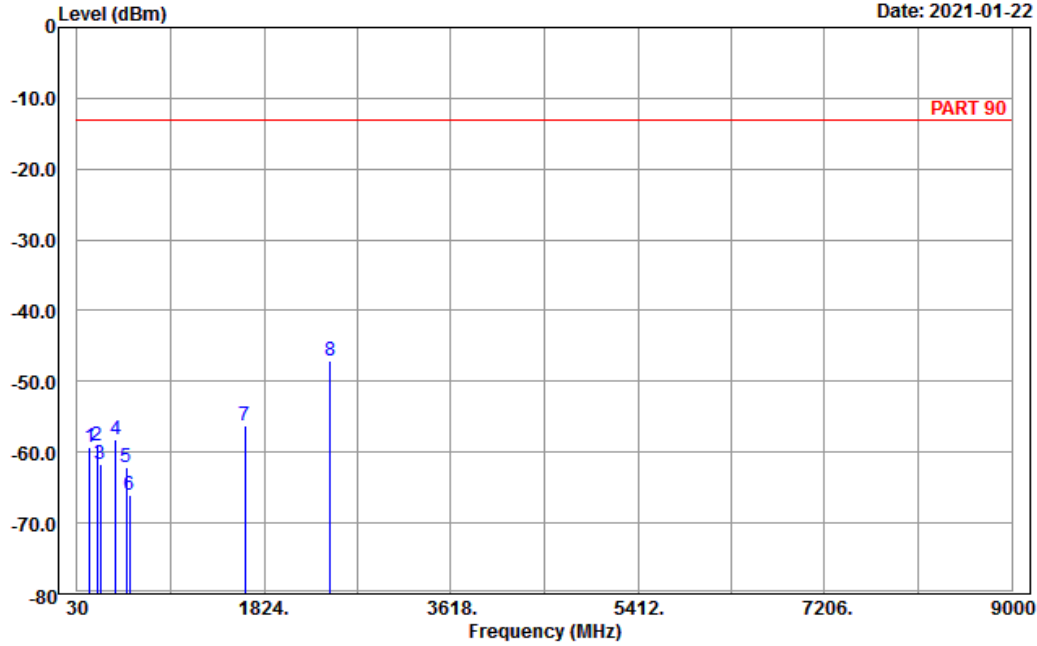

Site : 966 chamber 1  
Condition: PART 90 Horizontal  
Remark : LTE\_Band 26\_Link\_M-Ch  
Tested by: Charles Hsiao

	Freq	Level	Read Level	Factor	Limit Line	Over Limit	Remark
	MHz	dBm	dBm	dB	dBm	dB	
1	153.12	-59.34	-51.48	-7.86	-13.00	-46.34	Peak
2	217.38	-59.12	-53.17	-5.95	-13.00	-46.12	Peak
3	251.13	-61.72	-56.20	-5.52	-13.00	-48.72	Peak
4	398.00	-58.20	-55.36	-2.84	-13.00	-45.20	Peak
5	498.80	-62.04	-56.81	-5.23	-13.00	-49.04	Peak
6	531.70	-66.11	-63.10	-3.01	-13.00	-53.11	Peak
7	1638.00	-56.16	-63.72	7.56	-13.00	-43.16	Peak
8 pp	2457.00	-47.03	-58.05	11.02	-13.00	-34.03	Peak



Bureau Veritas Consumer Products Services Ltd., Taoyuan Branch

A D T

Data: 10

Date: 2021-01-22

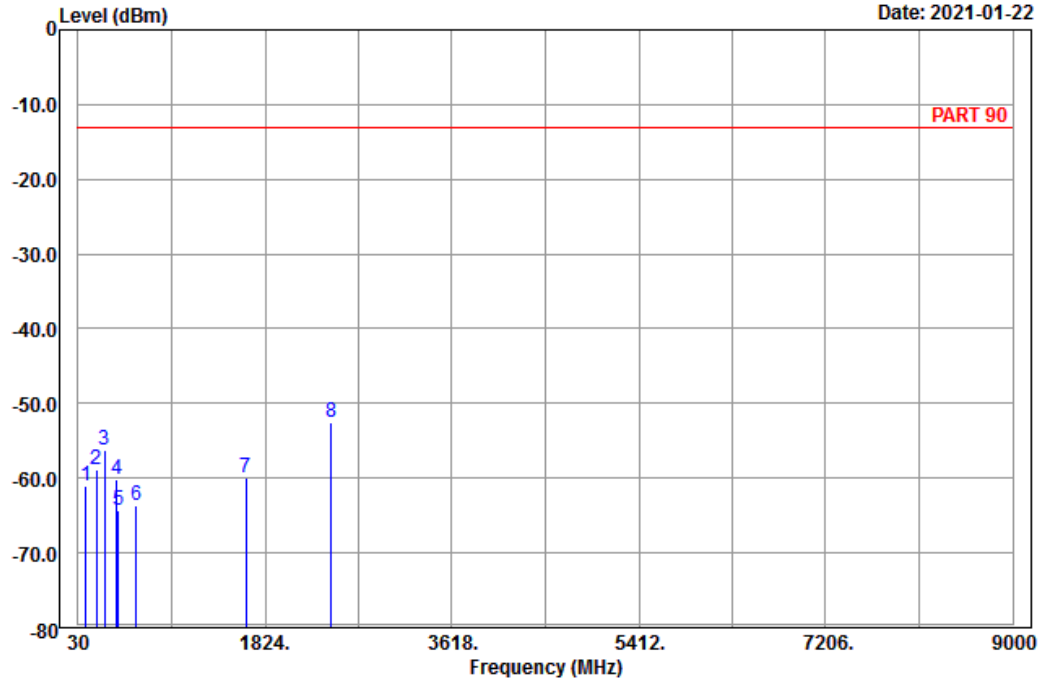

Site : 966 chamber 1  
 Condition: PART 90 Vertical  
 Remark : LTE\_Band 26\_Link\_M-Ch  
 Tested by: Charles Hsiao

	Freq	Level	Read Level	Factor	Limit Line	Over Limit	Remark
	MHz	dBm	dBm	dB	dBm	dB	
1	101.55	-60.99	-51.10	-9.89	-13.00	-47.99	Peak
2	208.47	-58.94	-52.87	-6.07	-13.00	-45.94	Peak
3	279.75	-56.33	-50.56	-5.77	-13.00	-43.33	Peak
4	398.70	-60.15	-57.36	-2.79	-13.00	-47.15	Peak
5	419.00	-64.29	-61.12	-3.17	-13.00	-51.29	Peak
6	585.60	-63.69	-63.51	-0.18	-13.00	-50.69	Peak
7	1638.00	-60.02	-67.58	7.56	-13.00	-47.02	Peak
8 pp	2457.00	-52.61	-63.63	11.02	-13.00	-39.61	Peak

## 5 Pictures of Test Arrangements

Please refer to the attached file (Test Setup Photo).

## Appendix – Information of the Testing Laboratories

We, Bureau Veritas Consumer Products Services (H.K.) Ltd., Taoyuan Branch, were founded in 1988 to provide our best service in EMC, Radio, Telecom and Safety consultation. Our laboratories are FCC recognized accredited test firms and accredited according to ISO/IEC 17025.

If you have any comments, please feel free to contact us at the following:

**Lin Kou EMC/RF Lab**

Tel: 886-2-26052180

Fax: 886-2-26051924

**Hsin Chu EMC/RF/Telecom Lab**

Tel: 886-3-6668565

Fax: 886-3-6668323

**Hwa Ya EMC/RF/Safety**

Tel: 886-3-3183232

Fax: 886-3-3270892

**Email:** [service.adt@tw.bureauveritas.com](mailto:service.adt@tw.bureauveritas.com)

**Web Site:** [www.bureauveritas-adt.com](http://www.bureauveritas-adt.com)

The address and road map of all our labs can be found in our web site also.

--- END ---