

Getac

V110
USER MANUAL

Rugged Mobile Computing Solution

Oct. 2013

TRADEMARKS

All brand and product names are trademarks or registered trademarks of their respective companies.

NOTE

The information in this manual is subject to change without notice. For the latest version of the manual, please visit the Getac website at www.getac.com.

Table of Contents

Chapter 1	Getting Started	1-1
	Getting the Computer Running.....	1-2
	Unpacking.....	1-2
	Connecting to AC Power.....	1-3
	Opening and Closing the Cover.....	1-4
	Operating in Tablet Mode.....	1-5
	Turning On and Off the Computer.....	1-7
	Taking a Look at the Computer.....	1-8
	Front Components.....	1-8
	Rear Components.....	1-10
	Right-Side Components.....	1-11
	Left-Side Components.....	1-12
	Top-open Components.....	1-13
	Bottom Components.....	1-15
	Installing the Accessories.....	1-17
	Attaching the Carrying Strap.....	1-17
	Using the Tether.....	1-18
	Attaching the Handgrip Strap (Optional).....	1-19
Chapter 2	Operating Your Computer	2-1
	Using the Internal Keyboard.....	2-2
	Typewriter Keys.....	2-2
	Cursor-Control Keys.....	2-2
	Numeric Keypad.....	2-3
	Function Keys.....	2-4
	Fn Key.....	2-4
	Hot Keys.....	2-4
	Windows Keys.....	2-6

Using the Touchpad.....	2-7
Configuring the Touchpad.....	2-9
Navigating on the Screen.....	2-10
Using the Touchscreen.....	2-10
Using the Dual Mode Display (Optional).....	2-13
Using the Network Features.....	2-14
Using the LAN.....	2-14
Using the Wireless LAN.....	2-14
Using the BT Feature.....	2-16
Turning On/Off the BT Radio.....	2-16
Connecting to another BT Device.....	2-17
Using the WWAN Feature (Optional).....	2-18
Installing a SIM Card.....	2-18
Turning On/Off the WWAN Radio.....	2-19
Setting up a WWAN Connection.....	2-20
Chapter 3 Managing Power.....	3-1
AC Adapter.....	3-2
Battery Pack.....	3-3
Charging the Battery Pack.....	3-3
Initializing the Battery Pack.....	3-4
Checking the Battery Level.....	3-4
Battery Low Signals and Actions.....	3-5
Replacing the Battery Pack.....	3-6
Power-Saving Tips.....	3-8
Chapter 4 Expanding Your Computer.....	4-1
Connecting an HDMI Display Monitor.....	4-2
Connecting a USB Device.....	4-3
Connecting a Serial Device.....	4-4
Connecting an Audio Device.....	4-5
Using Smart Cards.....	4-6
Using ExpressCards.....	4-7
Replacing the Hard Disk Drive.....	4-9
System Memory Upgrade.....	4-10
Chapter 5 Using BIOS Setup.....	5-1
When and How to Use.....	5-2
Menu Descriptions.....	5-3
Information Menu.....	5-3
Main Menu.....	5-3

	Advanced Menu.....	5-4
	Security Menu	5-5
	Boot Menu	5-6
	Exit Menu	5-6
Chapter 6	Using Getac Software	6-1
	OSD Control Panel	6-2
	G-Manager	6-3
	Getac Camera (Optional).....	6-5
	Getac Smart Tag (Optional).....	6-6
Chapter 7	Caring for the Computer	7-1
	Protecting the Computer.....	7-2
	Using an Anti-Virus Strategy.....	7-2
	Using the Cable Lock	7-2
	Taking Care of the Computer	7-3
	Location Guidelines	7-3
	General Guidelines	7-4
	Cleaning Guidelines.....	7-4
	Battery Pack Guidelines.....	7-5
	Touchscreen Guidelines.....	7-6
	When Traveling.....	7-7
Chapter 8	Troubleshooting	8-1
	Preliminary Checklist.....	8-2
	Solving Common Problems.....	8-3
	Battery Problems	8-3
	BT Problems.....	8-3
	Display Problems.....	8-4
	Hardware Device Problems	8-5
	Hard Disk Drive Problems.....	8-5
	Keyboard and Touchpad Problems	8-5
	LAN Problems.....	8-6
	Power Management Problems	8-6
	Software Problems	8-7
	Sound Problems	8-7
	Startup Problems	8-7
	Wireless LAN Problems.....	8-8
	Other Problems	8-9
	Resetting the Computer	8-10
	System Recovery.....	8-11

System Restore, Refresh, or Reset (for Windows 8 Models)..... 8-11
System Recovery (a Tool for Windows 7 Models)..... 8-12

Appendix A Specifications A-1

Appendix B Regulatory Information..... B-1

On the Use of the System B-2
 Class B Regulations B-2
 ANSI Warning..... B-3
 Safety Notices..... B-4
On the Use of the RF Device..... B-6
 USA and Canada Safety Requirements and Notices..... B-6
 European Union CE Marking and Compliance Notices.... B-8

Chapter 1

Getting Started

Congratulations on purchasing this rugged computer.

This chapter first tells you step by step how to get the computer up and running. Then, you will find a section briefly introducing the external components of the computer.

Getting the Computer Running

Unpacking

After unpacking the shipping carton, you should find these standard items:

- Notebook computer
- Accessories:
 - AC adapter
 - AC power cord
 - Stylus or digitizer pen (optional)
 - Tether
 - Carrying Strap
 - AG/AR (anti-glare/anti-reflection) film, which is already attached to the screen
 - Screen cleaning cloth
 - Driver disc
 - Document(s)

Inspect all the items. If any item is damaged or missing, notify your dealer immediately.

Connecting to AC Power

It is suggested that you use AC power when you start up the computer for the very first time.

1. Plug the DC cord of the AC adapter to the power connector of the computer (❶).
2. Plug the female end of the AC power cord to the AC adapter and the male end to an electrical outlet (❷).

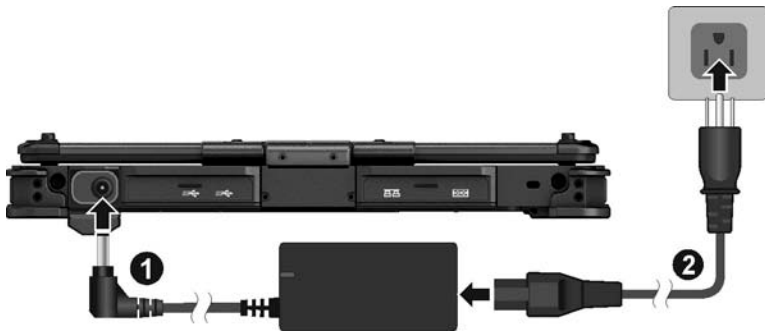

3. Power is being supplied from the electrical outlet to the AC adapter and onto your computer. Now, you are ready to turn on the computer.

CAUTION: Use only the AC adapter included with your computer. Using other AC adapters may damage the computer.

NOTE: When the AC adapter is connected, it also charges the battery pack. For information on using battery power, see Chapter 3.

Opening and Closing the Cover

To open the top cover:

1. Pull loose the cover latch (❶) and release the clamp (❷).
2. Lift up the cover (❸). You can tilt the cover forward or backward for optimal viewing clarity.



To close the top cover:

1. Close the display.
2. Lift the cover latch and engage the clamp on the display. Then, push in the cover latch to click it into place.

Operating in Tablet Mode

In addition to being used as a regular notebook computer (Laptop mode), your computer can also be operated in Tablet mode. In Tablet mode, you operate the computer with a stylus or digitizer pen, or a fingertip, instead of a keyboard or mouse.

1. Open the top cover so that it is almost perpendicular with the keyboard of the computer.
2. Turn the display counter-clockwise by 180°.



CAUTION: The allowed rotation range is between counter-clockwise by 180° and clockwise by 45°. Do not force beyond the limitation.

3. Close the computer with the display facing up.



4. Lift the cover latch and engage the clamp on the display. Then, push in the cover latch to click it into place.

Turning On and Off the Computer

Turning On

Press the power button (). The Windows operating system should start.

Turning Off

When you finish a working session, you can stop the system by turning off the power or leaving it in Sleep or Hibernation mode:

To...	Do this...	
	Windows 8	Windows 7
Power off (Shutdown)	<ol style="list-style-type: none">1. Open the Charms Bar of Windows 8 by swiping in from the right side of the screen.2. Tap Settings and then tap  (Power).3. Tap Shut down in the Power menu that pops up.	Use the Windows Start menu in the lower left and follow the shutdown procedure.
Sleep	Press the power button* or use the Power menu to put the computer in Sleep mode.	Press the power button* or use the Windows Start menu to put the computer in Sleep mode.
Hibernate	By default, this option is not shown in the Power menu. If you want to use the feature, set up according in Windows Control Panel .	Use the Windows Start menu to put the computer in Hibernation mode.

* "Sleep" is the default setting of the power button. You may change what the power button does in Windows **Control Panel**.

Taking a Look at the Computer



NOTE: Depending on the model you purchased, the appearance of your computer may not be exactly the same as those shown in this manual.

CAUTION: You need to open the protective covers to access the connectors. When not using a connector, make sure to close the cover completely for water- and dust-proof integrity. (Engage the locking mechanism if existing.)

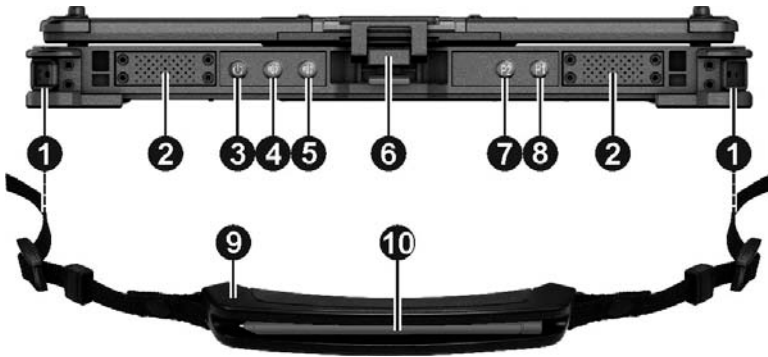
Front Components



Ref	Component	Description	See Also
❶	Strap Holder	Two buckles hold the carrying strap.	P. 1-17
❷	Stereo Speaker	Sends out sound and voice from your computer.	
❸	Power Button	Turns the power on or off. (The default "off" state is "Sleep mode.")	P. 1-7
❹	🔊 Up Button	Increases the sound volume.	
		When Function Lock is on: Increases the LCD brightness.	

Ref	Component	Description	See Also
5	 Down Button	Decreases the sound volume.	
		When Function Lock is on: Decreases the LCD brightness.	
6	Top Cover Latch	Locks the top cover.	P. 1-4
7	P2 Button	Starts the Getac Camera program and serves as the shutter release button.	P. 6-6
		When Function Lock is on: Enables or disables the touchscreen feature.	
8	P1 Button	Switches on or off Function Lock (FL) , which changes the P2 , Up , and Down buttons to an alternative function. When FL is on, the  icon appears on Windows taskbar.	
		When pressed longer: Serves as the Ctrl+Alt+Del keyboard keys.	P. 8-10
		Can be changed to another set of predefined functions using the Button Manager utility.	
9	Carrying Strap	Provides a convenient way to carry the computer.	P. 1-17
10	Stylus / Digitizer pen	Serves as the input device by tapping on the touchscreen to make selections and enter information.	P. 2-2

Rear Components



To access a connector, open its protective cover by lifting up the tab of the cover. When closing the cover, push the tab downward until the cover clicks into place.

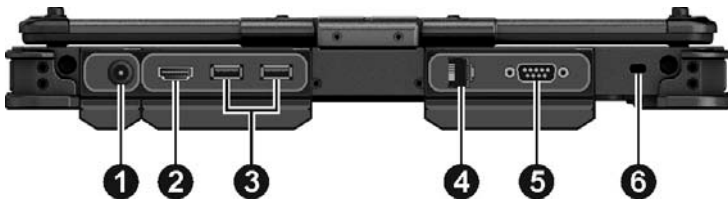

Ref	Component	Description	See Also
❶	Power Connector	Connects the AC adapter.	P. 1-3
❷	HDMI Connector	Connects a HDMI monitor or TV set.	P. 4-2
❸	USB 3.0 Port	Connects a USB device, such as a flash disk, printer, digital camera, joystick, and more.	P. 4-3
❹	RJ-45 Connector	Connects the LAN cable.	P. 2-14
❺	Serial Port	Connects a serial device.	P. 4-3
❻	Kensington Lock	Locks the computer to a stationary object for security.	P. 7-2

Right-Side Components



To access a connector, open its protective cover by lifting up the tab of the cover. When closing the cover, push the tab downward until the cover clicks into place.

To access a device bay, slide the cover latch toward the unlocked position (🔓) and then lift up the tab to release the cover. When closing the cover, push the tab downward until the cover clicks into place and then slide the latch toward the locked position (🔒).

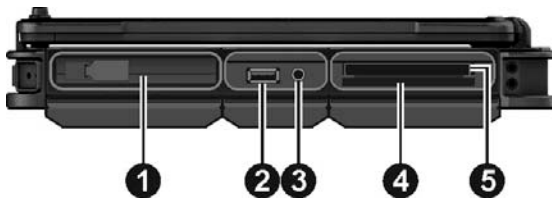

Ref	Component	Description	See Also
❶	Battery Pack	Inside is the battery pack (Battery 2) that supplies power to your computer when external power is not connected.	P. 3-3
❷	USB 2.0 Port	Connects a USB device, such as a flash disk, printer, digital camera, joystick, and more.	P. 4-3
❸	Combo Audio Connector	Connects a set of headphones or external speakers with amplifier	P. 4-5
		Supports a headset microphone with 4-pole TRRS 3.5mm jack.	
❹	Smart Card Slot	Accepts a smart card for additional security feature.	P. 4-6

Ref	Component	Description	See Also
5	ExpressCard Slot	Accepts an ExpressCard for additional functions.	P. 4-7

Left-Side Components

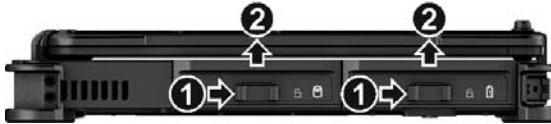

To access a device bay, slide the cover latch toward the unlocked position (🔓) and then lift up the tab to release the cover. When closing the cover, push the tab downward until the cover clicks into place and then slide the latch toward the locked position (🔒).

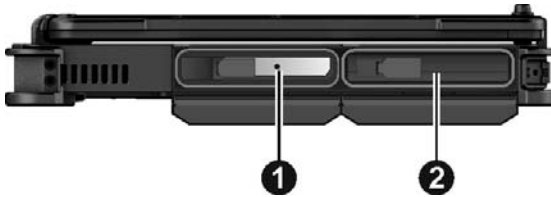





Ref	Component	Description	See Also
1	Hard Disk Drive	Inside is the hard disk drive.	P. 4-9
2	Battery Pack	Inside is the battery pack (Battery 1) that supplies power to your computer when external power is not connected.	P. 3-3

Top-open Components



Ref	Component	Description	See Also
①	RFID Antenna (optional)	Scans and reads RFID (Radio-frequency identification) tags.	P. 6-6
②	Touchscreen	Displays and receives information for the computer.	P. 2-10
③	Camera Lens (optional)	Allows you to use your computer's camera function. When the camera lens is in use, the LED beside it lights up.	P. 6-5
④	Microphone	Receives sound and voice to record voice.	

Ref	Component	Description	See Also
5	Light Sensor	Detects the surrounding lighting condition for automatic adjustment of the LCD brightness and optional keyboard backlight.	
6	Windows Logo Button	For Windows 8: Goes to the Start screen. Or if you're already on Start, pressing this button brings you to the last application you were in.	
		For Windows 8 (when pressed longer): Opens or closes the OSD Control Panel.	P. 6-2
		For Windows 7: Opens or closes the OSD Control Panel.	P. 6-2
7	Indicators	Show the current status of the computer's devices.	
	 Power	Lights green when the computer is turned on.	P. 1-7
		Blinks green when the computer is in Sleep mode.	
	 Battery Charge	Lights green when the battery is fully charged.	P. 3-3
		Lights amber when the battery is being charged.	
		Blinks red when the battery's capacity is below 10%.	P. 3-5
		Blinks amber when the battery charging is in an abnormal state. Replace the battery in case this happens.	
 Hard Disk Drive In-Use	Lights green when the computer is accessing the hard disk drive.		
 Caps Lock	Lights green when Caps Lock is on.	P. 2-2	

Ref	Component	Description	See Also
	 RF (Radio Frequency)	Lights green when the RF radio of any RF feature (WLAN/BT/WWAN) is on.	
8	Keyboard	Serves as the data input device.	P. 2-2
9	Touchpad	Serves as the pointing device.	P. 2-7

Bottom Components

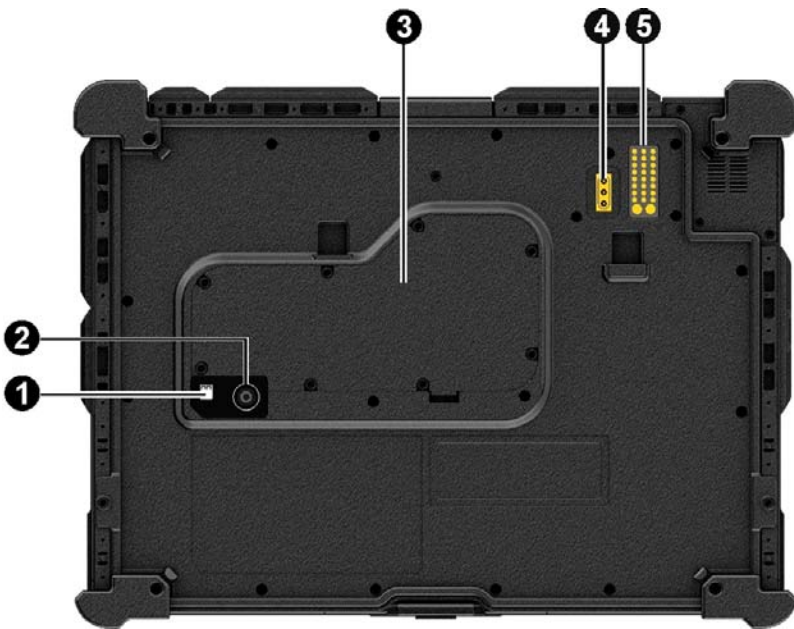

Ref	Component	Description	See Also
1	Camera Indicator (optional)	Lights up when the camera lens beside it is in use.	
	Flash (optional)	Provides extra light when taking pictures.	
2	Camera Lens (optional)	Allows you to use the camera function.	P. 6-5

Ref	Component	Description	See Also
③	Memory Slots	Inside are the memory slots for expanding the memory size of your computer.	P. 4-9
	SIM Card Slot (optional)	Inside is the SIM card slot.	P. 2-18
④	Antenna Pass-through (optional)	Connects to the docking station for using external WWAN/GPS/WLAN antenna. Can be tri type or dual type (WWAN+GPS or WLAN+GPS) depending on your model.	
⑤	Docking Connector	Inside is the docking connector for connecting an office dock or vehicle dock (purchased separately).	

Installing the Accessories

Attaching the Carrying Strap

Insert one end of the strap into one strap holder (❶) on your computer and feed it through the slider buckle (❷). Use the fastener (❸) to fix the strap end in place. Secure the other end of the strap to the computer in the same way.



The strap provides a slot for storing the stylus or digitizer pen (❹).

Using the Tether

A tether is provided for attaching the stylus to your computer.

1. Insert one of the tether's loop ends through the hole of the stylus (as indicated by ❶ below). Then, insert the other end through the first loop (as indicated by ❷ below) and pull it tight.



2. Insert the other loop end to the strap holder on computer (as indicated by ❶ below). Then, insert the stylus end through the loop (as indicated by ❷ below) and pull it tight.

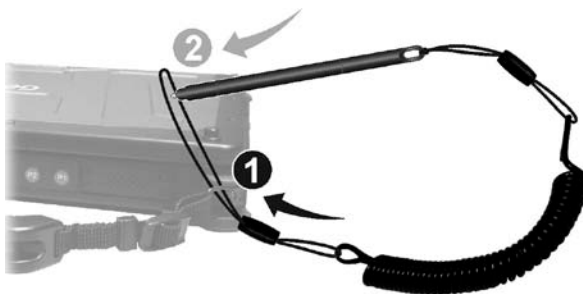

Attaching the Handgrip Strap (Optional)

To use the handgrip strap, attach its four loops to the four bottom hooks on your computer. Make sure the loops are securely hooked.



When you need to operate and hold your computer at the same time, insert your hand through the strap for a firm grip.

Chapter 2

Operating Your Computer

This chapter provides information about the use of the computer.

If you are new to computers, reading this chapter will help you learn the operating basics. If you are already a computer user, you may choose to read only the parts containing information unique to your computer.

CAUTION:

- Do not expose your skin to the computer when operating it in a very hot or cold environment.
- The computer can get uncomfortably warm when you use it in high temperatures. As a safety precaution in such a circumstance, do not place the computer on your lap or touch it with your bare hands for extended periods of time. Prolonged body contact can cause discomfort and potentially a burn.

Using the Internal Keyboard

Your keyboard has all the standard functions of a full-sized computer keyboard plus an **Fn** key added for specific functions.

The standard functions of the keyboard can be further divided into four major categories:

- Typewriter keys
- Cursor-control keys
- Numeric keys
- Function keys

Typewriter Keys

Typewriter keys are similar to the keys on a typewriter. Several keys are added such as the **Ctrl**, **Alt**, **Esc**, and lock keys for special purposes. When the lock keys (**Caps Lock** and **Num Lk**) are pressed, their corresponding indicators light up.

The Control (**Ctrl**) / Alternate (**Alt**) key is normally used in combination with other keys for program-specific functions. The Escape (**Esc**) key is usually used for stopping a process. Examples are exiting a program and canceling a command. The function depends on the program you are using.

Cursor-Control Keys

Cursor-control keys are generally used for moving and editing purposes.

NOTE: The word “cursor” refers to the indicator on the screen that lets you know exactly where on your screen anything you type will appear. It can take the form of a vertical or horizontal line, a block, or one of many other shapes.

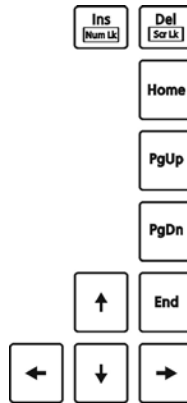

Numeric Keypad

A 15-key numeric keypad is embedded in the typewriter keys as shown next:

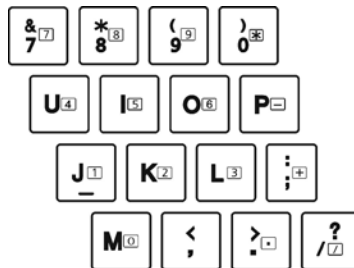

Numeric keys facilitate entering of numbers and calculations. When Num Lock is on, the numeric keys are activated; meaning you can use these keys to enter numerals.

NOTE:

- When the numeric keypad is activated and you need to type the English letter in the keypad area, you can turn Num Lock off or you can press Fn and then the letter without turning Num Lock off.
- Some software may not be able to use the numeric keypad on the computer. If so, use the numeric keypad on an external keyboard instead.

Function Keys

On the top row of the keys are the function keys: **F1** to **F12**. Function keys are multi-purpose keys that perform functions defined by individual programs.









Fn Key

















The **Fn** key, at the lower left corner of the keyboard, is used with another key to perform the alternative function of a key. The letter “Fn” and the alternative functions are identified by the color of blue on the keytop. To perform a desired function, first press and hold **Fn**, then press the other key.

Hot Keys



Hot keys refer to a combination of keys that can be pressed any time to activate special functions of the computer. Most hot keys operate in a cyclic way. Each time a hot key combination is pressed, it shifts the corresponding function to the other or next choice.



You can easily identify the hot keys with the icons imprinted on the keytop. The hot keys are described next.

Key	Description
 	Switches the keyboard backlight on and off (option).
 	Switches the RF (radio frequency) radio on and off. When off, all wireless modules (such as WLAN, BT, and WWAN) cannot be used. When on, individual settings of the module work.
 	Decreases the sound volume.
 	Increases the sound volume.

Key	Description
 	<p>Switches the display output to the next choice if an external display is connected. Choices are:</p> <pre> graph TD A[LCD only] --> B[LCD + External display Duplicate] B --> C[LCD + External display Extend] C --> D[External display only] </pre> <p>The hot keys are equivalent to  Windows logo key + P.</p>
 	Decreases the LCD brightness.
 	Increases the LCD brightness.
 	Switches the touchscreen on or off (option).
 	Switches the touchpad off or on.
 	Switches the system sound output off (mute) or on.
 	Switches the display on or off.
 	Serves as the sleep button that you can define with Windows' Power Options .

Windows Keys

The keyboard has two keys that perform Windows-specific functions:  Windows Logo key and  Application key.

The  Windows Logo key opens the **Start** menu and performs software-specific functions when used in combination with other keys. The  Application key usually has the same effect as a right mouse click.

Using the Touchpad

CAUTION: Do not use a sharp object such as a pen on the touchpad. Doing so may damage the touchpad surface.

NOTE:

- Press **Fn+F9** to toggle the touchpad on or off.
- For optimal performance of the touchpad, keep your fingers and the pads clean and dry. When tapping on the pad, tap lightly. Do not use excessive force.

The touchpad is a pointing device that allows you to communicate with the computer by controlling the location of the pointer on the screen and making selection with the buttons.







The touchpad consists of a rectangular pad (work surface) and a left and right buttons. To use the touchpad, place your forefinger or thumb on the pad. The rectangular pad acts like a miniature duplicate of your display. As you slide your fingertip across the pad, the pointer (also called cursor) on the screen moves accordingly. When your finger reaches the edge of the pad, simply relocate yourself by lifting the finger and placing it on the other side of the pad.

Here are some common terms that you should know when using the touchpad:

Term	Action
Point	Move your finger on the pad until the cursor points to the selection on the screen.
Click	Press and release the left button. –or– Tap gently anywhere on the pad.
Double-click	Press and release the left button twice in quick succession. –or– Tap twice on the pad rapidly.
Drag and drop	Press and hold the left button, then move your finger until you reach your destination (drag). Finally, release the button (drop) when you finish dragging your selection to the destination. The object will drop into the new location. –or– Gently tap twice on the pad and on the second tap, keep your finger in contact with the pad. Then, move your finger across the pad to drag the selected object to your destination. When you lift your finger from the pad, the selected object will drop into place.

The touchpad also supports the core touch gestures for Windows 8 as described below.

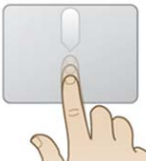
Gestures	Actions	Descriptions
Two-finger slide		Horizontal or vertical scroll

Gestures	Actions	Descriptions
Two-finger pinch		Zoom
Swipe in from the right edge		Open the Charms bar.
Swipe down from the top edge		Perform the same function as a right-click.
Swipe in from the left edge		Switch to the previous application.

Configuring the Touchpad

You may want to configure the touchpad to suit your needs. For example, if you are a left-handed user, you can swap the two buttons so that you can use the right button as the left button and vice versa. You can also change the size of the on-screen pointer, the speed of the pointer, and so on.

To configure the touchpad, go to **Control Panel**-

Navigating on the Screen

The screen of your computer is touch-sensitive. You can control the location of the cursor/pointer on the screen using the included stylus/digitizer pen or your finger to communicate with the computer.

CAUTION: Do not use a sharp object such as a ballpoint pen or pencil on the touchscreen. Doing so may damage the touchscreen surface. Use the included stylus/digitizer pen or your finger.

NOTE: An AG/AR film has been attached to the screen before shipment. The film is a consumable, which will be worn out by possible scratches. You can purchase a new one when replacement is required.

Using the Touchscreen

NOTE: Instead of a hard tip, your stylus has a soft tip so that it does not scratch the AG/AR film. It is normal for the soft tip to wear out after a long period of use. You can purchase a new one when needed.





The following table shows how you use the touchscreen to obtain equivalent mouse functions.

Term/Action	Equivalent Mouse Function
Tap: Touch the screen once.	Click/Point
Double-tap: Touch the screen twice rapidly.	Double-click
Tap and hold: Tap and hold until a popup menu appears.	Right-click
Drag: Hold the stylus (or finger) on the screen and drag across the screen until reaching your destination.	Drag

Using Multi-touch Gestures

You can interact with your computer by placing two fingers on the screen. The movement of the fingers across the screen creates “gestures,” which send commands to the computer.

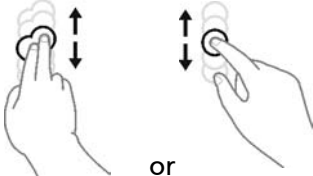
Here are the multi-touch gestures that you can use:

Gestures	Actions (○ = finger down; ◉ = finger up)	Descriptions
Pan (Scroll)	 <p>Drag 1 or 2 fingers up or down.</p>	Use panning to see another part of a page that has scroll bars.
Zoom (Pinch)	 <p>Move two fingers apart/toward each other.</p>	Use zooming to make an item (a photo for example) on the screen larger or smaller. The gesture works in applications that support mouse wheel zooming.

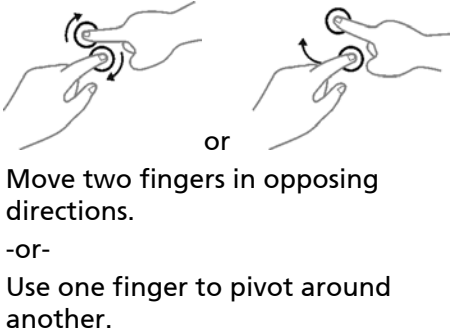
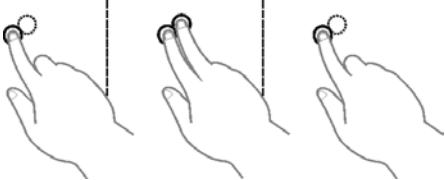
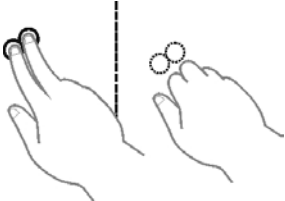
Gestures	Actions (○ = finger down; ◉ = finger up)	Descriptions
Rotate	 <p>Move two fingers in opposing directions. -or- Use one finger to pivot around another.</p>	Use rotating to move a picture or other item on the screen in a circular direction (clockwise or counter-clockwise). The gesture works in applications that support the specific gesture.
Press and Tap	 <p>Press on target and tap using a second finger.</p>	Use press and tap to access the shortcut menu.
Two-finger Tap	 <p>Tap two fingers at the same time (where the target is in the midpoint between the fingers).</p>	The function is defined by applications that support the specific gesture.

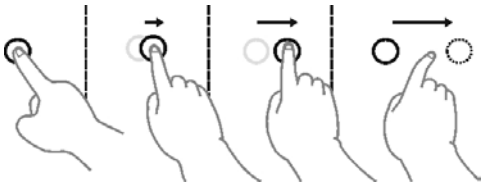
Gestures	Actions (○ = finger down; ◉ = finger up)	Descriptions
Flicks	 <p data-bbox="247 437 650 496">Make quick drag gestures in the desired direction.</p>	<p data-bbox="736 252 1031 504">Flick left or right to navigate back and forward in a browser and other applications. The gesture works in most applications that support back and forward.</p>

Using the Dual Mode Display (Optional)

Dual mode display (if your model has the feature) incorporates both touchscreen and digitizer functions.

The display is set to Touchscreen mode by default. Touchscreen mode provides all the functionalities that an ordinary touchscreen has. When the computer receives signals from the digitizer pen, the display automatically switches to Digitizer mode.



You can move the cursor by bringing the digitizer pen close to the screen, without actually touching the screen's surface.

Using the Network Features

Using the LAN

To connect the network cable to the LAN module, connect one end of the LAN cable to the RJ-45 connector on the computer and the other end to the network hub.



Using the Wireless LAN

The WLAN module of your computer supports IEEE 802.11 a/b/g/n/ac.

Turning On/Off the WLAN Radio

To turn on the WLAN radio:

1. Make sure that the Airplane mode is switched off. You can control the Airplane mode using one of the below methods.
 - Press **Fn+F1**.
 - Use the **Airplane Mode** button in the OSD Control Panel.
 - **For Windows 8:** Open the Charms Bar, tap **Settings** → **Change PC Settings** → **Wireless**. Slide the **Airplane mode** switch to the **Off** position.
2. If you have previously turned off the WLAN radio, use one of the below methods to turn it on.
 - **For Windows 8:** Open the Charms Bar of Windows. Tap **Settings** → **Change PC Settings** → **Wireless**. Slide the **Wi-Fi** switch to the **On** position.

- **For Windows 7:** Use either Windows Mobility Center or Getac Quick Bar. To open Getac Quick Bar, tap and hold the Getac Utility icon  on Windows taskbar and select **Quick Bar**. Tap the WLAN button in the Quick Bar (an X over the button means the radio is currently off).

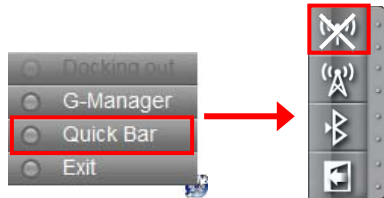



To turn off the WLAN radio:

You can turn off the WLAN radio the same way you turn it on.

If you want to quickly turn off all wireless radio, simply switch on Airplane mode.

Connecting to a WLAN Network

1. Make sure that the WLAN function is enabled (as described above).
2. **For Windows 8:** Open the Charms Bar of Windows. Tap **Settings** and then tap .

For Windows 7: Tap the Wireless Network icon  on the taskbar. (An orange light in the icon  indicates connections are available.)

3. In the list of available wireless networks, tap a network, and then tap **Connect**.
4. Some networks require a network security key or passphrase. To connect to one of those networks, ask your network administrator or Internet service provider (ISP) for the security key or passphrase.

For more information on setting a wireless network connection, refer to Windows online help.

NOTE: You can use Intel® PROSet Wireless to take full advantage of the Wi-Fi capabilities of your computer. See the Help of the utility for instructions.

Using the BT Feature

The BT 4.0 technology allows short-range (about 50 meters) wireless communications between devices without requiring a cable connection. Data can be transmitted through walls, pockets and briefcases as long as two devices are within range.

Turning On/Off the BT Radio

To turn on the BT radio:

1. Make sure that the Airplane mode is switched off. You can control the Airplane mode using one of the below methods.
 - Press **Fn+F1**.
 - Use the **Airplane Mode** button in the OSD Control Panel.
 - **For Windows 8:** Open the Charms Bar, tap **Settings** → **Change PC Settings** → **Wireless**. Slide the **Airplane mode** switch to the **Off** position.
2. If you have previously turned off the BT radio, use one of the below methods to turn it on.
 - **For Windows 8:** Open the Charms Bar of Windows. Tap **Settings** → **Change PC Settings** → **Wireless**. Slide the BT switch to the **On** position.
 - **For Windows 7:** Use Getac Quick Bar. To open Getac Quick Bar, tap and hold the Getac Utility icon  on Windows taskbar and select **Quick Bar**. Tap the BT button in the Quick Bar (an X over the button means the radio is currently off).

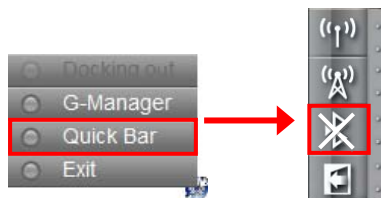

To turn off the BT radio:

You can turn off the BT radio the same way you turn it on.

If you want to quickly turn off all wireless radio, simply switch on Airplane mode.

Connecting to another BT Device

1. Make sure that the BT function is enabled (as described above).
2. Make sure that the target BT device is turned on, discoverable and within close range. (See the documentation that came with the BT device.)
3. **For Windows 8:** Open the Charms Bar of Windows. Tap **Settings** → **Change PC Settings** → **Devices**. Tap **Add a device**.
For Windows 7: Tap and hold the BT icon on Windows taskbar. Tap **Add a Device**.
4. Select the device you want to connect from the search results.
5. Depending on the type of BT device that you want to connect to, you will need to enter the pertinent information.

For detailed information on using the BT feature, see Windows' online Help.

Using the WWAN Feature (Optional)

A WWAN (Wireless Wide Area Network) uses mobile telecommunication cellular network technologies to transfer data. The WWAN module of your computer supports 3G and 4G LTE.

NOTE: Your model only supports data transmission. Voice transmission is not supported.

Installing a SIM Card

1. Turn off the computer and disconnect the AC adapter.
2. Carefully place the computer upside down.
3. Remove the 8 screws to open the compartment cover.

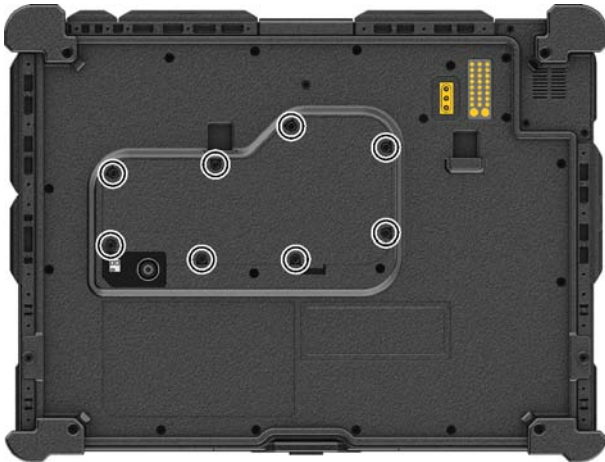

4. Locate the SIM card slot.

Slide the locking tab of the SIM card slot inward to unlock. Lift the slot up and, noting the orientation, insert the SIM card into the slot. Close the slot and slide the locking tab outward to secure the card in place.

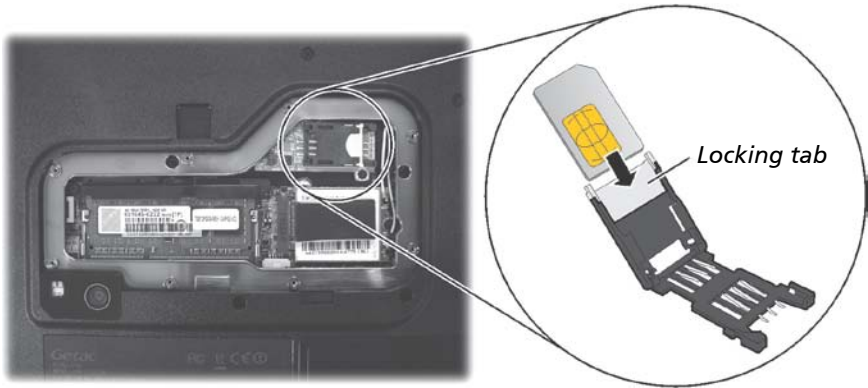

5. Close the compartment cover and secure with 8 screws.

Turning On/Off the WWAN Radio

To turn on the WWAN radio:

1. Make sure that the Airplane mode is switched off. You can control the Airplane mode using one of the below methods.
 - Press **Fn+F1**.
 - Use the **Airplane Mode** button in the OSD Control Panel.
 - **For Windows 8:** Open the Charms Bar, tap **Settings** → **Change PC Settings** → **Wireless**. Slide the **Airplane mode** switch to the **Off** position.
2. If you have previously turned off the WWAN radio, use one of the below methods to turn it on.
 - **For Windows 8:** Open the Charms Bar of Windows. Tap **Settings** → **Change PC Settings** → **Wireless**. Slide the **Mobile Broadband** switch to the On position.
 - **For Windows 7:** Use the WWAN utility software or Getac Quick Bar. To open Getac Quick Bar, tap and hold the Getac Utility icon  on Windows taskbar and select **Quick Bar**. Tap the WWAN button in the Quick Bar (an X over the button means the radio is currently off).

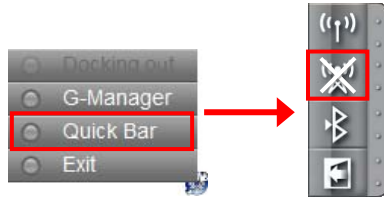

To turn off the WWAN radio:

You can turn off the WWAN radio the same way you turn it on.

If you want to quickly turn off all wireless radio, simply switch on Airplane mode.

Setting up a WWAN Connection

1. Make sure that the SIM card is inserted and the WWAN function is enabled (as described above).
2. Start the WWAN utility software (**AirCard Watcher**). The screen as below appears.



3. You can use the WWAN utility software to configure and use WWAN connections. See the online help for information.

Chapter 3

Managing Power

Your computer operates either on external AC power or on internal battery power.

This chapter tells you how you can effectively manage power. To maintain optimal battery performance, it is important that you use the battery in the proper way.

AC Adapter

CAUTION:

- The AC adapter is designed for use with your computer only. Connecting the AC adapter to another device can damage the adapter.
- The AC power cord supplied with your computer is for use in the country where you purchased your computer. If you plan to go overseas with the computer, consult your dealer for the appropriate power cord.
- When you disconnect the AC adapter, disconnect from the electrical outlet first and then from the computer. A reverse procedure may damage the AC adapter or computer.
- When unplugging the connector, always hold the plug head. Never pull on the cord.

The AC adapter serves as a converter from AC (Alternating Current) to DC (Direct Current) power because your computer runs on DC power, but an electrical outlet usually provides AC power. It also charges the battery pack when connected to AC power.

The adapter operates on any voltage in the range of 100~240 V AC.

Battery Pack

Your computer has two battery packs. The battery pack is the internal power source for the computer. It is rechargeable using the AC adapter.

NOTE: Care and maintenance information for the battery is provided in the “Battery Pack Guidelines” section in Chapter 7.

Charging the Battery Pack

NOTE:

- Charging will not start if the battery’s temperature is outside the allowed range, which is between 0 °C (32 °F) and 50 °C (122 °F). Once the temperature meets the requirements, charging automatically resumes.
- During charging, do not disconnect the AC adapter before the battery has been fully charged; otherwise you will get a prematurely charged battery.

To charge the battery pack, connect the AC adapter to the computer and an electrical outlet. The Battery Charge Indicator (🔋) on the computer glows amber to indicate that charging is in progress. You are advised to keep the computer power off while the battery is being charged. When the battery is fully charged, the Battery Charge Indicator glows green.

The two battery packs are charged in parallel. It takes approximately 5 hours to fully charge the two battery packs when the power is off and approximately 6 hours when the power is on (may need a longer charging time at lower temperatures).

CAUTION: After the computer has been fully recharged, do not immediately disconnect and reconnect the AC adapter to charge it again. Doing so may damage the battery.

NOTE: The battery level may automatically lessen due to the self-discharge process (0.21% per day), even when the battery pack is fully charged (100%). This happens no matter if the battery pack is installed in the computer.

Initializing the Battery Pack

You need to initialize a new battery pack before using it for the first time or when the actual operating time of a battery pack is much less than expected. Initializing is the process of fully charging, discharging, and then charging. It can take several hours.

A software tool called “Gauge Reset” is provided for the purpose. Use the G-Manager program and select the **Battery** tab to find the tool.

Checking the Battery Level

NOTE: Any battery level indication is an estimated result. The actual operating time can be different from the estimated time, depending on how you are using the computer.

The operating time of a fully charged battery pack depends on how you are using the computer. When your applications often access peripherals, you will experience a shorter operating time.

The two battery packs are discharged in parallel.

By Operating System

You can check the approximate battery level using the battery meter function of the operating system. To read the battery level in Windows, tap the battery icon on the taskbar.

By Gas Gauge



On the exterior side of the battery pack is a gas gauge for displaying the estimated battery charge. When the battery pack is not installed in the computer and you want to know the battery charge, you can press the switch with a pointed device to see the corresponding value of indicator segment that light green.



The value of the corresponding green segment indicates the relative percentage of the battery charge. The battery pack is fully discharged when you see no segment glowing green.

Battery Low Signals and Actions

The battery icon  changes appearance to display the current state of the battery.

Battery Icon	Battery Level	Description
	Discharging	The icon shows the charge remaining in 10-percent increments until the charge reaches the low-battery level.
	Low	The battery charge has reached the low-battery level (10% by default).
	Critically low	The battery charge has reached the critical battery level (5% by default). By default, Windows will display a notification and put your computer into Hibernation.

When the battery is low, the computer's Battery Charge Indicator () also blinks red to alert you to take actions.

Always respond to low-battery by connecting the AC adapter, placing your computer in Hibernation mode, or turning off the computer.

Replacing the Battery Pack

CAUTION:

- There is danger of explosion if the battery is incorrectly replaced. Replace the battery only with the computer manufacturer's battery packs. Discard used batteries according to the dealer's instructions.
- Do not attempt to disassemble the battery pack.

NOTE: You can hot swap one battery pack while the other one is supplying the power.

To replace the battery pack, follow these steps:

1. Depending on which battery pack (❶ on the left side or ❷ on the right side) you want to replace, open the respective cover.

Slide the cover latch toward the unlocked position (🔓) (❶) and then lift up the tab (❷) to release the cover.



(Battery 1 as the example)

2. Slide the battery latch toward the right to unlock.

CAUTION: To unlock or lock, always hold the battery latch itself to move it. Never use the ribbon strip to pull the battery latch because this wrong method can cause a broken strip or an incorrect battery pack installation.



(Battery 1 as the example)

3. Remove the battery pack out of the slot by pulling the ribbon strip.

4. Noting the orientation, insert the new battery pack all the way into the slot.
5. Slide the battery latch toward the left to the locked position.

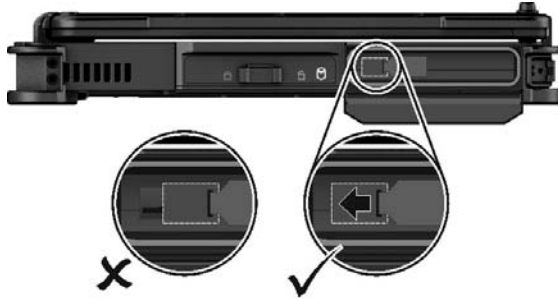

(Battery 1 as the example)

6. When closing the cover, push the tab downward until the cover clicks into place and then slide the latch toward the locked position (🔒).

Power-Saving Tips

Aside from enabling your computer's power saving mode, you can do your part to maximize the battery's operating time by following these suggestions.

- Do not disable Power Management.
- Decrease the LCD brightness to the lowest comfortable level.
- Shorten the length of time before Windows turn off the display.
- When not using a connected device, disconnect it.
- Turn off the wireless radio if you are not using the wireless module (such as WLAN, BT, or WWAN).
- Turn off the computer when you are not using it.

Chapter 4

Expanding Your Computer

You can expand the capabilities of your computer by connecting other peripheral devices. When using a device, be sure to read the instructions accompanying the device together with the relevant section in this chapter.

Connecting an HDMI Display Monitor

If you want the benefits of a larger display screen with higher resolution, you can connect an external display monitor to your computer.

Your computer supports an HDMI connector. HDMI (High-Definition Multimedia Interface) is an audio/video interface that transmits uncompressed digital data and therefore delivers true HD quality.



You can switch the display output by using **Fn+F5**, Windows **Control Panel**, or **OSD Control Panel**.

Connecting a USB Device

Your computer has three USB ports (two USB 3.0 ports at the rear and one USB 2.0 port at the right side) for connecting USB devices, such as a digital camera, scanner, printer, modem, and mouse.

USB 3.0 supports a transfer rate up to 5 Gbit/s and USB 2.0 a transfer rate up to 480 MB/s.

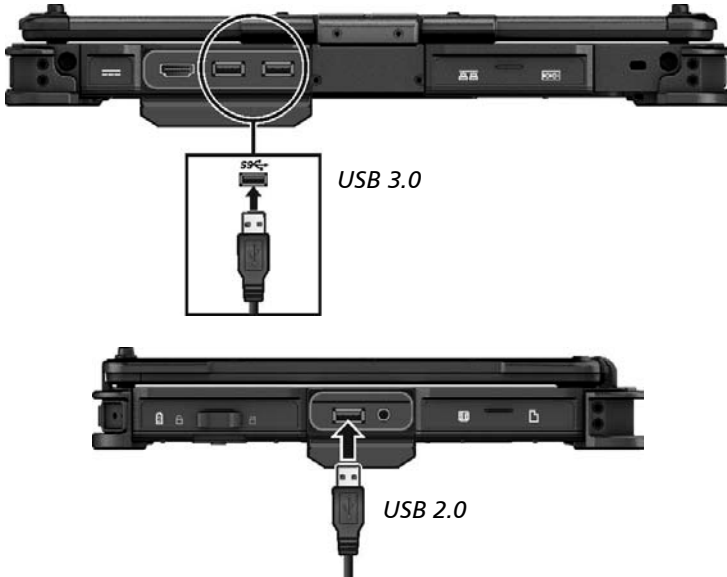

Connecting a Serial Device

Your computer has a serial port for connecting a serial device such as a serial mouse or serial communication device.



Connecting an Audio Device

For higher audio quality, you can send sound through an external audio device.

The combo connector is the “4-pole TRRS 3.5mm” type (Apple iPhone Recessed) so you can connect a compatible headset microphone.



SAFETY WARNING: 

To prevent possible hearing damage, do not listen at high volume levels for long periods.

Using Smart Cards

Your computer has a smart card slot.

With an embedded microcontroller, smart cards have the unique ability to store large amounts of data, carry out their own on-card functions (e.g., encryption and mutual authentication), and interact intelligently with a smart card reader.

To insert a smart card:

1. Locate the smart card reader. Open its protective cover by lifting up the tab of the cover.
2. Slide the smart card, with its label and embedded computer chip facing up into the slot (the lower one).



3. When closing the cover, push the tab downward until the cover clicks into place.

NOTE: An ExpressCard in the lower slot hinders the removal of the smart card. In this case, first remove the ExpressCard so that you can remove the smart card.

To remove a smart card:

1. Make sure that the software is not accessing the smart card.
2. Open the cover.
3. Slightly push the card to release and then pull it out of the slot.
4. Close the cover.

Using ExpressCards

Your computer has an ExpressCard slot.

The ExpressCard slot can accommodate a 54 mm (ExpressCard/54) or 34 mm (ExpressCard/34) wide ExpressCard. Typical ExpressCards support a very extensive range of applications including memory, wired and wireless communication cards, and security devices.

To insert an ExpressCard:

1. Locate the ExpressCard slot. Open its protective cover by lifting up the tab of the cover.
2. Slide the ExpressCard, with its label facing up, all the way into the slot (the upper one) until the rear connectors click into place.

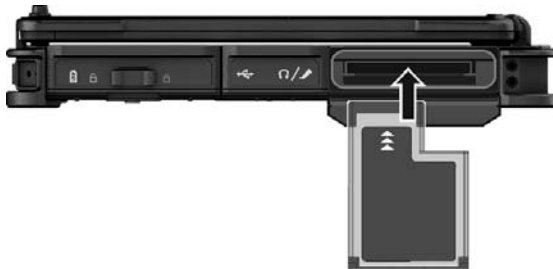

3. When a new card is seated, the computer will detect it and try to install the appropriate driver. Follow the on-screen instructions to complete the process.
4. When closing the cover, push the tab downward until the cover clicks into place.

To remove an ExpressCard:

1. Double-click on the **Safely Remove Hardware**  icon found on the Windows taskbar and the **Safely Remove Hardware** window appears on screen.
2. Select (highlight) the ExpressCard from the list to disable the card.

3. Open the cover.
4. Pull the card out of the slot.
5. Close the cover.

Replacing the Hard Disk Drive

1. Turn off the computer and disconnect the AC adapter.
2. Slide the cover latch toward the unlocked position () (**1**) and then lift up the tab (**2**) to release the cover.

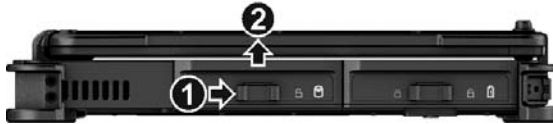

3. Using the ribbon strip, first pull the small latch toward the right to unlock (**1**) and then pull the hard disk drive out of the computer (**2**).

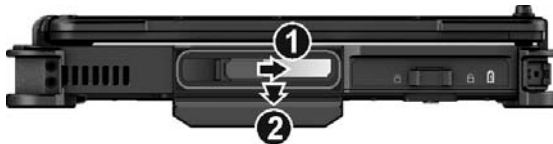

4. Noting the orientation, insert the new hard disk drive all the way into the slot until the small latch clicks into place.
5. When closing the cover, push the tab downward until the cover clicks into place and then slide the latch toward the locked position ().

System Memory Upgrade

You can upgrade your computer by expanding system memory.

CAUTION:

- It is not recommended that you buy and install RAM modules by yourself. If you want to expand system memory, please ask Getac service center to install DRAM modules for you so that full compatibility can be guaranteed.
- RAM modules are extremely sensitive to static electricity. There are cases where static electricity generated by the human body has adversely affected such modules. When inserting or removing a RAM module, do not touch the terminals or internal components, insert objects other than the module, or allow foreign particles to enter. Doing so has been known to cause damage, fire, or electrical shock.

To install the RAM module:

1. Disconnect the AC adapter and remove the battery pack.
2. Carefully place the computer upside down.
3. Remove the 8 screws to open the compartment cover.

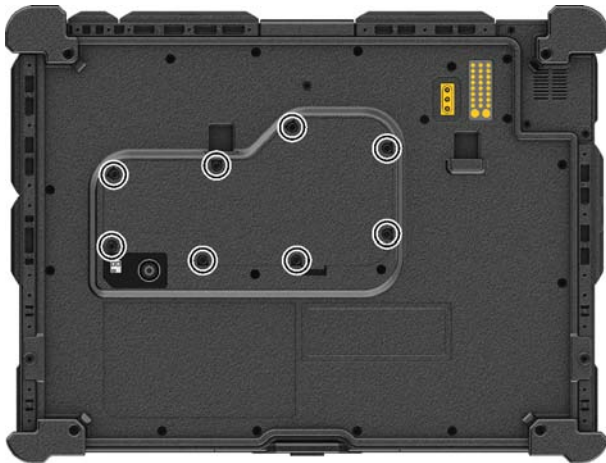

4. Remove the plastic bar by unfastening two screws.



5. To install the RAM module, match the module's notched part with the socket's projected part and firmly insert the module into the socket at a 20-degree angle (❶). Then push down until the retaining clips lock the module into position (❷).

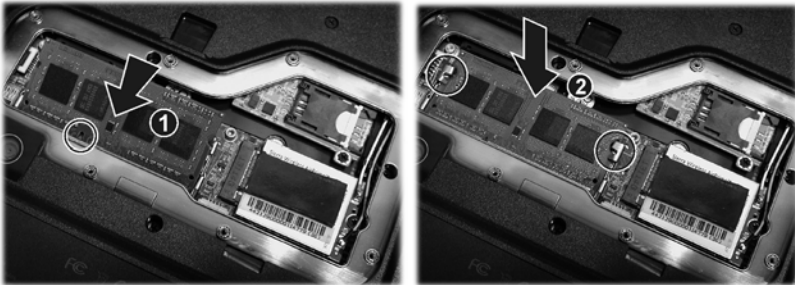

CAUTION: If the RAM module is difficult to insert or difficult to push down, do not force it. Check once more to ensure that the module is positioned correctly.

6. Replace the plastic bar and secure with two screws.
7. Close the compartment cover and secure with 8 screws.
8. Replace the battery pack.

Chapter 5

Using BIOS Setup

BIOS Setup Utility is a program for configuring the BIOS (Basic Input/ Output System) settings of the computer. BIOS is a layer of software, called firmware, that translates instructions from other layers of software into instructions that the computer hardware can understand. The BIOS settings are needed by your computer to identify the types of installed devices and establish special features.

This chapter tells you how to use the BIOS Setup Utility.

When and How to Use

You need to run BIOS Setup Utility when:

- You see an error message on the screen requesting you to run BIOS Setup Utility.
- You want to restore the factory default BIOS settings.
- You want to modify some specific settings according to the hardware.
- You want to modify some specific settings to optimize the system performance.

To run BIOS Setup Utility:

- **Method 1 for Windows 8 models:** Open the Charms Bar of Windows. Click **Settings** → **Change PC Settings** → **General**. Under **Advanced startup**, click **Restart now**. In the boot options menu, click **Troubleshoot** → **Advanced options** → **UEFI Firmware Settings**. Click **Restart** to restart the system and enter UEFI (BIOS).
- **Method 2 for Windows 8 models:** Restart the computer using the **Restart** option in Windows Power menu. Or, perform a full shutdown by holding down **Shift** while clicking the **Shutdown** option in Windows Power menu and then start up the computer. In either way, press the **F2** key during the brief time period – shortly after the computer powers on but before it begins to load Windows.
- **For Windows 7 models:** Press the **F2** key when the prompt appears on the screen during system startup.

NOTE: The actual setting items on your model may differ from those described in this chapter.

Menu Descriptions

Information Menu

The Information menu contains the basic configuration information of the system. There are no user-definable items in this menu.

NOTE: The “Asset Tag” information appears when you have entered the asset number for this computer using the asset management program. The program is provided in the **Asset tag** folder of the Driver disc.

Main Menu

The Main menu contains the various system settings.

- **System Date** sets the system date.
- **System Time** sets the system time.
- **Wireless LAN** specifies the on/off state of the wireless LAN radio when the system starts up. When set to *Last State*, the on/off state remains the same as the last state before you turn off the system.
- **Bluetooth** specifies the on/off state of the Bluetooth radio when the system starts up. When set to *Last State*, the on/off state remains the same as the last state before you turn off the system.
- **Legacy USB Support** enables or disables the system’s support for Legacy USB device in DOS mode. (This item appears only on Windows 7 models.)
- **CSM Support** enables or disables CSM (Compatibility Support Mode). You can set this item to *Yes* for backward compatibility with legacy BIOS services. (This item appears only on Windows 8 models.)
- **UEFI Boot** enables or disables booting using UEFI (Unified Extensible Firmware Interface). UEFI is a new type of firmware after the BIOS firmware. (This item appears only on Windows 8 models.)
- **Legacy Boot** enables or disables booting using legacy BIOS. This item is accessible only when the **CSM Support** item is set to *Yes*. (This item appears only on Windows 8 models.)

Advanced Menu

The Advanced menu contains the advanced settings.

- **Wake Up Capability**
 - Any-key Wake Up From S3** allows any key to wake up the system from S3 (Sleep) state.
 - USB Wake-Up From S3** allow a USB device activity to wake up the system from S3 (Sleep) state. (This feature works for Windows 7 only.)
- **AC Initiation** sets if connecting AC power will automatically start or resume the system.
- **SATA Mode** set to *AHCI* if your hard disk supports AHCI. AHCI allows you to take advantage of Advanced Host Controller Interface features. The options are *IDE* and *AHCI*.

CAUTION: Incorrect SATA mode settings can result in hard disk drive boot failure.

- **AMT Configuration**
 - Intel(R) AMT** enables or disables Intel® Active Management Technology BIOS extension execution. AMT allows the system administrator to access an AMT featured computer remotely.
 - Enter Intel MEBx Setup** determines whether the prompt for entering Intel MEBx Setup appears or not during POST.
- **Virtualization Technology Setup**
 - Intel(R) Virtualization Technology** enables or disables Intel® VT (Intel Virtualization Technology) feature which provides hardware support for processor virtualization. When enabled, a VMM (Virtual Machine Monitor) can utilize the additional hardware virtualization capabilities provided by this technology.
 - Intel(R) VT for Directed I/O (VT-d)** enables or disables VT-d (Intel® Virtualization Technology for Directed I/O). When enabled, VT-d helps enhance Intel platforms for efficient virtualization of I/O devices.
- **Graphics Setup**
 - DVMT Pre-Allocated** sets the amount of pre-allocated (fixed) graphics memory for use by the internal graphics device.

DVMT Total Gfx Mem sets the amount of total graphics memory (pre-allocated + fixed + DVMT) for use by the internal graphics device.

- **Device Configuration** enables or disables several hardware components. The items available for setting depend on your model.

Security Menu

The Security menu contains the security settings, which safeguard your system against unauthorized use.

NOTE:

- You can set the user password only when the supervisor password has been set.
- If both the supervisor and user passwords are set, you can enter any of them for starting up the system and/or entering BIOS Setup. However, the user password only allows you to view/change the settings of certain items.
- **Account's Password Status**
Supervisor/User Password Is shows whether you have set the supervisor/user password or not for the system.
Set Supervisor/User Password sets the supervisor/user password.-You can set the supervisor/user password to be required for starting up the system and/or entering BIOS Setup.
- **Password on Boot** allows you to enable or disable the entering of password for booting up your system. (This item appears only on Windows 7 models.)
- **Secure Boot Configuration** (This item appears only on Windows 8 models.)
Secure Boot Option enables or disables Secure Boot. Secure Boot is a feature that helps prevent unauthorized firmware, operating systems, or UEFI drivers from running at boot time.
Reset to Default resets secure boot variables to manufacturing default.
Change to Customization changes the platform to setup mode and disables Secure Boot.

- **HDD Security Status**
HDD 0 Password State shows whether you have set the hard disk password or not.
Set HDD 0 Password sets the password for locking the Primary Master hard disk drive. After setting a password, the hard disk drive can only be unlocked by the password no matter where it is installed.
- **TPM Setup Menu**
TPM Support enables or disables TPM (Trusted Platform Module) support. TPM (Trusted Platform Module) is a component on your computer's mainboard that is specifically designed to enhance platform security by providing a protected space for key operations and other security critical tasks.
Current TPM State shows the current TPM state.
TPM Action allows you to select between *No Change*, *Clear*, *Enable and Activate*, and *Disable and Deactivate*.
- **Intel Trusted Execution Technology** enables utilization of additional hardware capabilities provided by Intel® Trusted Execution Technology.

Boot Menu

The Boot menu sets the sequence of the devices to be searched for the operating system.

The bootable devices will be automatically detected during POST and shown here, allowing you to set the sequence that the BIOS uses to look for a device from which to load the OS.

Exit Menu

The Exit menu displays ways of exiting BIOS Setup Utility. After finishing with your settings, you must save and exit so that the changes can take effect.

- **Exit Saving Changes** saves the changes you have made and exits BIOS Setup Utility.
- **Exit Discarding Changes** exits BIOS Setup Utility without saving the changes you have made.

- **Load Setup Defaults** loads the factory default values for all the items.
- **Discard Changes** restores the previous values for all the items.
- **Saves Changes** saves the changes you have made.

Chapter 6

Using Getac Software

Getac software includes application programs for specific computer components and utility programs for overall management.

This chapter briefly describes the programs.

OSD Control Panel

The OSD (On Screen Display) Control Panel provides a user-friendly interface for you to quickly activate or operate certain functions on your computer with a simple tap of the screen.

To open the OSD Control Panel, start the program named **OSDC**. You can also press the **Windows Logo** button (long press if you have a Windows 8 model) on your computer to open it. The following screen appears.



For detailed information on the program, see the program's online help.

G-Manager

G-Manager is a unified user interface utility that allows you to view, manage, or configure your computer features.

With G-Manager, you can perform all or some of the tasks listed below.

- View system information.
- Check the battery status and configure the battery.
- Configure ECO modes (or called power profiles).
- View light sensor information (select models only).
- Set if your system will switch to the external antenna when connected to the docking station (select models only).
- Configure how your system works with the vehicle ignition (select models only).
- Monitor the system.
- View the GPS information (select models only).

Tap and hold the Getac Utility icon  located on Windows taskbar and select **G-Manager** to start the program. The G-Manager window appears, containing several tabs.

NOTE: Depending on your model, the actual items appearing on the screen may differ from those shown in this manual.

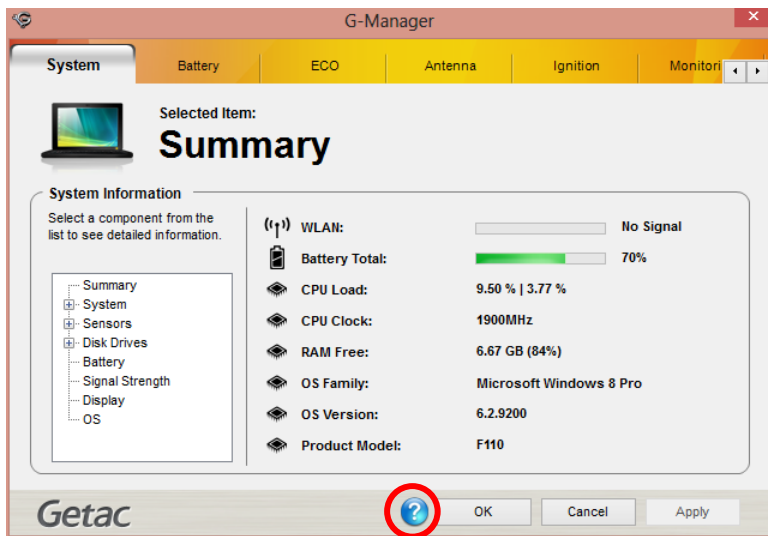

Help

For detailed information on the program, see the program's online help.

Getac Camera (Optional)

Getac Camera is a geo-tagging camera program, which allows you to stamp geographical information on photos as watermarks and embed such information into JPEG files as EXIF 2.2 metadata.

NOTE:

- Getac Camera works with Virtual-GPS (a separate application program).
- Before starting Getac Camera, close any other program that uses the camera; otherwise, Getac Camera can only provide limited functions.

Start **Getac Camera**. The Getac Camera window appears as shown below.



The GPS positioning will be automatically activated. When the GPS positioning is completed, you will see the geographical information in the watermark area on the image.

For detailed information on the program, see the program's online help. Tap

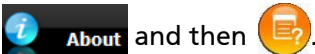

Getac Smart Tag (Optional)

If your model has the RFID reader/writer module, you can use Getac Smart Tag to read UID numbers from RFID tags (14443-A, 14443-B, and 15693 types).

Start **Getac Smart Tag**. The Getac Smart Tag floating button appears and is always on top of the screen. Tap the floating button to start scanning. While scanning is in progress, the button's color is orange.



Idle



Scanning

To configure the program, open the options menu by tapping and holding the floating button.

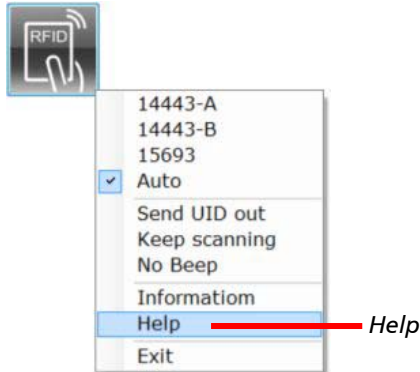

For detailed information on the program, see the program's online help.

Chapter 7

Caring for the Computer

Taking good care of your computer will ensure a trouble-free operation and reduce the risk of damage to your computer.

This chapter gives you guidelines covering areas such as protecting, storing, cleaning, and traveling.

Protecting the Computer

To safeguard the integrity of your computer data as well as the computer itself, you can protect the computer in several ways as described in this section.

Using an Anti-Virus Strategy

You can install a virus-detecting program to monitor potential viruses that could damage your files.

Using the Cable Lock

You can use a Kensington-type cable lock to protect your computer against theft. The cable lock is available in computer stores.

To use the lock, loop the lock cable around a stationary object such as a table. Insert the lock to the Kensington lock hole and turn the key to secure the lock. Store the key in a safe place.

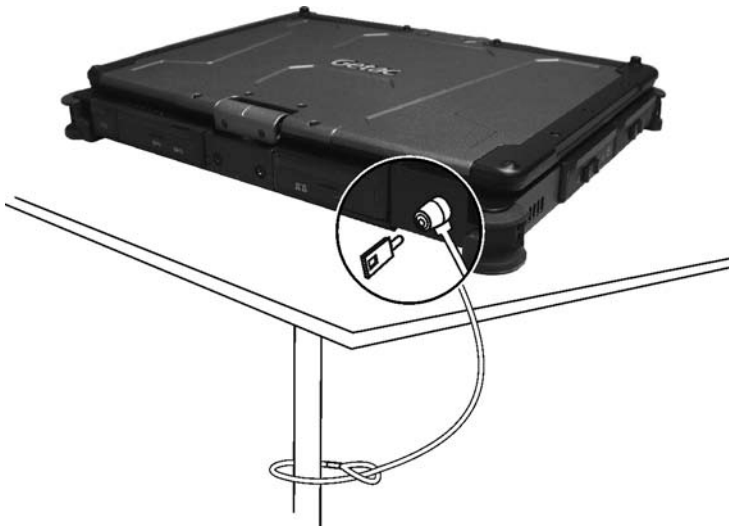

Taking Care of the Computer

Location Guidelines

- For optimal performance, use the computer where the recommended temperature is between 0 °C (32 °F) and 55 °C (131 °F). Actual operating temperature depends on product specifications.
- Avoid placing the computer in a location subject to high humidity, extreme temperatures, mechanical vibration, direct sunlight, or heavy dust. Using in extreme environments for long periods can result in product deterioration and a shortened product life.
- Operating in an environment with metallic dust is not allowed.
- Place the computer on a flat and steady surface. Do not stand the computer on its side or store it in an upside-down position. A strong impact by dropping or hitting may damage the computer.
- Do not cover or block any ventilation openings on the computer. For example, do not place the computer on a bed, sofa, rug, or other similar surface. Otherwise, overheating may occur that results in damage to the computer.
- As the computer can become very hot during operation, keep it away from objects that are vulnerable to heat.
- Keep the computer at least 13 cm (5 inches) away from electrical appliances that can generate a strong magnetic field such as a TV, refrigerator, motor, or a large audio speaker.
- Avoid moving the computer abruptly from a cold to a warm place. A temperature difference of more than 10 °C (18 °F) may cause condensation inside the unit, which may damage the storage media.

General Guidelines

- Do not expose your skin to the computer when operating it in a very hot or cold environment.
- Do not place heavy objects on top of the computer as this may damage the display.
- The screen surface is easily scratched. Avoid touching it with a sharp object such as a pen or pencil.
- LCD image sticking occurs when a fixed pattern is displayed on the screen for a prolonged period of time. You can avoid the problem by limiting the amount of static content on the display. It is recommended that you use a screen saver or turn off the display when it is not in use.
- To maximize the life of the backlight in the display, allow the backlight to automatically turn off as a result of power management.

Cleaning Guidelines

- Never clean the computer with its power on.
- Use a soft cloth moistened with water or a non-alkaline detergent to wipe the exterior of the computer.
- Gently wipe the display with a soft, lint-free cloth. Do not use alcohol or detergent on the display.
- Dust or grease on the touchpad can affect its sensitivity. Clean the pad by using adhesive tape to remove the dust and grease on its surface.
- If water or liquid is split onto the computer, wipe it dry and clean when possible. Though your computer is water-proof, do not leave the computer wet when you can dry it.
- If the computer gets wet where the temperature is 0°C (32°F) or below, freeze damage may occur. Make sure to dry the wet computer.

Battery Pack Guidelines

- Recharge the battery pack when it is nearly discharged. When recharging, make sure that the battery pack is fully charged. Doing so may avoid harm to the battery pack.
- The battery pack is a consumable product and the following conditions will shorten its life:
 - when frequently charging the battery pack
 - when using, charging, or storing the battery in high temperature condition
- To avoid hastening the deterioration of the battery pack thereby prolonging its useful life, minimize the number of times you charge it so as not to frequently increase its internal temperature.
- Charge the battery pack between 10 °C ~ 30 °C (50 °F ~ 86 °F) temperature range. A higher environment temperature will cause the battery pack's temperature to rise. Avoid charging the battery pack inside a closed vehicle and in hot weather condition. Also, charging will not start if the battery pack is not within the allowed temperature range.
- It is recommended that you do not charge the battery pack more than once a day.
- It is recommended that you charge the battery pack with the computer's power off.
- To maintain the battery pack's operating efficiency, store it in a cool dark place removed from the computer and with 30 % ~ 40 % charge remaining.
- Important guidelines when using the battery pack.
When installing or removing the battery pack take note of the following:
 - avoid installing or removing the battery pack when the computer is in Sleep mode. Abruptly removing the battery pack may cause loss of data or the computer may become unstable.
 - avoid touching the battery pack terminals or damage may occur, thereby causing improper operation to it or the computer.The computer's input voltage and surrounding temperature will directly affect the battery pack's charge and discharge time:

- charging time will be prolonged when the computer is turned on. To shorten the charging time, it is recommended that you place the computer in Sleep or hibernation mode.
- a low temperature will prolong the charging time as well as hasten the discharge time.
- When using battery power in an extremely low temperature environment, you may experience shortened operating time and incorrect battery level reading. This phenomenon comes from the chemical characteristics of batteries. The appropriate operating temperature for the battery is -10 °C ~ 50 °C (14 °F ~ 122 °F).
- Do not leave the battery pack in storage for more than six months without recharging it.

Touchscreen Guidelines

- Use the finger or the included stylus on the display. Using a sharp or metallic object other than your finger or stylus may cause scratches and damage the display, thereby causing errors.
- Use a soft cloth to remove dirt on the display. The touchscreen surface has a special protective coating that prevents dirt from sticking to it. Not using a soft cloth may cause damage to the special protective coating on the touchscreen surface.
- Turn off the computer power when cleaning the display. Cleaning the display with the power on may cause improper operation.
- Do not use excessive force on the display. Avoid placing objects on top of the display as this may cause the glass to break thereby damaging the display.
- Using the touchscreen during low temperature (less than 5 °C) may cause a slower response time, this is normal. A normal response time may be restored upon returning to room temperature.
- When there is noticeable discrepancy in the operation of the touchscreen function (wrong location on intended operation or improper display resolution), refer to the Windows online Help for instructions on recalibrating the touchscreen display.

When Traveling

- Before traveling with your computer, make a backup of your hard disk data into flash disks or other storage devices. As an added precaution, bring along an extra copy of your important data.
- Make sure that the battery pack is fully charged.
- Make sure that the computer is turned off.
- Disconnect the AC adapter from the computer and take it with you. Use the AC adapter as the power source and as a battery-charger.
- Hand-carry the computer. Do not check it in as luggage.
- If you need to leave the computer in the car, put it in the trunk of the car to avoid exposing the computer to excessive heat.
- When going through airport security, it is recommended that you send the computer and flash disks through the X-ray machine (the device you set your bags on). Avoid the magnetic detector (the device you walk through) or the magnetic wand (the handheld device used by security personnel).
- If you plan to travel abroad with your computer, consult your dealer for the appropriate AC power cord for use in your country of destination.

Chapter 8

Troubleshooting

computer problems can be caused by hardware, software, or both. When you encounter any problem, it might be a typical problem that can easily be solved.

This chapter tells you what actions to take when solving common computer problems.

Preliminary Checklist

Here are helpful hints to follow before you take further actions when you encounter any problem:

- Try to isolate which part of the computer is causing the problem.
- Make sure that you turn on all peripheral devices before turning on the computer.
- If an external device has a problem, make sure that the cable connections are correct and secure.
- Make sure that the configuration information is properly set in the BIOS Setup program.
- Make sure that all the device drivers are correctly installed.
- Make notes of your observations. Are there any messages on the screen? Do any indicators light? Do you hear any beeps? Detailed descriptions are useful to the service personnel when you need to consult one for assistance.

If any problem persists after you follow the instructions in this chapter, contact an authorized dealer for help.

Solving Common Problems

Battery Problems

The battery does not charge (Battery Charge indicator does not light amber).

- Make sure that the AC adapter is properly connected.
- Make sure that the battery is not too hot or cold. Allow time for the battery pack to return to room temperature.
- If the battery doesn't charge after it has been stored in very low temperatures, try disconnecting and reconnecting the AC adapter to solve the problem.
- Make sure that the battery pack is installed correctly.
- Make sure that the battery terminals are clean.

The operating time of a fully charged battery becomes shorter.

- If you often partially recharge and discharge, the battery might not be charged to its full potential. Initialize the battery to solve the problem.

The battery operating time indicated by the battery meter does not match the actual operating time.

- The actual operating time can be different from the estimated time, depending on how you are using the computer. If the actual operating time is much less than the estimated time, initialize the battery.

BT Problems

I cannot connect to another device with BT wireless technology.

- Make sure that both devices have activated BT feature.
- Make sure that the distance between the two devices is within the limit and that there are no walls or other obstructions between the devices.

- Make sure that the other device is not in “Hidden” mode.
- Make sure that both devices are compatible.

Display Problems

Nothing appears on the screen.

- During operation, the screen may automatically turn off as a result of power management. Press any key to see if the screen comes back.
- The brightness level might be too low. Increase the brightness.
- The display output might be set to an external device. To switch the display back to the LCD, press the **Fn+F5** hot key or change the display through the **Display Settings Properties**.

The characters on the screen are dim.

- Adjust the brightness and/or contrast.

The display brightness cannot be increased.

- As a protection, the display brightness will be fixed at a low level when the surrounding temperature is too high or too low. It is not a malfunction in this situation.

Bad dots appear on the display at all times.

- A small number of missing, discolored, or bright dots on the screen are an intrinsic characteristic of TFT LCD technology. It is not regarded as a LCD defect.

Clouding (or called “mura”) happens on the screen when you exert forces on the left or right side of the LCD frame.

- This is a normal phenomenon, not a defect.

Hardware Device Problems

The computer does not recognize a newly installed device.

- The device may not be correctly configured in the BIOS Setup program. Run the BIOS Setup program to identify the new type.
- Make sure if any device driver needs to be installed. (Refer to the documentation that came with the device.)
- Make sure if the device needs any jumper or switch settings. (Refer to the documentation that came with the device.)
- Check the cables or power cords for correct connections.
- For an external device that has its own power switch, make sure that the power is turned on.

Hard Disk Drive Problems

The hard disk drive error message appears on the screen.

- The hard disk drive has defects. Ask your dealer for help.

The hard disk drive operations seem slow.

- The data files stored on the hard disk drive may be fragmented. Use a tool such as Window's **Disk Defragmenter** to defragment the files.

Keyboard and Touchpad Problems

The keyboard does not respond.

- Try connecting an external keyboard. If it works, contact an authorized dealer, as the internal keyboard cable might be loose.

Water or liquid is spilt into the keyboard.

- Immediately turn off the computer and unplug the AC adapter. Then turn the keyboard upside down to drain the liquid out of the keyboard. Make sure to clean up any part of the spill you can get to. Though the

keyboard of your computer is spill-proof, liquid will remain in the keyboard enclosure if you don't remove it.

The touchpad does not work, or the pointer is difficult to control with the touchpad.

- Make sure that the touchpad is clean.

LAN Problems

I cannot access the network.

- Make sure that the LAN cable is properly connected to the RJ-45 connector and the network hub.
- Make sure that the network configuration is appropriate.
- Make sure that the user name or password is correct.

Power Management Problems

The computer does not enter Sleep or Hibernation mode automatically.

- If you have a connection to another computer, the computer does not enter Sleep or Hibernation mode if the connection is actively in use.
- Make sure that the Sleep or Hibernation time-out is enabled.

The computer does not enter Sleep or Hibernation mode immediately.

- If the computer is performing an operation, it normally waits for the operation to finish.

The computer does not resume from Sleep or Hibernation mode.

- The computer automatically enters Sleep or Hibernation mode when the battery pack is empty. Do any one of the following:
 - Connect the AC adapter to the computer.
 - Replace the empty battery pack with a fully charged one.

Software Problems

An application program does not work correctly.

- Make sure that the software is correctly installed.
- If an error message appears on the screen, consult the software program's documentation for further information.
- If you are sure the operation has stop, reset the computer. (See "Resetting the Computer" later in this chapter.)

Sound Problems

No sound is produced.

- Make sure that the volume control is not set too low. Increase the volume.
- Make sure that the sound is not muted.
- Make sure that the computer is not in Sleep mode.
- If using an external speaker, make sure that the speaker is properly connected.

Distorted sound is produced.

- Make sure that the volume control is not set too high or too low. In most cases, a high setting can cause the audio electronics to distort the sound.

Startup Problems

When you turn on the computer, it does not respond and the Power Indicator does not light green.

- If you are using an external AC power, make sure that the AC adapter is correctly and securely connected. If so, make sure that the electrical outlet works properly.
- If you are using the battery power, make sure that the battery is not discharged.

When you turn on the computer, it stops after POST.

- Reset your computer. (See “Resetting the computer” later in this chapter.)

Wireless LAN Problems

I cannot use the wireless LAN feature.

- Make sure that the wireless LAN feature is turned on.

Transmission quality is poor.

- Your computer may be in an out-of-range situation. Move your computer closer to the Access Point or another wireless LAN device it is associated with.
- Check if there is high interference around the environment and solve the problem as described next.

Radio interference exists.

- Move your computer away from the device causing the radio interference such as microwave oven and large metal objects.
- Plug your computer into an outlet on a different branch circuit from that used by the affecting device.
- Consult your dealer or an experienced radio technician for help.

I cannot connect to another wireless LAN device.

- Make sure that the wireless LAN feature is turned on.
- Make sure that the SSID setting is the same for every wireless LAN device in the network.
- Your computer is not recognizing changes. Restart the computer.
- Make sure that the IP address or subnet mask setting is correct.

I cannot communicate with the computer in the network when Infrastructure mode is configured.

- Make sure that the Access Point your computer is associated with is powered on and all the LEDs are working properly.
- If the operating radio channel is in poor quality, change the Access Point and all the wireless station(s) within the BSSID to another radio channel.
- Your computer may be in an out-of-range situation. Move your computer closer to the Access Point it is associated with.
- Make sure that your computer is configured with the same security option (encryption) to the Access Point.
- Use the Web Manager/Telnet of the Access Point to check whether it is connected to the network.
- Reconfigure and reset the Access Point.

I cannot access the network.

- Make sure that the network configuration is appropriate.
- Make sure that the user name or password is correct.
- You have moved out of range of the network.
- Turn off power management.

Other Problems

The date/time is incorrect.

- Correct the date and time via the operating system or BIOS Setup program.
- After you have performed everything as described above and still have the incorrect date and time every time you turn on the computer, the RTC (Real-Time Clock) battery is at the end of its life. Call an authorized dealer to replace the RTC battery.

Resetting the Computer

You may have to reset (reboot) your computer on some occasions when an error occurs and the program you are using hangs up.

If you are sure the operation has stopped and you cannot use the “restart” function of the operating system, reset the computer.

Reset the computer by any one of these methods:

- Press **Ctrl+Alt+Del** on the keyboard. Or press and hold the **P1** button for more than 2 seconds. This opens the **Ctrl-Alt-Del** screen where you can select actions including **Restart**.
- If the above action does not work, press and hold the power button for more than 5 seconds to force the system to turn off. Then turn on the power again.

System Recovery

System Restore, Refresh, or Reset (for Windows 8 Models)

If you're having problems with your Windows 8 computer, you can try to restore, refresh, or reset it.

To restore your computer to an earlier point in time:

1. Enter **Recovery** in the search box.
2. Tap **Settings**, and then tap **Recovery**.
3. Tap **Open System Restore**.

To refresh your computer without affecting your files:

1. Open the Charms Bar of Windows.
2. Tap **Settings** → **Change PC Settings** → **General**.
3. Under **Refresh your PC without affecting your files**, tap **Get started**.

To remove everything and reinstall Windows:

1. Open the Charms Bar of Windows.
2. Tap **Settings** → **Change PC Settings** → **General**.
3. Under **Remove everything and reinstall Windows**, tap **Get started**.

System Recovery (a Tool for Windows 7 Models)

Use System Recovery when:

- The Windows 7 operating system does not start at all.
- You want to restore the system to the factory state.

WARNING:

- Using this feature will reinstall Windows to your system and configure it to the system's factory default settings. All data on the hard disk drive will be lost.
- Make sure that power is not interrupted during the recovery process. An unsuccessful recovery may result in Windows startup problems.

To run System Recovery:

1. Connect the AC adapter.
2. Turn on the computer. During system startup when the following screen appears, press **Ctrl + Alt + F2** keys for four second.

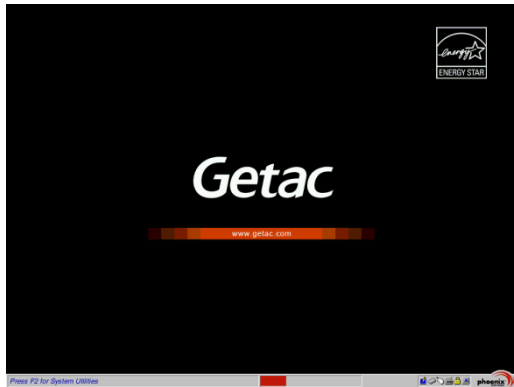

4. In the screen that appears, select **Recovery** to start the recovery process.



5. The progress bar shows the percentage completed. When it reaches 100%, the system turns off.
6. Turn on the computer. The Windows setup wizard starts. Follow the onscreen prompts to continue.
7. When the system restarts, the installer screen appears. The installer will perform system hardware detection and driver installation.

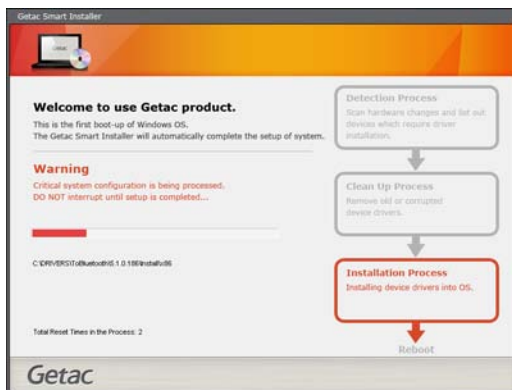

8. When completed, the system restarts and displays Windows desktop.

Appendix A

Specifications

NOTE: Specifications are subject to change without any prior notice.

Parts		Specifications
CPU		Haswell Intel® Core™ i3/i5/i7 processor
BIOS		Phoenix, Flash EEPROM, supporting UEFI, NIST, ACPI, and TPM
RAM		4GB/8GB DDR3L 1600MHz SO-DIMM
Video	Controller	UMA - Intel® GT2
	Display Panel	11.6-inch (16:9) TFT LCD, HD 1366x768 or FHD 1920x1080, sunlight readable, 800 Nits maximum brightness
Audio	Features	Azalia, High Definition audio
	Speaker	1.5W x 1
	Microphone	Integrated microphone
Keyboard		Standard keys with numeric pad keys, 12 function keys, special Fn (Function) key and Windows keys, with water-proof membrane or backlight (option)
Pointing device		ClickPad, glide touchpad with multi-touch
Hard disk drive		64/128/256 GB SSD (Solid-State Disk)
Card slots		ExpressCard/34/54 Smart Card
I/O ports		USB 3.0 x 2, USB 2.0, RS232, HDMI, combo audio (4-pole TRRS 3.5mm type), RJ-45, Docking

Parts		Specifications
LAN		10/100/1000 Mbps Ethernet
Wireless LAN + BT		IEEE 802.11ac, compatible with 802.11a/b/g/n, BT 4.0 + EDR
GPS (option)		NMEA0183
WWAN (option)		3G/4G LTE
Camera (option)		Front: HD Rear: 5M pixel, autofocus, LED, video capture
RFID Reader (option)		Contactless, UART, supporting ISO14443A/B and 15693
Security		Kensington lock TPM 1.2
Power	AC adapter	Universal 65 W; input: 100~240 V, 50/60 Hz; output: 19V
	Battery pack x 2	Lithium-ion Prismatic type, 3-cell
Dimension (LxWxD)		299 x 223 x 34mm (11.77 x 8.78 x 1.34 inch)
Weight		2 kg (4.41 lb)

Appendix B

Regulatory Information

This appendix provides regulatory statements and safety notices on your computer.

NOTE: Marking labels located on the exterior of your computer indicate the regulations that your model complies with. Please check the marking labels and refer to the corresponding statements in this appendix. Some notices apply to specific models only.

On the Use of the System

Class B Regulations

USA

Federal Communications Commission Radio Frequency Interference Statement

NOTE:

This equipment has been tested and found to comply with the limits for a Class B digital device pursuant to Part 15 of the FCC Rules. These limits are designed to provide reasonable protection against harmful interference in a residential installation. This equipment generates, uses, and can radiate radio frequency energy and, if not installed and used in accordance with the instructions, may cause harmful interference to radio communications. However, there is no guarantee that interference will not occur in a particular installation. If this equipment does cause harmful interference to radio or television reception, which can be determined by turning the equipment off and on, the user is encouraged to try to correct the interference by one or more of the following measures:

- Reorient or relocate the receiving antenna.
- Increase the separation between the equipment and receiver.
- Connect the equipment into an outlet on a circuit different from that to which the receiver is connected.
- Consult the dealer or an experienced radio/TV technician for help.

Any changes or modifications not expressly approved by the manufacturer could void the user's authority to operate the equipment.

Please note:

The use of a non-shielded interface cable with this equipment is prohibited.

Canada

Canadian Department of Communications Radio Interference Regulations Class B Compliance Notice

This Class B digital apparatus meets all requirements of the Canada Interference-Causing equipment regulations.

Cet appareil numérique de Classe B respecte toutes les exigences du Règlement Canadien sur le matériel brouilleur.

This digital apparatus does not exceed the Class B limits for radio noise emissions from digital apparatus set out in the Radio Interference Regulations of the Canadian Department of Communications.

Le présent appareil numérique n'émet pas de bruits radioélectriques dépassant les limites applicables aux appareils numériques de la classe B prescrites dans le Règlement sur le brouillage radioélectrique édicté par le ministère des Communications du Canada.

ANSI Warning

Equipment approved for ANSI/ISA 12.12.01, Nonincendive Electrical Equipment for use in Class 1, Division 2, Group A, B, C, and D.

Maximum ambient temperature: -25°C~55°C

- **WARNING:** To prevent ignition of a hazardous atmosphere, batteries must only be changed or charged in an area known to be non-hazardous.
- **EXPLOSION HAZARD WARNING:** External connections/hubs through the connectors as mentioned (USB connector, Ethernet connector, phone connector, video port, serial port, power supply connector, microphone jack, headphones jack, and buttons/switches) and super multi DVD/combo drive are not to be used in a hazardous location.
- Power adapter shall not be used in hazardous locations.

Safety Notices

About the Battery

Caution Texts Concerning Lithium Batteries

DANISH

ADVARSEL! Lithiumbatteri – Eksplosionsfare ved fejlagtig håndtering. Udskiftning må kun ske med batteri af samme fabrikat og type. Levér det brugte batteri tilbage til leverandøren.

NORWEGIAN

ADVARSEL: Eksplosjonsfare ved feilaktig skifte av batteri. Benytt samme batteritype eller en tilsvarende type anbefalt av apparatfabrikanten. Brukte batterier kasseres i henhold til fabrikantens instruksjoner.

SWEDISH

VARNING: Explosionsfara vid felaktigt batteribyte. Använd samma batterityp eller en ekvivalent typ som rekommenderas av apparattillverkaren. Kassera använt batteri enligt fabrikantens instruktion.

FINNISH

VAROITUS: Paristo voi räjähtää, jos se on virheellisesti asennettu. Vaihda paristo ainoastaan valmistajan suosittelemaan tyyppiin. Hävitä käytetty paristo valmistajan ohjeiden mukaisesti.

ENGLISH

CAUTION: Danger of explosion if battery is incorrectly replaced. Replace only with the same or equivalent type recommended by the equipment manufacturer. Discard used batteries according to manufacturer's instructions.

DEUTSCH

VORSICHT: Explosionsgefahr bei unsachgemäßem Austausch der Batterie. Ersatz nur durch denselben oder einen vom Hersteller empfohlenen gleichwertigen Typ. Entsorgung gebrauchter Batterien nach Angaben des Herstellers.

FRENCH

ATTENTION: Il y a danger d'explosion s'il y a remplacement incorrect de la batterie. Remplacer uniquement avec une batterie du même type ou d'un

type équivalent recommandé par le constructeur. Mettre au rebut les batteries usagées conformément aux instructions du fabricant.

Attention (for USA Users)

The product that you have purchased contains a rechargeable battery. The battery is recyclable. At the end of its useful life, under various state and local laws, it may be illegal to dispose of this battery into the municipal waste stream. Check with your local solid waste officials for details in your area for recycling options or proper disposal.

About the AC Adapter

- Use only the AC adapter supplied with your computer. Use of another type of AC adapter will result in malfunction and/or danger.
- Do not use the adapter in a high moisture environment. Never touch the adapter when your hands or feet are wet.
- Allow adequate ventilation around the adapter when using it to operate the device or charge the battery. Do not cover the AC adapter with paper or other objects that will reduce cooling. Do not use the AC adapter while it is inside a carrying case.
- Connect the adapter to a proper power source. The voltage requirements are found on the product case and/or packaging.
- Do not use the adapter if the cord becomes damaged.
- Do not attempt to service the unit. There are no serviceable parts inside. Replace the unit if it is damaged or exposed to excess moisture.

On the Use of the RF Device

USA and Canada Safety Requirements and Notices

IMPORTANT NOTE: To comply with FCC RF exposure compliance requirements, the antenna used for this transmitter must be installed to provide a separation distance of at least 20 cm from all persons and must not be co-located or operating in conjunction with any other antenna or transmitter.

Radio Frequency Interference Requirements and SAR

This device meets the government's requirements for exposure to radio waves.

This device is designed and manufactured not to exceed the emission limits for exposure to radio frequency (RF) energy set by the Federal Communications Commission of the U.S. Government.

This device complies with FCC radiation exposure limits set forth for an uncontrolled environment.

EMC Requirements

This device uses, generates and radiates radio frequency energy. The radio frequency energy produced by this device is well below the maximum exposure allowed by the Federal Communications Commission (FCC).

This device complies with the limits for a Class B digital device pursuant to Part 15 subpart C of the FCC Rules and Regulations. Operation is subject to the following two conditions:

- (1) This device may not cause harmful interference.
- (2) This device must accept any interference received, including interference that may cause undesired operation.

The FCC limits are designed to provide reasonable protection against harmful interference when the equipment is installed and used in accordance with the instruction manual and operated in a commercial

environment. However, there is no guarantee that interference will not occur in a particular commercial installation, or if operated in a residential area.

If harmful interference with radio or television reception occurs when the device is turned on, the user must correct the situation at the user's own expense. The user is encouraged to try one or more of the following corrective measures:

- Reorient or relocate the receiving antenna.
- Increase the separation between the equipment and receiver.
- Connect the equipment into an outlet on a circuit different from that to which the receiver is connected.
- Consult the dealer or an experienced radio/TV technician for help.

CAUTION: The Part 15 radio device operates on a non-interference basis with other devices operating at this frequency. Any changes or modification to said product not expressly approved by the manufacturer could void the user's authority to operate this device.

Canada Radio Frequency Interference Requirements

To prevent radio interference to the licensed service, this device is intended to be operated indoors and away from windows to provide maximum shielding. Equipment (or its transmit antenna) that is installed outdoors is subject to licensing.

Pour empêcher que cet appareil cause du brouillage au service faisant l'objet d'une licence, il doit être utilisé à l'intérieur et devrait être placé loin des fenêtres afin de fournir un écran de blindage maximal. Si le matériel (ou son antenne d'émission) est installé à l'extérieur, il doit faire l'objet d'une licence.

European Union CE Marking and Compliance Notices

Statements of Compliance

English

This product follows the provisions of the European Directive 1999/5/EC.

Danish

Dette produkt er i overensstemmelse med det europæiske direktiv 1999/5/EC.

Dutch

Dit product is in navolging van de bepalingen van Europees Directief 1999/5/EC.

Finnish

Tämä tuote noudattaa EU-direktiivin 1999/5/EC määräyksiä.

French

Ce produit est conforme aux exigences de la Directive Européenne 1999/5/EC.

German

Dieses Produkt entspricht den Bestimmungen der Europäischen Richtlinie 1999/5/EC.

Greek

Το προϊόν αυτό πληροί τις προβλέψεις της Ευρωπαϊκής Οδηγίας 1999/5/EC.

Icelandic

Þessi vara stenst reglugerð Evrópska Efnahags Bandalagsins númer 1999/5/EC.

Italian

Questo prodotto è conforme alla Direttiva Europea 1999/5/EC.

Norwegian

Dette produktet er i henhold til bestemmelsene i det europeiske direktivet 1999/5/EC.

Portuguese

Este produto cumpre com as normas da Diretiva Européia 1999/5/EC.

Spanish

Este producto cumple con las normas del Directivo Europeo 1999/5/EC.

Swedish

Denna produkt har tillverkats i enlighet med EG-direktiv 1999/5/EC.

Restrictions

This device is restricted to indoor use when operating in the 5150 to 5350 MHz frequency range.