



FCC TEST REPORT (15.407)

REPORT NO.: RF120410C09-1
MODEL NO.: E100 AVL
FCC ID: QYLE100AVL
RECEIVED: Apr. 10, 2012
TESTED: Apr. 26 ~ May 08, 2012
ISSUED: May 11, 2012

APPLICANT: Getac Technology Corporation.

ADDRESS: 5F., Building A, No. 209, Sec. 1, Nangang Rd.,
Nangang Dist, Taipei City 11568, Taiwan, R.O.C.

ISSUED BY: Bureau Veritas Consumer Products Services
(H.K.) Ltd., Taoyuan Branch

LAB ADDRESS: No. 47, 14th Ling, Chia Pau Vil., Lin Kou Dist.,
New Taipei City, Taiwan (R.O.C.)

TEST LOCATION: No. 19, Hwa Ya 2nd Rd, Wen Hwa Tsuen, Kwei
Shan Hsiang, Taoyuan Hsien 333, Taiwan, R.O.C.

This test report consists of 96 pages in total. It may be duplicated completely for legal use with the approval of the applicant. It should not be reproduced except in full, without the written approval of our laboratory. The client should not use it to claim product certification, approval or endorsement by TAF or any government agency. The test results in the report only apply to the tested sample.



TABLE OF CONTENTS

RELEASE CONTROL RECORD	4
1. CERTIFICATION	5
2. SUMMARY OF TEST RESULTS	6
2.1 MEASUREMENT UNCERTAINTY	6
3. GENERAL INFORMATION	7
3.1 GENERAL DESCRIPTION OF EUT	7
3.2 DESCRIPTION OF TEST MODES	9
3.2.1 TEST MODE APPLICABILITY AND TESTED CHANNEL DETAIL	10
3.3 DUTY CYCLE OF TEST SIGNAL	12
3.4 DESCRIPTION OF SUPPORT UNITS	12
3.4.1 CONFIGURATION OF SYSTEM UNDER TEST	12
3.5 GENERAL DESCRIPTION OF APPLIED STANDARDS	13
4. TEST TYPES AND RESULTS	14
4.1 RADIATED EMISSION AND BANDEDGE MEASUREMENT	14
4.1.1 LIMITS OF RADIATED EMISSION AND BANDEDGE MEASUREMENT	14
4.1.2 LIMITS OF UNWANTED EMISSION OUT OF THE RESTRICTED BANDS	14
4.1.3 TEST INSTRUMENTS	15
4.1.4 TEST PROCEDURES	16
4.1.5 DEVIATION FROM TEST STANDARD	16
4.1.6 TEST SETUP	17
4.1.7 EUT OPERATING CONDITION	17
4.1.8 TEST RESULTS	18
4.2 CONDUCTED EMISSION MEASUREMENT	66
4.2.1 LIMITS OF CONDUCTED EMISSION MEASUREMENT	66
4.2.2 TEST INSTRUMENTS	66
4.2.3 TEST PROCEDURES	67
4.2.4 DEVIATION FROM TEST STANDARD	67
4.2.5 TEST SETUP	67
4.2.6 EUT OPERATING CONDITIONS	67
4.2.7 TEST RESULTS	68
4.3 PEAK TRANSMIT POWER MEASUREMENT	76
4.3.1 LIMITS OF PEAK TRANSMIT POWER MEASUREMENT	76
4.3.2 TEST SETUP	76
4.3.3 TEST INSTRUMENTS	76
4.3.4 TEST PROCEDURE	77
4.3.5 DEVIATION FROM TEST STANDARD	77
4.3.6 EUT OPERATING CONDITIONS	77
4.3.7 TEST RESULTS	78
4.4 PEAK POWER SPECTRAL DENSITY MEASUREMENT	82
4.4.1 LIMITS OF PEAK POWER SPECTRAL DENSITY MEASUREMENT	82
4.4.2 TEST SETUP	82
4.4.3 TEST INSTRUMENTS	82
4.4.4 TEST PROCEDURES	82
4.4.5 DEVIATION FROM TEST STANDARD	82
4.4.6 EUT OPERATING CONDITIONS	82
4.4.7 TEST RESULTS	83
4.5 PEAK POWER EXCURSION MEASUREMENT	85



A D T

4.5.1	LIMITS OF PEAK POWER EXCURSION MEASUREMENT	85
4.5.2	TEST SETUP	85
4.5.3	TEST INSTRUMENTS	85
4.5.4	TEST PROCEDURE	85
4.5.5	DEVIATION FROM TEST STANDARD	85
4.5.6	EUT OPERATING CONDITIONS	85
4.5.7	TEST RESULTS	86
4.6	FREQUENCY STABILITY	91
4.6.1	LIMITS OF FREQUENCY STABILITY MEASUREMENT	91
4.6.2	TEST SETUP	91
4.6.3	TEST INSTRUMENTS	91
4.6.4	TEST PROCEDURE	92
4.6.5	DEVIATION FROM TEST STANDARD	92
4.6.6	EUT OPERATING CONDITION	92
4.6.7	TEST RESULTS	93
5.	PHOTOGRAPHS OF THE TEST CONFIGURATION	94
6.	INFORMATION ON THE TESTING LABORATORIES	95
7.	APPENDIX A - MODIFICATIONS RECORDERS FOR ENGINEERING CHANGES TO THE EUT BY THE LAB	96



A D T

RELEASE CONTROL RECORD

ISSUE NO.	REASON FOR CHANGE	DATE ISSUED
RF120410C09-1	Original release	May 11, 2012

2. SUMMARY OF TEST RESULTS

The EUT has been tested according to the following specifications:

APPLIED STANDARD: FCC PART 15, SUBPART E (SECTION 15.407)			
STANDARD SECTION	TEST TYPE	RESULT	REMARK
15.407(b)(6)	AC Power Conducted Emission	PASS	Meet the requirement of limit. Minimum passing margin is -12.72dB at 11.05078MHz.
15.407(b/1/2/3) (b)(6)	Spurious Emissions	PASS	Meet the requirement of limit. Minimum passing margin is -1.0dB at 5150.00MHz.
15.407(a/1/2)	Peak Transmit Power	PASS	Meet the requirement of limit.
15.407(a)(6)	Peak Power Excursion	PASS	Meet the requirement of limit.
15.407(a/1/2)	Peak Power Spectral Density	PASS	Meet the requirement of limit.
15.407(g)	Frequency Stability	PASS	Meet the requirement of limit.
15.203	Antenna Requirement	PASS	Antenna connector is UFL.

2.1 MEASUREMENT UNCERTAINTY

Where relevant, the following measurement uncertainty levels have been estimated for tests performed on the EUT as specified in CISPR 16-4-2:

MEASUREMENT	FREQUENCY	UNCERTAINTY
Conducted emissions	9kHz~30MHz	2.44 dB
Radiated emissions	30MHz ~ 200MHz	2.93 dB
	200MHz ~1000MHz	2.95 dB
	1GHz ~ 18GHz	2.26 dB
	18GHz ~ 40GHz	1.94 dB

This uncertainty represents an expanded uncertainty expressed at approximately the 95% confidence level using a coverage factor of $k = 2$.

3. GENERAL INFORMATION

3.1 GENERAL DESCRIPTION OF EUT

EUT	Tablet PC
MODEL NO.	E100 AVL
POWER SUPPLY	19Vdc (Adapter) 14.4Vdc (Battery)
MODULATION TYPE	64QAM, 16QAM, QPSK, BPSK
MODULATION TECHNOLOGY	OFDM
TRANSFER RATE	802.11a: 54.0/ 48.0/ 36.0/ 24.0/ 18.0/ 12.0/ 9.0/ 6.0Mbps 802.11n: up to 300.0Mbps
OPERATING FREQUENCY	5180 ~ 5240MHz, 5260 ~ 5320MHz & 5500 ~ 5700MHz
NUMBER OF CHANNEL	5180 ~ 5240MHz: 8 for 802.11a, 802.11n (20MHz) 4 for 802.11n (40MHz) 5260 ~ 5320MHz: 8 for 802.11a, 802.11n (20MHz) 4 for 802.11n (40MHz) 5500 ~ 5700MHz: 8 for 802.11a, 802.11n (20MHz) 5 for 802.11n (40MHz)
OUTPUT POWER	47.6mW for 5180 ~ 5240MHz 46.8mW for 5260 ~ 5320MHz 47.9mW for 5500 ~ 5700MHz
ANTENNA TYPE	Refer to note as below
ANTENNA CONNECTOR	UFL
DATA CABLE	NA
I/O PORTS	Refer to user's manual
ACCESSORY DEVICES	Adapter, Battery

NOTE:

- The frequency bands used in this EUT are listed as follows:

Frequency Band (MHz)	2412~2462	5180~5240	5260~5320	5500~5700	5745~5825
802.11b	√				
802.11g	√				
802.11a		√	√	√	√
802.11n (20MHz)	√	√	√	√	√
802.11n (40MHz)	√	√	√	√	√

- The WLAN module (Brand: Intel, Model: 62205ANHMW) is collocated in this EUT.
- The antenna used in this EUT is listed as below table:

ITEM	TYPE	GAIN (dBi)				
		5150 MHz	5250 MHz	5350 MHz	5470 MHz	5600 MHz
Main Antenna	PIFA	3.32	3.34	2.58	2.46	3.05
Aux. Antenna	PIFA	4.16	4.29	4.67	4.61	4.60

4. The EUT incorporates a MIMO function. Physically, the EUT provides two completed transmitters and two receivers.

MODULATION MODE	TX FUNCTION
802.11b	1TX
802.11g	1TX
802.11a	1TX
802.11n (20MHz)	1TX / 2TX
802.11n (40MHz)	1TX / 2TX

5. The EUT consumes power from the following adapter & battery.

ADAPTER	
BRAND:	DELTA ELECTRONICS, INC.
MODEL:	ADP-90CD DB
INPUT:	100-240Vac, 50/60Hz, 1.5A
OUTPUT:	19Vdc, 4.74A
POWER LINE:	DC 1.7m non-shielded cable with one core

BATTERY	
BRAND	Getac
MODEL	E100AVL Battery Pack
RATING	14.4Vdc, 4200mAh

6. The above EUT information is declared by manufacturer and for more detailed features description, please refer to the manufacturer's specifications or user's manual.

3.2 DESCRIPTION OF TEST MODES

FOR 5180 ~ 5240MHz

4 channels are provided for 802.11a, 802.11n (20MHz):

CHANNEL	FREQUENCY	CHANNEL	FREQUENCY
36	5180 MHz	44	5220 MHz
40	5200 MHz	48	5240 MHz

2 channels are provided for 802.11n (40MHz):

CHANNEL	FREQUENCY	CHANNEL	FREQUENCY
38	5190 MHz	46	5230 MHz

FOR 5260 ~ 5320MHz

4 channels are provided for 802.11a, 802.11n (20MHz):

CHANNEL	FREQUENCY	CHANNEL	FREQUENCY
52	5260 MHz	60	5300 MHz
56	5280 MHz	64	5320 MHz

2 channels are provided for 802.11n (40MHz):

CHANNEL	FREQUENCY	CHANNEL	FREQUENCY
54	5270 MHz	62	5310 MHz

FOR 5500 ~ 5700MHz

11 channels are provided for 802.11a, 802.11n (20MHz):

CHANNEL	FREQUENCY	CHANNEL	FREQUENCY
100	5500 MHz	124	5620 MHz
104	5520 MHz	128	5640 MHz
108	5540 MHz	132	5660 MHz
112	5560 MHz	136	5680 MHz
116	5580 MHz	140	5700 MHz
120	5600 MHz		

5 channels are provided for 802.11n (40MHz):

CHANNEL	FREQUENCY	CHANNEL	FREQUENCY
102	5510MHz	126	5630MHz
110	5550MHz	134	5670MHz
118	5590MHz		

3.2.1 TEST MODE APPLICABILITY AND TESTED CHANNEL DETAIL

EUT CONFIGURE MODE	APPLICABLE TO				DESCRIPTION
	RE \geq 1G	RE<1G	PLC	APCM	
-	√	√	√	√	-

Where **RE \geq 1G**: Radiated Emission above 1GHz **RE<1G**: Radiated Emission below 1GHz
PLC: Power Line Conducted Emission **APCM**: Antenna Port Conducted Measurement

NOTE: The EUT had been pre-tested on the positioned of each 3 axis. The worst case was found when positioned on **Z-plane**.

RADIATED EMISSION TEST (ABOVE 1GHz):

- Pre-Scan has been conducted to determine the worst-case mode from all possible combinations between available modulations, data rates and antenna ports (if EUT with antenna diversity architecture).
- Following channel(s) was (were) selected for the final test as listed below.

MODE	FREQ. BAND (MHz)	AVAILABLE CHANNEL	TESTED CHANNEL	MODULATION TECHNOLOGY	MODULATION TYPE	DATA RATE (Mbps)	TX Function
802.11a	5180-5240	36 to 48	36, 40, 48	OFDM	BPSK	6.0	1TX
802.11n (20MHz)		36 to 48	36, 40, 48	OFDM	BPSK	7.2	1TX
802.11n (40MHz)		38 to 46	38, 46	OFDM	BPSK	15.0	1TX
802.11n (20MHz)		36 to 48	36, 40, 48	OFDM	BPSK	14.4	2TX
802.11n (40MHz)		38 to 46	38, 46	OFDM	BPSK	30.0	2TX
802.11a	5260-5320	52 to 64	52, 60, 64	OFDM	BPSK	6.0	1TX
802.11n (20MHz)		52 to 64	52, 60, 64	OFDM	BPSK	7.2	1TX
802.11n (40MHz)		54 to 62	54, 62	OFDM	BPSK	15.0	1TX
802.11n (20MHz)		52 to 64	52, 60, 64	OFDM	BPSK	14.4	2TX
802.11n (40MHz)		54 to 62	54, 62	OFDM	BPSK	30.0	2TX
802.11a	5500-5700	100 to 140	100, 116, 132, 140	OFDM	BPSK	6.0	1TX
802.11n (20MHz)		100 to 140	100, 116, 132, 140	OFDM	BPSK	7.2	1TX
802.11n (40MHz)		102 to 134	102, 110, 134	OFDM	BPSK	15.0	1TX
802.11n (20MHz)		100 to 140	100, 116, 132, 140	OFDM	BPSK	14.4	2TX
802.11n (40MHz)		102 to 134	102, 110, 134	OFDM	BPSK	30.0	2TX

RADIATED EMISSION TEST (BELOW 1GHz):

- Pre-Scan has been conducted to determine the worst-case mode from all possible combinations between available modulations, data rates and antenna ports (if EUT with antenna diversity architecture).
- Following channel(s) was (were) selected for the final test as listed below.

MODE	FREQ. BAND (MHz)	AVAILABLE CHANNEL	TESTED CHANNEL	MODULATION TECHNOLOGY	MODULATION TYPE	DATA RATE (Mbps)	TX Function
802.11n (20MHz)	5180-5320	36 to 64	60	OFDM	BPSK	7.2	1TX
802.11n (20MHz)	5500-5700	100 to 140	116	OFDM	BPSK	7.2	1TX
802.11n (40MHz)	5180-5320	38 to 46	38	OFDM	BPSK	30.0	2TX
802.11n (20MHz)	5500-5700	100 to 140	100	OFDM	BPSK	14.4	2TX

POWER LINE CONDUCTED EMISSION TEST:

- Pre-Scan has been conducted to determine the worst-case mode from all possible combinations between available modulations, data rates and antenna ports (if EUT with antenna diversity architecture).
- Following channel(s) was (were) selected for the final test as listed below.

MODE	FREQ. BAND (MHz)	AVAILABLE CHANNEL	TESTED CHANNEL	MODULATION TECHNOLOGY	MODULATION TYPE	DATA RATE (Mbps)	TX Function
802.11n (20MHz)	5180-5320	36 to 64	60	OFDM	BPSK	7.2	1TX
802.11n (20MHz)	5500-5700	100 to 140	116	OFDM	BPSK	7.2	1TX
802.11n (40MHz)	5180-5320	38 to 46	38	OFDM	BPSK	30.0	2TX
802.11n (20MHz)	5500-5700	100 to 140	100	OFDM	BPSK	14.4	2TX

ANTENNA PORT CONDUCTED MEASUREMENT:

- This item includes all test value of each mode, but only includes spectrum plot of worst value of each mode.
- Pre-Scan has been conducted to determine the worst-case mode from all possible combinations between available modulations, data rates and antenna ports (if EUT with antenna diversity architecture).
- Following channel(s) was (were) selected for the final test as listed below.

MODE	FREQ. BAND (MHz)	AVAILABLE CHANNEL	TESTED CHANNEL	MODULATION TECHNOLOGY	MODULATION TYPE	DATA RATE (Mbps)	TX Function
802.11a	5180-5240	36 to 48	36, 40, 48	OFDM	BPSK	6.0	1TX
802.11n (20MHz)		36 to 48	36, 40, 48	OFDM	BPSK	7.2	1TX
802.11n (40MHz)		38 to 46	38, 46	OFDM	BPSK	15.0	1TX
802.11n (20MHz)		36 to 48	36, 40, 48	OFDM	BPSK	14.4	2TX
802.11n (40MHz)		38 to 46	38, 46	OFDM	BPSK	30.0	2TX
802.11a	5260-5320	52 to 64	52, 60, 64	OFDM	BPSK	6.0	1TX
802.11n (20MHz)		52 to 64	52, 60, 64	OFDM	BPSK	7.2	1TX
802.11n (40MHz)		54 to 62	54, 62	OFDM	BPSK	15.0	1TX
802.11n (20MHz)		52 to 64	52, 60, 64	OFDM	BPSK	14.4	2TX
802.11n (40MHz)		54 to 62	54, 62	OFDM	BPSK	30.0	2TX
802.11a	5500-5700	100 to 140	100, 116, 132, 140	OFDM	BPSK	6.0	1TX
802.11n (20MHz)		100 to 140	100, 116, 132, 140	OFDM	BPSK	7.2	1TX
802.11n (40MHz)		102 to 134	102, 110, 134	OFDM	BPSK	15.0	1TX
802.11n (20MHz)		100 to 140	100, 116, 132, 140	OFDM	BPSK	14.4	2TX
802.11n (40MHz)		102 to 134	102, 110, 134	OFDM	BPSK	30.0	2TX

TEST CONDITION:

APPLICABLE TO	ENVIRONMENTAL CONDITIONS	INPUT POWER	TESTED BY
RE _≥ 1G	22deg. C, 73%RH 21deg. C, 69%RH	120Vac, 60Hz	Anderson Hong Sun Lin
RE<1G	21deg. C, 69%RH	120Vac, 60Hz	Anderson Hong
PLC	25deg. C, 65%RH	120Vac, 60Hz	Anderson Hong
APCM	23deg. C, 70%RH	120Vac, 60Hz	Anderson Hong

3.3 DUTY CYCLE OF TEST SIGNAL

Duty cycle of test signal is > 98 %

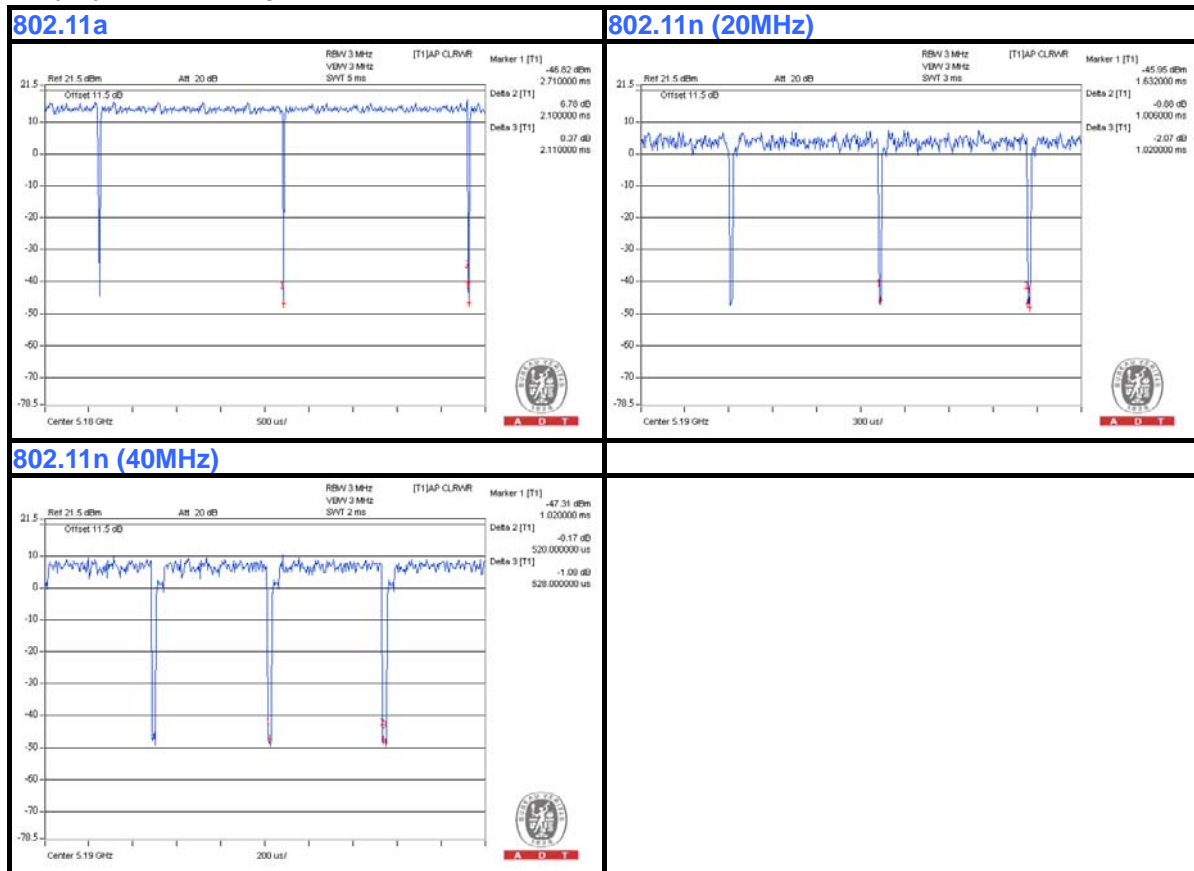

3.4 DESCRIPTION OF SUPPORT UNITS

The EUT has been tested as an independent unit together with other necessary accessories or support units. The following support units or accessories were used to form a representative test configuration during the tests.

NO.	PRODUCT	BRAND	MODEL NO.	SERIAL NO.	FCC ID
1	EARPHONE	PHILIPS	SBC HL150	NA	NA
2	DONGLE	Transcend	PQI	NA	NA
3	DONGLE	Transcend	U273	NA	NA
4	NOTEBOOK	DELL	D531	CN-0XM006-48643-81U-2610	NA

NO.	SIGNAL CABLE DESCRIPTION OF THE ABOVE SUPPORT UNITS
1	1.5m non-shielded cable
2	NA
3	NA
4	10m RJ45 UTP cable

NOTE:

1. All power cords of the above support units are non shielded (1.8m).
2. Item 4 acted as communication partner to transfer data.

3.4.1 CONFIGURATION OF SYSTEM UNDER TEST

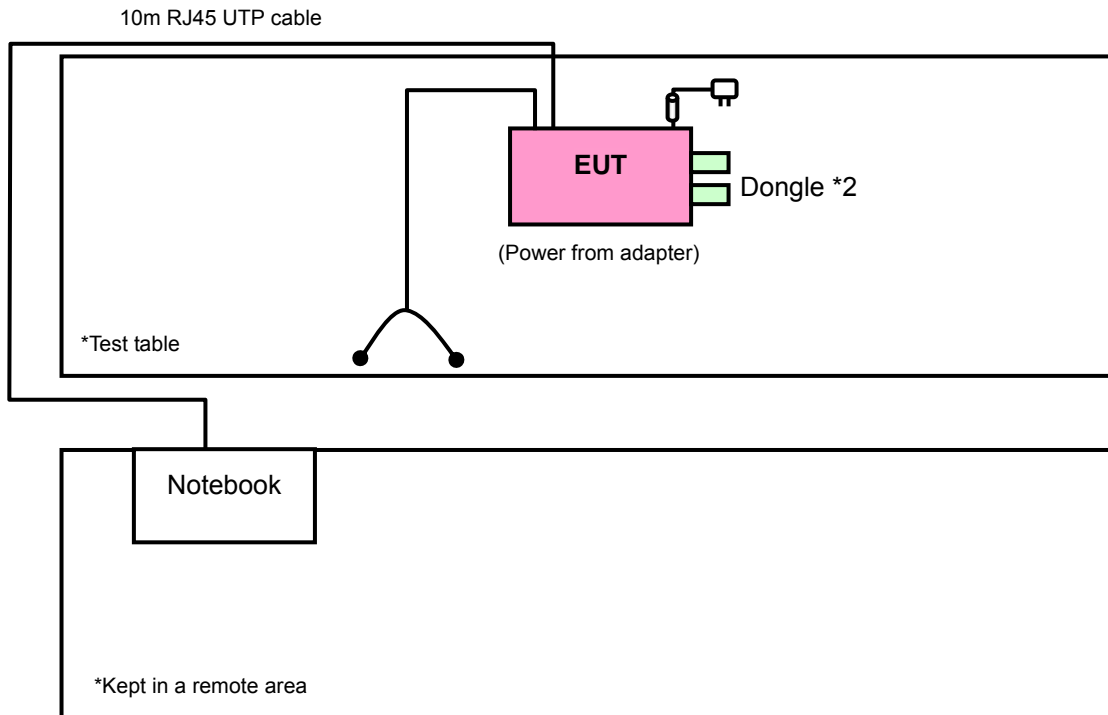

3.5 GENERAL DESCRIPTION OF APPLIED STANDARDS

The EUT is a RF Product. According to the specifications of the manufacturer, it must comply with the requirements of the following standards:

FCC Part 15, Subpart E (15.407)

ANSI C63.10-2009

KDB 789033 D01 General UNII Test Procedures v01r01

All test items have been performed and recorded as per the above standards.

NOTE: The EUT is also considered as a kind of computer peripheral, because the connection to computer is necessary for typical use. It has been verified to comply with the requirements of FCC Part 15, Subpart B, Class B (DoC). The test report has been issued separately.

4. TEST TYPES AND RESULTS

4.1 RADIATED EMISSION AND BANDEDGE MEASUREMENT

4.1.1 LIMITS OF RADIATED EMISSION AND BANDEDGE MEASUREMENT

Radiated emissions which fall in the restricted bands must comply with the radiated emission limits specified as below table:

FREQUENCIES (MHz)	FIELD STRENGTH (microvolts/meter)	MEASUREMENT DISTANCE (meters)
0.009 ~ 0.490	2400/F(kHz)	300
0.490 ~ 1.705	24000/F(kHz)	30
1.705 ~ 30.0	30	30
30 ~ 88	100	3
88 ~ 216	150	3
216 ~ 960	200	3
Above 960	500	3

NOTE:

1. The lower limit shall apply at the transition frequencies.
2. Emission level (dBuV/m) = 20 log Emission level (uV/m).
3. For frequencies above 1000MHz, the field strength limits are based on average detector, however, the peak field strength of any emission shall not exceed the maximum permitted average limits, specified above by more than 20dB under any condition of modulation.

4.1.2 LIMITS OF UNWANTED EMISSION OUT OF THE RESTRICTED BANDS

EIRP LIMIT (dBm)	EQUIVALENT FIELD STRENGTH AT 3m (dBµV/m)
PK	PK
-27	68.3

NOTE: The following formula is used to convert the equipment isotropic radiated power (eirp) to field strength:

$$E = \frac{1000000\sqrt{30P}}{3} \mu\text{V/m, where P is the eirp (Watts).}$$

4.1.3 TEST INSTRUMENTS

DESCRIPTION & MANUFACTURER	MODEL NO.	SERIAL NO.	DATE OF CALIBRATION	DUE DATE OF CALIBRATION
Test Receiver ROHDE & SCHWARZ	ESCI	100744	Apr. 19, 2012	Apr. 18, 2013
Spectrum Analyzer ROHDE & SCHWARZ	FSP40	100040	Aug. 04, 2011	Aug. 03, 2012
BILOG Antenna SCHWARZBECK	VULB9168	9168-156	Apr. 03, 2012	Apr. 02, 2013
HORN Antenna SCHWARZBECK	BBHA 9120 D	9120D-563	Sep. 06, 2011	Sep. 05, 2012
HORN Antenna SCHWARZBECK	BBHA 9170	148	Jul. 20, 2011	Jul. 19, 2012
Preamplifier Agilent	8449B	3008A01911	Oct. 29, 2011	Oct. 28, 2012
Preamplifier Agilent	8447D	2944A10638	Oct. 29, 2011	Oct. 28, 2012
RF signal cable HUBER+SUHNNER	SUCOFLEX 104	295013/4 283403/4	Aug. 19, 2011	Aug. 18, 2012
RF signal cable Worken	8D-FB	Cable-HYCH9-01	Aug. 13, 2011	Aug. 12, 2012
Software	ADT_Radiated_ V7.6.15.9.2	NA	NA	NA
Antenna Tower EMCO	2070/2080	512.835.4684	NA	NA
Turn Table EMCO	2087-2.03	NA	NA	NA
Antenna Tower & Turn Table Controller EMCO	2090	NA	NA	NA
Turn Table ADT.	TT100.	TT93021704	NA	NA
Turn Table Controller ADT.	SC100.	SC93021704	NA	NA
Loop Antenna	HFH2-Z2	100070	Jan. 31, 2012	Jan. 30, 2014
26GHz ~ 40GHz Amplifier	EM26400	815221	Oct. 29, 2011	Oct. 28, 2012
High Speed Peak Power Meter	ML2495A	0824011	Aug. 04, 2011	Aug. 03, 2012
Power Sensor	MA2411B	0738171	Aug. 04, 2011	Aug. 03, 2012
WIT Standard Temperature And Humidity Chamber	TH-4S-C	W981030	Jun. 15, 2011	Jun. 14, 2012

- NOTE:**
1. The calibration interval of the above test instruments is 12 months and the calibrations are traceable to NML/ROC and NIST/USA.
 2. The calibration interval of the loop antenna is 24 months and the calibrations are traceable to NML/ROC and NIST/USA.
 3. The test was performed in HwaYa Chamber 4.
 4. The horn antenna and HP preamplifier (model: 8449B) are used only for the measurement of emission frequency above 1GHz if tested.
 5. The FCC Site Registration No. is 460141.
 6. The IC Site Registration No. is IC7450F-4.

4.1.4 TEST PROCEDURES

- a. The EUT was placed on the top of a rotating table 0.8 meters above the ground at a 3 meter semi-anechoic chamber. The table was rotated 360 degrees to determine the position of the highest radiation.
- b. The EUT was set 3 meters away from the interference-receiving antenna, which was mounted on the top of a variable-height antenna tower.
- c. The antenna is a broadband antenna, and its height is varied from one meter to four meters above the ground to determine the maximum value of the field strength. Both horizontal and vertical polarizations of the antenna are set to make the measurement.
- d. For each suspected emission, the EUT was arranged to its worst case and then the antenna was tuned to heights from 1 meter to 4 meters and the rotatable table was turned from 0 degrees to 360 degrees to find the maximum reading.
- e. The test-receiver system was set to Peak Detect Function and Specified Bandwidth with Maximum Hold Mode.
- f. If the emission level of the EUT in peak mode was 10dB lower than the limit specified, then testing could be stopped and the peak values of the EUT would be reported. Otherwise the emissions that did not have 10dB margin would be re-tested one by one using peak, quasi-peak or average method as specified and then reported in a data sheet.

NOTE:

1. The resolution bandwidth and video bandwidth of test receiver/spectrum analyzer is 120kHz for Peak detection (PK) and Quasi-peak detection (QP) at frequency below 1GHz.
2. The resolution bandwidth of test receiver/spectrum analyzer is 1MHz and video bandwidth is 3MHz for Peak detection at frequency above 1GHz.
3. The resolution bandwidth of test receiver/spectrum analyzer is 1MHz and the video bandwidth is 1kHz for Average detection (AV) at frequency above 1GHz.
4. All modes of operation were investigated and the worst-case emissions are reported.

4.1.5 DEVIATION FROM TEST STANDARD

No deviation.

4.1.6 TEST SETUP

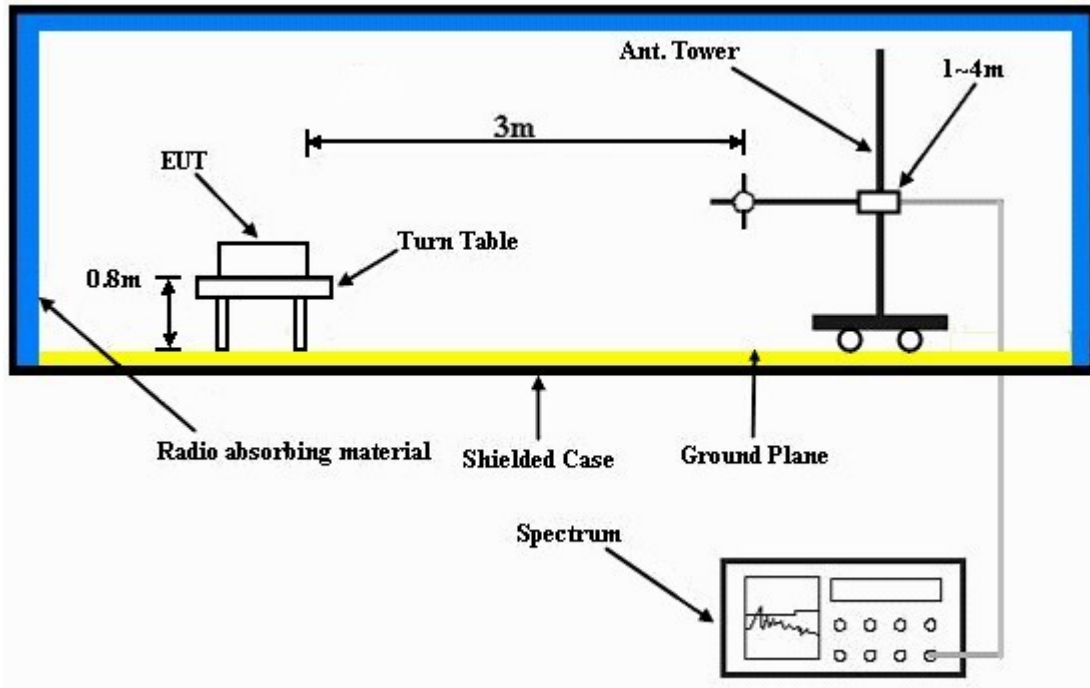

For the actual test configuration, please refer to the attached file (Test Setup Photo).

4.1.7 EUT OPERATING CONDITION

- Placed the EUT on the testing table.
- Prepared notebooks to act as communication partner and placed it outside of testing area.
- The communication partner connected with EUT via a RJ45 cable and run a test program (provided by manufacturer) to enable EUT under transmission condition continuously at specific channel frequency.
- The communication partner sent data to EUT by command "PING".

4.1.8 TEST RESULTS

ABOVE 1GHz DATA:

802.11a: 1TX

EUT TEST CONDITION		MEASUREMENT DETAIL	
CHANNEL	Channel 36	FREQUENCY RANGE	1 ~ 40GHz
INPUT POWER (SYSTEM)	120Vac, 60 Hz	DETECTOR FUNCTION	Peak (PK) Average (AV)
ENVIRONMENTAL CONDITIONS	22deg. C, 73%RH	TESTED BY	Sun Lin

ANTENNA POLARITY & TEST DISTANCE: HORIZONTAL AT 3 M								
NO.	FREQ. (MHz)	EMISSION LEVEL (dBuV/m)	LIMIT (dBuV/m)	MARGIN (dB)	ANTENNA HEIGHT (m)	TABLE ANGLE (Degree)	RAW VALUE (dBuV)	CORRECTION FACTOR (dB/m)
1	5150.00	57.2 PK	74.0	-16.8	1.16 H	171	19.00	38.20
2	5150.00	40.8 AV	54.0	-13.2	1.16 H	171	2.60	38.20
3	*5180.00	104.5 PK			1.36 H	171	66.30	38.20
4	*5180.00	94.0 AV			1.36 H	171	55.80	38.20
5	#10360.00	54.9 PK	68.3	-13.4	1.02 H	39	6.90	48.00
ANTENNA POLARITY & TEST DISTANCE: VERTICAL AT 3 M								
NO.	FREQ. (MHz)	EMISSION LEVEL (dBuV/m)	LIMIT (dBuV/m)	MARGIN (dB)	ANTENNA HEIGHT (m)	TABLE ANGLE (Degree)	RAW VALUE (dBuV)	CORRECTION FACTOR (dB/m)
1	5150.00	57.9 PK	74.0	-16.1	1.32 V	177	19.70	38.20
2	5150.00	42.2 AV	54.0	-11.8	1.32 V	177	4.00	38.20
3	*5180.00	106.4 PK			1.20 V	176	68.20	38.20
4	*5180.00	95.7 AV			1.20 V	176	57.50	38.20
5	#10360.00	56.1 PK	68.3	-12.2	1.27 V	92	8.10	48.00

REMARKS:

1. Emission level (dBuV/m) = Raw Value (dBuV) + Correction Factor (dB/m).
2. Correction Factor (dB/m) = Antenna Factor (dB/m) + Cable Factor (dB).
3. The other emission levels were very low against the limit.
4. Margin value = Emission level – Limit value.
5. “ * “: Fundamental frequency.
6. “#”:The radiated frequency is out the restricted band.



A D T

EUT TEST CONDITION		MEASUREMENT DETAIL	
CHANNEL	Channel 40	FREQUENCY RANGE	1 ~ 40GHz
INPUT POWER (SYSTEM)	120Vac, 60 Hz	DETECTOR FUNCTION	Peak (PK) Average (AV)
ENVIRONMENTAL CONDITIONS	22deg. C, 73%RH	TESTED BY	Sun Lin

ANTENNA POLARITY & TEST DISTANCE: HORIZONTAL AT 3 M								
NO.	FREQ. (MHz)	EMISSION LEVEL (dBuV/m)	LIMIT (dBuV/m)	MARGIN (dB)	ANTENNA HEIGHT (m)	TABLE ANGLE (Degree)	RAW VALUE (dBuV)	CORRECTION FACTOR (dB/m)
1	*5200.00	103.9 PK			1.21 H	158	65.70	38.20
2	*5200.00	93.5 AV			1.21 H	158	55.30	38.20
3	#10400.00	54.0 PK	68.3	-14.3	1.21 H	23	5.90	48.10
4	15600.00	54.9 PK	74.0	-19.1	1.29 H	15	5.80	49.10
5	15600.00	44.5 AV	54.0	-9.5	1.29 H	15	-4.60	49.10
ANTENNA POLARITY & TEST DISTANCE: VERTICAL AT 3 M								
NO.	FREQ. (MHz)	EMISSION LEVEL (dBuV/m)	LIMIT (dBuV/m)	MARGIN (dB)	ANTENNA HEIGHT (m)	TABLE ANGLE (Degree)	RAW VALUE (dBuV)	CORRECTION FACTOR (dB/m)
1	*5200.00	105.7 PK			1.42 V	175	67.50	38.20
2	*5200.00	94.3 AV			1.42 V	175	56.10	38.20
3	#10400.00	56.1 PK	68.3	-12.2	1.07 V	196	8.00	48.10
4	15600.00	56.7 PK	74.0	-17.3	1.37 V	25	7.60	49.10
5	15600.00	45.1 AV	54.0	-8.9	1.37 V	25	-4.00	49.10

REMARKS:

1. Emission level (dBuV/m) = Raw Value (dBuV) + Correction Factor (dB/m).
2. Correction Factor (dB/m) = Antenna Factor (dB/m) + Cable Factor (dB).
3. The other emission levels were very low against the limit.
4. Margin value = Emission level – Limit value.
5. " * ": Fundamental frequency.
6. "#": The radiated frequency is out the restricted band.



A D T

EUT TEST CONDITION		MEASUREMENT DETAIL	
CHANNEL	Channel 48	FREQUENCY RANGE	1 ~ 40GHz
INPUT POWER (SYSTEM)	120Vac, 60 Hz	DETECTOR FUNCTION	Peak (PK) Average (AV)
ENVIRONMENTAL CONDITIONS	22deg. C, 73%RH	TESTED BY	Sun Lin

ANTENNA POLARITY & TEST DISTANCE: HORIZONTAL AT 3 M								
NO.	FREQ. (MHz)	EMISSION LEVEL (dBuV/m)	LIMIT (dBuV/m)	MARGIN (dB)	ANTENNA HEIGHT (m)	TABLE ANGLE (Degree)	RAW VALUE (dBuV)	CORRECTION FACTOR (dB/m)
1	*5240.00	104.3 PK			1.17 H	168	66.00	38.30
2	*5240.00	94.5 AV			1.17 H	168	56.20	38.30
3	#10480.00	54.2 PK	68.3	-14.1	1.34 H	52	6.00	48.20
4	15720.00	54.3 PK	74.0	-19.7	1.22 H	8	5.40	48.90
5	15720.00	43.9 AV	54.0	-10.1	1.22 H	8	-5.00	48.90

ANTENNA POLARITY & TEST DISTANCE: VERTICAL AT 3 M								
NO.	FREQ. (MHz)	EMISSION LEVEL (dBuV/m)	LIMIT (dBuV/m)	MARGIN (dB)	ANTENNA HEIGHT (m)	TABLE ANGLE (Degree)	RAW VALUE (dBuV)	CORRECTION FACTOR (dB/m)
1	*5240.00	107.4 PK			1.09 V	176	69.10	38.30
2	*5240.00	96.7 AV			1.09 V	176	58.40	38.30
3	#10480.00	56.1 PK	68.3	-12.2	1.32 V	47	7.90	48.20
4	15720.00	56.7 PK	74.0	-17.3	1.35 V	57	7.80	48.90
5	15720.00	45.7 AV	54.0	-8.3	1.35 V	57	-3.20	48.90

REMARKS:

1. Emission level (dBuV/m) = Raw Value (dBuV) + Correction Factor (dB/m).
2. Correction Factor (dB/m) = Antenna Factor (dB/m) + Cable Factor (dB).
3. The other emission levels were very low against the limit.
4. Margin value = Emission level – Limit value.
5. " * ": Fundamental frequency.
6. "#": The radiated frequency is out the restricted band.



A D T

EUT TEST CONDITION		MEASUREMENT DETAIL	
CHANNEL	Channel 52	FREQUENCY RANGE	1 ~ 40GHz
INPUT POWER (SYSTEM)	120Vac, 60 Hz	DETECTOR FUNCTION	Peak (PK) Average (AV)
ENVIRONMENTAL CONDITIONS	23deg. C, 70%RH	TESTED BY	Sun Lin

ANTENNA POLARITY & TEST DISTANCE: HORIZONTAL AT 3 M								
NO.	FREQ. (MHz)	EMISSION LEVEL (dBuV/m)	LIMIT (dBuV/m)	MARGIN (dB)	ANTENNA HEIGHT (m)	TABLE ANGLE (Degree)	RAW VALUE (dBuV)	CORRECTION FACTOR (dB/m)
1	*5260.00	103.7 PK			1.12 H	21	65.40	38.30
2	*5260.00	93.5 AV			1.12 H	21	55.20	38.30
3	#10520.00	54.9 PK	68.3	-13.4	1.29 H	258	6.60	48.30
4	15780.00	54.9 PK	74.0	-19.1	1.12 H	127	6.10	48.80
5	15780.00	43.8 AV	54.0	-10.2	1.12 H	127	-5.00	48.80
ANTENNA POLARITY & TEST DISTANCE: VERTICAL AT 3 M								
NO.	FREQ. (MHz)	EMISSION LEVEL (dBuV/m)	LIMIT (dBuV/m)	MARGIN (dB)	ANTENNA HEIGHT (m)	TABLE ANGLE (Degree)	RAW VALUE (dBuV)	CORRECTION FACTOR (dB/m)
1	*5260.00	107.5 PK			1.20 V	358	69.20	38.30
2	*5260.00	96.8 AV			1.20 V	358	58.50	38.30
3	#10520.00	56.3 PK	68.3	-12.0	1.27 V	169	8.00	48.30
4	15780.00	55.3 PK	74.0	-18.7	1.51 V	233	6.50	48.80
5	15780.00	44.1 AV	54.0	-9.9	1.51 V	233	-4.70	48.80

REMARKS:

1. Emission level (dBuV/m) = Raw Value (dBuV) + Correction Factor (dB/m).
2. Correction Factor (dB/m) = Antenna Factor (dB/m) + Cable Factor (dB).
3. The other emission levels were very low against the limit.
4. Margin value = Emission level – Limit value.
5. " * ": Fundamental frequency.
6. "#": The radiated frequency is out the restricted band.



A D T

EUT TEST CONDITION		MEASUREMENT DETAIL	
CHANNEL	Channel 60	FREQUENCY RANGE	1 ~ 40GHz
INPUT POWER (SYSTEM)	120Vac, 60 Hz	DETECTOR FUNCTION	Peak (PK) Average (AV)
ENVIRONMENTAL CONDITIONS	23deg. C, 70%RH	TESTED BY	Sun Lin

ANTENNA POLARITY & TEST DISTANCE: HORIZONTAL AT 3 M								
NO.	FREQ. (MHz)	EMISSION LEVEL (dBuV/m)	LIMIT (dBuV/m)	MARGIN (dB)	ANTENNA HEIGHT (m)	TABLE ANGLE (Degree)	RAW VALUE (dBuV)	CORRECTION FACTOR (dB/m)
1	*5300.00	103.8 PK			1.15 H	7	65.40	38.40
2	*5300.00	93.5 AV			1.15 H	7	55.10	38.40
3	10600.00	54.3 PK	74.0	-19.7	1.32 H	261	6.00	48.30
4	10600.00	43.6 AV	54.0	-10.4	1.32 H	261	-4.70	48.30
5	15900.00	54.1 PK	74.0	-19.9	1.18 H	145	5.70	48.40
6	15900.00	42.8 AV	54.0	-11.2	1.18 H	145	-5.60	48.40
ANTENNA POLARITY & TEST DISTANCE: VERTICAL AT 3 M								
NO.	FREQ. (MHz)	EMISSION LEVEL (dBuV/m)	LIMIT (dBuV/m)	MARGIN (dB)	ANTENNA HEIGHT (m)	TABLE ANGLE (Degree)	RAW VALUE (dBuV)	CORRECTION FACTOR (dB/m)
1	*5300.00	107.9 PK			1.18 V	348	69.50	38.40
2	*5300.00	97.2 AV			1.18 V	348	58.80	38.40
3	10600.00	56.5 PK	74.0	-17.5	1.35 V	177	8.20	48.30
4	10600.00	45.7 AV	54.0	-8.3	1.35 V	177	-2.60	48.30
5	15900.00	55.8 PK	74.0	-18.2	1.49 V	241	7.40	48.40
6	15900.00	44.3 AV	54.0	-9.7	1.49 V	241	-4.10	48.40

REMARKS:

1. Emission level (dBuV/m) = Raw Value (dBuV) + Correction Factor (dB/m).
2. Correction Factor (dB/m) = Antenna Factor (dB/m) + Cable Factor (dB).
3. The other emission levels were very low against the limit.
4. Margin value = Emission level – Limit value.
5. “ * “: Fundamental frequency.



A D T

EUT TEST CONDITION		MEASUREMENT DETAIL	
CHANNEL	Channel 64	FREQUENCY RANGE	1 ~ 40GHz
INPUT POWER (SYSTEM)	120Vac, 60 Hz	DETECTOR FUNCTION	Peak (PK) Average (AV)
ENVIRONMENTAL CONDITIONS	23deg. C, 70%RH	TESTED BY	Sun Lin

ANTENNA POLARITY & TEST DISTANCE: HORIZONTAL AT 3 M								
NO.	FREQ. (MHz)	EMISSION LEVEL (dBuV/m)	LIMIT (dBuV/m)	MARGIN (dB)	ANTENNA HEIGHT (m)	TABLE ANGLE (Degree)	RAW VALUE (dBuV)	CORRECTION FACTOR (dB/m)
1	*5320.00	103.2 PK			1.12 H	357	64.80	38.40
2	*5320.00	92.6 AV			1.12 H	357	54.20	38.40
3	5350.00	57.5 PK	74.0	-16.5	1.41 H	359	19.00	38.50
4	5350.00	44.7 AV	54.0	-9.3	1.41 H	359	6.20	38.50
5	10640.00	54.0 PK	74.0	-20.0	1.34 H	295	5.50	48.50
6	10640.00	44.3 AV	54.0	-9.7	1.34 H	295	-4.20	48.50
ANTENNA POLARITY & TEST DISTANCE: VERTICAL AT 3 M								
NO.	FREQ. (MHz)	EMISSION LEVEL (dBuV/m)	LIMIT (dBuV/m)	MARGIN (dB)	ANTENNA HEIGHT (m)	TABLE ANGLE (Degree)	RAW VALUE (dBuV)	CORRECTION FACTOR (dB/m)
1	*5320.00	107.1 PK			1.18 V	3	68.70	38.40
2	*5320.00	96.5 AV			1.18 V	3	58.10	38.40
3	5350.00	60.6 PK	74.0	-13.4	1.17 V	1	22.10	38.50
4	5350.00	47.0 AV	54.0	-7.0	1.17 V	1	8.50	38.50
5	10640.00	55.9 PK	74.0	-18.1	1.47 V	221	7.40	48.50
6	10640.00	45.1 AV	54.0	-8.9	1.47 V	221	-3.40	48.50

REMARKS:

1. Emission level (dBuV/m) = Raw Value (dBuV) + Correction Factor (dB/m).
2. Correction Factor (dB/m) = Antenna Factor (dB/m) + Cable Factor (dB).
3. The other emission levels were very low against the limit.
4. Margin value = Emission level – Limit value.
5. “ * “: Fundamental frequency.



A D T

EUT TEST CONDITION		MEASUREMENT DETAIL	
CHANNEL	Channel 100	FREQUENCY RANGE	1 ~ 40GHz
INPUT POWER (SYSTEM)	120Vac, 60 Hz	DETECTOR FUNCTION	Peak (PK) Average (AV)
ENVIRONMENTAL CONDITIONS	23deg. C, 70%RH	TESTED BY	Sun Lin

ANTENNA POLARITY & TEST DISTANCE: HORIZONTAL AT 3 M								
NO.	FREQ. (MHz)	EMISSION LEVEL (dBuV/m)	LIMIT (dBuV/m)	MARGIN (dB)	ANTENNA HEIGHT (m)	TABLE ANGLE (Degree)	RAW VALUE (dBuV)	CORRECTION FACTOR (dB/m)
1	5460.00	58.1 PK	74.0	-15.9	1.12 H	17	19.40	38.70
2	5460.00	38.7 AV	54.0	-15.3	1.12 H	17	0.00	38.70
3	#5470.00	59.5 PK	68.3	-8.8	1.12 H	17	20.80	38.70
4	*5500.00	102.4 PK			1.17 H	7	63.70	38.70
5	*5500.00	92.1 AV			1.17 H	7	53.40	38.70
6	11000.00	54.1 PK	74.0	-19.9	1.37 H	212	4.90	49.20
7	11000.00	43.3 AV	54.0	-10.7	1.37 H	212	-5.90	49.20
ANTENNA POLARITY & TEST DISTANCE: VERTICAL AT 3 M								
NO.	FREQ. (MHz)	EMISSION LEVEL (dBuV/m)	LIMIT (dBuV/m)	MARGIN (dB)	ANTENNA HEIGHT (m)	TABLE ANGLE (Degree)	RAW VALUE (dBuV)	CORRECTION FACTOR (dB/m)
1	5460.00	63.5 PK	74.0	-10.5	1.15 V	3	24.80	38.70
2	5460.00	46.8 AV	54.0	-7.2	1.15 V	3	8.10	38.70
3	#5470.00	67.0 PK	68.3	-1.3	1.15 V	3	28.30	38.70
4	*5500.00	106.5 PK			1.04 V	1	67.80	38.70
5	*5500.00	96.3 AV			1.04 V	1	57.60	38.70
6	11000.00	55.7 PK	74.0	-18.3	1.58 V	213	6.50	49.20
7	11000.00	44.7 AV	54.0	-9.3	1.58 V	213	-4.50	49.20

REMARKS:

1. Emission level (dBuV/m) = Raw Value (dBuV) + Correction Factor (dB/m).
2. Correction Factor (dB/m) = Antenna Factor (dB/m) + Cable Factor (dB).
3. The other emission levels were very low against the limit.
4. Margin value = Emission level – Limit value.
5. “ * “: Fundamental frequency.
6. “#”:The radiated frequency is out the restricted band.



A D T

EUT TEST CONDITION		MEASUREMENT DETAIL	
CHANNEL	Channel 116	FREQUENCY RANGE	1 ~ 40GHz
INPUT POWER (SYSTEM)	120Vac, 60 Hz	DETECTOR FUNCTION	Peak (PK) Average (AV)
ENVIRONMENTAL CONDITIONS	23deg. C, 70%RH	TESTED BY	Sun Lin

ANTENNA POLARITY & TEST DISTANCE: HORIZONTAL AT 3 M								
NO.	FREQ. (MHz)	EMISSION LEVEL (dBuV/m)	LIMIT (dBuV/m)	MARGIN (dB)	ANTENNA HEIGHT (m)	TABLE ANGLE (Degree)	RAW VALUE (dBuV)	CORRECTION FACTOR (dB/m)
1	*5580.00	103.4 PK			1.04 H	1	64.50	38.90
2	*5580.00	93.2 AV			1.04 H	1	54.30	38.90
3	11160.00	52.6 PK	74.0	-21.4	1.18 H	202	3.30	49.30
4	11160.00	42.2 AV	54.0	-11.8	1.18 H	202	-7.10	49.30
5	#16740.00	53.5 PK	68.3	-14.8	1.08 H	109	2.00	51.50
ANTENNA POLARITY & TEST DISTANCE: VERTICAL AT 3 M								
NO.	FREQ. (MHz)	EMISSION LEVEL (dBuV/m)	LIMIT (dBuV/m)	MARGIN (dB)	ANTENNA HEIGHT (m)	TABLE ANGLE (Degree)	RAW VALUE (dBuV)	CORRECTION FACTOR (dB/m)
1	*5580.00	107.3 PK			1.14 V	359	68.40	38.90
2	*5580.00	96.7 AV			1.14 V	359	57.80	38.90
3	11160.00	55.4 PK	74.0	-18.6	1.31 V	249	6.10	49.30
4	11160.00	44.7 AV	54.0	-9.3	1.31 V	249	-4.60	49.30
5	#16740.00	55.8 PK	68.3	-12.5	1.52 V	234	4.30	51.50

REMARKS:

1. Emission level (dBuV/m) = Raw Value (dBuV) + Correction Factor (dB/m).
2. Correction Factor (dB/m) = Antenna Factor (dB/m) + Cable Factor (dB).
3. The other emission levels were very low against the limit.
4. Margin value = Emission level – Limit value.
5. " * ": Fundamental frequency.
6. "#": The radiated frequency is out the restricted band.



A D T

EUT TEST CONDITION		MEASUREMENT DETAIL	
CHANNEL	Channel 132	FREQUENCY RANGE	1 ~ 40GHz
INPUT POWER (SYSTEM)	120Vac, 60 Hz	DETECTOR FUNCTION	Peak (PK) Average (AV)
ENVIRONMENTAL CONDITIONS	23deg. C, 70%RH	TESTED BY	Sun Lin

ANTENNA POLARITY & TEST DISTANCE: HORIZONTAL AT 3 M								
NO.	FREQ. (MHz)	EMISSION LEVEL (dBuV/m)	LIMIT (dBuV/m)	MARGIN (dB)	ANTENNA HEIGHT (m)	TABLE ANGLE (Degree)	RAW VALUE (dBuV)	CORRECTION FACTOR (dB/m)
1	*5660.00	104.1 PK			1.13 H	273	65.00	39.10
2	*5660.00	94.0 AV			1.13 H	273	54.90	39.10
3	11320.00	52.3 PK	74.0	-21.7	1.19 H	208	3.00	49.30
4	11320.00	42.3 AV	54.0	-11.7	1.19 H	208	-7.00	49.30
5	#16980.00	53.8 PK	68.3	-14.5	1.09 H	120	1.40	52.40
ANTENNA POLARITY & TEST DISTANCE: VERTICAL AT 3 M								
NO.	FREQ. (MHz)	EMISSION LEVEL (dBuV/m)	LIMIT (dBuV/m)	MARGIN (dB)	ANTENNA HEIGHT (m)	TABLE ANGLE (Degree)	RAW VALUE (dBuV)	CORRECTION FACTOR (dB/m)
1	*5660.00	107.8 PK			1.05 V	172	68.70	39.10
2	*5660.00	97.1 AV			1.05 V	172	58.00	39.10
3	11320.00	56.8 PK	74.0	-17.2	1.02 V	90	7.50	49.30
4	11320.00	43.8 AV	54.0	-10.2	1.02 V	90	-5.50	49.30
5	#16980.00	56.3 PK	68.3	-12.0	1.31 V	279	3.90	52.40

REMARKS:

1. Emission level (dBuV/m) = Raw Value (dBuV) + Correction Factor (dB/m).
2. Correction Factor (dB/m) = Antenna Factor (dB/m) + Cable Factor (dB).
3. The other emission levels were very low against the limit.
4. Margin value = Emission level – Limit value.
5. “ * “: Fundamental frequency.
6. “#“: The radiated frequency is out the restricted band.



A D T

EUT TEST CONDITION		MEASUREMENT DETAIL	
CHANNEL	Channel 140	FREQUENCY RANGE	1 ~ 40GHz
INPUT POWER (SYSTEM)	120Vac, 60 Hz	DETECTOR FUNCTION	Peak (PK) Average (AV)
ENVIRONMENTAL CONDITIONS	23deg. C, 70%RH	TESTED BY	Sun Lin

ANTENNA POLARITY & TEST DISTANCE: HORIZONTAL AT 3 M								
NO.	FREQ. (MHz)	EMISSION LEVEL (dBuV/m)	LIMIT (dBuV/m)	MARGIN (dB)	ANTENNA HEIGHT (m)	TABLE ANGLE (Degree)	RAW VALUE (dBuV)	CORRECTION FACTOR (dB/m)
1	*5700.00	104.7 PK			1.15 H	275	65.50	39.20
2	*5700.00	94.4 AV			1.15 H	275	55.20	39.20
3	#5725.00	63.7 PK	68.3	-4.6	1.15 H	275	24.50	39.20
4	11400.00	52.5 PK	74.0	-21.5	1.21 H	205	3.20	49.30
5	11400.00	42.6 AV	54.0	-11.4	1.21 H	205	-6.70	49.30
ANTENNA POLARITY & TEST DISTANCE: VERTICAL AT 3 M								
NO.	FREQ. (MHz)	EMISSION LEVEL (dBuV/m)	LIMIT (dBuV/m)	MARGIN (dB)	ANTENNA HEIGHT (m)	TABLE ANGLE (Degree)	RAW VALUE (dBuV)	CORRECTION FACTOR (dB/m)
1	*5700.00	107.9 PK			1.04 V	172	68.70	39.20
2	*5700.00	97.4 AV			1.04 V	172	58.20	39.20
3	#5725.00	64.8 PK	68.3	-3.5	1.04 V	172	25.60	39.20
4	11400.00	57.1 PK	74.0	-16.9	1.05 V	93	7.80	49.30
5	11400.00	44.0 AV	54.0	-10.0	1.05 V	93	-5.30	49.30

REMARKS:

1. Emission level (dBuV/m) = Raw Value (dBuV) + Correction Factor (dB/m).
2. Correction Factor (dB/m) = Antenna Factor (dB/m) + Cable Factor (dB).
3. The other emission levels were very low against the limit.
4. Margin value = Emission level – Limit value.
5. “ * “: Fundamental frequency.
6. “#”:The radiated frequency is out the restricted band.



A D T

802.11n (20MHz): 1TX

EUT TEST CONDITION		MEASUREMENT DETAIL	
CHANNEL	Channel 36	FREQUENCY RANGE	1 ~ 40GHz
INPUT POWER (SYSTEM)	120Vac, 60 Hz	DETECTOR FUNCTION	Peak (PK) Average (AV)
ENVIRONMENTAL CONDITIONS	23deg. C, 70%RH	TESTED BY	Sun Lin

ANTENNA POLARITY & TEST DISTANCE: HORIZONTAL AT 3 M								
NO.	FREQ. (MHz)	EMISSION LEVEL (dBuV/m)	LIMIT (dBuV/m)	MARGIN (dB)	ANTENNA HEIGHT (m)	TABLE ANGLE (Degree)	RAW VALUE (dBuV)	CORRECTION FACTOR (dB/m)
1	5150.00	58.8 PK	74.0	-15.2	1.14 H	1	20.60	38.20
2	5150.00	44.9 AV	54.0	-9.1	1.14 H	1	6.70	38.20
3	*5180.00	104.5 PK			1.02 H	2	66.30	38.20
4	*5180.00	94.0 AV			1.02 H	2	55.80	38.20
5	#10360.00	54.2 PK	68.3	-14.1	1.31 H	195	6.20	48.00

ANTENNA POLARITY & TEST DISTANCE: VERTICAL AT 3 M								
NO.	FREQ. (MHz)	EMISSION LEVEL (dBuV/m)	LIMIT (dBuV/m)	MARGIN (dB)	ANTENNA HEIGHT (m)	TABLE ANGLE (Degree)	RAW VALUE (dBuV)	CORRECTION FACTOR (dB/m)
1	5150.00	61.6 PK	74.0	-12.4	1.09 V	2	23.40	38.20
2	5150.00	46.7 AV	54.0	-7.3	1.09 V	2	8.50	38.20
3	*5180.00	107.9 PK			1.08 V	2	69.70	38.20
4	*5180.00	96.7 AV			1.08 V	2	58.50	38.20
5	#10360.00	56.2 PK	68.3	-12.1	1.43 V	107	8.20	48.00

REMARKS:

1. Emission level (dBuV/m) = Raw Value (dBuV) + Correction Factor (dB/m).
2. Correction Factor (dB/m) = Antenna Factor (dB/m) + Cable Factor (dB).
3. The other emission levels were very low against the limit.
4. Margin value = Emission level – Limit value.
5. “ * “: Fundamental frequency.
6. "#":The radiated frequency is out the restricted band.



A D T

EUT TEST CONDITION		MEASUREMENT DETAIL	
CHANNEL	Channel 40	FREQUENCY RANGE	1 ~ 40GHz
INPUT POWER (SYSTEM)	120Vac, 60 Hz	DETECTOR FUNCTION	Peak (PK) Average (AV)
ENVIRONMENTAL CONDITIONS	23deg. C, 70%RH	TESTED BY	Sun Lin

ANTENNA POLARITY & TEST DISTANCE: HORIZONTAL AT 3 M								
NO.	FREQ. (MHz)	EMISSION LEVEL (dBuV/m)	LIMIT (dBuV/m)	MARGIN (dB)	ANTENNA HEIGHT (m)	TABLE ANGLE (Degree)	RAW VALUE (dBuV)	CORRECTION FACTOR (dB/m)
1	*5200.00	103.8 PK			1.12 H	2	65.60	38.20
2	*5200.00	93.2 AV			1.12 H	2	55.00	38.20
3	#10400.00	54.5 PK	68.3	-13.8	1.29 H	215	6.40	48.10
4	15600.00	54.9 PK	74.0	-19.1	1.17 H	98	5.80	49.10
5	15600.00	44.1 AV	54.0	-9.9	1.17 H	98	-5.00	49.10

ANTENNA POLARITY & TEST DISTANCE: VERTICAL AT 3 M								
NO.	FREQ. (MHz)	EMISSION LEVEL (dBuV/m)	LIMIT (dBuV/m)	MARGIN (dB)	ANTENNA HEIGHT (m)	TABLE ANGLE (Degree)	RAW VALUE (dBuV)	CORRECTION FACTOR (dB/m)
1	*5200.00	107.0 PK			1.20 V	1	68.80	38.20
2	*5200.00	96.7 AV			1.20 V	1	58.50	38.20
3	#10400.00	57.0 PK	68.3	-11.3	1.18 V	203	8.90	48.10
4	15600.00	56.8 PK	74.0	-17.2	1.48 V	229	7.70	49.10
5	15600.00	45.9 AV	54.0	-8.1	1.48 V	229	-3.20	49.10

REMARKS:

1. Emission level (dBuV/m) = Raw Value (dBuV) + Correction Factor (dB/m).
2. Correction Factor (dB/m) = Antenna Factor (dB/m) + Cable Factor (dB).
3. The other emission levels were very low against the limit.
4. Margin value = Emission level – Limit value.
5. “ * “: Fundamental frequency.
6. “#”:The radiated frequency is out the restricted band.



A D T

EUT TEST CONDITION		MEASUREMENT DETAIL	
CHANNEL	Channel 48	FREQUENCY RANGE	1 ~ 40GHz
INPUT POWER (SYSTEM)	120Vac, 60 Hz	DETECTOR FUNCTION	Peak (PK) Average (AV)
ENVIRONMENTAL CONDITIONS	23deg. C, 70%RH	TESTED BY	Sun Lin

ANTENNA POLARITY & TEST DISTANCE: HORIZONTAL AT 3 M								
NO.	FREQ. (MHz)	EMISSION LEVEL (dBuV/m)	LIMIT (dBuV/m)	MARGIN (dB)	ANTENNA HEIGHT (m)	TABLE ANGLE (Degree)	RAW VALUE (dBuV)	CORRECTION FACTOR (dB/m)
1	*5240.00	103.2 PK			1.03 H	8	64.90	38.30
2	*5240.00	92.8 AV			1.03 H	8	54.50	38.30
3	#10480.00	54.8 PK	68.3	-13.5	1.31 H	224	6.60	48.20
4	15720.00	54.3 PK	74.0	-19.7	1.13 H	107	5.40	48.90
5	15720.00	43.5 AV	54.0	-10.5	1.13 H	107	-5.40	48.90

ANTENNA POLARITY & TEST DISTANCE: VERTICAL AT 3 M								
NO.	FREQ. (MHz)	EMISSION LEVEL (dBuV/m)	LIMIT (dBuV/m)	MARGIN (dB)	ANTENNA HEIGHT (m)	TABLE ANGLE (Degree)	RAW VALUE (dBuV)	CORRECTION FACTOR (dB/m)
1	*5240.00	106.5 PK			1.15 V	7	68.20	38.30
2	*5240.00	96.1 AV			1.15 V	7	57.80	38.30
3	#10480.00	56.7 PK	68.3	-11.6	1.33 V	71	8.50	48.20
4	15720.00	56.3 PK	74.0	-17.7	1.04 V	59	7.40	48.90
5	15720.00	45.4 AV	54.0	-8.6	1.04 V	59	-3.50	48.90

REMARKS:

1. Emission level (dBuV/m) = Raw Value (dBuV) + Correction Factor (dB/m).
2. Correction Factor (dB/m) = Antenna Factor (dB/m) + Cable Factor (dB).
3. The other emission levels were very low against the limit.
4. Margin value = Emission level – Limit value.
5. “ * “: Fundamental frequency.
6. “#”: The radiated frequency is out the restricted band.



A D T

EUT TEST CONDITION		MEASUREMENT DETAIL	
CHANNEL	Channel 52	FREQUENCY RANGE	1 ~ 40GHz
INPUT POWER (SYSTEM)	120Vac, 60 Hz	DETECTOR FUNCTION	Peak (PK) Average (AV)
ENVIRONMENTAL CONDITIONS	23deg. C, 70%RH	TESTED BY	Sun Lin

ANTENNA POLARITY & TEST DISTANCE: HORIZONTAL AT 3 M								
NO.	FREQ. (MHz)	EMISSION LEVEL (dBuV/m)	LIMIT (dBuV/m)	MARGIN (dB)	ANTENNA HEIGHT (m)	TABLE ANGLE (Degree)	RAW VALUE (dBuV)	CORRECTION FACTOR (dB/m)
1	*5260.00	104.5 PK			1.07 H	9	66.20	38.30
2	*5260.00	94.0 AV			1.07 H	9	55.70	38.30
3	#10520.00	54.7 PK	68.3	-13.6	1.34 H	247	6.40	48.30
4	15780.00	54.7 PK	74.0	-19.3	1.08 H	118	5.90	48.80
5	15780.00	43.6 AV	54.0	-10.4	1.08 H	118	-5.20	48.80

ANTENNA POLARITY & TEST DISTANCE: VERTICAL AT 3 M								
NO.	FREQ. (MHz)	EMISSION LEVEL (dBuV/m)	LIMIT (dBuV/m)	MARGIN (dB)	ANTENNA HEIGHT (m)	TABLE ANGLE (Degree)	RAW VALUE (dBuV)	CORRECTION FACTOR (dB/m)
1	*5260.00	108.7 PK			1.07 V	4	70.40	38.30
2	*5260.00	98.2 AV			1.07 V	4	59.90	38.30
3	#10520.00	56.1 PK	68.3	-12.2	1.23 V	132	7.80	48.30
4	15780.00	55.9 PK	74.0	-18.1	1.52 V	235	7.10	48.80
5	15780.00	44.5 AV	54.0	-9.5	1.52 V	235	-4.30	48.80

REMARKS:

1. Emission level (dBuV/m) = Raw Value (dBuV) + Correction Factor (dB/m).
2. Correction Factor (dB/m) = Antenna Factor (dB/m) + Cable Factor (dB).
3. The other emission levels were very low against the limit.
4. Margin value = Emission level – Limit value.
5. “ * “: Fundamental frequency.
6. “#”:The radiated frequency is out the restricted band.



A D T

EUT TEST CONDITION		MEASUREMENT DETAIL	
CHANNEL	Channel 60	FREQUENCY RANGE	1 ~ 40GHz
INPUT POWER (SYSTEM)	120Vac, 60 Hz	DETECTOR FUNCTION	Peak (PK) Average (AV)
ENVIRONMENTAL CONDITIONS	23deg. C, 70%RH	TESTED BY	Sun Lin

ANTENNA POLARITY & TEST DISTANCE: HORIZONTAL AT 3 M								
NO.	FREQ. (MHz)	EMISSION LEVEL (dBuV/m)	LIMIT (dBuV/m)	MARGIN (dB)	ANTENNA HEIGHT (m)	TABLE ANGLE (Degree)	RAW VALUE (dBuV)	CORRECTION FACTOR (dB/m)
1	*5300.00	104.3 PK			1.12 H	12	65.90	38.40
2	*5300.00	93.6 AV			1.12 H	12	55.20	38.40
3	10600.00	54.0 PK	74.0	-20.0	1.24 H	225	5.70	48.30
4	10600.00	43.3 AV	54.0	-10.7	1.24 H	225	-5.00	48.30
5	15900.00	56.2 PK	74.0	-17.8	1.33 H	296	7.80	48.40
6	15900.00	45.2 AV	54.0	-8.8	1.33 H	296	-3.20	48.40
ANTENNA POLARITY & TEST DISTANCE: VERTICAL AT 3 M								
NO.	FREQ. (MHz)	EMISSION LEVEL (dBuV/m)	LIMIT (dBuV/m)	MARGIN (dB)	ANTENNA HEIGHT (m)	TABLE ANGLE (Degree)	RAW VALUE (dBuV)	CORRECTION FACTOR (dB/m)
1	*5300.00	108.2 PK			1.18 V	5	69.80	38.40
2	*5300.00	97.5 AV			1.18 V	5	59.10	38.40
3	10600.00	55.8 PK	74.0	-18.2	1.32 V	158	7.50	48.30
4	10600.00	44.8 AV	54.0	-9.2	1.32 V	158	-3.50	48.30
5	15900.00	56.1 PK	74.0	-17.9	1.43 V	295	7.70	48.40
6	15900.00	44.8 AV	54.0	-9.2	1.43 V	295	-3.60	48.40

REMARKS:

1. Emission level (dBuV/m) = Raw Value (dBuV) + Correction Factor (dB/m).
2. Correction Factor (dB/m) = Antenna Factor (dB/m) + Cable Factor (dB).
3. The other emission levels were very low against the limit.
4. Margin value = Emission level – Limit value.
5. “ * “: Fundamental frequency.



A D T

EUT TEST CONDITION		MEASUREMENT DETAIL	
CHANNEL	Channel 64	FREQUENCY RANGE	1 ~ 40GHz
INPUT POWER (SYSTEM)	120Vac, 60 Hz	DETECTOR FUNCTION	Peak (PK) Average (AV)
ENVIRONMENTAL CONDITIONS	23deg. C, 70%RH	TESTED BY	Sun Lin

ANTENNA POLARITY & TEST DISTANCE: HORIZONTAL AT 3 M								
NO.	FREQ. (MHz)	EMISSION LEVEL (dBuV/m)	LIMIT (dBuV/m)	MARGIN (dB)	ANTENNA HEIGHT (m)	TABLE ANGLE (Degree)	RAW VALUE (dBuV)	CORRECTION FACTOR (dB/m)
1	*5320.00	104.5 PK			1.17 H	52	66.10	38.40
2	*5320.00	93.8 AV			1.17 H	52	55.40	38.40
3	5350.00	58.6 PK	74.0	-15.4	1.22 H	356	20.10	38.50
4	5350.00	41.2 AV	54.0	-12.8	1.22 H	356	2.70	38.50
5	10640.00	53.7 PK	74.0	-20.3	1.29 H	225	5.20	48.50
6	10640.00	43.1 AV	54.0	-10.9	1.29 H	225	-5.40	48.50
ANTENNA POLARITY & TEST DISTANCE: VERTICAL AT 3 M								
NO.	FREQ. (MHz)	EMISSION LEVEL (dBuV/m)	LIMIT (dBuV/m)	MARGIN (dB)	ANTENNA HEIGHT (m)	TABLE ANGLE (Degree)	RAW VALUE (dBuV)	CORRECTION FACTOR (dB/m)
1	*5320.00	107.9 PK			1.09 V	358	69.50	38.40
2	*5320.00	97.3 AV			1.09 V	358	58.90	38.40
3	5350.00	64.4 PK	74.0	-9.6	1.18 V	357	25.90	38.50
4	5350.00	45.6 AV	54.0	-8.4	1.18 V	357	7.10	38.50
5	10640.00	56.8 PK	74.0	-17.2	1.22 V	169	8.30	48.50
6	10640.00	45.6 AV	54.0	-8.4	1.22 V	169	-2.90	48.50

REMARKS:

1. Emission level (dBuV/m) = Raw Value (dBuV) + Correction Factor (dB/m).
2. Correction Factor (dB/m) = Antenna Factor (dB/m) + Cable Factor (dB).
3. The other emission levels were very low against the limit.
4. Margin value = Emission level – Limit value.
5. “ * “: Fundamental frequency.



A D T

EUT TEST CONDITION		MEASUREMENT DETAIL	
CHANNEL	Channel 100	FREQUENCY RANGE	1 ~ 40GHz
INPUT POWER (SYSTEM)	120Vac, 60 Hz	DETECTOR FUNCTION	Peak (PK) Average (AV)
ENVIRONMENTAL CONDITIONS	23deg. C, 70%RH	TESTED BY	Sun Lin

ANTENNA POLARITY & TEST DISTANCE: HORIZONTAL AT 3 M								
NO.	FREQ. (MHz)	EMISSION LEVEL (dBuV/m)	LIMIT (dBuV/m)	MARGIN (dB)	ANTENNA HEIGHT (m)	TABLE ANGLE (Degree)	RAW VALUE (dBuV)	CORRECTION FACTOR (dB/m)
1	5460.00	58.5 PK	74.0	-15.5	1.18 H	357	19.80	38.70
2	5460.00	39.3 AV	54.0	-14.7	1.18 H	357	0.60	38.70
3	#5470.00	59.7 PK	68.3	-8.6	1.18 H	357	21.00	38.70
4	*5500.00	102.2 PK			1.18 H	347	63.50	38.70
5	*5500.00	92.0 AV			1.18 H	347	53.30	38.70
6	11000.00	54.5 PK	74.0	-19.5	1.34 H	218	5.30	49.20
7	11000.00	43.7 AV	54.0	-10.3	1.34 H	218	-5.50	49.20
ANTENNA POLARITY & TEST DISTANCE: VERTICAL AT 3 M								
NO.	FREQ. (MHz)	EMISSION LEVEL (dBuV/m)	LIMIT (dBuV/m)	MARGIN (dB)	ANTENNA HEIGHT (m)	TABLE ANGLE (Degree)	RAW VALUE (dBuV)	CORRECTION FACTOR (dB/m)
1	5460.00	64.9 PK	74.0	-9.1	1.15 V	349	26.20	38.70
2	5460.00	47.8 AV	54.0	-6.2	1.15 V	349	9.10	38.70
3	#5470.00	66.7 PK	68.3	-1.6	1.15 V	349	28.00	38.70
4	*5500.00	107.0 PK			1.14 V	351	68.30	38.70
5	*5500.00	97.3 AV			1.14 V	351	58.60	38.70
6	11000.00	55.1 PK	74.0	-18.9	1.22 V	243	5.90	49.20
7	11000.00	44.7 AV	54.0	-9.3	1.22 V	243	-4.50	49.20

REMARKS:

1. Emission level (dBuV/m) = Raw Value (dBuV) + Correction Factor (dB/m).
2. Correction Factor (dB/m) = Antenna Factor (dB/m) + Cable Factor (dB).
3. The other emission levels were very low against the limit.
4. Margin value = Emission level – Limit value.
5. “ * “: Fundamental frequency.
6. “#”:The radiated frequency is out the restricted band.



A D T

EUT TEST CONDITION		MEASUREMENT DETAIL	
CHANNEL	Channel 116	FREQUENCY RANGE	1 ~ 40GHz
INPUT POWER (SYSTEM)	120Vac, 60 Hz	DETECTOR FUNCTION	Peak (PK) Average (AV)
ENVIRONMENTAL CONDITIONS	23deg. C, 70%RH	TESTED BY	Sun Lin

ANTENNA POLARITY & TEST DISTANCE: HORIZONTAL AT 3 M								
NO.	FREQ. (MHz)	EMISSION LEVEL (dBuV/m)	LIMIT (dBuV/m)	MARGIN (dB)	ANTENNA HEIGHT (m)	TABLE ANGLE (Degree)	RAW VALUE (dBuV)	CORRECTION FACTOR (dB/m)
1	*5580.00	104.2 PK			1.12 H	3	65.30	38.90
2	*5580.00	94.0 AV			1.12 H	3	55.10	38.90
3	11160.00	52.8 PK	74.0	-21.2	1.27 H	211	3.50	49.30
4	11160.00	42.7 AV	54.0	-11.3	1.27 H	211	-6.60	49.30
5	#16740.00	54.1 PK	68.3	-14.2	1.02 H	107	2.60	51.50
ANTENNA POLARITY & TEST DISTANCE: VERTICAL AT 3 M								
NO.	FREQ. (MHz)	EMISSION LEVEL (dBuV/m)	LIMIT (dBuV/m)	MARGIN (dB)	ANTENNA HEIGHT (m)	TABLE ANGLE (Degree)	RAW VALUE (dBuV)	CORRECTION FACTOR (dB/m)
1	*5580.00	108.5 PK			1.21 V	358	69.60	38.90
2	*5580.00	98.3 AV			1.21 V	358	59.40	38.90
3	11160.00	55.7 PK	74.0	-18.3	1.28 V	257	6.40	49.30
4	11160.00	45.1 AV	54.0	-8.9	1.28 V	257	-4.20	49.30
5	#16740.00	55.6 PK	68.3	-12.7	1.48 V	242	4.10	51.50

REMARKS:

1. Emission level (dBuV/m) = Raw Value (dBuV) + Correction Factor (dB/m).
2. Correction Factor (dB/m) = Antenna Factor (dB/m) + Cable Factor (dB).
3. The other emission levels were very low against the limit.
4. Margin value = Emission level – Limit value.
5. “ * “: Fundamental frequency.
6. “#”:The radiated frequency is out the restricted band.



A D T

EUT TEST CONDITION		MEASUREMENT DETAIL	
CHANNEL	Channel 132	FREQUENCY RANGE	1 ~ 40GHz
INPUT POWER (SYSTEM)	120Vac, 60 Hz	DETECTOR FUNCTION	Peak (PK) Average (AV)
ENVIRONMENTAL CONDITIONS	23deg. C, 70%RH	TESTED BY	Sun Lin

ANTENNA POLARITY & TEST DISTANCE: HORIZONTAL AT 3 M								
NO.	FREQ. (MHz)	EMISSION LEVEL (dBuV/m)	LIMIT (dBuV/m)	MARGIN (dB)	ANTENNA HEIGHT (m)	TABLE ANGLE (Degree)	RAW VALUE (dBuV)	CORRECTION FACTOR (dB/m)
1	*5660.00	104.5 PK			1.07 H	12	65.40	39.10
2	*5660.00	94.1 AV			1.07 H	12	55.00	39.10
3	11320.00	52.9 PK	74.0	-21.1	1.35 H	203	3.60	49.30
4	11320.00	42.7 AV	54.0	-11.3	1.35 H	203	-6.60	49.30
5	#16980.00	53.8 PK	68.3	-14.5	1.01 H	113	1.40	52.40
ANTENNA POLARITY & TEST DISTANCE: VERTICAL AT 3 M								
NO.	FREQ. (MHz)	EMISSION LEVEL (dBuV/m)	LIMIT (dBuV/m)	MARGIN (dB)	ANTENNA HEIGHT (m)	TABLE ANGLE (Degree)	RAW VALUE (dBuV)	CORRECTION FACTOR (dB/m)
1	*5660.00	108.6 PK			1.12 V	351	69.50	39.10
2	*5660.00	98.3 AV			1.12 V	351	59.20	39.10
3	11320.00	55.2 PK	74.0	-18.8	1.24 V	269	5.90	49.30
4	11320.00	44.7 AV	54.0	-9.3	1.24 V	269	-4.60	49.30
5	#16980.00	55.9 PK	68.3	-12.4	1.37 V	252	3.50	52.40

REMARKS:

1. Emission level (dBuV/m) = Raw Value (dBuV) + Correction Factor (dB/m).
2. Correction Factor (dB/m) = Antenna Factor (dB/m) + Cable Factor (dB).
3. The other emission levels were very low against the limit.
4. Margin value = Emission level – Limit value.
5. “ * “: Fundamental frequency.
6. “#”:The radiated frequency is out the restricted band.



A D T

EUT TEST CONDITION		MEASUREMENT DETAIL	
CHANNEL	Channel 140	FREQUENCY RANGE	1 ~ 40GHz
INPUT POWER (SYSTEM)	120Vac, 60 Hz	DETECTOR FUNCTION	Peak (PK) Average (AV)
ENVIRONMENTAL CONDITIONS	23deg. C, 70%RH	TESTED BY	Sun Lin

ANTENNA POLARITY & TEST DISTANCE: HORIZONTAL AT 3 M								
NO.	FREQ. (MHz)	EMISSION LEVEL (dBuV/m)	LIMIT (dBuV/m)	MARGIN (dB)	ANTENNA HEIGHT (m)	TABLE ANGLE (Degree)	RAW VALUE (dBuV)	CORRECTION FACTOR (dB/m)
1	*5700.00	102.5 PK			1.14 H	18	63.30	39.20
2	*5700.00	92.2 AV			1.14 H	18	53.00	39.20
3	#5725.00	61.5 PK	68.3	-6.8	1.07 H	12	22.30	39.20
4	11400.00	53.9 PK	74.0	-20.1	1.49 H	198	4.60	49.30
5	11400.00	43.6 AV	54.0	-10.4	1.49 H	198	-5.70	49.30
ANTENNA POLARITY & TEST DISTANCE: VERTICAL AT 3 M								
NO.	FREQ. (MHz)	EMISSION LEVEL (dBuV/m)	LIMIT (dBuV/m)	MARGIN (dB)	ANTENNA HEIGHT (m)	TABLE ANGLE (Degree)	RAW VALUE (dBuV)	CORRECTION FACTOR (dB/m)
1	*5700.00	106.9 PK			1.00 V	351	67.70	39.20
2	*5700.00	96.4 AV			1.00 V	351	57.20	39.20
3	#5725.00	66.8 PK	68.3	-1.5	1.18 V	341	27.60	39.20
4	11400.00	54.7 PK	74.0	-19.3	1.32 V	251	5.40	49.30
5	11400.00	44.3 AV	54.0	-9.7	1.32 V	251	-5.00	49.30

REMARKS:

1. Emission level (dBuV/m) = Raw Value (dBuV) + Correction Factor (dB/m).
2. Correction Factor (dB/m) = Antenna Factor (dB/m) + Cable Factor (dB).
3. The other emission levels were very low against the limit.
4. Margin value = Emission level – Limit value.
5. “ * “: Fundamental frequency.
6. “#”:The radiated frequency is out the restricted band.

802.11n (40MHz): 1TX

EUT TEST CONDITION		MEASUREMENT DETAIL	
CHANNEL	Channel 38	FREQUENCY RANGE	1 ~ 40GHz
INPUT POWER (SYSTEM)	120Vac, 60 Hz	DETECTOR FUNCTION	Peak (PK) Average (AV)
ENVIRONMENTAL CONDITIONS	23deg. C, 70%RH	TESTED BY	Anderson Hong

ANTENNA POLARITY & TEST DISTANCE: HORIZONTAL AT 3 M								
NO.	FREQ. (MHz)	EMISSION LEVEL (dBuV/m)	LIMIT (dBuV/m)	MARGIN (dB)	ANTENNA HEIGHT (m)	TABLE ANGLE (Degree)	RAW VALUE (dBuV)	CORRECTION FACTOR (dB/m)
1	5150.00	65.1 PK	74.0	-8.9	1.23 H	180	26.90	38.20
2	5150.00	49.7 AV	54.0	-4.3	1.23 H	180	11.50	38.20
3	*5190.00	99.9 PK			1.23 H	180	61.70	38.20
4	*5190.00	89.2 AV			1.23 H	180	51.00	38.20
5	#10380.00	55.9 PK	68.3	-12.4	1.21 H	40	7.90	48.00

ANTENNA POLARITY & TEST DISTANCE: VERTICAL AT 3 M								
NO.	FREQ. (MHz)	EMISSION LEVEL (dBuV/m)	LIMIT (dBuV/m)	MARGIN (dB)	ANTENNA HEIGHT (m)	TABLE ANGLE (Degree)	RAW VALUE (dBuV)	CORRECTION FACTOR (dB/m)
1	5150.00	67.3 PK	74.0	-6.7	1.06 V	184	29.10	38.20
2	5150.00	53.0 AV	54.0	-1.0	1.06 V	184	14.80	38.20
3	*5190.00	104.0 PK			1.06 V	184	65.80	38.20
4	*5190.00	92.9 AV			1.06 V	184	54.70	38.20
5	#10380.00	56.6 PK	68.3	-11.7	1.00 V	287	8.60	48.00

REMARKS:

1. Emission level (dBuV/m) = Raw Value (dBuV) + Correction Factor (dB/m).
2. Correction Factor (dB/m) = Antenna Factor (dB/m) + Cable Factor (dB).
3. The other emission levels were very low against the limit.
4. Margin value = Emission level – Limit value.
5. “ * “: Fundamental frequency.
6. "#":The radiated frequency is out the restricted band.



A D T

EUT TEST CONDITION		MEASUREMENT DETAIL	
CHANNEL	Channel 46	FREQUENCY RANGE	1 ~ 40GHz
INPUT POWER (SYSTEM)	120Vac, 60 Hz	DETECTOR FUNCTION	Peak (PK) Average (AV)
ENVIRONMENTAL CONDITIONS	23deg. C, 70%RH	TESTED BY	Anderson Hong

ANTENNA POLARITY & TEST DISTANCE: HORIZONTAL AT 3 M								
NO.	FREQ. (MHz)	EMISSION LEVEL (dBuV/m)	LIMIT (dBuV/m)	MARGIN (dB)	ANTENNA HEIGHT (m)	TABLE ANGLE (Degree)	RAW VALUE (dBuV)	CORRECTION FACTOR (dB/m)
1	5150.00	54.9 PK	74.0	-19.1	1.22 H	178	16.70	38.20
2	5150.00	42.3 AV	54.0	-11.7	1.22 H	178	4.10	38.20
3	*5230.00	102.4 PK			1.22 H	175	64.10	38.30
4	*5230.00	91.8 AV			1.22 H	175	53.50	38.30
5	#10460.00	57.1 PK	68.3	-11.2	1.25 H	45	8.90	48.20

ANTENNA POLARITY & TEST DISTANCE: VERTICAL AT 3 M								
NO.	FREQ. (MHz)	EMISSION LEVEL (dBuV/m)	LIMIT (dBuV/m)	MARGIN (dB)	ANTENNA HEIGHT (m)	TABLE ANGLE (Degree)	RAW VALUE (dBuV)	CORRECTION FACTOR (dB/m)
1	5150.00	55.2 PK	74.0	-18.8	1.05 V	185	17.00	38.20
2	5150.00	42.8 AV	54.0	-11.2	1.05 V	185	4.60	38.20
3	*5230.00	106.5 PK			1.05 V	185	68.20	38.30
4	*5230.00	95.5 AV			1.05 V	185	57.20	38.30
5	#10460.00	57.8 PK	68.3	-10.5	1.03 V	289	9.60	48.20

REMARKS:

1. Emission level (dBuV/m) = Raw Value (dBuV) + Correction Factor (dB/m).
2. Correction Factor (dB/m) = Antenna Factor (dB/m) + Cable Factor (dB).
3. The other emission levels were very low against the limit.
4. Margin value = Emission level – Limit value.
5. “ * “: Fundamental frequency.
6. “#”:The radiated frequency is out the restricted band.



EUT TEST CONDITION		MEASUREMENT DETAIL	
CHANNEL	Channel 54	FREQUENCY RANGE	1 ~ 40GHz
INPUT POWER (SYSTEM)	120Vac, 60 Hz	DETECTOR FUNCTION	Peak (PK) Average (AV)
ENVIRONMENTAL CONDITIONS	23deg. C, 70%RH	TESTED BY	Anderson Hong

ANTENNA POLARITY & TEST DISTANCE: HORIZONTAL AT 3 M								
NO.	FREQ. (MHz)	EMISSION LEVEL (dBuV/m)	LIMIT (dBuV/m)	MARGIN (dB)	ANTENNA HEIGHT (m)	TABLE ANGLE (Degree)	RAW VALUE (dBuV)	CORRECTION FACTOR (dB/m)
1	*5270.00	102.7 PK			1.22 H	178	64.30	38.40
2	*5270.00	91.6 AV			1.22 H	178	53.20	38.40
3	#10540.00	56.8 PK	68.3	-11.5	1.21 H	41	8.50	48.30
4	15810.00	53.2 PK	74.0	-20.8	1.11 H	213	4.50	48.70
5	15810.00	40.3 AV	54.0	-13.7	1.11 H	213	-8.40	48.70

ANTENNA POLARITY & TEST DISTANCE: VERTICAL AT 3 M								
NO.	FREQ. (MHz)	EMISSION LEVEL (dBuV/m)	LIMIT (dBuV/m)	MARGIN (dB)	ANTENNA HEIGHT (m)	TABLE ANGLE (Degree)	RAW VALUE (dBuV)	CORRECTION FACTOR (dB/m)
1	*5270.00	106.2 PK			1.04 V	184	67.80	38.40
2	*5270.00	95.2 AV			1.04 V	184	56.80	38.40
3	#10540.00	57.5 PK	68.3	-10.8	1.05 V	285	9.20	48.30
4	15810.00	54.5 PK	74.0	-19.5	1.03 V	79	5.80	48.70
5	15810.00	41.5 AV	54.0	-12.5	1.03 V	79	-7.20	48.70

REMARKS:

1. Emission level (dBuV/m) = Raw Value (dBuV) + Correction Factor (dB/m).
2. Correction Factor (dB/m) = Antenna Factor (dB/m) + Cable Factor (dB).
3. The other emission levels were very low against the limit.
4. Margin value = Emission level – Limit value.
5. “ * “: Fundamental frequency.
6. “#”:The radiated frequency is out the restricted band.



A D T

EUT TEST CONDITION		MEASUREMENT DETAIL	
CHANNEL	Channel 62	FREQUENCY RANGE	1 ~ 40GHz
INPUT POWER (SYSTEM)	120Vac, 60 Hz	DETECTOR FUNCTION	Peak (PK) Average (AV)
ENVIRONMENTAL CONDITIONS	23deg. C, 70%RH	TESTED BY	Anderson Hong

ANTENNA POLARITY & TEST DISTANCE: HORIZONTAL AT 3 M								
NO.	FREQ. (MHz)	EMISSION LEVEL (dBuV/m)	LIMIT (dBuV/m)	MARGIN (dB)	ANTENNA HEIGHT (m)	TABLE ANGLE (Degree)	RAW VALUE (dBuV)	CORRECTION FACTOR (dB/m)
1	*5310.00	98.4 PK			1.20 H	176	60.00	38.40
2	*5310.00	87.6 AV			1.20 H	176	49.20	38.40
3	5350.00	61.6 PK	74.0	-12.4	1.20 H	176	23.10	38.50
4	5350.00	48.5 AV	54.0	-5.5	1.20 H	176	10.00	38.50
5	10620.00	55.8 PK	74.0	-18.2	1.23 H	43	7.40	48.40
6	10620.00	42.3 AV	54.0	-11.7	1.23 H	43	-6.10	48.40
ANTENNA POLARITY & TEST DISTANCE: VERTICAL AT 3 M								
NO.	FREQ. (MHz)	EMISSION LEVEL (dBuV/m)	LIMIT (dBuV/m)	MARGIN (dB)	ANTENNA HEIGHT (m)	TABLE ANGLE (Degree)	RAW VALUE (dBuV)	CORRECTION FACTOR (dB/m)
1	*5310.00	102.6 PK			1.04 V	183	64.20	38.40
2	*5310.00	91.7 AV			1.04 V	183	53.30	38.40
3	5350.00	66.3 PK	74.0	-7.7	1.03 V	185	27.80	38.50
4	5350.00	52.5 AV	54.0	-1.5	1.03 V	185	14.00	38.50
5	10620.00	56.5 PK	74.0	-17.5	1.04 V	284	8.10	48.40
6	10620.00	43.2 AV	54.0	-10.8	1.04 V	284	-5.20	48.40

REMARKS:

1. Emission level (dBuV/m) = Raw Value (dBuV) + Correction Factor (dB/m).
2. Correction Factor (dB/m) = Antenna Factor (dB/m) + Cable Factor (dB).
3. The other emission levels were very low against the limit.
4. Margin value = Emission level – Limit value.
5. “ * “: Fundamental frequency.



A D T

EUT TEST CONDITION		MEASUREMENT DETAIL	
CHANNEL	Channel 102	FREQUENCY RANGE	1 ~ 40GHz
INPUT POWER (SYSTEM)	120Vac, 60 Hz	DETECTOR FUNCTION	Peak (PK) Average (AV)
ENVIRONMENTAL CONDITIONS	23deg. C, 70%RH	TESTED BY	Anderson Hong

ANTENNA POLARITY & TEST DISTANCE: HORIZONTAL AT 3 M								
NO.	FREQ. (MHz)	EMISSION LEVEL (dBuV/m)	LIMIT (dBuV/m)	MARGIN (dB)	ANTENNA HEIGHT (m)	TABLE ANGLE (Degree)	RAW VALUE (dBuV)	CORRECTION FACTOR (dB/m)
1	5460.00	56.9 PK	74.0	-17.1	1.18 H	167	18.20	38.70
2	5460.00	44.5 AV	54.0	-9.5	1.18 H	167	5.80	38.70
3	#5470.00	62.2 PK	68.3	-6.1	1.18 H	167	23.50	38.70
4	*5510.00	99.1 PK			1.18 H	167	60.30	38.80
5	*5510.00	88.1 AV			1.18 H	167	49.30	38.80
6	11020.00	55.6 PK	74.0	-18.4	1.21 H	39	6.40	49.20
7	11020.00	42.1 AV	54.0	-11.9	1.21 H	39	-7.10	49.20
ANTENNA POLARITY & TEST DISTANCE: VERTICAL AT 3 M								
NO.	FREQ. (MHz)	EMISSION LEVEL (dBuV/m)	LIMIT (dBuV/m)	MARGIN (dB)	ANTENNA HEIGHT (m)	TABLE ANGLE (Degree)	RAW VALUE (dBuV)	CORRECTION FACTOR (dB/m)
1	5460.00	60.7 PK	74.0	-13.3	1.10 V	186	22.00	38.70
2	5460.00	47.0 AV	54.0	-7.0	1.10 V	186	8.30	38.70
3	#5470.00	67.1 PK	68.3	-1.2	1.10 V	186	28.40	38.70
4	*5510.00	102.9 PK			1.10 V	186	64.10	38.80
5	*5510.00	91.9 AV			1.10 V	186	53.10	38.80
6	11020.00	56.1 PK	74.0	-17.9	1.05 V	283	6.90	49.20
7	11020.00	42.8 AV	54.0	-11.2	1.05 V	283	-6.40	49.20

REMARKS:

1. Emission level (dBuV/m) = Raw Value (dBuV) + Correction Factor (dB/m).
2. Correction Factor (dB/m) = Antenna Factor (dB/m) + Cable Factor (dB).
3. The other emission levels were very low against the limit.
4. Margin value = Emission level – Limit value.
5. “ * “: Fundamental frequency.
6. “#”:The radiated frequency is out the restricted band.



A D T

EUT TEST CONDITION		MEASUREMENT DETAIL	
CHANNEL	Channel 110	FREQUENCY RANGE	1 ~ 40GHz
INPUT POWER (SYSTEM)	120Vac, 60 Hz	DETECTOR FUNCTION	Peak (PK) Average (AV)
ENVIRONMENTAL CONDITIONS	23deg. C, 70%RH	TESTED BY	Anderson Hong

ANTENNA POLARITY & TEST DISTANCE: HORIZONTAL AT 3 M								
NO.	FREQ. (MHz)	EMISSION LEVEL (dBuV/m)	LIMIT (dBuV/m)	MARGIN (dB)	ANTENNA HEIGHT (m)	TABLE ANGLE (Degree)	RAW VALUE (dBuV)	CORRECTION FACTOR (dB/m)
1	*5550.00	101.8 PK			1.27 H	202	63.00	38.80
2	*5550.00	90.9 AV			1.27 H	202	52.10	38.80
3	11100.00	56.4 PK	74.0	-17.6	1.25 H	41	7.20	49.20
4	11100.00	42.8 AV	54.0	-11.2	1.25 H	41	-6.40	49.20
5	#16650.00	57.2 PK	68.3	-11.1	1.03 H	90	6.10	51.10
ANTENNA POLARITY & TEST DISTANCE: VERTICAL AT 3 M								
NO.	FREQ. (MHz)	EMISSION LEVEL (dBuV/m)	LIMIT (dBuV/m)	MARGIN (dB)	ANTENNA HEIGHT (m)	TABLE ANGLE (Degree)	RAW VALUE (dBuV)	CORRECTION FACTOR (dB/m)
1	*5550.00	105.7 PK			1.08 V	186	66.90	38.80
2	*5550.00	94.5 AV			1.08 V	186	55.70	38.80
3	11100.00	56.8 PK	74.0	-17.2	1.04 V	280	7.60	49.20
4	11100.00	43.5 AV	54.0	-10.5	1.04 V	280	-5.70	49.20
5	#16650.00	58.5 PK	68.3	-9.8	1.11 V	321	7.40	51.10

REMARKS:

1. Emission level (dBuV/m) = Raw Value (dBuV) + Correction Factor (dB/m).
2. Correction Factor (dB/m) = Antenna Factor (dB/m) + Cable Factor (dB).
3. The other emission levels were very low against the limit.
4. Margin value = Emission level – Limit value.
5. “ * “: Fundamental frequency.
6. “#”: The radiated frequency is out the restricted band.



A D T

EUT TEST CONDITION		MEASUREMENT DETAIL	
CHANNEL	Channel 134	FREQUENCY RANGE	1 ~ 40GHz
INPUT POWER (SYSTEM)	120Vac, 60 Hz	DETECTOR FUNCTION	Peak (PK) Average (AV)
ENVIRONMENTAL CONDITIONS	23deg. C, 70%RH	TESTED BY	Anderson Hong

ANTENNA POLARITY & TEST DISTANCE: HORIZONTAL AT 3 M								
NO.	FREQ. (MHz)	EMISSION LEVEL (dBuV/m)	LIMIT (dBuV/m)	MARGIN (dB)	ANTENNA HEIGHT (m)	TABLE ANGLE (Degree)	RAW VALUE (dBuV)	CORRECTION FACTOR (dB/m)
1	*5670.00	102.0 PK			1.45 H	184	62.90	39.10
2	*5670.00	91.0 AV			1.45 H	184	51.90	39.10
3	#5725.00	59.7 PK	68.3	-8.6	1.45 H	184	20.50	39.20
4	11340.00	56.7 PK	74.0	-17.3	1.31 H	39	7.40	49.30
5	11340.00	43.1 AV	54.0	-10.9	1.31 H	39	-6.20	49.30

ANTENNA POLARITY & TEST DISTANCE: VERTICAL AT 3 M								
NO.	FREQ. (MHz)	EMISSION LEVEL (dBuV/m)	LIMIT (dBuV/m)	MARGIN (dB)	ANTENNA HEIGHT (m)	TABLE ANGLE (Degree)	RAW VALUE (dBuV)	CORRECTION FACTOR (dB/m)
1	*5670.00	106.1 PK			1.05 V	171	67.00	39.10
2	*5670.00	95.0 AV			1.05 V	171	55.90	39.10
3	#5725.00	62.0 PK	68.3	-6.3	1.05 V	171	22.80	39.20
4	11340.00	57.0 PK	74.0	-17.0	1.07 V	278	7.70	49.30
5	11340.00	43.8 AV	54.0	-10.2	1.07 V	278	-5.50	49.30

REMARKS:

1. Emission level (dBuV/m) = Raw Value (dBuV) + Correction Factor (dB/m).
2. Correction Factor (dB/m) = Antenna Factor (dB/m) + Cable Factor (dB).
3. The other emission levels were very low against the limit.
6. "#":The radiated frequency is out the restricted band.
4. Margin value = Emission level – Limit value.



A D T

802.11n (20MHz): 2TX

EUT TEST CONDITION		MEASUREMENT DETAIL	
CHANNEL	Channel 36	FREQUENCY RANGE	1 ~ 40GHz
INPUT POWER (SYSTEM)	120Vac, 60 Hz	DETECTOR FUNCTION	Peak (PK) Average (AV)
ENVIRONMENTAL CONDITIONS	23deg. C, 70%RH	TESTED BY	Anderson Hong

ANTENNA POLARITY & TEST DISTANCE: HORIZONTAL AT 3 M								
NO.	FREQ. (MHz)	EMISSION LEVEL (dBuV/m)	LIMIT (dBuV/m)	MARGIN (dB)	ANTENNA HEIGHT (m)	TABLE ANGLE (Degree)	RAW VALUE (dBuV)	CORRECTION FACTOR (dB/m)
1	5150.00	55.8 PK	74.0	-18.2	1.00 H	35	17.60	38.20
2	5150.00	42.7 AV	54.0	-11.3	1.00 H	35	4.50	38.20
3	*5180.00	103.7 PK			1.00 H	35	65.50	38.20
4	*5180.00	90.7 AV			1.00 H	35	52.50	38.20
5	#10360.00	55.8 PK	68.3	-12.5	1.26 H	41	7.80	48.00

ANTENNA POLARITY & TEST DISTANCE: VERTICAL AT 3 M								
NO.	FREQ. (MHz)	EMISSION LEVEL (dBuV/m)	LIMIT (dBuV/m)	MARGIN (dB)	ANTENNA HEIGHT (m)	TABLE ANGLE (Degree)	RAW VALUE (dBuV)	CORRECTION FACTOR (dB/m)
1	5150.00	57.7 PK	74.0	-16.3	1.17 V	179	19.50	38.20
2	5150.00	44.1 AV	54.0	-9.9	1.17 V	179	5.90	38.20
3	*5180.00	106.1 PK			1.17 V	179	67.90	38.20
4	*5180.00	93.2 AV			1.17 V	179	55.00	38.20
5	#10360.00	56.6 PK	68.3	-11.7	1.00 V	123	8.60	48.00

REMARKS:

1. Emission level (dBuV/m) = Raw Value (dBuV) + Correction Factor (dB/m).
2. Correction Factor (dB/m) = Antenna Factor (dB/m) + Cable Factor (dB).
3. The other emission levels were very low against the limit.
4. Margin value = Emission level – Limit value.
5. " * ": Fundamental frequency.
6. "#": The radiated frequency is out the restricted band.



A D T

EUT TEST CONDITION		MEASUREMENT DETAIL	
CHANNEL	Channel 40	FREQUENCY RANGE	1 ~ 40GHz
INPUT POWER (SYSTEM)	120Vac, 60 Hz	DETECTOR FUNCTION	Peak (PK) Average (AV)
ENVIRONMENTAL CONDITIONS	23deg. C, 70%RH	TESTED BY	Anderson Hong

ANTENNA POLARITY & TEST DISTANCE: HORIZONTAL AT 3 M								
NO.	FREQ. (MHz)	EMISSION LEVEL (dBuV/m)	LIMIT (dBuV/m)	MARGIN (dB)	ANTENNA HEIGHT (m)	TABLE ANGLE (Degree)	RAW VALUE (dBuV)	CORRECTION FACTOR (dB/m)
1	*5200.00	103.7 PK			1.22 H	178	65.50	38.20
2	*5200.00	90.5 AV			1.22 H	178	52.30	38.20
3	#10400.00	56.2 PK	68.3	-12.1	1.28 H	45	8.10	48.10
4	15600.00	57.9 PK	74.0	-16.1	1.19 H	231	8.80	49.10
5	15600.00	44.5 AV	54.0	-9.5	1.19 H	231	-4.60	49.10
ANTENNA POLARITY & TEST DISTANCE: VERTICAL AT 3 M								
NO.	FREQ. (MHz)	EMISSION LEVEL (dBuV/m)	LIMIT (dBuV/m)	MARGIN (dB)	ANTENNA HEIGHT (m)	TABLE ANGLE (Degree)	RAW VALUE (dBuV)	CORRECTION FACTOR (dB/m)
1	*5200.00	106.5 PK			1.16 V	180	68.30	38.20
2	*5200.00	93.2 AV			1.16 V	180	55.00	38.20
3	#10400.00	57.0 PK	68.3	-11.3	1.03 V	122	8.90	48.10
4	15600.00	59.3 PK	74.0	-14.7	1.00 V	45	10.20	49.10
5	15600.00	45.7 AV	54.0	-8.3	1.00 V	45	-3.40	49.10

REMARKS:

1. Emission level (dBuV/m) = Raw Value (dBuV) + Correction Factor (dB/m).
2. Correction Factor (dB/m) = Antenna Factor (dB/m) + Cable Factor (dB).
3. The other emission levels were very low against the limit.
4. Margin value = Emission level – Limit value.
5. " * ": Fundamental frequency.
6. "#": The radiated frequency is out the restricted band.



A D T

EUT TEST CONDITION		MEASUREMENT DETAIL	
CHANNEL	Channel 48	FREQUENCY RANGE	1 ~ 40GHz
INPUT POWER (SYSTEM)	120Vac, 60 Hz	DETECTOR FUNCTION	Peak (PK) Average (AV)
ENVIRONMENTAL CONDITIONS	23deg. C, 70%RH	TESTED BY	Anderson Hong

ANTENNA POLARITY & TEST DISTANCE: HORIZONTAL AT 3 M								
NO.	FREQ. (MHz)	EMISSION LEVEL (dBuV/m)	LIMIT (dBuV/m)	MARGIN (dB)	ANTENNA HEIGHT (m)	TABLE ANGLE (Degree)	RAW VALUE (dBuV)	CORRECTION FACTOR (dB/m)
1	*5240.00	103.4 PK			1.00 H	35	65.10	38.30
2	*5240.00	90.6 AV			1.00 H	35	52.30	38.30
3	5350.00	54.8 PK	74.0	-19.2	1.00 H	35	16.30	38.50
4	5350.00	42.9 AV	54.0	-11.1	1.00 H	35	4.40	38.50
5	#10480.00	55.6 PK	68.3	-12.7	1.31 H	45	7.40	48.20
ANTENNA POLARITY & TEST DISTANCE: VERTICAL AT 3 M								
NO.	FREQ. (MHz)	EMISSION LEVEL (dBuV/m)	LIMIT (dBuV/m)	MARGIN (dB)	ANTENNA HEIGHT (m)	TABLE ANGLE (Degree)	RAW VALUE (dBuV)	CORRECTION FACTOR (dB/m)
1	*5240.00	105.8 PK			1.16 V	184	67.50	38.30
2	*5240.00	93.0 AV			1.16 V	184	54.70	38.30
3	5350.00	55.7 PK	74.0	-18.3	1.16 V	184	17.20	38.50
4	5350.00	43.7 AV	54.0	-10.3	1.16 V	184	5.20	38.50
5	#10480.00	56.3 PK	68.3	-12.0	1.00 V	125	8.10	48.20

REMARKS:

1. Emission level (dBuV/m) = Raw Value (dBuV) + Correction Factor (dB/m).
2. Correction Factor (dB/m) = Antenna Factor (dB/m) + Cable Factor (dB).
3. The other emission levels were very low against the limit.
4. Margin value = Emission level – Limit value.
5. “ * “: Fundamental frequency.
6. “#“: The radiated frequency is out the restricted band.



EUT TEST CONDITION		MEASUREMENT DETAIL	
CHANNEL	Channel 52	FREQUENCY RANGE	1 ~ 40GHz
INPUT POWER (SYSTEM)	120Vac, 60 Hz	DETECTOR FUNCTION	Peak (PK) Average (AV)
ENVIRONMENTAL CONDITIONS	23deg. C, 70%RH	TESTED BY	Anderson Hong

ANTENNA POLARITY & TEST DISTANCE: HORIZONTAL AT 3 M								
NO.	FREQ. (MHz)	EMISSION LEVEL (dBuV/m)	LIMIT (dBuV/m)	MARGIN (dB)	ANTENNA HEIGHT (m)	TABLE ANGLE (Degree)	RAW VALUE (dBuV)	CORRECTION FACTOR (dB/m)
1	5150.00	53.5 PK	74.0	-20.5	1.00 H	33	15.30	38.20
2	5150.00	41.6 AV	54.0	-12.4	1.00 H	33	3.40	38.20
3	*5260.00	104.7 PK			1.00 H	33	66.40	38.30
4	*5260.00	91.8 AV			1.00 H	33	53.50	38.30
5	#10520.00	56.8 PK	68.3	-11.5	1.32 H	48	8.50	48.30
ANTENNA POLARITY & TEST DISTANCE: VERTICAL AT 3 M								
NO.	FREQ. (MHz)	EMISSION LEVEL (dBuV/m)	LIMIT (dBuV/m)	MARGIN (dB)	ANTENNA HEIGHT (m)	TABLE ANGLE (Degree)	RAW VALUE (dBuV)	CORRECTION FACTOR (dB/m)
1	5150.00	54.2 PK	74.0	-19.8	1.05 V	182	16.00	38.20
2	5150.00	42.3 AV	54.0	-11.7	1.05 V	182	4.10	38.20
3	*5260.00	107.7 PK			1.05 V	182	69.40	38.30
4	*5260.00	95.0 AV			1.05 V	182	56.70	38.30
5	#10520.00	57.5 PK	68.3	-10.8	1.03 V	128	9.20	48.30

REMARKS:

1. Emission level (dBuV/m) = Raw Value (dBuV) + Correction Factor (dB/m).
2. Correction Factor (dB/m) = Antenna Factor (dB/m) + Cable Factor (dB).
3. The other emission levels were very low against the limit.
4. Margin value = Emission level – Limit value.
5. " * ": Fundamental frequency.
6. "#": The radiated frequency is out the restricted band.



A D T

EUT TEST CONDITION		MEASUREMENT DETAIL	
CHANNEL	Channel 60	FREQUENCY RANGE	1 ~ 40GHz
INPUT POWER (SYSTEM)	120Vac, 60 Hz	DETECTOR FUNCTION	Peak (PK) Average (AV)
ENVIRONMENTAL CONDITIONS	23deg. C, 70%RH	TESTED BY	Anderson Hong

ANTENNA POLARITY & TEST DISTANCE: HORIZONTAL AT 3 M								
NO.	FREQ. (MHz)	EMISSION LEVEL (dBuV/m)	LIMIT (dBuV/m)	MARGIN (dB)	ANTENNA HEIGHT (m)	TABLE ANGLE (Degree)	RAW VALUE (dBuV)	CORRECTION FACTOR (dB/m)
1	*5300.00	104.5 PK			1.00 H	35	66.10	38.40
2	*5300.00	91.8 AV			1.00 H	35	53.40	38.40
3	10600.00	56.7 PK	74.0	-17.3	1.35 H	51	8.40	48.30
4	10600.00	43.4 AV	54.0	-10.6	1.35 H	51	-4.90	48.30
5	15900.00	57.2 PK	74.0	-16.8	1.23 H	321	8.80	48.40
6	15900.00	43.8 AV	54.0	-10.2	1.23 H	321	-4.60	48.40
ANTENNA POLARITY & TEST DISTANCE: VERTICAL AT 3 M								
NO.	FREQ. (MHz)	EMISSION LEVEL (dBuV/m)	LIMIT (dBuV/m)	MARGIN (dB)	ANTENNA HEIGHT (m)	TABLE ANGLE (Degree)	RAW VALUE (dBuV)	CORRECTION FACTOR (dB/m)
1	*5300.00	107.5 PK			1.03 V	183	69.10	38.40
2	*5300.00	94.8 AV			1.03 V	183	56.40	38.40
3	10600.00	57.5 PK	74.0	-16.5	1.00 V	131	9.20	48.30
4	10600.00	44.1 AV	54.0	-9.9	1.00 V	131	-4.20	48.30
5	15900.00	58.2 PK	74.0	-15.8	1.08 V	93	9.80	48.40
6	15900.00	44.9 AV	54.0	-9.1	1.08 V	93	-3.50	48.40

REMARKS:

1. Emission level (dBuV/m) = Raw Value (dBuV) + Correction Factor (dB/m).
2. Correction Factor (dB/m) = Antenna Factor (dB/m) + Cable Factor (dB).
3. The other emission levels were very low against the limit.
4. Margin value = Emission level – Limit value.
5. “ * ”: Fundamental frequency.



A D T

EUT TEST CONDITION		MEASUREMENT DETAIL	
CHANNEL	Channel 64	FREQUENCY RANGE	1 ~ 40GHz
INPUT POWER (SYSTEM)	120Vac, 60 Hz	DETECTOR FUNCTION	Peak (PK) Average (AV)
ENVIRONMENTAL CONDITIONS	23deg. C, 70%RH	TESTED BY	Anderson Hong

ANTENNA POLARITY & TEST DISTANCE: HORIZONTAL AT 3 M								
NO.	FREQ. (MHz)	EMISSION LEVEL (dBuV/m)	LIMIT (dBuV/m)	MARGIN (dB)	ANTENNA HEIGHT (m)	TABLE ANGLE (Degree)	RAW VALUE (dBuV)	CORRECTION FACTOR (dB/m)
1	*5320.00	104.3 PK			1.00 H	30	65.90	38.40
2	*5320.00	91.5 AV			1.00 H	30	53.10	38.40
3	5350.00	55.4 PK	74.0	-18.6	1.00 H	30	16.90	38.50
4	5350.00	44.2 AV	54.0	-9.8	1.00 H	30	5.70	38.50
5	10640.00	56.5 PK	74.0	-17.5	1.41 H	55	8.00	48.50
6	10640.00	43.2 AV	54.0	-10.8	1.41 H	55	-5.30	48.50
ANTENNA POLARITY & TEST DISTANCE: VERTICAL AT 3 M								
NO.	FREQ. (MHz)	EMISSION LEVEL (dBuV/m)	LIMIT (dBuV/m)	MARGIN (dB)	ANTENNA HEIGHT (m)	TABLE ANGLE (Degree)	RAW VALUE (dBuV)	CORRECTION FACTOR (dB/m)
1	*5320.00	107.3 PK			1.03 V	182	68.90	38.40
2	*5320.00	94.7 AV			1.03 V	182	56.30	38.40
3	5350.00	57.5 PK	74.0	-16.5	1.03 V	182	19.00	38.50
4	5350.00	45.6 AV	54.0	-8.4	1.03 V	182	7.10	38.50
5	10640.00	57.5 PK	74.0	-16.5	1.00 V	135	9.00	48.50
6	10640.00	44.0 AV	54.0	-10.0	1.00 V	135	-4.50	48.50

REMARKS:

1. Emission level (dBuV/m) = Raw Value (dBuV) + Correction Factor (dB/m).
2. Correction Factor (dB/m) = Antenna Factor (dB/m) + Cable Factor (dB).
3. The other emission levels were very low against the limit.
4. Margin value = Emission level – Limit value.
5. “ * “: Fundamental frequency.



A D T

EUT TEST CONDITION		MEASUREMENT DETAIL	
CHANNEL	Channel 100	FREQUENCY RANGE	1 ~ 40GHz
INPUT POWER (SYSTEM)	120Vac, 60 Hz	DETECTOR FUNCTION	Peak (PK) Average (AV)
ENVIRONMENTAL CONDITIONS	23deg. C, 70%RH	TESTED BY	Anderson Hong

ANTENNA POLARITY & TEST DISTANCE: HORIZONTAL AT 3 M								
NO.	FREQ. (MHz)	EMISSION LEVEL (dBuV/m)	LIMIT (dBuV/m)	MARGIN (dB)	ANTENNA HEIGHT (m)	TABLE ANGLE (Degree)	RAW VALUE (dBuV)	CORRECTION FACTOR (dB/m)
1	5460.00	55.0 PK	74.0	-19.0	1.16 H	201	16.30	38.70
2	5460.00	43.2 AV	54.0	-10.8	1.16 H	201	4.50	38.70
3	#5470.00	59.1 PK	68.3	-9.2	1.16 H	201	20.40	38.70
4	*5500.00	104.1 PK			1.16 H	201	65.40	38.70
5	*5500.00	91.5 AV			1.16 H	201	52.80	38.70
6	11000.00	56.8 PK	74.0	-17.2	1.42 H	58	7.60	49.20
7	11000.00	43.5 AV	54.0	-10.5	1.42 H	58	-5.70	49.20
ANTENNA POLARITY & TEST DISTANCE: VERTICAL AT 3 M								
NO.	FREQ. (MHz)	EMISSION LEVEL (dBuV/m)	LIMIT (dBuV/m)	MARGIN (dB)	ANTENNA HEIGHT (m)	TABLE ANGLE (Degree)	RAW VALUE (dBuV)	CORRECTION FACTOR (dB/m)
1	5460.00	57.6 PK	74.0	-16.4	1.09 V	168	18.90	38.70
2	5460.00	44.6 AV	54.0	-9.4	1.09 V	168	5.90	38.70
3	#5470.00	61.5 PK	68.3	-6.8	1.09 V	168	22.80	38.70
4	*5500.00	108.5 PK			1.09 V	168	69.80	38.70
5	*5500.00	95.5 AV			1.09 V	168	56.80	38.70
6	11000.00	57.8 PK	74.0	-16.2	1.02 V	131	8.60	49.20
7	11000.00	44.4 AV	54.0	-9.6	1.02 V	131	-4.80	49.20

REMARKS:

1. Emission level (dBuV/m) = Raw Value (dBuV) + Correction Factor (dB/m).
2. Correction Factor (dB/m) = Antenna Factor (dB/m) + Cable Factor (dB).
3. The other emission levels were very low against the limit.
4. Margin value = Emission level – Limit value.
5. “ * “: Fundamental frequency.
6. “#“: The radiated frequency is out the restricted band.



A D T

EUT TEST CONDITION		MEASUREMENT DETAIL	
CHANNEL	Channel 116	FREQUENCY RANGE	1 ~ 40GHz
INPUT POWER (SYSTEM)	120Vac, 60 Hz	DETECTOR FUNCTION	Peak (PK) Average (AV)
ENVIRONMENTAL CONDITIONS	23deg. C, 70%RH	TESTED BY	Anderson Hong

ANTENNA POLARITY & TEST DISTANCE: HORIZONTAL AT 3 M								
NO.	FREQ. (MHz)	EMISSION LEVEL (dBuV/m)	LIMIT (dBuV/m)	MARGIN (dB)	ANTENNA HEIGHT (m)	TABLE ANGLE (Degree)	RAW VALUE (dBuV)	CORRECTION FACTOR (dB/m)
1	*5580.00	104.7 PK			1.14 H	199	65.80	38.90
2	*5580.00	91.4 AV			1.14 H	199	52.50	38.90
3	11160.00	57.1 PK	74.0	-16.9	1.45 H	61	7.80	49.30
4	11160.00	43.8 AV	54.0	-10.2	1.45 H	61	-5.50	49.30
5	#16740.00	57.1 PK	68.3	-11.2	1.20 H	311	5.60	51.50
ANTENNA POLARITY & TEST DISTANCE: VERTICAL AT 3 M								
NO.	FREQ. (MHz)	EMISSION LEVEL (dBuV/m)	LIMIT (dBuV/m)	MARGIN (dB)	ANTENNA HEIGHT (m)	TABLE ANGLE (Degree)	RAW VALUE (dBuV)	CORRECTION FACTOR (dB/m)
1	*5580.00	108.3 PK			1.05 V	171	69.40	38.90
2	*5580.00	95.5 AV			1.05 V	171	56.60	38.90
3	11160.00	58.1 PK	74.0	-15.9	1.03 V	133	8.80	49.30
4	11160.00	44.5 AV	54.0	-9.5	1.03 V	133	-4.80	49.30
5	#16740.00	58.2 PK	68.3	-10.1	1.11 V	175	6.70	51.50

REMARKS:

1. Emission level (dBuV/m) = Raw Value (dBuV) + Correction Factor (dB/m).
2. Correction Factor (dB/m) = Antenna Factor (dB/m) + Cable Factor (dB).
3. The other emission levels were very low against the limit.
4. Margin value = Emission level – Limit value.
5. " * ": Fundamental frequency.
6. "#": The radiated frequency is out the restricted band.



A D T

EUT TEST CONDITION		MEASUREMENT DETAIL	
CHANNEL	Channel 132	FREQUENCY RANGE	1 ~ 40GHz
INPUT POWER (SYSTEM)	120Vac, 60 Hz	DETECTOR FUNCTION	Peak (PK) Average (AV)
ENVIRONMENTAL CONDITIONS	23deg. C, 70%RH	TESTED BY	Anderson Hong

ANTENNA POLARITY & TEST DISTANCE: HORIZONTAL AT 3 M								
NO.	FREQ. (MHz)	EMISSION LEVEL (dBuV/m)	LIMIT (dBuV/m)	MARGIN (dB)	ANTENNA HEIGHT (m)	TABLE ANGLE (Degree)	RAW VALUE (dBuV)	CORRECTION FACTOR (dB/m)
1	*5660.00	104.4 PK			1.17 H	201	65.30	39.10
2	*5660.00	91.1 AV			1.17 H	201	52.00	39.10
3	11320.00	56.9 PK	74.0	-17.1	1.41 H	65	7.60	49.30
4	11320.00	43.6 AV	54.0	-10.4	1.41 H	65	-5.70	49.30
5	#16980.00	57.0 PK	68.3	-11.3	1.21 H	309	4.60	52.40
ANTENNA POLARITY & TEST DISTANCE: VERTICAL AT 3 M								
NO.	FREQ. (MHz)	EMISSION LEVEL (dBuV/m)	LIMIT (dBuV/m)	MARGIN (dB)	ANTENNA HEIGHT (m)	TABLE ANGLE (Degree)	RAW VALUE (dBuV)	CORRECTION FACTOR (dB/m)
1	*5660.00	108.4 PK			1.04 V	167	69.30	39.10
2	*5660.00	95.4 AV			1.04 V	167	56.30	39.10
3	11320.00	57.9 PK	74.0	-16.1	1.05 V	131	8.60	49.30
4	11320.00	44.4 AV	54.0	-9.6	1.05 V	131	-4.90	49.30
5	#16980.00	58.0 PK	68.3	-10.3	1.13 V	171	5.60	52.40

REMARKS:

1. Emission level (dBuV/m) = Raw Value (dBuV) + Correction Factor (dB/m).
2. Correction Factor (dB/m) = Antenna Factor (dB/m) + Cable Factor (dB).
3. The other emission levels were very low against the limit.
4. Margin value = Emission level – Limit value.
5. “ * “: Fundamental frequency.
6. “#“: The radiated frequency is out the restricted band.



A D T

EUT TEST CONDITION		MEASUREMENT DETAIL	
CHANNEL	Channel 140	FREQUENCY RANGE	1 ~ 40GHz
INPUT POWER (SYSTEM)	120Vac, 60 Hz	DETECTOR FUNCTION	Peak (PK) Average (AV)
ENVIRONMENTAL CONDITIONS	23deg. C, 70%RH	TESTED BY	Anderson Hong

ANTENNA POLARITY & TEST DISTANCE: HORIZONTAL AT 3 M								
NO.	FREQ. (MHz)	EMISSION LEVEL (dBuV/m)	LIMIT (dBuV/m)	MARGIN (dB)	ANTENNA HEIGHT (m)	TABLE ANGLE (Degree)	RAW VALUE (dBuV)	CORRECTION FACTOR (dB/m)
1	*5700.00	104.7 PK			1.31 H	199	65.50	39.20
2	*5700.00	91.4 AV			1.31 H	199	52.20	39.20
3	#5725.00	58.4 PK	68.3	-9.9	1.31 H	199	19.20	39.20
4	11400.00	57.1 PK	74.0	-16.9	1.43 H	61	7.80	49.30
5	11400.00	43.9 AV	54.0	-10.1	1.43 H	61	-5.40	49.30
ANTENNA POLARITY & TEST DISTANCE: VERTICAL AT 3 M								
NO.	FREQ. (MHz)	EMISSION LEVEL (dBuV/m)	LIMIT (dBuV/m)	MARGIN (dB)	ANTENNA HEIGHT (m)	TABLE ANGLE (Degree)	RAW VALUE (dBuV)	CORRECTION FACTOR (dB/m)
1	*5700.00	108.6 PK			1.04 V	169	69.40	39.20
2	*5700.00	95.5 AV			1.04 V	169	56.30	39.20
3	#5725.00	63.2 PK	68.3	-5.1	1.04 V	169	24.00	39.20
4	11400.00	58.3 PK	74.0	-15.7	1.08 V	128	9.00	49.30
5	11400.00	44.7 AV	54.0	-9.3	1.08 V	128	-4.60	49.30

REMARKS:

1. Emission level (dBuV/m) = Raw Value (dBuV) + Correction Factor (dB/m).
2. Correction Factor (dB/m) = Antenna Factor (dB/m) + Cable Factor (dB).
3. The other emission levels were very low against the limit.
4. Margin value = Emission level – Limit value.
5. “ * “: Fundamental frequency.
6. “#“: The radiated frequency is out the restricted band.

802.11n (40MHz): 2TX

EUT TEST CONDITION		MEASUREMENT DETAIL	
CHANNEL	Channel 38	FREQUENCY RANGE	1 ~ 40GHz
INPUT POWER (SYSTEM)	120Vac, 60 Hz	DETECTOR FUNCTION	Peak (PK) Average (AV)
ENVIRONMENTAL CONDITIONS	23deg. C, 70%RH	TESTED BY	Anderson Hong

ANTENNA POLARITY & TEST DISTANCE: HORIZONTAL AT 3 M								
NO.	FREQ. (MHz)	EMISSION LEVEL (dBuV/m)	LIMIT (dBuV/m)	MARGIN (dB)	ANTENNA HEIGHT (m)	TABLE ANGLE (Degree)	RAW VALUE (dBuV)	CORRECTION FACTOR (dB/m)
1	5150.00	63.2 PK	74.0	-10.8	1.00 H	36	25.00	38.20
2	5150.00	48.6 AV	54.0	-5.4	1.00 H	36	10.40	38.20
3	*5190.00	102.0 PK			1.00 H	36	63.80	38.20
4	*5190.00	88.6 AV			1.00 H	36	50.40	38.20
5	#10380.00	55.6 PK	68.3	-12.7	1.30 H	45	7.60	48.00
ANTENNA POLARITY & TEST DISTANCE: VERTICAL AT 3 M								
NO.	FREQ. (MHz)	EMISSION LEVEL (dBuV/m)	LIMIT (dBuV/m)	MARGIN (dB)	ANTENNA HEIGHT (m)	TABLE ANGLE (Degree)	RAW VALUE (dBuV)	CORRECTION FACTOR (dB/m)
1	5150.00	68.5 PK	74.0	-5.5	1.17 V	181	30.30	38.20
2	5150.00	52.8 AV	54.0	-1.2	1.17 V	181	14.60	38.20
3	*5190.00	104.8 PK			1.17 V	181	66.60	38.20
4	*5190.00	91.5 AV			1.17 V	181	53.30	38.20
5	#10380.00	56.3 PK	68.3	-12.0	1.03 V	125	8.30	48.00

REMARKS:

1. Emission level (dBuV/m) = Raw Value (dBuV) + Correction Factor (dB/m).
2. Correction Factor (dB/m) = Antenna Factor (dB/m) + Cable Factor (dB).
3. The other emission levels were very low against the limit.
4. Margin value = Emission level – Limit value.
5. “ * “: Fundamental frequency.
6. “#”:The radiated frequency is out the restricted band.



EUT TEST CONDITION		MEASUREMENT DETAIL	
CHANNEL	Channel 46	FREQUENCY RANGE	1 ~ 40GHz
INPUT POWER (SYSTEM)	120Vac, 60 Hz	DETECTOR FUNCTION	Peak (PK) Average (AV)
ENVIRONMENTAL CONDITIONS	23deg. C, 70%RH	TESTED BY	Anderson Hong

ANTENNA POLARITY & TEST DISTANCE: HORIZONTAL AT 3 M								
NO.	FREQ. (MHz)	EMISSION LEVEL (dBuV/m)	LIMIT (dBuV/m)	MARGIN (dB)	ANTENNA HEIGHT (m)	TABLE ANGLE (Degree)	RAW VALUE (dBuV)	CORRECTION FACTOR (dB/m)
1	5150.00	54.2 PK	74.0	-19.8	1.00 H	38	16.00	38.20
2	5150.00	42.5 AV	54.0	-11.5	1.00 H	38	4.30	38.20
3	*5230.00	101.7 PK			1.00 H	38	63.40	38.30
4	*5230.00	88.6 AV			1.00 H	38	50.30	38.30
5	#10460.00	55.4 PK	68.3	-12.9	1.31 H	43	7.20	48.20
ANTENNA POLARITY & TEST DISTANCE: VERTICAL AT 3 M								
NO.	FREQ. (MHz)	EMISSION LEVEL (dBuV/m)	LIMIT (dBuV/m)	MARGIN (dB)	ANTENNA HEIGHT (m)	TABLE ANGLE (Degree)	RAW VALUE (dBuV)	CORRECTION FACTOR (dB/m)
1	5150.00	56.6 PK	74.0	-17.4	1.16 V	182	18.40	38.20
2	5150.00	43.2 AV	54.0	-10.8	1.16 V	182	5.00	38.20
3	*5230.00	105.0 PK			1.16 V	182	66.70	38.30
4	*5230.00	91.6 AV			1.16 V	182	53.30	38.30
5	#10460.00	56.0 PK	68.3	-12.3	1.04 V	131	7.80	48.20

REMARKS:

1. Emission level (dBuV/m) = Raw Value (dBuV) + Correction Factor (dB/m).
2. Correction Factor (dB/m) = Antenna Factor (dB/m) + Cable Factor (dB).
3. The other emission levels were very low against the limit.
4. Margin value = Emission level – Limit value.
5. “ * “: Fundamental frequency.
6. “#”:The radiated frequency is out the restricted band.



A D T

EUT TEST CONDITION		MEASUREMENT DETAIL	
CHANNEL	Channel 54	FREQUENCY RANGE	1 ~ 40GHz
INPUT POWER (SYSTEM)	120Vac, 60 Hz	DETECTOR FUNCTION	Peak (PK) Average (AV)
ENVIRONMENTAL CONDITIONS	23deg. C, 70%RH	TESTED BY	Anderson Hong

ANTENNA POLARITY & TEST DISTANCE: HORIZONTAL AT 3 M								
NO.	FREQ. (MHz)	EMISSION LEVEL (dBuV/m)	LIMIT (dBuV/m)	MARGIN (dB)	ANTENNA HEIGHT (m)	TABLE ANGLE (Degree)	RAW VALUE (dBuV)	CORRECTION FACTOR (dB/m)
1	5150.00	54.7 PK	74.0	-19.3	1.00 H	33	16.50	38.20
2	5150.00	42.7 AV	54.0	-11.3	1.00 H	33	4.50	38.20
3	*5270.00	101.9 PK			1.00 H	33	63.50	38.40
4	*5270.00	88.5 AV			1.00 H	33	50.10	38.40
5	#10540.00	55.9 PK	68.3	-12.4	1.31 H	42	7.60	48.30
ANTENNA POLARITY & TEST DISTANCE: VERTICAL AT 3 M								
NO.	FREQ. (MHz)	EMISSION LEVEL (dBuV/m)	LIMIT (dBuV/m)	MARGIN (dB)	ANTENNA HEIGHT (m)	TABLE ANGLE (Degree)	RAW VALUE (dBuV)	CORRECTION FACTOR (dB/m)
1	5150.00	55.9 PK	74.0	-18.1	1.04 V	183	17.70	38.20
2	5150.00	43.5 AV	54.0	-10.5	1.04 V	183	5.30	38.20
3	*5270.00	105.0 PK			1.04 V	183	66.60	38.40
4	*5270.00	91.8 AV			1.04 V	183	53.40	38.40
5	#10540.00	56.8 PK	68.3	-11.5	1.05 V	121	8.50	48.30

REMARKS:

1. Emission level (dBuV/m) = Raw Value (dBuV) + Correction Factor (dB/m).
2. Correction Factor (dB/m) = Antenna Factor (dB/m) + Cable Factor (dB).
3. The other emission levels were very low against the limit.
4. Margin value = Emission level – Limit value.
5. “ * “: Fundamental frequency.
6. “#”:The radiated frequency is out the restricted band.



A D T

EUT TEST CONDITION		MEASUREMENT DETAIL	
CHANNEL	Channel 62	FREQUENCY RANGE	1 ~ 40GHz
INPUT POWER (SYSTEM)	120Vac, 60 Hz	DETECTOR FUNCTION	Peak (PK) Average (AV)
ENVIRONMENTAL CONDITIONS	23deg. C, 70%RH	TESTED BY	Anderson Hong

ANTENNA POLARITY & TEST DISTANCE: HORIZONTAL AT 3 M								
NO.	FREQ. (MHz)	EMISSION LEVEL (dBuV/m)	LIMIT (dBuV/m)	MARGIN (dB)	ANTENNA HEIGHT (m)	TABLE ANGLE (Degree)	RAW VALUE (dBuV)	CORRECTION FACTOR (dB/m)
1	*5310.00	102.1 PK			1.00 H	34	63.70	38.40
2	*5310.00	88.6 AV			1.00 H	34	50.20	38.40
3	5350.00	60.4 PK	74.0	-13.6	1.00 H	34	21.90	38.50
4	5350.00	48.0 AV	54.0	-6.0	1.00 H	34	9.50	38.50
5	10620.00	56.1 PK	74.0	-17.9	1.28 H	319	7.70	48.40
6	10620.00	43.4 AV	54.0	-10.6	1.28 H	319	-5.00	48.40
ANTENNA POLARITY & TEST DISTANCE: VERTICAL AT 3 M								
NO.	FREQ. (MHz)	EMISSION LEVEL (dBuV/m)	LIMIT (dBuV/m)	MARGIN (dB)	ANTENNA HEIGHT (m)	TABLE ANGLE (Degree)	RAW VALUE (dBuV)	CORRECTION FACTOR (dB/m)
1	*5310.00	105.0 PK			1.02 V	182	66.60	38.40
2	*5310.00	91.9 AV			1.02 V	182	53.50	38.40
3	5350.00	66.2 PK	74.0	-7.8	1.02 V	182	27.70	38.50
4	5350.00	51.6 AV	54.0	-2.4	1.02 V	182	13.10	38.50
5	10620.00	56.3 PK	74.0	-17.7	1.13 V	296	7.90	48.40
6	10620.00	44.5 AV	54.0	-9.5	1.13 V	296	-3.90	48.40

REMARKS:

1. Emission level (dBuV/m) = Raw Value (dBuV) + Correction Factor (dB/m).
2. Correction Factor (dB/m) = Antenna Factor (dB/m) + Cable Factor (dB).
3. The other emission levels were very low against the limit.
4. Margin value = Emission level – Limit value.
5. “ * “: Fundamental frequency.



A D T

EUT TEST CONDITION		MEASUREMENT DETAIL	
CHANNEL	Channel 102	FREQUENCY RANGE	1 ~ 40GHz
INPUT POWER (SYSTEM)	120Vac, 60 Hz	DETECTOR FUNCTION	Peak (PK) Average (AV)
ENVIRONMENTAL CONDITIONS	23deg. C, 70%RH	TESTED BY	Anderson Hong

ANTENNA POLARITY & TEST DISTANCE: HORIZONTAL AT 3 M								
NO.	FREQ. (MHz)	EMISSION LEVEL (dBuV/m)	LIMIT (dBuV/m)	MARGIN (dB)	ANTENNA HEIGHT (m)	TABLE ANGLE (Degree)	RAW VALUE (dBuV)	CORRECTION FACTOR (dB/m)
1	5460.00	57.8 PK	74.0	-16.2	1.06 H	272	19.10	38.70
2	5460.00	45.6 AV	54.0	-8.4	1.06 H	272	6.90	38.70
3	#5470.00	63.6 PK	68.3	-4.7	1.06 H	272	24.90	38.70
4	*5510.00	99.8 PK			1.06 H	272	61.00	38.80
5	*5510.00	86.8 AV			1.06 H	272	48.00	38.80
6	11020.00	55.7 PK	74.0	-18.3	1.25 H	315	6.50	49.20
7	11020.00	43.1 AV	54.0	-10.9	1.25 H	315	-6.10	49.20
ANTENNA POLARITY & TEST DISTANCE: VERTICAL AT 3 M								
NO.	FREQ. (MHz)	EMISSION LEVEL (dBuV/m)	LIMIT (dBuV/m)	MARGIN (dB)	ANTENNA HEIGHT (m)	TABLE ANGLE (Degree)	RAW VALUE (dBuV)	CORRECTION FACTOR (dB/m)
1	5460.00	61.0 PK	74.0	-13.0	1.00 V	185	22.30	38.70
2	5460.00	48.6 AV	54.0	-5.4	1.00 V	185	9.90	38.70
3	#5470.00	67.1 PK	68.3	-1.2	1.00 V	185	28.40	38.70
4	*5510.00	103.6 PK			1.00 V	185	64.80	38.80
5	*5510.00	90.3 AV			1.00 V	185	51.50	38.80
6	11020.00	56.0 PK	74.0	-18.0	1.15 V	300	6.80	49.20
7	11020.00	44.1 AV	54.0	-9.9	1.15 V	300	-5.10	49.20

REMARKS:

1. Emission level (dBuV/m) = Raw Value (dBuV) + Correction Factor (dB/m).
2. Correction Factor (dB/m) = Antenna Factor (dB/m) + Cable Factor (dB).
3. The other emission levels were very low against the limit.
4. Margin value = Emission level – Limit value.
5. “ * “: Fundamental frequency.
6. "#":The radiated frequency is out the restricted band.



A D T

EUT TEST CONDITION		MEASUREMENT DETAIL	
CHANNEL	Channel 110	FREQUENCY RANGE	1 ~ 40GHz
INPUT POWER (SYSTEM)	120Vac, 60 Hz	DETECTOR FUNCTION	Peak (PK) Average (AV)
ENVIRONMENTAL CONDITIONS	23deg. C, 70%RH	TESTED BY	Anderson Hong

ANTENNA POLARITY & TEST DISTANCE: HORIZONTAL AT 3 M								
NO.	FREQ. (MHz)	EMISSION LEVEL (dBuV/m)	LIMIT (dBuV/m)	MARGIN (dB)	ANTENNA HEIGHT (m)	TABLE ANGLE (Degree)	RAW VALUE (dBuV)	CORRECTION FACTOR (dB/m)
1	*5550.00	101.9 PK			1.05 H	274	63.10	38.80
2	*5550.00	88.6 AV			1.05 H	274	49.80	38.80
3	11100.00	56.6 PK	74.0	-17.4	1.28 H	312	7.40	49.20
4	11100.00	44.0 AV	54.0	-10.0	1.28 H	312	-5.20	49.20
5	#16650.00	57.1 PK	68.3	-11.2	1.21 H	351	6.00	51.10
ANTENNA POLARITY & TEST DISTANCE: VERTICAL AT 3 M								
NO.	FREQ. (MHz)	EMISSION LEVEL (dBuV/m)	LIMIT (dBuV/m)	MARGIN (dB)	ANTENNA HEIGHT (m)	TABLE ANGLE (Degree)	RAW VALUE (dBuV)	CORRECTION FACTOR (dB/m)
1	*5550.00	105.1 PK			1.08 V	171	66.30	38.80
2	*5550.00	91.4 AV			1.08 V	171	52.60	38.80
3	11100.00	56.8 PK	74.0	-17.2	1.18 V	302	7.60	49.20
4	11100.00	44.8 AV	54.0	-9.2	1.18 V	302	-4.40	49.20
5	#16650.00	57.9 PK	68.3	-10.4	1.13 V	263	6.80	51.10

REMARKS:

1. Emission level (dBuV/m) = Raw Value (dBuV) + Correction Factor (dB/m).
2. Correction Factor (dB/m) = Antenna Factor (dB/m) + Cable Factor (dB).
3. The other emission levels were very low against the limit.
4. Margin value = Emission level – Limit value.
5. “ * “: Fundamental frequency.
6. “#”:The radiated frequency is out the restricted band.



A D T

EUT TEST CONDITION		MEASUREMENT DETAIL	
CHANNEL	Channel 134	FREQUENCY RANGE	1 ~ 40GHz
INPUT POWER (SYSTEM)	120Vac, 60 Hz	DETECTOR FUNCTION	Peak (PK) Average (AV)
ENVIRONMENTAL CONDITIONS	23deg. C, 70%RH	TESTED BY	Anderson Hong

ANTENNA POLARITY & TEST DISTANCE: HORIZONTAL AT 3 M								
NO.	FREQ. (MHz)	EMISSION LEVEL (dBuV/m)	LIMIT (dBuV/m)	MARGIN (dB)	ANTENNA HEIGHT (m)	TABLE ANGLE (Degree)	RAW VALUE (dBuV)	CORRECTION FACTOR (dB/m)
1	*5670.00	102.3 PK			1.03 H	108	63.20	39.10
2	*5670.00	89.4 AV			1.03 H	108	50.30	39.10
3	#5725.00	55.7 PK	68.3	-12.6	1.03 H	108	16.50	39.20
4	11340.00	57.0 PK	74.0	-17.0	1.31 H	310	7.70	49.30
5	11340.00	44.2 AV	54.0	-9.8	1.31 H	310	-5.10	49.30
ANTENNA POLARITY & TEST DISTANCE: VERTICAL AT 3 M								
NO.	FREQ. (MHz)	EMISSION LEVEL (dBuV/m)	LIMIT (dBuV/m)	MARGIN (dB)	ANTENNA HEIGHT (m)	TABLE ANGLE (Degree)	RAW VALUE (dBuV)	CORRECTION FACTOR (dB/m)
1	*5670.00	105.8 PK			1.11 V	153	66.70	39.10
2	*5670.00	92.1 AV			1.11 V	153	53.00	39.10
3	#5725.00	56.4 PK	68.3	-11.9	1.11 V	153	17.20	39.20
4	11340.00	57.1 PK	74.0	-16.9	1.19 V	301	7.80	49.30
5	11340.00	45.0 AV	54.0	-9.0	1.19 V	301	-4.30	49.30

REMARKS:

1. Emission level (dBuV/m) = Raw Value (dBuV) + Correction Factor (dB/m).
2. Correction Factor (dB/m) = Antenna Factor (dB/m) + Cable Factor (dB).
3. The other emission levels were very low against the limit.
4. Margin value = Emission level – Limit value.
5. “ * “: Fundamental frequency.
6. “#”:The radiated frequency is out the restricted band.

BELOW 1GHz WORST-CASE DATA :

802.11n (20MHz): 1TX

EUT TEST CONDITION		MEASUREMENT DETAIL	
CHANNEL	Channel 60	FREQUENCY RANGE	Below 1000MHz
INPUT POWER (SYSTEM)	120Vac, 60 Hz	DETECTOR FUNCTION	Quasi-Peak
ENVIRONMENTAL CONDITIONS	21deg. C, 69%RH	TESTED BY	Anderson Hong

ANTENNA POLARITY & TEST DISTANCE: HORIZONTAL AT 3 M								
NO.	FREQ. (MHz)	EMISSION LEVEL (dBuV/m)	LIMIT (dBuV/m)	MARGIN (dB)	ANTENNA HEIGHT (m)	TABLE ANGLE (Degree)	RAW VALUE (dBuV)	CORRECTION FACTOR (dB/m)
1	111.48	30.1 QP	43.5	-13.4	1.00 H	286	19.30	10.80
2	165.80	35.4 QP	43.5	-8.1	1.00 H	258	21.70	13.70
3	363.68	33.5 QP	46.0	-12.5	1.25 H	71	17.00	16.50
4	497.54	35.3 QP	46.0	-10.7	1.00 H	348	15.30	20.00
5	582.90	31.1 QP	46.0	-14.9	1.00 H	3	9.10	22.00
6	749.74	30.7 QP	46.0	-15.3	1.50 H	171	6.70	24.00
ANTENNA POLARITY & TEST DISTANCE: VERTICAL AT 3 M								
NO.	FREQ. (MHz)	EMISSION LEVEL (dBuV/m)	LIMIT (dBuV/m)	MARGIN (dB)	ANTENNA HEIGHT (m)	TABLE ANGLE (Degree)	RAW VALUE (dBuV)	CORRECTION FACTOR (dB/m)
1	113.42	29.7 QP	43.5	-13.8	1.50 V	169	18.60	11.10
2	154.16	34.3 QP	43.5	-9.2	1.00 V	137	20.30	14.00
3	398.60	38.2 QP	46.0	-7.8	1.25 V	287	20.80	17.40
4	497.54	37.4 QP	46.0	-8.6	1.00 V	256	17.40	20.00
5	549.92	32.2 QP	46.0	-13.8	1.50 V	4	10.90	21.30
6	582.90	28.6 QP	46.0	-17.4	1.00 V	69	6.60	22.00

REMARKS:

1. Emission level (dBuV/m) = Raw Value (dBuV) + Correction Factor (dB/m).
2. Correction Factor (dB/m) = Antenna Factor (dB/m) + Cable Factor (dB).
3. The other emission levels were very low against the limit.
4. Margin value = Emission level – Limit value.



A D T

EUT TEST CONDITION		MEASUREMENT DETAIL	
CHANNEL	Channel 116	FREQUENCY RANGE	Below 1000MHz
INPUT POWER (SYSTEM)	120Vac, 60 Hz	DETECTOR FUNCTION	Quasi-Peak
ENVIRONMENTAL CONDITIONS	21deg. C, 69%RH	TESTED BY	Anderson Hong

ANTENNA POLARITY & TEST DISTANCE: HORIZONTAL AT 3 M								
NO.	FREQ. (MHz)	EMISSION LEVEL (dBuV/m)	LIMIT (dBuV/m)	MARGIN (dB)	ANTENNA HEIGHT (m)	TABLE ANGLE (Degree)	RAW VALUE (dBuV)	CORRECTION FACTOR (dB/m)
1	111.48	30.3 QP	43.5	-13.2	1.00 H	274	19.50	10.80
2	165.80	34.6 QP	43.5	-8.9	1.50 H	258	20.90	13.70
3	371.44	35.7 QP	46.0	-10.3	1.00 H	53	19.00	16.70
4	538.28	34.2 QP	46.0	-11.8	1.00 H	127	13.20	21.00
5	598.42	29.5 QP	46.0	-16.5	1.25 H	247	7.20	22.30
6	751.68	30.8 QP	46.0	-15.2	1.25 H	170	6.80	24.00
ANTENNA POLARITY & TEST DISTANCE: VERTICAL AT 3 M								
NO.	FREQ. (MHz)	EMISSION LEVEL (dBuV/m)	LIMIT (dBuV/m)	MARGIN (dB)	ANTENNA HEIGHT (m)	TABLE ANGLE (Degree)	RAW VALUE (dBuV)	CORRECTION FACTOR (dB/m)
1	113.42	29.7 QP	43.5	-13.8	1.25 V	144	18.60	11.10
2	154.16	35.4 QP	43.5	-8.1	1.00 V	114	21.40	14.00
3	398.60	38.1 QP	46.0	-7.9	1.25 V	300	20.70	17.40
4	499.48	36.8 QP	46.0	-9.2	1.50 V	254	16.70	20.10
5	598.42	30.1 QP	46.0	-15.9	1.00 V	15	7.80	22.30
6	751.68	27.3 QP	46.0	-18.7	1.00 V	213	3.30	24.00

REMARKS:

1. Emission level (dBuV/m) = Raw Value (dBuV) + Correction Factor (dB/m).
2. Correction Factor (dB/m) = Antenna Factor (dB/m) + Cable Factor (dB).
3. The other emission levels were very low against the limit.
4. Margin value = Emission level – Limit value.

802.11n (40MHz): 2TX

EUT TEST CONDITION		MEASUREMENT DETAIL	
CHANNEL	Channel 38	FREQUENCY RANGE	Below 1000MHz
INPUT POWER (SYSTEM)	120Vac, 60 Hz	DETECTOR FUNCTION	Quasi-Peak
ENVIRONMENTAL CONDITIONS	21deg. C, 69%RH	TESTED BY	Anderson Hong

ANTENNA POLARITY & TEST DISTANCE: HORIZONTAL AT 3 M								
NO.	FREQ. (MHz)	EMISSION LEVEL (dBuV/m)	LIMIT (dBuV/m)	MARGIN (dB)	ANTENNA HEIGHT (m)	TABLE ANGLE (Degree)	RAW VALUE (dBuV)	CORRECTION FACTOR (dB/m)
1	107.60	30.2 QP	43.5	-13.3	1.25 H	96	19.80	10.40
2	165.80	35.4 QP	43.5	-8.1	1.25 H	255	21.70	13.70
3	299.66	35.2 QP	46.0	-10.8	1.00 H	67	20.30	14.90
4	373.38	33.6 QP	46.0	-12.4	1.00 H	59	16.80	16.80
5	598.42	31.0 QP	46.0	-15.0	1.50 H	95	8.70	22.30
6	749.74	30.5 QP	46.0	-15.5	1.00 H	166	6.50	24.00
ANTENNA POLARITY & TEST DISTANCE: VERTICAL AT 3 M								
NO.	FREQ. (MHz)	EMISSION LEVEL (dBuV/m)	LIMIT (dBuV/m)	MARGIN (dB)	ANTENNA HEIGHT (m)	TABLE ANGLE (Degree)	RAW VALUE (dBuV)	CORRECTION FACTOR (dB/m)
1	113.42	29.9 QP	43.5	-13.6	1.00 V	171	18.80	11.10
2	154.16	36.2 QP	43.5	-7.3	1.50 V	126	22.20	14.00
3	400.54	38.6 QP	46.0	-7.4	1.00 V	295	21.10	17.50
4	499.48	37.1 QP	46.0	-8.9	1.00 V	268	17.00	20.10
5	582.90	30.1 QP	46.0	-15.9	1.75 V	7	8.10	22.00
6	749.74	26.0 QP	46.0	-20.0	1.25 V	211	2.00	24.00

REMARKS:

1. Emission level (dBuV/m) = Raw Value (dBuV) + Correction Factor (dB/m).
2. Correction Factor (dB/m) = Antenna Factor (dB/m) + Cable Factor (dB).
3. The other emission levels were very low against the limit.
4. Margin value = Emission level – Limit value.



802.11n (20MHz): 2TX

EUT TEST CONDITION		MEASUREMENT DETAIL	
CHANNEL	Channel 100	FREQUENCY RANGE	Below 1000MHz
INPUT POWER (SYSTEM)	120Vac, 60 Hz	DETECTOR FUNCTION	Quasi-Peak
ENVIRONMENTAL CONDITIONS	21deg. C, 69%RH	TESTED BY	Anderson Hong

ANTENNA POLARITY & TEST DISTANCE: HORIZONTAL AT 3 M								
NO.	FREQ. (MHz)	EMISSION LEVEL (dBuV/m)	LIMIT (dBuV/m)	MARGIN (dB)	ANTENNA HEIGHT (m)	TABLE ANGLE (Degree)	RAW VALUE (dBuV)	CORRECTION FACTOR (dB/m)
1	113.42	29.8 QP	43.5	-13.7	1.00 H	273	18.70	11.10
2	165.80	35.2 QP	43.5	-8.3	1.25 H	265	21.50	13.70
3	299.66	35.7 QP	46.0	-10.3	1.00 H	166	20.80	14.90
4	516.94	36.2 QP	46.0	-9.8	1.50 H	146	15.70	20.50
5	697.36	31.6 QP	46.0	-14.4	1.50 H	133	8.80	22.80
6	751.68	30.3 QP	46.0	-15.7	1.75 H	164	6.30	24.00
ANTENNA POLARITY & TEST DISTANCE: VERTICAL AT 3 M								
NO.	FREQ. (MHz)	EMISSION LEVEL (dBuV/m)	LIMIT (dBuV/m)	MARGIN (dB)	ANTENNA HEIGHT (m)	TABLE ANGLE (Degree)	RAW VALUE (dBuV)	CORRECTION FACTOR (dB/m)
1	113.42	30.1 QP	43.5	-13.4	1.50 V	165	19.00	11.10
2	154.16	34.4 QP	43.5	-9.1	1.00 V	103	20.40	14.00
3	398.60	38.5 QP	46.0	-7.5	1.25 V	296	21.10	17.40
4	499.48	36.9 QP	46.0	-9.1	1.00 V	237	16.80	20.10
5	549.92	32.5 QP	46.0	-13.5	1.25 V	12	11.20	21.30
6	749.74	26.1 QP	46.0	-19.9	1.00 V	193	2.10	24.00

REMARKS:

1. Emission level (dBuV/m) = Raw Value (dBuV) + Correction Factor (dB/m).
2. Correction Factor (dB/m) = Antenna Factor (dB/m) + Cable Factor (dB).
3. The other emission levels were very low against the limit.
4. Margin value = Emission level – Limit value.

4.2 CONDUCTED EMISSION MEASUREMENT

4.2.1 LIMITS OF CONDUCTED EMISSION MEASUREMENT

FREQUENCY OF EMISSION (MHz)	CONDUCTED LIMIT (dB μ V)	
	Quasi-peak	Average
0.15 ~ 0.5	66 to 56	56 to 46
0.5 ~ 5	56	46
5 ~ 30	60	50

- NOTE:** 1. The lower limit shall apply at the transition frequencies.
2. The limit decreases in line with the logarithm of the frequency in the range of 0.15 to 0.50MHz.
3. All emanations from a class A/B digital device or system, including any network of conductors and apparatus connected thereto, shall not exceed the level of field strengths specified above.

4.2.2 TEST INSTRUMENTS

DESCRIPTION & MANUFACTURER	MODEL NO.	SERIAL NO.	DATE OF CALIBRATION	DUE DATE OF CALIBRATION
Test Receiver ROHDE & SCHWARZ	ESCS30	100289	Nov. 19, 2011	Nov. 18, 2012
RF signal cable Woken	5D-FB	Cable-HYCO2-01	Dec. 22, 2011	Dec. 21, 2012
LISN ROHDE & SCHWARZ	ESH2-Z5	100100	Dec. 30, 2011	Dec. 29, 2012
LISN ROHDE & SCHWARZ	ESH3-Z5	100312	Jul. 07, 2011	Jul. 06, 2012
Software ADT	ADT_Cond_ V7.3.7	NA	NA	NA

- NOTE:** 1. The calibration interval of the above test instruments is 12 months and the calibrations are traceable to NML/ROC and NIST/USA.
2. The test was performed in HwaYa Shielded Room 2.
3. The VCCI Site Registration No. is C-2047.

4.2.3 TEST PROCEDURES

- The EUT was placed 0.4 meters from the conducting wall of the shielded room with EUT being connected to the power mains through a line impedance stabilization network (LISN). Other support units were connected to the power mains through another LISN. The two LISNs provide 50 ohm/ 50uH of coupling impedance for the measuring instrument.
- Both lines of the power mains connected to the EUT were checked for maximum conducted interference.
- The frequency range from 150kHz to 30MHz was searched. Emission levels under (Limit - 20dB) was not recorded.

NOTE: All modes of operation were investigated and the worst-case emissions are reported.

4.2.4 DEVIATION FROM TEST STANDARD

No deviation.

4.2.5 TEST SETUP

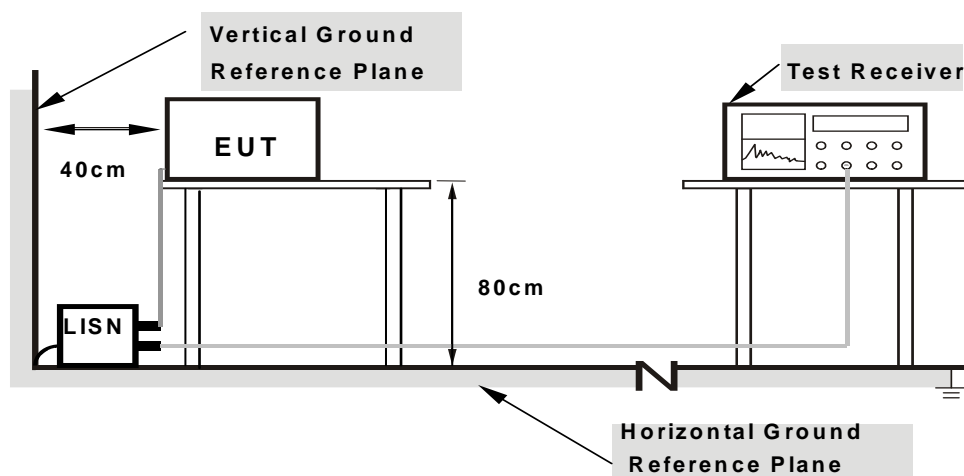

- Note:**
- Support units were connected to second LISN.
 - Both of LISNs (AMN) are 80 cm from EUT and at least 80 from other units and other metal planes

For the actual test configuration, please refer to the attached file (Test Setup Photo).

4.2.6 EUT OPERATING CONDITIONS

Same as 4.1.6.

4.2.7 TEST RESULTS

CONDUCTED WORST-CASE DATA :

802.11n (20MHz): 1TX

PHASE	Line 1	6dB BANDWIDTH	9kHz
CHANNEL	Channel 60		

No	Freq. [MHz]	Corr. Factor (dB)	Reading Value		Emission Level		Limit		Margin	
			[dB (uV)]		[dB (uV)]		[dB (uV)]		(dB)	
			Q.P.	AV.	Q.P.	AV.	Q.P.	AV.	Q.P.	AV.
1	0.18516	0.15	43.22	31.50	43.37	31.65	64.25	54.25	-20.88	-22.60
2	0.25547	0.16	35.78	28.57	35.94	28.73	61.58	51.58	-25.64	-22.85
3	0.70469	0.18	33.69	20.87	33.87	21.05	56.00	46.00	-22.13	-24.95
4	1.33203	0.21	34.06	26.56	34.27	26.77	56.00	46.00	-21.73	-19.23
5	5.81250	0.37	41.22	29.94	41.59	30.31	60.00	50.00	-18.41	-19.69
6	10.84375	0.45	42.46	35.78	42.91	36.23	60.00	50.00	-17.09	-13.77

- REMARKS:**
1. Q.P. and AV. are abbreviations of quasi-peak and average individually.
 2. The emission levels of other frequencies were very low against the limit.
 3. Margin value = Emission level - Limit value
 4. Correction factor = Insertion loss + Cable loss
 5. Emission Level = Correction Factor + Reading Value.

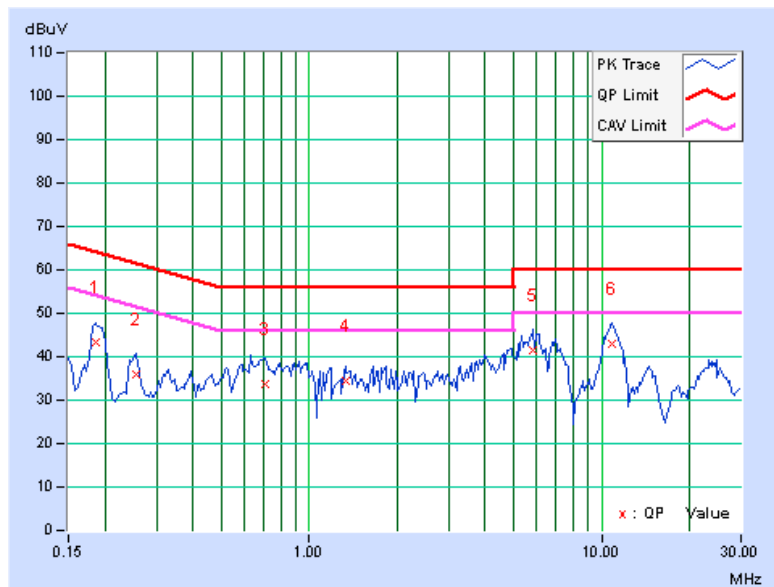



PHASE	Line 2	6dB BANDWIDTH	9kHz
CHANNEL	Channel 60		

No	Freq. [MHz]	Corr. Factor (dB)	Reading Value		Emission Level		Limit		Margin	
			[dB (uV)]		[dB (uV)]		[dB (uV)]		(dB)	
			Q.P.	AV.	Q.P.	AV.	Q.P.	AV.	Q.P.	AV.
1	0.16172	0.13	46.91	36.74	47.04	36.87	65.38	55.38	-18.33	-18.50
2	0.21641	0.14	36.81	24.63	36.95	24.77	62.96	52.96	-26.00	-28.18
3	0.65391	0.17	34.19	23.45	34.36	23.62	56.00	46.00	-21.64	-22.38
4	2.76172	0.29	32.84	25.25	33.13	25.54	56.00	46.00	-22.87	-20.46
5	13.44531	0.56	29.13	22.19	29.69	22.75	60.00	50.00	-30.31	-27.25
6	23.91406	0.65	33.25	28.19	33.90	28.84	60.00	50.00	-26.10	-21.16

- REMARKS:**
1. Q.P. and AV. are abbreviations of quasi-peak and average individually.
 2. The emission levels of other frequencies were very low against the limit.
 3. Margin value = Emission level - Limit value
 4. Correction factor = Insertion loss + Cable loss
 5. Emission Level = Correction Factor + Reading Value.

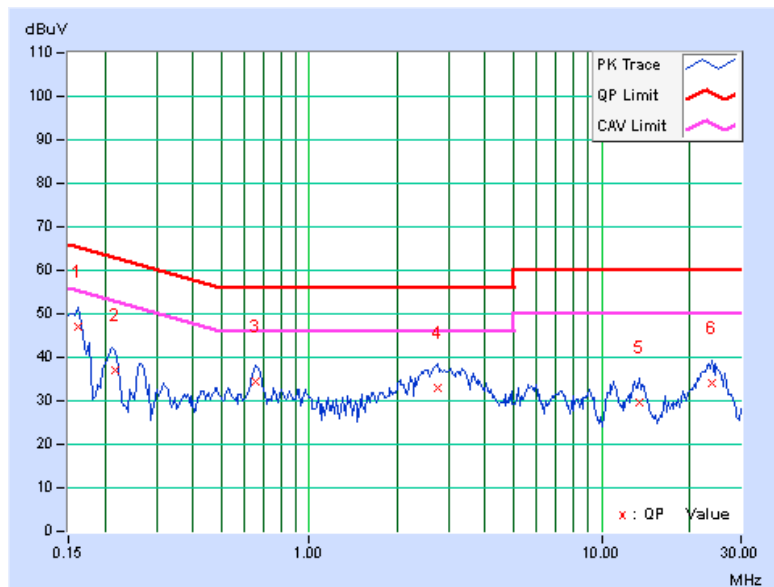

PHASE	Line 1	6dB BANDWIDTH	9kHz
CHANNEL	Channel 116		

No	Freq. [MHz]	Corr. Factor (dB)	Reading Value		Emission Level		Limit		Margin	
			[dB (uV)]		[dB (uV)]		[dB (uV)]		(dB)	
			Q.P.	AV.	Q.P.	AV.	Q.P.	AV.	Q.P.	AV.
1	0.17344	0.15	45.88	35.17	46.03	35.32	64.79	54.79	-18.76	-19.47
2	0.23203	0.15	37.94	27.65	38.09	27.80	62.38	52.38	-24.28	-24.57
3	0.64219	0.18	32.94	21.77	33.12	21.95	56.00	46.00	-22.88	-24.05
4	1.45703	0.22	30.47	23.03	30.69	23.25	56.00	46.00	-25.31	-22.75
5	5.89453	0.37	41.06	27.83	41.43	28.20	60.00	50.00	-18.57	-21.80
6	10.89844	0.45	40.59	34.01	41.04	34.46	60.00	50.00	-18.96	-15.54

- REMARKS:**
1. Q.P. and AV. are abbreviations of quasi-peak and average individually.
 2. The emission levels of other frequencies were very low against the limit.
 3. Margin value = Emission level - Limit value
 4. Correction factor = Insertion loss + Cable loss
 5. Emission Level = Correction Factor + Reading Value.

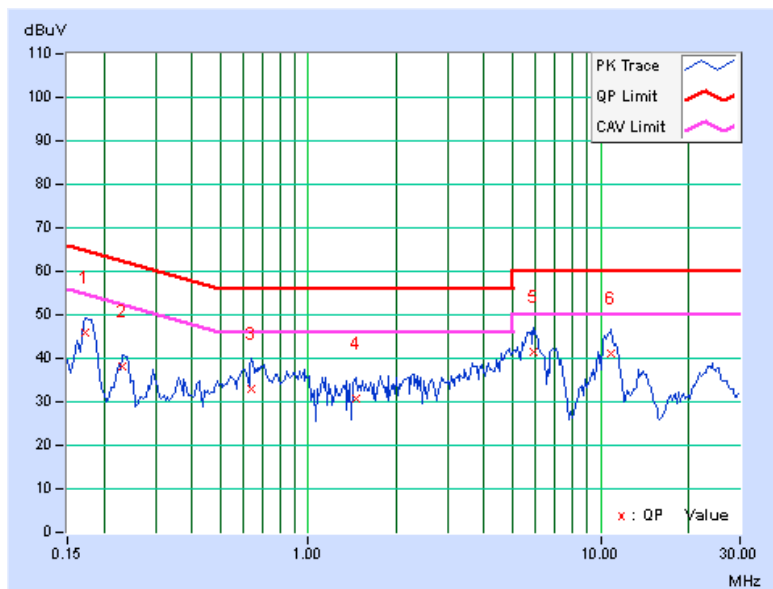



A D T

PHASE	Line 2	6dB BANDWIDTH	9kHz
CHANNEL	Channel 116		

No	Freq. [MHz]	Corr. Factor (dB)	Reading Value		Emission Level		Limit		Margin	
			[dB (uV)]		[dB (uV)]		[dB (uV)]		(dB)	
			Q.P.	AV.	Q.P.	AV.	Q.P.	AV.	Q.P.	AV.
1	0.15000	0.13	42.36	29.51	42.49	29.64	66.00	56.00	-23.51	-26.36
2	0.23984	0.14	35.62	26.03	35.76	26.17	62.10	52.10	-26.34	-25.93
3	0.64609	0.17	29.49	20.72	29.66	20.89	56.00	46.00	-26.34	-25.11
4	2.84375	0.30	33.17	24.47	33.47	24.77	56.00	46.00	-22.53	-21.23
5	13.14844	0.56	27.60	20.86	28.16	21.42	60.00	50.00	-31.84	-28.58
6	23.96875	0.65	33.12	28.14	33.77	28.79	60.00	50.00	-26.23	-21.21

- REMARKS:**
1. Q.P. and AV. are abbreviations of quasi-peak and average individually.
 2. The emission levels of other frequencies were very low against the limit.
 3. Margin value = Emission level - Limit value
 4. Correction factor = Insertion loss + Cable loss
 5. Emission Level = Correction Factor + Reading Value.

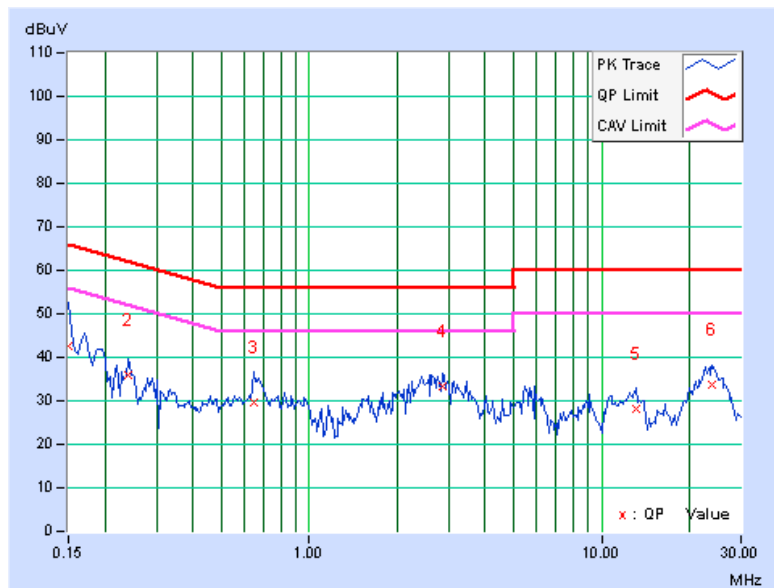

802.11n (40MHz): 2TX

PHASE	Line 1	6dB BANDWIDTH	9kHz
CHANNEL	Channel 38		

No	Freq. [MHz]	Corr. Factor (dB)	Reading Value		Emission Level		Limit		Margin	
			[dB (uV)]		[dB (uV)]		[dB (uV)]		(dB)	
			Q.P.	AV.	Q.P.	AV.	Q.P.	AV.	Q.P.	AV.
1	0.16562	0.15	46.15	35.09	46.30	35.24	65.18	55.18	-18.88	-19.94
2	0.21641	0.15	39.26	30.98	39.41	31.13	62.96	52.96	-23.54	-21.82
3	0.65781	0.18	37.71	29.79	37.89	29.97	56.00	46.00	-18.11	-16.03
4	1.36719	0.22	30.00	22.23	30.22	22.45	56.00	46.00	-25.78	-23.55
5	5.86328	0.37	40.66	28.33	41.03	28.70	60.00	50.00	-18.97	-21.30
6	10.92969	0.45	37.37	30.72	37.82	31.17	60.00	50.00	-22.18	-18.83

- REMARKS:**
1. Q.P. and AV. are abbreviations of quasi-peak and average individually.
 2. The emission levels of other frequencies were very low against the limit.
 3. Margin value = Emission level - Limit value
 4. Correction factor = Insertion loss + Cable loss
 5. Emission Level = Correction Factor + Reading Value.

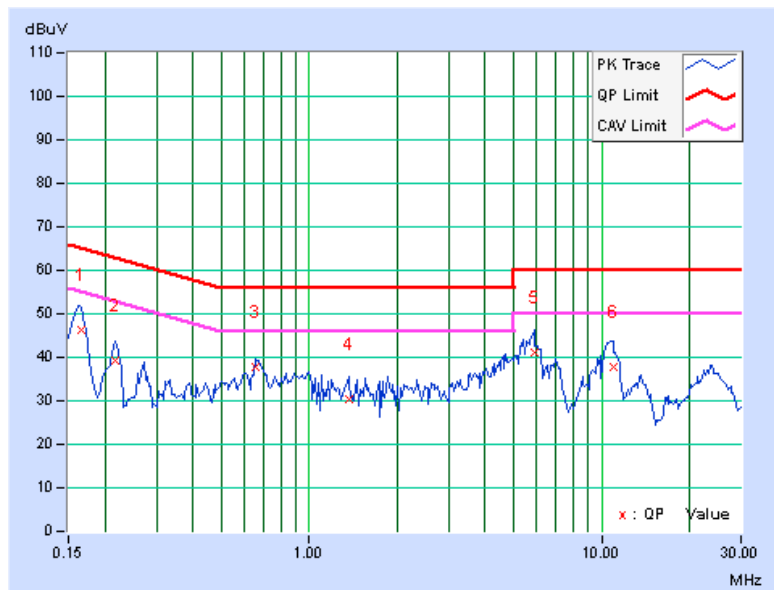



A D T

PHASE	Line 2	6dB BANDWIDTH	9kHz
CHANNEL	Channel 38		

No	Freq. [MHz]	Corr. Factor (dB)	Reading Value		Emission Level		Limit		Margin	
			[dB (uV)]		[dB (uV)]		[dB (uV)]		(dB)	
			Q.P.	AV.	Q.P.	AV.	Q.P.	AV.	Q.P.	AV.
1	0.16953	0.13	40.38	19.70	40.51	19.83	64.98	54.98	-24.47	-35.15
2	0.23594	0.14	35.17	27.47	35.31	27.61	62.24	52.24	-26.92	-24.62
3	0.67734	0.17	28.78	20.72	28.95	20.89	56.00	46.00	-27.05	-25.11
4	2.73828	0.29	32.45	24.83	32.74	25.12	56.00	46.00	-23.26	-20.88
5	12.72266	0.55	28.12	22.20	28.67	22.75	60.00	50.00	-31.33	-27.25
6	23.73438	0.66	32.99	28.17	33.65	28.83	60.00	50.00	-26.35	-21.17

- REMARKS:**
1. Q.P. and AV. are abbreviations of quasi-peak and average individually.
 2. The emission levels of other frequencies were very low against the limit.
 3. Margin value = Emission level - Limit value
 4. Correction factor = Insertion loss + Cable loss
 5. Emission Level = Correction Factor + Reading Value.

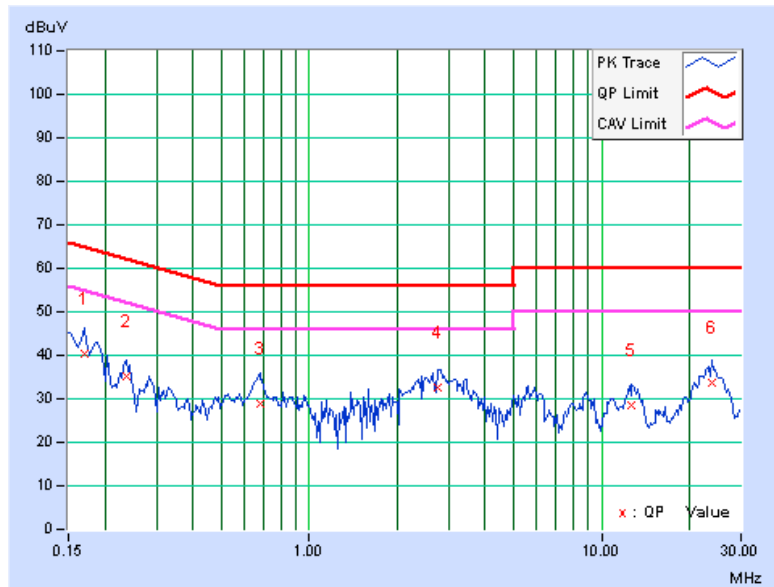

802.11n (20MHz): 2TX

PHASE	Line 1	6dB BANDWIDTH	9kHz
CHANNEL	Channel 100		

No	Freq. [MHz]	Corr. Factor (dB)	Reading Value		Emission Level		Limit		Margin	
			[dB (uV)]		[dB (uV)]		[dB (uV)]		(dB)	
			Q.P.	AV.	Q.P.	AV.	Q.P.	AV.	Q.P.	AV.
1	0.20859	0.15	41.93	31.60	42.08	31.75	63.26	53.26	-21.18	-21.51
2	0.28672	0.16	33.48	21.26	33.64	21.42	60.62	50.62	-26.98	-29.20
3	0.65781	0.18	33.30	22.44	33.48	22.62	56.00	46.00	-22.52	-23.38
4	1.50000	0.23	34.18	21.56	34.41	21.79	56.00	46.00	-21.59	-24.21
5	5.80469	0.37	41.41	30.19	41.78	30.56	60.00	50.00	-18.22	-19.44
6	11.05078	0.45	43.36	36.83	43.81	37.28	60.00	50.00	-16.19	-12.72

- REMARKS:**
1. Q.P. and AV. are abbreviations of quasi-peak and average individually.
 2. The emission levels of other frequencies were very low against the limit.
 3. Margin value = Emission level - Limit value
 4. Correction factor = Insertion loss + Cable loss
 5. Emission Level = Correction Factor + Reading Value.

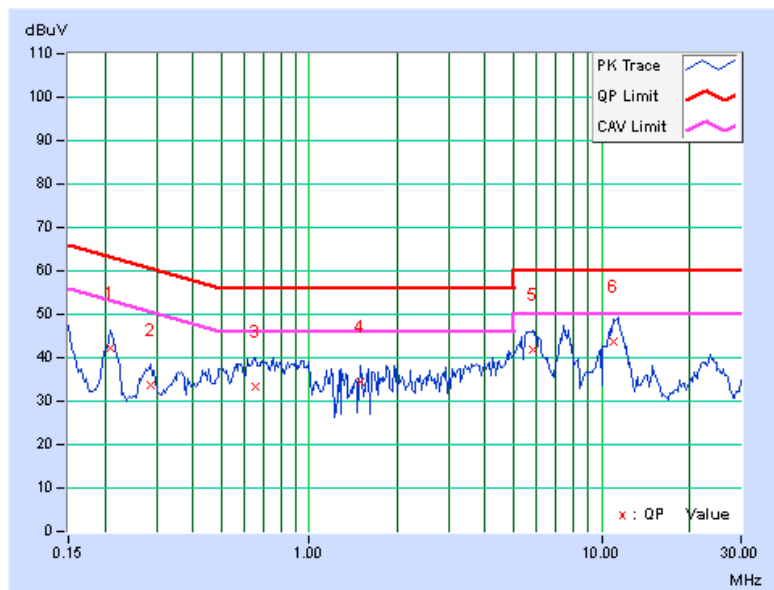



A D T

PHASE	Line 2	6dB BANDWIDTH	9kHz
CHANNEL	Channel 100		

No	Freq. [MHz]	Corr. Factor (dB)	Reading Value		Emission Level		Limit		Margin	
			[dB (uV)]		[dB (uV)]		[dB (uV)]		(dB)	
			Q.P.	AV.	Q.P.	AV.	Q.P.	AV.	Q.P.	AV.
1	0.15000	0.13	42.60	31.56	42.73	31.69	66.00	56.00	-23.27	-24.31
2	0.23984	0.14	35.58	25.99	35.72	26.13	62.10	52.10	-26.38	-25.97
3	0.67734	0.17	28.81	20.42	28.98	20.59	56.00	46.00	-27.02	-25.41
4	2.55469	0.28	33.12	24.85	33.40	25.13	56.00	46.00	-22.60	-20.87
5	12.90234	0.55	28.91	21.98	29.46	22.53	60.00	50.00	-30.54	-27.47
6	24.93359	0.64	31.75	26.75	32.39	27.39	60.00	50.00	-27.61	-22.61

- REMARKS:**
1. Q.P. and AV. are abbreviations of quasi-peak and average individually.
 2. The emission levels of other frequencies were very low against the limit.
 3. Margin value = Emission level - Limit value
 4. Correction factor = Insertion loss + Cable loss
 5. Emission Level = Correction Factor + Reading Value.

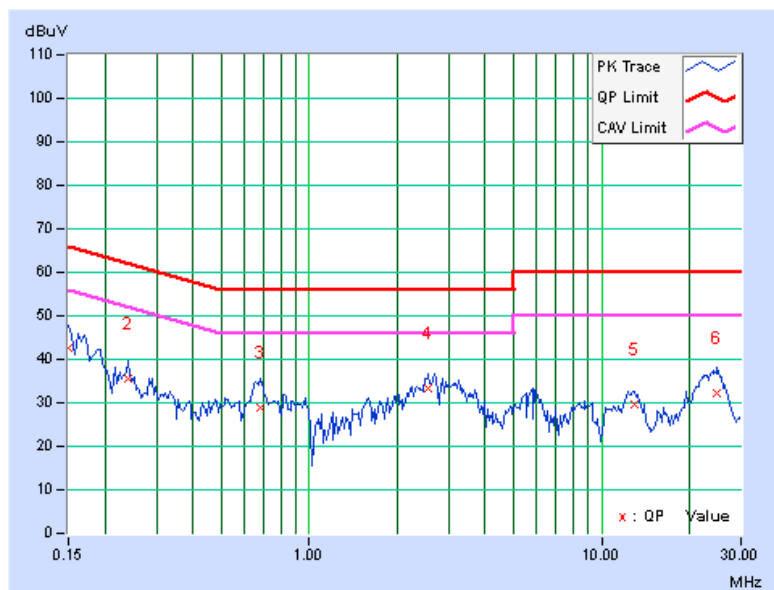

4.3 PEAK TRANSMIT POWER MEASUREMENT

4.3.1 LIMITS OF PEAK TRANSMIT POWER MEASUREMENT

FREQUENCY BAND	LIMIT
5.150 ~ 5.250GHz	The lesser of 50mW (17dBm) or 4dBm + 10logB
5.250 ~ 5.350GHz	The lesser of 250mW (24dBm) or 11dBm + 10logB
5.470 ~ 5.725GHz	The lesser of 250mW (24dBm) or 11dBm + 10logB

NOTE: Where B is the 26dB emission bandwidth in MHz.

4.3.2 TEST SETUP

FOR POWER OUTPUT MEASUREMENT

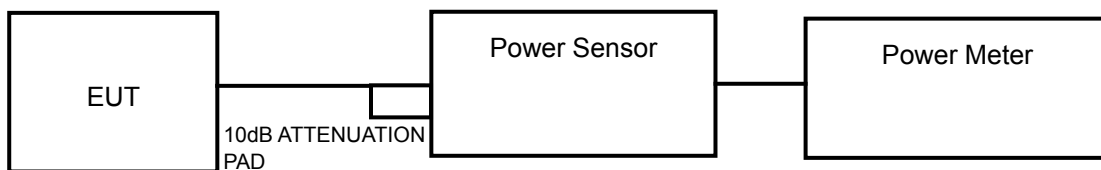

FOR 26dB BANDWIDTH

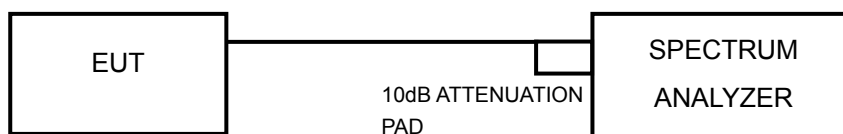

4.3.3 TEST INSTRUMENTS

Refer to section 4.1.3 to get information of above instrument.

4.3.4 TEST PROCEDURE

FOR AVERAGE POWER MEASUREMENT (Method-PM)

Method PM is used to perform output power measurement, trigger and gating function of wide band power meter is enabled to measure max output power of TX on burst. Duty factor is not added to measured value.

FOR 26dB BANDWIDTH

- 1) Set RBW = approximately 1% of the emission bandwidth.
- 2) Set the VBW > RBW.
- 3) Detector = Peak.
- 4) Trace mode = max hold.
- 5) Measure the maximum width of the emission that is 26 dB down from the peak of the emission. Compare this with the RBW setting of the analyzer. Readjust RBW and repeat measurement as needed until the RBW/EBW ratio is approximately 1%.

4.3.5 DEVIATION FROM TEST STANDARD

No deviation.

4.3.6 EUT OPERATING CONDITIONS

The software provided by client to enable the EUT under transmission condition continuously at specific channel frequencies individually.



4.3.7 TEST RESULTS

POWER OUTPUT: 802.11a: 1TX

CHANNEL	CHANNEL FREQUENCY (MHz)	AVERAGE POWER (mW)	AVERAGE POWER (dBm)	POWER LIMIT (dBm)	PASS/FAIL
36	5180	28.576	14.56	17	PASS
44	5220	27.861	14.45	17	PASS
48	5240	27.227	14.35	17	PASS
52	5260	45.394	16.57	24	PASS
60	5300	44.566	16.49	24	PASS
64	5320	45.814	16.61	24	PASS
100	5500	41.115	16.14	24	PASS
116	5580	44.771	16.51	24	PASS
132	5660	45.814	16.61	24	PASS
140	5700	45.499	16.58	24	PASS

802.11n (20MHz): 1TX

CHANNEL	CHANNEL FREQUENCY (MHz)	AVERAGE POWER (mW)	AVERAGE POWER (dBm)	POWER LIMIT (dBm)	PASS/FAIL
36	5180	27.990	14.47	17	PASS
44	5220	28.249	14.51	17	PASS
48	5240	27.733	14.43	17	PASS
52	5260	45.604	16.59	24	PASS
60	5300	46.026	16.63	24	PASS
64	5320	44.875	16.52	24	PASS
100	5500	34.198	15.34	24	PASS
116	5580	46.452	16.67	24	PASS
132	5660	44.463	16.48	24	PASS
140	5700	33.189	15.21	24	PASS

802.11n (40MHz): 1TX

CHANNEL	CHANNEL FREQUENCY (MHz)	AVERAGE POWER (mW)	AVERAGE POWER (dBm)	POWER LIMIT (dBm)	PASS/FAIL
38	5190	25.468	14.06	17	PASS
46	5230	45.499	16.58	17	PASS
54	5270	45.814	16.61	24	PASS
62	5310	22.080	13.44	24	PASS
102	5510	18.967	12.78	24	PASS
110	5550	45.814	16.61	24	PASS
134	5670	46.132	16.64	24	PASS



802.11n (20MHz): 2TX

CHAN.	CHAN. FREQ. (MHz)	AVERAGE POWER (dBm)		TOTAL POWER (mW)	TOTAL POWER (dBm)	POWER LIMIT (dBm)	PASS / FAIL
		CHAIN 0	CHAIN 1				
36	5180	11.63	11.56	28.9	14.6	17	PASS
44	5220	11.61	11.54	28.7	14.6	17	PASS
48	5240	11.42	11.52	28.1	14.5	17	PASS
52	5260	13.69	13.53	45.9	16.6	24	PASS
60	5300	13.78	13.51	46.3	16.7	24	PASS
64	5320	13.68	13.71	46.8	16.7	24	PASS
100	5500	13.71	13.87	47.9	16.8	24	PASS
116	5580	13.63	13.50	45.5	16.6	24	PASS
132	5660	13.43	13.52	44.5	16.5	24	PASS
140	5700	13.68	13.78	47.2	16.7	24	PASS

**Signal type of 802.11n mode is uncorrelated.

802.11n (40MHz): 2TX

CHAN.	CHAN. FREQ. (MHz)	AVERAGE POWER (dBm)		TOTAL POWER (mW)	TOTAL POWER (dBm)	POWER LIMIT (dBm)	PASS / FAIL
		CHAIN 0	CHAIN 1				
38	5190	13.81	13.72	47.6	16.8	17	PASS
46	5230	13.55	13.78	46.5	16.7	17	PASS
54	5270	13.51	13.85	46.7	16.7	24	PASS
62	5310	13.64	13.51	45.6	16.6	24	PASS
102	5510	12.51	12.64	36.2	15.6	24	PASS
110	5550	13.67	13.78	47.2	16.7	24	PASS
134	5670	13.78	13.56	46.6	16.7	24	PASS

**Signal type of 802.11n mode is uncorrelated.



26dB BANDWIDTH: 802.11a: 1TX

CHANNEL	CHANNEL FREQUENCY (MHz)	26dBc BANDWIDTH (MHz)	PASS / FAIL
36	5180	24.73	PASS
44	5220	27.53	PASS
48	5240	24.00	PASS
52	5260	29.48	PASS
60	5300	34.10	PASS
64	5320	28.82	PASS
100	5500	27.04	PASS
116	5580	28.91	PASS
132	5660	37.03	PASS
140	5700	37.15	PASS

802.11n (20MHz): 1TX

CHANNEL	CHANNEL FREQUENCY (MHz)	26dBc BANDWIDTH (MHz)	PASS / FAIL
36	5180	22.31	PASS
44	5220	23.32	PASS
48	5240	23.59	PASS
52	5260	39.64	PASS
60	5300	43.03	PASS
64	5320	39.48	PASS
100	5500	28.47	PASS
116	5580	39.88	PASS
132	5660	40.89	PASS
140	5700	27.55	PASS

802.11n (40MHz): 1TX

CHANNEL	CHANNEL FREQUENCY (MHz)	26dBc BANDWIDTH (MHz)	PASS / FAIL
38	5190	45.01	PASS
46	5230	58.04	PASS
54	5270	58.30	PASS
62	5310	44.74	PASS
102	5510	41.33	PASS
110	5550	59.28	PASS
134	5670	61.20	PASS



802.11n (20MHz): 2TX

CHANNEL	CHANNEL FREQUENCY (MHz)	26dBc BANDWIDTH (MHz)		PASS / FAIL
		CHAIN 0	CHAIN 1	
36	5180	21.03	21.14	PASS
44	5220	20.93	21.14	PASS
48	5240	21.03	21.10	PASS
52	5260	21.42	21.43	PASS
60	5300	21.52	21.48	PASS
64	5320	21.82	21.71	PASS
100	5500	21.93	21.73	PASS
116	5580	23.37	21.90	PASS
132	5660	22.03	21.70	PASS
140	5700	21.93	22.06	PASS

802.11n (40MHz): 2TX

CHANNEL	CHANNEL FREQUENCY (MHz)	26dBc BANDWIDTH (MHz)		PASS / FAIL
		CHAIN 0	CHAIN 1	
38	5190	40.72	41.43	PASS
46	5230	40.62	41.06	PASS
54	5270	40.84	41.19	PASS
62	5310	40.70	41.14	PASS
102	5510	40.59	41.03	PASS
110	5550	44.83	41.19	PASS
134	5670	46.84	42.25	PASS

4.4 PEAK POWER SPECTRAL DENSITY MEASUREMENT

4.4.1 LIMITS OF PEAK POWER SPECTRAL DENSITY MEASUREMENT

FREQUENCY BAND	LIMIT
5.150 ~ 5.250GHz	4dBm
5.250 ~ 5.350GHz	11dBm
5.470 ~ 5.725GHz	11dBm

4.4.2 TEST SETUP

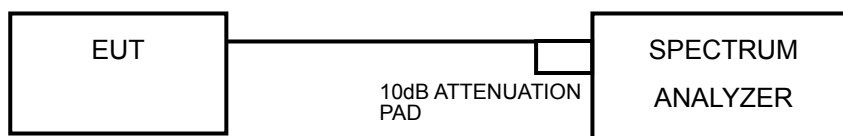

4.4.3 TEST INSTRUMENTS

Refer to section 4.1.3 to get information of above instrument.

4.4.4 TEST PROCEDURES

- 1) Set span to encompass the entire emission bandwidth (EBW) of the signal.
- 2) Set RBW = 1 MHz, Set VBW \geq 3 MHz, Detector = RMS
- 3) Sweep time = auto, trigger set to “free run”.
- 4) Trace average at least 100 traces in power averaging mode.
- 5) Record the max value

4.4.5 DEVIATION FROM TEST STANDARD

No deviation.

4.4.6 EUT OPERATING CONDITIONS

Same as 4.3.6.



4.4.7 TEST RESULTS

802.11a: 1TX

CHANNEL	FREQUENCY (MHz)	PSD (dBm)	MAXIMUM LIMIT (dBm)	PASS/FAIL
36	5180	3.71	4	PASS
44	5220	3.62	4	PASS
48	5240	3.57	4	PASS
52	5260	5.47	11	PASS
60	5300	5.19	11	PASS
64	5320	5.36	11	PASS
100	5500	4.69	11	PASS
116	5580	5.53	11	PASS
132	5660	5.59	11	PASS
140	5700	5.47	11	PASS

802.11n (20MHz): 1TX

CHANNEL	FREQUENCY (MHz)	PSD (dBm)	MAXIMUM LIMIT (dBm)	PASS/FAIL
36	5180	3.76	4	PASS
44	5220	3.61	4	PASS
48	5240	3.65	4	PASS
52	5260	5.31	11	PASS
60	5300	5.25	11	PASS
64	5320	5.07	11	PASS
100	5500	4.16	11	PASS
116	5580	5.34	11	PASS
132	5660	5.06	11	PASS
140	5700	3.70	11	PASS

802.11n (40MHz): 1TX

CHANNEL	FREQUENCY (MHz)	PSD (dBm)	MAXIMUM LIMIT (dBm)	PASS/FAIL
38	5190	0.53	4	PASS
46	5230	3.08	4	PASS
54	5270	2.61	11	PASS
62	5310	-0.16	11	PASS
102	5510	-0.80	11	PASS
110	5550	2.50	11	PASS
134	5670	2.48	11	PASS

**802.11n (20MHz): 2TX**

CHAN.	CHAN. FREQ. (MHz)	PSD (dBm)		TOTAL POWER DENSITY (dBm)	MAX. LIMIT (dBm)	PASS / FAIL
		CHAIN 0	CHAIN 1			
36	5180	0.76	0.86	3.786	4	PASS
44	5220	0.82	0.75	3.788	4	PASS
48	5240	0.57	0.65	3.614	4	PASS
52	5260	2.53	2.37	5.450	11	PASS
60	5300	2.46	2.26	5.288	11	PASS
64	5320	2.41	2.67	5.507	11	PASS
100	5500	2.60	2.61	5.616	11	PASS
116	5580	2.33	2.27	5.263	11	PASS
132	5660	2.06	2.23	5.089	11	PASS
140	5700	2.24	2.64	5.430	11	PASS

- NOTE:** 1. Method 1 of power density measurement of KDB 662911 is using for calculating total power density. Total power density is summing entire spectra across corresponding frequency bins on the various outputs by computer.
2. Signal type of 802.11n mode is uncorrelated.

802.11n (40MHz): 2TX

CHAN.	CHAN. FREQ. (MHz)	PSD (dBm)		TOTAL POWER DENSITY (dBm)	MAX. LIMIT (dBm)	PASS / FAIL
		CHAIN 0	CHAIN 1			
38	5190	-0.51	-0.29	2.593	4	PASS
46	5230	-0.68	-0.25	2.526	4	PASS
54	5270	-0.60	-0.15	2.618	11	PASS
62	5310	-0.87	-0.64	2.192	11	PASS
102	5510	-1.88	-1.40	1.372	11	PASS
110	5550	-0.59	-0.25	2.579	11	PASS
134	5670	-0.62	-0.55	2.388	11	PASS

- NOTE:** 1. Method 1 of power density measurement of KDB 662911 is using for calculating total power density. Total power density is summing entire spectra across corresponding frequency bins on the various outputs by computer.
2. Signal type of 802.11n mode is uncorrelated.

4.5 PEAK POWER EXCURSION MEASUREMENT

4.5.1 LIMITS OF PEAK POWER EXCURSION MEASUREMENT

Shall not exceed 13 dB.

4.5.2 TEST SETUP

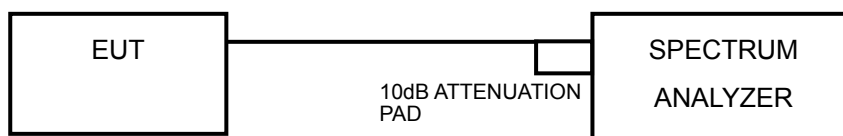

4.5.3 TEST INSTRUMENTS

Refer to section 4.1.3 to get information of above instrument.

4.5.4 TEST PROCEDURE

- 1) Set RBW = 1 MHz, VBW \geq 3 MHz, Detector = peak.
- 2) Trace mode = max-hold. Allow the sweeps to continue until the trace stabilizes.
- 3) Use the peak search function to find the peak of the spectrum.
- 4) Measure the PPSD.
- 5) Compute the ratio of the maximum of the peak-max-hold spectrum to the PPSD.

4.5.5 DEVIATION FROM TEST STANDARD

No deviation.

4.5.6 EUT OPERATING CONDITIONS

Same as 4.2.6

4.5.7 TEST RESULTS

802.11a: 1TX

CHANNEL	CHANNEL FREQUENCY (MHz)	PEAK VALUE (dBm)	PPSD (dBm)	PEAK EXCURSION (dB)	LIMIT (dB)	PASS/FAIL
36	5180	12.10	3.71	8.39	13	PASS
44	5220	12.20	3.62	8.58	13	PASS
48	5240	12.10	3.57	8.53	13	PASS
52	5260	14.24	5.47	8.77	13	PASS
60	5300	13.98	5.19	8.79	13	PASS
64	5320	14.04	5.36	8.68	13	PASS
100	5500	13.53	4.69	8.84	13	PASS
116	5580	13.99	5.53	8.46	13	PASS
132	5660	13.99	5.59	8.40	13	PASS
140	5700	13.99	5.47	8.52	13	PASS

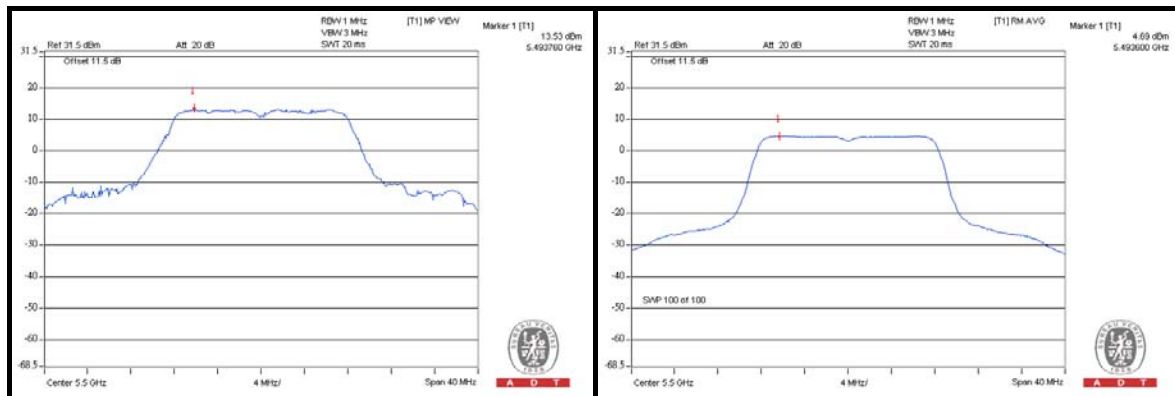



A D T

802.11n (20MHz): 1TX

CHANNEL	CHANNEL FREQUENCY (MHz)	PEAK VALUE (dBm)	PPSD (dBm)	PEAK EXCURSION (dB)	LIMIT (dB)	PASS/FAIL
36	5180	11.60	3.76	7.84	13	PASS
44	5220	11.65	3.61	8.04	13	PASS
48	5240	11.59	3.65	7.94	13	PASS
52	5260	13.70	5.31	8.39	13	PASS
60	5300	13.53	5.25	8.28	13	PASS
64	5320	13.49	5.07	8.42	13	PASS
100	5500	12.66	4.16	8.50	13	PASS
116	5580	13.56	5.34	8.22	13	PASS
132	5660	13.46	5.06	8.40	13	PASS
140	5700	12.25	3.70	8.55	13	PASS

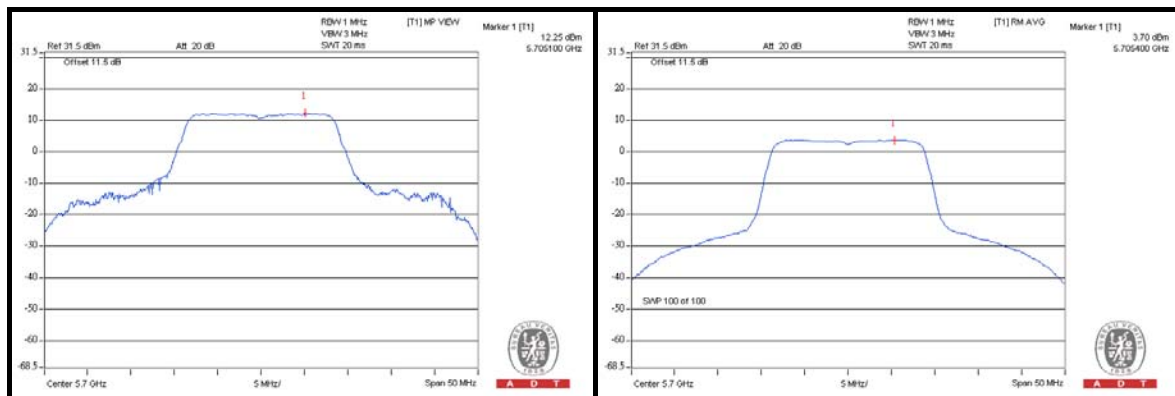



802.11n (40MHz): 1TX

CHANNEL	CHANNEL FREQUENCY (MHz)	PEAK VALUE (dBm)	PPSD (dBm)	PEAK EXCURSION (dB)	LIMIT (dB)	PASS/FAIL
38	5190	9.36	0.53	8.83	13	PASS
46	5230	11.77	3.08	8.69	13	PASS
54	5270	11.34	2.61	8.73	13	PASS
62	5310	8.51	-0.16	8.67	13	PASS
102	5510	8.01	-0.80	8.81	13	PASS
110	5550	11.33	2.50	8.83	13	PASS
134	5670	11.29	2.48	8.81	13	PASS

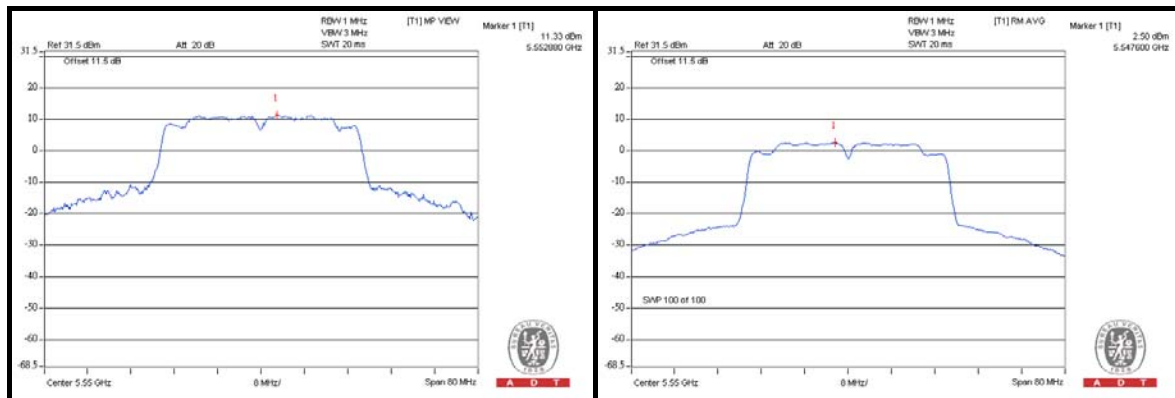

802.11n (20MHz): 2TX

CHAN.	CHAN. FREQ. (MHz)	PEAK VALUE (dBm)		PPSD (dBm)		PEAK EXCURSION (dB)		LIMIT (dB)	PASS/ FAIL
		CHAIN 0	CHAIN 1	CHAIN 0	CHAIN 1	CHAIN 0	CHAIN 1		
36	5180	10.31	10.50	0.76	0.86	9.55	9.64	13	PASS
44	5220	10.42	10.39	0.82	0.75	9.60	9.64	13	PASS
48	5240	10.18	10.37	0.57	0.65	9.61	9.72	13	PASS
52	5260	12.43	12.35	2.53	2.37	9.90	9.98	13	PASS
60	5300	12.47	12.23	2.46	2.26	10.01	9.97	13	PASS
64	5320	12.35	12.45	2.41	2.67	9.94	9.78	13	PASS
100	5500	12.50	12.58	2.60	2.61	9.90	9.97	13	PASS
116	5580	12.22	12.27	2.33	2.27	9.89	10.00	13	PASS
132	5660	11.99	12.43	2.06	2.23	9.93	10.20	13	PASS
140	5700	12.15	12.56	2.24	2.64	9.91	9.92	13	PASS

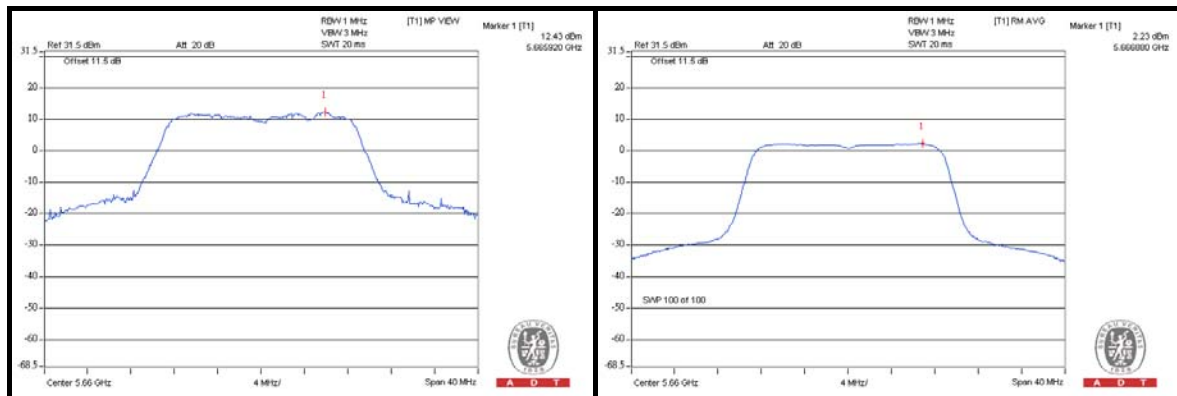



A D T

802.11n (40MHz): 2TX

CHAN.	CHAN. FREQ. (MHz)	PEAK VALUE (dBm)		PPSD (dBm)		PEAK EXCURSION (dB)		LIMIT (dB)	PASS/FAIL
		CHAIN 0	CHAIN 1	CHAIN 0	CHAIN 1	CHAIN 0	CHAIN 1		
38	5190	9.28	10.04	-0.51	-0.29	9.79	10.33	13	PASS
46	5230	9.24	10.14	-0.68	-0.25	9.92	10.39	13	PASS
54	5270	9.19	10.02	-0.60	-0.15	9.79	10.17	13	PASS
62	5310	9.17	9.68	-0.87	-0.64	10.04	10.32	13	PASS
102	5510	7.89	8.85	-1.88	-1.40	9.77	10.25	13	PASS
110	5550	9.01	10.07	-0.59	-0.25	9.60	10.32	13	PASS
134	5670	9.01	9.77	-0.62	-0.55	9.63	10.32	13	PASS

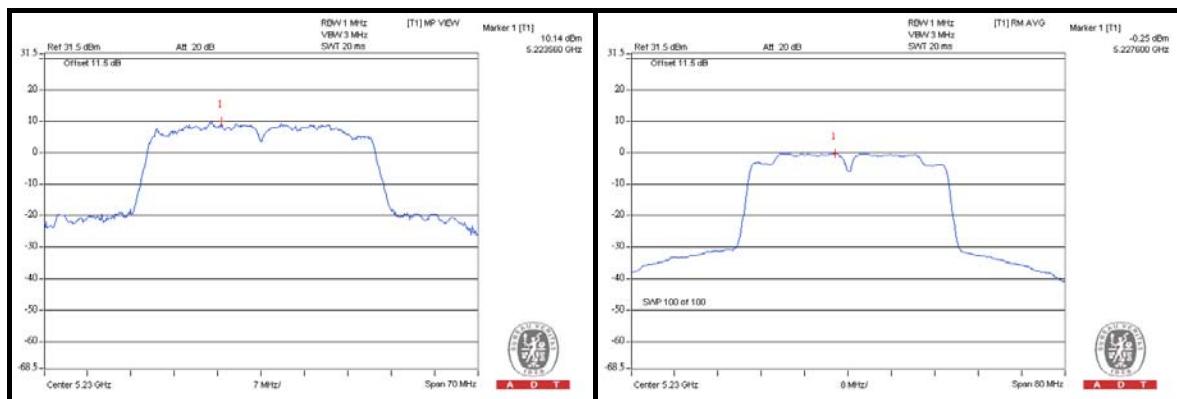

4.6 FREQUENCY STABILITY

4.6.1 LIMITS OF FREQUENCY STABILITY MEASUREMENT

The frequency of the carrier signal shall be maintained within band of operation

4.6.2 TEST SETUP

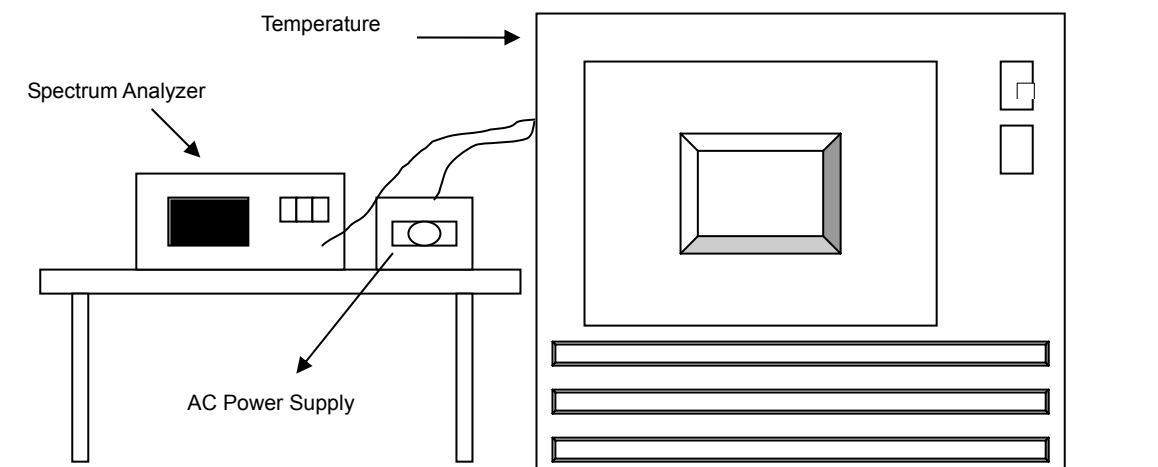

4.6.3 TEST INSTRUMENTS

Refer to section 4.1.3 to get information of above instrument.

4.6.4 TEST PROCEDURE

- a. The EUT was placed inside the environmental test chamber and powered by nominal AC voltage.
- b. Turn the EUT on and couple its output to a spectrum analyzer.
- c. Turn the EUT off and set the chamber to the highest temperature specified.
- d. Allow sufficient time (approximately 30 min) for the temperature of the chamber to stabilize, turn the EUT on and measure the operating frequency after 2, 5, and 10 minutes.
- e. Repeat step 2 and 3 with the temperature chamber set to the lowest temperature.
- f. The test chamber was allowed to stabilize at +20 degree C for a minimum of 30 minutes. The supply voltage was then adjusted on the EUT from 85% to 115% and the frequency record.

4.6.5 DEVIATION FROM TEST STANDARD

No deviation.

4.6.6 EUT OPERATING CONDITION

Set the EUT transmit at un-modulation mode to test frequency stability.



4.6.7 TEST RESULTS

FREQUENCY STABILITY VERSUS TEMP.									
OPERATING FREQUENCY: 5320MHz									
TEMP. (°C)	POWER SUPPLY (Vac)	0 MINUTE		2 MINUTE		5 MINUTE		10 MINUTE	
		Measured Frequency (MHz)	Frequency Drift (ppm)	Measured Frequency (MHz)	Frequency Drift (ppm)	Measured Frequency (MHz)	Frequency Drift (ppm)	Measured Frequency (MHz)	Frequency Drift (ppm)
55	110.0	5320.087725	16.490	5320.088295	16.597	5320.088197	16.578	5320.088265	16.591
50	110.0	5320.088628	16.659	5320.088521	16.639	5320.088263	16.591	5320.088610	16.656
40	110.0	5320.090279	16.970	5320.089592	16.841	5320.089581	16.839	5320.089915	16.901
30	110.0	5320.091189	17.141	5320.091264	17.155	5320.091315	17.164	5320.091412	17.183
20	110.0	5320.092691	17.423	5320.092445	17.377	5320.092776	17.439	5320.092543	17.395
10	110.0	5320.090860	17.079	5320.091154	17.134	5320.090797	17.067	5320.091343	17.170
0	110.0	5320.089640	16.850	5320.089997	16.917	5320.089565	16.836	5320.089739	16.868
-10	110.0	5320.089246	16.776	5320.089356	16.796	5320.089436	16.811	5320.088581	16.651
-20	110.0	5320.087915	16.525	5320.087653	16.476	5320.087759	16.496	5320.087894	16.521
-30	110.0	5320.089162	16.760	5320.089012	16.732	5320.089331	16.792	5320.089029	16.735

FREQUENCY STABILITY VERSUS VOLTAGE									
OPERATING FREQUENCY: 5320MHz									
TEMP. (°C)	POWER SUPPLY (Vac)	0 MINUTE		2 MINUTE		5 MINUTE		10 MINUTE	
		Measured Frequency (MHz)	Frequency Drift (ppm)	Measured Frequency (MHz)	Frequency Drift (ppm)	Measured Frequency (MHz)	Frequency Drift (ppm)	Measured Frequency (MHz)	Frequency Drift (ppm)
20	93.5	5320.091533	17.205	5320.091454	17.191	5320.091140	17.132	5320.091064	17.117
	110.0	5320.092691	17.423	5320.092445	17.377	5320.092776	17.439	5320.092543	17.395
	126.5	5320.091080	17.120	5320.090965	17.099	5320.091124	17.129	5320.091044	17.114

5. PHOTOGRAPHS OF THE TEST CONFIGURATION

Please refer to the attached file (Test Setup Photo).



6. INFORMATION ON THE TESTING LABORATORIES

We, Bureau Veritas Consumer Products Services (H.K.) Ltd., Taoyuan Branch, were founded in 1988 to provide our best service in EMC, Radio, Telecom and Safety consultation. Our laboratories are accredited and approved according to ISO/IEC 17025.

Copies of accreditation and authorization certificates of our laboratories obtained from approval agencies can be downloaded from our web site: www.adt.com.tw/index.5.phtml. If you have any comments, please feel free to contact us at the following:

Linko EMC/RF Lab:
Tel: 886-2-26052180
Fax: 886-2-26051924

Hsin Chu EMC/RF Lab:
Tel: 886-3-5935343
Fax: 886-3-5935342

Hwa Ya EMC/RF/Safety Telecom Lab:
Tel: 886-3-3183232
Fax: 886-3-3270892

Email: service.adt@tw.bureauveritas.com
Web Site: www.adt.com.tw

The address and road map of all our labs can be found in our web site also.

7. APPENDIX A - MODIFICATIONS RECORDERS FOR ENGINEERING CHANGES TO THE EUT BY THE LAB

No modifications were made to the EUT by the lab during the test.

---END---