



FCC RF Test Report

APPLICANT : Getac Technology Corporation.
EQUIPMENT : Body Worn Camera
BRAND NAME : Getac
MODEL NAME : Veretos BC-02
FCC ID : QYLBWC2
STANDARD : FCC Part 15 Subpart C §15.247
CLASSIFICATION : (DTS) Digital Transmission System

This is a variant report which is only valid together with the original test report. The product was received on Aug. 03, 2016 and testing was completed on Sep. 14, 2016. We, SPORTON INTERNATIONAL INC., would like to declare that the tested sample has been evaluated in accordance with the test procedures and has been in compliance with the applicable technical standards.

The test results in this report apply exclusively to the tested model / sample. Without written approval of SPORTON INTERNATIONAL INC., the test report shall not be reproduced except in full.

Reviewed by: Joseph Lin / Supervisor

Approved by: Jones Tsai / Manager



SPORTON INTERNATIONAL INC.

No. 52, Hwa Ya 1st Rd., Hwa Ya Technology Park, Kwei-Shan District, Tao Yuan City, Taiwan, R.O.C.

SPORTON INTERNATIONAL INC.

TEL : 886-3-327-3456

FAX : 886-3-328-4978

FCC ID : QYLBWC2

Page Number : 1 of 20

Report Issued Date : Oct. 17, 2016

Report Version : Rev. 01

Report Template No.: BU5-FR15CBT4.0 Version 1.3



TABLE OF CONTENTS

REVISION HISTORY..... 3

SUMMARY OF TEST RESULT 4

1 GENERAL DESCRIPTION..... 5

 1.1 Applicant 5

 1.2 Manufacturer..... 5

 1.3 Product Feature of Equipment Under Test..... 5

 1.4 Product Specification of Equipment Under Test..... 5

 1.5 Modification of EUT 5

 1.6 Testing Location 6

 1.7 Applicable Standards..... 6

2 TEST CONFIGURATION OF EQUIPMENT UNDER TEST..... 7

 2.1 Descriptions of Test Mode 7

 2.2 Test Mode..... 7

 2.3 Connection Diagram of Test System..... 8

 2.4 Support Unit used in test configuration and system 8

 2.5 EUT Operation Test Setup 9

3 TEST RESULT 10

 3.1 Radiated Band Edges and Spurious Emission Measurement 10

 3.2 AC Conducted Emission Measurement..... 14

 3.3 Antenna Requirements..... 18

4 LIST OF MEASURING EQUIPMENT..... 19

5 UNCERTAINTY OF EVALUATION..... 20

APPENDIX A. RADIATED SPURIOUS EMISSION

APPENDIX B. RADIATED SPURIOUS EMISSION PLOTS

APPENDIX C. DUTY CYCLE PLOTS

APPENDIX D. SETUP PHOTOGRAPHS

APPENDIX E. ORIGINAL REPORT



SUMMARY OF TEST RESULT

Report Section	FCC Rule	Description	Limit	Result	Remark
3.1	15.247(d)	Radiated Band Edges and Spurious Emission	15.209(a) & 15.247(d)	Pass	Under limit 2.79 dB at 4960.000 MHz
3.2	15.207	AC Conducted Emission	15.207(a)	Pass	Under limit 17.10 dB at 0.702 MHz
3.3	15.203 & 15.247(b)	Antenna Requirement	N/A	Pass	-



1 General Description

1.1 Applicant

Getac Technology Corporation.

5F., Building A, No. 209, Sec.1, Nangang Rd.,Nangang Dist., Taipei City 11568, Taiwan, R.O.C.

1.2 Manufacturer

Ability Enterprise Co., Ltd.

4F., No.8, Lane7, Wuchiuan Rd, Wugu Dist., New Taipei City 24886, Taiwan, R.O.C.

1.3 Product Feature of Equipment Under Test

Product Feature	
Equipment	Body Worn Camera
Brand Name	Getac
Model Name	Veretos BC-02
FCC ID	QYLBWC2
EUT supports Radios application	NFC WLAN 11b/g/n HT20 Bluetooth v4.0 LE
EUT Stage	Production Unit

Remark: The above EUT's information was declared by manufacturer. Please refer to the specifications or user's manual for more detailed description.

1.4 Product Specification of Equipment Under Test

Standards-related Product Specification	
Tx/Rx Frequency Range	2402 MHz ~ 2480 MHz
Number of Channels	40
Carrier Frequency of Each Channel	40 Channel(37 hopping + 3 advertising channel)
Maximum Output Power to Antenna	5.89 dBm (0.0039 W)
Antenna Type	PIFA Antenna type with gain 0.88 dBi
Type of Modulation	Bluetooth LE : GFSK

1.5 Modification of EUT

No modifications are made to the EUT during all test items.



1.6 Testing Location

Sporton Lab is accredited to ISO 17025 by Taiwan Accreditation Foundation (TAF code : 1190) and the FCC designation No. TW1022 under the FCC 2.948(e) by Mutual Recognition Agreement (MRA) in FCC Test.

Test Site	SPORTON INTERNATIONAL INC.	
Test Site Location	No. 52, Hwa Ya 1 st Rd., Hwa Ya Technology Park, Kwei-Shan District, Tao Yuan City, Taiwan, R.O.C. TEL: +886-3-327-3456 FAX: +886-3-328-4978	
Test Site No.	Sporton Site No.	
	TH02-HY	CO05-HY

Note: The test site complies with ANSI C63.4 2014 requirement.

Test Site	SPORTON INTERNATIONAL INC.	
Test Site Location	No.58, Aly. 75, Ln. 564, Wenhua 3rd Rd. Guishan Dist, Taoyuan City, Taiwan (R.O.C.) TEL: +886-3-327-0868 FAX: +886-3-327-0855	
Test Site No.	Sporton Site No.	
	03CH10-HY	

Note: The test site complies with ANSI C63.4 2014 requirement.

1.7 Applicable Standards

According to the specifications of the manufacturer, the EUT must comply with the requirements of the following standards:

- ♦ FCC Part 15 Subpart C §15.247
- ♦ FCC KDB Publication No. 558074 D01 DTS Meas. Guidance v03r05
- ♦ ANSI C63.10-2013

Remark:

1. All test items were verified and recorded according to the standards and without any deviation during the test.
2. This EUT has also been tested and complied with the requirements of FCC Part 15, Subpart B, recorded in a separate test report.



2 Test Configuration of Equipment Under Test

2.1 Descriptions of Test Mode

The RF output power was recorded in the following table:

Channel	Frequency	Bluetooth 4.0 – LE RF Output Power	
		Data Rate / Modulation	
		GFSK	
		1Mbps	
Ch00	2402MHz	5.67 dBm	
Ch19	2440MHz	5.77 dBm	
Ch39	2480MHz	5.89 dBm	

- a. The EUT has been associated with peripherals and configuration operated in a manner tended to maximize its emission characteristics in a typical application. Frequency range investigated: conduction (150 kHz to 30 MHz), radiation (9 kHz to the 10th harmonic of the highest fundamental frequency or to 40 GHz, whichever is lower). Pre-scanned tests, X, Y, Z in three orthogonal panels to determine the final configuration (Y plane as worst plane) from all possible combinations.
- b. AC power line Conducted Emission was tested under maximum output power.

2.2 Test Mode

The following summary table is showing all test modes to demonstrate in compliance with the standard.

Summary table of Test Cases	
Test Item	Data Rate / Modulation
	Bluetooth 4.0 – LE / GFSK
Conducted TCs	Mode 1: Bluetooth Tx CH00_2402 MHz_1Mbps
	Mode 2: Bluetooth Tx CH19_2440 MHz_1Mbps
	Mode 3: Bluetooth Tx CH39_2480 MHz_1Mbps
Radiated TCs	Mode 1: Bluetooth Tx CH00_2402 MHz_1Mbps
	Mode 2: Bluetooth Tx CH19_2440 MHz_1Mbps
	Mode 3: Bluetooth Tx CH39_2480 MHz_1Mbps
AC Conducted Emission	Mode 1: BT LE Tx + EUT with Docking + USB Cable (Charging from Adapter)
	Mode 2: WLAN Tx + EUT with Docking + USB Cable (Charging from Adapter)
Remark: The worst case of conducted emission is mode 2; only the test data of it was reported.	

2.3 Connection Diagram of Test System

<Bluetooth 4.0 – LE Tx Mode>

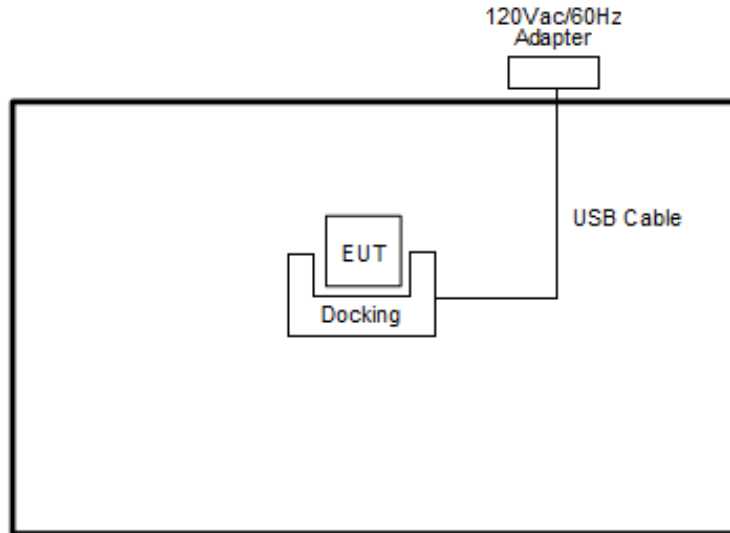

<AC Conducted Emission Mode>

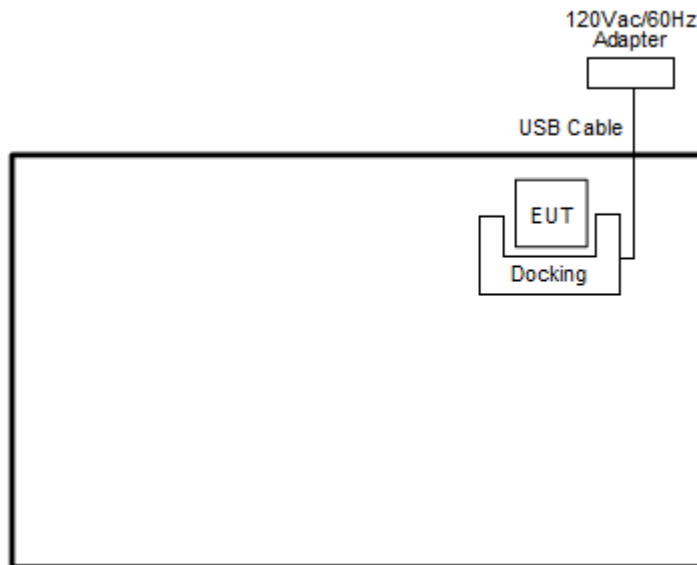

2.4 Support Unit used in test configuration and system

Item	Equipment	Trade Name	Model Name	FCC ID	Data Cable	Power Cord
1.	Docking	Getac	N/A	N/A	N/A	Unshielded, 1.0m
2.	Adapter	TPC	NSS050200B	N/A	N/A	N/A



2.5 EUT Operation Test Setup

For Bluetooth function, the RF utility, "Sample_Project" was installed in EUT which was programmed in order to make the EUT get into the engineering modes to contact with Bluetooth base station for continuous transmitting and receiving signals.



3 Test Result

3.1 Radiated Band Edges and Spurious Emission Measurement

3.1.1 Limit of Radiated Band Edges and Spurious Emission

In any 100 kHz bandwidth outside the intentional radiator frequency band, all harmonics/spurious must be at least 20 dB below the highest emission level within the authorized band. If the output power of this device was measured by spectrum analyzer, the attenuation under this paragraph shall be 30 dB instead of 20 dB. In addition, radiated emissions which fall in the restricted bands must also comply with the FCC section 15.209 limits as below.

Frequency (MHz)	Field Strength (microvolts/meter)	Measurement Distance (meters)
0.009 – 0.490	2400/F(kHz)	300
0.490 – 1.705	24000/F(kHz)	30
1.705 – 30.0	30	30
30 – 88	100	3
88 – 216	150	3
216 - 960	200	3
Above 960	500	3

3.1.2 Measuring Instruments

The section 4.0 of List of Measuring Equipment of this test report is used for test.



3.1.3 Test Procedures

1. The testing follows FCC KDB Publication No. 558074 D01 DTS Meas. Guidance v03r05.
2. The EUT was arranged to its worst case and then tune the antenna tower (from 1 m to 4 m) and turntable (from 0 degree to 360 degrees) to find the maximum reading. A pre-amp and a high pass filter are used for the test in order to get better signal level.
3. The EUT was placed on a turntable with 0.8 meter for frequency below 1GHz and 1.5 meter for frequency above 1GHz respectively above ground.
4. The EUT was set 3 meters from the interference receiving antenna, which was mounted on the top of a variable height antenna tower.
5. Corrected Reading: Antenna Factor + Cable Loss + Read Level - Preamp Factor = Level
6. For measurement below 1GHz, If the emission level of the EUT measured by the peak detector is 3 dB lower than the applicable limit, the peak emission level will be reported. Otherwise, the emission measurement will be repeated using the quasi-peak detector and reported.
7. Use the following spectrum analyzer settings:
 - (1) Span shall wide enough to fully capture the emission being measured;
 - (2) Set RBW=100 kHz for $f < 1$ GHz; VBW \geq RBW; Sweep = auto; Detector function = peak; Trace = max hold;
 - (3) Set RBW = 1 MHz, VBW= 3MHz for $f \geq 1$ GHz for peak measurement.
For average measurement:
 - VBW = 10 Hz, when duty cycle is no less than 98 percent.
 - VBW $\geq 1/T$, when duty cycle is less than 98 percent where T is the minimum transmission duration over which the transmitter is on and is transmitting at its maximum power control level for the tested mode of operation.

3.1.4 Test Setup

For radiated emissions below 30MHz

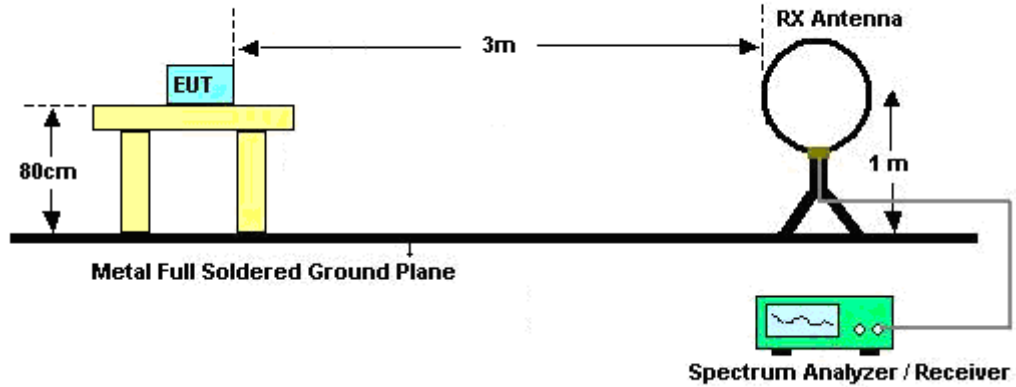

For radiated emissions from 30MHz to 1GHz

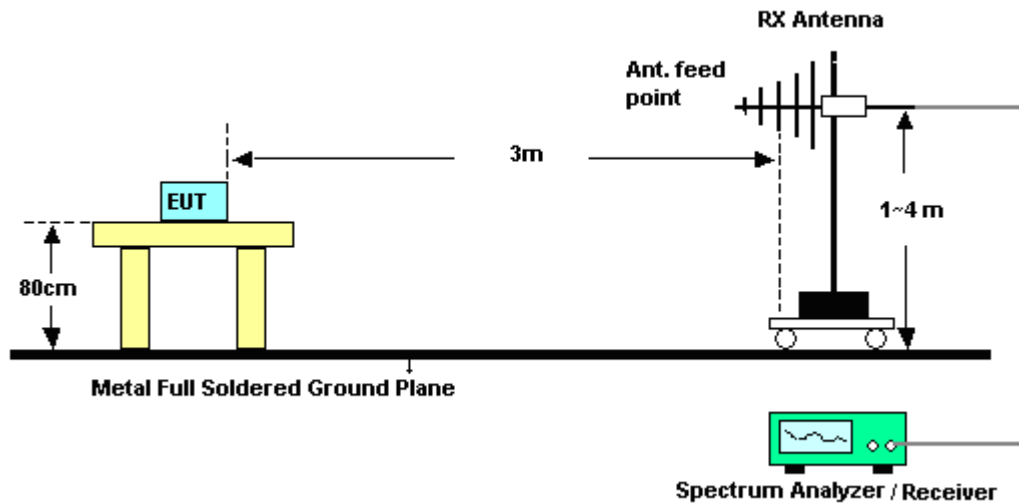

For radiated emissions above 1GHz

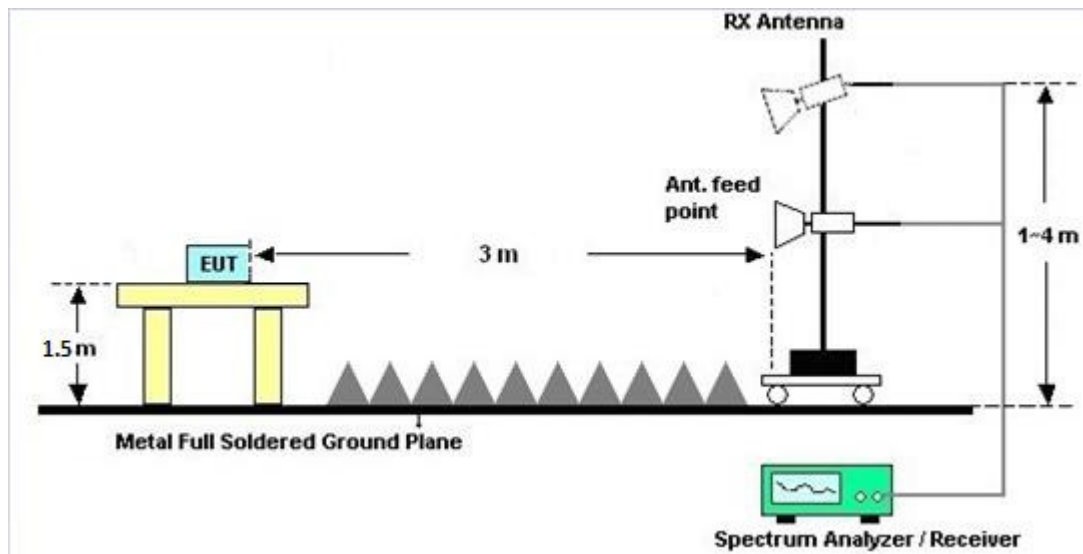

3.1.5 Test Results of Radiated Spurious Emissions (9 kHz ~ 30 MHz)

The low frequency, which started from 9 kHz to 30MHz, was pre-scanned and the result which was 20dB lower than the limit line per 15.31(o) was not reported.

3.1.6 Test Result of Radiated Spurious at Band Edges

Please refer to Appendix A and B

3.1.7 Duty Cycle

Please refer to Appendix C.

3.1.8 Test Result of Radiated Spurious Emission (30MHz ~ 10th Harmonic)

Please refer to Appendix A and B



3.2 AC Conducted Emission Measurement

3.2.1 Limit of AC Conducted Emission

For equipment that is designed to be connected to the public utility (AC) power line, the radio frequency voltage that is conducted back onto the AC power line on any frequency or frequencies within the band 150 kHz to 30 MHz shall not exceed the limits in the following table.

Frequency of emission (MHz)	Conducted limit (dB μ V)	
	Quasi-peak	Average
0.15-0.5	66 to 56*	56 to 46*
0.5-5	56	46
5-30	60	50

*Decreases with the logarithm of the frequency.

3.2.2 Measuring Instruments

The section 4.0 of List of Measuring Equipment of this test report is used for test.

3.2.3 Test Procedures

1. The EUT was placed 0.4 meter from the conducting wall of the shielding room was kept at least 80 centimeters from any other grounded conducting surface.
2. Connect EUT to the power mains through a line impedance stabilization network (LISN).
3. All the support units are connecting to the other LISN.
4. The LISN provides 50 ohm coupling impedance for the measuring instrument.
5. The FCC states that a 50 ohm, 50 microhenry LISN should be used.
6. Both sides of AC line were checked for maximum conducted interference.
7. The frequency range from 150 kHz to 30 MHz was searched.
8. Set the test-receiver system to Peak Detect Function and specified bandwidth (IF Bandwidth = 9kHz) with Maximum Hold Mode. Then measurement is also conducted by Average Detector and Quasi-Peak Detector Function respectively.

3.2.4 Test Setup

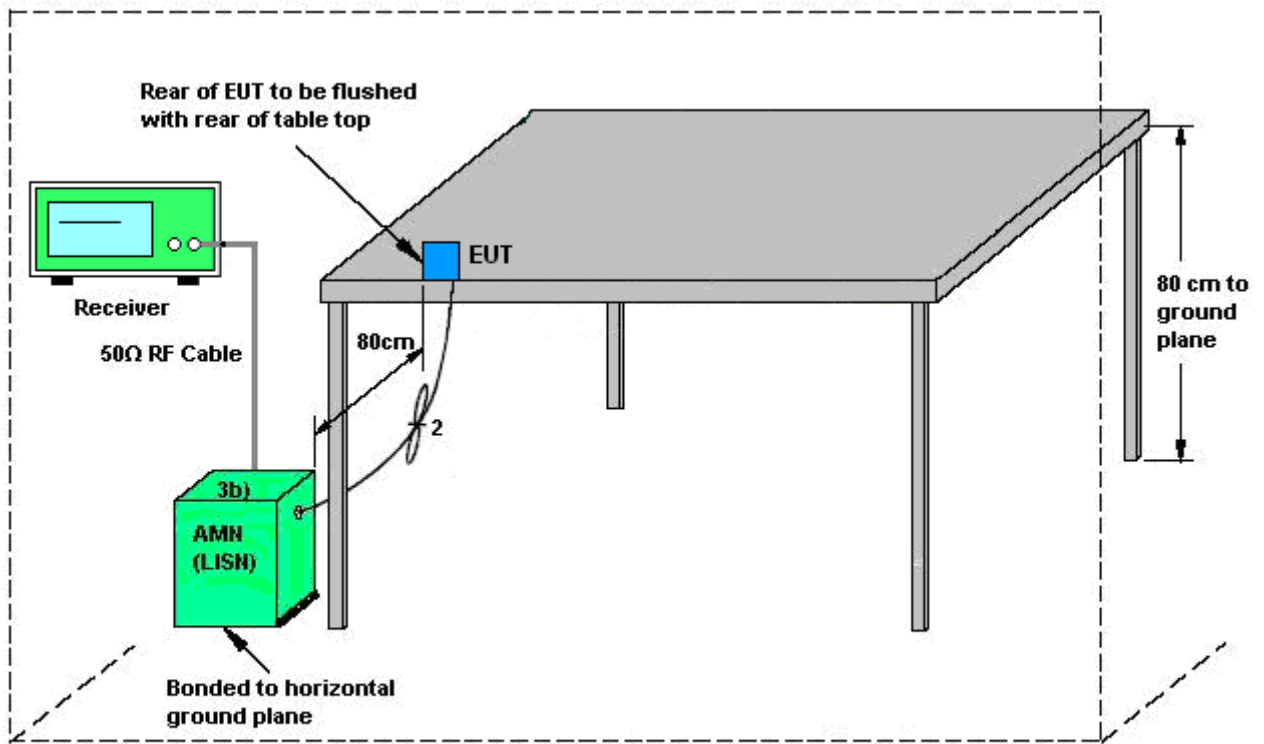

AMN = Artificial mains network (LISN)
AE = Associated equipment
EUT = Equipment under test
ISN = Impedance stabilization network



3.2.5 Test Result of AC Conducted Emission

Test Mode :	Mode 2	Temperature :	22~23°C
Test Engineer :	Arthur Hsieh	Relative Humidity :	51~52%
Test Voltage :	120Vac / 60Hz	Phase :	Line
Function Type :	WLAN Tx + EUT with Docking + USB Cable (Charging from Adapter)		

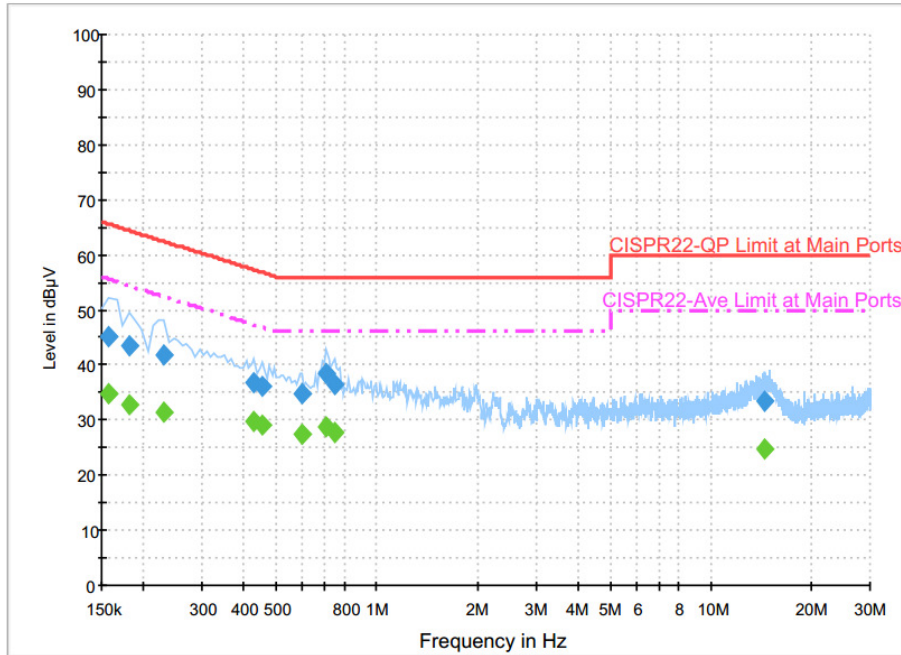

Final Result : Quasi-Peak

Frequency (MHz)	Quasi-Peak (dBµV)	Filter	Line	Corr. (dB)	Margin (dB)	Limit (dBµV)
0.158000	45.1	Off	L1	19.6	20.5	65.6
0.182000	43.5	Off	L1	19.6	20.9	64.4
0.230000	41.7	Off	L1	19.6	20.7	62.4
0.430000	36.6	Off	L1	19.6	20.7	57.3
0.454000	36.1	Off	L1	19.6	20.7	56.8
0.598000	34.7	Off	L1	19.6	21.3	56.0
0.702000	38.5	Off	L1	19.6	17.5	56.0
0.750000	36.6	Off	L1	19.6	19.4	56.0
14.574000	33.3	Off	L1	20.4	26.7	60.0

Final Result : Average

Frequency (MHz)	Average (dBµV)	Filter	Line	Corr. (dB)	Margin (dB)	Limit (dBµV)
0.158000	34.9	Off	L1	19.6	20.7	55.6
0.182000	32.9	Off	L1	19.6	21.5	54.4
0.230000	31.5	Off	L1	19.6	20.9	52.4
0.430000	29.7	Off	L1	19.6	17.6	47.3
0.454000	29.2	Off	L1	19.6	17.6	46.8
0.598000	27.6	Off	L1	19.6	18.4	46.0
0.702000	28.9	Off	L1	19.6	17.1	46.0
0.750000	27.6	Off	L1	19.6	18.4	46.0
14.574000	24.8	Off	L1	20.4	25.2	50.0



Test Mode :	Mode 2	Temperature :	22~23°C
Test Engineer :	Arthur Hsieh	Relative Humidity :	51~52%
Test Voltage :	120Vac / 60Hz	Phase :	Neutral
Function Type :	WLAN Tx + EUT with Docking + USB Cable (Charging from Adapter)		

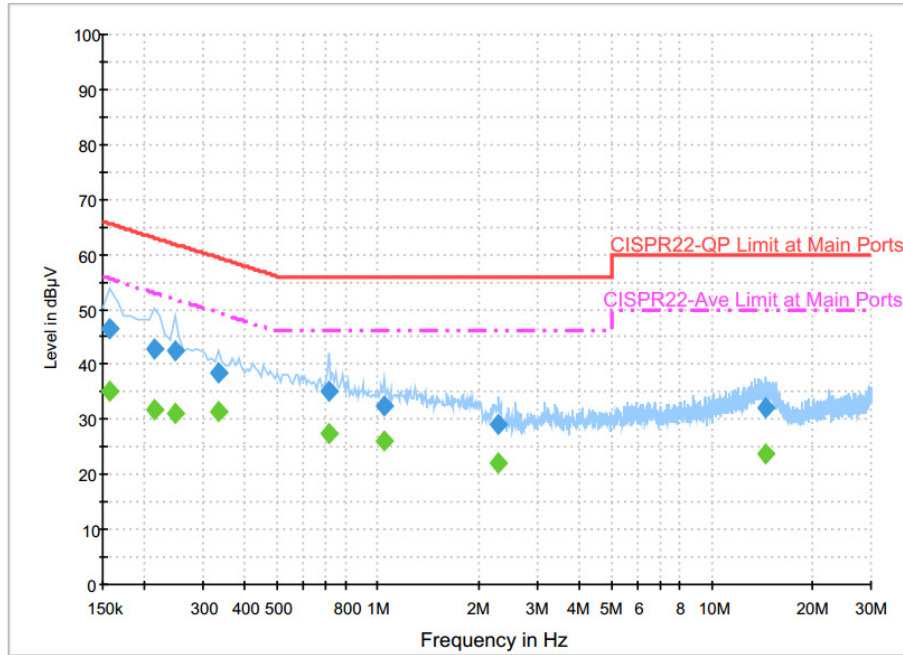

Final Result : Quasi-Peak

Frequency (MHz)	Quasi-Peak (dBµV)	Filter	Line	Corr. (dB)	Margin (dB)	Limit (dBµV)
0.158000	46.6	Off	N	19.6	19.0	65.6
0.214000	42.7	Off	N	19.6	20.3	63.0
0.246000	42.3	Off	N	19.6	19.6	61.9
0.334000	38.4	Off	N	19.6	21.0	59.4
0.710000	35.3	Off	N	19.6	20.7	56.0
1.046000	32.6	Off	N	19.6	23.4	56.0
2.302000	29.1	Off	N	18.6	26.9	56.0
14.582000	32.1	Off	N	20.4	27.9	60.0

Final Result : Average

Frequency (MHz)	Average (dBµV)	Filter	Line	Corr. (dB)	Margin (dB)	Limit (dBµV)
0.158000	35.3	Off	N	19.6	20.3	55.6
0.214000	31.8	Off	N	19.6	21.2	53.0
0.246000	31.2	Off	N	19.6	20.7	51.9
0.334000	31.5	Off	N	19.6	17.9	49.4
0.710000	27.5	Off	N	19.6	18.5	46.0
1.046000	25.9	Off	N	19.6	20.1	46.0
2.302000	22.2	Off	N	18.6	23.8	46.0
14.582000	23.7	Off	N	20.4	26.3	50.0



3.3 Antenna Requirements

3.3.1 Standard Applicable

If directional gain of transmitting antennas is greater than 6dBi, the power shall be reduced by the same level in dB comparing to gain minus 6dBi. The use of a permanently attached antenna or of an antenna that uses a unique coupling to the intentional radiator shall be considered sufficient to comply with the FCC rule.

3.3.2 Antenna Anti-Replacement Construction

An embedded-in antenna design is used.

3.3.3 Antenna Gain

The antenna peak gain of EUT is less than 6 dBi. Therefore, it is not necessary to reduce maximum peak output power limit.



4 List of Measuring Equipment

Instrument	Manufacturer	Model No.	Serial No.	Characteristics	Calibration Date	Test Date	Due Date	Remark
Power Meter	Agilent	E4416A	GB412923 44	300MHz~40GHz	Jan. 08, 2016	Aug. 05, 2016	Jan. 07, 2017	Conducted (TH02-HY)
Power Meter	Anritsu	ML2495A	1036004	300MHz~40GHz	Jul. 28, 2016	Aug. 05, 2016	Jul. 27, 2017	Conducted (TH02-HY)
Power Sensor	Agilent	E9327A	US404415 48	300MHz~40GHz	Jan. 07, 2016	Aug. 05, 2016	Jan. 06, 2017	Conducted (TH02-HY)
Power Sensor	Anritsu	MA2411B	1027253	300MHz~40GHz	Jul. 28, 2016	Aug. 05, 2016	Jul. 27, 2017	Conducted (TH02-HY)
Spectrum Analyzer	Rohde & Schwarz	FSP40	100055	9kHz~40GHz	Jun. 17, 2016	Aug. 05, 2016	Jun. 16, 2017	Conducted (TH02-HY)
AC Power Source	ChainTek	APC-1000W	N/A	N/A	N/A	Aug. 31, 2016	N/A	Conduction (CO05-HY)
LISN	Rohde & Schwarz	ENV216	100080	9kHz~30MHz	Dec. 02, 2015	Aug. 31, 2016	Dec. 01, 2016	Conduction (CO05-HY)
EMI Test Receiver	Keysight	N9038A (MXE)	MY541300 85	20Hz ~ 8.4GHz	Nov. 04, 2015	Aug. 31, 2016	Nov. 03, 2016	Conduction (CO05-HY)
Loop Antenna	Rohde & Schwarz	HFH2-Z2	100315	9 kHz~30 MHz	Sep. 02, 2015	Sep. 07, 2016 ~ Sep. 14, 2016	Sep. 01, 2017	Radiation (03CH10-HY)
Bilog Antenna	TESEQ	CBL 6111D	35413	30MHz~1GHz	Jan. 13, 2016	Sep. 07, 2016 ~ Sep. 14, 2016	Jan. 12, 2017	Radiation (03CH10-HY)
Horn Antenna	SCHWARZBE CK	BBHA 9120 D	9120D-132 5	1GHz ~ 18GHz	Sep. 30, 2015	Sep. 07, 2016 ~ Sep. 14, 2016	Sep. 29, 2016	Radiation (03CH10-HY)
SHF-EHF Horn Antenna	SCHWARZBE CK	BBHA 9170	BBHA9170 576	18GHz ~ 40GHz	Apr. 15, 2016	Sep. 07, 2016 ~ Sep. 14, 2016	Apr. 14, 2017	Radiation (03CH10-HY)
Amplifier	SONOMA	310N	187311	9kHz~1GHz	Nov. 16, 2015	Sep. 07, 2016 ~ Sep. 14, 2016	Nov. 15, 2016	Radiation (03CH10-HY)
Preamplifier	MITEQ	AMF-7D-0010 1800-30-10P	1902246	1GHz~18GHz	Nov. 16, 2015	Sep. 07, 2016 ~ Sep. 14, 2016	Nov. 15, 2016	Radiation (03CH10-HY)
Preamplifier	Keysight	83017A	MY532700 78	1GHz~26.5GHz	Nov. 13, 2015	Sep. 07, 2016 ~ Sep. 14, 2016	Nov. 12, 2016	Radiation (03CH10-HY)
Preamplifier	MITEQ	TTA0204	1872107	2GHz~40GHz	Feb. 15, 2016	Sep. 07, 2016 ~ Sep. 14, 2016	Feb. 14, 2017	Radiation (03CH10-HY)
Spectrum Analyzer	Keysight	N9010A	MY542004 85	10Hz ~ 44GHz	Oct. 15, 2015	Sep. 07, 2016 ~ Sep. 14, 2016	Oct. 14, 2016	Radiation (03CH10-HY)
Antenna Mast	EMEC	AM-BS-4500- B	N/A	1~4m	N/A	Sep. 07, 2016 ~ Sep. 14, 2016	N/A	Radiation (03CH10-HY)
Turn Table	EMEC	TT 2200	N/A	0~360 Degree	N/A	Sep. 07, 2016 ~ Sep. 14, 2016	N/A	Radiation (03CH10-HY)



5 Uncertainty of Evaluation

Uncertainty of Conducted Emission Measurement (150 kHz ~ 30 MHz)

Measuring Uncertainty for a Level of Confidence of 95% ($U = 2Uc(y)$)	2.26
---	------

Uncertainty of Radiated Emission Measurement (30 MHz ~ 1000 MHz)

Measuring Uncertainty for a Level of Confidence of 95% ($U = 2Uc(y)$)	5.6
---	-----

Uncertainty of Radiated Emission Measurement (1 GHz ~ 18 GHz)

Measuring Uncertainty for a Level of Confidence of 95% ($U = 2Uc(y)$)	5.9
---	-----

Uncertainty of Radiated Emission Measurement (18 GHz ~ 40 GHz)

Measuring Uncertainty for a Level of Confidence of 95% ($U = 2Uc(y)$)	5.2
---	-----



Appendix A. Radiated Spurious Emission

Test Engineer :	Kyle Jhuang, Wilson Wu and Tsung Lee	Temperature :	22~24°C
		Relative Humidity :	43~44%

2.4GHz 2400~2483.5MHz

BLE (Band Edge @ 3m)

BLE	Note	Frequency (MHz)	Level (dBµV/m)	Over Limit (dB)	Limit Line (dBµV/m)	Read Level (dBµV)	Antenna Factor (dB/m)	Cable Loss (dB)	Preamp Factor (dB)	Ant Pos (cm)	Table Pos (deg)	Peak Avg. (P/A)	Pol. (H/V)	
BLE CH 00 2402MHz		2382.24	51.51	-22.49	74	52.17	27.19	5.39	33.24	117	6	P	H	
		2388.225	41.91	-12.09	54	42.53	27.23	5.39	33.24	117	6	A	H	
	*	2402	98.58	-	-	99.18	27.23	5.39	33.22	117	6	P	H	
	*	2402	97.71	-	-	98.31	27.23	5.39	33.22	117	6	A	H	
													H	
														H
			2389.905	50.75	-23.25	74	51.35	27.23	5.39	33.22	159	71	P	V
			2389.275	41.8	-12.2	54	42.42	27.23	5.39	33.24	159	71	A	V
	*		2402	97.28	-	-	97.88	27.23	5.39	33.22	159	71	P	V
	*		2402	96.49	-	-	97.09	27.23	5.39	33.22	159	71	A	V
														V
														V
BLE CH 19 2440MHz		2349.06	51.44	-22.56	74	52.26	27.1	5.33	33.25	111	5	P	H	
		2384.06	41.7	-12.3	54	42.36	27.19	5.39	33.24	111	5	A	H	
	*	2440	99.26	-	-	99.68	27.37	5.42	33.21	111	5	P	H	
	*	2440	98.59	-	-	99.01	27.37	5.42	33.21	111	5	A	H	
			2485.93	51.5	-22.5	74	51.76	27.46	5.46	33.18	111	5	P	H
			2485.09	42.15	-11.85	54	42.41	27.46	5.46	33.18	111	5	A	H
			2348.64	51.59	-22.41	74	52.41	27.1	5.33	33.25	390	39	P	V
			2388.82	41.97	-12.03	54	42.59	27.23	5.39	33.24	390	39	A	V
	*		2440	98.45	-	-	98.87	27.37	5.42	33.21	390	39	P	V
	*		2440	97.78	-	-	98.2	27.37	5.42	33.21	390	39	A	V
			2487.26	50.82	-23.18	74	51.08	27.46	5.46	33.18	390	39	P	V
			2488.17	42.19	-11.81	54	42.41	27.5	5.46	33.18	390	39	A	V



BLE CH 39 2480MHz	*	2480	99.93	-	-	100.21	27.46	5.44	33.18	130	7	P	H
	*	2480	98.42	-	-	98.7	27.46	5.44	33.18	130	7	A	H
		2486.04	52.33	-21.67	74	52.59	27.46	5.46	33.18	130	7	P	H
		2484.04	42.21	-11.79	54	42.47	27.46	5.46	33.18	130	7	A	H
													H
													H
	*	2480	98.66	-	-	98.94	27.46	5.44	33.18	235	67	P	V
	*	2480	98.09	-	-	98.37	27.46	5.44	33.18	235	67	A	V
		2499.72	51.46	-22.54	74	51.67	27.5	5.46	33.17	235	67	P	V
		2486.2	42.13	-11.87	54	42.39	27.46	5.46	33.18	235	67	A	V
													V
													V
Remark	<ol style="list-style-type: none"> 1. No other spurious found. 2. All results are PASS against Peak and Average limit line. 												



2.4GHz 2400~2483.5MHz

BLE (Harmonic @ 3m)

BLE	Note	Frequency (MHz)	Level (dBμV/m)	Over Limit (dB)	Limit Line (dBμV/m)	Read Level (dBμV)	Antenna Factor (dB/m)	Cable Loss (dB)	Preamp Factor (dB)	Ant Pos (cm)	Table Pos (deg)	Peak Avg. (P/A)	Pol. (H/V)	
BLE CH 00 2402MHz		4804	50.11	-23.89	74	43.7	31.42	7.58	32.59	100	0	P	H	
													H	
													H	
													H	
			4804	48.86	-25.14	74	42.45	31.42	7.58	32.59	100	0	P	V
														V
														V
BLE CH 19 2440MHz		4880	53.64	-20.36	74	46.96	31.56	7.7	32.58	219	88	P	H	
		4880	50.33	-3.67	54	43.65	31.56	7.7	32.58	219	88	A	H	
		7320	50.72	-23.28	74	38.51	36.22	9.49	33.5	100	0	P	H	
														H
			4880	50.94	-23.06	74	44.26	31.56	7.7	32.58	100	0	P	V
			7320	50.58	-23.42	74	38.37	36.22	9.49	33.5	100	0	P	V
														V
BLE CH 39 2480MHz		4960	54.51	-19.49	74	47.43	31.73	7.93	32.58	100	188	P	H	
		4960	51.21	-2.79	54	44.13	31.73	7.93	32.58	100	188	A	H	
		7440	50.4	-23.6	74	37.86	36.49	9.61	33.56	100	0	P	H	
														H
			4960	52.26	-21.74	74	45.18	31.73	7.93	32.58	121	56	P	V
			4960	48.77	-5.23	54	41.69	31.73	7.93	32.58	121	56	A	V
			7440	50.88	-23.12	74	38.34	36.49	9.61	33.56	100	0	P	V
													V	
Remark	1. No other spurious found. 2. All results are PASS against Peak and Average limit line.													



Note symbol

*	Fundamental Frequency which can be ignored. However, the level of any unwanted emissions shall not exceed the level of the fundamental frequency.
!	Test result is over limit line.
P/A	Peak or Average
H/V	Horizontal or Vertical



A calculation example for radiated spurious emission is shown as below:

WIFI	Note	Frequency	Level	Over	Limit	Read	Antenna	Cable	Preamp	Ant	Table	Peak	Pol.
Ant.				Limit	Line	Level	Factor	Loss	Factor	Pos	Pos	Avg.	
1+2		(MHz)	(dBμV/m)	(dB)	(dBμV/m)	(dBμV)	(dB/m)	(dB)	(dB)	(cm)	(deg)	(P/A)	(H/V)
802.11b		2390	55.45	-18.55	74	54.51	32.22	4.58	35.86	103	308	P	H
CH 01													
2412MHz		2390	43.54	-10.46	54	42.6	32.22	4.58	35.86	103	308	A	H

- Level(dBμV/m) =
Antenna Factor(dB/m) + Cable Loss(dB) + Read Level(dBμV) - Preamp Factor(dB)
- Over Limit(dB) = Level(dBμV/m) – Limit Line(dBμV/m)

For Peak Limit @ 2390MHz:

- Level(dBμV/m)
= Antenna Factor(dB/m) + Cable Loss(dB) + Read Level(dBμV) - Preamp Factor(dB)
= 32.22(dB/m) + 4.58(dB) + 54.51(dBμV) – 35.86 (dB)
= 55.45 (dBμV/m)
- Over Limit(dB)
= Level(dBμV/m) – Limit Line(dBμV/m)
= 55.45(dBμV/m) – 74(dBμV/m)
= -18.55(dB)

For Average Limit @ 2390MHz:

- Level(dBμV/m)
= Antenna Factor(dB/m) + Cable Loss(dB) + Read Level(dBμV) - Preamp Factor(dB)
= 32.22(dB/m) + 4.58(dB) + 42.6(dBμV) – 35.86 (dB)
= 43.54 (dBμV/m)
- Over Limit(dB)
= Level(dBμV/m) – Limit Line(dBμV/m)
= 43.54(dBμV/m) – 54(dBμV/m)
= -10.46(dB)

Both peak and average measured complies with the limit line, so test result is “PASS”.



Appendix B. Radiated Spurious Emission

Test Engineer :	Kyle Jhuang, Wilson Wu and Tsung Lee	Temperature :	22~24°C
		Relative Humidity :	43~44%

Note symbol

-L	Low channel location
-R	High channel location



2.4GHz 2400~2483.5MHz

BLE (Band Edge @ 3m)

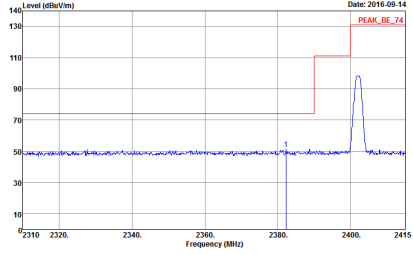
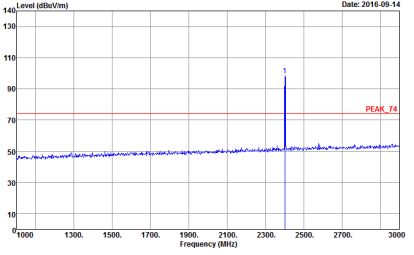
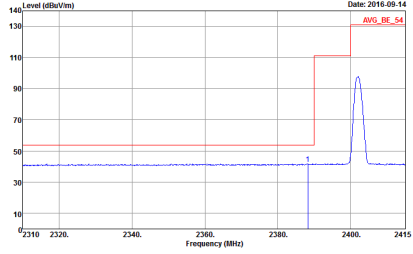
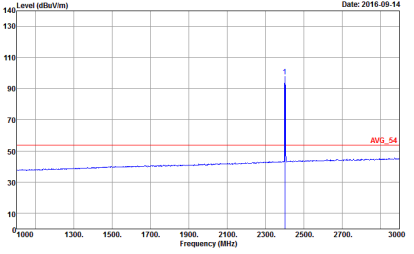
BLE	2.4GHz 2400~2483.5MHz Band Edge @ 3m	
ANT	BLE CH00 2402MHz	
1	Horizontal	Fundamental
Peak	 <p>Site : 03CH10-HY Condition : PEAK_BE_74 3m HORN 9120D-HF HORIZONTAL RBW:1000.000KHz VBW:3000.000KHz SWT:Auto Detector : Peak Project : 660109-02 Mode : 5 EUT : #11</p>	 <p>Site : 03CH10-HY Condition : PEAK_74 3m HORN 9120D-HF HORIZONTAL RBW:1000.000KHz VBW:3000.000KHz SWT:Auto Detector : Peak Project : 660109-02 Mode : 5 EUT : #11</p>
Avg.	 <p>Site : 03CH10-HY Condition : AVG_BE_54 3m HORN 9120D-HF HORIZONTAL RBW:1000.000KHz VBW:3.000KHz SWT:Auto Detector : Peak Project : 660109-02 Mode : 5 EUT : #11</p>	 <p>Site : 03CH10-HY Condition : AVG_54 3m HORN 9120D-HF HORIZONTAL RBW:1000.000KHz VBW:3.000KHz SWT:Auto Detector : Peak Project : 660109-02 Mode : 5 EUT : #11</p>

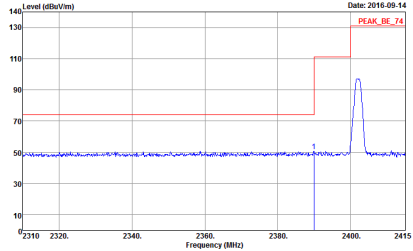
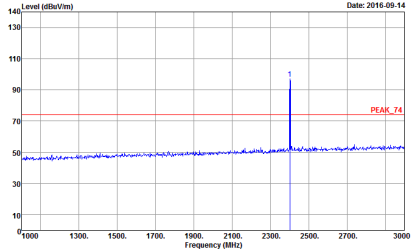
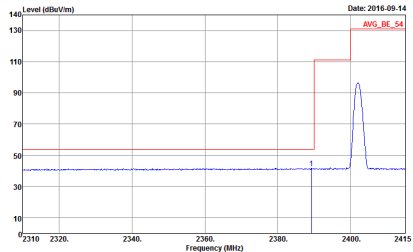
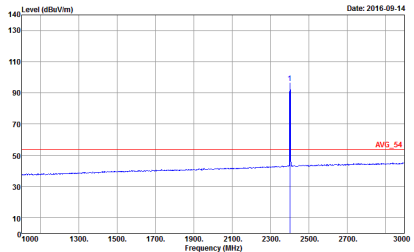

BLE	2.4GHz 2400~2483.5MHz Band Edge @ 3m	
ANT	BLE CH00 2402MHz	
1	Vertical	Fundamental
Peak	 <p>Level (dBuV/m) vs Frequency (MHz) plot showing a peak at 2402 MHz. The y-axis ranges from 10 to 140 dBuV/m, and the x-axis ranges from 2310 to 2415 MHz. A red line indicates the peak level at approximately 110 dBuV/m.</p> <p>Site : 03CH10-HY Condition : PEAK_BE_74 3m HORN 9120D-HF VERTICAL RBW:1000.000KHz VBW:3000.000KHz SWT:Auto Detector : Peak Project : 660109-02 Mode : 5 EUT : #11</p>	 <p>Level (dBuV/m) vs Frequency (MHz) plot showing a peak at 2402 MHz. The y-axis ranges from 10 to 140 dBuV/m, and the x-axis ranges from 1000 to 3000 MHz. A red line indicates the peak level at approximately 75 dBuV/m.</p> <p>Site : 03CH10-HY Condition : PEAK_74 3m HORN 9120D-HF VERTICAL RBW:1000.000KHz VBW:3000.000KHz SWT:Auto Detector : Peak Project : 660109-02 Mode : 5 EUT : #11</p>
Avg	 <p>Level (dBuV/m) vs Frequency (MHz) plot showing an average level at 2402 MHz. The y-axis ranges from 10 to 140 dBuV/m, and the x-axis ranges from 2310 to 2415 MHz. A red line indicates the average level at approximately 110 dBuV/m.</p> <p>Site : 03CH10-HY Condition : AVG_BE_54 3m HORN 9120D-HF VERTICAL RBW:1000.000KHz VBW:3.000KHz SWT:Auto Detector : Peak Project : 660109-02 Mode : 5 EUT : #11</p>	 <p>Level (dBuV/m) vs Frequency (MHz) plot showing an average level at 2402 MHz. The y-axis ranges from 10 to 140 dBuV/m, and the x-axis ranges from 1000 to 3000 MHz. A red line indicates the average level at approximately 55 dBuV/m.</p> <p>Site : 03CH10-HY Condition : AVG_54 3m HORN 9120D-HF VERTICAL RBW:1000.000KHz VBW:3.000KHz SWT:Auto Detector : Peak Project : 660109-02 Mode : 5 EUT : #11</p>

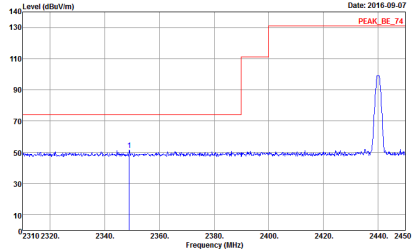
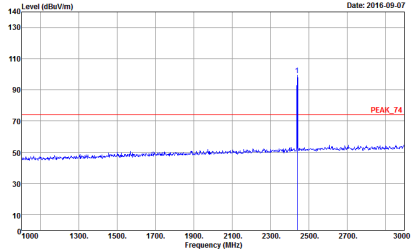
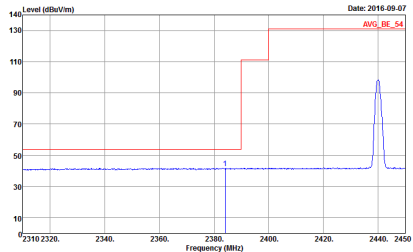
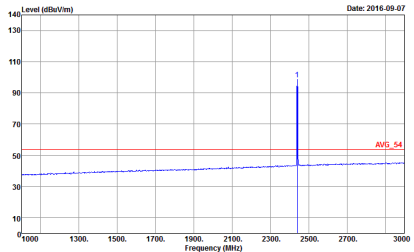

BLE	2.4GHz 2400~2483.5MHz Band Edge @ 3m	
ANT	BLE CH19 2440MHz - L	
1	Horizontal	Fundamental
Peak	 <p>Date: 2016-09-07 PEAK_BE_74</p> <p>Site : 03CH10-HY Condition : PEAK_BE_74 3m HORN 9120D-HF HORIZONTAL RBW:1000.000KHz VBW:3000.000KHz SWT:Auto Detector : Peak Project : 660109-02 Mode : 1 EUT : #11</p>	 <p>Date: 2016-09-07 PEAK_74</p> <p>Site : 03CH10-HY Condition : PEAK_74 3m HORN 9120D-HF HORIZONTAL RBW:1000.000KHz VBW:3000.000KHz SWT:Auto Detector : Peak Project : 660109-02 Mode : 1 EUT : #11</p>
Avg.	 <p>Date: 2016-09-07 AVG_BE_54</p> <p>Site : 03CH10-HY Condition : AVG_BE_54 3m HORN 9120D-HF HORIZONTAL RBW:1000.000KHz VBW:3.000KHz SWT:Auto Detector : Peak Project : 660109-02 Mode : 1 EUT : #11</p>	 <p>Date: 2016-09-07 AVG_54</p> <p>Site : 03CH10-HY Condition : AVG_54 3m HORN 9120D-HF HORIZONTAL RBW:1000.000KHz VBW:3.000KHz SWT:Auto Detector : Peak Project : 660109-02 Mode : 1 EUT : #11</p>

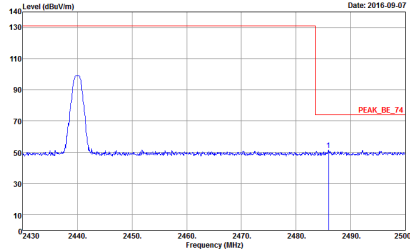
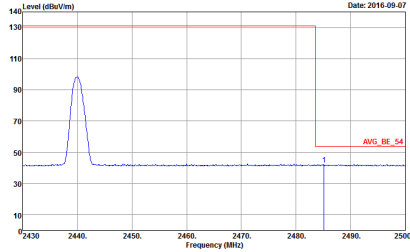

BLE	2.4GHz 2400~2483.5MHz Band Edge @ 3m	
ANT	BLE CH19 2440MHz - R	
1	Horizontal	Fundamental
<p>Peak</p>	 <p>Site : 03CH10-HY Condition : PEAK_BE_74 3m HORN 9120D-HF HORIZONTAL RBW:1000.000KHz VBW:3000.000KHz SWT:Auto Detector : Peak Project : 660109-02 Mode : 1 EUT : #11</p>	<p>Left blank</p>
<p>Avg.</p>	 <p>Site : 03CH10-HY Condition : AVG_BE_54 3m HORN 9120D-HF HORIZONTAL RBW:1000.000KHz VBW:3000.000KHz SWT:Auto Detector : Peak Project : 660109-02 Mode : 1 EUT : #11</p>	<p>Left blank</p>

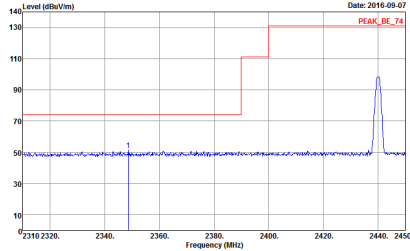
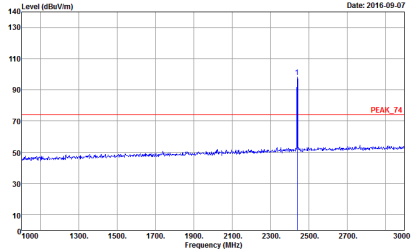
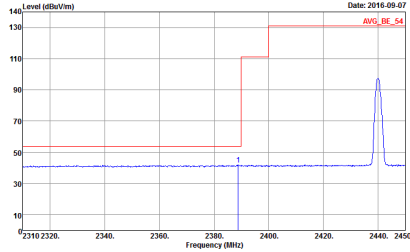
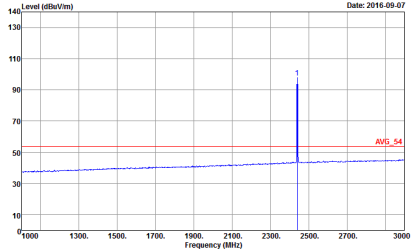

BLE	2.4GHz 2400~2483.5MHz Band Edge @ 3m	
ANT	BLE CH19 2440MHz - L	
1	Vertical	Fundamental
Peak	 <p>Site : 03CH10-HY Condition : PEAK_BE_74 3m HORN 9120D-HF VERTICAL RBW:1000.000KHz VBW:3000.000KHz SWT:Auto Detector : Peak Project : 660109-02 Mode : 1 EUT : #11</p>	 <p>Site : 03CH10-HY Condition : PEAK_74 3m HORN 9120D-HF VERTICAL RBW:1000.000KHz VBW:3000.000KHz SWT:Auto Detector : Peak Project : 660109-02 Mode : 1 EUT : #11</p>
Avg.	 <p>Site : 03CH10-HY Condition : AVG_BE_54 3m HORN 9120D-HF VERTICAL RBW:1000.000KHz VBW:3.000KHz SWT:Auto Detector : Peak Project : 660109-02 Mode : 1 EUT : #11</p>	 <p>Site : 03CH10-HY Condition : AVG_54 3m HORN 9120D-HF VERTICAL RBW:1000.000KHz VBW:3.000KHz SWT:Auto Detector : Peak Project : 660109-02 Mode : 1 EUT : #11</p>

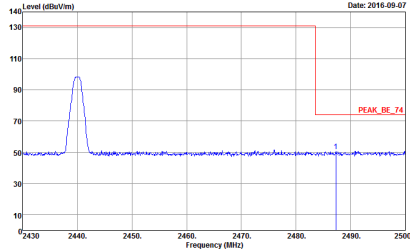
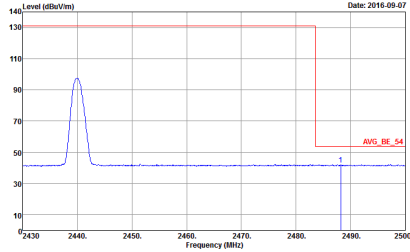

BLE	2.4GHz 2400~2483.5MHz Band Edge @ 3m	
ANT	BLE CH19 2440MHz - R	
1	Vertical	Fundamental
Peak	 <p>Date: 2016-09-07</p> <p>Site : 03CH10-HY Condition : PEAK_BE_74 3m HORN 9120D-HF VERTICAL RBW:1000.000KHz VBW:3000.000KHz SWT:Auto Detector : Peak Project : 660109-02 Mode : 1 EUT : #11</p>	Left blank
Avg.	 <p>Date: 2016-09-07</p> <p>Site : 03CH10-HY Condition : AVG_BE_54 3m HORN 9120D-HF VERTICAL RBW:1000.000KHz VBW:3.000KHz SWT:Auto Detector : Peak Project : 660109-02 Mode : 1 EUT : #11</p>	Left blank

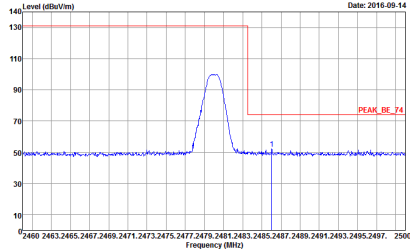
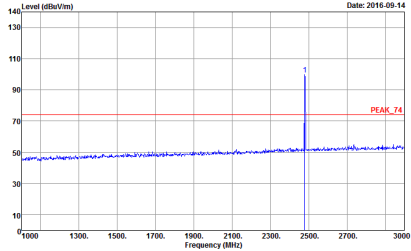
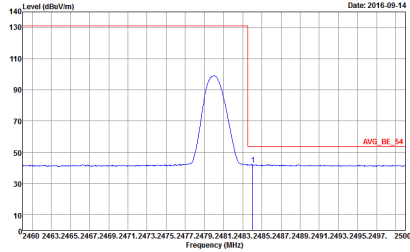
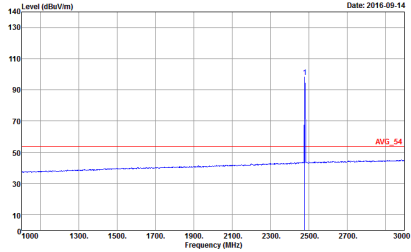

BLE	2.4GHz 2400~2483.5MHz Band Edge @ 3m	
ANT	BLE CH39 2480MHz	
1	Horizontal	Fundamental
Peak	 <p>Site : 03CH10-11Y Condition : PEAK_BE_74 3m HORN 9120D-1HF HORIZONTAL RBW:1000.000KHz VBW:3000.000KHz SWT:Auto Detector : Peak Project : 660109-02 Mode : 6 EUT : #11</p>	 <p>Site : 03CH10-11Y Condition : PEAK_74 3m HORN 9120D-1HF HORIZONTAL RBW:1000.000KHz VBW:3000.000KHz SWT:Auto Detector : Peak Project : 660109-02 Mode : 6 EUT : #11</p>
Avg.	 <p>Site : 03CH10-11Y Condition : AVG_BE_54 3m HORN 9120D-1HF HORIZONTAL RBW:1000.000KHz VBW:3000.000KHz SWT:Auto Detector : Peak Project : 660109-02 Mode : 6 EUT : #11</p>	 <p>Site : 03CH10-11Y Condition : AVG_54 3m HORN 9120D-1HF HORIZONTAL RBW:1000.000KHz VBW:3000.000KHz SWT:Auto Detector : Peak Project : 660109-02 Mode : 6 EUT : #11</p>

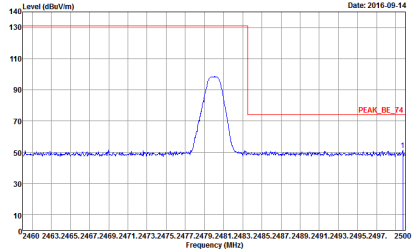
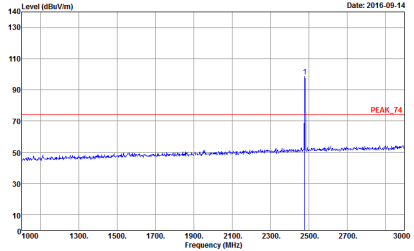
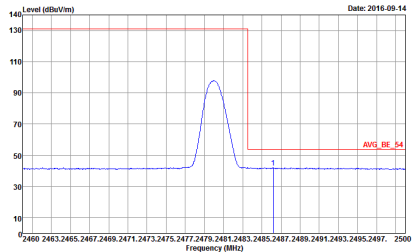
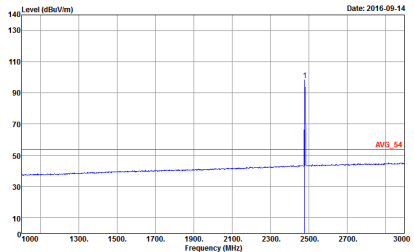

BLE	2.4GHz 2400~2483.5MHz Band Edge @ 3m	
ANT	BLE CH39 2480MHz	
1	Vertical	Fundamental
Peak	 <p>Site : 03CH10-HY Condition : PEAK_BE_74 3m HORN 9120D-HF VERTICAL RBW:1000.000KHz VBW:3000.000KHz SWT:Auto Detector : Peak Project : 660109-02 Mode : 6 EUT : #11</p>	 <p>Site : 03CH10-HY Condition : PEAK_74 3m HORN 9120D-HF VERTICAL RBW:1000.000KHz VBW:3000.000KHz SWT:Auto Detector : Peak Project : 660109-02 Mode : 6 EUT : #11</p>
Avg.	 <p>Site : 03CH10-HY Condition : AVG_BE_54 3m HORN 9120D-HF VERTICAL RBW:1000.000KHz VBW:3.000KHz SWT:Auto Detector : Peak Project : 660109-02 Mode : 6 EUT : #11</p>	 <p>Site : 03CH10-HY Condition : AVG_54 3m HORN 9120D-HF VERTICAL RBW:1000.000KHz VBW:3.000KHz SWT:Auto Detector : Peak Project : 660109-02 Mode : 6 EUT : #11</p>



2.4GHz 2400~2483.5MHz

BLE (Harmonic @ 3m)

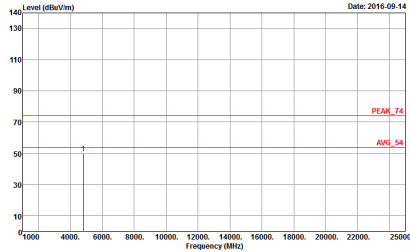
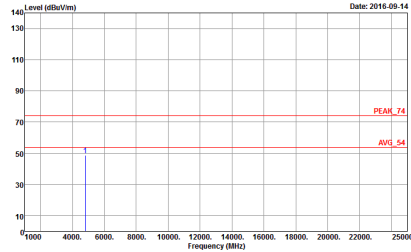
BLE	2.4GHz 2400~2483.5MHz Harmonic @ 3m	
ANT	BLE CH00 2402MHz	
1	Horizontal	Vertical
<p>Peak Avg.</p>	 <p>Site : 03CH10-#Y Condition : PEAK_74 3m HORN_9170_406_0584 HORIZONTAL Detector : Peak Project : 660109-02 Mode : 5 EUT : #11</p>	 <p>Site : 03CH10-#Y Condition : PEAK_74 3m HORN_9170_406_0584 VERTICAL Detector : Peak Project : 660109-02 Mode : 5 EUT : #11</p>

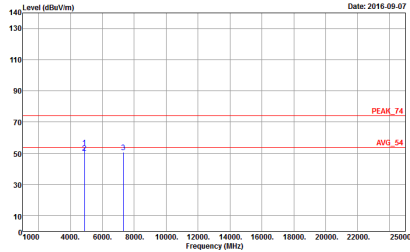
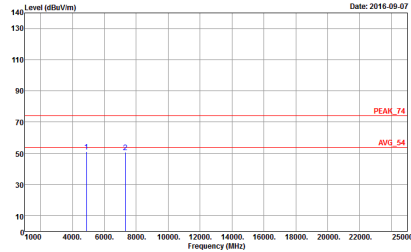

BLE	2.4GHz 2400~2483.5MHz Harmonic @ 3m	
ANT	BLE CH19 2440MHz	
1	Horizontal	Vertical
<p>Peak</p> <p>Avg.</p>	 <p>Site : 03CH10-#Y Condition : PEAK_74 3m HORN_9170_406_0584 HORIZONTAL Detector : Peak Project : 660109-02 Mode : 1 EUT : #11</p>	 <p>Site : 03CH10-#Y Condition : PEAK_74 3m HORN_9170_406_0584 VERTICAL Detector : Peak Project : 660109-02 Mode : 1 EUT : #11</p>



BLE	2.4GHz 2400~2483.5MHz Harmonic @ 3m	
ANT	BLE CH39 2480MHz	
1	Horizontal	Vertical
Peak	<p>Site : 03CH10-#Y Condition : PEAK_74 3m HORN_9170_406_0584 HORIZONTAL Detector : Peak Project : 660109-02 Mode : 6 EUT : #11</p>	<p>Site : 03CH10-#Y Condition : PEAK_74 3m HORN_9170_406_0584 VERTICAL Detector : Peak Project : 660109-02 Mode : 6 EUT : #11</p>



Emission below 1GHz

2.4GHz BLE (LF)

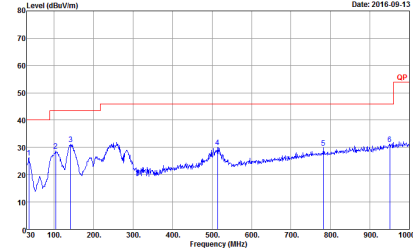
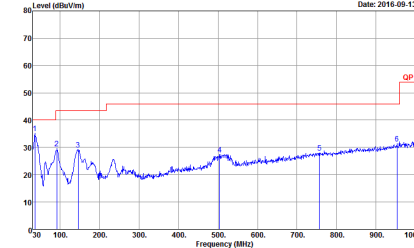
BLE	2.4GHz 2400~2483.5MHz	
ANT	BLE LF	
1	Horizontal	Vertical
<p>QP / Peak</p>	 <p>Site : 03CH10-HY Condition : QP 3m BI-LO6 6111D-LF HORIZONTAL Detector : Peak Project : 660109-02 Mode : 2 EUT : #11</p>	 <p>Site : 03CH10-HY Condition : QP 3m BI-LO6 6111D-LF VERTICAL Detector : Peak Project : 660109-02 Mode : 2 EUT : #11</p>



Appendix C. Duty Cycle Plots

Band	Duty Cycle(%)	T(us)	1/T(kHz)	VBW Setting
Bluetooth 4.0 – LE	61.66	386.00	2.59	3kHz

Bluetooth 4.0 – LE

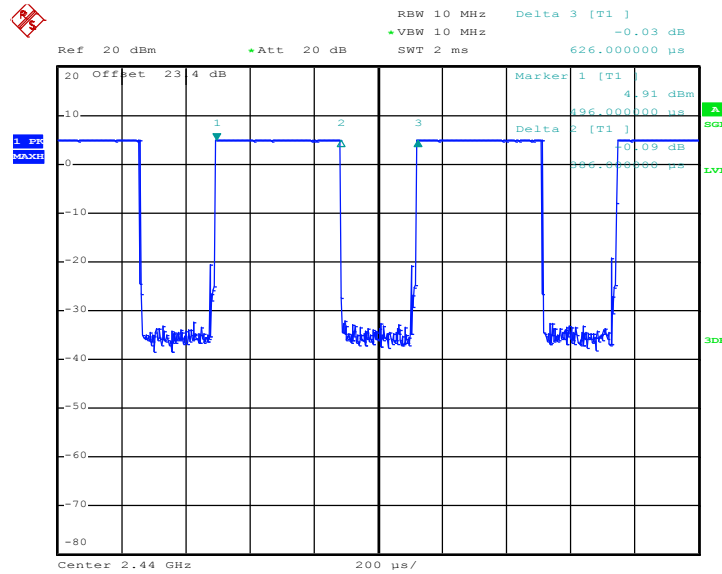

Date: 5.AUG.2016 02:23:52



Appendix E. Original Report

Please refer to Sporton report number FR660109A as below.



FCC RF Test Report

APPLICANT : Getac Technology Corporation.
EQUIPMENT : Body Worn Camera
BRAND NAME : Getac
MODEL NAME : Veretos BC-02
FCC ID : QYLBWC2
STANDARD : FCC Part 15 Subpart C §15.247
CLASSIFICATION : (DTS) Digital Transmission System

The product was received on May 17, 2016 and testing was completed on Jul. 05, 2016. We, SPORTON INTERNATIONAL INC., would like to declare that the tested sample has been evaluated in accordance with the test procedures and has been in compliance with the applicable technical standards.

The test results in this report apply exclusively to the tested model / sample. Without written approval of SPORTON INTERNATIONAL INC., the test report shall not be reproduced except in full.

Reviewed by: Joseph Lin / Supervisor

Approved by: Jones Tsai / Manager



SPORTON INTERNATIONAL INC.

No. 52, Hwa Ya 1st Rd., Hwa Ya Technology Park, Kwei-Shan District, Tao Yuan City, Taiwan, R.O.C.

SPORTON INTERNATIONAL INC.

TEL : 886-3-327-3456

FAX : 886-3-328-4978

FCC ID : QYLBWC2

Page Number : 1 of 36

Report Issued Date : Aug. 25, 2016

Report Version : Rev. 02

Report Template No.: BU5-FR15CBT4.0 Version 1.3



TABLE OF CONTENTS

REVISION HISTORY..... 3

SUMMARY OF TEST RESULT 4

1 GENERAL DESCRIPTION..... 5

 1.1 Applicant 5

 1.2 Manufacturer..... 5

 1.3 Product Feature of Equipment Under Test..... 5

 1.4 Product Specification of Equipment Under Test..... 5

 1.5 Modification of EUT 5

 1.6 Testing Location 6

 1.7 Applicable Standards..... 6

2 TEST CONFIGURATION OF EQUIPMENT UNDER TEST..... 7

 2.1 Descriptions of Test Mode 7

 2.2 Test Mode..... 7

 2.3 Connection Diagram of Test System..... 8

 2.4 Support Unit used in test configuration and system 8

 2.5 EUT Operation Test Setup 9

 2.6 Measurement Results Explanation Example..... 9

3 TEST RESULT 10

 3.1 6dB and 99% Bandwidth Measurement 10

 3.2 Peak Output Power Measurement 15

 3.3 Power Spectral Density Measurement 16

 3.4 Conducted Band Edges and Spurious Emission Measurement 21

 3.5 Radiated Band Edges and Spurious Emission Measurement 26

 3.6 AC Conducted Emission Measurement..... 30

 3.7 Antenna Requirements 34

4 LIST OF MEASURING EQUIPMENT..... 35

5 UNCERTAINTY OF EVALUATION..... 36

APPENDIX A. CONDUCTED TEST RESULTS

APPENDIX B. RADIATED SPURIOUS EMISSION

APPENDIX C. RADIATED SPURIOUS EMISSION PLOTS

APPENDIX D. DUTY CYCLE PLOTS

APPENDIX E. SETUP PHOTOGRAPHS



REVISION HISTORY

REPORT NO.	VERSION	DESCRIPTION	ISSUED DATE
FR660109A	Rev. 01	Initial issue of report	Aug. 10, 2016
FR660109A	Rev. 02	Revising Antenna type	Aug. 25, 2016



SUMMARY OF TEST RESULT

Report Section	FCC Rule	Description	Limit	Result	Remark
3.1	15.247(a)(2)	6dB Bandwidth	$\geq 0.5\text{MHz}$	Pass	-
3.1	-	99% Bandwidth	-	Pass	-
3.2	15.247(b)(1)	Peak Output Power	$\leq 30\text{dBm}$	Pass	-
3.3	15.247(e)	Power Spectral Density	$\leq 8\text{dBm}/3\text{kHz}$	Pass	-
3.4	15.247(d)	Conducted Band Edges and Spurious Emission	$\leq 20\text{dBc}$	Pass	-
3.5	15.247(d)	Radiated Band Edges and Spurious Emission	15.209(a) & 15.247(d)	Pass	Under limit 11.33 dB at 65.910 MHz
3.6	15.207	AC Conducted Emission	15.207(a)	Pass	Under limit 19.90 dB at 0.158 MHz
3.7	15.203 & 15.247(b)	Antenna Requirement	N/A	Pass	-



1 General Description

1.1 Applicant

Getac Technology Corporation.

5F., Building A, No. 209, Sec.1, Nangang Rd.,Nangang Dist., Taipei City 11568, Taiwan, R.O.C.

1.2 Manufacturer

Ability Enterprise Co., Ltd.

4F., No.8, Lane7, Wuchiuan Rd, Wugu Dist., New Taipei City 24886, Taiwan, R.O.C.

1.3 Product Feature of Equipment Under Test

Product Feature	
Equipment	Body Worn Camera
Brand Name	Getac
Model Name	Veretos BC-02
FCC ID	QYLBWC2
EUT supports Radios application	WLAN 11b/g/n HT20 Bluetooth v4.0 LE
EUT Stage	Production Unit

Remark: The above EUT's information was declared by manufacturer. Please refer to the specifications or user's manual for more detailed description.

1.4 Product Specification of Equipment Under Test

Standards-related Product Specification	
Tx/Rx Frequency Range	2402 MHz ~ 2480 MHz
Number of Channels	40
Carrier Frequency of Each Channel	40 Channel(37 hopping + 3 advertising channel)
Maximum Output Power to Antenna	6.25 dBm (0.0042 W)
99% Occupied Bandwidth	1.05MHz
Antenna Type	PIFA Antenna type with gain 0.88 dBi
Type of Modulation	GFSK

1.5 Modification of EUT

No modifications are made to the EUT during all test items.



1.6 Testing Location

Sporton Lab is accredited to ISO 17025 by Taiwan Accreditation Foundation (TAF code : 1190) and the FCC designation No. TW1022 under the FCC 2.948(e) by Mutual Recognition Agreement (MRA) in FCC Test.

Test Site	SPORTON INTERNATIONAL INC.	
Test Site Location	No. 52, Hwa Ya 1 st Rd., Hwa Ya Technology Park, Kwei-Shan District, Tao Yuan City, Taiwan, R.O.C. TEL: +886-3-327-3456 FAX: +886-3-328-4978	
Test Site No.	Sporton Site No.	
	TH02-HY	CO05-HY

Note: The test site complies with ANSI C63.4 2014 requirement.

Test Site	SPORTON INTERNATIONAL INC.	
Test Site Location	No.58, Aly. 75, Ln. 564, Wenhua 3rd Rd. Guishan Dist, Taoyuan City, Taiwan (R.O.C.) TEL: +886-3-327-0868 FAX: +886-3-327-0855	
Test Site No.	Sporton Site No.	
	03CH10-HY	

Note: The test site complies with ANSI C63.4 2014 requirement.

1.7 Applicable Standards

According to the specifications of the manufacturer, the EUT must comply with the requirements of the following standards:

- ♦ FCC Part 15 Subpart C §15.247
- ♦ FCC KDB Publication No. 558074 D01 DTS Meas. Guidance v03r05
- ♦ ANSI C63.10-2013

Remark:

1. All test items were verified and recorded according to the standards and without any deviation during the test.
2. This EUT has also been tested and complied with the requirements of FCC Part 15, Subpart B, recorded in a separate test report.



2 Test Configuration of Equipment Under Test

2.1 Descriptions of Test Mode

The RF output power was recorded in the following table:

Channel	Frequency	Bluetooth 4.0 – LE RF Output Power	
		Data Rate / Modulation	
		GFSK	
		1Mbps	
Ch00	2402MHz	5.66 dBm	
Ch19	2440MHz	6.08 dBm	
Ch39	2480MHz	6.25 dBm	

- a. The EUT has been associated with peripherals and configuration operated in a manner tended to maximize its emission characteristics in a typical application. Frequency range investigated: conduction (150 kHz to 30 MHz), radiation (9 kHz to the 10th harmonic of the highest fundamental frequency or to 40 GHz, whichever is lower). Pre-scanned tests, X, Y, Z in three orthogonal panels to determine the final configuration (Y plane as worst plane) from all possible combinations.
- b. AC power line Conducted Emission was tested under maximum output power.

2.2 Test Mode

The following summary table is showing all test modes to demonstrate in compliance with the standard.

Summary table of Test Cases	
Test Item	Data Rate / Modulation
	Bluetooth 4.0 – LE / GFSK
Conducted TCs	Mode 1: Bluetooth Tx CH00_2402 MHz_1Mbps Mode 2: Bluetooth Tx CH19_2440 MHz_1Mbps Mode 3: Bluetooth Tx CH39_2480 MHz_1Mbps
Radiated TCs	Mode 1: Bluetooth Tx CH00_2402 MHz_1Mbps Mode 2: Bluetooth Tx CH19_2440 MHz_1Mbps Mode 3: Bluetooth Tx CH39_2480 MHz_1Mbps
AC Conducted Emission	Mode 1: BT LE Tx + EUT with Docking + USB Cable (Charging from Adapter) Mode 2: WLAN Tx + EUT with Docking + USB Cable (Charging from Adapter)
Remark: The worst case of conducted emission is mode 1; only the test data of it was reported.	

2.3 Connection Diagram of Test System

<Bluetooth 4.0 – LE Tx Mode>

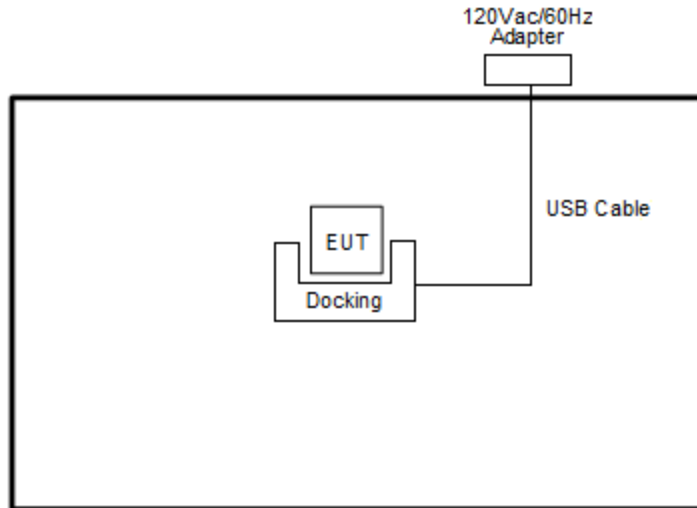

<AC Conducted Emission Mode>

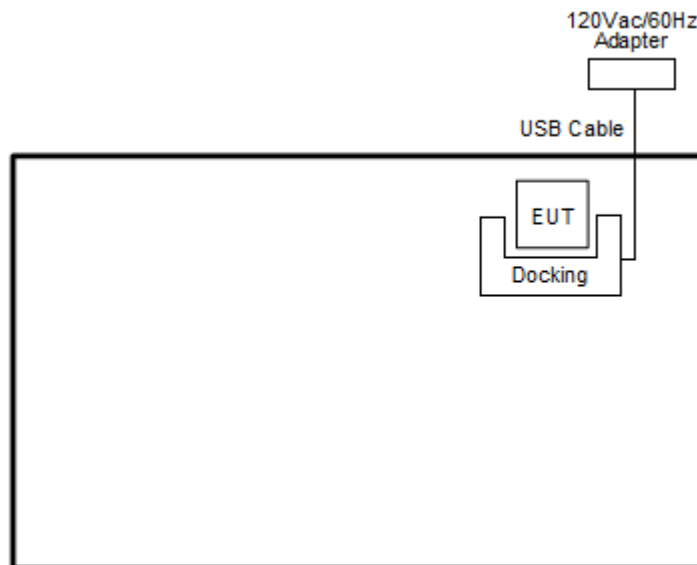

2.4 Support Unit used in test configuration and system

Item	Equipment	Trade Name	Model Name	FCC ID	Data Cable	Power Cord
1.	Docking	Getac	N/A	N/A	N/A	Unshielded, 1.1 m
2.	Adapter	TPC	NSS050200B	N/A	N/A	N/A



2.5 EUT Operation Test Setup

For Bluetooth function, the RF utility, "Sample_Project" was installed in EUT which was programmed in order to make the EUT get into the engineering modes to contact with Bluetooth base station for continuous transmitting and receiving signals.

2.6 Measurement Results Explanation Example

For all conducted test items:

The offset level is set in the spectrum analyzer to compensate the RF cable loss and attenuator factor between EUT conducted output port and spectrum analyzer. With the offset compensation, the spectrum analyzer reading level is exactly the EUT RF output level.

Example :

The spectrum analyzer offset is derived from RF cable loss and attenuator factor.

Offset = RF cable loss + attenuator factor.

Following shows an offset computation example with cable loss 4.2 dB and 10dB attenuator.

$$\begin{aligned} \text{Offset(dB)} &= \text{RF cable loss(dB)} + \text{attenuator factor(dB)}. \\ &= 4.2 + 10 = 14.2 \text{ (dB)} \end{aligned}$$

3 Test Result

3.1 6dB and 99% Bandwidth Measurement

3.1.1 Limit of 6dB and 99% Bandwidth

The minimum 6 dB bandwidth shall be at least 500 kHz.

3.1.2 Measuring Instruments

The section 4.0 of List of Measuring Equipment of this test report is used for test.

3.1.3 Test Procedures

1. The testing follows FCC KDB Publication No. 558074 D01 DTS Meas. Guidance v03r05.
2. The RF output of EUT was connected to the spectrum analyzer by RF cable and attenuator. The path loss was compensated to the results for each measurement.
3. Set to the maximum power setting and enable the EUT transmit continuously.
4. Make the measurement with the spectrum analyzer's resolution bandwidth (RBW) = 100 kHz. Set the Video bandwidth (VBW) = 300 kHz. In order to make an accurate measurement. The 6 dB bandwidth must be greater than 500 kHz.
5. For 99% Bandwidth Measurement, the spectrum analyzer's resolution bandwidth (RBW) is set 30kHz and set the Video bandwidth (VBW) = 100kHz.
6. Measure and record the results in the test report.

3.1.4 Test Setup

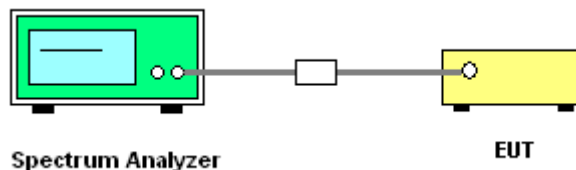



3.1.5 Test Result of 6dB Bandwidth

Test data refer to Appendix A.

6 dB Bandwidth Plot on Channel 00

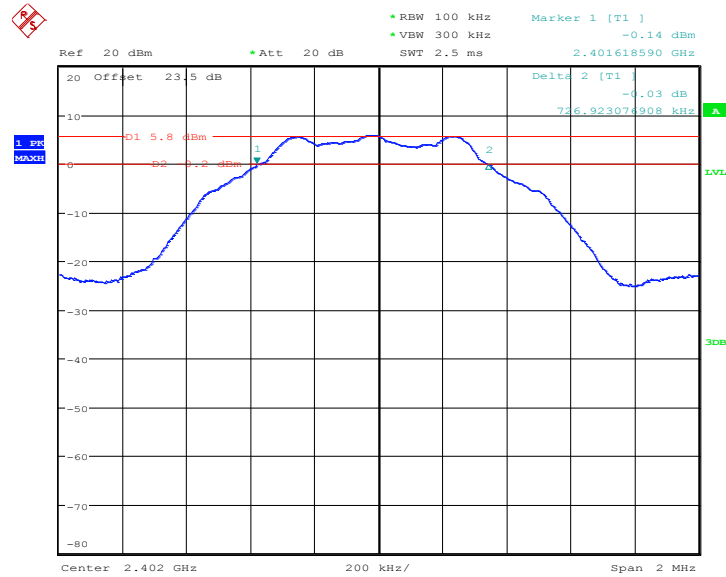

Date: 21.JUN.2016 20:19:36



6 dB Bandwidth Plot on Channel 19

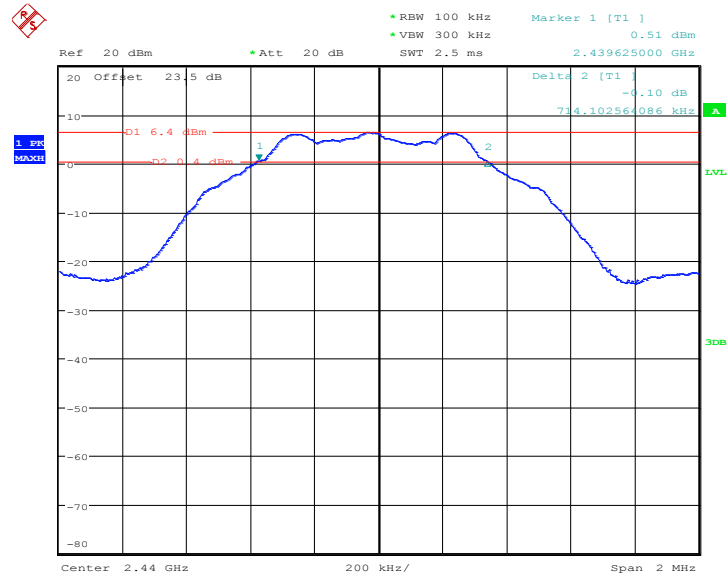

Date: 21.JUN.2016 20:24:42

6 dB Bandwidth Plot on Channel 39

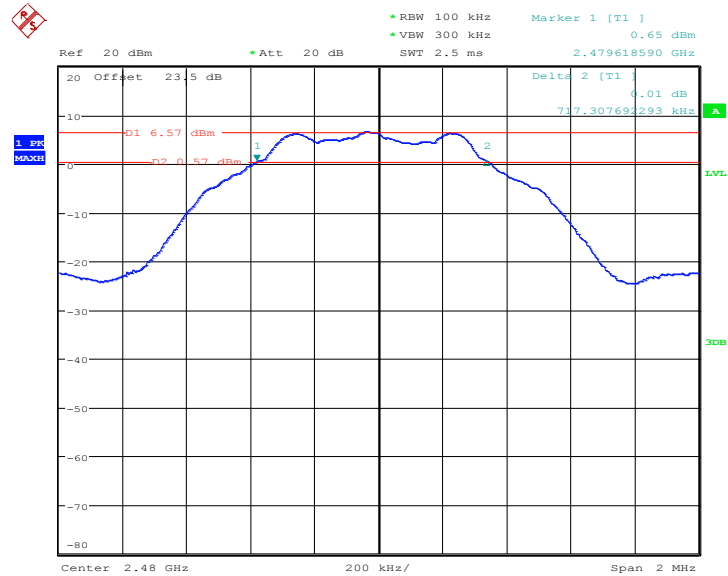

Date: 21.JUN.2016 20:28:41



3.1.6 Test Result of 99% Occupied Bandwidth

Test data refer to Appendix A.

99% Bandwidth Plot on Channel 00

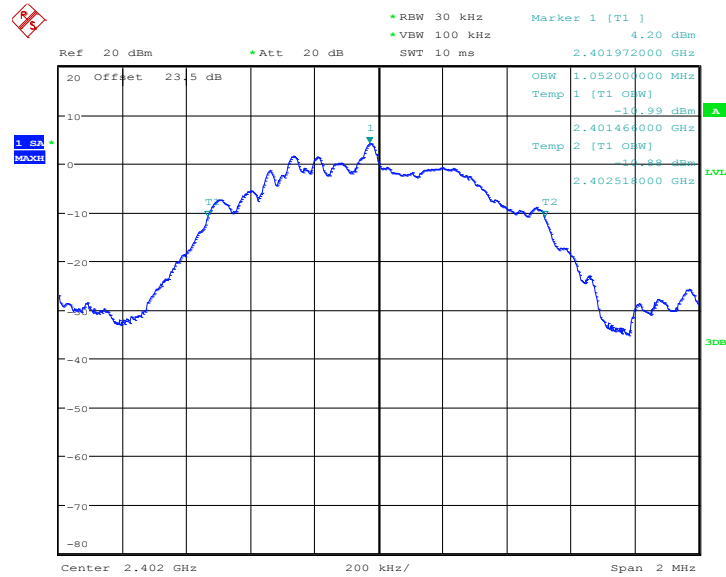

Date: 21.JUN.2016 20:22:00



99% Occupied Bandwidth Plot on Channel 19

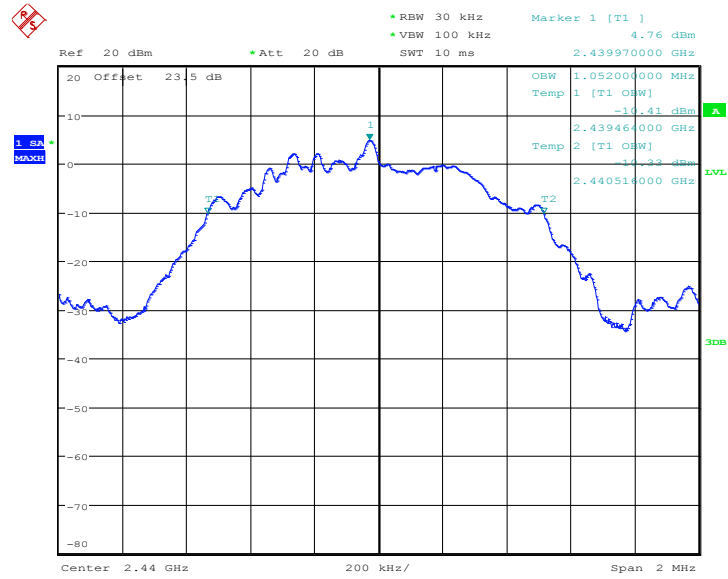

Date: 21.JUN.2016 20:26:09

99% Occupied Bandwidth Plot on Channel 39

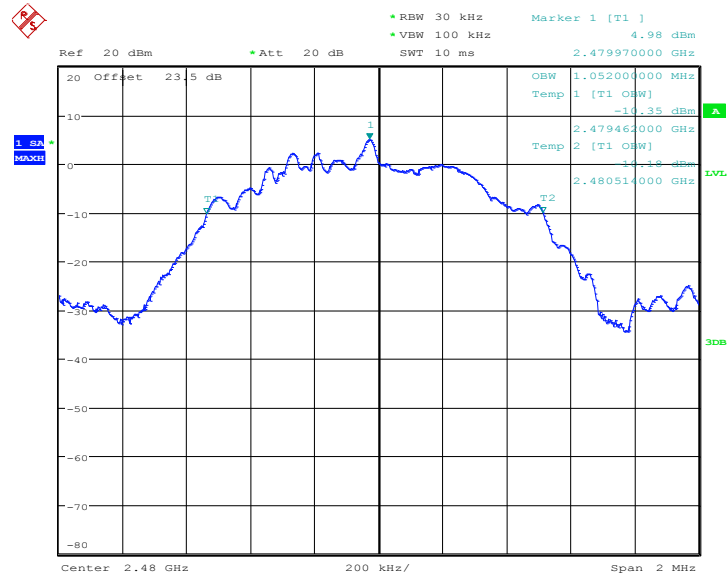

Date: 21.JUN.2016 20:33:09

Note : The occupied channel bandwidth is maintained within the band of operation for all of the modulations.

3.2 Peak Output Power Measurement

3.2.1 Limit of Peak Output Power

For systems using digital modulation in the 2400-2483.5MHz, the limit for peak output power is 30dBm. If transmitting antenna of directional gain greater than 6dBi is used, the peak output power from the intentional radiator shall be reduced below the above stated value by the amount in dB that the directional gain of the antenna exceeds 6 dBi. In case of point-to-point operation, the limit has to be reduced by 1dB for every 3dB that the directional gain of the antenna exceeds 6dBi.

3.2.2 Measuring Instruments

The section 4.0 of List of Measuring Equipment of this test report is used for test.

3.2.3 Test Procedures

1. The testing follows the Measurement Procedure of FCC KDB No. 558074 DTS D01 Meas. Guidance v03r05 section 9.1.2 PKPM1 Peak power meter method.
2. The RF output of EUT was connected to the power meter by RF cable and attenuator. The path loss was compensated to the results for each measurement.
3. Set to the maximum power setting and enable the EUT transmit continuously.
4. Measure the conducted output power and record the results in the test report.

3.2.4 Test Setup

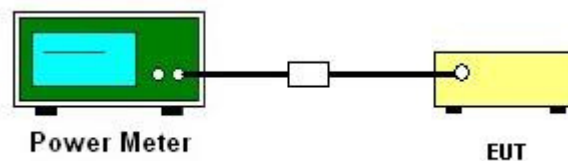

3.2.5 Test Result of Peak Output Power

Test data refers to Appendix A.

3.3 Power Spectral Density Measurement

3.3.1 Limit of Power Spectral Density

The peak power spectral density shall not be greater than 8dBm in any 3kHz band at any time interval of continuous transmission.

3.3.2 Measuring Instruments

The section 4.0 of List of Measuring Equipment of this test report is used for test.

3.3.3 Test Procedures

1. The testing follows Measurement Procedure 10.2 Method PKPSD of FCC KDB Publication No. 558074 D01 DTS Meas. Guidance v03r05
2. The RF output of EUT was connected to the spectrum analyzer by RF cable and attenuator. The path loss was compensated to the results for each measurement.
3. Set to the maximum power setting and enable the EUT transmit continuously.
4. Make the measurement with the spectrum analyzer's resolution bandwidth (RBW) = 3 kHz. Video bandwidth VBW = 10 kHz In order to make an accurate measurement, set the span to 1.5 times DTS Channel Bandwidth. (6dB BW)
5. Detector = peak, Sweep time = auto couple, Trace mode = max hold, Allow trace to fully stabilize. Use the peak marker function to determine the maximum power level.
6. Measure and record the results in the test report.
7. The Measured power density (dBm)/ 100kHz is a reference level and used as 20dBc down limit line for Conducted Band Edges and Conducted Spurious Emission.

3.3.4 Test Setup

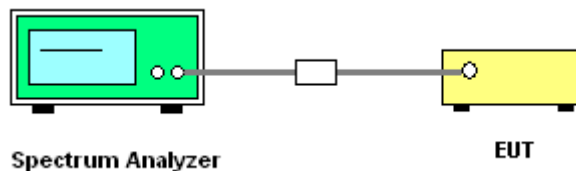



3.3.5 Test Result of Power Spectral Density

Test data refers to Appendix A.

3.3.6 Test Result of Power Spectral Density Plots (100kHz)

PSD 100kHz Plot on Channel 00

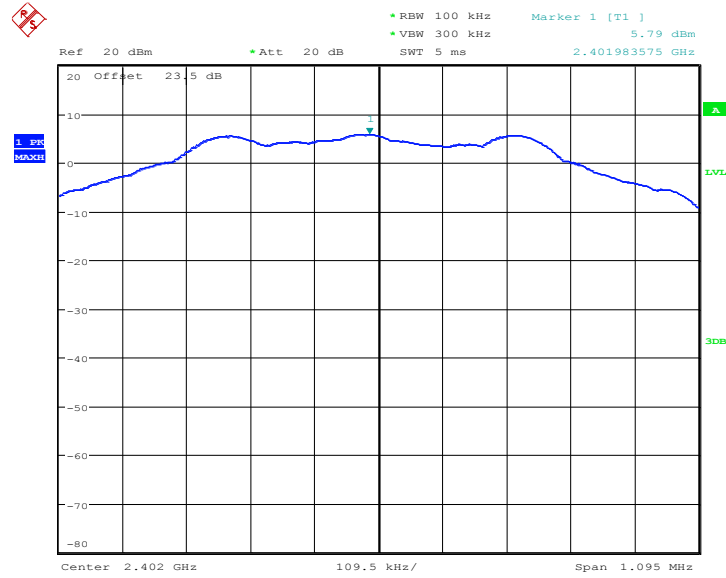

Date: 21.JUN.2016 20:20:45



PSD 100kHz Plot on Channel 19

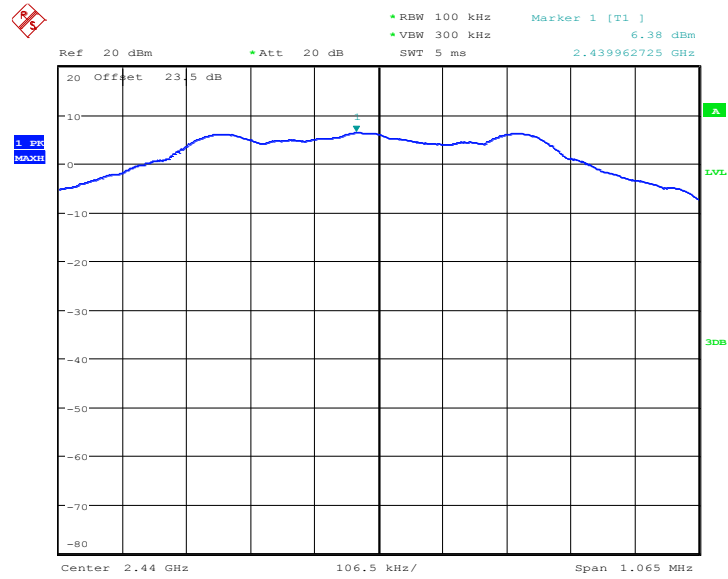

Date: 21.JUN.2016 20:25:27

PSD 100kHz Plot on Channel 39

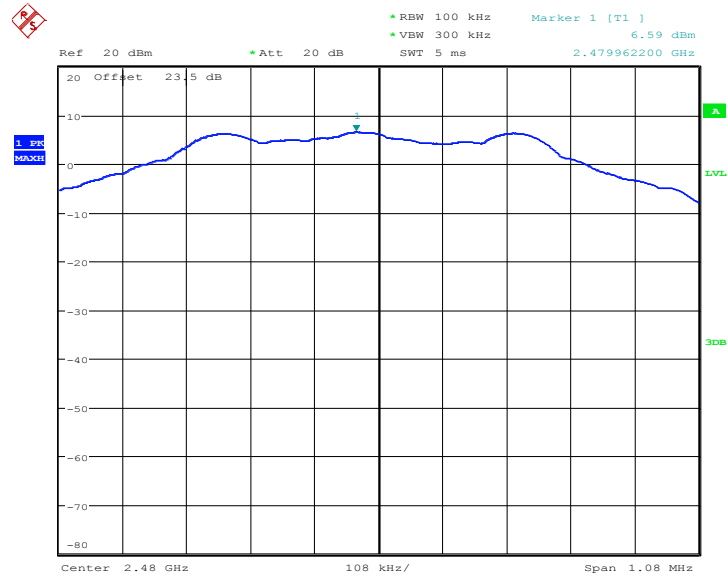

Date: 21.JUN.2016 20:29:47



3.3.7 Test Result of Power Spectral Density Plots (3kHz)

PSD 3kHz Plot on Channel 00

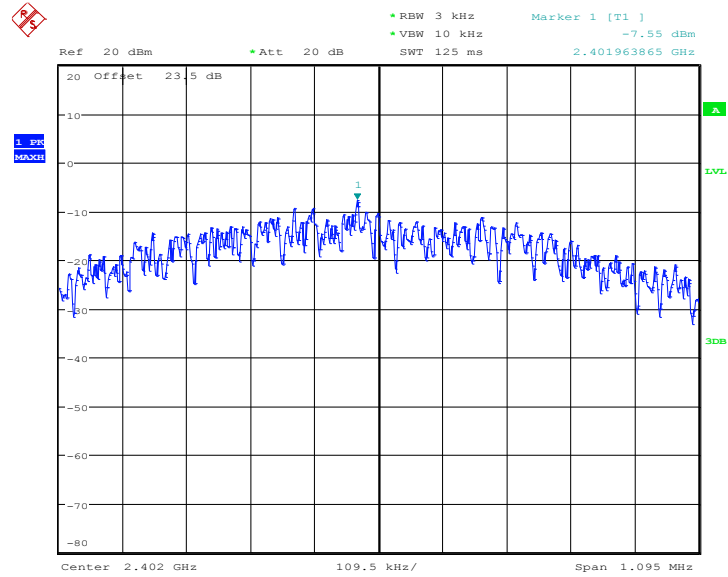

Date: 21.JUN.2016 20:20:21



PSD 3kHz Plot on Channel 19

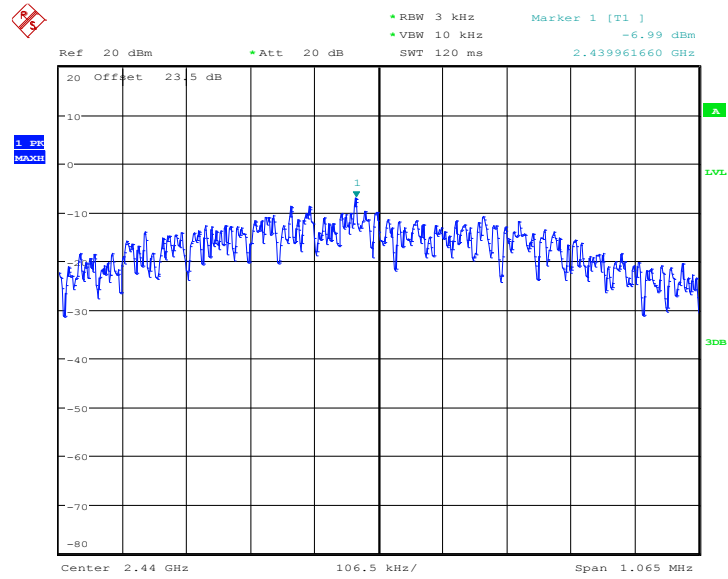

Date: 21.JUN.2016 20:25:07

PSD 3kHz Plot on Channel 39

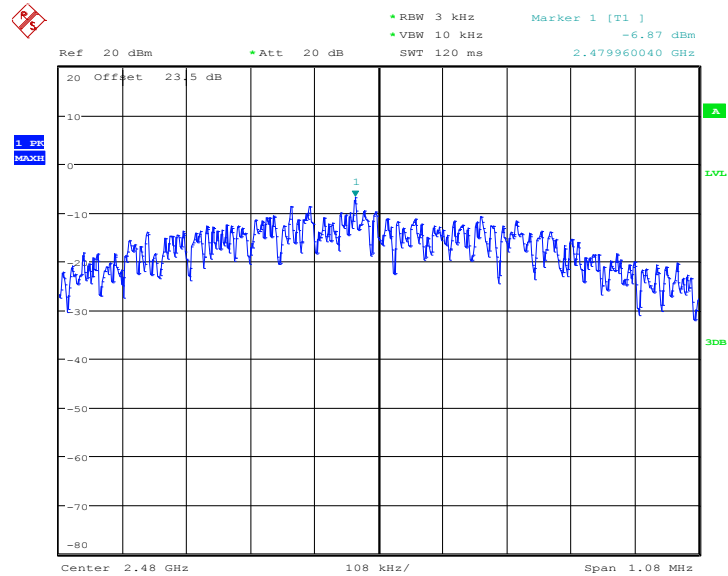

Date: 21.JUN.2016 20:28:59

3.4 Conducted Band Edges and Spurious Emission Measurement

3.4.1 Limit of Conducted Band Edges and Spurious Emission

All harmonics/spurious must be at least 20 dB down from the highest emission level within the authorized band.

3.4.2 Measuring Instruments

The section 4.0 of List of Measuring Equipment of this test report is used for test.

3.4.3 Test Procedure

1. The testing follows FCC KDB Publication No. 558074 D01 DTS Meas. Guidance v03r05.
2. The RF output of EUT was connected to the spectrum analyzer by RF cable and attenuator. The path loss was compensated to the results for each measurement.
3. Set to the maximum power setting and enable the EUT transmit continuously.
4. Set RBW = 100 kHz, VBW=300 kHz, Peak Detector. Unwanted Emissions measured in any 100 kHz bandwidth outside of the authorized frequency band shall be attenuated by at least 20 dB relative to the maximum in-band peak PSD level in 100 kHz when maximum peak conducted output power procedure is used. If the transmitter complies with the conducted power limits based on the use of RMS averaging over a time interval, the attenuation required under this paragraph shall be 30 dB instead of 20 dB per 15.247(d).
5. Measure and record the results in the test report.
6. The RF fundamental frequency should be excluded against the limit line in the operating frequency band.

3.4.4 Test Setup

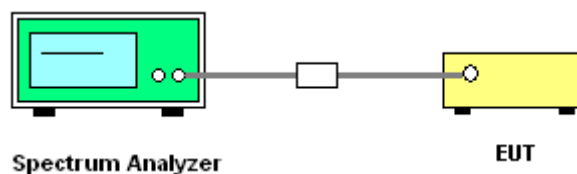



3.4.5 Test Result of Conducted Band Edges Plots

Low Band Edge Plot on Channel 00

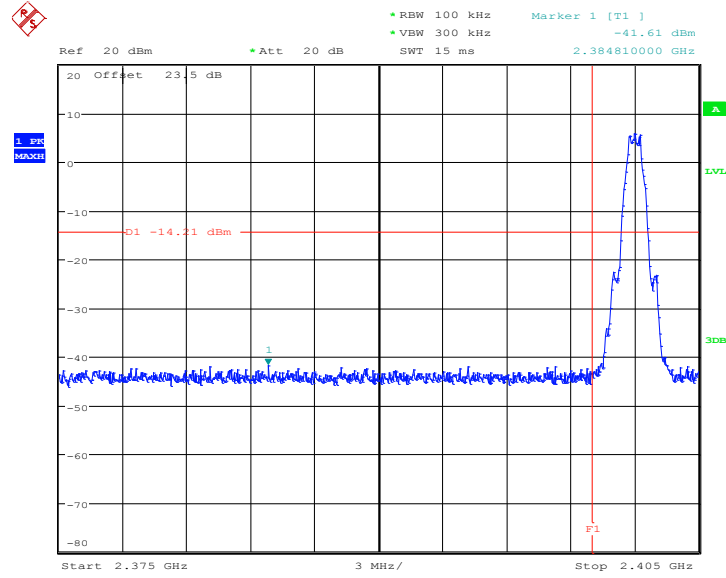

Date: 21.JUN.2016 20:21:01

High Band Edge Plot on Channel 39

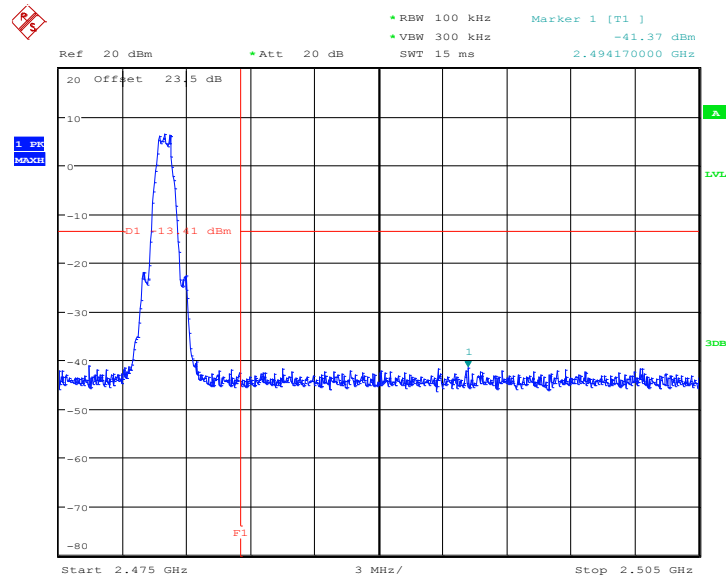

Date: 21.JUN.2016 20:32:18



3.4.6 Test Result of Conducted Spurious Emission Plots

Conducted Spurious Emission Plot on Bluetooth LE 1Mbps GFSK Channel 00

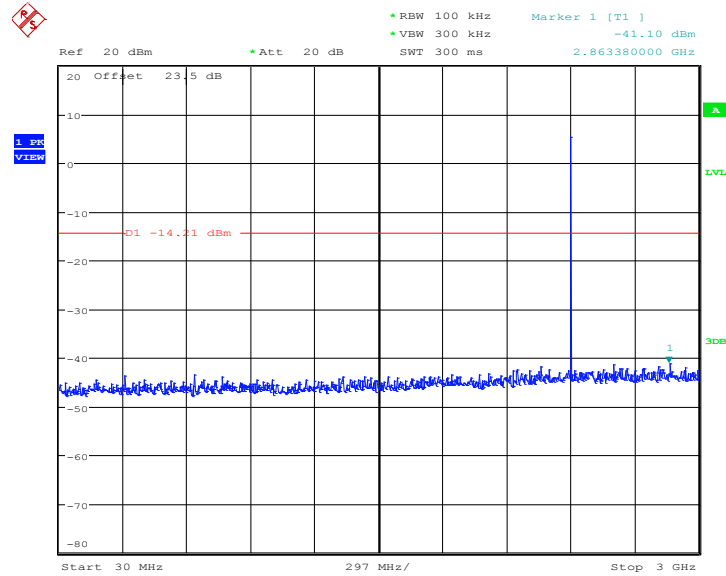

Date: 21.JUN.2016 20:21:33

Conducted Spurious Emission Plot on Bluetooth LE 1Mbps GFSK Channel 00

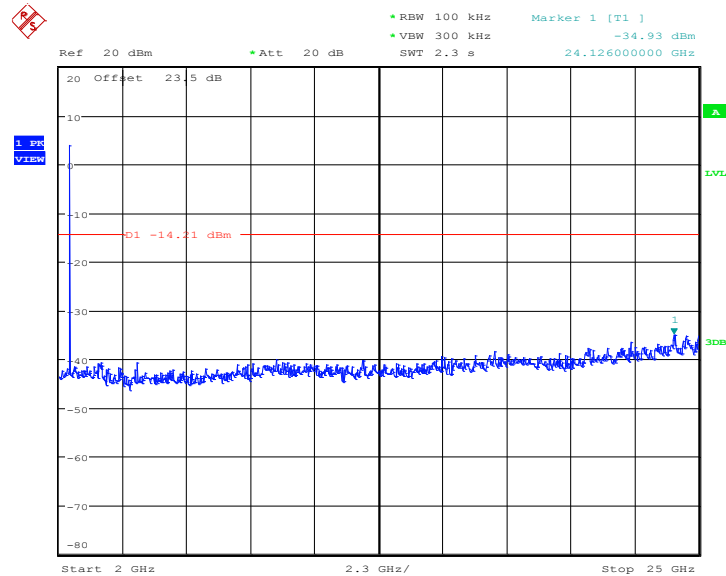

Date: 21.JUN.2016 20:21:42



Conducted Spurious Emission Plot on Bluetooth LE 1Mbps GFSK Channel 19

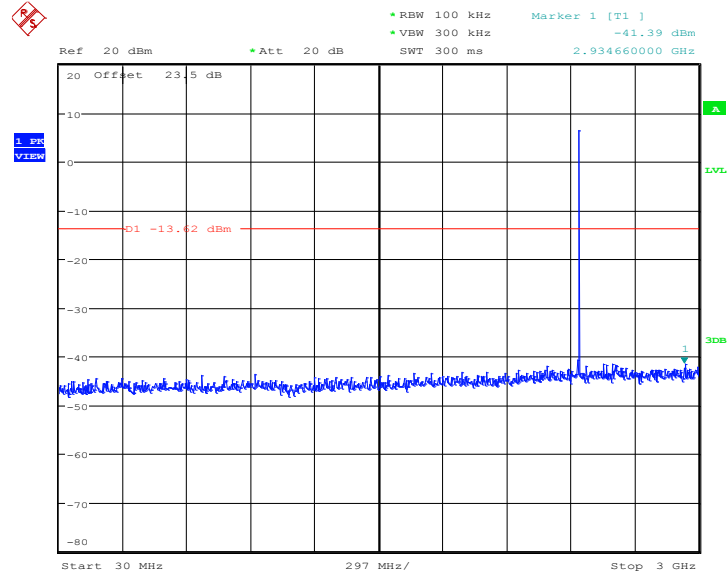

Date: 21.JUN.2016 20:25:40

Conducted Spurious Emission Plot on Bluetooth LE 1Mbps GFSK Channel 19

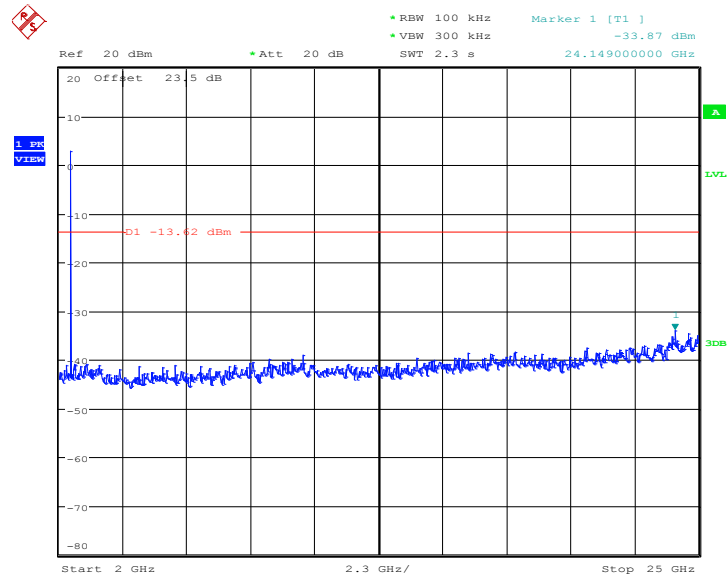

Date: 21.JUN.2016 20:25:48



Conducted Spurious Emission Plot on Bluetooth LE 1Mbps GFSK Channel 39

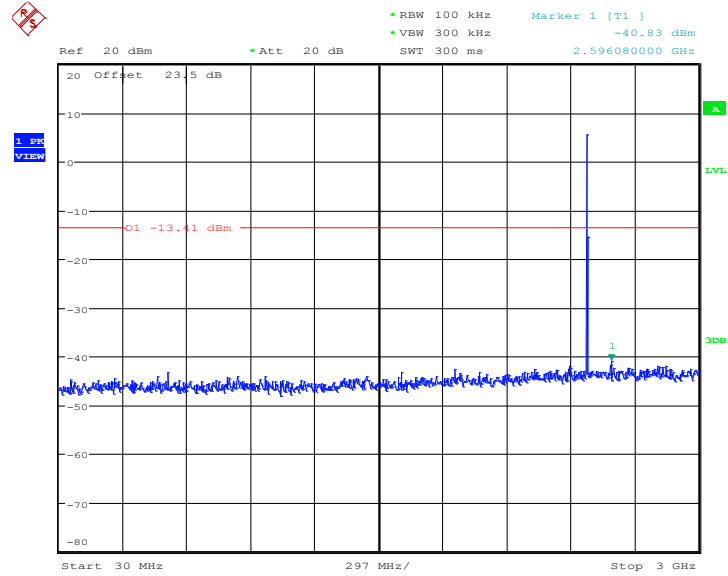

Date: 21.JUN.2016 20:32:31

Conducted Spurious Emission Plot on Bluetooth LE 1Mbps GFSK Channel 39

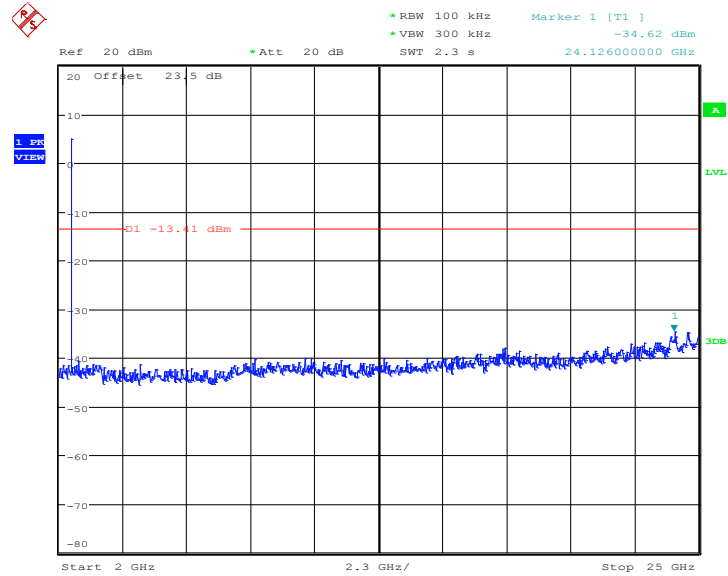

Date: 21.JUN.2016 20:32:39



3.5 Radiated Band Edges and Spurious Emission Measurement

3.5.1 Limit of Radiated Band Edges and Spurious Emission

In any 100 kHz bandwidth outside the intentional radiator frequency band, all harmonics/spurious must be at least 20 dB below the highest emission level within the authorized band. If the output power of this device was measured by spectrum analyzer, the attenuation under this paragraph shall be 30 dB instead of 20 dB. In addition, radiated emissions which fall in the restricted bands must also comply with the FCC section 15.209 limits as below.

Frequency (MHz)	Field Strength (microvolts/meter)	Measurement Distance (meters)
0.009 – 0.490	2400/F(kHz)	300
0.490 – 1.705	24000/F(kHz)	30
1.705 – 30.0	30	30
30 – 88	100	3
88 – 216	150	3
216 - 960	200	3
Above 960	500	3

3.5.2 Measuring Instruments

The section 4.0 of List of Measuring Equipment of this test report is used for test.



3.5.3 Test Procedures

1. The testing follows FCC KDB Publication No. 558074 D01 DTS Meas. Guidance v03r05.
2. The EUT was arranged to its worst case and then tune the antenna tower (from 1 m to 4 m) and turntable (from 0 degree to 360 degrees) to find the maximum reading. A pre-amp and a high pass filter are used for the test in order to get better signal level.
3. The EUT was placed on a turntable with 0.8 meter for frequency below 1GHz and 1.5 meter for frequency above 1GHz respectively above ground.
4. The EUT was set 3 meters from the interference receiving antenna, which was mounted on the top of a variable height antenna tower.
5. Corrected Reading: Antenna Factor + Cable Loss + Read Level - Preamp Factor = Level
6. For measurement below 1GHz, If the emission level of the EUT measured by the peak detector is 3 dB lower than the applicable limit, the peak emission level will be reported. Otherwise, the emission measurement will be repeated using the quasi-peak detector and reported.
7. Use the following spectrum analyzer settings:
 - (1) Span shall wide enough to fully capture the emission being measured;
 - (2) Set RBW=100 kHz for $f < 1$ GHz; VBW \geq RBW; Sweep = auto; Detector function = peak; Trace = max hold;
 - (3) Set RBW = 1 MHz, VBW= 3MHz for $f \geq 1$ GHz for peak measurement.
For average measurement:
 - VBW = 10 Hz, when duty cycle is no less than 98 percent.
 - VBW $\geq 1/T$, when duty cycle is less than 98 percent where T is the minimum transmission duration over which the transmitter is on and is transmitting at its maximum power control level for the tested mode of operation.

3.5.4 Test Setup

For radiated emissions below 30MHz

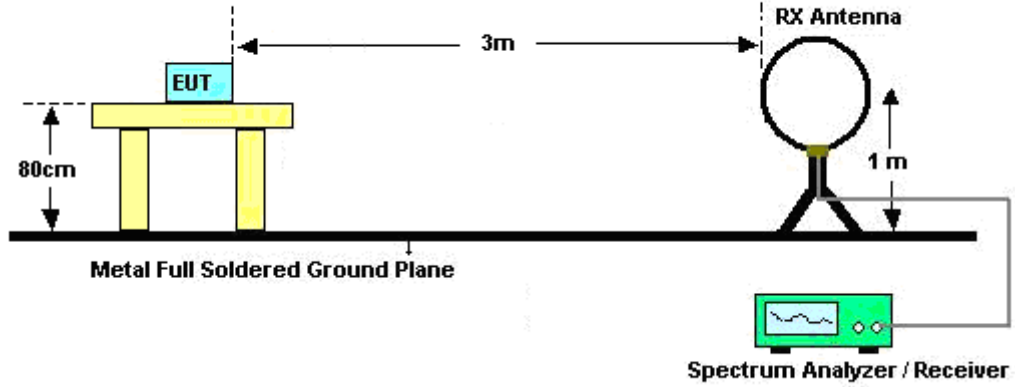

For radiated emissions from 30MHz to 1GHz

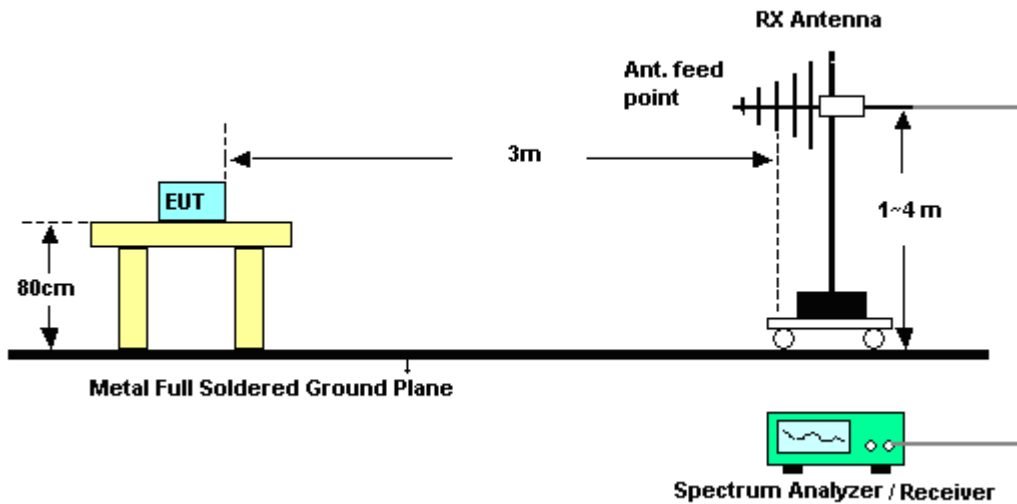

For radiated emissions above 1GHz

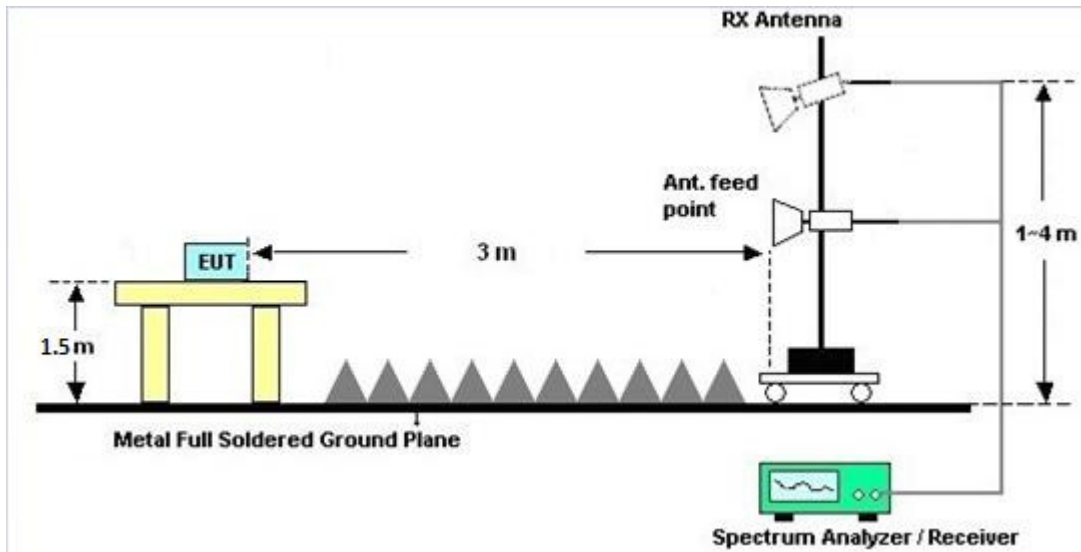

3.5.5 Test Results of Radiated Spurious Emissions (9 kHz ~ 30 MHz)

The low frequency, which started from 9 kHz to 30MHz, was pre-scanned and the result which was 20dB lower than the limit line per 15.31(o) was not reported.

3.5.6 Test Result of Radiated Spurious at Band Edges

Please refer to Appendix B and C.

3.5.7 Duty Cycle

Please refer to Appendix D.

3.5.8 Test Result of Radiated Spurious Emission (30MHz ~ 10th Harmonic)

Please refer to Appendix B and C.



3.6 AC Conducted Emission Measurement

3.6.1 Limit of AC Conducted Emission

For equipment that is designed to be connected to the public utility (AC) power line, the radio frequency voltage that is conducted back onto the AC power line on any frequency or frequencies within the band 150 kHz to 30 MHz shall not exceed the limits in the following table.

Frequency of emission (MHz)	Conducted limit (dB μ V)	
	Quasi-peak	Average
0.15-0.5	66 to 56*	56 to 46*
0.5-5	56	46
5-30	60	50

*Decreases with the logarithm of the frequency.

3.6.2 Measuring Instruments

The section 4.0 of List of Measuring Equipment of this test report is used for test.

3.6.3 Test Procedures

1. The EUT was placed 0.4 meter from the conducting wall of the shielding room was kept at least 80 centimeters from any other grounded conducting surface.
2. Connect EUT to the power mains through a line impedance stabilization network (LISN).
3. All the support units are connecting to the other LISN.
4. The LISN provides 50 ohm coupling impedance for the measuring instrument.
5. The FCC states that a 50 ohm, 50 microhenry LISN should be used.
6. Both sides of AC line were checked for maximum conducted interference.
7. The frequency range from 150 kHz to 30 MHz was searched.
8. Set the test-receiver system to Peak Detect Function and specified bandwidth (IF Bandwidth = 9kHz) with Maximum Hold Mode. Then measurement is also conducted by Average Detector and Quasi-Peak Detector Function respectively.

3.6.4 Test Setup

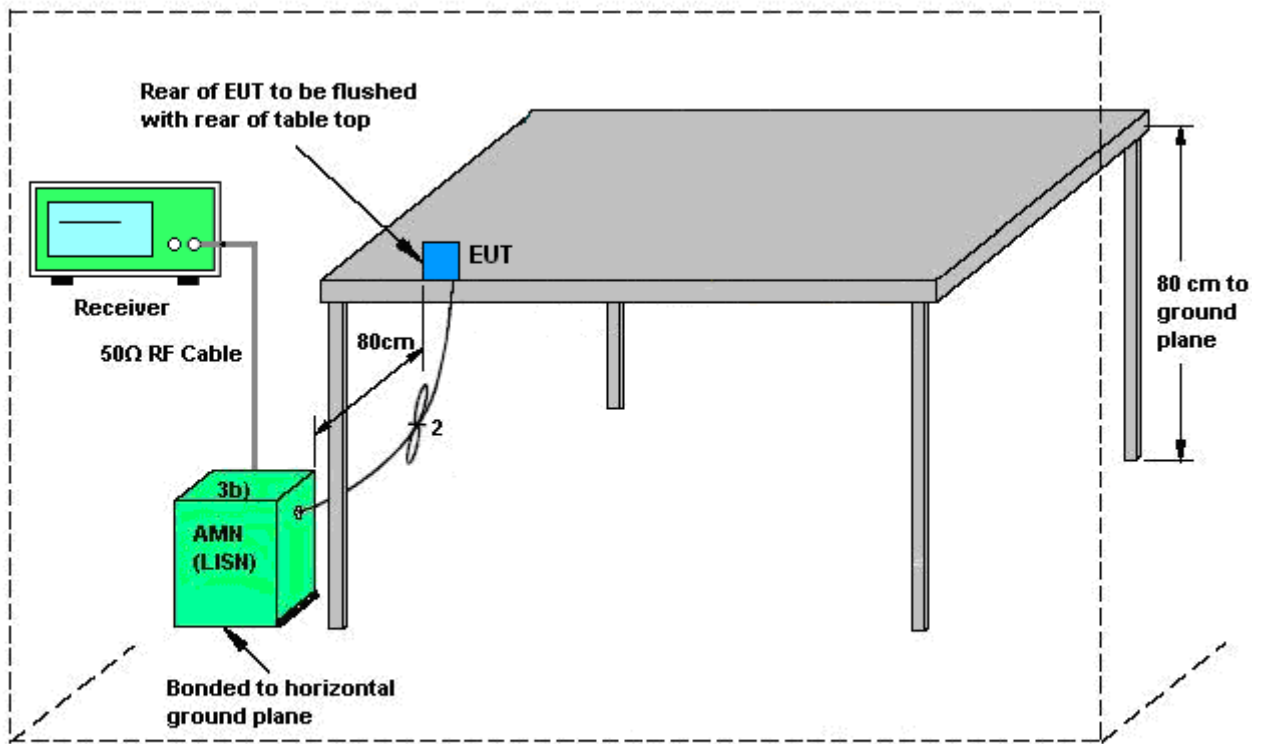

AMN = Artificial mains network (LISN)
 AE = Associated equipment
 EUT = Equipment under test
 ISN = Impedance stabilization network



3.6.5 Test Result of AC Conducted Emission

Test Mode :	Mode 1	Temperature :	22~23°C
Test Engineer :	Arthur Hsieh	Relative Humidity :	51~52%
Test Voltage :	120Vac / 60Hz	Phase :	Line
Function Type :	BT LE Tx + EUT with Docking + USB Cable (Charging from Adapter)		

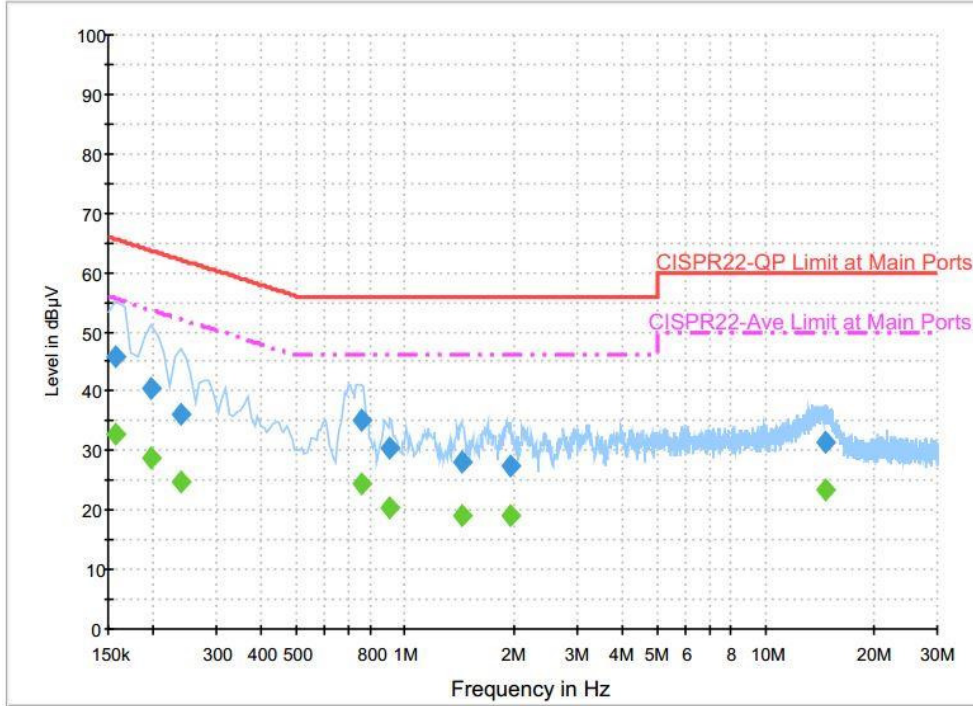

Final Result : Quasi-Peak

Frequency (MHz)	Quasi-Peak (dBµV)	Filter	Line	Corr. (dB)	Margin (dB)	Limit (dBµV)
0.158000	45.7	Off	L1	19.6	19.9	65.6
0.198000	40.6	Off	L1	19.6	23.1	63.7
0.238000	36.1	Off	L1	19.6	26.1	62.2
0.758000	35.3	Off	L1	19.6	20.7	56.0
0.910000	30.3	Off	L1	19.6	25.7	56.0
1.438000	28.2	Off	L1	19.7	27.8	56.0
1.974000	27.4	Off	L1	19.7	28.6	56.0
14.694000	31.3	Off	L1	20.4	28.7	60.0

Final Result : Average

Frequency (MHz)	Average (dBµV)	Filter	Line	Corr. (dB)	Margin (dB)	Limit (dBµV)
0.158000	32.8	Off	L1	19.6	22.8	55.6
0.198000	28.7	Off	L1	19.6	25.0	53.7
0.238000	24.8	Off	L1	19.6	27.4	52.2
0.758000	24.5	Off	L1	19.6	21.5	46.0
0.910000	20.5	Off	L1	19.6	25.5	46.0
1.438000	19.1	Off	L1	19.7	26.9	46.0
1.974000	18.9	Off	L1	19.7	27.1	46.0
14.694000	23.4	Off	L1	20.4	26.6	50.0



Test Mode :	Mode 1	Temperature :	22~23°C
Test Engineer :	Arthur Hsieh	Relative Humidity :	51~52%
Test Voltage :	120Vac / 60Hz	Phase :	Neutral
Function Type :	BT LE Tx + EUT with Docking + USB Cable (Charging from Adapter)		

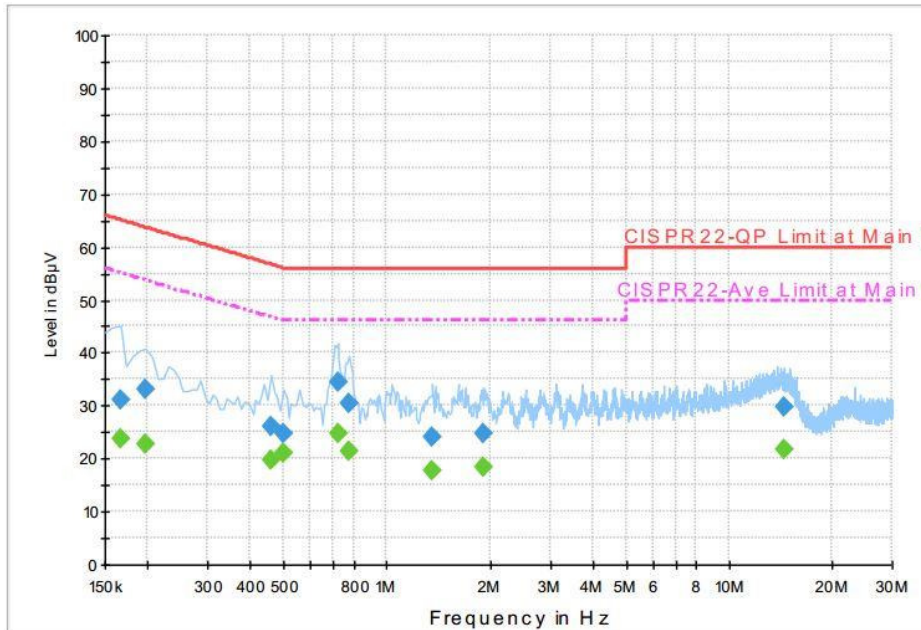

Final Result : Quasi-Peak

Frequency (MHz)	Quasi-Peak (dBµV)	Filter	Line	Corr. (dB)	Margin (dB)	Limit (dBµV)
0.166000	31.0	Off	N	19.6	34.2	65.2
0.198000	33.3	Off	N	19.6	30.4	63.7
0.462000	26.1	Off	N	19.6	30.6	56.7
0.502000	24.9	Off	N	19.6	31.1	56.0
0.718000	34.6	Off	N	19.6	21.4	56.0
0.774000	30.5	Off	N	19.6	25.5	56.0
1.358000	24.0	Off	N	19.6	32.0	56.0
1.926000	24.8	Off	N	19.7	31.2	56.0
14.542000	29.6	Off	N	20.4	30.4	60.0

Final Result : Average

Frequency (MHz)	Average (dBµV)	Filter	Line	Corr. (dB)	Margin (dB)	Limit (dBµV)
0.166000	23.6	Off	N	19.6	31.6	55.2
0.198000	22.8	Off	N	19.6	30.9	53.7
0.462000	19.6	Off	N	19.6	27.1	46.7
0.502000	21.0	Off	N	19.6	25.0	46.0
0.718000	24.6	Off	N	19.6	21.4	46.0
0.774000	21.6	Off	N	19.6	24.4	46.0
1.358000	17.7	Off	N	19.6	28.3	46.0
1.926000	18.3	Off	N	19.7	27.7	46.0
14.542000	21.8	Off	N	20.4	28.2	50.0



3.7 Antenna Requirements

3.7.1 Standard Applicable

If directional gain of transmitting antennas is greater than 6dBi, the power shall be reduced by the same level in dB comparing to gain minus 6dBi. The use of a permanently attached antenna or of an antenna that uses a unique coupling to the intentional radiator shall be considered sufficient to comply with the FCC rule.

3.7.2 Antenna Anti-Replacement Construction

An embedded-in antenna design is used.

3.7.3 Antenna Gain

The antenna peak gain of EUT is less than 6 dBi. Therefore, it is not necessary to reduce maximum peak output power limit.



4 List of Measuring Equipment

Instrument	Manufacturer	Model No.	Serial No.	Characteristics	Calibration Date	Test Date	Due Date	Remark
Power Meter	Agilent	E4416A	GB412923 44	300MHz~40GHz	Jan. 08, 2016	Jun. 07, 2016 ~ Jun. 21, 2016	Jan. 07, 2017	Conducted (TH02-HY)
Power Meter	Anritsu	ML2495A	1036004	300MHz~40GHz	Jul. 29, 2015	Jun. 07, 2016 ~ Jun. 21, 2016	Jul. 28, 2016	Conducted (TH02-HY)
Power Sensor	Agilent	E9327A	US404415 48	300MHz~40GHz	Jan. 07, 2016	Jun. 07, 2016 ~ Jun. 21, 2016	Jan. 06, 2017	Conducted (TH02-HY)
Power Sensor	Anritsu	MA2411B	1027253	300MHz~40GHz	Jul. 29, 2015	Jun. 07, 2016 ~ Jun. 21, 2016	Jul. 28, 2016	Conducted (TH02-HY)
Spectrum Analyzer	Rohde & Schwarz	FSP40	100055	9kHz~40GHz	Jun. 18, 2015	Jun. 07, 2016 ~ Jun. 16, 2016	Jun. 17, 2016	Conducted (TH02-HY)
Spectrum Analyzer	Rohde & Schwarz	FSP40	100055	9kHz~40GHz	Jun. 17, 2016	Jun. 17, 2016 ~ Jun. 21, 2016	Jun. 16, 2017	Conducted (TH02-HY)
AC Power Source	ChainTek	APC-1000 W	N/A	N/A	N/A	Jul. 05, 2016	N/A	Conduction (CO05-HY)
EMI Test Receiver	Rohde & Schwarz	ESCI 7	100724	9kHz~7GHz	Aug. 26, 2015	Jul. 05, 2016	Aug. 25, 2016	Conduction (CO05-HY)
LISN	Rohde & Schwarz	ENV216	100080	9kHz~30MHz	Dec. 02, 2015	Jul. 05, 2016	Dec. 01, 2016	Conduction (CO05-HY)
Loop Antenna	Rohde & Schwarz	HFH2-Z2	100315	9 kHz~30 MHz	Sep. 02, 2015	Jun. 28, 2016 ~ Jul. 01, 2016	Sep. 01, 2016	Radiation (03CH10-HY)
Amplifier	SONOMA	310N	187311	9kHz~1GHz	Nov. 16, 2015	Jun. 28, 2016 ~ Jul. 01, 2016	Nov. 15, 2016	Radiation (03CH10-HY)
Bilog Antenna	TESEQ	CBL 6111D	35413	30MHz~1GHz	Jan. 13, 2016	Jun. 28, 2016 ~ Jul. 01, 2016	Jan. 12, 2017	Radiation (03CH10-HY)
Horn Antenna	SCHWARZBEC K	BBHA 9120 D	9120D-132 5	1GHz ~ 18GHz	Sep. 30, 2015	Jun. 28, 2016 ~ Jul. 01, 2016	Sep. 29, 2016	Radiation (03CH10-HY)
Preamplifier	Keysight	83017A	MY532700 78	1GHz~26.5GHz	Nov. 13, 2015	Jun. 28, 2016 ~ Jul. 01, 2016	Nov. 12, 2016	Radiation (03CH10-HY)
Preamplifier	MITEQ	AMF-7D-00 101800-30- 10P	1902246	1GHz~18GHz	Nov. 16, 2015	Jun. 28, 2016 ~ Jul. 01, 2016	Nov. 15, 2016	Radiation (03CH10-HY)
Spectrum Analyzer	Keysight	N9010A	MY542004 85	10Hz ~ 44GHz	Oct. 15, 2015	Jun. 28, 2016 ~ Jul. 01, 2016	Oct. 14, 2016	Radiation (03CH10-HY)
Antenna Mast	EMEC	AM-BS-450 0-B	N/A	1~4m	N/A	Jun. 28, 2016 ~ Jul. 01, 2016	N/A	Radiation (03CH10-HY)
Turn Table	EMEC	TT 2200	N/A	0~360 Degree	N/A	Jun. 28, 2016 ~ Jul. 01, 2016	N/A	Radiation (03CH10-HY)
Preamplifier	MITEQ	JS44-18004 000-33-8P	1840917	18GHz ~ 40GHz	Jun. 14, 2016	Jun. 28, 2016 ~ Jul. 01, 2016	Jun. 13, 2017	Radiation (03CH10-HY)
SHF-EHF Horn Antenna	SCHWARZBEC K	BBHA 9170	BBHA9170 584	18GHz- 40GHz	Nov. 02, 2015	Jun. 28, 2016 ~ Jul. 01, 2016	Nov. 01, 2016	Radiation (03CH10-HY)
EMI Test Receiver	Agilent	N9038A (MXE)	MY532900 53	20Hz to 26.5GHz	Jan. 20, 2016	Jun. 28, 2016 ~ Jul. 01, 2016	Jan. 19, 2017	Radiation (03CH10-HY)



5 Uncertainty of Evaluation

Uncertainty of Conducted Emission Measurement (150 kHz ~ 30 MHz)

Measuring Uncertainty for a Level of Confidence of 95% ($U = 2Uc(y)$)	2.26
---	------

Uncertainty of Radiated Emission Measurement (30 MHz ~ 1000 MHz)

Measuring Uncertainty for a Level of Confidence of 95% ($U = 2Uc(y)$)	5.50
---	------



Appendix A. Conducted Test Results

Bluetooth Low Energy

Test Engineer:	PH Yang	Temperature:	21~25	°C
Test Date:	2016/06/07~2016/06/21	Relative Humidity:	51~54	%

TEST RESULTS DATA
6dB and 99% Occupied Bandwidth

Mod.	Data Rate	NTX	CH.	Freq. (MHz)	99% Occupied BW (MHz)	6dB BW (MHz)	6dB BW Limit (MHz)	Pass/Fail
BLE	1Mbps	1	0	2402	1.05	0.73	0.50	Pass
BLE	1Mbps	1	19	2440	1.05	0.71	0.50	Pass
BLE	1Mbps	1	39	2480	1.05	0.72	0.50	Pass

TEST RESULTS DATA
Peak Power Table

Mod.	Data Rate	NTX	CH.	Freq. (MHz)	Peak Conducted Power (dBm)	Conducted Power Limit (dBm)	DG (dBi)	EIRP Power (dBm)	EIRP Power Limit (dBm)	Pass /Fail
BLE	1Mbps	1	0	2402	5.66	30.00	0.88	6.54	36.00	Pass
BLE	1Mbps	1	19	2440	6.08	30.00	0.88	6.96	36.00	Pass
BLE	1Mbps	1	39	2480	6.25	30.00	0.88	7.13	36.00	Pass

TEST RESULTS DATA
Average Power Table
(Reporting Only)

Mod.	Data Rate	NTX	CH.	Freq. (MHz)	Duty Factor (dB)	Average Conducted Power (dBm)
BLE	1Mbps	1	0	2402	2.09	5.41
BLE	1Mbps	1	19	2440	2.09	5.85
BLE	1Mbps	1	39	2480	2.09	5.95

TEST RESULTS DATA
Peak Power Density

Mod.	Data Rate	NTX	CH.	Freq. (MHz)	Peak PSD (dBm /100kHz)	Peak PSD (dBm /3kHz)	DG (dBi)	Peak PSD Limit (dBm /3kHz)	Pass/Fail
BLE	1Mbps	1	0	2402	5.79	-7.55	0.88	8.00	Pass
BLE	1Mbps	1	19	2440	6.38	-6.99	0.88	8.00	Pass
BLE	1Mbps	1	39	2480	6.59	-6.87	0.88	8.00	Pass

Note: PSD (dBm/ 100kHz) is a reference level used for Conducted Band Edges and Conducted Spurious Emission 20dBc limit.



Appendix B. Radiated Spurious Emission

Test Engineer :	Wilson Wu	Temperature :	24~25°C
		Relative Humidity :	50~52%

2.4GHz 2400~2483.5MHz

BLE (Band Edge @ 3m)

BLE	Note	Frequency (MHz)	Level (dBμV/m)	Over Limit (dB)	Limit Line (dBμV/m)	Read Level (dBμV)	Antenna Factor (dB/m)	Cable Loss (dB)	Preamp Factor (dB)	Ant Pos (cm)	Table Pos (deg)	Peak Avg. (P/A)	Pol. (H/V)	
BLE CH 00 2402MHz		2343.81	51.46	-22.54	74	52.28	27.1	5.33	33.25	348	99	P	H	
		2338.035	41.65	-12.35	54	42.48	27.1	5.33	33.26	348	99	A	H	
	*	2402	94.83	-	-	95.43	27.23	5.39	33.22	348	99	P	H	
	*	2402	94.09	-	-	94.69	27.23	5.39	33.22	348	99	A	H	
													H	
														H
			2381.4	51.12	-22.88	74	51.78	27.19	5.39	33.24	280	22	P	V
			2379.72	41.87	-12.13	54	42.53	27.19	5.39	33.24	280	22	A	V
	*		2402	95.11	-	-	95.71	27.23	5.39	33.22	280	22	P	V
	*		2402	94.43	-	-	95.03	27.23	5.39	33.22	280	22	A	V
														V
														V
BLE CH 19 2440MHz		2388.96	50.59	-23.41	74	51.21	27.23	5.39	33.24	336	133	P	H	
		2380.42	41.52	-12.48	54	42.18	27.19	5.39	33.24	336	133	A	H	
	*	2440	96.67	-	-	97.09	27.37	5.42	33.21	336	133	P	H	
	*	2440	95.93	-	-	96.35	27.37	5.42	33.21	336	133	A	H	
			2499.44	50.82	-23.18	74	51.03	27.5	5.46	33.17	336	133	P	H
			2485.51	42.14	-11.86	54	42.4	27.46	5.46	33.18	336	133	A	H
			2386.58	50.95	-23.05	74	51.57	27.23	5.39	33.24	303	30	P	V
			2388.68	41.52	-12.48	54	42.14	27.23	5.39	33.24	303	30	A	V
	*		2440	96.27	-	-	96.69	27.37	5.42	33.21	303	30	P	V
	*		2440	95.65	-	-	96.07	27.37	5.42	33.21	303	30	A	V
			2488.38	50.63	-23.37	74	50.85	27.5	5.46	33.18	303	30	P	V
			2493.49	42.2	-11.8	54	42.41	27.5	5.46	33.17	303	30	A	V



BLE CH 39 2480MHz	*	2480	97.25	-	-	97.53	27.46	5.44	33.18	290	123	P	H
	*	2480	96.14	-	-	96.42	27.46	5.44	33.18	290	123	A	H
		2484.12	51.5	-22.5	74	51.76	27.46	5.46	33.18	290	123	P	H
		2483.96	42.11	-11.89	54	42.37	27.46	5.46	33.18	290	123	A	H
													H
													H
	*	2480	97.19	-	-	97.47	27.46	5.44	33.18	261	30	P	V
	*	2480	96.46	-	-	96.74	27.46	5.44	33.18	261	30	A	V
		2490.08	51.54	-22.46	74	51.76	27.5	5.46	33.18	261	30	P	V
		2483.84	42.08	-11.92	54	42.34	27.46	5.46	33.18	261	30	A	V
													V
													V
Remark	1. No other spurious found. 2. All results are PASS against Peak and Average limit line.												



2.4GHz 2400~2483.5MHz
BLE (Harmonic @ 3m)

BLE	Note	Frequency (MHz)	Level (dBµV/m)	Over Limit (dB)	Limit Line (dBµV/m)	Read Level (dBµV)	Antenna Factor (dB/m)	Cable Loss (dB)	Preamp Factor (dB)	Ant Pos (cm)	Table Pos (deg)	Peak Avg. (P/A)	Pol. (H/V)
BLE CH 00 2402MHz		4804	43.84	-30.16	74	56.02	31.42	7.58	51.18	100	0	P	H
													H
													H
													H
		4804	42.73	-31.27	74	54.91	31.42	7.58	51.18	100	0	P	V
													V
													V
BLE CH 19 2440MHz		4880	43.55	-30.45	74	55.44	31.56	7.7	51.15	100	0	P	H
		7320	41.67	-32.33	74	46.76	36.22	9.49	50.8	100	0	P	H
													H
													H
		4880	41.15	-32.85	74	53.04	31.56	7.7	51.15	100	0	P	V
		7320	42.41	-31.59	74	47.5	36.22	9.49	50.8	100	0	P	V
													V
BLE CH 39 2480MHz		4960	42.83	-31.17	74	54.29	31.73	7.93	51.12	100	0	P	H
		7440	42.4	-31.6	74	47.1	36.49	9.61	50.8	100	0	P	H
													H
													H
		4960	41.3	-32.7	74	52.76	31.73	7.93	51.12	100	0	P	V
		7440	42.56	-31.44	74	47.26	36.49	9.61	50.8	100	0	P	V
													V
Remark	1. No other spurious found.												
	2. All results are PASS against Peak and Average limit line.												



Emission below 1GHz

2.4GHz BLE (LF)

BLE	Note	Frequency	Level	Over	Limit	Read	Antenna	Cable	Preamp	Ant	Table	Peak	Pol.	
		(MHz)	(dBμV/m)	(dB)	(dBμV/m)	(dBμV)	(dB/m)	(dB)	(dB)	(cm)	(deg)	(P/A)	(H/V)	
2.4GHz BLE LF		65.91	28.67	-11.33	40	48.11	12.36	0.93	32.73	100	23	P	H	
		100.2	25.08	-18.42	43.5	40.17	16.4	1.14	32.63	-	-	P	H	
		271.92	21.26	-24.74	46	32.85	19.38	1.76	32.73	-	-	P	H	
		505.8	26.11	-19.89	46	32.47	24.24	2.33	32.93	-	-	P	H	
		720	28.23	-17.77	46	31.61	26.77	2.82	32.97	-	-	P	H	
		951	31.29	-14.71	46	29.75	30	3.29	31.75	-	-	P	H	
														H
														H
														H
														H
														H
														H
			41.88	28.58	-11.42	40	41.35	19.38	0.65	32.8	100	12	P	V
			167.97	22.7	-20.8	43.5	37.56	16.36	1.48	32.7	-	-	P	V
			259.23	22.76	-23.24	46	34.03	19.7	1.76	32.73	-	-	P	V
			521.9	27.5	-18.5	46	33.78	24.33	2.33	32.94	-	-	P	V
			747.3	28.75	-17.25	46	31.35	27.43	2.91	32.94	-	-	P	V
			956.6	31.8	-14.2	46	30.19	30	3.29	31.68	-	-	P	V
														V
														V
													V	
													V	
													V	
													V	
Remark	1. No other spurious found. 2. All results are PASS against limit line.													



Note symbol

*	Fundamental Frequency which can be ignored. However, the level of any unwanted emissions shall not exceed the level of the fundamental frequency.
!	Test result is over limit line.
P/A	Peak or Average
H/V	Horizontal or Vertical



A calculation example for radiated spurious emission is shown as below:

WIFI	Note	Frequency	Level	Over	Limit	Read	Antenna	Cable	Preamp	Ant	Table	Peak	Pol.
Ant.				Limit	Line	Level	Factor	Loss	Factor	Pos	Pos	Avg.	
1+2		(MHz)	(dBμV/m)	(dB)	(dBμV/m)	(dBμV)	(dB/m)	(dB)	(dB)	(cm)	(deg)	(P/A)	(H/V)
802.11b		2390	55.45	-18.55	74	54.51	32.22	4.58	35.86	103	308	P	H
CH 01													
2412MHz		2390	43.54	-10.46	54	42.6	32.22	4.58	35.86	103	308	A	H

- Level(dBμV/m) =
Antenna Factor(dB/m) + Cable Loss(dB) + Read Level(dBμV) - Preamp Factor(dB)
- Over Limit(dB) = Level(dBμV/m) – Limit Line(dBμV/m)

For Peak Limit @ 2390MHz:

- Level(dBμV/m)
= Antenna Factor(dB/m) + Cable Loss(dB) + Read Level(dBμV) - Preamp Factor(dB)
= 32.22(dB/m) + 4.58(dB) + 54.51(dBμV) – 35.86 (dB)
= 55.45 (dBμV/m)
- Over Limit(dB)
= Level(dBμV/m) – Limit Line(dBμV/m)
= 55.45(dBμV/m) – 74(dBμV/m)
= -18.55(dB)

For Average Limit @ 2390MHz:

- Level(dBμV/m)
= Antenna Factor(dB/m) + Cable Loss(dB) + Read Level(dBμV) - Preamp Factor(dB)
= 32.22(dB/m) + 4.58(dB) + 42.6(dBμV) – 35.86 (dB)
= 43.54 (dBμV/m)
- Over Limit(dB)
= Level(dBμV/m) – Limit Line(dBμV/m)
= 43.54(dBμV/m) – 54(dBμV/m)
= -10.46(dB)

Both peak and average measured complies with the limit line, so test result is “PASS”.



Appendix C. Radiated Spurious Emission

Test Engineer :	Wilson Wu	Temperature :	24~25°C
		Relative Humidity :	50~52%

Note symbol

-L	Low channel location
-R	High channel location



2.4GHz 2400~2483.5MHz

BLE (Band Edge @ 3m)

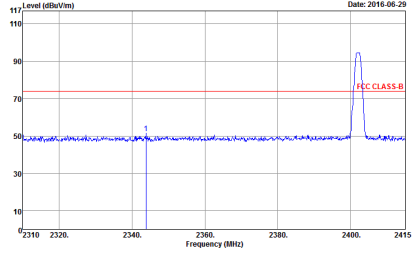
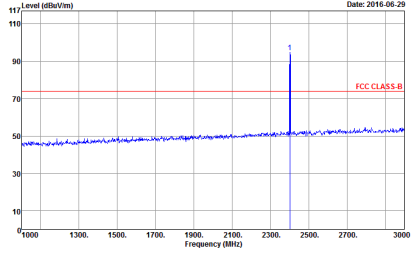
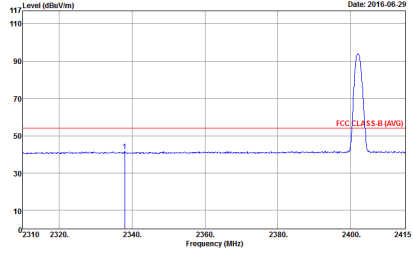
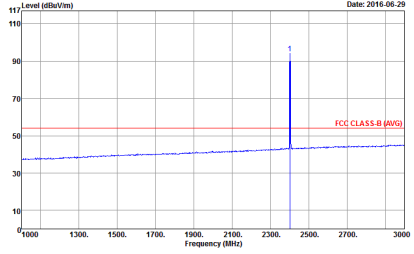
BLE	2.4GHz 2400~2483.5MHz Band Edge @ 3m	
ANT	BLE CH00 2402MHz	
1	Horizontal	Fundamental
Peak	 <p>Site : 03CH10-HY Condition : FCC CLASS-B 3m HORN 9120D-HF HORIZONTAL RBW:1000.000KHz VBW:3000.000KHz SWT:Auto Detector : Peak Project : 660109 Mode : 1</p>	 <p>Site : 03CH10-HY Condition : FCC CLASS-B 3m HORN 9120D-HF HORIZONTAL RBW:1000.000KHz VBW:3000.000KHz SWT:Auto Detector : Peak Project : 660109 Mode : 1</p>
Avg.	 <p>Site : 03CH10-HY Condition : FCC CLASS-B (AVG) 3m HORN 9120D-HF HORIZONTAL RBW:1000.000KHz VBW:3.000KHz SWT:Auto Detector : Peak Project : 660109 Mode : 1</p>	 <p>Site : 03CH10-HY Condition : FCC CLASS-B (AVG) 3m HORN 9120D-HF HORIZONTAL RBW:1000.000KHz VBW:3.000KHz SWT:Auto Detector : Peak Project : 660109 Mode : 1</p>

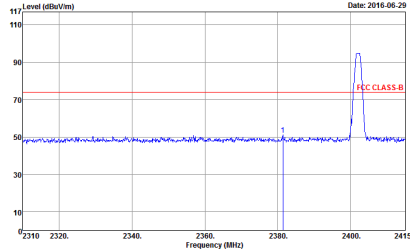
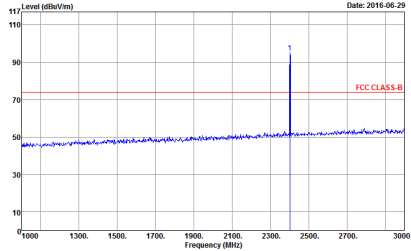
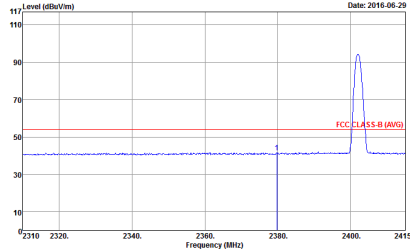
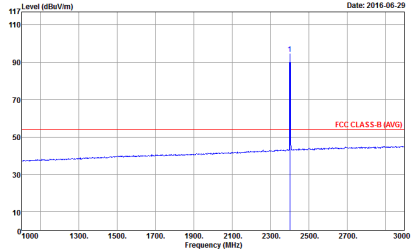

BLE	2.4GHz 2400~2483.5MHz Band Edge @ 3m	
ANT	BLE CH00 2402MHz	
1	Vertical	Fundamental
Peak	 <p>Site : 03CH10-HY Condition : FCC CLASS-B 3m HORN 9120D-HF VERTICAL RBW:1000.000KHz VBW:3000.000KHz SWT:Auto Detector : Peak Project : 660109 Mode : 1</p>	 <p>Site : 03CH10-HY Condition : FCC CLASS-B 3m HORN 9120D-HF VERTICAL RBW:1000.000KHz VBW:3000.000KHz SWT:Auto Detector : Peak Project : 660109 Mode : 1</p>
Avg	 <p>Site : 03CH10-HY Condition : FCC CLASS-B (AVG) 3m HORN 9120D-HF VERTICAL RBW:1000.000KHz VBW:3.000KHz SWT:Auto Detector : Peak Project : 660109 Mode : 1</p>	 <p>Site : 03CH10-HY Condition : FCC CLASS-B (AVG) 3m HORN 9120D-HF VERTICAL RBW:1000.000KHz VBW:3.000KHz SWT:Auto Detector : Peak Project : 660109 Mode : 1</p>

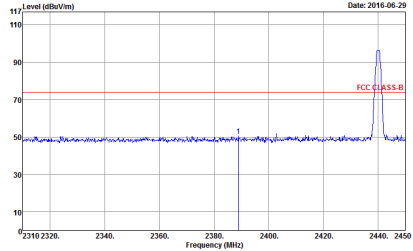
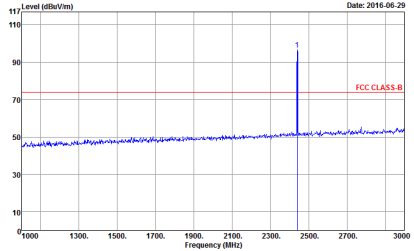
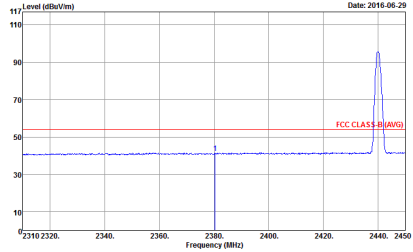
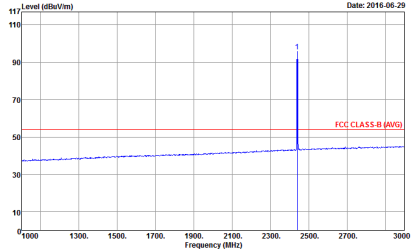

BLE	2.4GHz 2400~2483.5MHz Band Edge @ 3m	
ANT	BLE CH19 2440MHz - L	
1	Horizontal	Fundamental
Peak	 <p>Date: 2016-06-29</p> <p>Site : 03CH10-HY Condition : FCC CLASS-B 3m HORN 9120D-HF HORIZONTAL RBW:1000.000KHz VBW:3000.000KHz SWT:Auto Detector : Peak Project : 660109 Mode : 2</p>	 <p>Date: 2016-06-29</p> <p>Site : 03CH10-HY Condition : FCC CLASS-B 3m HORN 9120D-HF HORIZONTAL RBW:1000.000KHz VBW:3000.000KHz SWT:Auto Detector : Peak Project : 660109 Mode : 2</p>
Avg.	 <p>Date: 2016-06-29</p> <p>Site : 03CH10-HY Condition : FCC CLASS-B (AVG) 3m HORN 9120D-HF HORIZONTAL RBW:1000.000KHz VBW:3.000KHz SWT:Auto Detector : Peak Project : 660109 Mode : 2</p>	 <p>Date: 2016-06-29</p> <p>Site : 03CH10-HY Condition : FCC CLASS-B (AVG) 3m HORN 9120D-HF HORIZONTAL RBW:1000.000KHz VBW:3.000KHz SWT:Auto Detector : Peak Project : 660109 Mode : 2</p>

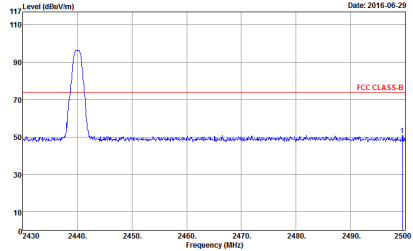
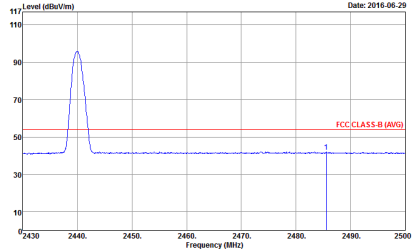

BLE	2.4GHz 2400~2483.5MHz Band Edge @ 3m	
ANT	BLE CH19 2440MHz - R	
1	Horizontal	Fundamental
<p>Peak</p>	 <p>Site : 03CH10-HY Condition : FCC CLASS-B 3m HORN 9120D-HF HORIZONTAL RBW:1000.000KHz VBW:3000.000KHz SWT:Auto Detector : Peak Project : 660109 Mode : 2</p>	<p>Left blank</p>
<p>Avg.</p>	 <p>Site : 03CH10-HY Condition : FCC CLASS-B (AVG) 3m HORN 9120D-HF HORIZONTAL RBW:1000.000KHz VBW:3.000KHz SWT:Auto Detector : Peak Project : 660109 Mode : 2</p>	<p>Left blank</p>

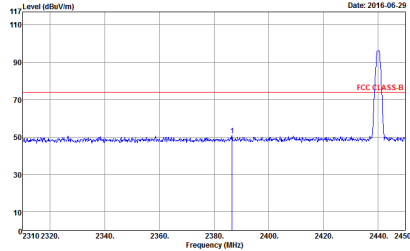
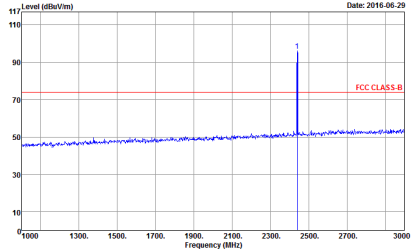
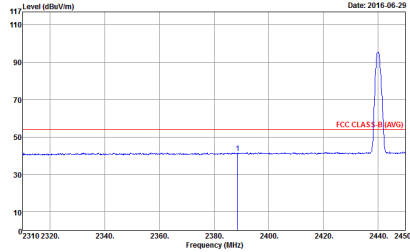
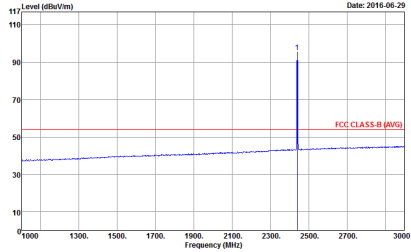

BLE	2.4GHz 2400~2483.5MHz Band Edge @ 3m	
ANT	BLE CH19 2440MHz - L	
1	<p style="text-align: center;">Vertical</p>  <p>Site : 03CH10-#Y Condition : FCC CLASS-B 3m HORN 9120D-HF VERTICAL RBW:1000.000KHz VBW:3000.000KHz SWT:Auto Detector : Peak Project : 660109 Mode : 2</p>	<p style="text-align: center;">Fundamental</p>  <p>Site : 03CH10-#Y Condition : FCC CLASS-B 3m HORN 9120D-HF VERTICAL RBW:1000.000KHz VBW:3000.000KHz SWT:Auto Detector : Peak Project : 660109 Mode : 2</p>
Peak	 <p>Site : 03CH10-#Y Condition : FCC CLASS-B (AVG) 3m HORN 9120D-HF VERTICAL RBW:1000.000KHz VBW:3.000KHz SWT:Auto Detector : Peak Project : 660109 Mode : 2</p>	 <p>Site : 03CH10-#Y Condition : FCC CLASS-B (AVG) 3m HORN 9120D-HF VERTICAL RBW:1000.000KHz VBW:3.000KHz SWT:Auto Detector : Peak Project : 660109 Mode : 2</p>
Avg.		

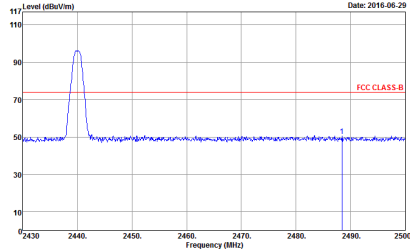
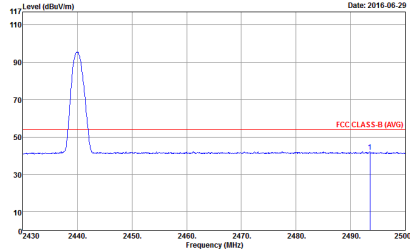

BLE	2.4GHz 2400~2483.5MHz Band Edge @ 3m	
ANT	BLE CH19 2440MHz - R	
1	Vertical	Fundamental
Peak	 <p>Date: 2016-06-29</p> <p>Site : 03CH10-HY Condition : FCC CLASS-B 3m HORN 9120D-HF VERTICAL RBW:1000.000KHz VBW:3000.000KHz SWT:Auto Detector : Peak Project : 660109 Mode : 2</p>	Left blank
Avg.	 <p>Date: 2016-06-29</p> <p>Site : 03CH10-HY Condition : FCC CLASS-B (AVG) 3m HORN 9120D-HF VERTICAL RBW:1000.000KHz VBW:3.000KHz SWT:Auto Detector : Peak Project : 660109 Mode : 2</p>	Left blank

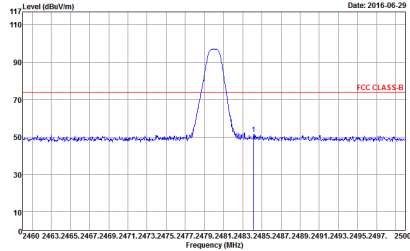
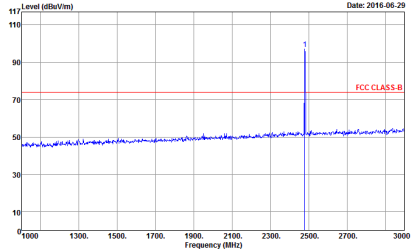
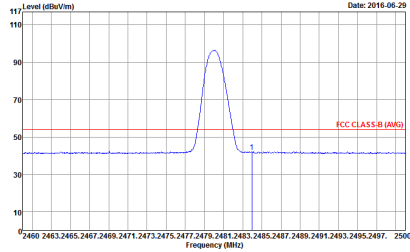
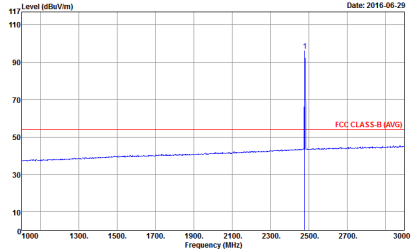

BLE	2.4GHz 2400~2483.5MHz Band Edge @ 3m	
ANT	BLE CH39 2480MHz	
1	Horizontal	Fundamental
Peak	 <p>Site : 03CH10-#Y Condition : FCC CLASS-B 3m HORN 9120D-HF HORIZONTAL RBW:1000.000KHz VBW:3000.000KHz SWT:Auto Detector : Peak Project : 660109 Mode : 3</p>	 <p>Site : 03CH10-#Y Condition : FCC CLASS-B 3m HORN 9120D-HF HORIZONTAL RBW:1000.000KHz VBW:3000.000KHz SWT:Auto Detector : Peak Project : 660109 Mode : 3</p>
Avg.	 <p>Site : 03CH10-#Y Condition : FCC CLASS-B (AVG) 3m HORN 9120D-HF HORIZONTAL RBW:1000.000KHz VBW:3.000KHz SWT:Auto Detector : Peak Project : 660109 Mode : 3</p>	 <p>Site : 03CH10-#Y Condition : FCC CLASS-B (AVG) 3m HORN 9120D-HF HORIZONTAL RBW:1000.000KHz VBW:3.000KHz SWT:Auto Detector : Peak Project : 660109 Mode : 3</p>

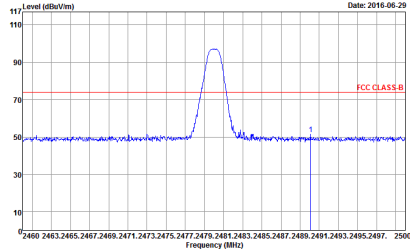
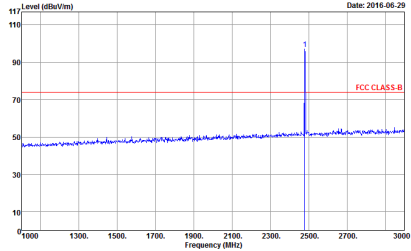
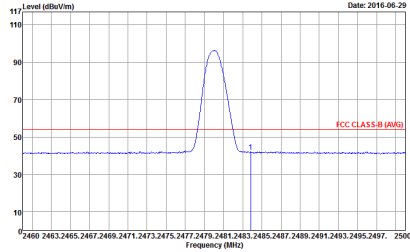
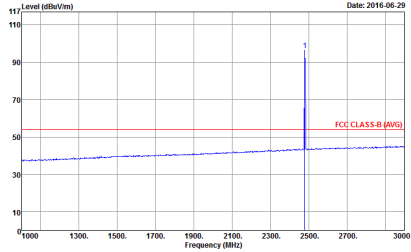

BLE	2.4GHz 2400~2483.5MHz Band Edge @ 3m	
ANT	BLE CH39 2480MHz	
1	Vertical	Fundamental
Peak	 <p>Site : 03CH10-#Y Condition : FCC CLASS-B 3m HORN 9120D-HF VERTICAL RBW:1000.000KHz VBW:3000.000KHz SWT:Auto Detector : Peak Project : 660109 Mode : 3</p>	 <p>Site : 03CH10-#Y Condition : FCC CLASS-B 3m HORN 9120D-HF VERTICAL RBW:1000.000KHz VBW:3000.000KHz SWT:Auto Detector : Peak Project : 660109 Mode : 3</p>
Avg.	 <p>Site : 03CH10-#Y Condition : FCC CLASS-B (AVG) 3m HORN 9120D-HF VERTICAL RBW:1000.000KHz VBW:3.000KHz SWT:Auto Detector : Peak Project : 660109 Mode : 3</p>	 <p>Site : 03CH10-#Y Condition : FCC CLASS-B (AVG) 3m HORN 9120D-HF VERTICAL RBW:1000.000KHz VBW:3.000KHz SWT:Auto Detector : Peak Project : 660109 Mode : 3</p>



2.4GHz 2400~2483.5MHz

BLE (Harmonic @ 3m)

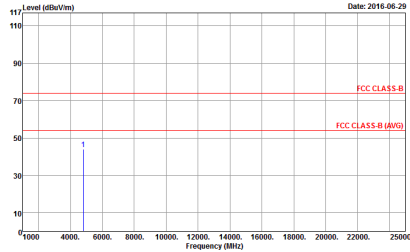
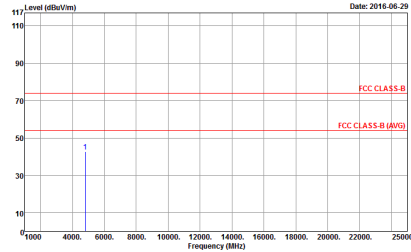
BLE	2.4GHz 2400~2483.5MHz Harmonic @ 3m	
ANT	BLE CH00 2402MHz	
1	Horizontal	Vertical
Peak Avg.	 <p>Date: 2016-06-29</p> <p>Site : 03CH10-#Y Condition : FCC CLASS-B 3m HORN_9170_406_0584 HORIZONTAL Detector : Peak Project : 660109 Mode : 1</p>	 <p>Date: 2016-06-29</p> <p>Site : 03CH10-#Y Condition : FCC CLASS-B 3m HORN_9170_406_0584 VERTICAL Detector : Peak Project : 660109 Mode : 1</p>



BLE	2.4GHz 2400~2483.5MHz Harmonic @ 3m	
ANT	BLE CH19 2440MHz	
1	Horizontal	Vertical
Peak Avg.	<p>Site : 03CH10-#Y Condition : FCC CLASS-B 3m HORN_9170_406_0584 HORIZONTAL Detector : Peak Project : 660109 Mode : 2</p>	<p>Site : 03CH10-#Y Condition : FCC CLASS-B 3m HORN_9170_406_0584 VERTICAL Detector : Peak Project : 660109 Mode : 2</p>



BLE	2.4GHz 2400~2483.5MHz Harmonic @ 3m	
ANT	BLE CH39 2480MHz	
1	Horizontal	Vertical
Peak	<p>Site : 03CH10-#Y Condition : FCC CLASS-B 3m HORN_9170_406_0584 HORIZONTAL Detector : Peak Project : 660109 Mode : 3</p>	<p>Site : 03CH10-#Y Condition : FCC CLASS-B 3m HORN_9170_406_0584 VERTICAL Detector : Peak Project : 660109 Mode : 3</p>



Emission below 1GHz

2.4GHz BLE (LF)

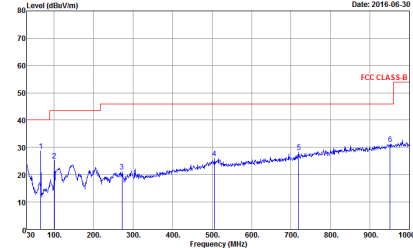
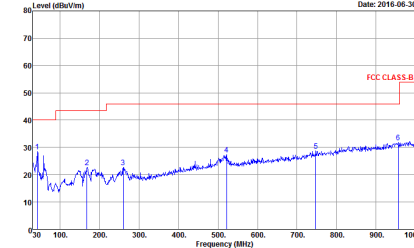
BLE	2.4GHz 2400~2483.5MHz	
ANT	BLE LF	
1	Horizontal	Vertical
QP / Peak	 <p>Site : 03CH10-HY Condition : FCC CLASS-B 3m BT-LOG 6111D-LF HORIZONTAL Detector : Peak Project : 660109 Mode : 4</p>	 <p>Site : 03CH10-HY Condition : FCC CLASS-B 3m BT-LOG 6111D-LF VERTICAL Detector : Peak Project : 660109 Mode : 4</p>



Appendix D. Duty Cycle Plots

Band	Duty Cycle(%)	T(us)	1/T(kHz)	VBW Setting
Bluetooth 4.0 – LE	61.78	388	2.58	3kHz

Bluetooth 4.0 – LE

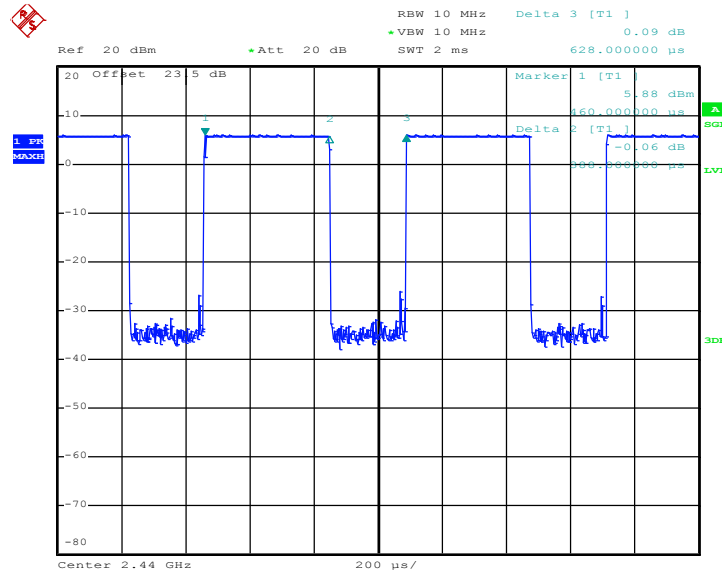

Date: 7.JUN.2016 21:40:51