



FCC RF Test Report

APPLICANT : Getac Technology Corporation.
EQUIPMENT : Body Worn Camera
BRAND NAME : Getac
MODEL NAME : Veretos BC-02
FCC ID : QYLBWC2
STANDARD : FCC Part 15 Subpart C §15.247
CLASSIFICATION : (DTS) Digital Transmission System

The product was received on May 17, 2016 and testing was completed on Jul. 05, 2016. We, SPORTON INTERNATIONAL INC., would like to declare that the tested sample has been evaluated in accordance with the test procedures and has been in compliance with the applicable technical standards.

The test results in this report apply exclusively to the tested model / sample. Without written approval of SPORTON INTERNATIONAL INC., the test report shall not be reproduced except in full.

Reviewed by: Joseph Lin / Supervisor

Approved by: Jones Tsai / Manager



SPORTON INTERNATIONAL INC.

No. 52, Hwa Ya 1st Rd., Hwa Ya Technology Park, Kwei-Shan District, Tao Yuan City, Taiwan, R.O.C.



TABLE OF CONTENTS

REVISION HISTORY..... 3

SUMMARY OF TEST RESULT 4

1 GENERAL DESCRIPTION 5

 1.1 Applicant 5

 1.2 Manufacturer 5

 1.3 Product Feature of Equipment Under Test..... 5

 1.4 Product Specification of Equipment Under Test..... 5

 1.5 Modification of EUT 5

 1.6 Testing Location 6

 1.7 Applicable Standards 6

2 TEST CONFIGURATION OF EQUIPMENT UNDER TEST 7

 2.1 Carrier Frequency Channel 7

 2.2 Pre-Scanned RF Power 7

 2.3 Test Mode 8

 2.4 Connection Diagram of Test System 9

 2.5 Support Unit used in test configuration and system 9

 2.6 EUT Operation Test Setup 10

 2.7 Measurement Results Explanation Example 10

3 TEST RESULT 11

 3.1 6dB and 99% Bandwidth Measurement 11

 3.2 Output Power Measurement 13

 3.3 Power Spectral Density Measurement 14

 3.4 Conducted Band Edges and Spurious Emission Measurement 16

 3.5 Radiated Band Edges and Spurious Emission Measurement 26

 3.6 AC Conducted Emission Measurement 30

 3.7 Antenna Requirements 34

4 LIST OF MEASURING EQUIPMENT 35

5 UNCERTAINTY OF EVALUATION 36

APPENDIX A. CONDUCTED TEST RESULTS

APPENDIX B. RADIATED SPURIOUS EMISSION

APPENDIX C. RADIATED SPURIOUS EMISSION PLOTS

APPENDIX D. DUTY CYCLE PLOTS

APPENDIX E. SETUP PHOTOGRAPHS



REVISION HISTORY

REPORT NO.	VERSION	DESCRIPTION	ISSUED DATE
FR660109B	Rev. 01	Initial issue of report	Aug. 10, 2016



SUMMARY OF TEST RESULT

Report Section	FCC Rule	Description	Limit	Result	Remark
3.1	15.247(a)(2)	6dB Bandwidth	$\geq 0.5\text{MHz}$	Pass	-
3.1	-	99% Bandwidth	-	Pass	-
3.2	15.247(b)	Power Output Measurement	$\leq 30\text{dBm}$	Pass	-
3.3	15.247(e)	Power Spectral Density	$\leq 8\text{dBm}/3\text{kHz}$	Pass	-
3.4	15.247(d)	Conducted Band Edges	$\leq 20\text{dBc}$	Pass	-
		Conducted Spurious Emission		Pass	-
3.5	15.247(d)	Radiated Band Edges and Radiated Spurious Emission	15.209(a) & 15.247(d)	Pass	Under limit 3.94 dB at 2484.760 MHz
3.6	15.207	AC Conducted Emission	15.207(a)	Pass	Under limit 19.90 dB at 0.158 MHz
3.7	15.203 & 15.247(b)	Antenna Requirement	N/A	Pass	-



1 General Description

1.1 Applicant

Getac Technology Corporation.

5F., Building A, No. 209, Sec.1, Nangang Rd.,Nangang Dist., Taipei City 11568, Taiwan, R.O.C.

1.2 Manufacturer

Ability Enterprise Co., Ltd.

4F., No.8, Lane7, Wuchiuan Rd, Wugu Dist., New Taipei City 24886, Taiwan, R.O.C.

1.3 Product Feature of Equipment Under Test

Product Feature	
Equipment	Body Worn Camera
Brand Name	Getac
Model Name	Veretos BC-02
FCC ID	QYLBWC2
EUT supports Radios application	WLAN 11b/g/n HT20 Bluetooth v4.0 LE
EUT Stage	Production Unit

Remark: The above EUT's information was declared by manufacturer. Please refer to the specifications or user's manual for more detailed description.

1.4 Product Specification of Equipment Under Test

Standards-related Product Specification	
Tx/Rx Channel Frequency Range	802.11b/g/n : 2412 MHz ~ 2462 MHz
Maximum (Peak) Output Power to Antenna	802.11b : 14.82 dBm (0.0303 W) 802.11g : 22.70 dBm (0.1862 W) 802.11n HT20 : 22.73 dBm (0.1875 W)
99% Occupied Bandwidth	802.11b : 14.15MHz 802.11g : 17.90MHz 802.11n HT20 : 18.70MHz
Antenna Type	802.11b/g/n : Chip Antenna type with gain 0.88 dBi
Type of Modulation	802.11b : DSSS (DBPSK / DQPSK / CCK) 802.11g/n : OFDM (BPSK / QPSK / 16QAM / 64QAM)

1.5 Modification of EUT

No modifications are made to the EUT during all test items.



1.6 Testing Location

Sporton Lab is accredited to ISO 17025 by Taiwan Accreditation Foundation (TAF code : 1190) and the FCC designation No. TW1022 under the FCC 2.948(e) by Mutual Recognition Agreement (MRA) in FCC Test.

Test Site	SPORTON INTERNATIONAL INC.	
Test Site Location	No. 52, Hwa Ya 1 st Rd., Hwa Ya Technology Park, Kwei-Shan District, Tao Yuan City, Taiwan, R.O.C. TEL: +886-3-327-3456 FAX: +886-3-328-4978	
Test Site No.	Sporton Site No.	
	TH02-HY	CO05-HY

Note: The test site complies with ANSI C63.4 2014 requirement.

Test Site	SPORTON INTERNATIONAL INC.	
Test Site Location	No.58, Aly. 75, Ln. 564, Wenhua 3rd Rd. Guishan Dist, Taoyuan City, Taiwan (R.O.C.) TEL: +886-3-327-0868 FAX: +886-3-327-0855	
Test Site No.	Sporton Site No.	
	03CH10-HY	

Note: The test site complies with ANSI C63.4 2014 requirement.

1.7 Applicable Standards

According to the specifications of the manufacturer, the EUT must comply with the requirements of the following standards:

- ♦ FCC Part 15 Subpart C §15.247
- ♦ FCC KDB Publication No. 558074 D01 DTS Meas. Guidance v03r05
- ♦ ANSI C63.10-2013

Remark:

1. All test items were verified and recorded according to the standards and without any deviation during the test.
2. This EUT has also been tested and complied with the requirements of FCC Part 15, Subpart B, recorded in a separate test report.



2 Test Configuration of Equipment Under Test

The EUT has been associated with peripherals and configuration operated in a manner tended to maximize its emission characteristics in a typical application. Frequency range investigated: conducted emission (150 kHz to 30 MHz) and radiated emission (9 kHz to the 10th harmonic of the highest fundamental frequency or to 40 GHz, whichever is lower). For radiated measurement, pre-scanned in three orthogonal panels, X, Y, Z. The worst cases (Y plane) were recorded in this report.

2.1 Carrier Frequency Channel

Frequency Band	Channel	Freq. (MHz)	Channel	Freq. (MHz)
2400-2483.5 MHz	1	2412	7	2442
	2	2417	8	2447
	3	2422	9	2452
	4	2427	10	2457
	5	2432	11	2462
	6	2437	-	-

2.2 Pre-Scanned RF Power

Preliminary tests were performed in different data rate and data rate associated with the highest power were chosen for full test shown in the following tables.

2.4GHz 802.11b mode				
Data Rate (MHz)	1M bps	2M bps	5.5M bps	11M bps
Peak Power (dBm)	14.26	14.51	14.51	14.82

2.4GHz 802.11g mode								
Data Rate (MHz)	6M bps	9M bps	12M bps	18M bps	24M bps	36M bps	48M bps	54M bps
Peak Power (dBm)	21.94	21.72	21.78	21.68	22.70	22.58	22.56	22.46

2.4GHz 802.11n HT20 mode								
Data Rate (MHz)	MCS0	MCS1	MCS2	MCS3	MCS4	MCS5	MCS6	MCS7
Peak Power (dBm)	22.06	22.03	21.74	22.73	22.60	22.57	22.53	22.60



2.3 Test Mode

Final test mode of conducted test items and radiated spurious emissions are considering the modulation and worse data rates from the power table described in section 2.2.

<2.4GHz>

Modulation	Data Rate
802.11b	11 Mbps
802.11g	24 Mbps
802.11n HT20	MCS3

Test Cases	
AC Conducted Emission	Mode 1: BT LE Tx + EUT with Docking + USB Cable (Charging from Adapter)
	Mode 2: WLAN Tx + EUT with Docking + USB Cable (Charging from Adapter)
Remark: The worst case of conducted emission is mode 1; only the test data of it was reported.	

2.4 Connection Diagram of Test System

<WLAN Tx Mode>

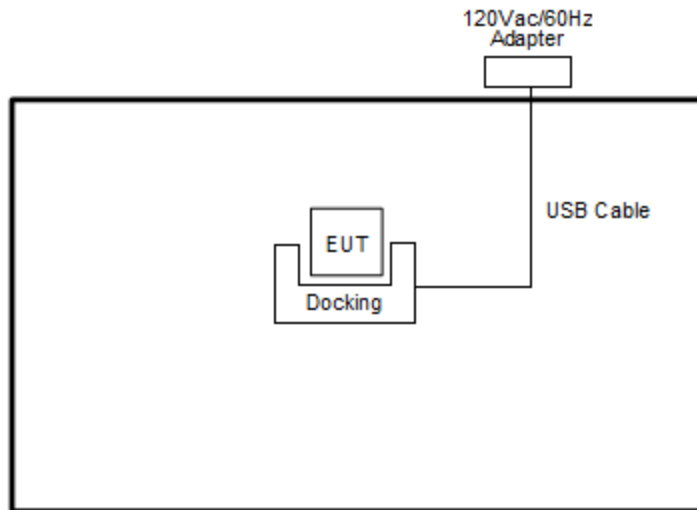

<AC Conducted Emission Mode>

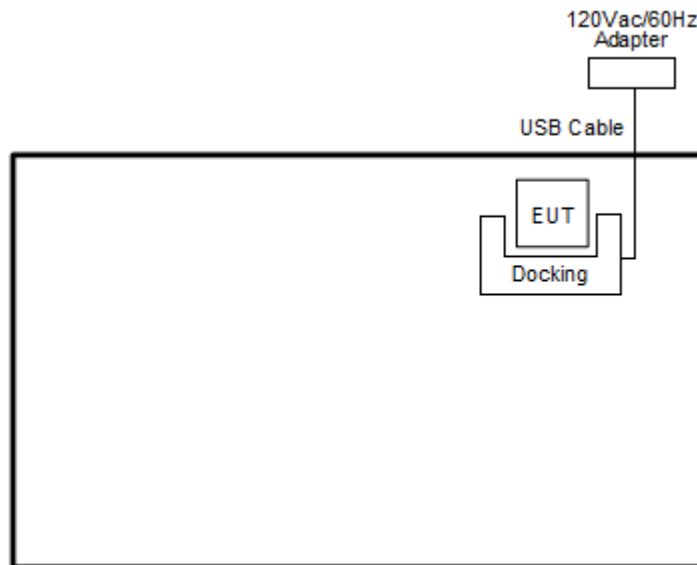

2.5 Support Unit used in test configuration and system

Item	Equipment	Trade Name	Model Name	FCC ID	Data Cable	Power Cord
1.	Docking	Getac	N/A	N/A	N/A	Unshielded, 1.1 m
2.	Adapter	TPC	NSS050200B	N/A	N/A	N/A



2.6 EUT Operation Test Setup

The programmed RF utility “Sample_Project”, is installed in EUT to provide channel selection, power level, data rate and the application type. RF Utility can send transmitting signal for all testing. The RF output power selection is for the setting of RF output power expected by the customer and is going to be fixed on the firmware of the final end product.

2.7 Measurement Results Explanation Example

For all conducted test items:

The offset level is set in the spectrum analyzer to compensate the RF cable loss and attenuator factor between EUT conducted output port and spectrum analyzer. With the offset compensation, the spectrum analyzer reading level is exactly the EUT RF output level.

Example :

The spectrum analyzer offset is derived from RF cable loss and attenuator factor.

Offset = RF cable loss + attenuator factor.

Following shows an offset computation example with cable loss 4.2 dB and 10dB attenuator.

$$\begin{aligned} \text{Offset(dB)} &= \text{RF cable loss(dB)} + \text{attenuator factor(dB)}. \\ &= 4.2 + 10 = 14.2 \text{ (dB)} \end{aligned}$$

3 Test Result

3.1 6dB and 99% Bandwidth Measurement

3.1.1 Limit of 6dB and 99% Bandwidth

The minimum 6 dB bandwidth shall be at least 500 kHz.

3.1.2 Measuring Instruments

The measuring equipment is listed in the section 4 of this test report.

3.1.3 Test Procedures

1. The testing follows FCC KDB Publication No. 558074 DTS D01 Meas. Guidance v03r05.
2. The RF output of EUT was connected to the spectrum analyzer by RF cable and attenuator. The path loss was compensated to the results for each measurement.
3. Set to the maximum power setting and enable the EUT transmit continuously.
4. Make the measurement with the spectrum analyzer's resolution bandwidth (RBW) = 100 kHz. Set the Video bandwidth (VBW) = 300 kHz. In order to make an accurate measurement. The 6 dB bandwidth must be greater than 500 kHz.
5. For 99% Bandwidth Measurement, the spectrum analyzer's resolution bandwidth (RBW) = 1MHz and set the Video bandwidth (VBW) = 3MHz.
6. Measure and record the results in the test report.

3.1.4 Test Setup





3.1.5 Test Result of 6dB and 99% Occupied Bandwidth

Please refer to Appendix A of this test report.

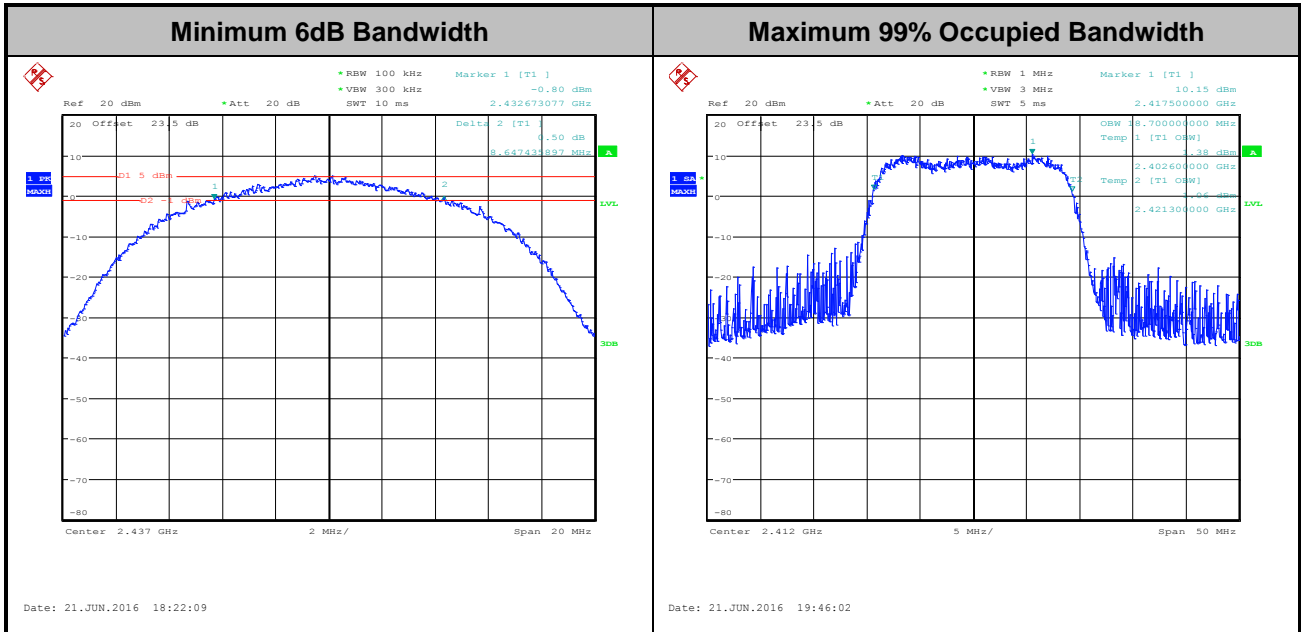

Note : The occupied channel bandwidth is maintained within the band of operation for all of the modulations.

3.2 Output Power Measurement

3.2.1 Limit of Output Power

For systems using digital modulation in the 2400-2483.5MHz, the limit for peak output power is 30dBm. If transmitting Antenna of directional gain greater than 6dBi are used the peak output power from the intentional radiator shall be reduced below the above stated value by the amount in dB that the directional gain of the Antenna exceeds 6 dBi. In case of point-to-point operation, the limit has to be reduced by 1dB for every 3dB that the directional gain of the Antenna exceeds 6dBi.

3.2.2 Measuring Instruments

The measuring equipment is listed in the section 4 of this test report.

3.2.3 Test Procedures

1. The testing follows the Measurement Procedure of FCC KDB No. 558074 DTS D01 Meas. Guidance v03r05 section 9.1.2 PKPM1 Peak power meter method.
2. The RF output of EUT was connected to the power meter by RF cable and attenuator. The path loss was compensated to the results for each measurement.
3. Set to the maximum power setting and enable the EUT transmit continuously.
4. Measure the conducted output power and record the results in the test report.

3.2.4 Test Setup

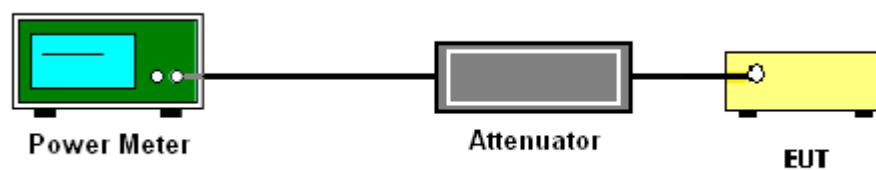

3.2.5 Test Result of Peak Output Power

Please refer to Appendix A of this test report.

3.2.6 Test Result of Average output Power (Reporting Only)

Please refer to Appendix A of this test report.

3.3 Power Spectral Density Measurement

3.3.1 Limit of Power Spectral Density

The peak power spectral density shall not be greater than 8dBm in any 3kHz band at any time interval of continuous transmission.

3.3.2 Measuring Instruments

The measuring equipment is listed in the section 4 of this test report.

3.3.3 Test Procedures

1. The testing follows Measurement Procedure 10.2 Method PKPSD of FCC KDB Publication No. 558074 D01 DTS Meas. Guidance v03r05
2. The RF output of EUT was connected to the spectrum analyzer by RF cable and attenuator. The path loss was compensated to the results for each measurement.
3. Set to the maximum power setting and enable the EUT transmit continuously.
4. Make the measurement with the spectrum analyzer's resolution bandwidth (RBW) = 3 kHz. Video bandwidth VBW = 10 kHz In order to make an accurate measurement, set the span to 1.5 times DTS Channel Bandwidth. (6dB BW)
5. Detector = peak, Sweep time = auto couple, Trace mode = max hold, Allow trace to fully stabilize. Use the peak marker function to determine the maximum power level.
6. Measure and record the results in the test report.

3.3.4 Test Setup





3.3.5 Test Result of Power Spectral Density

Please refer to Appendix A of this test report.

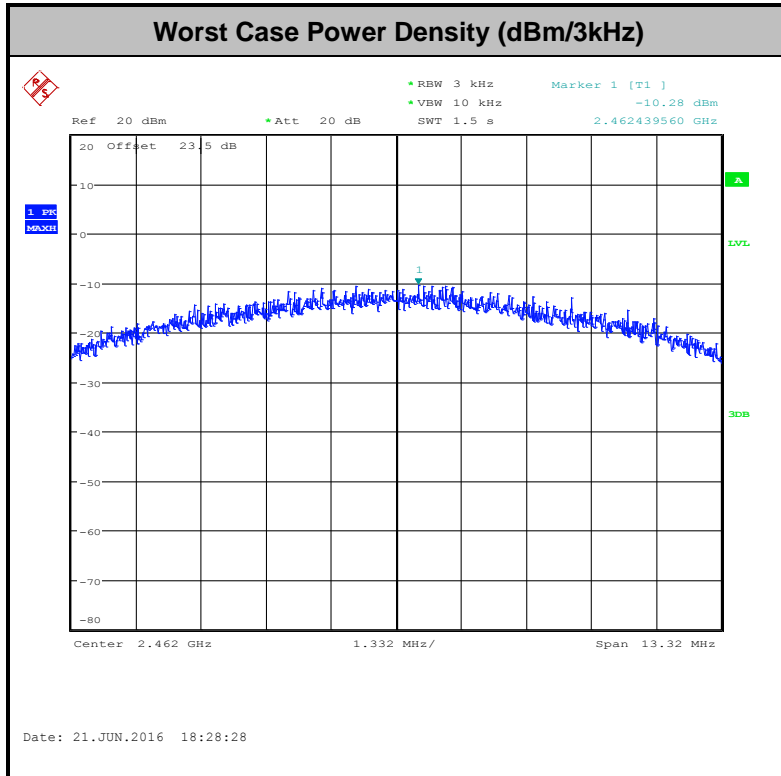

3.4 Conducted Band Edges and Spurious Emission Measurement

3.4.1 Limit of Conducted Band Edges and Spurious Emission Measurement

In any 100 kHz bandwidth outside of the authorized frequency band, the emissions which fall in the non-restricted bands shall be attenuated at least 20 dB / 30dB relative to the maximum PSD level in 100 kHz by RF conducted measurement and radiated emissions which fall in the restricted bands, as defined in Section 15.205(a), must also comply with the radiated emission limits specified in Section 15.209(a).

3.4.2 Measuring Instruments

The measuring equipment is listed in the section 4 of this test report.

3.4.3 Test Procedures

1. The testing follows FCC KDB Publication No. 558074 D01 DTS Meas. Guidance v03r05.
2. The RF output of EUT was connected to the spectrum analyzer by RF cable and attenuator. The path loss was compensated to the results for each measurement.
3. Set to the maximum power setting and enable the EUT transmit continuously.
4. Set RBW = 100 kHz, VBW=300 kHz, Peak Detector. Unwanted Emissions measured in any 100 kHz bandwidth outside of the authorized frequency band shall be attenuated by at least 20 dB relative to the maximum in-band peak PSD level in 100 kHz when maximum peak conducted output power procedure is used. If the transmitter complies with the conducted power limits based on the use of RMS averaging over a time interval, the attenuation required under this paragraph shall be 30 dB instead of 20 dB per 15.247(d).
5. Measure and record the results in the test report.
6. The RF fundamental frequency should be excluded against the limit line in the operating frequency band.

3.4.4 Test Setup

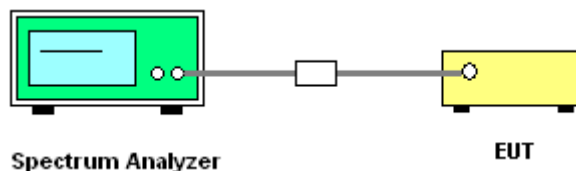



3.4.5 Test Result of Conducted Band Edges and Spurious Emission

Test Mode :	802.11b	Temperature :	21~25°C
Test Band :	2.4GHz Low	Relative Humidity :	51~54%
Test Channel :	01	Test Engineer :	PH Yang

WLAN 802.11b Channel 01

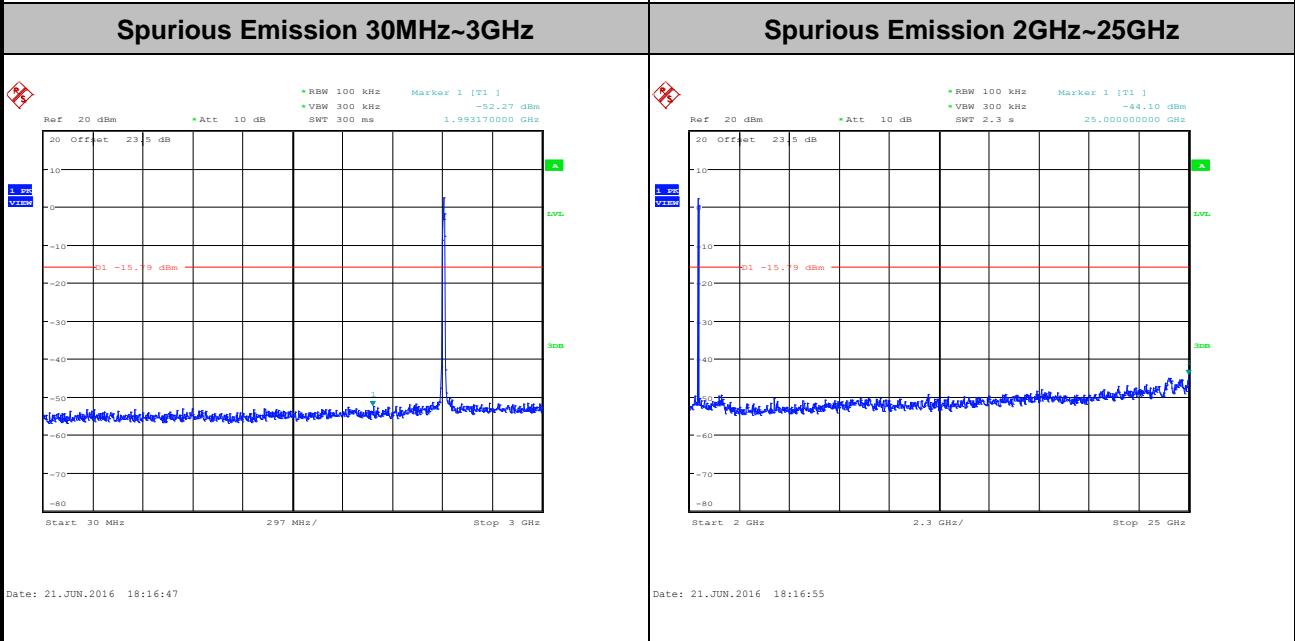
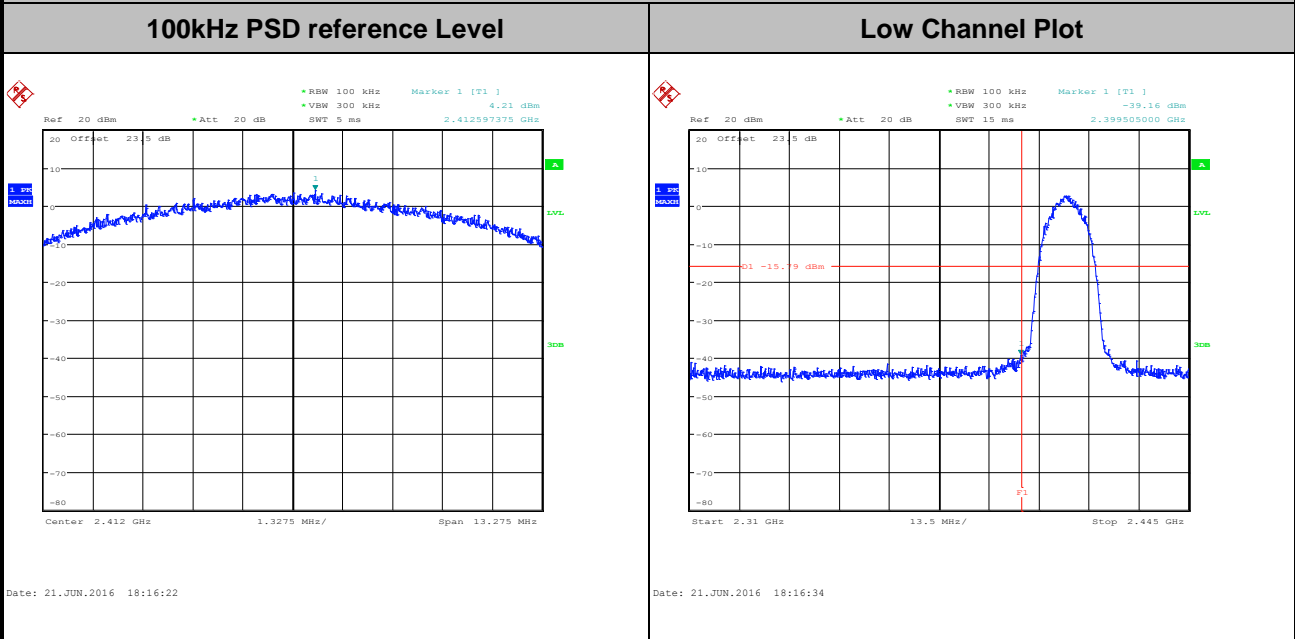



Test Mode :	802.11b	Temperature :	21~25°C
Test Band :	2.4GHz Mid	Relative Humidity :	51~54%
Test Channel :	06	Test Engineer :	PH Yang

WLAN 802.11b Channel 06

100kHz PSD reference Level

Mid Channel Plot

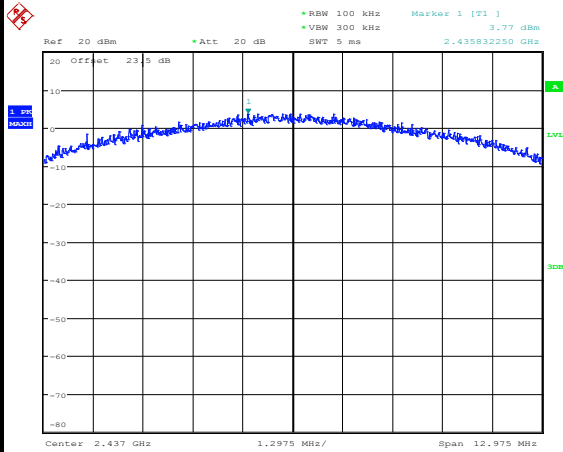

Date: 21.JUN.2016 18:23:06

Spurious Emission 30MHz~3GHz

Spurious Emission 2GHz~25GHz

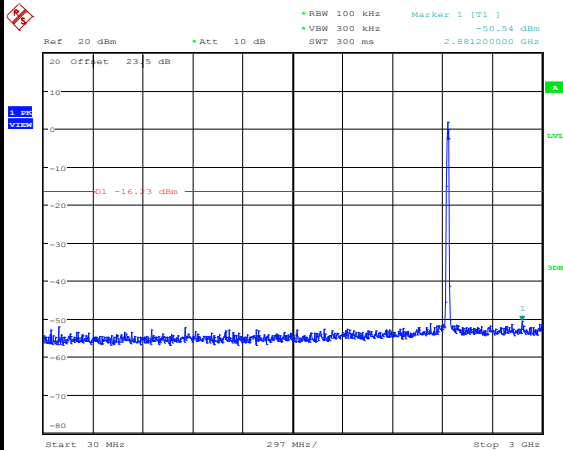

Date: 21.JUN.2016 18:23:40

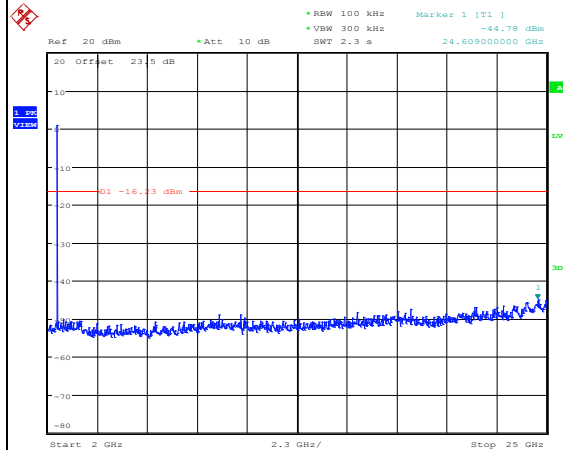

Date: 21.JUN.2016 18:23:48



Test Mode :	802.11b	Temperature :	21~25°C
Test Band :	2.4GHz High	Relative Humidity :	51~54%
Test Channel :	11	Test Engineer :	PH Yang

WLAN 802.11b Channel 11

100kHz PSD reference Level

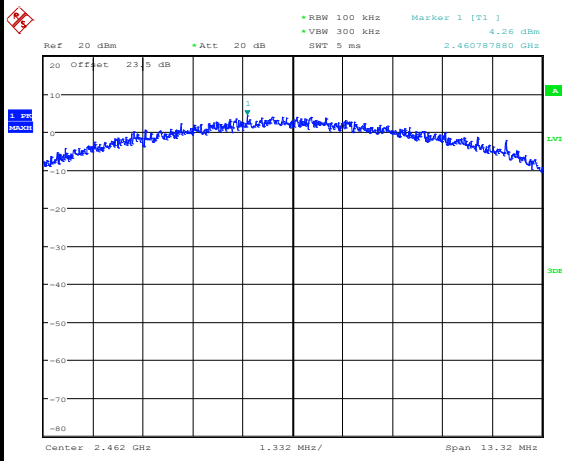

Date: 21.JUN.2016 18:28:49

High Channel Plot

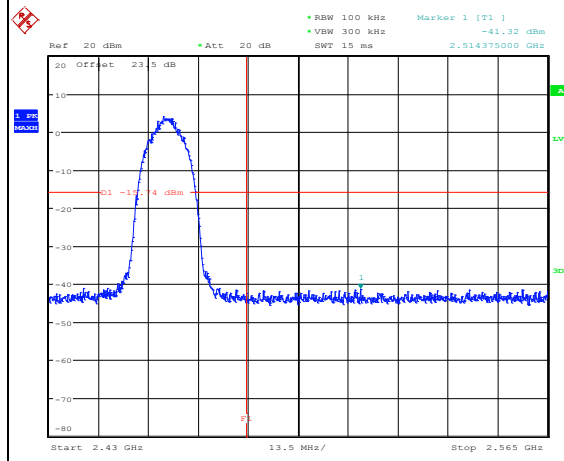

Date: 21.JUN.2016 18:29:07

Spurious Emission 30MHz~3GHz

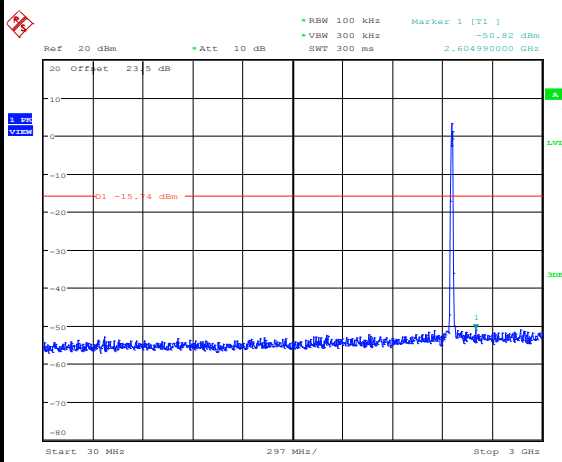

Date: 21.JUN.2016 18:29:23

Spurious Emission 2GHz~25GHz

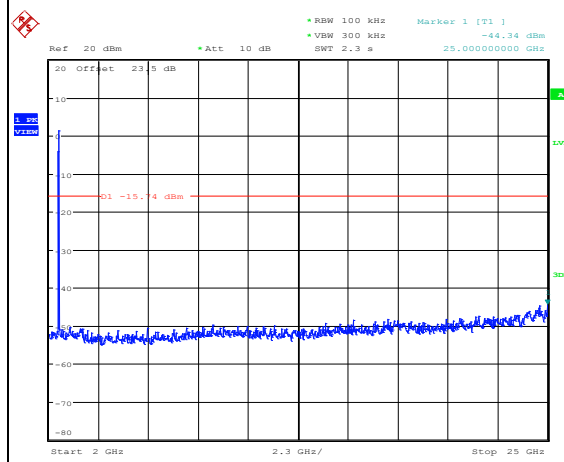

Date: 21.JUN.2016 18:29:31



Test Mode :	802.11g	Temperature :	21~25°C
Test Band :	2.4GHz Low	Relative Humidity :	51~54%
Test Channel :	01	Test Engineer :	PH Yang

WLAN 802.11g Channel 01

100kHz PSD reference Level

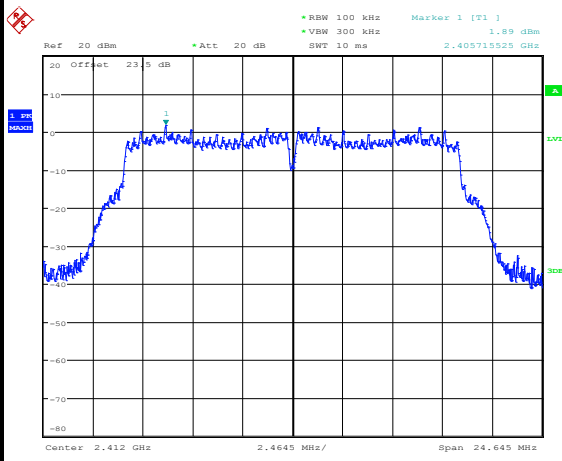

Date: 21.JUN.2016 19:15:22

Low Channel Plot

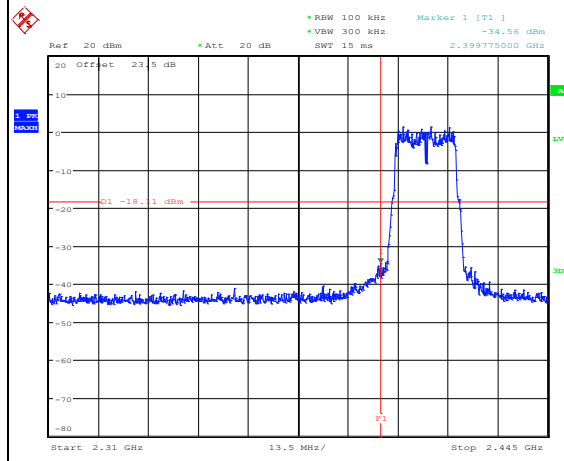

Date: 21.JUN.2016 19:15:39

Spurious Emission 30MHz~3GHz

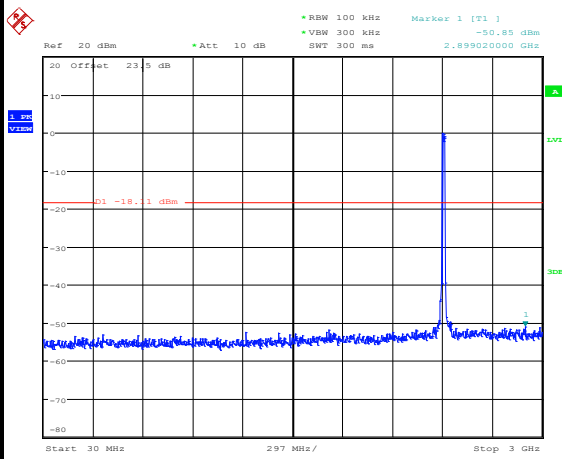

Date: 21.JUN.2016 19:15:51

Spurious Emission 2GHz~25GHz

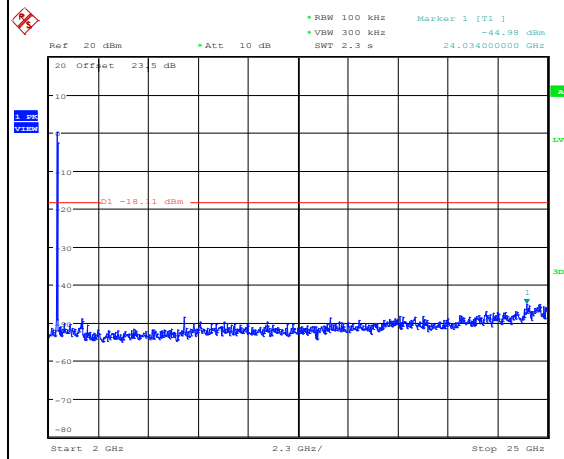

Date: 21.JUN.2016 19:15:59



Test Mode :	802.11g	Temperature :	21~25°C
Test Band :	2.4GHz Mid	Relative Humidity :	51~54%
Test Channel :	06	Test Engineer :	PH Yang

WLAN 802.11g Channel 06

100kHz PSD reference Level

Mid Channel Plot

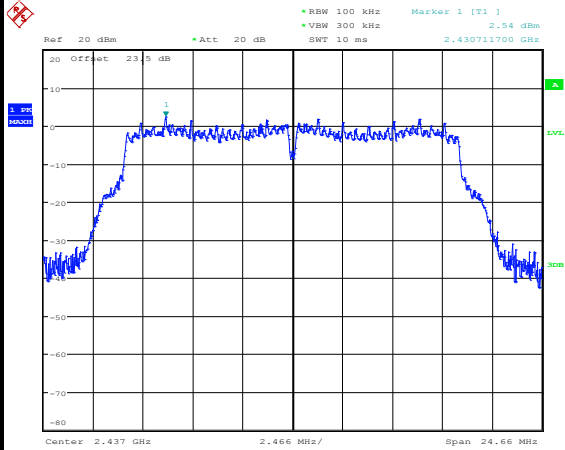

Date: 21.JUN.2016 19:20:16

Spurious Emission 30MHz~3GHz

Spurious Emission 2GHz~25GHz

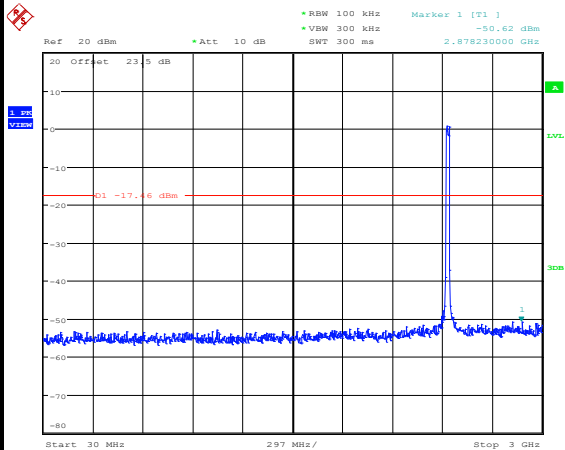

Date: 21.JUN.2016 19:21:07

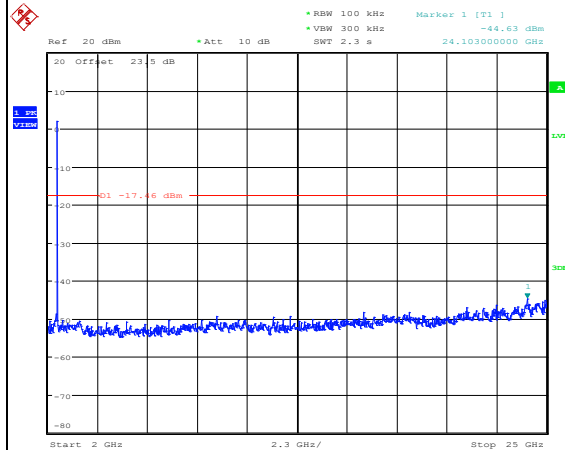

Date: 21.JUN.2016 19:21:15



Test Mode :	802.11g	Temperature :	21~25°C
Test Band :	2.4GHz High	Relative Humidity :	51~54%
Test Channel :	11	Test Engineer :	PH Yang

WLAN 802.11g Channel 11

100kHz PSD reference Level

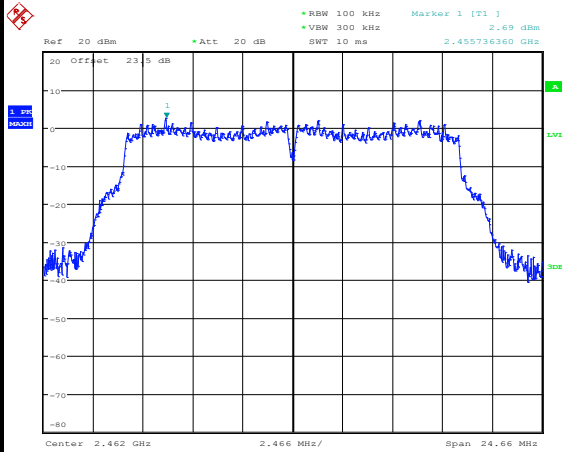

Date: 21.JUN.2016 19:27:20

High Channel Plot

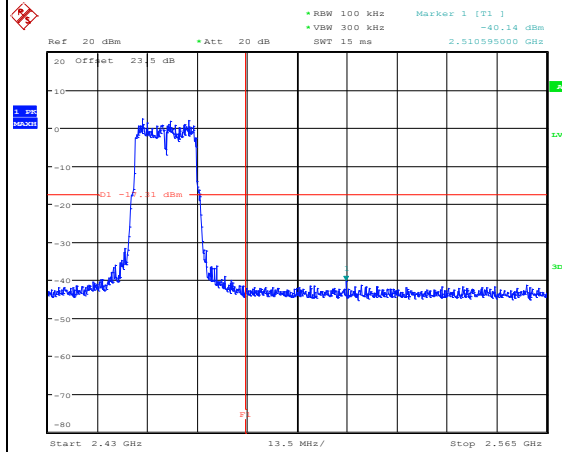

Date: 21.JUN.2016 19:27:36

Spurious Emission 30MHz~3GHz

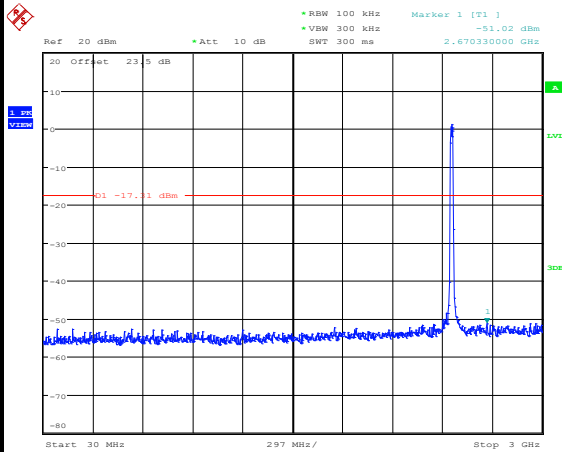

Date: 21.JUN.2016 19:27:48

Spurious Emission 2GHz~25GHz

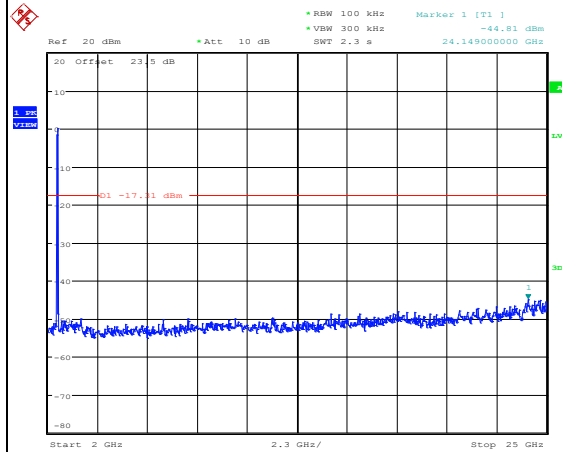

Date: 21.JUN.2016 19:27:56



Test Mode :	802.11n HT20	Temperature :	21~25°C
Test Band :	2.4GHz Low	Relative Humidity :	51~54%
Test Channel :	01	Test Engineer :	PH Yang

WLAN 802.11n HT20 Channel 01

100kHz PSD reference Level

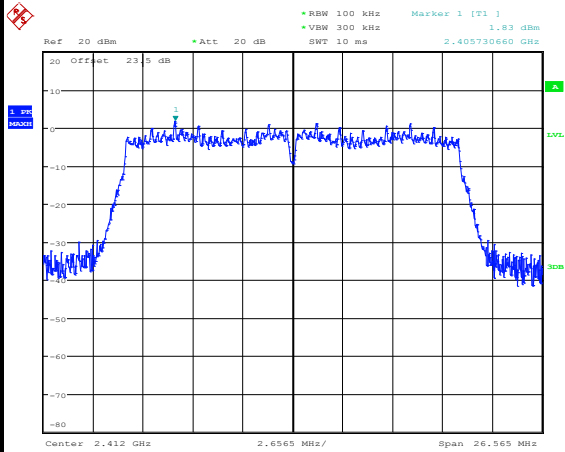

Date: 21.JUN.2016 19:33:56

Low Channel Plot

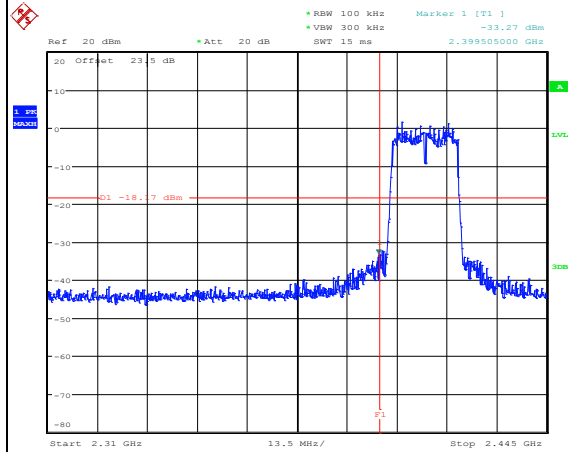

Date: 21.JUN.2016 19:34:10

Spurious Emission 30MHz~3GHz

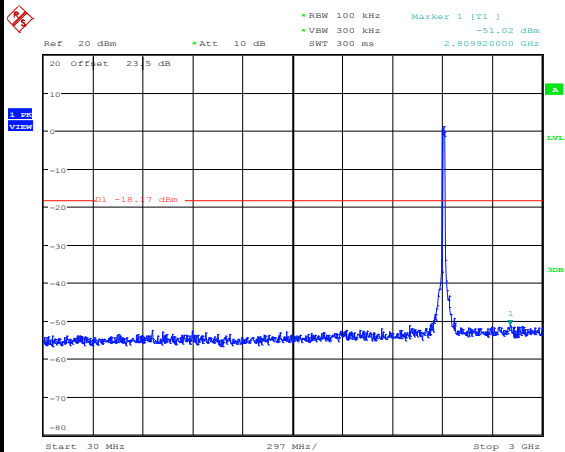

Date: 21.JUN.2016 19:44:33

Spurious Emission 2GHz~25GHz

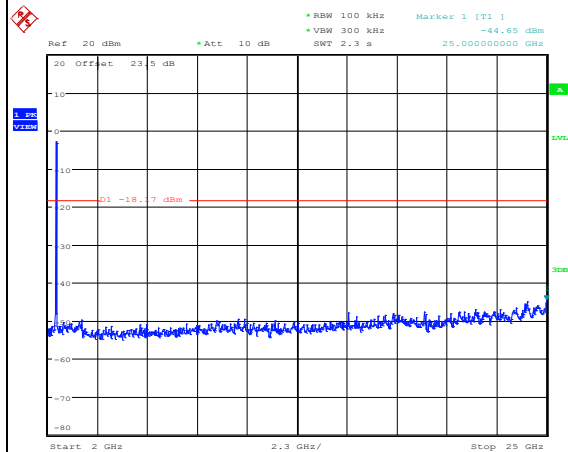

Date: 21.JUN.2016 19:41:10



Test Mode :	802.11n HT20	Temperature :	21~25°C
Test Band :	2.4GHz Mid	Relative Humidity :	51~54%
Test Channel :	06	Test Engineer :	PH Yang

WLAN 802.11n HT20 Channel 06

100kHz PSD reference Level

Mid Channel Plot

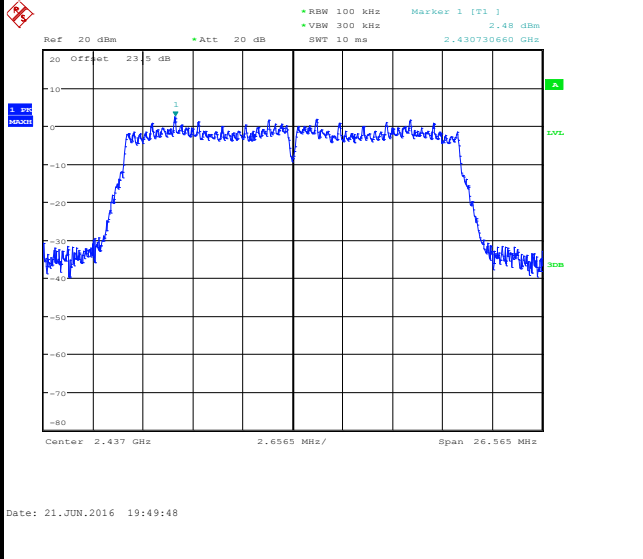

Spurious Emission 30MHz~3GHz

Spurious Emission 2GHz~25GHz

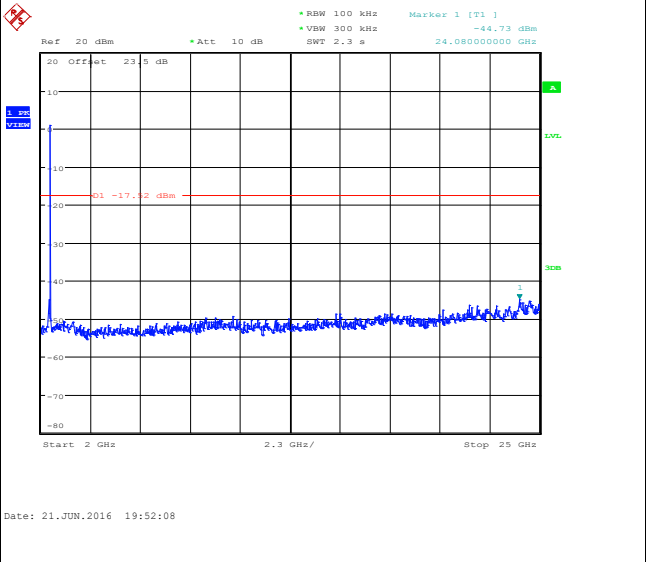
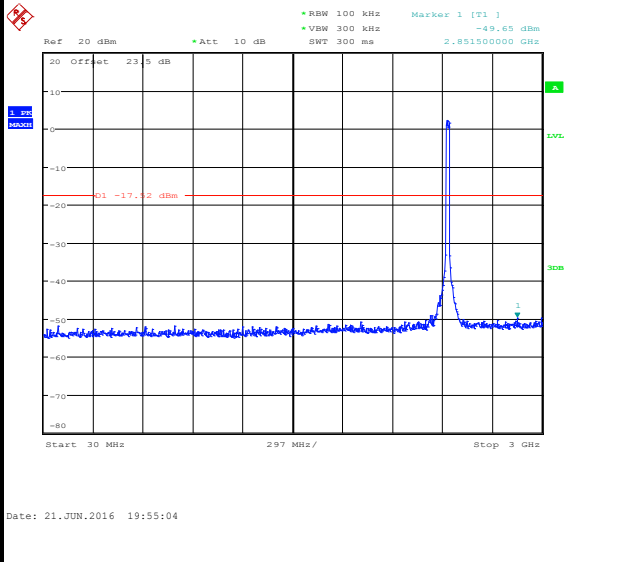



Test Mode :	802.11n HT20	Temperature :	21~25°C
Test Band :	2.4GHz High	Relative Humidity :	51~54%
Test Channel :	11	Test Engineer :	PH Yang

WLAN 802.11n HT20 Channel 11

100kHz PSD reference Level

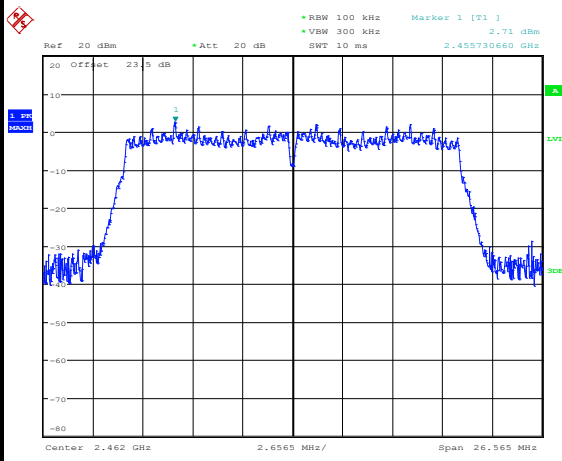

Date: 21.JUN.2016 19:58:42

High Channel Plot

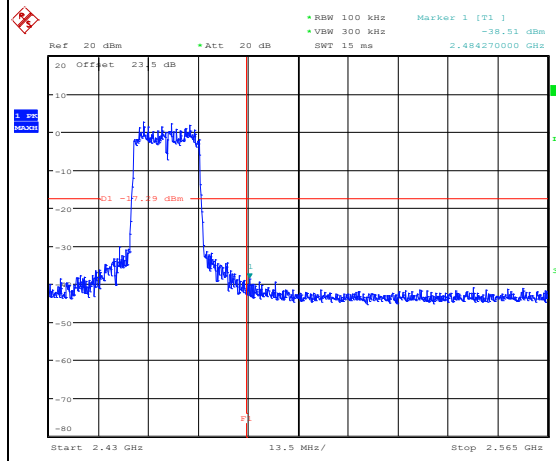

Date: 21.JUN.2016 19:58:57

Spurious Emission 30MHz~3GHz

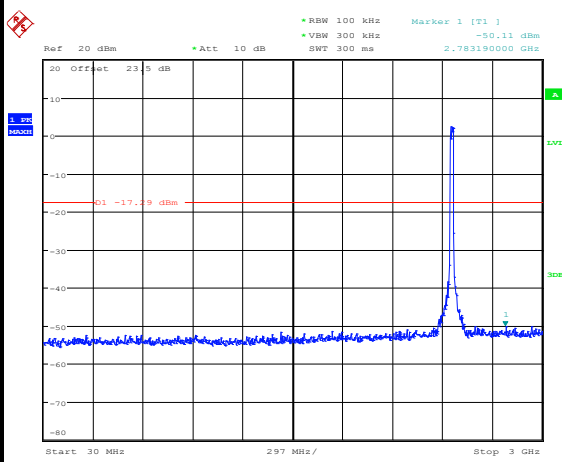

Date: 21.JUN.2016 20:01:54

Spurious Emission 2GHz~25GHz

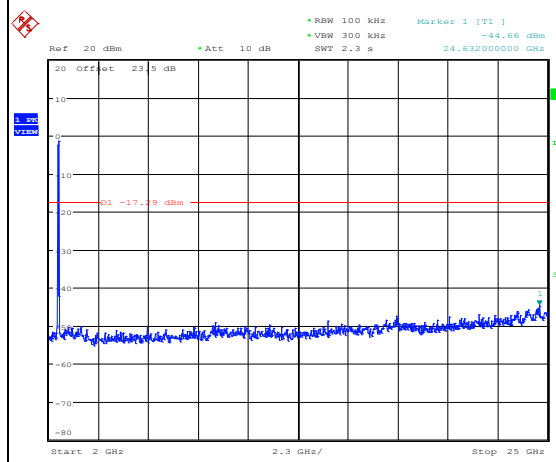

Date: 21.JUN.2016 20:00:18



3.5 Radiated Band Edges and Spurious Emission Measurement

3.5.1 Limit of Radiated band edge and Spurious Emission Measurement

In any 100 kHz bandwidth outside the intentional radiator frequency band, all harmonics/spurious must be at least 20 dB below the highest emission level within the authorized band. If the output power of this device was measured by spectrum analyzer, the attenuation under this paragraph shall be 30 dB instead of 20 dB. In addition, radiated emissions which fall in the restricted bands must also comply with the FCC section 15.209 limits as below.

Frequency (MHz)	Field Strength (microvolts/meter)	Measurement Distance (meters)
0.009 – 0.490	2400/F(kHz)	300
0.490 – 1.705	24000/F(kHz)	30
1.705 – 30.0	30	30
30 – 88	100	3
88 – 216	150	3
216 - 960	200	3
Above 960	500	3

3.5.2 Measuring Instruments

The measuring equipment is listed in the section 4 of this test report.



3.5.3 Test Procedures

1. The testing follows FCC KDB Publication No. 558074 D01 DTS Meas. Guidance v03r05.
2. The EUT was arranged to its worst case and then tune the antenna tower (from 1 m to 4 m) and turntable (from 0 degree to 360 degrees) to find the maximum reading. A pre-amp and a high pass filter are used for the test in order to get better signal level.
3. The EUT was placed on a turntable with 0.8 meter for frequency below 1GHz and 1.5 meter for frequency above 1GHz respectively above ground.
4. The EUT was set 3 meters from the interference receiving antenna, which was mounted on the top of a variable height antenna tower.
5. Corrected Reading: Antenna Factor + Cable Loss + Read Level - Preamp Factor = Level
6. For measurement below 1GHz, If the emission level of the EUT measured by the peak detector is 3 dB lower than the applicable limit, the peak emission level will be reported. Otherwise, the emission measurement will be repeated using the quasi-peak detector and reported.
7. Use the following spectrum analyzer settings:
 - (1) Span shall wide enough to fully capture the emission being measured;
 - (2) Set RBW=100 kHz for $f < 1$ GHz; VBW \geq RBW; Sweep = auto; Detector function = peak; Trace = max hold;
 - (3) Set RBW = 1 MHz, VBW= 3MHz for $f \geq 1$ GHz for peak measurement.
For average measurement:
 - VBW = 10 Hz, when duty cycle is no less than 98 percent.
 - VBW $\geq 1/T$, when duty cycle is less than 98 percent where T is the minimum transmission duration over which the transmitter is on and is transmitting at its maximum power control level for the tested mode of operation.

3.5.4 Test Setup

For radiated emissions below 30MHz



For radiated emissions from 30MHz to 1GHz

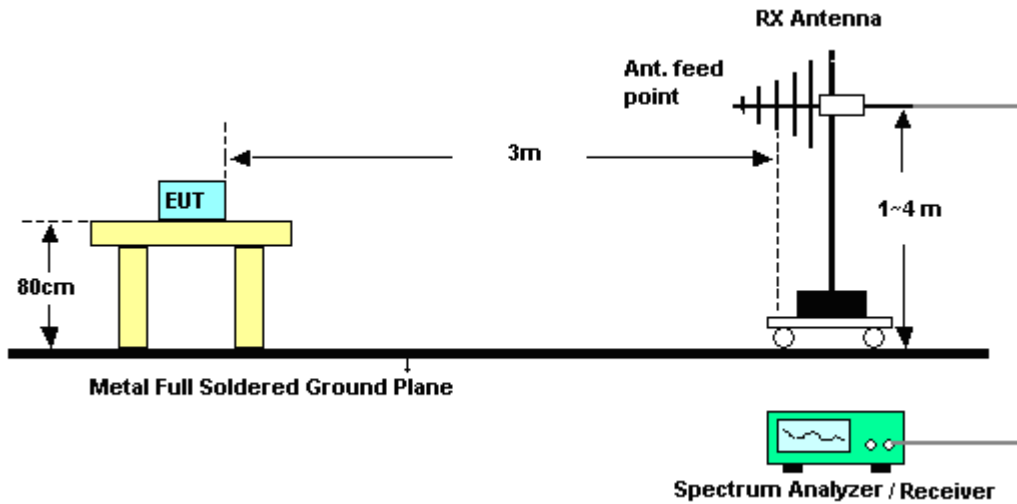

For radiated emissions above 1GHz

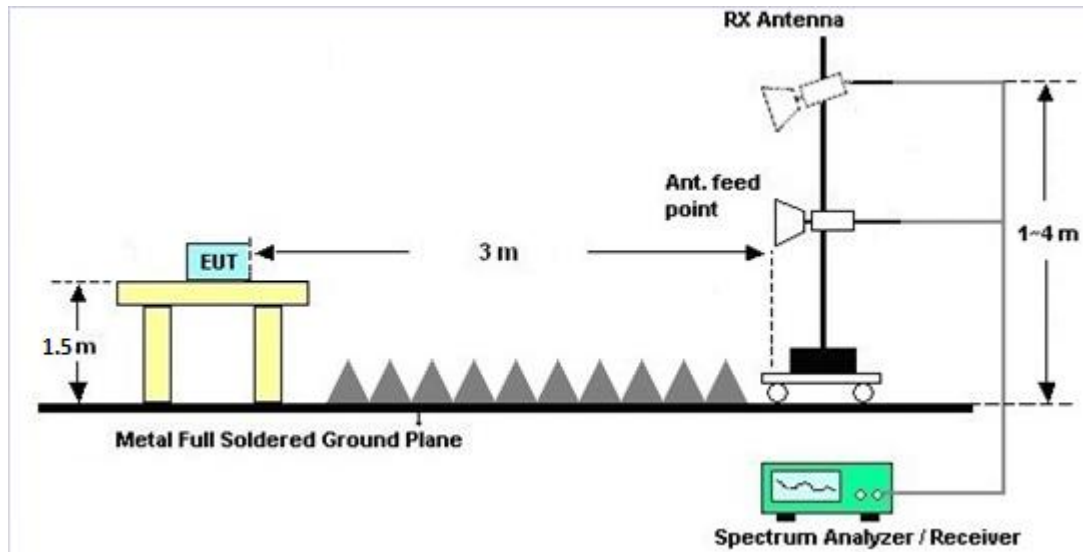

3.5.5 Test Results of Radiated Spurious Emissions (9kHz ~ 30MHz)

The low frequency, which started from 9 kHz to 30MHz, was pre-scanned and the result which was 20dB lower than the limit line per 15.31(o) was not reported.

3.5.6 Test Result of Radiated Spurious at Band Edges

Please refer to Appendix B and C.

3.5.7 Duty Cycle

Please refer to Appendix D.

3.5.8 Test Result of Radiated Spurious Emission (30MHz ~ 10th Harmonic)

Please refer to Appendix B and C.



3.6 AC Conducted Emission Measurement

3.6.1 Limit of AC Conducted Emission

For equipment that is designed to be connected to the public utility (AC) power line, the radio frequency voltage that is conducted back onto the AC power line on any frequency or frequencies within the band 150 kHz to 30 MHz shall not exceed the limits in the following table.

Frequency of Emission (MHz)	Conducted Limit (dB μ V)	
	Quasi-Peak	Average
0.15-0.5	66 to 56*	56 to 46*
0.5-5	56	46
5-30	60	50

*Decreases with the logarithm of the frequency.

3.6.2 Measuring Instruments

The measuring equipment is listed in the section 4 of this test report.

3.6.3 Test Procedures

1. The EUT was placed 0.4 meter from the conducting wall of the shielding room, and it was kept at least 80 centimeters from any other grounded conducting surface.
2. Connect EUT to the power mains through a line impedance stabilization network (LISN).
3. All the support units are connecting to the other LISN.
4. The LISN provides 50 ohm coupling impedance for the measuring instrument.
5. The FCC states that a 50 ohm, 50 microhenry LISN should be used.
6. Both sides of AC line were checked for maximum conducted interference.
7. The frequency range from 150 kHz to 30 MHz was searched.
8. Set the test-receiver system to Peak Detect Function and specified bandwidth (IF bandwidth = 9kHz) with Maximum Hold Mode.

3.6.4 Test Setup

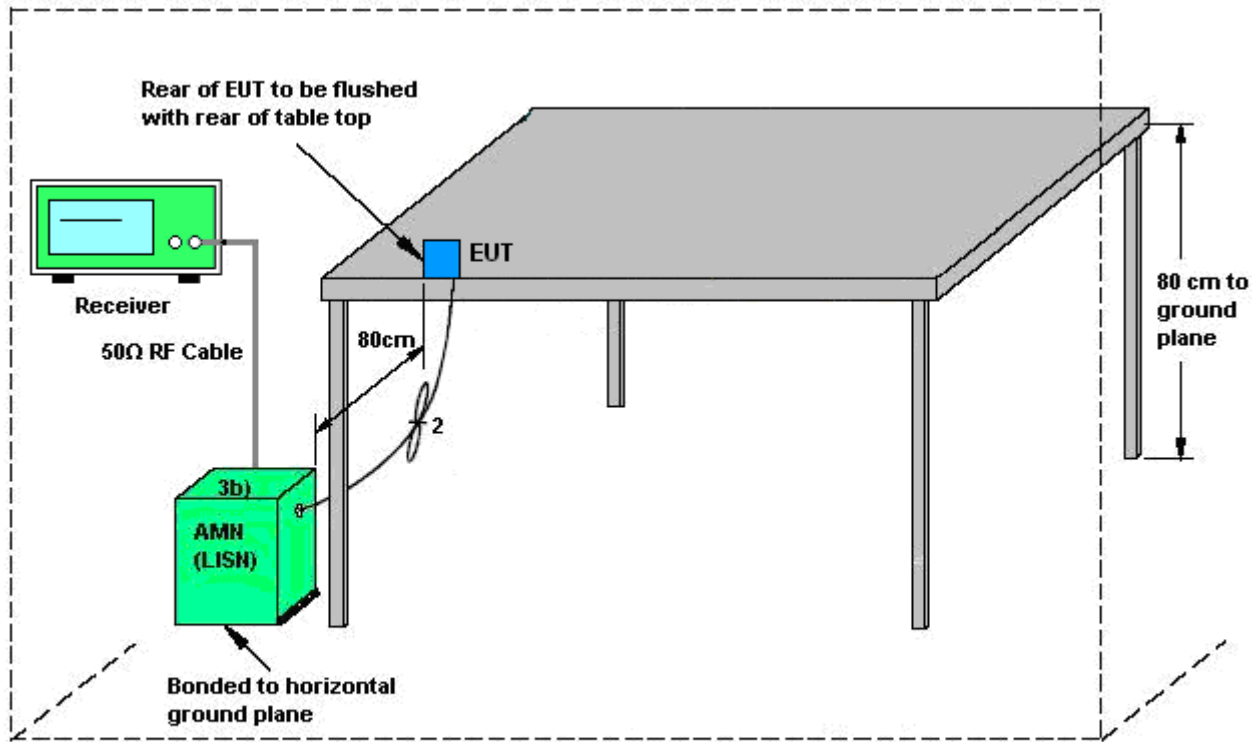

AMN = Artificial mains network (LISN)
AE = Associated equipment
EUT = Equipment under test
ISN = Impedance stabilization network



3.6.5 Test Result of AC Conducted Emission

Test Mode :	Mode 1	Temperature :	22~23°C
Test Engineer :	Arthur Hsieh	Relative Humidity :	51~52%
Test Voltage :	120Vac / 60Hz	Phase :	Line
Function Type :	BT LE Tx + EUT with Docking + USB Cable (Charging from Adapter)		

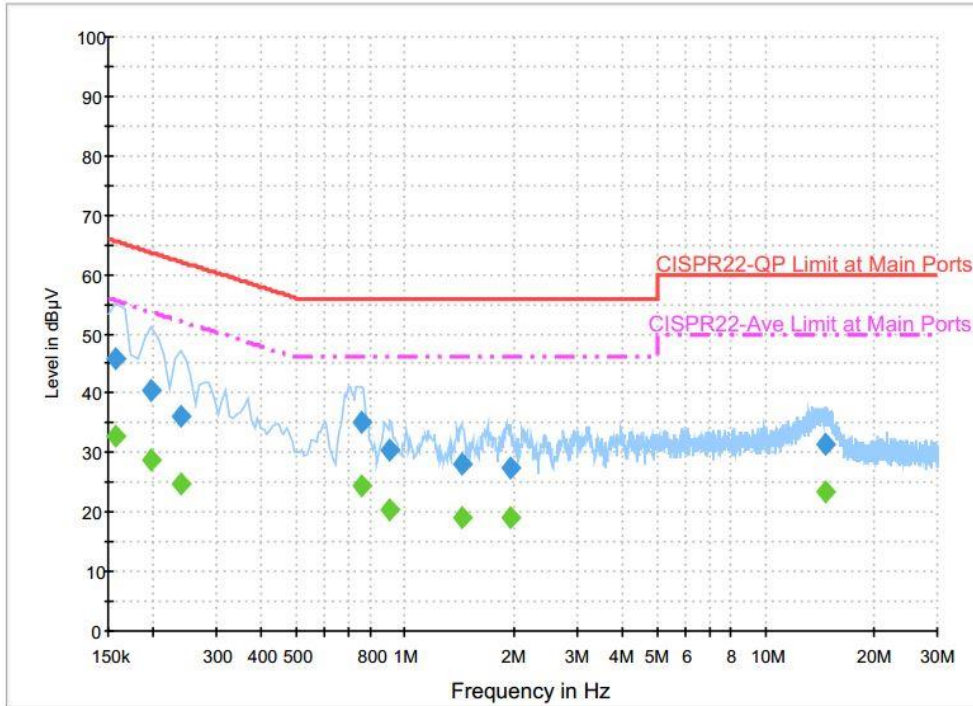

Final Result : Quasi-Peak

Frequency (MHz)	Quasi-Peak (dBµV)	Filter	Line	Corr. (dB)	Margin (dB)	Limit (dBµV)
0.158000	45.7	Off	L1	19.6	19.9	65.6
0.198000	40.6	Off	L1	19.6	23.1	63.7
0.238000	36.1	Off	L1	19.6	26.1	62.2
0.758000	35.3	Off	L1	19.6	20.7	56.0
0.910000	30.3	Off	L1	19.6	25.7	56.0
1.438000	28.2	Off	L1	19.7	27.8	56.0
1.974000	27.4	Off	L1	19.7	28.6	56.0
14.694000	31.3	Off	L1	20.4	28.7	60.0

Final Result : Average

Frequency (MHz)	Average (dBµV)	Filter	Line	Corr. (dB)	Margin (dB)	Limit (dBµV)
0.158000	32.8	Off	L1	19.6	22.8	55.6
0.198000	28.7	Off	L1	19.6	25.0	53.7
0.238000	24.8	Off	L1	19.6	27.4	52.2
0.758000	24.5	Off	L1	19.6	21.5	46.0
0.910000	20.5	Off	L1	19.6	25.5	46.0
1.438000	19.1	Off	L1	19.7	26.9	46.0
1.974000	18.9	Off	L1	19.7	27.1	46.0
14.694000	23.4	Off	L1	20.4	26.6	50.0



Test Mode :	Mode 1	Temperature :	22~23°C
Test Engineer :	Arthur Hsieh	Relative Humidity :	51~52%
Test Voltage :	120Vac / 60Hz	Phase :	Neutral
Function Type :	BT LE Tx + EUT with Docking + USB Cable (Charging from Adapter)		

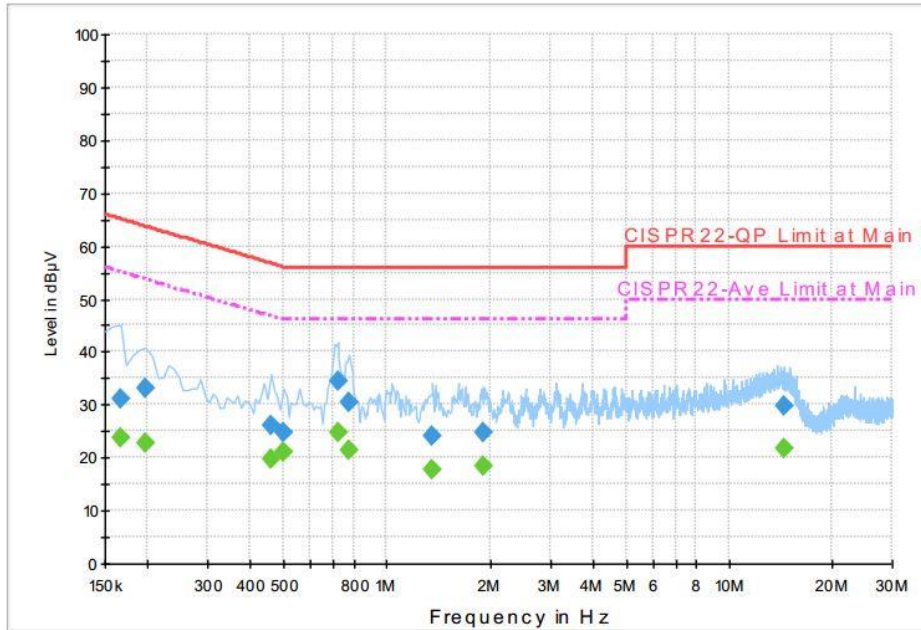

Final Result : Quasi-Peak

Frequency (MHz)	Quasi-Peak (dBµV)	Filter	Line	Corr. (dB)	Margin (dB)	Limit (dBµV)
0.166000	31.0	Off	N	19.6	34.2	65.2
0.198000	33.3	Off	N	19.6	30.4	63.7
0.462000	26.1	Off	N	19.6	30.6	56.7
0.502000	24.9	Off	N	19.6	31.1	56.0
0.718000	34.6	Off	N	19.6	21.4	56.0
0.774000	30.5	Off	N	19.6	25.5	56.0
1.358000	24.0	Off	N	19.6	32.0	56.0
1.926000	24.8	Off	N	19.7	31.2	56.0
14.542000	29.6	Off	N	20.4	30.4	60.0

Final Result : Average

Frequency (MHz)	Average (dBµV)	Filter	Line	Corr. (dB)	Margin (dB)	Limit (dBµV)
0.166000	23.6	Off	N	19.6	31.6	55.2
0.198000	22.8	Off	N	19.6	30.9	53.7
0.462000	19.6	Off	N	19.6	27.1	46.7
0.502000	21.0	Off	N	19.6	25.0	46.0
0.718000	24.6	Off	N	19.6	21.4	46.0
0.774000	21.6	Off	N	19.6	24.4	46.0
1.358000	17.7	Off	N	19.6	28.3	46.0
1.926000	18.3	Off	N	19.7	27.7	46.0
14.542000	21.8	Off	N	20.4	28.2	50.0



3.7 Antenna Requirements

3.7.1 Standard Applicable

If directional gain of transmitting antennas is greater than 6dBi, the power shall be reduced by the same level in dB comparing to gain minus 6dBi. For the fixed point-to-point operation, the power shall be reduced by one dB for every 3 dB that the directional gain of the antenna exceeds 6 dBi. The use of a permanently attached antenna or of an antenna that uses a unique coupling to the intentional radiator shall be considered sufficient to comply with the FCC rule.

3.7.2 Antenna Anti-Replacement Construction

An embedded-in antenna design is used.

3.7.3 Antenna Gain

The antenna peak gain of EUT is less than 6 dBi. Therefore, it is not necessary to reduce maximum peak output power limit.



4 List of Measuring Equipment

Instrument	Manufacturer	Model No.	Serial No.	Characteristics	Calibration Date	Test Date	Due Date	Remark
Power Meter	Agilent	E4416A	GB4129 2344	300MHz~40GHz	Jan. 08, 2016	May 17, 2016 ~ Jun. 21, 2016	Jan. 07, 2017	Conducted (TH02-HY)
Power Meter	Anritsu	ML2495A	1036004	300MHz~40GHz	Jul. 29, 2015	May 17, 2016 ~ Jun. 21, 2016	Jul. 28, 2016	Conducted (TH02-HY)
Power Sensor	Agilent	E9327A	US4044 1548	300MHz~40GHz	Jan. 07, 2016	May 17, 2016 ~ Jun. 21, 2016	Jan. 06, 2017	Conducted (TH02-HY)
Power Sensor	Anritsu	MA2411B	1027253	300MHz~40GHz	Jul. 29, 2015	May 17, 2016 ~ Jun. 21, 2016	Jul. 28, 2016	Conducted (TH02-HY)
Spectrum Analyzer	Rohde & Schwarz	FSP40	100055	9kHz~40GHz	Jun. 18, 2015	May 17, 2016 ~ Jun. 16, 2016	Jun. 17, 2016	Conducted (TH02-HY)
Spectrum Analyzer	Rohde & Schwarz	FSP40	100055	9kHz~40GHz	Jun. 17, 2016	Jun. 17, 2016 ~ Jun. 21, 2016	Jun. 16, 2017	Conducted (TH02-HY)
AC Power Source	ChainTek	APC-1000W	N/A	N/A	N/A	Jul. 05, 2016	N/A	Conduction (CO05-HY)
EMI Test Receiver	Rohde & Schwarz	ESCI 7	100724	9kHz~7GHz	Aug. 26, 2015	Jul. 05, 2016	Aug. 25, 2016	Conduction (CO05-HY)
LISN	Rohde & Schwarz	ENV216	100080	9kHz~30MHz	Dec. 02, 2015	Jul. 05, 2016	Dec. 01, 2016	Conduction (CO05-HY)
Loop Antenna	Rohde & Schwarz	HFH2-Z2	100315	9 kHz~30 MHz	Sep. 02, 2015	Jun. 28, 2016 ~ Jul. 01, 2016	Sep. 01, 2016	Radiation (03CH10-HY)
Amplifier	SONOMA	310N	187311	9kHz~1GHz	Nov. 16, 2015	Jun. 28, 2016 ~ Jul. 01, 2016	Nov. 15, 2016	Radiation (03CH10-HY)
Bilog Antenna	TESEQ	CBL 6111D	35413	30MHz~1GHz	Jan. 13, 2016	Jun. 28, 2016 ~ Jul. 01, 2016	Jan. 12, 2017	Radiation (03CH10-HY)
Horn Antenna	SCHWARZBE CK	BBHA 9120 D	9120D-1 325	1GHz ~ 18GHz	Sep. 30, 2015	Jun. 28, 2016 ~ Jul. 01, 2016	Sep. 29, 2016	Radiation (03CH10-HY)
Preamplifier	Keysight	83017A	MY5327 0078	1GHz~26.5GHz	Nov. 13, 2015	Jun. 28, 2016 ~ Jul. 01, 2016	Nov. 12, 2016	Radiation (03CH10-HY)
Preamplifier	MITEQ	AMF-7D-00101 800-30-10P	1902246	1GHz~18GHz	Nov. 16, 2015	Jun. 28, 2016 ~ Jul. 01, 2016	Nov. 15, 2016	Radiation (03CH10-HY)
Spectrum Analyzer	Keysight	N9010A	MY5420 0485	10Hz ~ 44GHz	Oct. 15, 2015	Jun. 28, 2016 ~ Jul. 01, 2016	Oct. 14, 2016	Radiation (03CH10-HY)
Antenna Mast	EMEC	AM-BS-4500-B	N/A	1~4m	N/A	Jun. 28, 2016 ~ Jul. 01, 2016	N/A	Radiation (03CH10-HY)
Turn Table	EMEC	TT 2200	N/A	0~360 Degree	N/A	Jun. 28, 2016 ~ Jul. 01, 2016	N/A	Radiation (03CH10-HY)
Preamplifier	MITEQ	JS44-18004000 -33-8P	1840917	18GHz ~ 40GHz	Jun. 14, 2016	Jun. 28, 2016 ~ Jul. 01, 2016	Jun. 13, 2017	Radiation (03CH10-HY)
SHF-EHF Horn Antenna	SCHWARZBE CK	BBHA 9170	BBHA91 70584	18GHz- 40GHz	Nov. 02, 2015	Jun. 28, 2016 ~ Jul. 01, 2016	Nov. 01, 2016	Radiation (03CH10-HY)
EMI Test Receiver	Agilent	N9038A (MXE)	MY5329 0053	20Hz to 26.5GHz	Jan. 20, 2016	Jun. 28, 2016 ~ Jul. 01, 2016	Jan. 19, 2017	Radiation (03CH10-HY)



5 Uncertainty of Evaluation

Uncertainty of Conducted Emission Measurement (150kHz ~ 30MHz)

Measuring Uncertainty for a Level of Confidence of 95% ($U = 2Uc(y)$)	2.26
---	------

Uncertainty of Radiated Emission Measurement (30 MHz ~ 1000 MHz)

Measuring Uncertainty for a Level of Confidence of 95% ($U = 2Uc(y)$)	5.50
---	------



Appendix A. Conducted Test Results