

# TEST REPORT

## CERTIFICATE OF CONFORMITY

**Standard:** 47 CFR FCC Part 15, Subpart C (Section 15.247)

**Report No.:** RFCDVB-WTW-P24010023-1

**FCC ID:** QYLAX211NG

**Product:** Wireless Module

**Brand:** Getac

**Model No.:** AX211NGW

**Received Date:** 2024/1/20

**Test Date:** 2024/2/20 ~ 2024/3/11

**Issued Date:** 2024/3/28

**Applicant:** Getac Technology Corporation.

**Address:** 5F., Building A, No. 209, Sec.1, Nangang Rd., Nangang Dist., Taipei City 11568, Taiwan, R.O.C.

**Issued By:** Bureau Veritas Consumer Products Services (H.K.) Ltd., Taoyuan Branch  
Lin Kou Laboratories

**Lab Address:** No. 47-2, 14th Ling, Chia Pau Vil., Lin Kou Dist., New Taipei City, Taiwan

**Test Location:** No. 19, Hwa Ya 2nd Rd., Wen Hwa Vil., Kewi Shan Dist., Taoyuan City 33383, Taiwan

**FCC Registration /** 788550 / TW0003

**Designation Number:**

Approved by: \_\_\_\_\_

*Jeremy Lin*

Jeremy Lin / Project Engineer

, Date: \_\_\_\_\_

2024/3/28

This test report consists of 26 pages in total. It may be duplicated completely for legal use with the approval of the applicant. It should not be reproduced except in full, without the written approval of our laboratory. The test results in the report only apply to the tested sample. The test results in this report are traceable to the national or international standards.

Prepared by : Gina Liu / Specialist



This report is governed by, and incorporates by reference, the Conditions of Testing as posted at the date of issuance of this report at <http://www.bureauveritas.com/home/about-us/our-business/cps/about-us/terms-conditions/> and is intended for your exclusive use. Any copying or replication of this report to or for any other person or entity, or use of our name or trademark, is permitted only with our prior written permission. This report sets forth our findings solely with respect to the test samples identified herein. The results set forth in this report are not indicative or representative of the quality or characteristics of the lot from which a test sample was taken or any similar or identical product unless specifically and expressly noted. Our report includes all of the tests requested by you and the results thereof based upon the information that you provided to us. Measurement uncertainty is only provided upon request for accredited tests. Statements of conformity are based on simple acceptance criteria without taking measurement uncertainty into account, unless otherwise requested in writing. You have 60 days from date of issuance of this report to notify us of any material error or omission caused by our negligence or if you require measurement uncertainty; provided, however, that such notice shall be in writing and shall specifically address the issue you wish to raise. A failure to raise such issue within the prescribed time shall constitute your unqualified acceptance of the completeness of this report, the tests conducted and the correctness of the report contents.

## Table of Contents

<b>Release Control Record .....</b>	<b>3</b>
<b>1 Certificate.....</b>	<b>4</b>
<b>2 Summary of Test Results .....</b>	<b>5</b>
2.1 Measurement Uncertainty .....	5
2.2 Supplementary Information .....	5
<b>3 General Information .....</b>	<b>6</b>
3.1 General Description.....	6
3.2 Antenna Description of EUT .....	7
3.3 Channel List.....	7
3.4 Test Mode Applicability and Tested Channel Detail.....	8
3.5 Duty Cycle of Test Signal.....	8
3.6 Test Program Used and Operation Descriptions .....	9
3.7 Connection Diagram of EUT and Peripheral Devices .....	9
3.8 Configuration of Peripheral Devices and Cable Connections .....	9
<b>4 Test Instruments .....</b>	<b>10</b>
4.1 RF Output Power.....	10
4.2 AC Power Conducted Emissions .....	10
4.3 Unwanted Emissions below 1 GHz .....	11
4.4 Unwanted Emissions above 1 GHz.....	12
<b>5 Limits of Test Items.....</b>	<b>13</b>
5.1 RF Output Power.....	13
5.2 AC Power Conducted Emissions .....	13
5.3 Unwanted Emissions below 1 GHz .....	13
5.4 Unwanted Emissions above 1 GHz.....	13
<b>6 Test Arrangements.....</b>	<b>14</b>
6.1 RF Output Power.....	14
6.1.1 Test Setup .....	14
6.1.2 Test Procedure.....	14
6.2 AC Power Conducted Emissions .....	14
6.2.1 Test Setup .....	14
6.2.2 Test Procedure.....	14
6.3 Unwanted Emissions below 1 GHz .....	15
6.3.1 Test Setup .....	15
6.3.2 Test Procedure.....	16
6.4 Unwanted Emissions above 1 GHz.....	17
6.4.1 Test Setup .....	17
6.4.2 Test Procedure.....	17
<b>7 Test Results of Test Item .....</b>	<b>18</b>
7.1 RF Output Power.....	18
7.2 AC Power Conducted Emissions .....	19
7.3 Unwanted Emissions below 1 GHz .....	21
7.4 Unwanted Emissions above 1 GHz.....	23
<b>8 Pictures of Test Arrangements .....</b>	<b>25</b>
<b>9 Information of the Testing Laboratories .....</b>	<b>26</b>



## Release Control Record

Issue No.	Description	Date Issued
RFCDVB-WTW-P24010023-1	Original release.	2024/3/28

## 1 Certificate

**Product:** Wireless Module

**Brand:** Getac

**Test Model:** AX211NGW

**Sample Status:** Engineering sample

**Applicant:** Getac Technology Corporation.

**Test Date:** 2024/2/20 ~ 2024/3/11

**Standard:** 47 CFR FCC Part 15, Subpart C (Section 15.247)

**Measurement** ANSI C63.10-2013

**procedure:** KDB 558074 D01 15.247 Meas Guidance v05r02

The above equipment has been tested by **Bureau Veritas Consumer Products Services (H.K.) Ltd., Taoyuan Branch**, and found compliance with the requirement of the above standards. The test record, data evaluation & Equipment Under Test (EUT) configurations represented herein are true and accurate accounts of the measurements of the sample's RF characteristics under the conditions specified in this report.

## 2 Summary of Test Results

47 CFR FCC Part 15, Subpart C (Section 15.247)			
Standard / Clause	Test Item	Result	Remark
15.247(b)	RF Output Power	Pass	Meet the requirement of limit.
15.247(e)	Power Spectral Density	N/A	Refer to Note
15.247(a)(2)	6 dB Bandwidth	N/A	Refer to Note
15.247(d)	Conducted Out of Band Emissions	N/A	Refer to Note
15.207	AC Power Conducted Emissions	Pass	Minimum passing margin is -19.83 dB at 0.51400 MHz
15.205 / 15.209 / 15.247(d)	Unwanted Emissions below 1 GHz	Pass	Minimum passing margin is -7.2 dB at 421.88 MHz
15.205 / 15.209 / 15.247(d)	Unwanted Emissions above 1 GHz	Pass	Minimum passing margin is -5.6 dB at 2483.50 MHz
15.203	Antenna Requirement	Pass	Antenna connector is MHF-4 not a standard connector.

### Notes:

1. Only test item of Output Power, AC Power Conducted Emissions and Unwanted Emissions were performed for this report. Other testing data please refer to module report No.: 200611-01.TR04 (Brand: Intel® Wi-Fi 6E AX211, Model: AX211NGW).
2. Determining compliance based on the results of the compliance measurement, not taking into account measurement instrumentation uncertainty.

### 2.1 Measurement Uncertainty

Where relevant, the following measurement uncertainty levels have been estimated for tests performed on the EUT as specified in CISPR 16-4-2:

Measurement	Specification	Expanded Uncertainty (k=2) (±)
RF Output Power	-	1.371 dB
AC Power Conducted Emissions	9 kHz ~ 30 MHz	2.88 dB
Unwanted Emissions below 1 GHz	9 kHz ~ 30 MHz	2.44 dB
	30 MHz ~ 1 GHz	2.95 dB
Unwanted Emissions above 1 GHz	1 GHz ~ 18 GHz	2.26 dB
	18 GHz ~ 40 GHz	1.94 dB

The other instruments specified are routine verified to remain within the calibrated levels, no measurement uncertainty is required to be calculated.

### 2.2 Supplementary Information

There is not any deviation from the test standards for the test method, and no modifications required for compliance.

### 3 General Information

#### 3.1 General Description

Product	Wireless Module
Brand	Getac
Test Model	AX211NGW
Status of EUT	Engineering sample
Power Supply Rating	End-product: 19.0 Vdc (from adapter) 10.8 Vdc (from battery)
Modulation Type	GFSK
Modulation Technology	DTS
Transfer Rate	Up to 2 Mbps
Operating Frequency	2.402 GHz ~ 2.48 GHz
Number of Channel	40
Output Power	7.727 mW (8.88 dBm)

Note:

1. This report is prepared for FCC class II permissive change. This report is issued as a supplementary report to module report No.: 200611-01.TR04 (Brand: Intel® Wi-Fi 6E AX211, Model: AX211NGW). The difference compared with original report are adding End-product. Therefore, only Output Power, AC Power Conducted Emission and Radiated Emissions were verified and recorded in this report. AC Power Conducted Emission and Radiated Emission tests according to module report radiated emission worst channel, and Conducted power were re-test.
2. The EUT is authorized for use in specific End-product. Please refer to below for more details.

Product	Brand	Model	Difference
Notebook	Getac	S510	marketing purpose
		S510Y (Y= 10 characters, Y can be 0 to 9, A to Z, a to z, “/”, “\”, “-”, “_” or blank for marketing purpose)	

3. The End-product contains following accessory devices.

Battery		
Brand	Model	Specification
Getac	BP3S2P3450P-04	Power Rating : Rating: 10.8Vdc , 6600mAh, 72Wh Typical Capacity: 6900mAh, 75Wh
AC Adapter 1		
Brand	Model	Specification
FSP	FSP065-RBBN3	AC Input : 100-240 Vac ; 50-60 Hz ; 1.5 A DC Output : 19.0Vdc ; 3.42A, 65.0W DC Output Cable : 1.45M / 1 core
AC Adapter 2		
Brand	Model	Specification
FSP	FSP090-ABBN3	AC Input : 100-240 Vac ; 50-60 Hz ; 1.2 A DC Output : 19.0Vdc ; 4.74A, 90.0W DC Output Cable : 1.2M / 1 core
Touch Pen		
Brand	Model	
Getac	340GA8900001	

\*After the pretesting, adapter 2 mode is found to be the worse case and therefore had been chosen for final test.

4. The above EUT information is declared by manufacturer and for more detailed features description, please refer to the manufacturer's specifications or User's Manual.

### 3.2 Antenna Description of EUT

1. The antenna information is listed as below.

Antenna No.	2.4GHz 2400-2483.5 MHz	5.2GHz 5150-5250 MHz	5.3GHz 5250-5350 MHz	5.6GHz 5470-5725 MHz	5.8GHz 5725-5850 MHz	5.9GHz 5850-5895 MHz	6.2GHz 5925-6425 MHz	6.5GHz 6425-6525 MHz	6.7GHz 6525-6875 MHz	7.0GHz 6875-7125 MHz	Antenna Type	Connector Type
1	2.41	1.39	1.21	2.45	2.41	2.39	2.18	1.46	1.83	1.56	PIFA	MHF-4
2	1.68	1.22	1.17	1.8	1.78	0.52	1.2	1.18	1.14	2.3	PIFA	MHF-4

\* Detail antenna specification please refer to antenna datasheet and/or antenna measurement report.

### 3.3 Channel List

40 channels are provided for BT-LE:

Channel	Frequency (MHz)	Channel	Frequency (MHz)	Channel	Frequency (MHz)	Channel	Frequency (MHz)
0	2402	10	2422	20	2442	30	2462
1	2404	11	2424	21	2444	31	2464
2	2406	12	2426	22	2446	32	2466
3	2408	13	2428	23	2448	33	2468
4	2410	14	2430	24	2450	34	2470
5	2412	15	2432	25	2452	35	2472
6	2414	16	2434	26	2454	36	2474
7	2416	17	2436	27	2456	37	2476
8	2418	18	2438	28	2458	38	2478
9	2420	19	2440	29	2460	39	2480

### 3.4 Test Mode Applicability and Tested Channel Detail

Following channel(s) was (were) selected for the final test as listed below:

Test Item	Mode	Tested Channel	Modulation	Data Rate Parameter
RF Output Power	BT-LE 1M	0, 19, 39	GFSK	1Mb/s
	BT-LE 2M	0, 19, 39	GFSK	2Mb/s
AC Power Conducted Emissions	BT-LE 1M	39	GFSK	1Mb/s
Unwanted Emissions below 1 GHz	BT-LE 1M	39	GFSK	1Mb/s
Unwanted Emissions above 1 GHz	BT-LE 1M	39	GFSK	1Mb/s

Note: The EUT is designed to be positioned on the NB Mode only.

### 3.5 Duty Cycle of Test Signal

**BT-LE 1M:** Duty cycle =  $0.394 \text{ ms} / 0.624 \text{ ms} \times 100\% = 63.1\%$ , duty factor =  $10 * \log (1/\text{Duty cycle}) = 2.00 \text{ dB}$

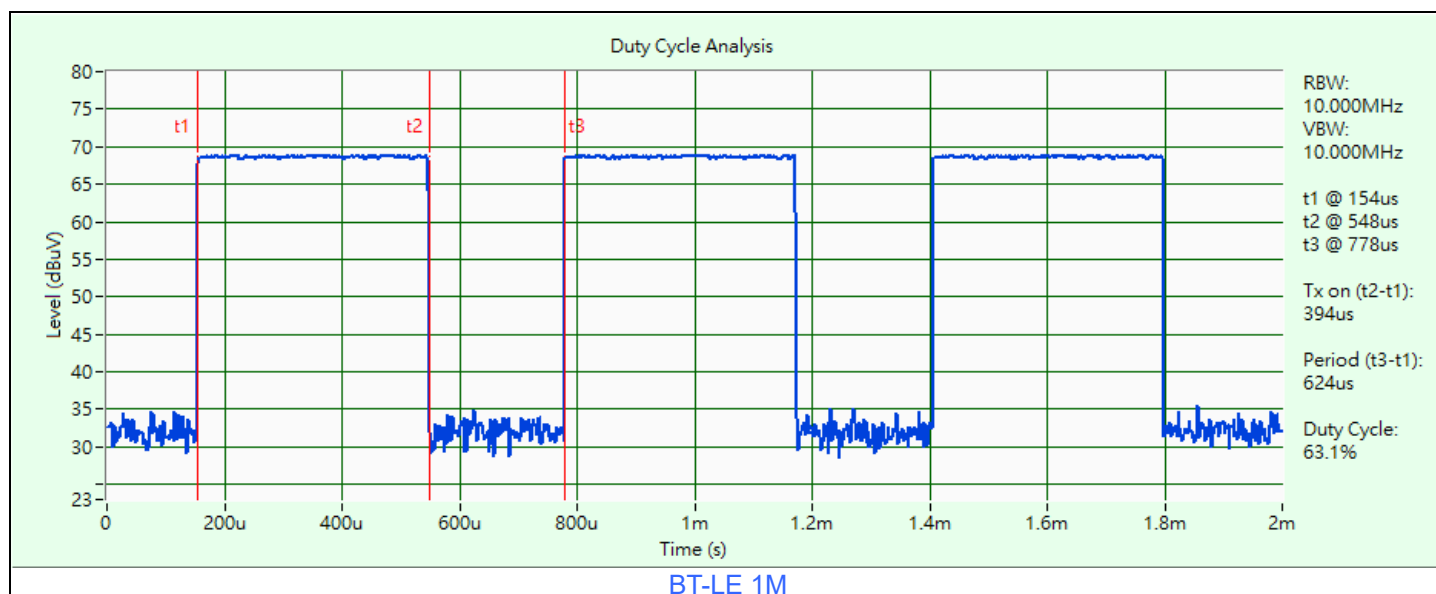



### 3.6 Test Program Used and Operation Descriptions

Controlling software DRTU 22.100.1.1 has been activated to set the EUT under transmission condition continuously at specific channel frequency.

### 3.7 Connection Diagram of EUT and Peripheral Devices

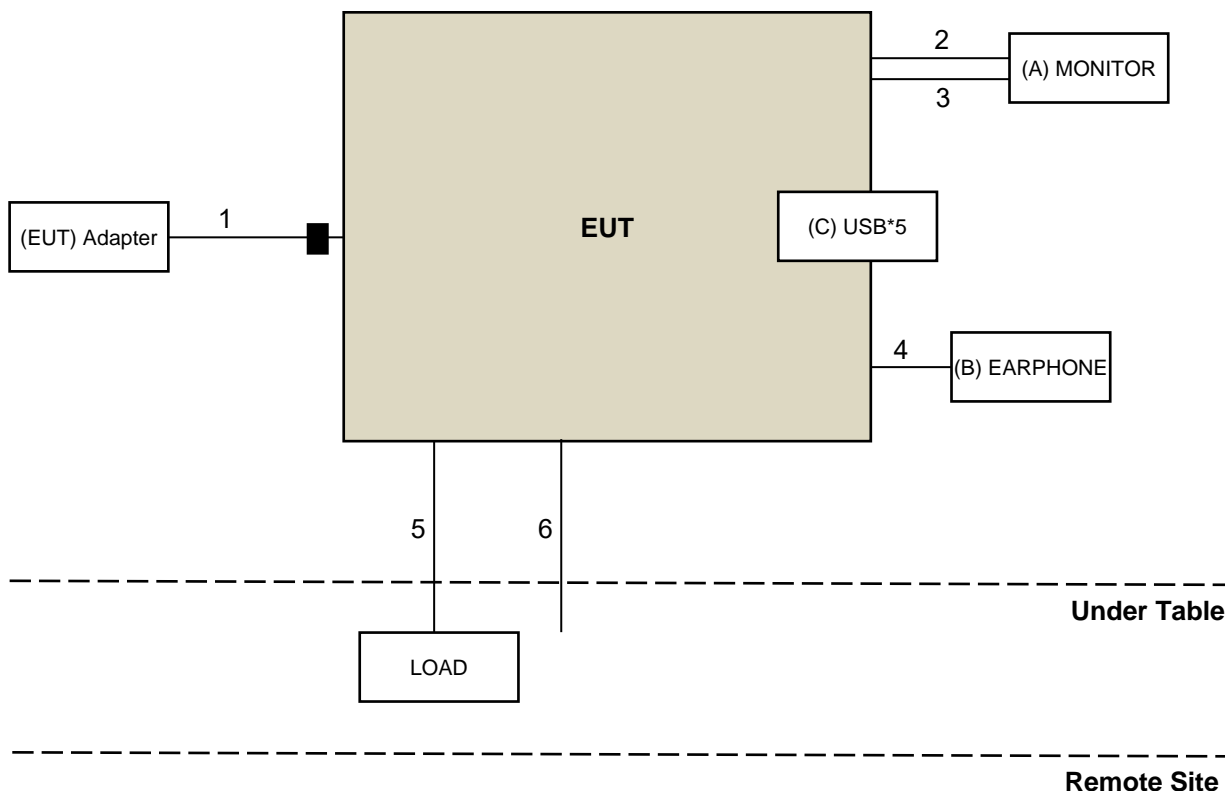

### 3.8 Configuration of Peripheral Devices and Cable Connections

ID	Product	Brand	Model No.	Serial No.	FCC ID	Remarks
A	Monitor	DELL	A14S2421HSXmTW	CN-01KQFW- WSL00-24C-711B	N/A	Provided by Lab
B	EARPHONE	APPLE	MB77PFEB	N/A	N/A	Provided by Lab
C	USB*5	SanDisk	SDDDC3-032G	N/A	N/A	Provided by Lab

ID	Cable Descriptions	Qty.	Length (m)	Shielding (Yes/No)	Cores (Qty.)	Remarks
1	ADAPTER	1	1.2	Y	1	Accessory of EUT
2	HDMI	1	1.8	Y	0	Provided by Lab
3	DP	1	1.8	Y	0	Provided by Lab
4	AUDIO	1	1.2	N	0	Provided by Lab
5	LAN	1	1.8	N	0	Provided by Lab
6	RS232	1	1.5	N	0	Provided by Lab

## 4 Test Instruments

The calibration interval of the all test instruments are 12 months and the calibrations are traceable to NML/ROC and NIST/USA.

### 4.1 RF Output Power

Description Manufacturer	Model No.	Serial No.	Calibrated Date	Calibrated Until
Peak Power Analyzer Keysight	8990B	MY51000485	2024/1/21	2025/1/20
Wideband Power Sensor Keysight	N1923A	MY58020002	2024/1/18	2025/1/17
		MY58140009	2024/1/18	2025/1/17

Notes:

1. The test was performed in Oven room.
2. Tested Date: 2024/3/11

### 4.2 AC Power Conducted Emissions

Description Manufacturer	Model No.	Serial No.	Calibrated Date	Calibrated Until
50 ohm terminal resistance HUBER+SUHNER	E1-011315	13	2023/11/22	2024/11/21
50 ohm terminal resistance	E1-011279	04	2023/11/22	2024/11/21
	E1-011280	05	2023/11/22	2024/11/21
DC-LISN Schwarzbeck	NNBM 8126G	8126G-069	2023/11/7	2024/11/6
EMI Test Receiver R&S	ESR3	102783	2023/12/13	2024/12/12
Fixed Attenuator SGH	BNC10W10dB	PAD-COND2-01	2023/9/2	2024/9/1
LISN R&S	ESH2-Z5	100100	2023/3/7	2024/3/6
	ESH3-Z5	100312	2023/9/12	2024/9/11
RF Coaxial Cable Woken	5D-FB	Cable-cond2-01	2023/9/2	2024/9/1
Software BVADT	BVADT_Cond_ V7.3.7.4	N/A	N/A	N/A
V-LISN Schwarzbeck	NNBL 8226-2	8226-142	2023/8/31	2024/8/30

Notes:

1. The test was performed in HY - Conduction 2.
2. Tested Date: 2024/2/22

### 4.3 Unwanted Emissions below 1 GHz

Description Manufacturer	Model No.	Serial No.	Calibrated Date	Calibrated Until
Antenna Tower & Turn Max-Full	MFA-440H	AT93021705	N/A	N/A
Bi_Log Antenna Schwarzbeck	VULB 9168	9168-472	2023/10/16	2024/10/15
EXA Signal Analyzer Agilent	N9010A	MY52220207	2023/12/28	2024/12/27
Loop Antenna Electro-Metrics	EM-6879	269	2023/9/23	2024/9/22
Loop Antenna TESEQ	HLA 6121	45745	2023/8/8	2024/8/7
MXE EMI Receiver Keysight	N9038A	MY55420137	2023/5/3	2024/5/2
Preamplifier EMCI	EMC 330H	980112	2023/9/27	2024/9/26
	EMC001340	980201	2023/9/27	2024/9/26
RF Coaxial Cable Woken	8D-FB	Cable-Ch10-01	2023/9/27	2024/9/26
Software BV ADT	ADT_Radiated_ V7.6.15.9.5	N/A	N/A	N/A
Turn Table Max-Full	MFT-201SS	N/A	N/A	N/A
Turn Table Controller Max-Full	MG-7802	N/A	N/A	N/A

Notes:

1. The test was performed in HY - 966 chamber 5.
2. Tested Date: 2024/2/21

#### 4.4 Unwanted Emissions above 1 GHz

Description Manufacturer	Model No.	Serial No.	Calibrated Date	Calibrated Until
Antenna Tower & Turn Max-Full	MFA-440H	AT93021705	N/A	N/A
Boresight antenna tower fixture BV	BAF-02	7	N/A	N/A
EXA Signal Analyzer Agilent	N9010A	MY52220207	2023/12/28	2024/12/27
Horn Antenna Schwarzbeck	BBHA 9120D	9120D-969	2023/11/12	2024/11/11
	BBHA 9170	148	2023/11/12	2024/11/11
MXE EMI Receiver Keysight	N9038A	MY55420137	2023/5/3	2024/5/2
Notch Filter Micro-Tronics	BRM17690	004	2024/1/23	2025/1/22
	BRM50716	060	2023/12/25	2024/12/24
Preamplifier EMCI	EMC 012645	980115	2023/9/27	2024/9/26
	EMC 184045	980116	2023/9/27	2024/9/26
RF Coaxial Cable EMCI	EMC102-KM-KM-600	150928	2023/7/8	2024/7/7
	EMC102-KM-KM-3000	150929	2023/7/8	2024/7/7
	EMC104-SM-SM- 8000+3000	171005	2023/9/27	2024/9/26
RF Coaxial Cable HUBER+SUHNER	SUCOFLEX 104	EMC104-SM-SM- 1000(140807)	2023/9/27	2024/9/26
Software BV ADT	ADT_Radiated_ V7.6.15.9.5	N/A	N/A	N/A
Turn Table Max-Full	MFT-201SS	N/A	N/A	N/A
Turn Table Controller Max-Full	MG-7802	N/A	N/A	N/A

Notes:

1. The test was performed in HY - 966 chamber 5.
2. Tested Date: 2024/2/20

## 5 Limits of Test Items

### 5.1 RF Output Power

For systems using digital modulation in the 2400–2483.5 MHz bands: 1 Watt (30 dBm)

### 5.2 AC Power Conducted Emissions

Frequency (MHz)	Conducted Limit (dBuV)	
	Quasi-peak	Average
0.15 - 0.5	66 - 56	56 - 46
0.50 - 5.0	56	46
5.0 - 30.0	60	50

Notes:

1. The lower limit shall apply at the transition frequencies.
2. The limit decreases in line with the logarithm of the frequency in the range of 0.15 to 0.50 MHz.

### 5.3 Unwanted Emissions below 1 GHz

Radiated emissions up to 1 GHz which fall in the restricted bands must comply with the radiated emission limits specified as below table. Other emissions shall be at least 20 dB below the highest level of the desired power:

Frequencies (MHz)	Field Strength (microvolts/meter)	Measurement Distance (meters)
0.009 ~ 0.490	2400/F(kHz)	300
0.490 ~ 1.705	24000/F(kHz)	30
1.705 ~ 30.0	30	30
30 ~ 88	100	3
88 ~ 216	150	3
216 ~ 960	200	3
Above 960	500	3

Notes:

1. The lower limit shall apply at the transition frequencies.
2. Emission level (dBuV/m) = 20 log Emission level (uV/m).

### 5.4 Unwanted Emissions above 1 GHz

Radiated emissions above 1 GHz which fall in the restricted bands must comply with the radiated emission limits specified as below table. Other emissions shall be at least 20 dB below the highest level of the desired power:

Frequencies (MHz)	Field Strength (microvolts/meter)	Measurement Distance (meters)
Above 960	500	3

Notes:

1. The lower limit shall apply at the transition frequencies.
2. Emission level (dBuV/m) = 20 log Emission level (uV/m).
3. For frequencies above 1000 MHz, the field strength limits are based on average detector, however, the peak field strength of any emission shall not exceed the maximum permitted average limits, specified above by more than 20 dB under any condition of modulation.

## 6 Test Arrangements

### 6.1 RF Output Power

#### 6.1.1 Test Setup

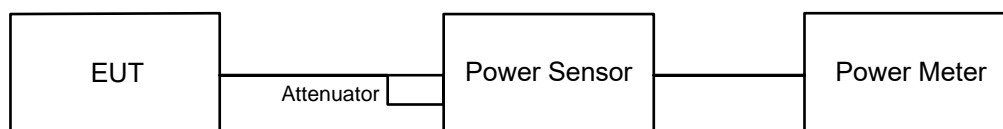

#### 6.1.2 Test Procedure

##### Peak Power:

A peak power sensor was used on the output port of the EUT. A power meter was used to read the response of the peak power sensor. Record the power level.

##### Average Power:

Average power sensor was used to perform output power measurement, trigger and gating function of wide band power meter is enabled to measure max output power of TX on burst. Duty factor is not added to measured value.

### 6.2 AC Power Conducted Emissions

#### 6.2.1 Test Setup

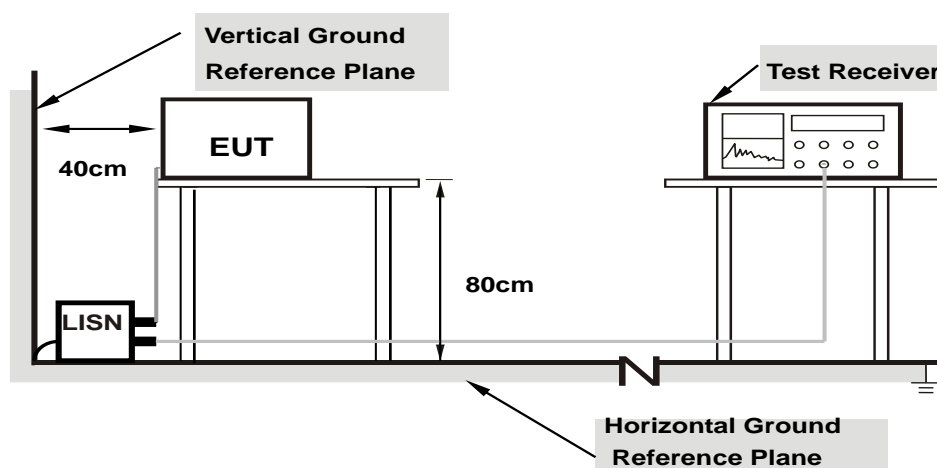

**Note: 1.Support units were connected to second LISN.**

For the actual test configuration, please refer to the attached file (Test Setup Photo).

#### 6.2.2 Test Procedure

- The EUT was placed on a 0.8 meter to the top of table and placed 0.4 meters from the conducting wall of the shielded room with EUT being connected to the power mains through a line impedance stabilization network (LISN). Other support units were connected to the power mains through another LISN. The two LISNs provide 50 ohm/ 50 uH of coupling impedance for the measuring instrument.
- Both lines of the power mains connected to the EUT were checked for maximum conducted interference.
- The frequency range from 150 kHz to 30 MHz was searched. Emission levels under (Limit – 20 dB) was not recorded.

Note: The resolution bandwidth and video bandwidth of test receiver is 9 kHz for quasi-peak detection (QP) and average detection (AV) at frequency 0.15 MHz-30 MHz.

### 6.3 Unwanted Emissions below 1 GHz

#### 6.3.1 Test Setup

##### For Radiated emission below 30 MHz

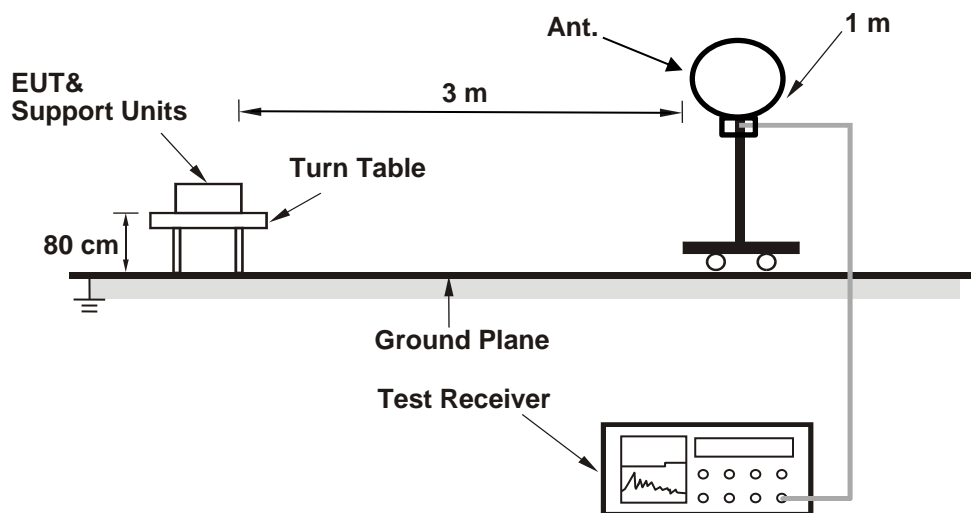

##### For Radiated emission above 30 MHz

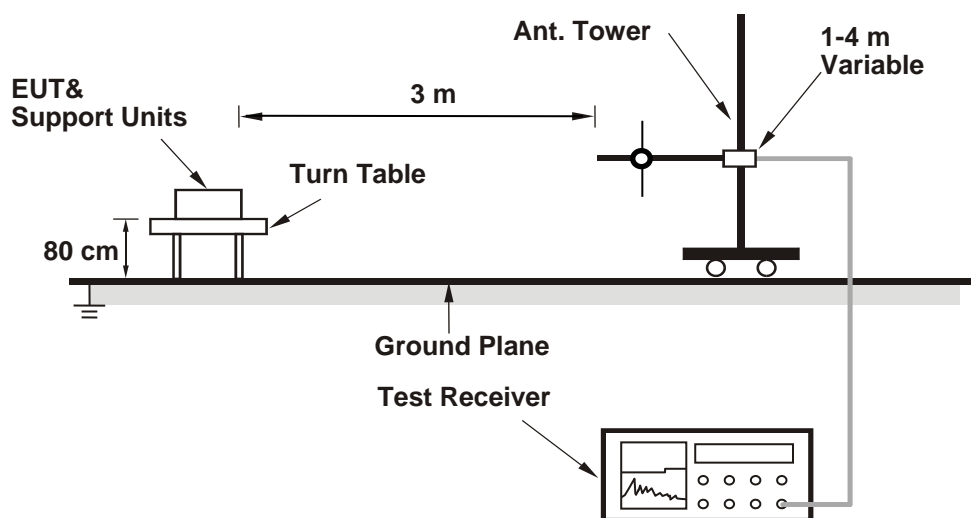

For the actual test configuration, please refer to the attached file (Test Setup Photo).

### 6.3.2 Test Procedure

#### For Radiated emission below 30 MHz

- a. The EUT was placed on the top of a rotating table 0.8 meters above the ground at 3 meter chamber room for test. The table was rotated 360 degrees to determine the position of the highest radiation.
- b. The EUT was set 3 meters away from the interference-receiving antenna, which was mounted on the top of a variable-height antenna tower.
- c. Parallel, perpendicular, and ground-parallel orientations of the antenna are set to make the measurement.
- d. For each suspected emission, the EUT was arranged to its worst case and the rotatable table was turned from 0 degrees to 360 degrees to find the maximum reading.
- e. The test-receiver system was set to Quasi-Peak Detect Function and Specified Bandwidth with Maximum Hold Mode, except for the frequency band (9 kHz to 90 kHz and 110 kHz to 490 kHz) set to average detect function and peak detect function.

#### Notes:

1. The resolution bandwidth and video bandwidth of test receiver/spectrum analyzer is 200 Hz at frequency below 150 kHz.
2. The resolution bandwidth and video bandwidth of test receiver/spectrum analyzer is 9 kHz or 10 kHz at frequency (150 kHz to 30 MHz).
3. All modes of operation were investigated and the worst-case emissions are reported.

#### For Radiated emission above 30 MHz

- a. The EUT was placed on the top of a rotating table 0.8 meters above the ground at 3 meter chamber room for test. The table was rotated 360 degrees to determine the position of the highest radiation.
- b. The EUT was set 3 meters away from the interference-receiving antenna, which was mounted on the top of a variable-height antenna tower.
- c. The height of antenna is varied from one meter to four meters above the ground to determine the maximum value of the field strength. Both horizontal and vertical polarizations of the antenna are set to make the measurement.
- d. For each suspected emission, the EUT was arranged to its worst case and then the antenna was tuned to heights from 1 meter to 4 meters and the rotatable table was turned from 0 degrees to 360 degrees to find the maximum reading.
- e. The test-receiver system was set to quasi-peak detect function and specified bandwidth with maximum hold mode when the test frequency is below 1 GHz.

#### Notes:

1. The resolution bandwidth and video bandwidth of test receiver/spectrum analyzer is 120 kHz for Quasi-peak detection (QP) at frequency below 1 GHz.
2. All modes of operation were investigated and the worst-case emissions are reported.



## 6.4 Unwanted Emissions above 1 GHz

### 6.4.1 Test Setup

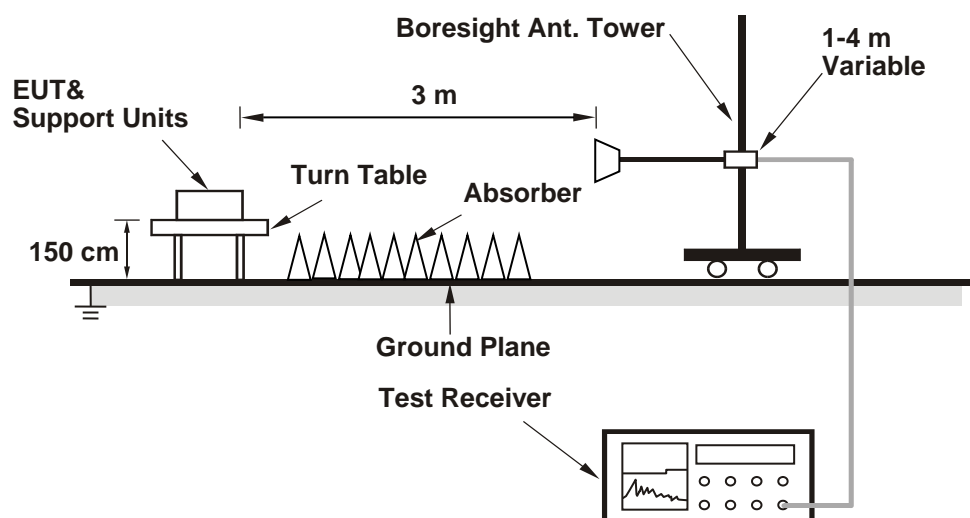

For the actual test configuration, please refer to the attached file (Test Setup Photo).

### 6.4.2 Test Procedure

- The EUT was placed on the top of a rotating table 1.5 meters above the ground at 3 meter chamber room for test. The table was rotated 360 degrees to determine the position of the highest radiation.
- The EUT was set 3 meters away from the interference-receiving antenna, which was mounted on the top of a variable-height antenna tower.
- The height of antenna is varied from one meter to four meters above the ground to determine the maximum value of the field strength. Both horizontal and vertical polarizations of the antenna are set to make the measurement.
- For each suspected emission, the EUT was arranged to its worst case and then the antenna was tuned to heights from 1 meter to 4 meters and the rotatable table was turned from 0 degrees to 360 degrees to find the maximum reading.
- The test-receiver/spectrum analyzer was set to peak and average detects function and specified bandwidth with maximum hold mode when the test frequency is above 1 GHz. If the peak reading value also meets average limit, measurement with the average detector is unnecessary.

#### Notes:

- The resolution bandwidth of test receiver/spectrum analyzer is 1 MHz and the video bandwidth is 3 MHz for Peak detection (PK) and Average detection (AV) at frequency above 1 GHz.
- For harmonic signal measurement, the resolution bandwidth of test receiver/spectrum analyzer is 1 MHz and the video bandwidth is  $\geq 1/T$  (Duty cycle  $< 98\%$ ) or 10 Hz (Duty cycle  $\geq 98\%$ ) for Average detection (AV) at frequency above 1 GHz.
- All modes of operation were investigated and the worst-case emissions are reported.

## 7 Test Results of Test Item

### 7.1 RF Output Power

Input Power:	10.8 Vdc	Environmental Conditions:	25°C, 60% RH	Tested By:	Jisyong Wang
--------------	----------	---------------------------	--------------	------------	--------------

#### For Peak Power

##### BT-LE 1M

Chan.	Chan. Freq. (MHz)	Peak Power (mW)	Peak Power (dBm)	Power Limit (dBm)	Test Result
0	2402	6.699	8.26	30	Pass
19	2440	7.112	8.52	30	Pass
39	2480	7.727	8.88	30	Pass

Note: The antenna gain is 1.68 dBi < 6 dBi, so the output power limit shall not be reduced.

##### BT-LE 2M

Chan.	Chan. Freq. (MHz)	Peak Power (mW)	Peak Power (dBm)	Power Limit (dBm)	Test Result
0	2402	6.683	8.25	30	Pass
19	2440	7.096	8.51	30	Pass
39	2480	7.709	8.87	30	Pass

Note: The antenna gain is 1.68 dBi < 6 dBi, so the output power limit shall not be reduced.

#### For Average Power

##### BT-LE 1M

Chan.	Chan. Freq. (MHz)	Average Power (mW)	Average Power (dBm)
0	2402	6.457	8.10
19	2440	6.823	8.34
39	2480	7.379	8.68

##### BT-LE 2M

Chan.	Chan. Freq. (MHz)	Average Power (mW)	Average Power (dBm)
0	2402	6.427	8.08
19	2440	6.792	8.32
39	2480	7.345	8.66

## 7.2 AC Power Conducted Emissions

RF Mode	BT-LE 1M	Channel	CH 39 : 2480 MHz
Frequency Range	150 kHz ~ 30 MHz	Detector Function & Resolution Bandwidth	Quasi-Peak (QP) / Average (AV), 9 kHz
Input Power	120 Vac, 60 Hz	Environmental Conditions	22°C, 67% RH
Tested By	Vincent Chen		

Phase Of Power : Line (L)										
No	Frequency (MHz)	Correction Factor (dB)	Reading Value (dBuV)		Emission Level (dBuV)		Limit (dBuV)		Margin (dB)	
			Q.P.	AV.	Q.P.	AV.	Q.P.	AV.	Q.P.	AV.
1	0.22985	10.35	25.20	9.04	35.55	19.39	62.46	52.46	-26.91	-33.07
2	0.34577	10.40	20.20	5.53	30.60	15.93	59.06	49.06	-28.46	-33.13
3	0.52200	10.42	23.40	6.19	33.82	16.61	56.00	46.00	-22.18	-29.39
4	1.27800	10.43	18.81	3.44	29.24	13.87	56.00	46.00	-26.76	-32.13
5	3.37000	10.49	9.52	0.59	20.01	11.08	56.00	46.00	-35.99	-34.92
6	21.89800	10.68	16.35	5.24	27.03	15.92	60.00	50.00	-32.97	-34.08

### Remarks:

1. Q.P. and AV. are abbreviations of quasi-peak and average individually.
2. The emission levels of other frequencies were very low against the limit.
3. Margin value = Emission level – Limit value
4. Correction factor = Insertion loss + Cable loss
5. Emission Level = Correction Factor + Reading Value

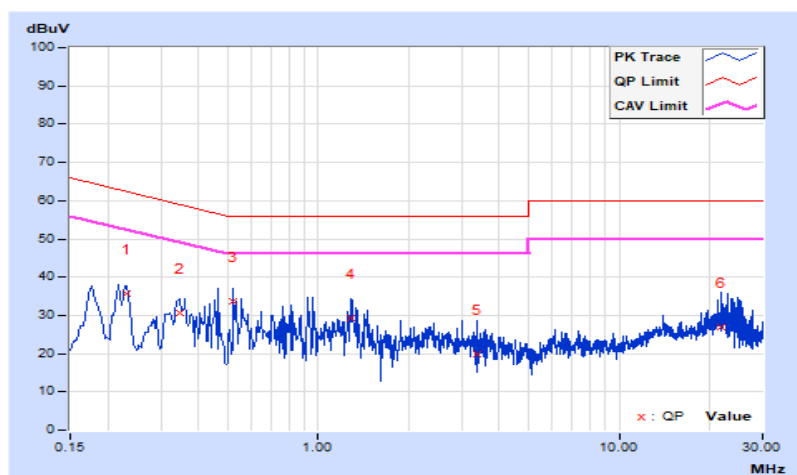

RF Mode	BT-LE 1M	Channel	CH 39 : 2480 MHz
Frequency Range	150 kHz ~ 30 MHz	Detector Function & Resolution Bandwidth	Quasi-Peak (QP) / Average (AV), 9 kHz
Input Power	120 Vac, 60 Hz	Environmental Conditions	22°C, 67% RH
Tested By	Vincent Chen		

Phase Of Power : Neutral (N)										
No	Frequency (MHz)	Correction Factor (dB)	Reading Value (dBuV)		Emission Level (dBuV)		Limit (dBuV)		Margin (dB)	
			Q.P.	AV.	Q.P.	AV.	Q.P.	AV.	Q.P.	AV.
1	0.23785	10.38	28.97	15.25	39.35	25.63	62.17	52.17	-22.82	-26.54
<b>2</b>	<b>0.51400</b>	<b>10.44</b>	<b>25.73</b>	<b>7.18</b>	<b>36.17</b>	<b>17.62</b>	<b>56.00</b>	<b>46.00</b>	<b>-19.83</b>	<b>-28.38</b>
3	0.93800	10.45	20.51	4.44	30.96	14.89	56.00	46.00	-25.04	-31.11
4	2.15000	10.45	13.18	1.07	23.63	11.52	56.00	46.00	-32.37	-34.48
5	6.71400	10.60	9.55	3.62	20.15	14.22	60.00	50.00	-39.85	-35.78
6	24.55800	10.75	16.99	3.36	27.74	14.11	60.00	50.00	-32.26	-35.89

**Remarks:**

1. Q.P. and AV. are abbreviations of quasi-peak and average individually.
2. The emission levels of other frequencies were very low against the limit.
3. Margin value = Emission level – Limit value
4. Correction factor = Insertion loss + Cable loss
5. Emission Level = Correction Factor + Reading Value

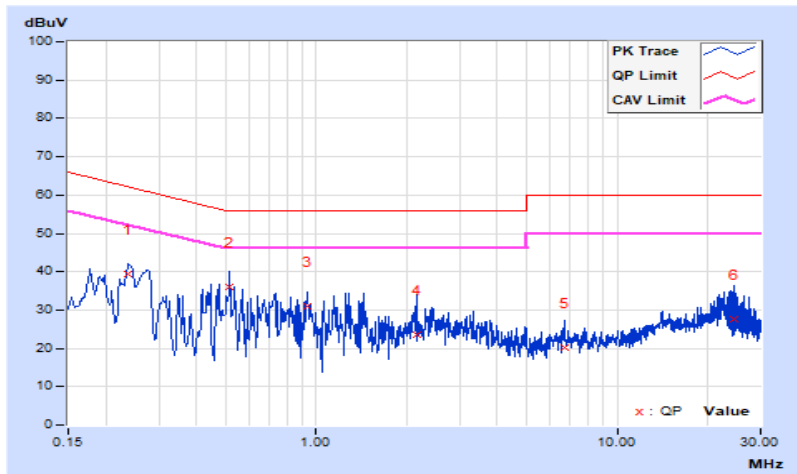

### 7.3 Unwanted Emissions below 1 GHz

<b>RF Mode</b>	BT-LE 1M	<b>Channel</b>	CH 39 : 2480 MHz
<b>Frequency Range</b>	30 MHz ~ 1 GHz	<b>Detector Function &amp; Bandwidth</b>	QP: RB=120kHz, DET=Quasi-Peak
<b>Input Power</b>	120 Vac, 60 Hz	<b>Environmental Conditions</b>	23°C, 68% RH
<b>Tested By</b>	Vincent Chen		

Antenna Polarity & Test Distance : Horizontal at 3 m								
No	Frequency (MHz)	Emission Level (dBuV/m)	Limit (dBuV/m)	Margin (dB)	Antenna Height (m)	Table Angle (Degree)	Raw Value (dBuV)	Correction Factor (dB/m)
1	77.53	29.7 QP	40.0	-10.3	1.00 H	148	46.5	-16.8
2	188.11	34.4 QP	43.5	-9.1	2.00 H	86	49.4	-15.0
3	418.00	37.4 QP	46.0	-8.6	1.00 H	251	46.6	-9.2
4	509.18	32.2 QP	46.0	-13.8	2.00 H	316	38.8	-6.6
5	660.50	28.0 QP	46.0	-18.0	1.00 H	2	32.0	-4.0
6	878.75	31.8 QP	46.0	-14.2	1.50 H	18	32.7	-0.9

#### Remarks:

1. Emission Level(dBuV/m) = Raw Value(dBuV) + Correction Factor(dB/m)
2. Correction Factor(dB/m) = Antenna Factor(dB/m) + Cable Factor(dB) – Pre-Amplifier Factor(dB)
3. Margin value = Emission Level – Limit value
4. The other emission levels were very low against the limit of frequency range 30 MHz ~ 1 GHz.
5. The frequency range 9 kHz ~ 30 MHz: all emissions are more than 20 dB below the limit, therefore do not be recorded in this report.

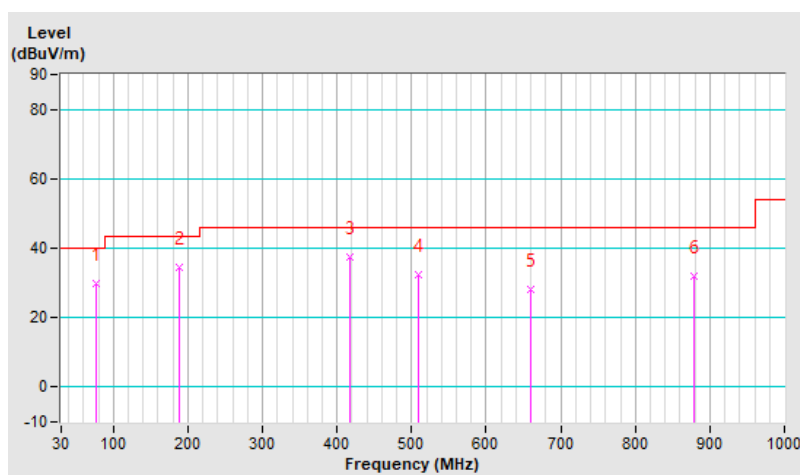

<b>RF Mode</b>	BT-LE 1M	<b>Channel</b>	CH 39 : 2480 MHz
<b>Frequency Range</b>	30 MHz ~ 1 GHz	<b>Detector Function &amp; Bandwidth</b>	QP: RB=120kHz, DET=Quasi-Peak
<b>Input Power</b>	120 Vac, 60 Hz	<b>Environmental Conditions</b>	23°C, 68% RH
<b>Tested By</b>	Vincent Chen		

Antenna Polarity & Test Distance : Vertical at 3 m								
No	Frequency (MHz)	Emission Level (dBuV/m)	Limit (dBuV/m)	Margin (dB)	Antenna Height (m)	Table Angle (Degree)	Raw Value (dBuV)	Correction Factor (dB/m)
1	76.56	31.4 QP	40.0	-8.6	1.50 V	245	47.8	-16.4
2	165.80	31.0 QP	43.5	-12.5	1.00 V	228	44.0	-13.0
<b>3</b>	<b>421.88</b>	<b>38.8 QP</b>	<b>46.0</b>	<b>-7.2</b>	<b>1.00 V</b>	<b>18</b>	<b>47.8</b>	<b>-9.0</b>
4	538.28	33.6 QP	46.0	-12.4	1.01 V	220	39.8	-6.2
5	675.05	29.9 QP	46.0	-16.1	1.50 V	299	33.5	-3.6
6	895.24	31.5 QP	46.0	-14.5	2.00 V	178	32.3	-0.8

**Remarks:**

1. Emission Level(dBuV/m) = Raw Value(dBuV) + Correction Factor(dB/m)
2. Correction Factor(dB/m) = Antenna Factor(dB/m) + Cable Factor(dB) – Pre-Amplifier Factor(dB)
3. Margin value = Emission Level – Limit value
4. The other emission levels were very low against the limit of frequency range 30 MHz ~ 1 GHz.
5. The frequency range 9 kHz ~ 30 MHz: all emissions are more than 20 dB below the limit, therefore do not be recorded in this report.

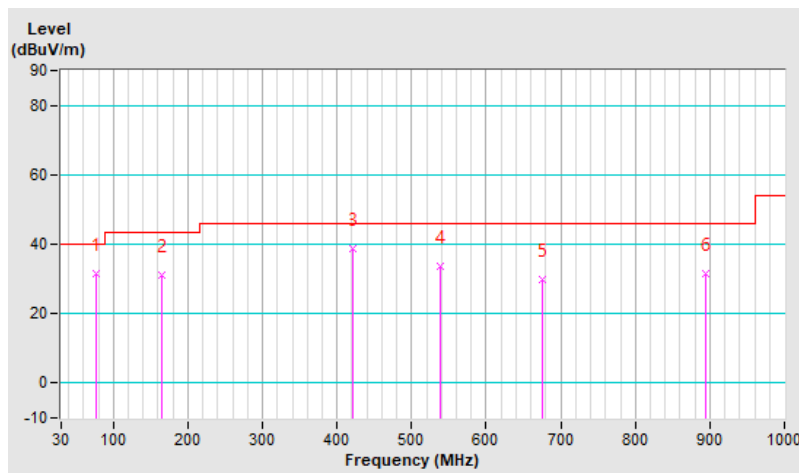

#### 7.4 Unwanted Emissions above 1 GHz

<b>RF Mode</b>	BT-LE 1M	<b>Channel</b>	CH 39 : 2480 MHz
<b>Frequency Range</b>	1 GHz ~ 25 GHz	<b>Detector Function &amp; Bandwidth</b>	PK: RB=1 MHz, VB=3 MHz, DET=Peak AV: RB=1 MHz, VB=3 kHz, DET=Peak
<b>Input Power</b>	120 Vac, 60 Hz	<b>Environmental Conditions</b>	23°C, 67% RH
<b>Tested By</b>	Vincent Chen		

Antenna Polarity & Test Distance : Horizontal at 3 m								
No	Frequency (MHz)	Emission Level (dBuV/m)	Limit (dBuV/m)	Margin (dB)	Antenna Height (m)	Table Angle (Degree)	Raw Value (dBuV)	Correction Factor (dB/m)
1	*2480.00	103.8 PK			1.75 H	145	68.8	35.0
2	*2480.00	99.6 AV			1.75 H	145	64.6	35.0
3	2483.50	60.8 PK	74.0	-13.2	1.75 H	145	25.8	35.0
<b>4</b>	<b>2483.50</b>	<b>48.4 AV</b>	<b>54.0</b>	<b>-5.6</b>	<b>1.75 H</b>	<b>145</b>	<b>13.4</b>	<b>35.0</b>
5	4960.00	52.2 PK	74.0	-21.8	2.57 H	287	42.8	9.4
6	4960.00	38.4 AV	54.0	-15.6	2.57 H	287	29.0	9.4
Antenna Polarity & Test Distance : Vertical at 3 m								
No	Frequency (MHz)	Emission Level (dBuV/m)	Limit (dBuV/m)	Margin (dB)	Antenna Height (m)	Table Angle (Degree)	Raw Value (dBuV)	Correction Factor (dB/m)
1	*2480.00	101.4 PK			2.88 V	141	66.4	35.0
2	*2480.00	97.3 AV			2.88 V	141	62.3	35.0
3	2483.50	60.7 PK	74.0	-13.3	2.88 V	141	25.7	35.0
4	2483.50	48.2 AV	54.0	-5.8	2.88 V	141	13.2	35.0
5	4960.00	51.9 PK	74.0	-22.1	1.85 V	225	42.5	9.4
6	4960.00	38.2 AV	54.0	-15.8	1.85 V	225	28.8	9.4

#### Remarks:

1. Emission Level(dBuV/m) = Raw Value(dBuV) + Correction Factor(dB/m)
2. Correction Factor(dB/m) = Antenna Factor(dB/m) + Cable Factor(dB) – Pre-Amplifier Factor(dB)
3. Margin value = Emission Level – Limit value
4. The other emission levels were very low against the limit.
5. " \* " : Fundamental frequency, the limit was restricted at the RF Output Power.

### Plot of Band Edge

Frequency Range	2.462 GHz ~ 2.5 GHz	Detector Function & Bandwidth	PK: RB=1 MHz, VB=3 MHz, DET=Peak AV: RB=1 MHz, VB=3 kHz, DET=Peak
-----------------	---------------------	-------------------------------	--

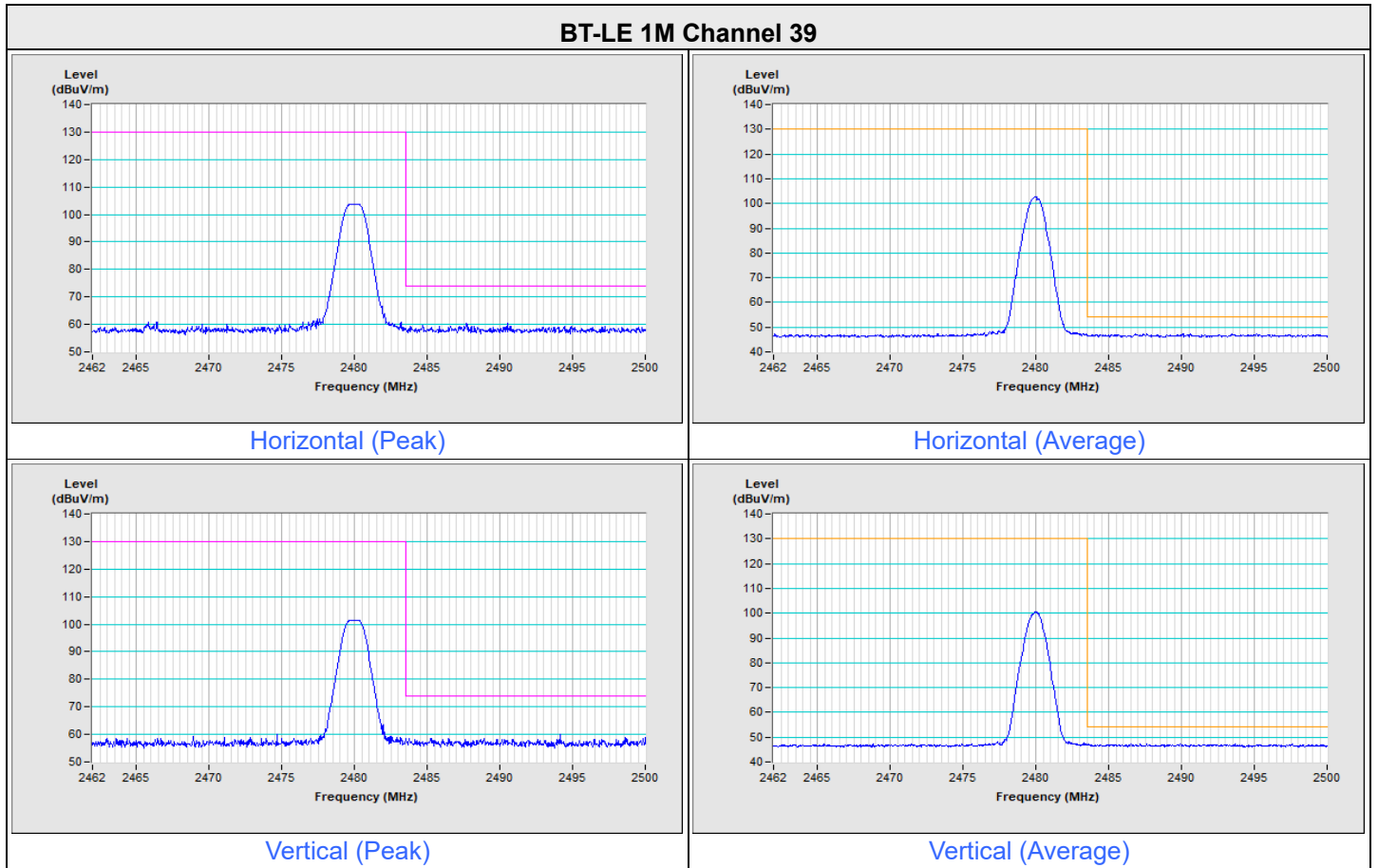



## 8 Pictures of Test Arrangements

Please refer to the attached file (Test Setup Photo)

## 9 Information of the Testing Laboratories

We, Bureau Veritas Consumer Products Services (H.K.) Ltd., Taoyuan Branch, were founded in 1988 to provide our best service in EMC, Radio, Telecom and Safety consultation. Our laboratories are FCC recognized accredited test firms and accredited according to ISO/IEC 17025.

If you have any comments, please feel free to contact us at the following:

**Lin Kou EMC/RF Lab**

Tel: 886-2-26052180

Fax: 886-2-26051924

**Hsin Chu EMC/RF/Telecom Lab**

Tel: 886-3-6668565

Fax: 886-3-6668323

**Hwa Ya EMC/RF/Safety Lab**

Tel: 886-3-3183232

Fax: 886-3-3270892

**Email:** [service.adt@bureauveritas.com](mailto:service.adt@bureauveritas.com)

**Web Site:** <http://ee.bureauveritas.com.tw>

The address and road map of all our labs can be found in our web site also.

--- END ---