

Prüfbericht-Nr.: <i>Test report no.:</i>	CN232OYL (P15C-BLE) 001	Auftrags-Nr.: <i>Order no.:</i>	48224241	Seite 1 von 25 Page 1 of 25
Kunden-Referenz-Nr.: <i>Client reference no.:</i>	N/A	Auftragsdatum: <i>Order date:</i>	2023-09-23	
Auftraggeber: <i>Client:</i>	Getac Technology Corporation. 5F., Building A, No. 209, Sec.1, Nangang Rd.,Nangang Dist., Taipei City 11568, Taiwan, R.O.C.			
Prüfgegenstand: <i>Test item:</i>	Tablet PC			
Bezeichnung / Typ-Nr.: <i>Identification / Type no.:</i>	F110,F110-501			
Auftrags-Inhalt: <i>Order content:</i>	FCC Part 15C Test report (BLE)			
Prüfgrundlage: <i>Test specification:</i>	FCC 47CFR Part 15: Subpart C Section 15.247			
Wareneingangsdatum: <i>Date of sample receipt:</i>	2023-09-26			
Prüfmuster-Nr.: <i>Test sample no:</i>	A003570410-001 A003570410-003			
Prüfzeitraum: <i>Testing period:</i>	2023-09-22 - 2023-10-06			
Ort der Prüfung: <i>Place of testing:</i>	EMC/RF Taipei Testing Site			
Prüflaboratorium: <i>Testing laboratory:</i>	Taipei Testing Laboratories			
Prüfergebnis*: <i>Test result*:</i>	Pass			
zusammengestellt von: <i>compiled by:</i>			genehmigt von: <i>authorized by:</i>	
Datum: <i>Date:</i>	2023-10-11	Ausstellungsdatum: <i>Issue date:</i>	2023-10-11	
Stellung / Position:	David Huang Project Manager	Stellung / Position:	Brenda Chen Senior Project Manager	
Sonstiges / Other:	Only RF output power, radiated spurious emissions and mains conduction tests were evaluated in this report. For other test results, please refer to module report no.: 180717-02.TR04.			
Zustand des Prüfgegenstandes bei Anlieferung: <i>Condition of the test item at delivery:</i>	Prüfmuster vollständig und unbeschädigt <i>Test item complete and undamaged</i>			
* Legende:	1 = sehr gut P(ass) = entspricht o.g. Prüfgrundlage(n)	2 = gut F(ail) = entspricht nicht o.g. Prüfgrundlage(n)	3 = befriedigend N/A = nicht anwendbar	4 = ausreichend N/T = nicht getestet
* Legend:	1 = very good P(ass) = passed a.m. test specification(s)	2 = good F(ail) = failed a.m. test specification(s)	3 = satisfactory N/A = not applicable	4 = sufficient N/T = not tested
Dieser Prüfbericht bezieht sich nur auf das o.g. Prüfmuster und darf ohne Genehmigung der Prüfstelle nicht auszugsweise vervielfältigt werden. Dieser Bericht berechtigt nicht zur Verwendung eines Prüfzeichens. <i>This test report only relates to the a. m. test sample. Without permission of the test center this test report is not permitted to be duplicated in extracts. This test report does not entitle to carry any test mark.</i>				

TEST SUMMARY

Report Section	FCC Clause	Test Item	Result
5.1.1	15.247(b) & 15.203	Antenna Requirement	Pass
5.1.2	15.247(b)(3)	Peak Output Power	Pass
-	15.247(a)(2)	6 dB Bandwidth	Note 1
-	2.1049	99% Occupied Bandwidth	N/A
-	15.247(e)	Power Spectral Density	Note 1
-	15.247(d)	Conducted Spurious Emissions and Band Edges	Note 1
5.1.3	15.247(d) & 15.205 & 15.209	Radiated Spurious Emissions and Band Edges	Pass
5.2.1	15.207	Mains Conducted Emission	Pass

Note:

1. Refer to module report for the details.
2. Determining compliance based on the results of the compliance measurement, not taking into account measurement instrumentation uncertainty.

Contents

HISTORY OF THIS TEST REPORT	5
1. GENERAL REMARKS	6
1.1 COMPLEMENTARY MATERIALS.....	6
1.2 DECISION RULE OF CONFORMITY	6
2. TEST SITES	7
2.1 TEST LABORATORY	7
2.2 TEST FACILITY.....	7
2.3 TRACEABILITY	8
2.4 CALIBRATION	8
2.5 MEASUREMENT UNCERTAINTY	8
3. GENERAL PRODUCT INFORMATION.....	9
3.1 PRODUCT FUNCTION AND INTENDED USE	9
3.2 SYSTEM DETAILS AND RATINGS.....	9
3.3 NOISE GENERATING AND NOISE SUPPRESSING PARTS	10
3.4 SUBMITTED DOCUMENTS.....	10
4. TEST SET-UP AND OPERATION MODES.....	11
4.1 PRINCIPLE OF CONFIGURATION SELECTION	11
4.2 CARRIER FREQUENCY AND CHANNEL.....	11
4.3 TEST OPERATION AND TEST SOFTWARE.....	12
4.4 SPECIAL ACCESSORIES AND AUXILIARY EQUIPMENT	13
4.5 TEST SETUP DIAGRAM	14
4.6 DUTY CYCLE OF TEST SIGNAL	15
5. TEST RESULTS	16
5.1 TRANSMITTER REQUIREMENT & TEST SUITES.....	16
5.1.1 <i>Antenna Requirement</i>	<i>16</i>
5.1.2 <i>Peak Output Power</i>	<i>17</i>
5.1.3 <i>Radiated Spurious Emissions and Band Edges</i>	<i>19</i>
5.2 MAINS EMISSION	24
5.2.1 <i>Mains Conducted Emission.....</i>	<i>24</i>

Prüfbericht - Nr.: CN232OYL (P15C-BLE) 001
Test Report No.

Seite 4 von 25
Page 4 of 25

APPENDIX A - TEST RESULT OF RADIATED EMISSIONS & MAINS CONDUCTED EMISSION

APPENDIX SP - PHOTOGRAPHS OF TEST SETUP

APPENDIX EP - PHOTOGRAPHS OF EUT

Prüfbericht - Nr.: CN232OYL (P15C-BLE) 001
Test Report No.

Seite 5 von 25
Page 5 of 25

HISTORY OF THIS TEST REPORT

Revision	Description	Date Issued
R01	Original Release	2023-10-11

1. General Remarks

1.1 Complementary Materials

All attachments are integral parts of this test report. This applies especially to the following appendix:

Appendix A - Test Result of Radiated Emissions & Mains Conducted Emission

Appendix SP - Photographs of Test Setup

Appendix EP - Photographs of EUT

Applied Standard and Test Levels

Radio
FCC 47CFR Part 15: Subpart C Section 15.247
FCC 47CFR Part 2: Subpart J Section 2.1049
ANSI C63.10:2013
KDB 558074 D01 15.247 Meas Guidance v05r02

1.2 Decision Rule of Conformity

The decision rule of conformity of this test report is following the requirements of the requested standard in the quotation, and agreed among testing laboratory and manufacturer (applicant) to exclude the consideration of Measurement Uncertainty, unless it is required by the specific standard.

2. Test Sites

2.1 Test Laboratory

Taipei Testing Laboratories

11F. No.758, Sec. 4, Bade Rd., Songshan Dist.
Taipei City 105
Taiwan (R.O.C.)

2.2 Test Facility

Taipei Testing Laboratories

No.458-18, Sec. 2, Fenliao Rd., Linkou Dist.,
New Taipei City 244
Taiwan (R.O.C.)
FCC Registration No.: 180491
ISED Registration No.: 25563

2.3 Traceability

All measurement equipment calibrations are traceable to NML(Taiwan)/NIST(USA) or where calibration is performed outside Taiwan, to equivalent nationally recognized standards organizations.

2.4 Calibration

Equipment requiring calibration is calibrated periodically in a suitably accredited Calibration Lab. Additionally all equipment is verified for proper performance on a regular basis using in house standards or comparisons.

2.5 Measurement Uncertainty

All measurement uncertainty values are shown with a coverage factor of $k=2$ to indicate a 95% level of confidence.

Emission Measurement Uncertainty

Parameter	Uncertainty
Radiated Emission (9 kHz ~ 30 MHz)	± 1.15 dB
Radiated Emission (30 MHz ~ 200 MHz)	± 1.32 dB
Radiated Emission (200 MHz ~ 1 GHz)	± 1.31 dB
Radiated Emission (1 GHz ~ 18 GHz)	± 1.53 dB
Radiated Emission (18 GHz ~ 40 GHz)	± 2.50 dB
Mains Conducted Emission	± 1.65 dB

3. General Product Information

3.1 Product Function and Intended Use

The EUT is a Tablet PC. It contains a Bluetooth compatible module enabling the user to communicate data through a Wireless interface.

For details refer to the User Guide, Data Sheet and Circuit Diagram.

3.2 System Details and Ratings

Basic Information of EUT

Item	EUT information
Kind of Equipment/Test Item	Tablet PC
Type Identification	F110,F110-501
FCC ID	QYLAX201NG

Technical Specification of EUT

Item	EUT information
Operating Frequency	2402 MHz ~ 2480 MHz
Channel Spacing	2 MHz
Channel Number	40
Data Rate	1Mbps, 2Mbps
Operation Voltage	120Vac
Modulation	GFSK
RF Module	AX201NGW
Maximum Output Power (mW)	4.93
Antenna Information	Refer to 5.1.1
Accessory Device	Refer to 4.4

Note:

- All models are listed as below.

Main Model	Series Model	Difference
F110	F110-501	The purpose of model naming differents is for market segmentation purpose only.

3.3 Noise Generating and Noise Suppressing Parts

Refer to the Circuit Diagram.

3.4 Submitted Documents

- Circuit Diagram
- Instruction Manual
- Rating Label
- Technical Description

4. Test Set-up and Operation Modes

4.1 Principle of Configuration Selection

The test modes were adapted accordingly in reference to the instructions for use.

During testing, Channel and Power Controlling Software provided by the customer was used to control the operating channel as well as the output power level. The RF output power selection is for the setting of RF output expected by the customer and is going to be fixed on the firmware of the final end product.

Table for Parameters of Test Software Setting

Frequency (MHz)	Power Setting
2402	5
2440	6
2480	6

4.2 Carrier Frequency and Channel

Channel	Freq. (MHz)	Channel	Freq. (MHz)	Channel	Freq. (MHz)	Channel	Freq. (MHz)
0	2402	10	2422	20	2442	30	2462
1	2404	11	2424	21	2444	31	2464
2	2406	12	2426	22	2446	32	2466
3	2408	13	2428	23	2448	33	2468
4	2410	14	2430	24	2450	34	2470
5	2412	15	2432	25	2452	35	2472
6	2414	16	2434	26	2454	36	2474
7	2416	17	2436	27	2456	37	2476
8	2418	18	2438	28	2458	38	2478
9	2420	19	2440	29	2460	39	2480

4.3 Test Operation and Test Software

Setup for testing: Test samples are provided with a USB interface which makes it possible to control them through a test software installed on a notebook computer.

This software was running on the laptop computer connected to the EUT. It was used to enable the operation modes listed as below.

Test Software	DRTU
---------------	------

The samples were used as follows:

A003570410-001

A003570410-003

Full test was applied on all test modes, but only worst case was shown.

EUT Configure Mode	Applicable To			Description	
	RF Output Power	Radiated Spurious Emissions above 1 GHz	Radiated Spurious Emissions below 1 GHz		Mains Conducted Emission
-	√	√	√	√	-

Note:

1. The EUT had been pre-tested on the positioned of each 3 axis. The worst case was found when position on **Y-plane**.
2. "-" means no effect.

RF Output Power

- Pre-Scan full test was applied on all test modes, but only worst case was shown.
- Following channel(s) was (were) selected for the final test as listed below.

EUT Configure Mode	Available Frequency (MHz)	Tested Frequency (MHz)	Date Rate (Mbps)
-	2402 to 2480	2402, 2440, 2480	1
	2402 to 2480	2402, 2440, 2480	2

Radiated Spurious Emissions (Above 1 GHz)

- Pre-Scan full test was applied on all test modes, but only worst case was shown.
- Following channel(s) was (were) selected for the final test as listed below.

EUT Configure Mode	Available Frequency (MHz)	Tested Frequency (MHz)	Date Rate (Mbps)
-	2402 to 2480	2440	2

Radiated Spurious Emissions (Below 1 GHz)

- Pre-Scan full test was applied on all test modes, but only worst case was shown.
- Following channel(s) was (were) selected for the final test as listed below.

EUT Configure Mode	Available Frequency (MHz)	Tested Frequency (MHz)	Date Rate (Mbps)
-	2402 to 2480	2440	2

Mains Conducted Emission

- Pre-Scan full test was applied on all test modes, but only worst case was shown.
- Following channel(s) was (were) selected for the final test as listed below.

EUT Configure Mode	Available Frequency (MHz)	Tested Frequency (MHz)	Date Rate (Mbps)
-	2402 to 2480	2440	2

Test Condition

Test Item	Ambient Temperature	Relative Humidity	Tested by
Conducted Measurement	23.4 °C	65 %	Zeke Wang
Radiated Spurious Emissions above 1 GHz	22.6-24.5 °C	52-54 %	Roger Liao
Radiated Spurious Emissions below 1 GHz	22.6-24.5 °C	52-54 %	Roger Liao
Mains Conducted Emission	19.1-25.9 °C	50.2-58.9 %	Roger Liao

4.4 Special Accessories and Auxiliary Equipment

The product has been tested together with the following additional accessories:

Accessory of EUT

No.	Product	Brand	Model	Description
B	Switching Power Adapter	FSP	FSP090-ABBN3	I/P: 100-240 Vac, 50/60 Hz, 1.2 A O/P: 19 Vdc, 4.74 A A003570410-008

Support Unit

Radiated and Mains Conducted Tests								
No	Description	Brand	Model	S/N	Shielded	Ferrite Core (Qty)	Length (cm)	Remark
A	Power cord	Getac	N/A	N/A	NO	NO	180	--
1	Headset	TUV	N/A	N/A	NO	NO	--	--

4.5 Test Setup Diagram

<Radiated Spurious Emissions Mode>

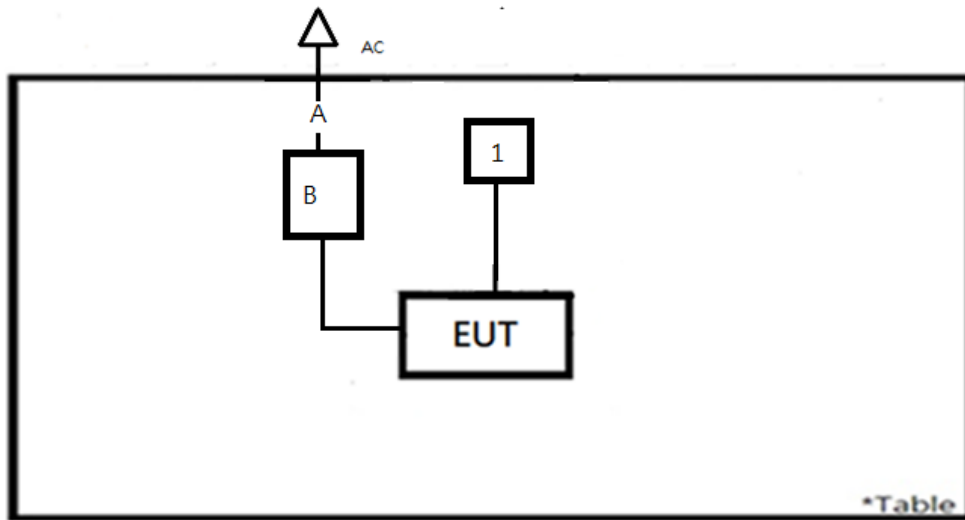

<Mains Conducted Emission Mode>

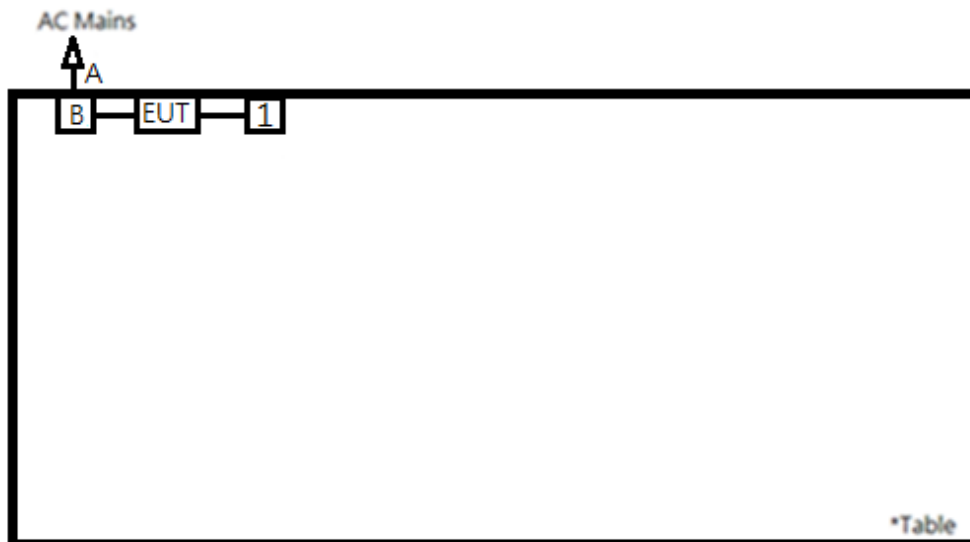

4.6 Duty Cycle of Test Signal

Mode	On + Off Time (ms)	On Time (ms)	Duty Cycle (%)	Duty Factor (dB)
BLE 1Mbps	2.5	2.14	85.60	0.68
BLE 2Mbps	1.88	1.09	57.87	2.38

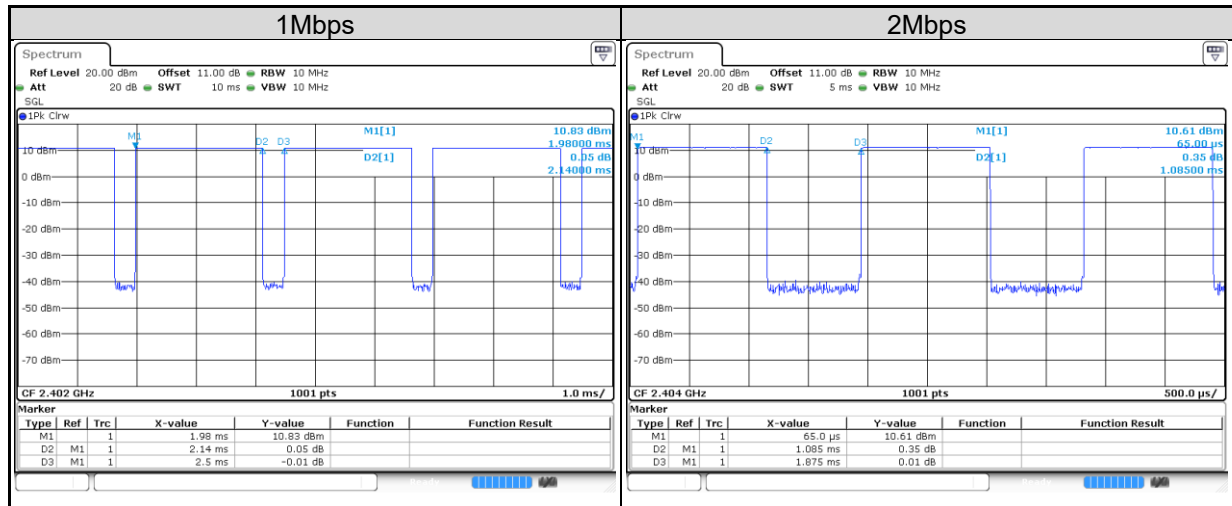

5. Test Results

5.1 Transmitter Requirement & Test Suites

5.1.1 Antenna Requirement

Requirement Use of approved antennas only

According to the manufacturer declaration, the EUT has an antenna with a directional gain of 1.83 dBi. The antenna is a PIFA antenna with no possibility of replacement with a non-approved antenna by the end-user. Therefore, the EUT is considered to comply with this provision.
Refer to EUT photo for details.

5.1.2 Peak Output Power

Limit 1 watt (30 dBm)

Kind of Test Site Shielded room

Test Setup



Test Instruments

Kind of Equipment	Manufacturer	Type	S/N	Calibration Date	Calibration Due Date	Test Date	
						From	Until
Power Meter	Anritsu	ML2495A	1901008	2023/3/17	2024/3/16	2023/9/22	2023/10/6
Power Sensor	Anritsu	MA2411B	1725269	2023/3/17	2024/3/16	2023/9/22	2023/10/6

Test Procedures

A peak power sensor was used on the output port of the EUT. A power meter was used to read the response of the peak power sensor. Record the power level.

Average power sensor was used to perform output power measurement, trigger and gating function of wide band power meter is enabled to measure max output power of TX on burst. Duty factor is not added to measured value.

Test Result
Peak Output Power
<1Mbps>

Channel	Channel Frequency	Peak Output Power		Limit (dBm)
	(MHz)	(dBm)	(mW)	
Low Channel	2402	6.57	4.54	30
Middle Channel	2440	6.91	4.91	30
High Channel	2480	6.93	4.93	30

<2Mbps>

Channel	Channel Frequency	Peak Output Power		Limit (dBm)
	(MHz)	(dBm)	(mW)	
Low Channel	2402	6.55	4.52	30
Middle Channel	2440	6.85	4.84	30
High Channel	2480	6.92	4.92	30

Average Power
<1Mbps>

Channel	Channel Frequency	Average Power	
	(MHz)	(dBm)	(mW)
Low Channel	2402	6.59	4.56
Middle Channel	2440	6.98	4.99
High Channel	2480	6.84	4.83

<2Mbps>

Channel	Channel Frequency	Average Power	
	(MHz)	(dBm)	(mW)
Low Channel	2402	6.47	4.44
Middle Channel	2440	6.76	4.74
High Channel	2480	6.81	4.80

5.1.3 Radiated Spurious Emissions and Band Edges

Limit

Radiated emissions which fall in the restricted bands, as defined in §15.205(a), must comply with the radiated emission limits specified in §15.209(a).

Emissions radiated outside the restricted and authorized frequency bands must either comply with the radiated emission limits specified for the restricted bands or in §15.247(d).

Kind of Test Site 3m Semi-Anechoic Chamber

Test Setup

<Radiated Emissions below 30 MHz>

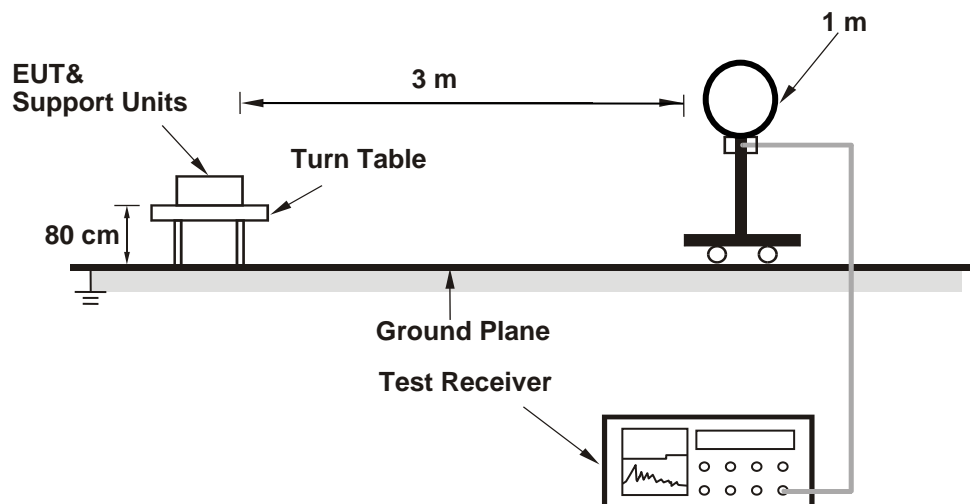

<Radiated Emissions 30 MHz to 1 GHz>

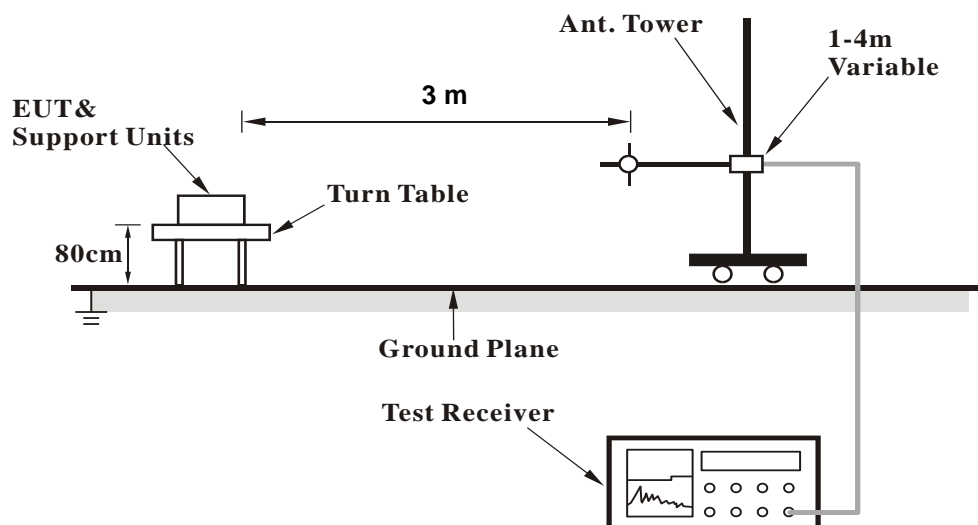

<Radiated Emissions above 1 GHz>

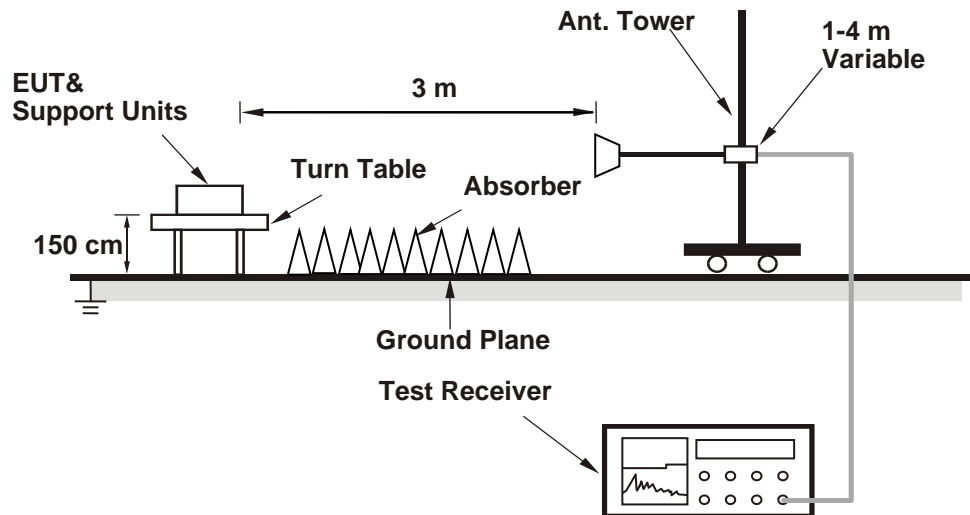

For the actual test configuration, please refer to the attached file (Test Setup Photo).

Test Instruments

Test Date: 2023/10/3 ~ 2023/10/4

Kind of Equipment	Manufacturer	Type	S/N	Calibration Date	Calibration Due Date
Above 1GHz					
Signal Analyzer	R&S	FSV40	101509	2023/4/26	2024/4/24
Horn Antenna	ETS-Lindgren	3117	00218929	2022/11/17	2023/11/16
Horn Antenna	SCHWARZBECK	BBHA 9170	00890	2023/5/4	2024/5/2
HF-AMP + AC source	EMCI	EMC051845SE	980635	2023/2/16	2024/2/15
HF-AMP + AC source	EMCI	EMC051845SE	980656	2023/1/16	2024/1/15
30MHz-1GHz					
Receiver	R&S	ESR7	102109	2023/2/24	2024/2/23
Bilog Antenna	SCHWARZBECK	VULB-9168	00951	2023/3/31	2024/3/29
LF-AMP	Agilent	8447D	2944A107722	2023/3/22	2024/3/20
Below 1GHz					
Receiver	R&S	ESR7	102109	2023/2/24	2024/2/23
Loop Antenna	SCHWARZBECK	FMZB 1519B	00215	2023/1/4	2024/1/3

Test Procedures**For Radiated Emissions below 30 MHz**

- a. The EUT was placed on the top of a rotating table 0.8 meters above the ground at a 3 meter chamber room. The table was rotated 360 degrees to determine the position of the highest radiation.
- b. The EUT was set 3 meters away from the interference-receiving antenna, which was mounted on the top of a variable-height antenna tower.
- c. Parallel (OPEN), perpendicular (CLOSE), and ground-parallel (GROUND) orientations of the antenna are set to make the measurement.
- d. For each suspected emission, the EUT was arranged to its worst case and the rotatable table was turned from 0 degrees to 360 degrees to find the maximum reading.
- e. The test-receiver system was set to Quasi-Peak Detect Function and Specified Bandwidth with Maximum Hold Mode.

Note:

1. The resolution bandwidth and video bandwidth of test receiver/spectrum analyzer is 9 kHz at frequency below 30 MHz.
2. All modes of operation were investigated and the worst-case emissions are reported.

For Radiated Emissions above 30 MHz

- a. The EUT was placed on the top of a rotating table 0.8 meters (for 30 MHz ~ 1 GHz) / 1.5 meters (for above 1 GHz) above the ground at 3 meter chamber room for test. The table was rotated 360 degrees to determine the position of the highest radiation.
- b. The EUT was set 3 meters away from the interference-receiving antenna, which was mounted on the top of a variable-height antenna tower.
- c. The height of antenna is varied from one meter to four meters above the ground to determine the maximum value of the field strength. Both horizontal and vertical polarizations of the antenna are set to make the measurement.
- d. For each suspected emission, the EUT was arranged to its worst case and then the antenna was tuned to heights from 1 meter to 4 meters and the rotatable table was turned from 0 degrees to 360 degrees to find the maximum reading.
- e. The test-receiver system was set to quasi-peak detect function and specified bandwidth with maximum hold mode when the test frequency is below 1 GHz.
- f. The test-receiver system was set to peak and average detected function and specified bandwidth with maximum hold mode when the test frequency is above 1 GHz. If the peak reading value also meets average limit, measurement with the average detector is unnecessary.

Note:

1. The resolution bandwidth and video bandwidth of test receiver/spectrum analyzer is 120 kHz for Quasi-peak detection (QP) or Peak detection (PK) at frequency below 1 GHz.
2. The resolution bandwidth of test receiver/spectrum analyzer is 1 MHz and the video bandwidth is 3 MHz for Peak detection (PK) at frequency above 1 GHz.
3. The resolution bandwidth of test receiver/spectrum analyzer is 1 MHz and the video bandwidth is $\geq 1/T$ (Duty cycle < 98 %) or 10 Hz (Duty cycle ≥ 98 %) for Average detection (AV) at frequency above 1 GHz.
4. All modes of operation were investigated and the worst-case emissions are reported.
5. The Radiated Emissions testing was performed in the X(E1), Y(H) and Z(E2) axis orientation. The worst-case Axis orientation is recorded in this test report.
6. The emission levels of other frequencies (including the 10th harmonic of the highest fundamental frequency) are very lower than the limit and are not shown in the test report.

Prüfbericht - Nr.: CN232OYL (P15C-BLE) 001
Test Report No.

Seite 23 von 25
Page 23 of 25

Test Results

Factor (dB/m) = Antenna Factor (dB/m) + Cable Loss (dB)
Level (dBuV/m) = Reading (dBuV) + Factor (dB/m)

Please refer to Appendix A.

5.2 Mains Emission

5.2.1 Mains Conducted Emission

Limit

Mains Conducted Emission as defined in §15.207 must comply with the mains conducted emission limits.

Kind of Test Site Shielded room

Test Setup

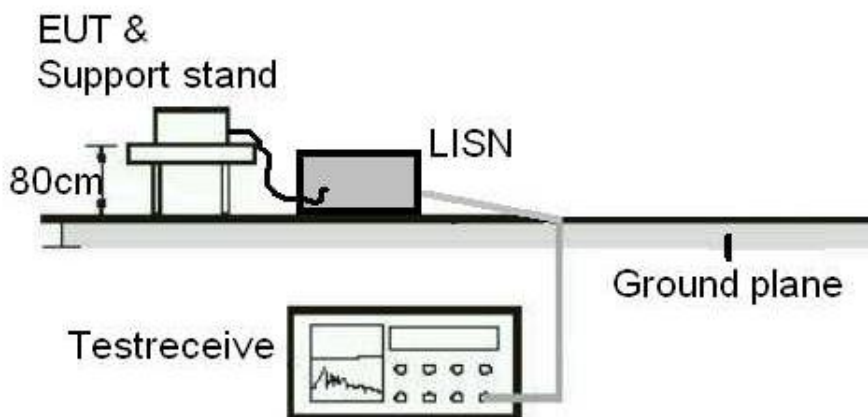

Test Instruments

Test Date: 2023/9/27

Kind of Equipment	Manufacturer	Type	S/N	Calibration Date	Calibration Due Date
Two-Line V-Network	Rohde & Schwarz	ENV216	101938	2022/10/17	2023/10/16
EMI Test Receiver	R&S	ESCI	101094	2022/11/24	2023/11/23

Test Procedures

- a. The EUT was placed 0.4 meters from the conducting wall of the shielded room with EUT being connected to the power mains through a line impedance stabilization network (LISN). Other support units were connected to the power mains through another LISN. The two LISNs provide 50 ohm/50 uH of coupling impedance for the measuring instrument.
- b. Both lines of the power mains connected to the EUT were checked for maximum conducted interference.
- c. The frequency range from 150 kHz to 30 MHz was searched. Emission levels under (Limit – 20 dB) was not recorded.

Note: The resolution bandwidth and video bandwidth of test receiver is 9 kHz for quasi-peak detection (QP) and average detection (AV) at frequency 0.15 MHz – 30 MHz.

Test Results

Please refer to Appendix A.

Appendix A: Test Results of Radiated Spurious Emissions & Mains

Radiated Emission Test

Band Edges, 2.31GHz ~ 2.9GHz

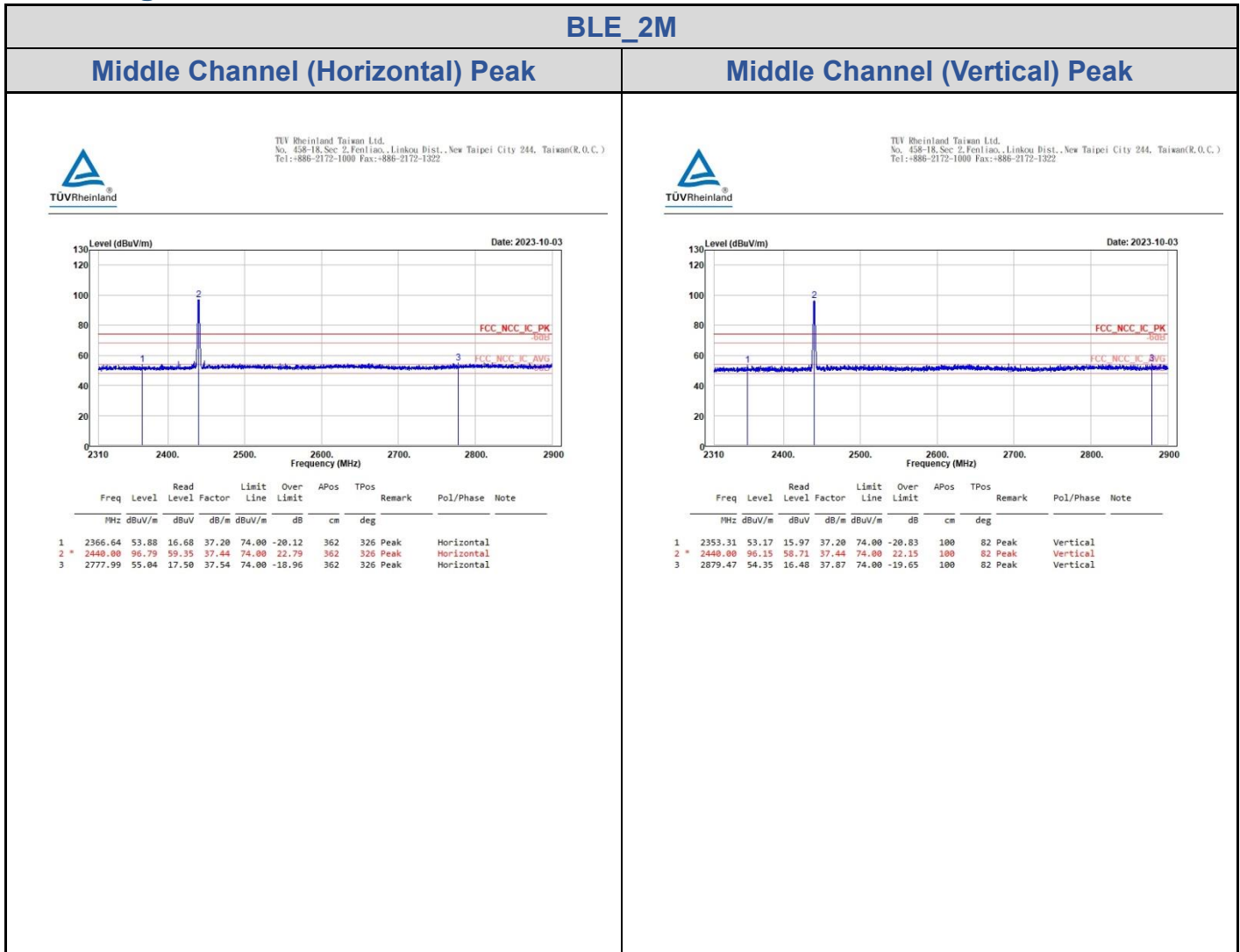

BLE_2M

Middle Channel (Horizontal) Average

Middle Channel (Vertical) Average



TUV Rheinland Taiwan Ltd.
No. 438-18, Sec 2, Fenliao, Linkou Dist., New Taipei City 244, Taiwan(R.O.C.)
Tel: +886-2172-1000 Fax: +886-2172-1322

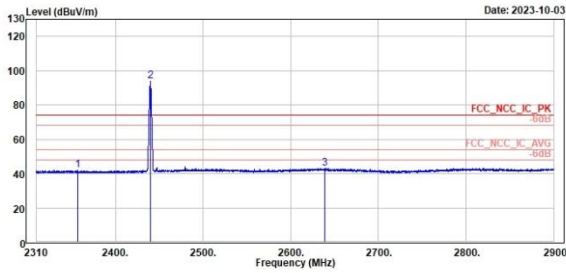

Freq	Level	Read	Limit	Over	APos	TPos	Remark	Pol/Phase	Note
MHz	dBuV/m	dBuV	dB/m	dBuV/m	dB	cm	deg		
1	2356.96	41.86	4.65	37.21	54.00	-12.14	362	326 Average	Horizontal
2 *	2448.00	94.09	56.63	37.44	54.00	40.09	362	326 average	Horizontal
3	2638.51	43.05	5.44	37.61	54.00	-10.95	362	326 Average	Horizontal



TUV Rheinland Taiwan Ltd.
No. 438-18, Sec 2, Fenliao, Linkou Dist., New Taipei City 244, Taiwan(R.O.C.)
Tel: +886-2172-1000 Fax: +886-2172-1322

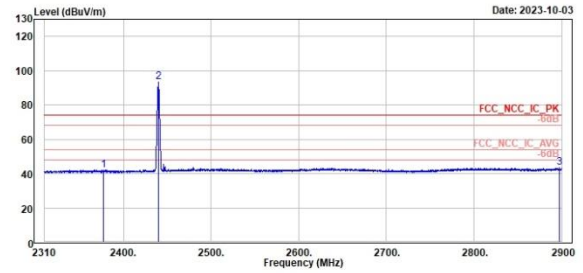

Freq	Level	Read	Limit	Over	APos	TPos	Remark	Pol/Phase	Note
MHz	dBuV/m	dBuV	dB/m	dBuV/m	dB	cm	deg		
1	2377.02	42.00	4.81	37.19	54.00	-12.00	100	82 Average	Vertical
2 *	2448.00	93.54	56.18	37.44	54.00	39.54	100	82 Average	Vertical
3	2897.52	43.36	5.43	37.93	54.00	-10.64	100	82 Average	Vertical

Spurious Emissions, Tx Mode, 9kHz ~ 30MHz

BLE_2M

Middle Channel (Open) 9kHz~150kHz

Middle Channel (Open) 150kHz~30MHz



TUV Rheinland Taiwan Ltd.
 No. 438-18, Sec 2, Fenfiao, Linkou Dist., New Taipei City 244, Taiwan(R.O.C.)
 Tel: +886-2172-1000 Fax: +886-2172-1322

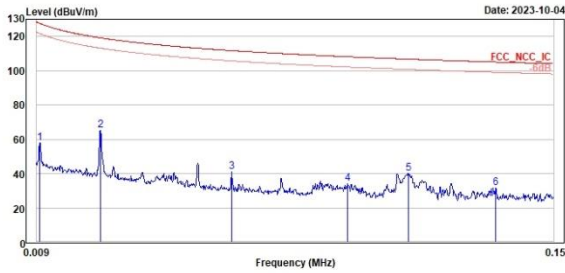

Peak	Freq (MHz)	Level (dBuV/m)	Read Level (dBuV)	Level Factor (dB/m)	Limit Line (dBuV/m)	Over Limit (dB)	APos (cm)	TPos (deg)	Remark	PoL/Phase	Note
1	0.01	57.74	39.95	17.79	127.72	-69.98	100	42	Peak	Open	
2	0.03	65.25	46.30	18.95	119.13	-53.88	100	51	Peak	Open	
3	0.06	41.07	22.25	18.82	111.72	-70.65	100	3	Peak	Open	
4	0.09	34.28	16.21	18.07	108.16	-73.88	100	161	Peak	Open	
5	0.11	40.27	22.31	17.96	106.74	-66.47	100	193	Peak	Open	
6	0.13	31.67	13.81	18.06	105.04	-73.17	100	259	Peak	Open	



TUV Rheinland Taiwan Ltd.
 No. 438-18, Sec 2, Fenfiao, Linkou Dist., New Taipei City 244, Taiwan(R.O.C.)
 Tel: +886-2172-1000 Fax: +886-2172-1322

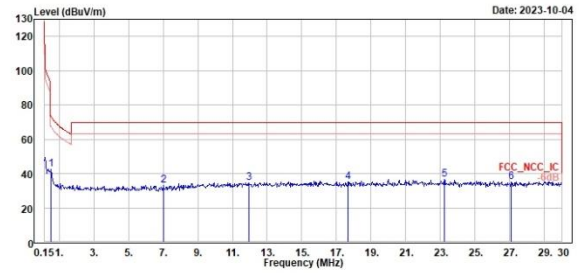

Peak	Freq (MHz)	Level (dBuV/m)	Read Level (dBuV)	Level Factor (dB/m)	Limit Line (dBuV/m)	Over Limit (dB)	APos (cm)	TPos (deg)	Remark	PoL/Phase	Note
1	0.54	42.70	23.83	18.87	72.99	-30.29	100	188	Peak	Open	
2	7.02	33.16	12.81	20.35	69.50	-36.34	100	270	Peak	Open	
3	11.97	34.83	13.11	21.72	69.50	-34.67	100	334	Peak	Open	
4	17.67	35.17	13.04	22.13	69.50	-34.33	100	11	Peak	Open	
5	23.22	36.60	14.27	22.33	69.50	-32.90	100	189	Peak	Open	
6	27.10	34.99	12.63	22.36	69.50	-34.51	100	84	Peak	Open	

Spurious Emissions, Tx Mode, 30MHz ~ 1GHz

BLE_2M

Middle Channel (Horizontal)

Middle Channel (Vertical)



TÜV Rheinland Taiwan Ltd.
 No. 438-18, Sec 2, Penfiao, Linkou Dist., New Taipei City 244, Taiwan(R.O.C.)
 Tel: +886-2172-1000 Fax: +886-2172-1322

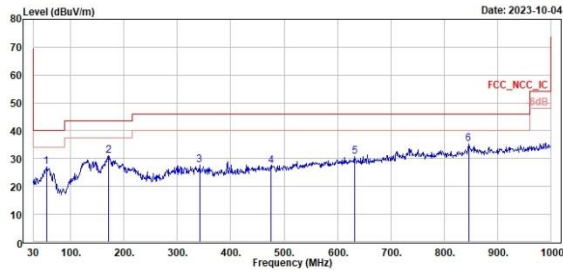

Peak	Freq (MHz)	Level (dBuV/m)	Read Level (dBuV)	Level Factor (dB/m)	Limit Line (dBuV/m)	Over Limit (dB)	APos (cm)	TPos (deg)	Remark	Pol/Phase	Note
1	54.25	27.13	32.87	-5.74	40.00	-12.87	200	163	Peak	Horizontal	
2	170.65	31.12	37.05	-5.93	43.50	-12.38	200	121	Peak	Horizontal	
3	341.37	27.60	31.48	-3.88	46.00	-18.40	100	360	Peak	Horizontal	
4	475.23	27.50	29.11	-1.61	46.00	-18.50	100	360	Peak	Horizontal	
5	632.37	30.66	29.63	1.03	46.00	-15.34	154	360	Peak	Horizontal	
6	845.77	35.43	31.33	4.10	46.00	-10.57	100	73	Peak	Horizontal	



TÜV Rheinland Taiwan Ltd.
 No. 438-18, Sec 2, Penfiao, Linkou Dist., New Taipei City 244, Taiwan(R.O.C.)
 Tel: +886-2172-1000 Fax: +886-2172-1322

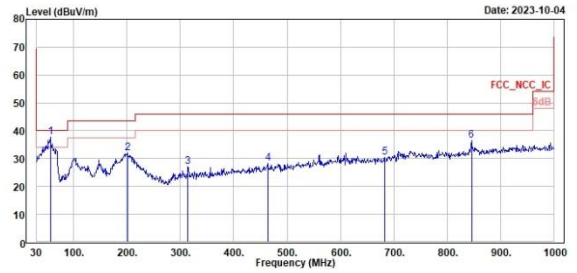

Peak	Freq (MHz)	Level (dBuV/m)	Read Level (dBuV)	Level Factor (dB/m)	Limit Line (dBuV/m)	Over Limit (dB)	APos (cm)	TPos (deg)	Remark	Pol/Phase	Note
1	56.19	37.67	43.61	-5.94	40.00	-2.33	100	261	Peak	Vertical	
2	200.72	31.99	40.69	-8.70	43.50	-11.51	100	62	Peak	Vertical	
3	314.21	26.92	31.35	-4.43	46.00	-19.08	161	360	Peak	Vertical	
4	463.59	28.32	30.23	-1.91	46.00	-17.68	116	360	Peak	Vertical	
5	682.81	30.42	28.93	1.49	46.00	-15.58	166	360	Peak	Vertical	
6	845.77	36.40	32.30	4.10	46.00	-9.60	200	331	Peak	Vertical	

Spurious Emissions, Tx Mode, 1GHz ~ 26.5GHz

BLE_2M

Middle Channel (Horizontal)

Middle Channel (Vertical)



TÜV Rheinland Taiwan Ltd.
 No. 438-18, Sec 2, Fenliao, Linkou Dist., New Taipei City 244, Taiwan(R.O.C.)
 Tel: +886-2172-1000 Fax: +886-2172-1322

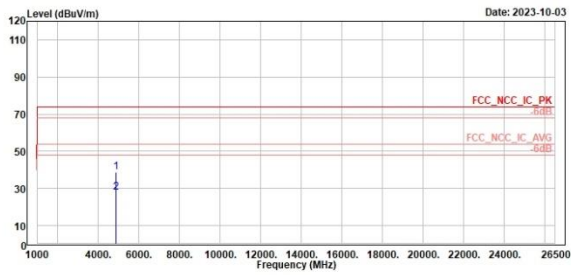

Read	Level	Level Factor	Limit Line	Over Limit	APos	TPos	Remark	Pol/Phase	Note
Freq	Level	Factor	Line	Limit	APos	TPos	Remark	Pol/Phase	Note
MHz	dBuV/m	dB/m	dBuV/m	dB	cm	deg			
1	4888.00	39.01	48.85	-9.04	74.00	-34.99	248	360 Peak	Horizontal
2	4888.00	27.98	37.02	-9.04	54.00	-26.02	248	360 Average	Horizontal



TÜV Rheinland Taiwan Ltd.
 No. 438-18, Sec 2, Fenliao, Linkou Dist., New Taipei City 244, Taiwan(R.O.C.)
 Tel: +886-2172-1000 Fax: +886-2172-1322

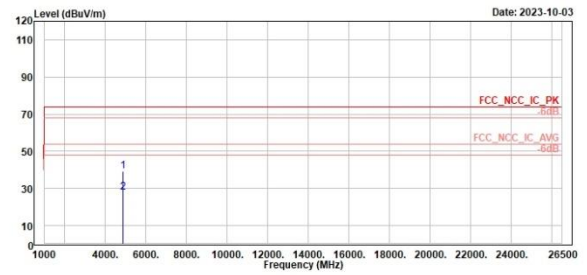

Read	Level	Level Factor	Limit Line	Over Limit	APos	TPos	Remark	Pol/Phase	Note
Freq	Level	Factor	Line	Limit	APos	TPos	Remark	Pol/Phase	Note
MHz	dBuV/m	dB/m	dBuV/m	dB	cm	deg			
1	4888.00	39.14	48.18	-9.04	74.00	-34.86	180	360 Peak	Vertical
2	4888.00	27.65	36.69	-9.04	54.00	-26.35	180	360 Average	Vertical

Mains Conducted Emission, Tx Mode 150kHz ~ 30MHz

Worst Band

(Line)

(Neutral)



TÜV Rheinland Taiwan Ltd.
No. 458-18, Sec. 2, Fenliao, Linkou Dist., New Taipei City 244, Taiwan(R.O.C.)
Tel: +886-2172-1000 Fax: +886-2172-1322

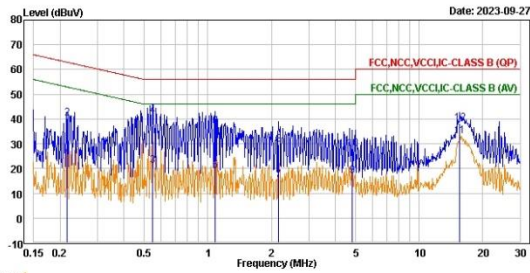

Trace: 1

Line	Freq (MHz)	Level (dBuV)	Read Level (dBuV)	Factor (dB)	Limit Line (dBuV)	Over Limit (dB)	Remark	Pol/Phase	Note
1	0.22	23.69	14.07	9.62	52.98	-29.29	Average	line1	
2	0.22	40.43	30.81	9.62	62.98	-22.55	QP	line1	
3	0.55	21.06	11.43	9.63	46.00	-24.94	Average	line1	
4	0.55	41.23	31.60	9.63	56.00	-14.77	QP	line1	
5	1.08	18.92	9.28	9.64	46.00	-27.08	Average	line1	
6	1.08	36.82	27.18	9.64	56.00	-19.18	QP	line1	
7	2.16	15.27	5.61	9.66	46.00	-30.73	Average	line1	
8	2.16	29.56	19.90	9.66	56.00	-26.44	QP	line1	
9	4.82	17.06	7.36	9.70	46.00	-28.94	Average	line1	
10	4.82	28.11	18.41	9.70	56.00	-27.89	QP	line1	
11	15.54	33.05	23.29	9.76	50.00	-16.95	Average	line1	
12	15.54	38.12	28.36	9.76	60.00	-21.88	QP	line1	



TÜV Rheinland Taiwan Ltd.
No. 458-18, Sec. 2, Fenliao, Linkou Dist., New Taipei City 244, Taiwan(R.O.C.)
Tel: +886-2172-1000 Fax: +886-2172-1322

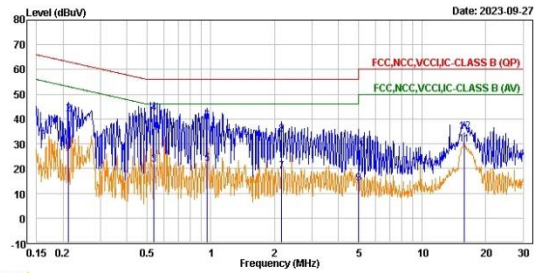

Trace: 1

Line	Freq (MHz)	Level (dBuV)	Read Level (dBuV)	Factor (dB)	Limit Line (dBuV)	Over Limit (dB)	Remark	Pol/Phase	Note
1	0.21	23.83	14.21	9.62	53.14	-29.31	Average	neutral	
2	0.21	41.97	32.35	9.62	63.14	-21.17	QP	neutral	
3	0.54	21.46	11.83	9.63	46.00	-24.54	Average	neutral	
4	0.54	42.52	32.89	9.63	56.00	-13.48	QP	neutral	
5	0.96	21.89	12.25	9.64	46.00	-24.11	Average	neutral	
6	0.96	39.28	29.64	9.64	56.00	-16.72	QP	neutral	
7	2.17	18.62	8.96	9.66	46.00	-27.38	Average	neutral	
8	2.17	33.83	24.17	9.66	56.00	-22.17	QP	neutral	
9	5.01	13.98	4.27	9.71	50.00	-36.02	Average	neutral	
10	5.01	28.25	18.54	9.71	60.00	-31.75	QP	neutral	
11	15.77	29.57	19.74	9.83	50.00	-20.43	Average	neutral	
12	15.77	34.87	25.04	9.83	60.00	-25.13	QP	neutral	