

Getac

X500

USER MANUAL

Rugged Mobile Computing Solution

August 2017

TRADEMARKS

The Bluetooth® word mark and logos are registered trademarks owned by Bluetooth SIG, Inc.

All brand and product names are trademarks or registered trademarks of their respective companies.

NOTE

The information in this manual is subject to change without notice.

For the latest version of the manual, please visit the Getac website at www.getac.com.

Table of Contents

Chapter 1	Getting Started	1
	Getting the Computer Running	2
	Unpacking	2
	Using the Tether (Optional)	3
	Connecting to AC Power	4
	Turning On and Off the Computer	5
	Taking a Look at the Computer	7
	Front Components	7
	Rear Components	8
	Right-Side Components	9
	Left-Side Components	10
	Top-open Components	11
	Bottom Components	13
Chapter 2	Operating Your Computer	15
	Using the Keyboard	16
	Typewriter Keys	16
	Cursor-Control Keys	16
	Numeric Keypad	17
	Function Keys	18
	Fn Key	18
	Hot Keys	18
	Windows Keys	20
	Using the Touchpad	21
	Configuring the Touchpad	22
	Using the Touchscreen (Optional)	23

Using Multi-touch Gestures (Optional)	24
Using the Quick Buttons.....	26
Configuring the Quick Buttons	27
Using the DVD Drive.....	28
Inserting and Removing a Disc.....	29
Using Network and Wireless Connections	31
Using the LAN.....	31
Using the WLAN	32
Using the Bluetooth Feature.....	33
Using the WWAN Feature (Optional)	34
Using the Fingerprint Scanner (Optional)	36
Chapter 3	
Managing Power.....	38
AC Adapter.....	39
Battery Pack	40
Charging the Battery Pack.....	40
Initializing the Battery Pack.....	41
Checking the Battery Level	41
Battery Low Signals and Actions.....	42
Replacing the Battery Pack.....	43
Power-Saving Tips	44
Chapter 4	
Expanding Your Computer.....	45
Connecting Peripheral Devices	46
Connecting Display Monitor	46
Connecting a Serial Device.....	47
Connecting a USB Device	47
Connecting an Audio Device	48
Using Storage and Expansion Cards	49
Using Smart Cards	49
Using PC Cards.....	50
Using ExpressCards.....	51
Using Storage Cards	52
Changing or Replacing	53
Replacing the Hard Disk Drive	53
Installing a Secondary Battery Pack or Hard Disk Drive....	53
System Memory Upgrade.....	54

Chapter 5	Using BIOS Setup.....	56
	When and How to Use.....	57
	Menu Descriptions	58
	Information Menu	58
	Main Menu.....	58
	Advanced Menu.....	59
	Security Menu	60
	Boot Menu	61
	Exit Menu	61
Chapter 6	Using Getac Software	63
	G-Manager	64
Chapter 7	Care and Maintenance	66
	Protecting the Computer.....	67
	Using an Anti-Virus Strategy	67
	Using the Cable Lock.....	67
	Taking Care of the Computer	69
	Location Guidelines.....	69
	General Guidelines	69
	Cleaning Guidelines	70
	Battery Pack Guidelines	70
	Touchscreen Guidelines	72
	When Traveling.....	73
Chapter 8	Troubleshooting.....	74
	Preliminary Checklist.....	75
	Solving Common Problems	76
	Battery Problems.....	76
	Bluetooth Problems.....	76
	Display Problems	77
	DVD Drive Problems	77
	Hardware Device Problems	78
	Hard Disk Drive Problems	78
	Keyboard and Touchpad Problems.....	79
	LAN Problems.....	79
	Power Management Problems	80

Software Problems	80
Sound Problems	80
Startup Problems	81
WLAN Problems	81
Other Problems	83
Resetting the Computer	84
System Restore, Recovery, or Reset.....	85
Using the Driver Disc	86
Appendix A Specifications	87
Appendix B Regulatory Information	89
On the Use of the System	90
Class B Regulations	90
Safety Notices	91
On the Use of the RF Device	94
USA and Canada Safety Requirements and Notices.....	94
European Union CE Marking and Compliance Notices	96
User Notification of Take-back Service	100
ENERGY STAR 6.1.....	101
Battery Recycling.....	103

Chapter 1

Getting Started

Congratulations on purchasing this rugged computer.







This chapter first tells you step by step how to get the computer up and running. Then, you will find a section briefly introducing the external components of the computer.

Getting the Computer Running

Unpacking

NOTE: This packing list applies to standard models. Select models may have different items.

After unpacking the shipping carton, you should find these standard items:

● X500 notebook computer	
● AC adapter 	● Screen cleaning cloth 
● AC power cord 	● Stylus* 
● Battery pack 	● Tether* 
	● Driver disc*
	● Document(s)

* Optional

Inspect all the items. If any item is damaged or missing, notify your dealer immediately.

Using the Tether (Optional)

A tether is available for attaching the stylus to your computer.

1. Insert one of the tether's loop ends through the hole of the stylus (as indicated by **1** below). Then, insert the other end through the first loop (as indicated by **2** below) and pull it tight.

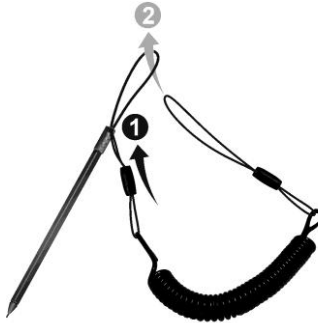

2. Insert the other loop end to the strap holder on computer (as indicated by **1** below). Then, insert the stylus end through the loop (as indicated by **2** below) and pull it tight.



Connecting to AC Power

CAUTION: Use only the AC adapter included with your computer. Using other AC adapters may damage the computer.

NOTE:

- The battery pack is shipped to you in power saving mode that protects it from charging/discharging. It will get out of the mode to be ready for use when you install the battery pack and connect AC power to the computer for the very first time.
- When the AC adapter is connected, it also charges the battery pack. For information on using battery power, see Chapter 3.

You must use AC power when starting up the computer for the very first time.

1. Plug the DC cord of the AC adapter to the power connector of the computer (❶).
2. Plug the female end of the AC power cord to the AC adapter and the male end to an electrical outlet (❷).

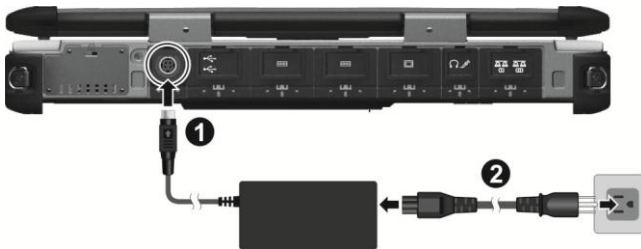

3. Power is being supplied from the electrical outlet to the AC adapter and onto your computer. Now, you are ready to turn on the computer.

Turning On and Off the Computer

Turning On

1. Open the top cover by pulling the cover latch and lifting up the cover. You can tilt the cover forward or backward for optimal viewing clarity.







2. Press the power button (). The Windows operating system should start.



Turning Off

When you finish a working session, you can stop the system by turning off the power or leaving it in Sleep or Hibernation mode:

To...	Do this...
Power off (Shutdown)	Click  →  Power → Shut down.
Sleep	Use one of these methods: <ul style="list-style-type: none">● Press the power button.*● Close the top cover.*● Press Fn + F10.*● Click  →  Power → Sleep.
Hibernate	By default, this option is not shown in the Start menu. If you want to use the feature, set up accordingly in Windows settings.

* “Sleep” is the default result of the action. You can change what the action does through Windows settings.

Taking a Look at the Computer

NOTE: Depending on the model you purchased, the appearance of your computer may not be exactly the same as those shown in this manual.

CAUTION: You need to open the protective covers to access the connectors or devices inside. When not accessing a connector or device, make sure to close the cover completely for water-, dust-, and fire-proof integrity of your computer. (Engage the locking mechanism if existing.)

Front Components

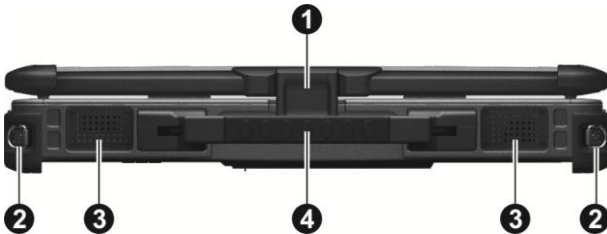

Ref	Component	Description
①	Top cover latch	Locks the top cover.
②	Strap holder	Two buckles hold the shoulder strap.
③	Stereo speaker	Sends out sound and voice from the computer.
④	Handle	Provides a convenient way to carry the computer.

Rear Components



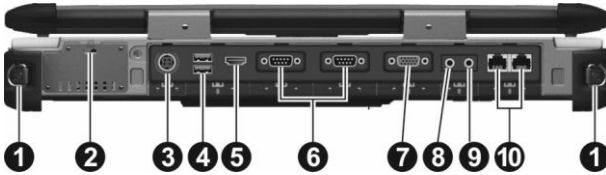

To access a connector, open its protective cover by pushing down the tab. When closing, push the tab upward so it clicks into the locked position.



Ref	Component	Description
①	Strap holder	Two buckles hold the shoulder strap.
②	Kensington lock	Locks the computer to a stationary object for security.
③	Power connector	Connects the AC adapter.
④	USB 3.0 port	Connects a USB device, such as a USB flash disk, printer, digital camera, joystick, and more.
⑤	HDMI connector	Connects a HDMI monitor or TV set.
⑥	Serial connector	Connects a serial device. The left one is COM1 and the right one is COM2.
		Can be configured as RS232 or RS422.
⑦	VGA connector	Connects an external display monitor.
⑧	Audio output connector	Connects a set of headphones or external speakers with amplifier.
⑨	Microphone connector	Connects an external microphone.
⑩	RJ-45 connector	Connects the LAN cable. The left one is LAN1 and the right one is LAN2.

Right-Side Components



To access a device bay, slide the latch toward the right to unlock () and then push down the latch to release the cover. When closing, engage the latch and then slide the latch toward the left to lock ().

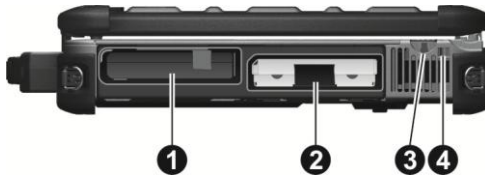



Ref	Component	Description
①	Battery pack	Supplies power to your computer when external power is not connected.
②	Hard disk drive	Inside is the hard disk drive.
③	Stylus (optional)	Serves as the input device by tapping on the touchscreen to make selections and enter information.
④	Tother hole	Stylus tethered to this hole.

Left-Side Components



To access a connector, open its protective cover by pushing down the tab. When closing, push the tab upward so it clicks into the locked position.

To access a device bay, slide the latch toward the right to unlock () and then push down the latch to release the cover. When closing, engage the latch and then slide the latch toward the left to lock ().

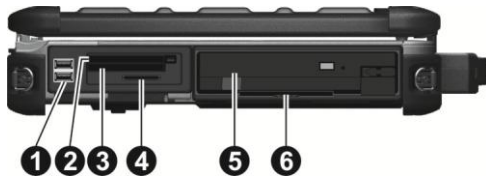





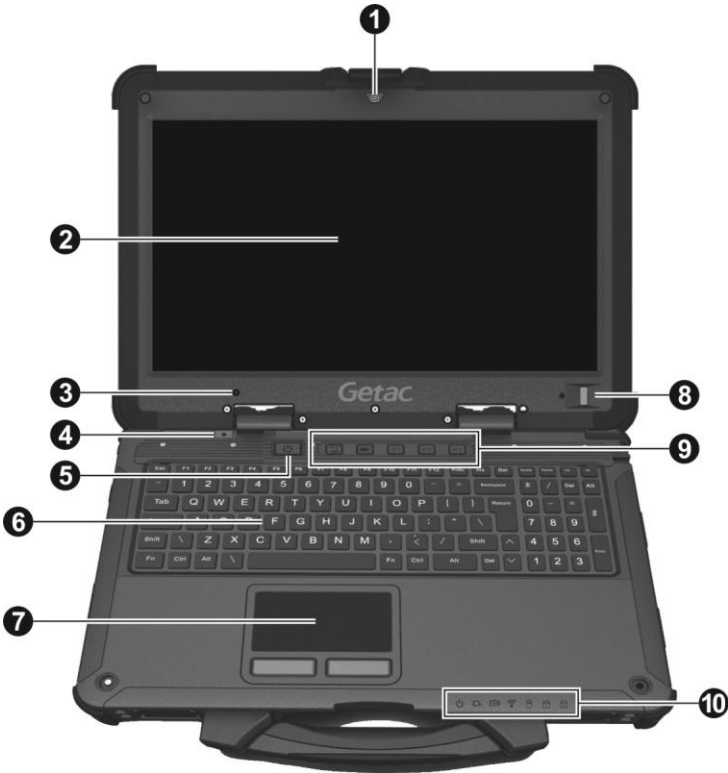



Ref	Component	Description
❶	USB 3.0 port	Connects a USB device, such as a USB flash disk, printer, digital camera, joystick, and more. There are two ports.
❷	PCMCIA slot	Accepts a PC card for additional functions.
❸	ExpressCard slot	Accepts an ExpressCard/34 or ExpressCard/54 for additional functions.
❹	SD card reader	Accepts a Secure Digital (SD) card for removable storage media.
❺	Super multi drive	Accepts a compact disc for installing or loading software, accessing data, and playing music/video. Can be replaced by a secondary hard disk drive or battery pack (purchased separately).
❻	Smart card reader	Accepts a smart card for additional security feature.

Top-open Components



Ref	Component	Description
①	Camera lens (optional)	Allows you to use the camera function.
②	LCD screen	Displays the output of the computer. May include the optional touchscreen feature.
③	Light sensor	Detects the surrounding lighting condition for automatic adjustment of the LCD brightness and optional keyboard backlight.
④	Microphone	Receives sound and voice for the computer.
⑤	Power button	Turns the power on or off (Sleep mode by default).

Ref	Component	Description
⑥	Keyboard	Serves as the data input device of the computer.
⑦	Touchpad	Serves as the pointing device of the computer.
⑧	Fingerprint scanner (optional)	Serves as the fingerprint verification, preventing unauthorized access to your computer.
⑨	Quick buttons	
		Toggles the sunlight-readable mode on or off.
		Switches the ECO mode to the next choice
	P1	Toggles Blackout mode on or off. (The function can be redefined.)
	P2	Toggles the touchpad off or on. (The function can be redefined.)
	P3	Toggles the light sensor on or off. (The function can be redefined.)
⑩	Indicators	
	 Power	Lights green when the computer is on.
		Blinks green when the computer is in Sleep mode.
	 AC power	Lights green when the computer is operating with AC power.
		Lights red when the optional hard disk drive heater is on.
	 Battery charge	Lights green when the battery is fully charged.
		Lights amber when the battery is being charged.
		Blinks red when the battery's capacity is below 10 %.
 RF	Lights green when the RF radio of any RF feature (WLAN/Bluetooth/WWAN) is on.	
 Hard disk drive	Blinks green when computer is reading / writing data to the hard disk.	

Ref	Component	Description
	 Num Lock	Lights green when Num Lock is on.
	 Caps Lock	Lights green when Caps Lock is on.

Bottom Components

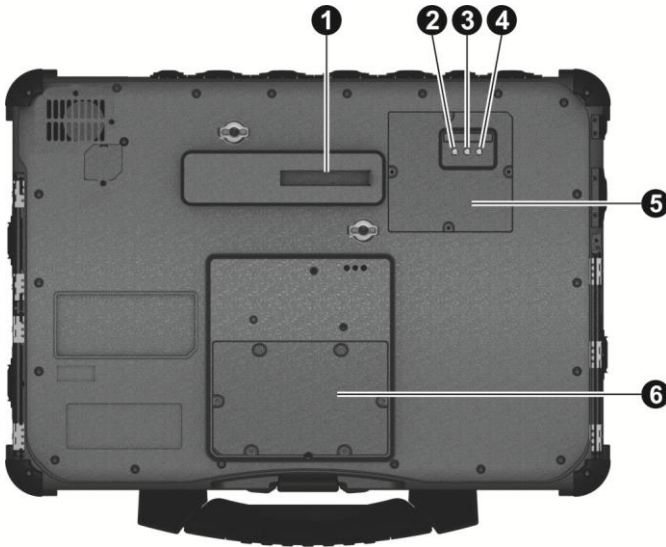

Ref	Component	Description
①	Docking connector	Connects to the Vehicle Dock (purchased separately).
②	WLAN antenna pass-through connector (optional)	Connects the external antenna for WLAN connectivity. NOTE: Must be connected via a docking station.
③	GPS antenna pass-through connector (optional)	Connects the external antenna for GPS signal reception. NOTE: Must be connected via a docking station.

④	WWAN antenna pass-through connector (optional)	Connects the external antenna for WWAN connectivity. NOTE: Must be connected via a docking station.
⑤	SIM card slot (optional)	Inside is the SIM card slot.
⑥	Memory slots	Inside are the memory slots for expanding the memory size of your computer.

Chapter 2

Operating Your Computer

This chapter provides information about the use of the computer.

If you are new to computers, reading this chapter will help you learn the operating basics. If you are already a computer user, you may choose to read only the parts containing information unique to your computer.

CAUTION:

- Do not expose your skin to the computer when operating it in a very hot or cold environment.
- The computer can get uncomfortably warm when you use it in high temperatures. As a safety precaution in such a circumstance, do not place the computer on your lap or touch it with your bare hands for extended periods of time. Prolonged body contact can cause discomfort and potentially a burn.

Using the Keyboard

Your keyboard has all the standard functions of a full-sized computer keyboard plus an **Fn** key added for specific functions.

The standard functions of the keyboard can be further divided into four major categories:

- Typewriter keys
- Cursor-control keys
- Numeric keys
- Function keys

Typewriter Keys

Typewriter keys are similar to the keys on a typewriter. Several keys are added such as the **Ctrl**, **Alt**, **Esc**, and lock keys for special purposes.

The Control (**Ctrl**) / Alternate (**Alt**) key is normally used in combination with other keys for program-specific functions. The Escape (**Esc**) key is usually used for stopping a process. Examples are exiting a program and canceling a command. The function depends on the program you are using.

Cursor-Control Keys

Cursor-control keys are generally used for moving and editing purposes.

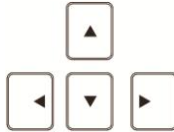

NOTE: The word "cursor" refers to the indicator on the screen that lets you know exactly where on your screen anything you type will appear. It can take the form of a vertical or horizontal line, a block, or one of many other shapes.

Numeric Keypad



Numeric keys facilitate entering of numbers and calculations. When Num Lock is on, the numeric keys are activated; meaning you can use these keys to enter numerals.

When Num Lock is off, the keys serve as cursor-control keys.

Function Keys

On the top row of the keys are the function keys: **F1** to **F12**. Function keys are multi-purpose keys that perform functions defined by individual programs.











Fn Key











The **Fn** key, at the lower left corner of the keyboard, is used with another key to perform the alternative function of a key. To perform a desired function, first press and hold **Fn**, then press the other key.

Hot Keys

Hot keys refer to a combination of keys that can be pressed any time to activate special functions of the computer. Most hot keys operate in a cyclic way. Each time a hot key combination is pressed, it shifts the corresponding function to the other or next choice.

You can easily identify the hot keys with the icons imprinted on the keytop. The hot keys are described next.



Key	Description
 	Switches the keyboard backlight on and off (option).
 	Switches the RF (radio frequency) radio on or off. When off, all wireless modules (such as WLAN, Bluetooth, and WWAN) cannot be used. When on, individual settings of the module work.
 	Decreases the sound volume.
 	Increases the sound volume.
 	Increases the LCD brightness.



Key	Description
 	Decreases the LCD brightness.
 	Switches the system sound output off (mute) or on.
 	Switches the display off or on.
 	<p>Switches the display output to the next choice if an external display is connected. Choices are:</p> <pre> graph TD A[LCD only] --> B[LCD + External display Duplicate] B --> C[LCD + External display Extend] C --> D[External display only] </pre> <p>The hot keys are equivalent to  Windows logo key + P.</p> <p>NOTE:</p> <ul style="list-style-type: none"> • Display resolution remains unchanged when you switch the display output using this hot key combination. • This hot key combination does not function during the playback of DVD or MPEG files by certain applications. • This hot key combination does not function in full screen DOS mode.
 	Serves as the sleep button that you can define with Windows' Power Options .

NOTE:

- If you have changed your system from the default ACPI mode to APM mode, the hot keys **Fn+F3**, **Fn+F4**, and **Fn+F10** will not be supported.
- The operating system might ignore the hot keys when busy with tasks. Do not keep on pressing the hot keys under such circumstance. Wait for a while before you try again.

Windows Keys

The keyboard has two keys that perform Windows-specific functions:  Windows Logo key and  Application key.

The  Windows Logo key opens the **Start** menu and performs software-specific functions when used in combination with other keys. The  Application key usually has the same effect as a right mouse click.

Using the Touchpad

CAUTION: Do not use a sharp object such as a pen on the touchpad. Doing so may damage the touchpad surface.

NOTE: For optimal performance of the touchpad, keep your fingers and the pads clean and dry. When tapping on the pad, tap lightly. Do not use excessive force.

The touchpad is a pointing device that allows you to communicate with the computer by controlling the location of the pointer on the screen and making selection with the buttons.



The touchpad consists of a rectangular pad (work surface) and a left and right buttons. To use the touchpad, place your forefinger or thumb on the pad. The rectangular pad acts like a miniature duplicate of your display. As you slide your fingertip across the pad, the pointer (also called cursor) on the screen moves accordingly. When your finger reaches the edge of the pad, simply relocate yourself by lifting the finger and placing it on the other side of the pad.

Here are some common terms that you should know when using the touchpad:

Term	Action
Point	Move your finger on the pad until the cursor points to the selection on the screen.
Click	Press and release the left button. -or- Tap gently anywhere on the pad.
Double-click	Press and release the left button twice in quick succession. -or- Tap twice on the pad rapidly.
Drag and drop	Press and hold the left button, then move your finger until you reach your destination (drag). Finally, release the button (drop) when you finish dragging your selection to the destination. The object will drop into the new location. -or- Gently tap twice on the pad and on the second tap, keep your finger in contact with the pad. Then, move your finger across the pad to drag the selected object to your destination. When you lift your finger from the pad, the selected object will drop into place.

Configuring the Touchpad

You may want to configure the touchpad to suit your needs. For example, if you are a left-handed user, you can swap the two buttons so that you can use the right button as the left button and vice versa. You can also change the size of the on-screen pointer, the speed of the pointer, and so on.

To configure the touchpad, go to **Settings → Devices → Mouse & touchpad**.

Using the Touchscreen (Optional)

CAUTION: Do not use a sharp object such as a ballpoint pen or pencil on the touchscreen. Doing so may damage the touchscreen surface.

The touchscreen is a touch-sensitive device that allows you to navigate on the screen without using a keyboard, touchpad, or mouse.



Use the included stylus to select objects on the screen. The stylus can be stretched for better grip and handling.

The following table shows how you use the touchscreen to obtain equivalent mouse functions.

Term/Action	Equivalent Mouse Function
Tap: Touch the screen once.	Click/Point
Double-tap: Touch the screen twice rapidly.	Double-click
Tap and hold: Tap and hold until a popup menu appears.	Right-click





Drag: Hold the stylus (or finger) on the screen and drag across the screen until reaching your destination.



Drag

Using Multi-touch Gestures (Optional)

You can interact with your computer by placing two fingers on the screen. The movement of the fingers across the screen creates “gestures,” which send commands to the computer.

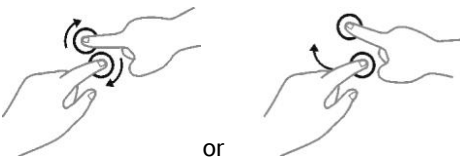
Here are the multi-touch gestures that you can use:

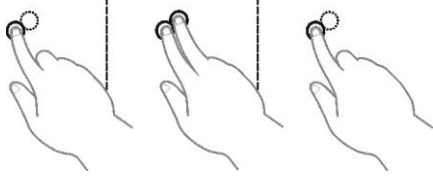
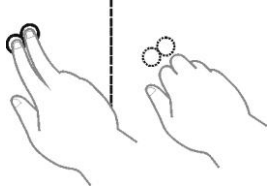
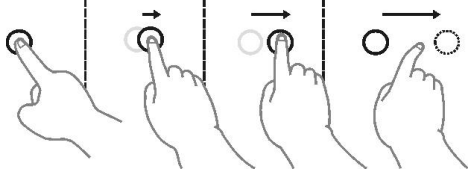

Gestures	Actions  = finger down;  = finger up	Descriptions
Pan (Scroll)	 or Drag 1 or 2 fingers up or down.	Use panning to see another part of a page that has scroll bars.
Zoom (Pinch)	 Move two fingers apart/toward each other.	Use zooming to make an item (a photo for example) on the screen larger or smaller. The gesture works in applications that support mouse wheel zooming.
Rotate	 or Move two fingers in opposing directions. -or- Use one finger to pivot around another.	Use rotating to move a picture or other item on the screen in a circular direction (clockwise or counter-clockwise). The gesture works in applications that support the specific gesture.

Gostures	Actions  = finger down;  = finger up)	Descriptions
Press and Tap	 <p data-bbox="240 406 711 462">Press on target and tap using a second finger.</p>	Use press and tap to access the shortcut menu.
Two-finger Tap	 <p data-bbox="240 686 711 774">Tap two fingers at the same time (where the target is in the midpoint between the fingers).</p>	The function is defined by applications that support the specific gesture.
Flicks	 <p data-bbox="240 973 711 1029">Make quick drag gestures in the desired direction.</p>	Flick left or right to navigate back and forward in a browser and other applications. The gesture works in most applications that support back and forward.

Using the Quick Buttons



The Quick Buttons allow you to quickly start a program or activate a function. Default functions are:

Button	Description
	<p>Toggles the sunlight-readable mode on or off. An OSD (On Screen Display) pops up on the screen indicating the current status (MAX for on and MANUAL for off).</p> <p>In sunlight-readable mode, the LCD brightness is increased to the highest level. The mode automatically ends when the brightness setting is changed, the computer resumes from Sleep/Hibernation mode, or the computer is restarted.</p>
	<p>NOTE: The button works only when using battery power.</p> <p>Switches the ECO mode to the next choice (QUICK MODE, MAX POWER SAVING, WORK MODE, or OFF). An OSD (On Screen Display) pops up on the screen indicating the current status.</p> <p>The ECO mode will return to the default OFF setting when AC power is connected, any power related setting is changed, the computer resumes from Sleep/Hibernation mode, or the computer is restarted.</p> <p>Each ECO mode is a combination of power settings that results in different power consumptions.</p>

Button	Description
P1	<p>Toggles Blackout mode on or off.</p> <p>In Blackout mode, the LCD backlight, keyboard/button backlight, and LED indicators are all turned off; and the sound is muted.</p> <p>To bring the computer out of Blackout mode, press the power button.</p>
P2	<p>Toggles the touchpad off or on. An OSD (On Screen Display) pops up on the screen indicating the current status.</p>
P3	<p>Toggles the light sensor on or off. An OSD (On Screen Display) pops up on the screen indicating the current status (AUTO for on and MANUAL for off).</p> <p>When set to AUTO, the brightness will be automatically adjusted according to the current ambient light.</p> <p>The backlight will return to the default MANUAL setting whenever the computer resumes from Sleep/Hibernation mode or the computer is restarted.</p>

Configuring the Quick Buttons

The button functions can be redefined. Use the G-Manager program and select the **Buttons** tab to configure the buttons. (See “G-Manager” in Chapter 6 for information.)

Using the DVD Drive

Your computer comes with a Super Multi drive. The drive can read from and write to CD, DVD+, DVD- and DVD-RAM media.

CAUTION:

- When inserting a disc, do not use force.
- Make sure that the disc is correctly inserted into the tray, and then close the tray.
- Do not leave the drive tray open. Also, avoid touching the lens in the tray with your hand. If the lens becomes dirty, the drive may malfunction.
- Do not wipe the lens using materials with rough surface (such as paper towel). Instead, use a cotton swab to gently wipe the lens.

FDA regulations require the following statement for all laser-based devices:

"Caution, Use of controls or adjustments or performance of procedures other than those specified herein may result in hazardous radiation exposure."

NOTE: The DVD drive is classified as a Class 1 laser product. This label is located on the DVD drive.

**CLASS 1 LASER PRODUCT
LASER KLASSE 1**

NOTE: This product incorporates copyright protection technology that is protected by method claims of certain U.S. patents and other intellectual property rights owned by Macrovision Corporation and other rights owners. Use of this copyright protection technology must be authorized by Macrovision Corporation, and is intended for home and other limited viewing uses only unless otherwise authorized by Macrovision Corporation. Reverse engineering or disassembly is prohibited.

Inserting and Removing a Disc

1. Turn on the computer.
2. Locate the DVD drive on the left side of your computer. Slide the latch toward the right to unlock () and then push down the latch to release the cover.
3. Press the eject button and the DVD tray will slide out partially. Gently pull on it until it is fully extended.
4. To insert a disc, place down the disc in the tray with its label facing up. Slightly press the center of the disc until it clicks into place.

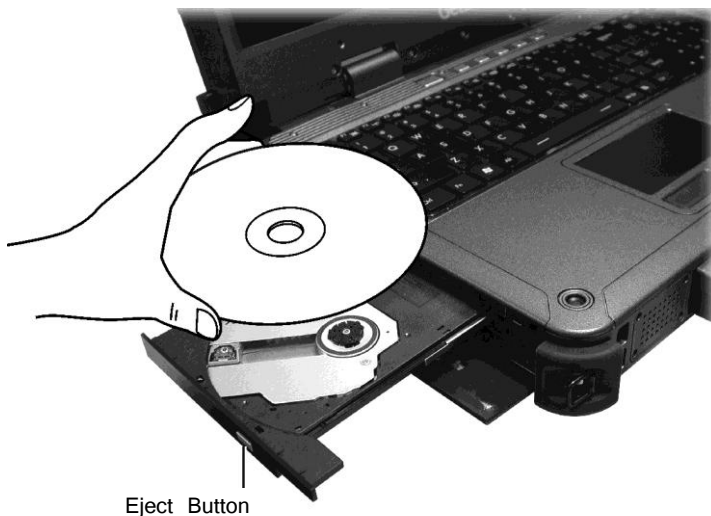

To remove a disc, hold the disc by its outer edge and lift it up from the tray.

5. Gently push the tray back into the drive.
6. Close the cover.

NOTE: In the unlikely event that you are unable to release the drive tray by pressing the eject button, you can manually

release the disc. (See "You cannot eject a disc." in Chapter 8.)

Using Network and Wireless Connections

Using the LAN

The internal 10/100/1000Base-T LAN (Local Area Network) module allows you to connect your computer to a network. It supports data transfer rate up to 1000 Mbps.

To connect the network cable to the LAN module, connect one end of the LAN cable to the RJ-45 connector on the computer and the other end to the network hub.

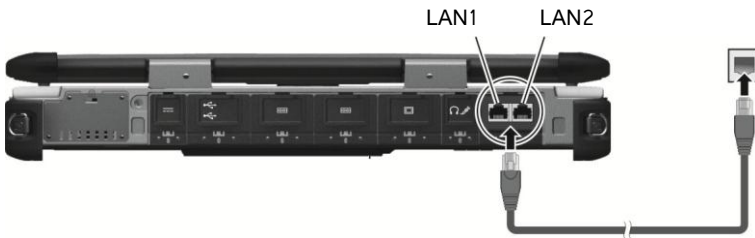

Your computer supports two LAN modules (LAN1 and LAN2) so you can connect to two networks at the same time.

Using the WLAN

The WLAN (Wireless Local Area Network) module supports IEEE 802.11ac, compatible with 802.11a/b/g/n.

Turning On/Off the WLAN Radio

If you have previously turned off the WLAN radio, use this method to turn it on.

Click  → **Settings** → **Network & Internet** → **Wi-Fi**. Slide the **Wi-Fi** switch to the **On** position

To turn off the WLAN radio:

You can turn off the WLAN radio the same way you turn it on.

If you want to quickly turn off all wireless radio, simply switch on Airplane mode. Click  → **Settings** → **Network & Internet** → **Airplane mode**. Slide the **Airplane mode** switch to the **On** position. You can also press **Fn+F2** to switch Airplane mode on or off.

Connecting to a WLAN Network

1. Make sure that the WLAN function is enabled (as described above).
2. Click the network icon  in the lower right of the task bar.
3. In the list of available wireless networks, select a network, and then select **Connect**.
4. Some networks require a network security key or passphrase. To connect to one of those networks, ask your network administrator or Internet service provider (ISP) for the security key or passphrase.

For more information on setting a wireless network connection, refer to Windows online help.

Using the Bluetooth Feature

The Bluetooth technology allows short-range wireless communications between devices without requiring a cable connection. Data can be transmitted through walls, pockets and briefcases as long as two devices are within range.

Turning On/Off the Bluetooth Radio

To turn on the Bluetooth radio:

If you have previously turned off the Bluetooth radio, use this method to turn it on.

Click  → **Settings** → **Devices** → **Bluetooth**. Slide the **Bluetooth** switch to the **On** position.

To turn off the Bluetooth radio:

You can turn off the Bluetooth radio the same way you turn it on.

If you want to quickly turn off all wireless radio, simply switch on Airplane mode. Click  → **Settings** → **Network & Internet** → **Airplane mode**. Slide the **Airplane mode** switch to the **On** position. You can also press **Fn+F2** to switch Airplane mode on or off.

Connecting to another Bluetooth Device

1. Make sure that the Bluetooth function is enabled (as described above).
2. Make sure that the target Bluetooth device is turned on, discoverable and within close range. (See the documentation that came with the Bluetooth device.)
3. Click  → **Settings** → **Devices** → **Bluetooth**.
4. Select the device you want to connect from the search results.
5. Depending on the type of Bluetooth device that you want to connect to, you will need to enter the pertinent information.

For detailed information on using the Bluetooth feature, see Windows' online Help.

Using the WWAN Feature (Optional)

A WWAN (Wireless Wide Area Network) uses mobile telecommunication cellular network technologies to transfer data. The WWAN module of your computer supports 3G.

NOTE: Your model only supports data transmission. Voice transmission is not supported.

Installing a SIM Card

1. Turn off the computer and disconnect the AC adapter.
2. Carefully place the computer upside down.
3. Unfasten four screws and flip open the cover. Be careful not to pull on the cables connected to the cover.

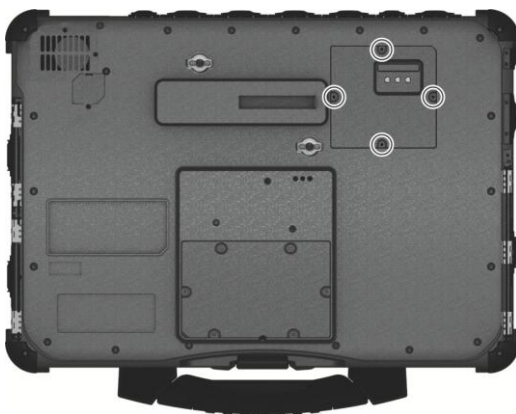

4. Locate the SIM card slot. Slide the locking tab inward to unlock (❶). Lift the slot up and, noting the orientation, insert the SIM card into the slot (❷). Slide the locking tab outward to secure the SIM card in place (❸).

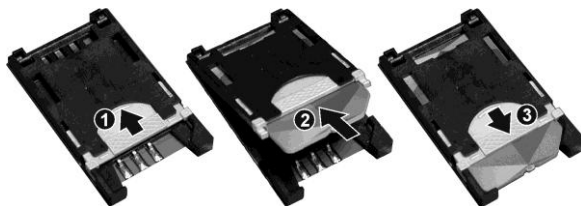

5. Close the cover and secure with four screws.

Turning On/Off the WWAN Radio

To turn on the WWAN radio:

If you have previously turned off the WWAN radio, use this method to turn it on.

Click  → **Settings** → **Network & Internet** → **Airplane mode**. Slide the **Cellular** switch to the On position.

To turn off the WWAN radio:

You can turn off the WWAN radio the same way you turn it on.

If you want to quickly turn off all wireless radio, simply switch on Airplane mode.

Click  → **Settings** → **Network & Internet** → **Airplane mode**. Slide the **Airplane mode** switch to the **On** position. You can also press **Fn+F2** to switch Airplane mode on or off.

Setting up a WWAN Connection

Click  → **Settings** → **Network & Internet** → **Cellular**. (For detailed information on cellular settings in Windows 10, see Microsoft Support website.)

Using the Fingerprint Scanner (Optional)

WARNING:

- We shall not be liable for any loss or damage whatsoever resulting from your use of the fingerprint scanner or neglect of fingerprint scanner use, or any data loss resulting from such developments as fingerprint authentication malfunctioning.
- It is not recommended that you use the fingerprint scanner in a below-freezing temperature. The moisture on your finger can freeze to the scanner's metal surface when you touch it, resulting in a failed operation. Besides, touching freezing metal with your finger can cause frostbite.

The fingerprint scanner provides a strong authentication mechanism based on fingerprint recognition.

To enroll your fingerprint and configure the function:

NOTE: You can enroll a fingerprint only after creating a password for the Windows user account.

1. Click  → **Settings** → **Accounts** → **Sign-in options**.
2. On the right side under **Fingerprint**, click **Set up**.
3. Follow the onscreen instructions to complete.



NOTE: The fingerprint logon process can take a while. This is because the system has to check hardware devices and security configuration before initiating the fingerprint scanner.

Chapter 3

Managing Power

Your computer operates either on external AC power or on internal battery power.

This chapter tells you how you can effectively manage power. To maintain optimal battery performance, it is important that you use the battery in the proper way.

AC Adapter

CAUTION:

- The AC adapter is designed for use with your computer only. Connecting the AC adapter to another device can damage the adapter.
- The AC power cord supplied with your computer is for use in the country where you purchased your computer. If you plan to go overseas with the computer, consult your dealer for the appropriate power cord.
- When you disconnect the AC adapter, disconnect from the electrical outlet first and then from the computer. A reverse procedure may damage the AC adapter or computer.
- When unplugging the connector, always hold the plug head. Never pull on the cord.

The AC adapter serves as a converter from AC (Alternating Current) to DC (Direct Current) power because your computer runs on DC power, but an electrical outlet usually provides AC power. It also charges the battery pack when connected to AC power.

The adapter operates on any voltage in the range of 100~240 V AC.

Battery Pack

The battery pack is the internal power source for the computer. It is rechargeable using the AC adapter.

The operating time of a fully charged battery pack depends on how you are using the computer. When your applications often access peripherals, you will experience a shorter operating time.

NOTE: Care and maintenance information for the battery is provided in the “Battery Pack Guidelines” section in Chapter 7.

Charging the Battery Pack

NOTE:

- Charging will not start if the battery’s temperature is below 0 °C (32 °F) or above 40 °C (104 °F); the charging process will stop if the battery’s temperature gets above 60 °C (140 °F). To avoid damaging the battery under this situation, disconnect the AC adapter and wait for the battery to return to room temperature before charging again.
- During charging, do not disconnect the AC adapter before the battery has been fully charged; otherwise you will get a prematurely charged battery.
- The battery level may automatically lessen due to the self-discharge process, even when the battery pack is fully charged. This happens no matter if the battery pack is installed in the computer.

To charge the battery pack, connect the AC adapter to the computer and an electrical outlet. The Battery Charge Indicator () on the computer glows amber to indicate that charging is in progress. You are advised to keep the computer power off while the battery is being charged. When the battery is fully charged, the Battery Charge Indicator glows green.

It takes approximately 4 hours to fully charge the Li-Ion battery pack when the computer is off, and approximately 7 hours to fully charge the battery pack when the computer is on.

CAUTION: After the computer has been fully recharged, do not immediately disconnect and reconnect the AC adapter to charge it again. Doing so may damage the battery.

Initializing the Battery Pack

You need to initialize a new battery pack before using it for the first time or when the actual operating time of a battery pack is much less than expected. Initializing is the process of fully charging, discharging, and then charging. It can take several hours.

A software tool called “Gauge Reset” is provided for the purpose. Use the G-Manager program and select the **Battery** tab to find the tool.

Checking the Battery Level

NOTE: Any battery level indication is an estimated result. The actual operating time can be different from the estimated time, depending on how you are using the computer.

By Operating System

You can check the approximate battery level using the battery meter function of the operating system. To read the battery level in Windows, click the battery icon on the taskbar.

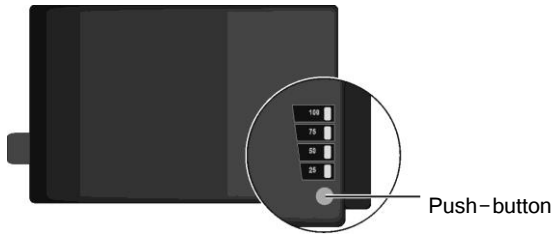

By Gas Gauge

On the exterior side of the battery pack is a gas gauge for displaying the estimated battery charge. When the battery pack is not installed in the computer and you want to know the battery charge, you can press the push-button to see the number of LEDs that light up. Each LED represents 25% charge.



Battery Low Signals and Actions

The battery icon changes appearance to display the current state of the battery.

Battery Icon	Battery Level	Description
	Discharging	The icon shows the charge remaining in 10-percent increments until the charge reaches the low-battery level.
	Low	The battery charge has reached the low-battery level (10% by default).
	Critically low	The battery charge has reached the critical battery level (5% by default). By default, Windows will display a notification and put your computer into Hibernation.

When the battery is low, the computer's Battery Charge Indicator () also blinks red to alert you to take actions.

Always respond to low-battery by connecting the AC adapter, placing your computer in Hibernation mode, or turning off the computer.

Replacing the Battery Pack

CAUTION:

- There is danger of explosion if the battery is incorrectly replaced. Replace the battery only with the computer manufacturer's optional battery packs. Discard used batteries according to the dealer's instructions.
- Do not attempt to disassemble the battery pack.

1. Turn off the computer and disconnect the AC adapter.
2. Locate the battery pack on the right side of your computer. Slide the latch toward the right to unlock () and then push down the latch to release the cover.
3. Pull the strip and slide the battery pack out of the slot.



4. With the strip facing outward, insert the new battery pack all the way into the slot.
5. Close the cover.

Power-Saving Tips

Aside from enabling your computer's power saving mode, you can do your part to maximize the battery's operating time by following these suggestions.

- Do not disable Power Management.
- Decrease the LCD brightness to the lowest comfortable level.
- Shorten the length of time before Windows turn off the display.
- When not using a connected device, disconnect it.
- Remove the card (such as smart card, ExpressCard, or PC card) if not using it.
- Turn off the wireless radio if you are not using the wireless module (such as WLAN, Bluetooth, or WWAN).
- Turn off the computer when you are not using it.

Chapter 4

Expanding Your Computer

You can expand the capabilities of your computer by connecting other peripheral devices.

When using a device, be sure to read the instructions accompanying the device together with the relevant section in this chapter.

Connecting Peripheral Devices

Connecting Display Monitor

If you want the benefits of a larger display screen with higher resolution, you can connect an external display monitor to your computer.

Your computer supports a VGA connector and a HDMI connector. HDMI (High-Definition Multimedia Interface) is an audio/video interface that transmits uncompressed digital data and therefore delivers true HD quality.

1. Turn off the computer.
2. Depending on the type of your monitor, plug the monitor's signal connector to the computer's VGA or HDMI connector.

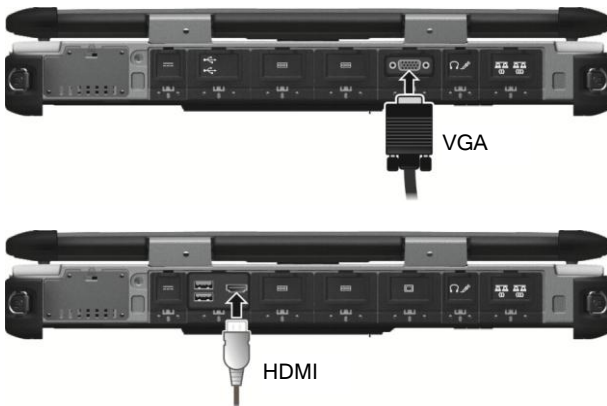

3. Plug one end of the monitor's power cord into the power socket on the monitor and the other end to an electrical outlet.
4. To use the monitor, turn on the monitor before turning on the computer.
5. The connected device should respond by default. If not, you can switch the display output by pressing the **Fn+F9** hot keys. (You can also change the display through Windows **Control Panel** → **Display Settings** Properties.)

Connecting a Serial Device

Your computer has two serial ports for connecting a serial device.

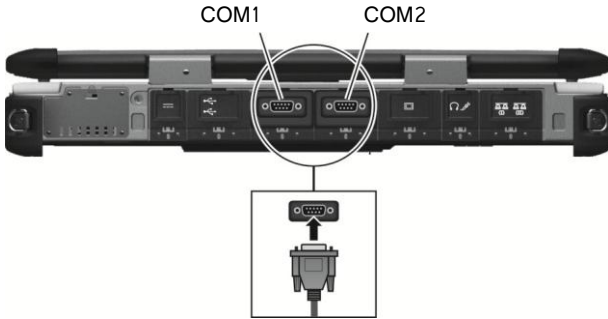

NOTE: The serial port is configured as RS232 by default. If you want to use it as RS422, run BIOS Setup to change the setting. (See “Advanced Menu” in Chapter 5 for information.)

Connecting a USB Device

Your computer has four USB 3.0 ports for connecting USB devices, such as a digital camera, scanner, printer, modem, and mouse.



Connecting an Audio Device

For higher audio quality, you can send or receive sound through external audio devices.



- **Audio Output Connector** can be connected to speakers, headphones, or earphone set.
- **Microphone Connector** can be connected to an external microphone for recording voice or sound.

NOTE :

- After connecting an external audio device, make sure that you specify the use of the correct audio device in Windows.
- When using the external speakers/headphones or microphone, you cannot use the internal one.

Using Storage and Expansion Cards

Using Smart Cards

Your computer has a smart card slot.

With an embedded microcontroller, smart cards have the unique ability to store large amounts of data, carry out their own on-card functions (e.g., encryption and mutual authentication), and interact intelligently with a smart card reader.

To insert a smart card:

1. Locate the smart card slot on the left side of the computer and open the protective cover.
2. Slide the smart card, with its label and embedded chip facing up into the slot.

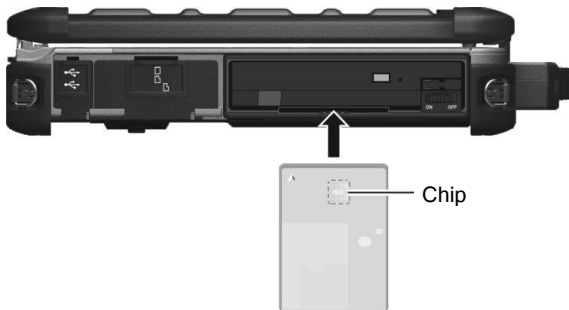

3. Close the cover.

To remove a smart card:

1. Make sure that the software is not accessing the smart card.
2. Pull the card out of the slot.
3. Close the cover.

Using PC Cards

Your computer has a PC card slot which supports PCMCIA Type II and CardBus specifications.

To insert a PC card:

1. Locate the PC card slot on the left side of the computer and open the protective cover.
2. Slide the PC card, with its label facing up, into the slot until the eject button pops out.

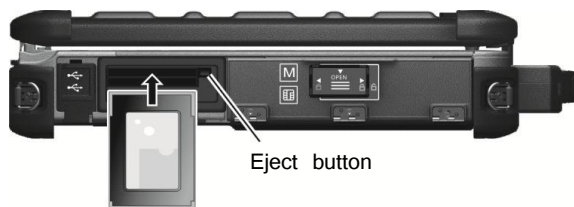

3. Close the cover.

To remove a PC card:

1. Double-click on the **Safely Remove Hardware**  icon found on the Windows taskbar and the **Safely Remove Hardware** window appears on screen.
2. Select (highlight) the PC card from the list to disable the card.
3. Push the eject button and the card will slide out slightly. Pull the card out of the slot.
4. Close the cover.

Using ExpressCards

Your computer has an ExpressCard slot.

The ExpressCard slot can accommodate a 54 mm (ExpressCard/54) or 34 mm (ExpressCard/34) wide ExpressCard. Typical ExpressCards support a very extensive range of applications including memory, wired and wireless communication cards, and security devices.

To insert an ExpressCard:

1. Locate the ExpressCard slot on the left side of the computer and open the protective cover.
2. Slide the ExpressCard, with its label facing up, all the way into the slot until the rear connectors click into place.



3. Close the cover.

To remove an ExpressCard:

1. Double-click on the **Safely Remove Hardware**  icon found on the Windows taskbar and the **Safely Remove Hardware** window appears on screen.
2. Select (highlight) the ExpressCard from the list to disable the card.
3. Slightly push the card to release and then pull it out of the slot.
4. Close the cover.

Using Storage Cards

NOTE: You can use only storage cards. Your Card Reader does not support cards with I/O (input/output) functions such as a wireless network card or Bluetooth card.

Your computer has a storage card reader. The card reader is a small drive for reading from and writing to removable storage cards (or called memory cards). The reader supports SD (Secure Digital) cards.

To insert a storage card:

1. Locate the SD card reader on the left side of the computer and open the cover.
2. Align the card with its connector pointing to the slot and its label facing up. Slide the card into the slot until it reaches the end.



Windows will detect the card and assign it a drive name.

3. Close the cover.

To remove a storage card:

1. Open **File Explorer** and click **Computer**.
2. Right-click the drive with the card and select **Eject**.
3. Slightly push the card to release and then pull it out of the slot.
4. Close the cover.

Changing or Replacing

Replacing the Hard Disk Drive

1. Turn off the computer and disconnect the AC adapter.
2. Locate the hard disk drive on the right side of your computer and open the protective cover.
3. Pull the strip and slide the hard disk drive out of the slot.



4. With the strip facing outward, insert the new hard disk drive all the way into the slot.
5. Close the cover.

Installing a Secondary Battery Pack or Hard Disk Drive

You can purchase a secondary battery pack or hard disk drive to be installed in the multi-purpose device bay.

1. Locate the multi-purpose device bay on the left side of your computer and open the protective cover.
2. Pull the strip and slide the existing device out of the bay.



3. With the strip facing outward, insert the new device all the way into the bay.

4. Close the cover.

System Memory Upgrade

You can upgrade your computer by expanding system memory.

CAUTION:

- It is not recommended that you buy and install RAM modules by yourself. If you want to expand system memory, please ask Getac service center to install DRAM modules for you so that full compatibility can be guaranteed.
- RAM modules are extremely sensitive to static electricity. There are cases where static electricity generated by the human body has adversely affected such modules. When inserting or removing a RAM module, do not touch the terminals or internal components, insert objects other than the module, or allow foreign particles to enter. Doing so has been known to cause damage, fire, or electrical shock.

To install the RAM module:

1. Disconnect the AC adapter and remove the battery pack.
2. Carefully place the computer upside down.
3. Remove the 6 screws to open the compartment cover.

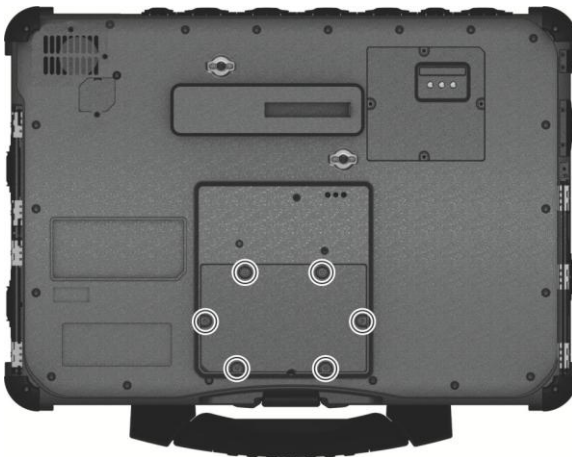

- To install the RAM module, match the module's notched part with the socket's projected part and firmly insert the module into the socket at a 20-degree angle (❶). Then push down until the retaining clips lock the module into position (❷).

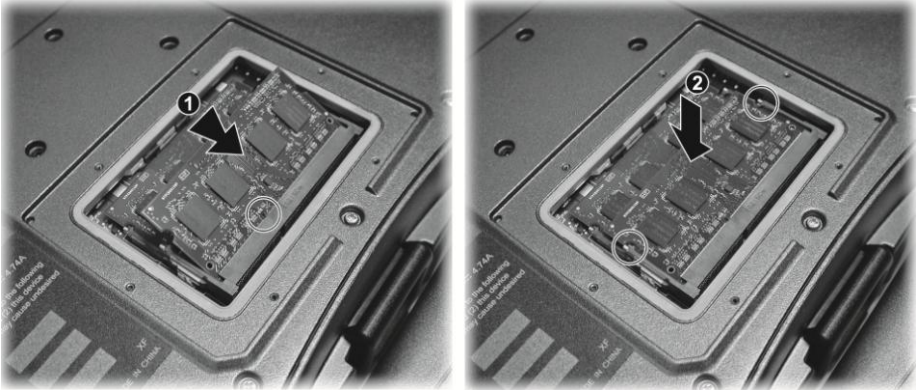

CAUTION: If the RAM module is difficult to insert or difficult to push down, do not force it. Check once more to ensure that the module is positioned correctly.

- Replace the compartment cover and secure with 6 screws.
- Replace the battery pack.

Chapter 5

Using BIOS Setup

BIOS Setup Utility is a program for configuring the BIOS (Basic Input/ Output System) settings of the computer. BIOS is a layer of software, called firmware, that translates instructions from other layers of software into instructions that the computer hardware can understand. The BIOS settings are needed by your computer to identify the types of installed devices and establish special features.

This chapter tells you how to use the BIOS Setup Utility.

When and How to Use

You need to run BIOS Setup Utility when:

- You see an error message on the screen requesting you to run BIOS Setup Utility.
- You want to restore the factory default BIOS settings.
- You want to modify some specific settings according to the hardware.
- You want to modify some specific settings to optimize the system performance.

To run BIOS Setup Utility, click  → **Settings** → **Update & security** → **Recovery**. Under **Advanced startup**, click **Restart now**. In the boot options menu, click **Troubleshoot** → **Advanced options** → **UEFI Firmware Settings**. Click **Restart**.

In general, you can use the arrow keys to move around and + / - keys to change the setup values. Keyboard information can be found at the bottom of the screen.

NOTE: The actual setting items on your model may differ from those described in this chapter.

Menu Descriptions

Information Menu

The Information menu contains the basic configuration information of the system. There are no user-definable items in this menu.

NOTE: The “Asset Tag” information appears when you have entered the asset number for this computer using the asset management program. The program is provided in the **Asset tag** folder of the Driver disc.

Main Menu

The Main menu contains the various system settings.

- **System Date** sets the system date.
- **System Time** sets the system time.
- **OS Select** specifies which version of Windows your computer is running.
- **Boot Priority** determines the first device that the system boots from. Select Legacy First or UEFI First according to your needs.
- **Legacy USB Support** enables or disables the system’s support for Legacy USB device in DOS mode
- **CSM Support** enables or disables CSM (Compatibility Support Mode). You can set this item to Yes for backward compatibility with legacy BIOS services.
- **PXE Boot** sets the PXE boot to *UEFI* or *Legacy*. PXE (Preboot eXecution Environment) is an environment to boot computers using a network interface independently of data storage devices or installed operating systems.
- **Internal Numlock** sets if the Num Lock function of the built-in keyboard can work. When set to Enabled, you can press **Fn + Num LK** to activate the numeric keypad, which is embedded in the typewriter keys. When set to Disabled, Num

Lock does not work. In this case, you can still press **Fn +** a letter key to enter a number.

Advanced Menu

The Advanced menu contains the advanced settings.

- **Wake Up Capability**
Any-key Wake Up from S3 allows any key to wake up the system from S3 (Sleep) state.
USB Wake Up From S3 allow a USB device activity to wake up the system from S3 (Sleep) state.
- **System Policy** allows you to choose between Performance and *Balance*. If battery life is your first priority, select *Balance*. If you need system performance more than battery life, select *Performance*.
- **AC Initiation** sets if connecting AC power will automatically start or resume the system.
- **SATA Mode Selection** determines how the SATA controller works. It can be set to either *AHCI* or *Intel RST Premium* (RAID) mode.

CAUTION: Incorrect SATA mode settings can result in hard disk drive boot failure.

- **Active Management Technology Support** (This item appears only on models supporting vPro.)
Intel AMT Support enables or disables Intel® Active Management Technology BIOS extension execution. AMT allows the system administrator to access an AMT featured computer remotely.
Intel AMT Setup Prompt determines whether the prompt for entering Intel AMT Setup appears or not during POST. (This item only appears when the previous item is set to Enabled.)
USB Provisioning of AMT enables or disables the use of a USB key for provisioning Intel AMT.
- **Virtualization Technology Setup**
Intel(R) Virtualization Technology enables or disables Intel® VT (Intel Virtualization Technology) feature which provides hardware support for processor virtualization. When enabled, a VMM (Virtual Machine Monitor) can utilize the

additional hardware virtualization capabilities provided by this technology.

Intel(R) VT for Directed I/O (VT-d) enables or disables VT-d (Intel® Virtualization Technology for Directed I/O). When enabled, VT-d helps enhance Intel platforms for efficient virtualization of I/O devices.

SW Guard Extensions (SGX) can be set to *Disabled*, *Enabled*, or *Software Controlled*. Intel® Software Guard Extensions (Intel® SGX) is an Intel technology for increasing the security of application code. It is used by application developers.

- **Graphics Setup**
DVMT Pre-Allocated sets the amount of pre-allocated (fixed) graphics memory for use by the internal graphics device.
- **Device Configuration** enables or disables several hardware components. The items available for setting depend on your model.
- **Diagnostics and System Tester**
H20DST Tool performs system baseline check.
- **Device Manager** allows you to manage RAID volumes on the Intel RAID controller and Adaptec 6805 RAID card controller (if existing on your system). Note that the Intel RAID controller is available only when you set the **SATA Mode Selection** item to *Intel RST Premium*.

Security Menu

The Security menu contains the security settings, which safeguard your system against unauthorized use.

NOTE :

- You can set the user password only when the supervisor password has been set.
- If both the administrator and user passwords are set, you can enter any of them for starting up the system and/or entering BIOS Setup. However, the user password only allows you to view/change the settings of certain items.

- **Set Supervisor/User Password** sets the supervisor/user password. You can set the supervisor/user password to be required for starting up the system and/or entering BIOS Setup.
- **Strong Password** enables or disables strong password. When enabled, the password you set must contain at least one upper-case letter, one lower-case letter, and one digit.
- **Password Configuration** sets the minimum password length. Enter the number in the input field and select **Yes!**. The number should be between 4 and 64.
- **Password on Boot** allows you to enable or disable the entering of password for booting up your system.
- **Set HDD 0 Password** sets the password for locking the Primary Master hard disk drive. After setting a password, the hard disk drive can only be unlocked by the password no matter where it is installed.
- **TPM Setup Menu**
TPM Support enables or disables TPM (Trusted Platform Module) support. TPM (Trusted Platform Module) is a component on your computer's mainboard that is specifically designed to enhance platform security by providing a protected space for key operations and other security critical tasks.
Change TPM State allows you to select between No Change and Clear.
- **Intel Trusted Execution Technology** enables utilization of additional hardware capabilities provided by Intel® Trusted Execution Technology.

Boot Menu

The Boot menu sets the sequence of the devices to be searched for the operating system. (See the information on the right side of the menu for keyboard usage.)

Exit Menu

The Exit menu displays ways of exiting BIOS Setup Utility. After finishing with your settings, you must save and exit so that the changes can take effect.

- **Exit Saving Changes** saves the changes you have made and exits BIOS Setup Utility.
- **Exit Discarding Changes** exits BIOS Setup Utility without saving the changes you have made.
- **Load Setup Defaults** loads the factory default values for all the items.
- **Discard Changes** restores the previous values for all the items.
- **Saves Changes** saves the changes you have made.

Chapter 6

Using Getac Software

Getac software includes application programs for specific computer components and utility programs for overall management.

This chapter briefly introduces the programs.

G-Manager

G-Manager is a unified user interface utility that allows you to view, manage, or configure your computer features. With G-Manager, you can perform all or some of the tasks listed below.

- View system information.
- Check the battery status and configure the battery.
- Configure ECO modes (or called power profiles).
- Configure how the light sensor works.
- Change the function of the hardware button.
- Monitor the system.
- View the GPS information (select models only).

Right-click the Getac Utility icon  located on Windows taskbar and select **G-Manager** to start the program. The G-Manager window appears, containing several tabs.

NOTE: Depending on your model, the actual items and information appearing on the screen may differ from those shown in this manual.

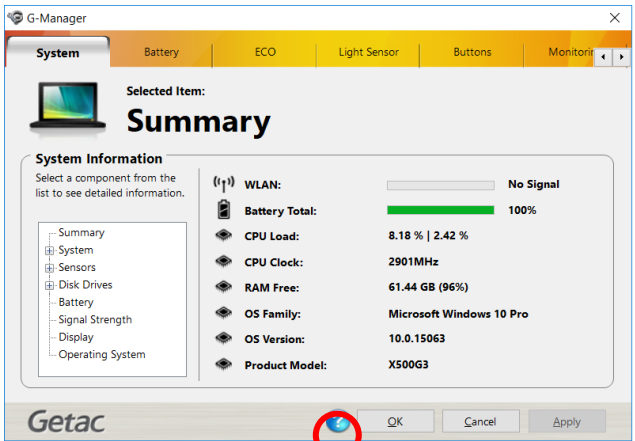

Help

For detailed information on the program, see the program's online help.

Chapter 7

Care and Maintenance

Taking good care of your computer will ensure a trouble-free operation and reduce the risk of damage to your computer.

This chapter gives you guidelines covering areas such as protecting, storing, cleaning, and traveling.

Protecting the Computer

To safeguard the integrity of your computer data as well as the computer itself, you can protect the computer in several ways as described in this section.

Using an Anti-Virus Strategy

You can install a virus-detecting program to monitor potential viruses that could damage your files.

Using the Cable Lock

You can use a Kensington-type cable lock to protect your computer against theft. The cable lock is available in most computer stores.

To use the lock, loop the lock cable around a stationary object such as a table. Insert the lock to the Kensington lock hole and turn the key to secure the lock. Store the key in a safe place.



Taking Care of the Computer

Location Guidelines

- For optimal performance, use the computer where the recommended temperature is between 0 °C (32 °F) and 55 °C (131 °F). (Actual operating temperature depends on product specifications.)
- Avoid placing the computer in a location subject to high humidity, extreme temperatures, mechanical vibration, direct sunlight, or heavy dust. Using the computer in extreme environments for long periods can result in product deterioration and a shortened product life.
- Operating in an environment with metallic dust is not allowed.
- Place the computer on a flat and steady surface. Do not stand the computer on its side or store it in an upside-down position. A strong impact by dropping or hitting may damage the computer.
- Do not cover or block any ventilation openings on the computer. For example, do not place the computer on a bed, sofa, rug, or other similar surface. Otherwise, overheating may occur that results in damage to the computer.
- As the computer can become very hot during operation, keep it away from objects that are vulnerable to heat.
- Keep the computer at least 13 cm (5 inches) away from electrical appliances that can generate a strong magnetic field such as a TV, refrigerator, motor, or a large audio speaker.
- Avoid moving the computer abruptly from a cold to a warm place. A temperature difference of more than 10 °C (18 °F) may cause condensation inside the unit, which may damage the storage media.

General Guidelines

- Do not place heavy objects on top of the computer when it is closed as this may damage the display.

- Do not move the computer simply by grasping the display screen.
- The screen surface is easily scratched. Do not use paper towels to clean the display but use the included soft cloth.
- LCD image sticking occurs when a fixed pattern is displayed on the screen for a prolonged period of time. You can avoid the problem by limiting the amount of static content on the display. It is recommended that you use a screen saver or turn off the display when it is not in use.
- To maximize the life of the backlight in the display, allow the backlight to automatically turn off as a result of power management.

Cleaning Guidelines

- Never clean the computer with its power on.
- Use a soft cloth moistened with water or a non-alkaline detergent to wipe the exterior of the computer.
- Gently wipe the display with a soft, lint-free cloth.
- Dust or grease on the touchpad can affect its sensitivity. Clean the pad by using adhesive tape to remove the dust and grease on its surface.
- If water or liquid is split onto the computer, wipe it dry and clean when possible. Though your computer is water-proof, do not leave the computer wet when you can dry it.
- If the computer gets wet where the temperature is 0°C (32°F) or below, freeze damage may occur. Make sure to dry the wet computer.

Battery Pack Guidelines

- Recharge the battery pack when it is nearly discharged. When recharging, make sure that the battery pack is fully charged. Doing so may avoid harm to the battery pack.

- The battery pack is a consumable product and the following conditions will shorten its life:
 - when frequently charging the battery pack
 - when using, charging, or storing in high temperature condition
- To avoid hastening the deterioration of the battery pack thereby prolonging its useful life, minimize the number of times you charge it so as not to frequently increase its internal temperature.
- Charge the battery pack between 10 °C ~ 30 °C (50 °F ~ 86 °F) temperature range. A higher environment temperature will cause the battery pack's temperature to rise. Avoid charging the battery pack inside a closed vehicle and in hot weather condition. Also, charging will not start if the battery pack is not within the allowed temperature range.
- It is recommended that you do not charge the battery pack more than once a day.
- It is recommended that you charge the battery pack with the computer's power off.
- To maintain the battery pack's operating efficiency, store it in a cool dark place removed from the computer and with 30 % ~ 40 % charge remaining.
- Important guidelines when using the battery pack.

When installing or removing the battery pack take note of the following:

 - avoid installing or removing the battery pack when the computer is in Sleep mode. Abruptly removing the battery pack may cause loss of data or the computer may become unstable.
 - avoid touching the battery pack terminals or damage may occur, thereby causing improper operation to it or the computer.

The computer's input voltage and surrounding temperature will directly affect the battery pack's charge and discharge time:

 - charging time will be prolonged when the computer is turned on. To shorten the charging time, it is recommended that you place the computer in sleep or hibernation mode.
 - a low temperature will prolong the charging time as well as hasten the discharge time.

- When using battery power in an extremely low temperature environment, you may experience shortened operating time and incorrect battery level reading. This phenomenon comes from the chemical characteristics of batteries. The appropriate operating temperature for the battery is $-10\text{ }^{\circ}\text{C} \sim 50\text{ }^{\circ}\text{C}$ ($14\text{ }^{\circ}\text{F} \sim 122\text{ }^{\circ}\text{F}$).
- Do not leave the battery pack in storage for more than six months without recharging it.

Touchscreen Guidelines

- Use the finger or stylus on the display. Using a sharp or metallic object other than your finger or stylus may cause scratches and damage the display, thereby causing errors.
- Use a soft cloth to remove dirt on the display. The touchscreen surface has a special protective coating that prevents dirt from sticking to it. Not using a soft cloth may cause damage to the special protective coating on the touchscreen surface.
- Turn off the computer power when cleaning the display. Cleaning the display with the power on may cause improper operation.
- Do not use excessive force on the display. Avoid placing objects on top of the display as this may cause the glass to break thereby damaging the display.
- Using the touchscreen during low temperature ($\text{below } 5\text{ }^{\circ}\text{C} / 41\text{ }^{\circ}\text{F}$) may cause a slower response time, this is normal. A normal response time may be restored upon returning to room temperature.
- When there is noticeable discrepancy in the operation of the touchscreen function (wrong location on intended operation or improper display resolution), refer to the Windows online Help for instructions on recalibrating the touchscreen display.

When Traveling

- Before traveling with your computer, make a backup of your hard disk data into flash disks or other storage devices. As an added precaution, bring along an extra copy of your important data.
- Make sure that the battery pack is fully charged.
- Make sure that the computer is turned off and the top cover is securely closed.
- Make sure that all the connector covers are closed completely to ensure the waterproof integrity.
- Do not leave objects in between the keyboard and closed display.
- Disconnect the AC adapter from the computer and take it with you. Use the AC adapter as the power source and as a battery-charger.
- Hand-carry the computer. Do not check it in as luggage.
- If you need to leave the computer in the car, put it in the trunk of the car to avoid exposing the computer to excessive heat.
- When going through airport security, it is recommended that you send the computer and flash disks through the X-ray machine (the device you set your bags on). Avoid the magnetic detector (the device you walk through) or the magnetic wand (the handheld device used by security personnel).
- If you plan to travel abroad with your computer, consult your dealer for the appropriate AC power cord for use in your country of destination.

Chapter 8

Troubleshooting

Computer problems can be caused by hardware, software, or both. When you encounter any problem, it might be a typical problem that can easily be solved.

This chapter tells you what actions to take when solving common computer problems.

Preliminary Checklist

Here are helpful hints to follow before you take further actions when you encounter any problem:

- Try to isolate which part of the computer is causing the problem.
- Make sure that you turn on all peripheral devices before turning on the computer.
- If an external device has a problem, make sure that the cable connections are correct and secure.
- Make sure that the configuration information is properly set in the BIOS Setup program.
- Make sure that all the device drivers are correctly installed.
- Make notes of your observations. Are there any messages on the screen? Do any indicators light? Do you hear any beeps? Detailed descriptions are useful to the service personnel when you need to consult one for assistance.

If any problem persists after you follow the instructions in this chapter, contact an authorized dealer for help.

Solving Common Problems

Battery Problems

The battery does not charge (Battery Charge indicator does not light amber).

- Make sure that the AC adapter is properly connected.
- Make sure that the battery is not too hot or cold. Allow time for the battery pack to return to room temperature.
- If the battery doesn't charge after it has been stored in very low temperatures, try disconnecting and reconnecting the AC adapter to solve the problem.
- Make sure that the battery pack is installed correctly.
- Make sure that the battery terminals are clean.

The operating time of a fully charged battery becomes shorter.

- If you often partially recharge and discharge, the battery might not be charged to its full potential. Initialize the battery to solve the problem.

The battery operating time indicated by the battery meter does not match the actual operating time.

- The actual operating time can be different from the estimated time, depending on how you are using the computer. If the actual operating time is much less than the estimated time, initialize the battery.

Bluetooth Problems

I cannot connect to another Bluetooth-enabled device.

- Make sure that both devices have activated Bluetooth feature.
- Make sure that the distance between the two devices is within the limit and that there are no walls or other obstructions between the devices.
- Make sure that the other device is not in “Hidden” mode.

- Make sure that both devices are compatible.

Display Problems

Nothing appears on the screen.

- During operation, the screen may automatically turn off as a result of power management. Press any key to see if the screen comes back.
- The brightness level might be too low. Increase brightness.
- The display output might be set to an external device. To switch the display back to the LCD, press the **Fn+F9** hot key or change the display through the **Display Settings** Properties.

The characters on the screen are dim.

- Adjust the brightness and/or contrast.

The display brightness cannot be increased.

- As a protection, the display brightness will be fixed at a low level when the surrounding temperature is too high or too low. It is not a malfunction in this situation.

Bad dots appear on the display at all times.

- A small number of missing, discolored, or bright dots on the screen are an intrinsic characteristic of TFT LCD technology. It is not regarded as a LCD defect.

Clouding (or called “mura”) happens on the screen when you exert forces on the left or right side of the LCD frame.

- This is a normal phenomenon, not a defect.

DVD Drive Problems

The DVD drive cannot read a disc.

- Make sure that the disc is correctly seated in the tray, with the label facing up.

- Make sure that the disc is not dirty. Clean the disc with a disc cleaning kit, available in most computer stores.
- Make sure that the computer supports the disc or the files contained.

You cannot eject a disc.

- The disc is not properly seated in the drive. Manually release the disc by inserting a small rod, such as a straightened paperclip, into the drive's manual eject hole and pushing firmly to release the tray.



Hardware Device Problems

The computer does not recognize a newly installed device.

- The device may not be correctly configured in the BIOS Setup program. Run the BIOS Setup program to identify the new type.
- Make sure if any device driver needs to be installed. (Refer to the documentation that came with the device.)
- Make sure if the device needs any jumper or switch settings. (Refer to the documentation that came with the device.)
- Check the cables or power cords for correct connections.
- For an external device that has its own power switch, make sure that the power is turned on.

Hard Disk Drive Problems

The hard disk drive error message appears on the screen.

- The hard disk drive has defects. Ask your dealer for help.

The hard disk drive operations seem slow.

- The data files stored on the hard disk drive may be fragmented. Defragment the drive. (See Windows online help for instructions.).

The hard disk drive in-use indicator glows without blinking.

- The data files stored on the hard disk drive may be fragmented. Defragment the drive. (See Windows online help for instructions.).

Keyboard and Touchpad Problems

The keyboard does not respond.

- Try connecting an external keyboard. If it works, contact an authorized dealer, as the internal keyboard cable might be loose.

Water or liquid is spilled into the keyboard.

- Immediately turn off the computer and unplug the AC adapter. Then tilt the keyboard 90 degrees to the right (where the drainpipe ends are located) to let the liquid flow out of the keyboard. Make sure to clean up any part of the spill you can get to. Though the keyboard of your computer is spill-proof, liquid will remain in the keyboard enclosure if you don't remove it. Wait for the keyboard to air dry before using the computer again.

The touchpad does not work, or the pointer is difficult to control with the touchpad.

- Make sure that the touchpad is clean.

LAN Problems

I cannot access the network.

- Make sure that the LAN cable is properly connected to the RJ-45 connector and the network hub.
- Make sure that the network configuration is appropriate.
- Make sure that the user name or password is correct.

Power Management Problems

The computer does not enter Sleep or Hibernation mode automatically.

- If you have a connection to another computer, the computer does not enter Sleep or Hibernation mode if the connection is actively in use.
- Make sure that the Sleep or Hibernation time-out is enabled.

The computer does not enter Sleep or Hibernation mode immediately.

- If the computer is performing an operation, it normally waits for the operation to finish.

The computer does not resume from Sleep or Hibernation mode.

- The computer automatically enters Sleep or Hibernation mode when the battery pack is empty. Do any one of the following:
 - Connect the AC adapter to the computer.
 - Replace the empty battery pack with a fully charged one.

Software Problems

An application program does not work correctly.

- Make sure that the software is correctly installed.
- If an error message appears on the screen, consult the software program's documentation for further information.
- If you are sure the operation has stop, reset the computer.

Sound Problems

No sound is produced.

- Make sure that the volume control is not set too low.
- Make sure that the computer is not in Sleep mode.
- If using an external speaker, make sure that the speaker is properly connected.

Distorted sound is produced.

- Make sure that the volume control is not set too high or too low. In most cases, a high setting can cause the audio electronics to distort the sound.

Startup Problems

When you turn on the computer, it does not seem to respond.

- Make sure that either the AC adapter is connected or the battery has power.
- **For models with the “HDD preheat” feature:** When turning on the computer in an extremely low temperature environment, the computer will heat up the hard disk before starting up. The AC Power indicator () lights red to indicate the heater is on. Wait till the heating is finished. However, if external AC power is not available and the remaining battery power is too low for the heating to complete, the computer may not start up. In case the computer fails to start up, turn off the computer and leave it in room temperature for about an hour before trying to turn it on again.

WLAN Problems

I cannot use the WLAN feature.

- Make sure that the WLAN feature is turned on.

Transmission quality is poor.

- Your computer may be in an out-of-range situation. Move your computer closer to the Access Point or another WLAN device it is associated with.
- Check if there is high interference around the environment and solve the problem as described next.

Radio interference exists.

- Move your computer away from the device causing the radio interference such as microwave oven and large metal objects.

- Plug your computer into an outlet on a different branch circuit from that used by the affecting device.
- Consult your dealer or an experienced radio technician for help.

I cannot connect to another WLAN device.

- Make sure that the WLAN feature is turned on.
- Make sure that the SSID setting is the same for every WLAN device in the network.
- Your computer is not recognizing changes. Restart the computer.
- Make sure that the IP address or subnet mask setting is correct.

I cannot communicate with the computer in the network when Infrastructure mode is configured.

- Make sure that the Access Point your computer is associated with is powered on and all the LEDs are working properly.
- If the operating radio channel is in poor quality, change the Access Point and all the wireless station(s) within the BSSID to another radio channel.
- Your computer may be in an out-of-range situation. Move your computer closer to the Access Point it is associated with.
- Make sure that your computer is configured with the same security option (encryption) to the Access Point.
- Use the Web Manager/Telnet of the Access Point to check whether it is connected to the network.
- Reconfigure and reset the Access Point.

I cannot access the network.

- Make sure that the network configuration is appropriate.
- Make sure that the user name or password is correct.
- You have moved out of range of the network.

- Turn off power management.

Other Problems

The date/time is incorrect.

- Correct the date and time via the operating system or BIOS Setup program.
- After you have performed everything as described above and still have the incorrect date and time every time you turn on the computer, the RTC (Real-Time Clock) battery is at the end of its life. Call an authorized dealer to replace the RTC battery.

Resetting the Computer

You may have to reset (reboot) your computer on some occasions when an error occurs and the program you are using hangs up.

If you are sure the operation has stopped and you cannot use the “restart” function of the operating system, reset the computer

Reset the computer by any of these methods:

- Press **Ctrl+Alt+Del** on the keyboard. This opens the **Ctrl-Alt-Del** screen where you can select actions including **Restart**.
- If the above action does not work, press and hold the power button for more than 5 seconds to force the system to turn off. Then turn on the power again.

System Restore, Recovery, or Reset

Click  → **Settings** → **Update & security**. You have several options.

- **System Restore**

This option allows you to restore Windows to an earlier point in time if you have created a restore point.

- **Recover from a drive**

If you have created a recovery drive on Windows 10, you can use the recovery drive to reinstall Windows

- **Reset this PC**

This option allows you to reinstall Windows with or without keeping your files.

See Microsoft website for more information.

NOTE: System recovery for Windows 10 typically will take several hours to complete.

Using the Driver Disc (Optional)

NOTE: You can download the latest drivers and utilities from Getac website at <http://www.getac.com> → **Support**.

The Driver disc contains drivers and utilities required for specific hardware in your computer.

Since your computer comes with drivers and utilities pre-installed, you normally do not need to use the Driver disc. In case you want to manually install Windows, you will have to install the drivers and utilities one by one after installing Windows.

To manually install drivers and utilities:

1. Start up the computer.
2. Insert the Driver disc. Make sure you use the disc that matches the Windows version of your computer.
3. The autorun program should automatically start. You will see the installation menu. Click **NEXT** to go to the next page if there is more than one.
4. To install a driver or utility, just click the particular button and follow the onscreen instructions to complete the installation.

Appendix A

Specifications

NOTE: Specifications are subject to change without any prior notice.

Parts		Specifications
CPU		Intel® Core™ i5-7440HQ vPro™ Processor 2.8 GHz, Max 3.8 GHz with Intel® Turbo Boost Technology <ul style="list-style-type: none">- 6 MB Intel® Smart Cache- Mobile Intel® QM175 Chipset
		Intel® Core™ i7-7820HQ vPro™ Processor 2.9 GHz, Max 3.9 GHz with Intel® Turbo Boost Technology <ul style="list-style-type: none">- 8 MB Intel® Smart Cache- Mobile Intel® QM175 Chipset
		Intel® Xeon® E3-1505M v6 vPro™ Processor 3.0 GHz, Max 4.0 GHz with Intel® Turbo Boost Technology <ul style="list-style-type: none">- 8 MB Intel® Smart Cache- Mobile Intel® CM238 Chipset
BIOS		16 MB SPI Flash
RAM		Default 8 GB (for Intel Core processors) or 16 GB (for Intel Xeon processors), Max. 64 GB, DDR4 SO-DIMM Option: ECC DDR4 R-DIMM
Video	Controller	Default: UMA - Intel® HD Graphics 630 Option: Nvidia N16P-GT (Geforce 950M)
	Display panel	15.6-inch (16:9) TFT LCD, FHD 1920x1080, sunlight readable, 1200 Nits maximum brightness, touchscreen with stylus (option)
Audio	Features	Azalia 32 bit, 192KHz chipset, HD audio support, MS-Sound compatible
	Speaker	Speaker × 2
	Microphone	Integrated microphone

Parts		Specifications
Keyboard		Standard keys with numeric pad keys, 12 function keys, special Fn (Function) key and Windows keys, water-proof membrane, with backlight (option)
Pointing device		Glide touchpad with 2 buttons
Storage device	Hard disk drive	SATA III interface, 2.5-inch diameter, shock-mounted, user-removable, solid-state disk (option), HDD heater (option), secondary hard disk drive and RAID support (option)
	DVD drive	SATA interface, Super-Multi DVD drive
Card slots		PCMCIA CardBus Type II ExpressCard/54 Smart Card Secure Digital card
I/O ports		USB 3.0 x 4, serial (RS232/RS422) x 2, VGA, HDMI, RJ-45 x 2, headphone out, microphone, docking
LAN		LAN1: Intel® Jacksonville LM Gigabit Network Connection LAN2: Realtek 8111H
WLAN + Bluetooth		Intel (Windstorm Peak 8265) 802.11 AC + Bluetooth 4.2 combo
GPS (option)		GPS module
WWAN (option)		WWAN 3G minicard, external accessible SIM card slot
Camera (option)		2M FHD Webcam
Security		Kensington lock TPM 2.0 Fingerprint scanner, slide type (option) Smart Card Reader
Power	AC adapter	Universal AC adapter, 150 W; input: 100~240 V, output: 19 V
	Battery pack	8700mAh, 9 cells, 10.8V
Dimension (LxWxD)		410 x 290 x 65mm (16.1 × 11.4 × 2.5 inch)
Weight		5.2 kg (11.4 lb)

Appendix B

Regulatory Information

This appendix provides regulatory statements and safety notices on your computer.

NOTE: Marking labels located on the exterior of your computer indicate the regulations that your model complies with. Please check the marking labels and refer to the corresponding statements in this appendix. Some notices apply to specific models only.

On the Use of the System

Class B Regulations

USA

Federal Communications Commission Radio Frequency Interference Statement

NOTE:

This equipment has been tested and found to comply with the limits for a Class B digital device pursuant to Part 15 of the FCC Rules. These limits are designed to provide reasonable protection against harmful interference in a residential installation. This equipment generates, uses, and can radiate radio frequency energy and, if not installed and used in accordance with the instructions, may cause harmful interference to radio communications. However, there is no guarantee that interference will not occur in a particular installation. If this equipment does cause harmful interference to radio or television reception, which can be determined by turning the equipment off and on, the user is encouraged to try to correct the interference by one or more of the following measures:

- Reorient or relocate the receiving antenna.
- Increase the separation between the equipment and receiver.
- Connect the equipment into an outlet on a circuit different from that to which the receiver is connected.
- Consult the dealer or an experienced radio/TV technician for help.

Any changes or modifications not expressly approved by the manufacturer could void the user's authority to operate the equipment.

Please note:

The use of a non-shielded interface cable with this equipment is prohibited.

Canada

Canadian Department of Communications Radio Interference Regulations Class B Compliance Notice

This Class B digital apparatus meets all requirements of the Canada Interference-Causing equipment regulations.

Cet appareil numérique de Classe B respecte toutes les exigences du Règlement Canadien sur le matériel brouilleur.

This digital apparatus does not exceed the Class B limits for radio noise emissions from digital apparatus set out in the Radio Interference Regulations of the Canadian Department of Communications.

Le présent appareil numérique n'émet pas de bruits radioélectriques dépassant les limites applicables aux appareils numériques de la classe B prescrites dans le Règlement sur le brouillage radioélectrique édicté par le ministère des Communications du Canada.

Safety Notices

About the Battery

- Keep the battery pack out of the reach of children.

Caution Texts Concerning Lithium Batteries

DANISH

ADVARSEL! Lithiumbatteri – Eksplosionsfare ved fejlagtig håndtering. Udskiftning må kun ske med batteri af samme fabrikat og type. Levér det brugte batteri tilbage til leverandøren.

NORWEGIAN

ADVARSEL: Eksplosjonsfare ved feilaktig skifte av batteri. Benytt samme batteritype eller en tilsvarende type anbefalt av apparatfabrikanten. Brukte batterier kasseres i henhold til fabrikantens instruksjoner.

SWEDISH

VARNING: Explosionsfara vid felaktigt batteribyte. Använd samma batterityp eller en

ekvivalent typ som rekommenderas av apparatillverkaren. Kassera använt batteri enligt fabrikantens instruktion.

FINNISH

VAROITUS: Paristo voi räjähtää, jos se on virheellisesti asennettu. Vaihda paristo ainoastaan valmistajan suosittelemaan tyyppiin. Hävitä käytetty paristo valmistajan ohjeiden mukaisesti.

ENGLISH

CAUTION: Danger of explosion if battery is incorrectly replaced. Replace only with the same or equivalent type recommended by the equipment manufacturer. Discard used batteries according to manufacturer's instructions.

DEUTSCH

VORSICHT: Explosionsgefahr bei unsachgemäßem Austausch der Batterie. Ersatz nur durch denselben oder einen vom Hersteller empfohlenen gleichwertigen Typ. Entsorgung gebrauchter Batterien nach Angaben des Herstellers.

FRENCH

ATTENTION: Il y a danger d'explosion s'il y a un remplacement incorrect de la batterie. Remplacer uniquement avec une batterie du même type ou d'un type équivalent recommandé par le constructeur. Mettre au rebut les batteries usagées conformément aux instructions du fabricant.

Attention (for USA Users)

The product that you have purchased contains a rechargeable battery. The battery is recyclable. At the end of its useful life, under various state and local laws, it may be illegal to dispose of this battery into the municipal waste stream. Check with your local solid waste officials for details in your area for recycling options or proper disposal.

About the AC Adapter

- Use only the AC adapter supplied with your computer. Use of another type of AC adapter will result in malfunction and/or danger.
- Do not use the adapter in a high moisture environment. Never touch the adapter when your hands or feet are wet.

- Allow adequate ventilation around the adapter when using it to operate the device or charge the battery. Do not cover the AC adapter with paper or other objects that will reduce cooling. Do not use the AC adapter while it is inside a carrying case.
- Connect the adapter to a proper power source. The voltage requirements are found on the product case and/or packaging.
- Do not use the adapter if the cord becomes damaged.
- Do not attempt to service the unit. There are no serviceable parts inside. Replace the unit if it is damaged or exposed to excess moisture.

Option ANSI Instruction

INSTALLATION INSTRUCTIONS:

- This equipment is suitable for use in Class I, Division 2, Groups A, B, C and D or non-hazardous locations only.
- WARNING – EXPLOSION HAZARD – Do not disconnect equipment unless power has been removed or the area is known to be non-hazardous.
- WARNING – EXPLOSION HAZARD – Substitution of components may impair suitability for Class I, Division 2.
- WARNING – EXPLOSION HAZARD – External Connections/Hubs are not to be used in a Hazardous Location.
- WARNING – EXPLOSION HAZARD – Notebook is to be only powered from the battery pack while in Hazardous Locations.
- Replace battery manufactured by Getac Technology Corp. only. Use of another battery may present a risk of fire or explosion.

On the Use of the RF Device

USA and Canada Safety Requirements and Notices

This device complies with Part 15 of the FCC Rules. Operation is subject to the following two conditions: (1) This device may not cause harmful interference, and (2) this device must accept any interference received, including interference that may cause undesired operation.

This equipment has been tested and found to comply with the limits for a Class B digital device, pursuant to Part 15 of the FCC Rules. These limits are designed to provide reasonable protection against harmful interference in a residential installation. This equipment generates, uses and can radiate radio frequency energy and, if not installed and used in accordance with the instructions, may cause harmful interference to radio communications. However, there is no guarantee that interference will not occur in a particular installation. If this equipment does cause harmful interference to radio or television reception, which can be determined by turning the equipment off and on, the user is encouraged to try to correct the interference by one of the following measures:

- Reorient or relocate the receiving antenna.
- Increase the separation between the equipment and receiver.
- Connect the equipment into an outlet on a circuit different from that to which the receiver is connected.
- Consult the dealer or an experienced radio/TV technician for help.

FCC Caution:

- Any changes or modifications not expressly approved by the party responsible for compliance could void the user's authority to operate this equipment.
- This transmitter must not be co-located or operating in conjunction with any other antenna or transmitter.

Radiation Exposure Statement:

This equipment complies with FCC radiation exposure limits set forth for an uncontrolled environment. This equipment should be installed and operated with minimum distance 20cm between the radiator & your body.

Note: The country code selection is for non-US model only and is not available to all US model. Per FCC regulation, all Wi-Fi product marketed in US must fixed to US operation channels only.

Canada Radio Frequency Interference Requirements

- ❶ This device complies with Industry Canada license-exempt RSS standard(s). Operation is subject to the following two conditions:
 - 1) this device may not cause interference, and
 - 2) this device must accept any interference, including interference that may cause undesired operation of the device.
- ❶ Le présent appareil est conforme aux CNR d'Industrie Canada applicables aux appareils radio exempts de licence. L'exploitation est autorisée aux deux conditions suivantes:
 - 1) l'appareil ne doit pas produire de brouillage, etl'utilisateur de l'appareil doit accepter tout brouillage radioélectrique subi, même si le brouillage est susceptible d'en compromettre le fonctionnement.
- ❷ This Class B digital apparatus complies with Canadian ICES-003.
- ❷ Cet appareil numérique de la classe B est conforme à la norme NMB-003 du Canada.
- ❹ This device and its antenna(s) must not be co-located or operating in conjunction with any other antenna or transmitter, except tested built-in radios.
- ❹ Cet appareil et son antenne ne doivent pas être situés ou fonctionner en conjonction avec une autre antenne ou un autre émetteur, exception faites des radios intégrées qui ont été testées.
- ❺ The County Code Selection feature is disabled for products marketed in the US/ Canada.

- ⑤ La fonction de sélection de l'indicatif du pays est désactivée pour les produits commercialisés aux États-Unis et au Canada.

Radiation Exposure Statement:

The product comply with the Canada portable RF exposure limit set forth for an uncontrolled environment and are safe for intended operation as described in this manual. The further RF exposure reduction can be achieved if the product can be kept as far as possible from the user body or set the device to lower output power if such function is available.

Déclaration d'exposition aux radiations:

Le produit est conforme aux limites d'exposition pour les appareils portables RF pour les Etats-Unis et le Canada établies pour un environnement non contrôlé.

Le produit est sûr pour un fonctionnement tel que décrit dans ce manuel. La réduction aux expositions RF peut être augmentée si l'appareil peut être conservé aussi loin que possible du corps de l'utilisateur ou que le dispositif est réglé sur la puissance de sortie la plus faible si une telle fonction est disponible.

Caution :

- 1) the device for operation in the band 5150–5250 MHz is only for indoor use to reduce the potential for harmful interference to co-channel mobile satellite systems;
- 2) the maximum antenna gain permitted for devices in the bands 5250–5350 MHz and 5470–5725 MHz shall comply with the e.i.r.p. limit; and
- 3) the maximum antenna gain permitted for devices in the band 5725–5825 MHz shall comply with the e.i.r.p. limits specified for point-to-point and non point-to-point operation as appropriate.
- 4) the worst-case tilt angle(s) necessary to remain compliant with the e.i.r.p. elevation mask requirement set forth in Section 6.2.2(3) shall be clearly indicated.
- 5) Users should also be advised that high-power radars are allocated as primary users (i.e. priority users) of the bands 5250–5350 MHz and 5650–5850 MHz and that these radars could cause interference and/or damage to LE-LAN devices.

Avertissement:

- 1) les dispositifs fonctionnant dans la bande 5150–5250 MHz sont réservés uniquement pour une utilisation à l'intérieur afin de réduire les risques de brouillage préjudiciable aux systèmes de satellites mobiles utilisant les mêmes canaux;
- 2) le gain maximal d'antenne permis pour les dispositifs utilisant les bandes 5250–5350 MHz et 5470–5725 MHz doit se conformer à la limite de p.i.r.e.;
- 3) le gain maximal d'antenne permis (pour les dispositifs utilisant la bande 5725–5825 MHz) doit se conformer à la limite de p.i.r.e. spécifiée pour l'exploitation point à point et non point à point, selon le cas.
- 4) les pires angles d'inclinaison nécessaires pour rester conforme à l'exigence de la p.i.r.e. applicable au masque d'élévation, et énoncée à la section 6.2.2 3), doivent être clairement indiqués.
- 5) De plus, les utilisateurs devraient aussi être avisés que les utilisateurs de radars de haute puissance sont désignés utilisateurs principaux (c.-à-d., qu'ils ont la priorité) pour les bandes 5250–5350 MHz et 5650–5850 MHz et que ces radars pourraient causer du brouillage et/ou des dommages aux dispositifs LAN-EL.

European Union CE Marking and Compliance Notices

Statements of Compliance

English

This product follows the provisions of the European Directive 2014/53/EU.

Danish

Dette produkt er i overensstemmelse med det europæiske direktiv 2014/53/EU.

Dutch

Dit product is in navolging van de bepalingen van Europees Directief 2014/53/EU.

Finnish

Tämä tuote noudattaa EU-direktiivin 2014/53/EU määräyksiä.

French

Ce produit est conforme aux exigences de la Directive Européenne 2014/53/EU.

German

Dieses Produkt entspricht den Bestimmungen der Europäischen Richtlinie 2014/53/EU.

Greek

Το προϊόν αυτό πληροί τις προβλέψεις της Ευρωπαϊκής Οδηγίας 2014/53/EU.

Icelandic

Þessi vara sténst reglugerð Evrópska Efnahags Bandalagsins númer 2014/53/EU.

Italian

Questo prodotto è conforme alla Direttiva Europea 2014/53/EU.

Norwegian

Denne produktet er i henhold til bestemmelsene i det europeiske direktivet 2014/53/EU.

Portuguese

Este produto cumpre com as normas da Diretiva Europeia 2014/53/EU.

Spanish

Este producto cumple con las normas del Directivo Europeo 2014/53/EU.

Swedish

Denna produkt har tillverkats i enlighet med EG-direktiv 2014/53/EU.

Notices

CE Max power:

WLAN 2.4G: 16.5 dBm

WLAN 5G: 16.8 dBm

BT: 10 dBm

WWAN: 23.2 dBm

The device is restricted to indoor use only when operating in the 5150 to 5350 MHz frequency range.

	AT	BE	BG	HR	CY	CZ	DK
	EE	FI	FR	DE	EL	HU	IE
	IT	LV	LT	LU	MT	NL	PL
	PT	RO	SK	SI	ES	SE	UK

	<p>Waste Electrical and Electronic Equipment (WEEE)</p> <p>This symbol means that according to local laws and regulations your product and/or its battery shall be disposed of separately from household waste. When this product reaches its end of life, take it to a collection point designated by local authorities. Proper recycling of your product will protect human health and the environment.</p>
---	--

User Notification of Take-back Service

To Institutional (B2B) Users in United States:

Getac believes in providing our institutional customers with easy-to-use solutions to recycle your Getac-brand products for free. Getac understands the institutional customers will likely be recycling multiple items at once and as such. Getac wants to make the recycling process for these larger shipments as streamlined as possible. Getac works with recycling vendors with the highest standards for protecting our environment, ensuring worker safety, and complying with global environmental laws. Our commitment to recycling our old equipment grows out of our work to protect the environment in many ways.

Please see the product type below for information on Getac product, battery and packaging recycling in USA.

- **For Product Recycling:**

Your portable Getac products contain hazardous materials. While they pose no risk to you during normal use, they should never be disposed with other wastes. Getac provides a free take-back service for recycling your Getac products. Our electronics recycler will provide competitive bids for recycling non-Getac products as well.

- **For Battery Recycling:**

The batteries used to power your portable Getac products contain hazardous materials. While they pose no risk to you during normal use, they should never be disposed with other wastes. Getac provides a free take-back service for recycling your batteries from Getac products.

- **For Packaging Recycling:**

Getac has chosen the packaging materials used to transport our products carefully, to balance the requirements of shipping the product to you safely while minimizing the amount of material used. The materials used in our packaging are designed to be recycled locally.

If you have the above for recycling, please contact our recycler, All Green Electronics Recycling, LLC. For more information on recycling, visit the website

<http://www.allgreenrecycling.com>.

ENERGY STAR 6.1

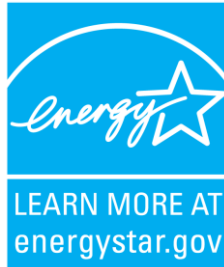

ENERGY STAR[®] is a government program that offers businesses and consumers energy-efficient solutions, making it easy to save money while protecting the environment for future generations.

Please reference ENERGY STAR[®] related information from <http://www.energystar.gov>.

As an ENERGY STAR[®] Partner, Getac Technology Corporation has determined that this product meets the ENERGY STAR[®] guidelines for energy efficiency.

An ENERGY STAR[®] qualified computer uses 70 % less electricity than computers without enabled power management features.

Earning the ENERGY STAR[®]

- When every home office is powered by equipment that has earned the ENERGY STAR[®], the change will keep over 289 billion pounds of greenhouse gases out of the air.
- If left inactive, ENERGY STAR[®] qualified computers enter a low-power mode and may use 15 watts or less. New chip technologies make power management features more reliable, dependable, and user-friendly than even just a few years ago.
- Spending a large portion of time in low-power mode not only saves energy, but helps equipment run cooler and last longer.

- Businesses that use ENERGY STAR® enabled office equipment may realize additional savings on air conditioning and maintenance.
- Over its lifetime, ENERGY STAR® qualified equipment in a single home office (e.g., computer, monitor, printer, and fax) can save enough electricity to light an entire home for more than 4 years.
- Power management (“sleep settings”) on computers and monitors can result in much savings annually.

Remember, saving energy prevents pollution

Because most computer equipment is left on 24 hours a day, power management features are important for saving energy and are an easy way to reduce air pollution. By using less energy, these products help lower consumers’ utility bills, and prevent greenhouse gas emissions.

Getac Product Compliance

All Getac products with ENERGY STAR® logo comply with the ENERGY STAR® standard, and the power management feature is enabled by default. As recommended by the ENERGY STAR® program for optimal energy savings, the computer is automatically set to sleep after 15 minutes (in battery mode) and 30 minutes (in AC mode) of user inactivity. To wake up the computer, press the power button.

If you want to configure power management settings such as inactivity time and ways to initiate/end Sleep mode, go to **Power Options** by right-clicking the battery icon on the Windows taskbar and then selecting **Power Options** in the pop-up menu.

Please visit <http://www.energystar.gov/powermanagement> for detail information on power management and its benefits to the environment.

Battery Recycling

For the U.S. and Canada only:

To recycle the battery, please go to the RBRC Call2Recycle website or use the Call2Recycle Helpline at 800-822-8837.

Call2Recycle® is a product stewardship program providing no-cost battery and cellphone recycling solutions across the U.S. and Canada. Operated by Call2Recycle, Inc., a 501(c)4 nonprofit public service organization, the program is funded by battery and product manufacturers committed to responsible recycling. See more at: <http://www.call2recycle.org>

