

FCC Test Report

Report No.: RF170428C35

FCC ID: QYL8260GAINF110

Test Model: F110

Received Date: Apr. 28, 2017

Test Date: May 16, 2017 ~ May 19, 2017

Issued Date: Jun. 09, 2017

Applicant: Getac Technology Corporation.

Address: 5F., Building A, No. 209, Sec.1, Nangang Rd., Nangang Dist., Taipei City
11568, Taiwan, R.O.C.

Issued By: Bureau Veritas Consumer Products Services (H.K.) Ltd., Taoyuan Branch

Lab Address: No. 47-2, 14th Ling, Chia Pau Vil., Lin Kou Dist., New Taipei City, Taiwan
(R.O.C)

Test Location: No.19, Hwa Ya 2nd Rd., Wen Hwa Vil., Kwei Shan Dist., Taoyuan City
33383, Taiwan, R.O.C.



This report is for your exclusive use. Any copying or replication of this report to or for any other person or entity, or use of our name or trademark, is permitted only with our prior written permission. This report sets forth our findings solely with respect to the test samples identified herein. The results set forth in this report are not indicative or representative of the quality or characteristics of the lot from which a test sample was taken or any similar or identical product unless specifically and expressly noted. Our report includes all of the tests requested by you and the results thereof based upon the information that you provided to us. You have 60 days from date of issuance of this report to notify us of any material error or omission caused by our negligence, provided, however, that such notice shall be in writing and shall specifically address the issue you wish to raise. A failure to raise such issue within the prescribed time shall constitute your unqualified acceptance of the completeness of this report, the tests conducted and the correctness of the report contents. Unless specific mention, the uncertainty of measurement has been explicitly taken into account to declare the compliance or non-compliance to the specification.

Table of Contents

Release Control Record	4
1 Certificate of Conformity	5
2 Summary of Test Results	6
2.1 Measurement Uncertainty	6
2.2 Modification Record	6
3 General Information	7
3.1 General Description of EUT	7
3.2 Description of Test Modes	8
3.2.1 Test Mode Applicability and Tested Channel Detail	9
3.3 Duty Cycle of Test Signal	11
3.4 Description of Support Units	12
3.4.1 Configuration of System under Test	12
3.5 General Description of Applied Standards	12
4 Test Types and Results	13
4.1 Radiated Emission and Bandedge Measurement	13
4.1.1 Limits of Radiated Emission and Bandedge Measurement	13
4.1.2 Test Instruments	14
4.1.3 Test Procedures	15
4.1.4 Deviation from Test Standard	15
4.1.5 Test Set Up	16
4.1.6 EUT Operating Conditions	16
4.1.7 Test Results	17
4.2 Conducted Emission Measurement	30
4.2.1 Limits of Conducted Emission Measurement	30
4.2.2 Test Instruments	30
4.2.3 Test Procedures	31
4.2.4 Deviation from Test Standard	31
4.2.5 Test Setup	31
4.2.6 EUT Operating Conditions	31
4.2.7 Test Results	32
4.3 6 dB Bandwidth Measurement	34
4.3.1 Limits of 6 dB Bandwidth Measurement	34
4.3.2 Test Setup	34
4.3.3 Test Instruments	34
4.3.4 Test Procedure	34
4.3.5 Deviation from Test Standard	34
4.3.6 EUT Operating Conditions	34
4.3.7 Test Result	35
4.4 Conducted Output Power Measurement	37
4.4.1 Limits of Conducted Output Power Measurement	37
4.4.2 Test Setup	37
4.4.3 Test Instruments	37
4.4.4 Test Procedures	37
4.4.5 Deviation from Test Standard	37
4.4.6 EUT Operating Conditions	37
4.4.7 Test Results	38
4.5 Power Spectral Density Measurement	39
4.5.1 Limits of Power Spectral Density Measurement	39
4.5.2 Test Setup	39
4.5.3 Test Instruments	39
4.5.4 Test Procedure	39
4.5.5 Deviation from Test Standard	39
4.5.6 EUT Operating Condition	39

4.5.7 Test Results	40
4.6 Conducted Out of Band Emission Measurement	42
4.6.1 Limits of Conducted Out of Band Emission Measurement.....	42
4.6.2 Test Setup.....	42
4.6.3 Test Instruments	42
4.6.4 Test Procedure	42
4.6.5 Deviation from Test Standard	42
4.6.6 EUT Operating Condition	42
4.6.7 Test Results	43
5 Pictures of Test Arrangements.....	55
Appendix – Information on the Testing Laboratories	56

Release Control Record

Issue No.	Description	Date Issued
RF170428C35	Original Release	Jun. 09, 2017

1 Certificate of Conformity

Product: Industrial Tablet

Brand: Getac

Test Model: F110

Sample Status: Production Unit

Applicant: Getac Technology Corporation.

Test Date: May 16, 2017 ~ May 19, 2017

Standards: 47 CFR FCC Part 15, Subpart C (Section 15.247)
ANSI C63.10:2013

The above equipment has been tested by **Bureau Veritas Consumer Products Services (H.K.) Ltd., Taoyuan Branch**, and found compliance with the requirement of the above standards. The test record, data evaluation & Equipment Under Test (EUT) configurations represented herein are true and accurate accounts of the measurements of the sample's EMC characteristics under the conditions specified in this report.

Prepared by : Evonne Liu , **Date:** Jun. 09, 2017
Evonne Liu / Specialist

Approved by : David Huang , **Date:** Jun. 09, 2017
David Huang / Project Engineer

2 Summary of Test Results

47 CFR FCC Part 15, Subpart C (Section 15.247)			
FCC Clause	Test Item	Result	Remarks
15.207	AC Power Conducted Emission	Pass	Meet the requirement of limit. Minimum passing margin is -16.42 dB at 0.16172 MHz.
15.205 / 15.209 / 15.247(d)	Radiated Emissions and Band Edge Measurement	Pass	Meet the requirement of limit. Minimum passing margin is -5.35 dB at 2483.6 MHz.
15.247(d)	Antenna Port Emission	Pass	Meet the requirement of limit.
15.247(a)(2)	6 dB Bandwidth	Pass	Meet the requirement of limit.
15.247(b)	Conducted power	Pass	Meet the requirement of limit.
15.247(e)	Power Spectral Density	Pass	Meet the requirement of limit.
15.203	Antenna Requirement	Pass	No antenna connector is used.

2.1 Measurement Uncertainty

Where relevant, the following measurement uncertainty levels have been estimated for tests performed on the EUT:

The listed uncertainties are the worst case uncertainty for the entire range of measurement. Please note that the uncertainty values are provided for informational purposes only and are not used in determining the PASS/FAIL results.

Measurement	Frequency	Expanded Uncertainty (k=2) (\pm)
Conducted Emissions at mains ports	150 kHz ~ 30 MHz	2.44 dB
Radiated Emissions up to 1 GHz	30 MHz ~ 200 MHz	2.93 dB
	200 MHz ~ 1000 MHz	2.95 dB
Radiated Emissions above 1 GHz	1 GHz ~ 18 GHz	2.26 dB
	18 GHz ~ 40 GHz	1.94 dB

2.2 Modification Record

There were no modifications required for compliance.

3 General Information

3.1 General Description of EUT

Product	Industrial Tablet
Brand	Getac
Test Model	F110
Status of EUT	Production Unit
Power Supply Rating	19 Vdc (Adapter)
Modulation Type	CCK, DQPSK, DBPSK for DSSS 64QAM, 16QAM, QPSK, BPSK for OFDM
Modulation Technology	DSSS, OFDM
Transfer Rate	802.11b: 11.0 / 5.5 / 2.0 / 1.0 Mbps 802.11g: 54.0 / 48.0 / 36.0 / 24.0 / 18.0 / 12.0 / 9.0 / 6.0 Mbps 802.11n: up to MCS15
Operating Frequency	2412 ~ 2462 MHz
Number of Channel	11 for 802.11b, 802.11g, 802.11n (HT20) 7 for 802.11n (HT40)
Output Power	279.254 mW
Antenna Type	PIFA antenna with Main: 4.53 dBi / Aux.: 4.44 dBi gain
Antenna Connector	N/A
Accessory Device	Refer to Note as below
Data Cable Supplied	Refer to Note as below

Note:

- The EUT incorporates a MIMO function. Physically, the EUT provides two completed transmitters and two receivers.

Modulation Mode	TX Function
802.11b	1TX
802.11g	1TX
802.11n (HT20)	1TX, 2TX
802.11n (HT40)	1TX, 2TX

- The EUT contains following accessory devices.

Product	Brand	Model	Description
Adapter 1	Chicony	A12-065N2A	I/P: 100-240Vac, 50/60Hz, 1.7A O/P: 19Vdc, 3.42A 1.45 m shielded cable with core
Adapter 2	DELTA ELECTRONICS, INC	SADP-65KB B	I/P: 100-240Vac, 50/60Hz, 1.5A O/P: 19Vdc, 3.42A 1.8 m shielded cable with core

- The above EUT information is declared by manufacturer and for more detailed features description, please refer to the manufacturer's specifications or user's manual.

3.2 Description of Test Modes

11 channels are provided for 802.11b, 802.11g and 802.11n (HT20):

Channel	Frequency (MHz)	Channel	Frequency (MHz)
1	2412	7	2442
2	2417	8	2447
3	2422	9	2452
4	2427	10	2457
5	2432	11	2462
6	2437		

7 channels are provided for 802.11n (HT40):

Channel	Frequency (MHz)	Channel	Frequency (MHz)
3	2422	7	2442
4	2427	8	2447
5	2432	9	2452
6	2437		

3.2.1 Test Mode Applicability and Tested Channel Detail

EUT Configure Mode	Applicable To				Description
	RE \geq 1G	RE<1G	PLC	APCM	
A	√	√	√	√	SISO
B	√	√	-	√	MIMO

Where **RE \geq 1G**: Radiated Emission above 1 GHz **RE<1G**: Radiated Emission below 1 GHz
PLC: Power Line Conducted Emission **APCM**: Antenna Port Conducted Measurement

NOTE: The EUT had been pre-tested on the positioned of each 3 axis. The worst case was found when positioned on **Y-plane**.
NOTE: "-" means no effect.

Radiated Emission Test (Above 1 GHz):

- Pre-Scan has been conducted to determine the worst-case mode from all possible combinations between available modulations, data rates and antenna ports (if EUT with antenna diversity architecture).
- Following channel(s) was (were) selected for the final test as listed below.

EUT Configure Mode	Mode	Available Channel	Tested Channel	Modulation Technology	Modulation Type	Data Rate (Mbps)
A	802.11b	1 to 11	1, 6, 11	DSSS	DBPSK	1.0
	802.11g	1 to 11	1, 6, 11	OFDM	BPSK	6.0
B	802.11n (HT20)	1 to 11	1, 6, 11	OFDM	BPSK	MCS0
	802.11n (HT40)	3 to 9	3, 6, 9	OFDM	BPSK	MCS0

Radiated Emission Test (Below 1 GHz):

- Pre-Scan has been conducted to determine the worst-case mode from all possible combinations between available modulations, data rates and antenna ports (if EUT with antenna diversity architecture).
- Following channel(s) was (were) selected for the final test as listed below.

EUT Configure Mode	Mode	Available Channel	Tested Channel	Modulation Technology	Modulation Type	Data Rate (Mbps)
A	802.11n (HT40)	3 to 9	9	OFDM	BPSK	MCS0

Power Line Conducted Emission Test:

- Pre-Scan has been conducted to determine the worst-case mode from all possible combinations between available modulations, data rates and antenna ports (if EUT with antenna diversity architecture).
- Following channel(s) was (were) selected for the final test as listed below.

EUT Configure Mode	Mode	Available Channel	Tested Channel	Modulation Technology	Modulation Type	Data Rate (Mbps)
A	802.11n (HT40)	3 to 9	9	OFDM	BPSK	6.0

Bandedge Measurement:

- Pre-Scan has been conducted to determine the worst-case mode from all possible combinations between available modulations, data rates and antenna ports (if EUT with antenna diversity architecture).
- Following channel(s) was (were) selected for the final test as listed below.

EUT Configure Mode	Mode	Available Channel	Tested Channel	Modulation Technology	Modulation Type	Data Rate (Mbps)
A	802.11b	1 to 11	1, 11	DSSS	DBPSK	1.0
	802.11g	1 to 11	1, 11	OFDM	BPSK	6.0
B	802.11n (HT20)	1 to 11	1, 11	OFDM	BPSK	MCS0
	802.11n (HT40)	3 to 9	3, 9	OFDM	BPSK	MCS0

Antenna Port Conducted Measurement:

- This item includes all test value of each mode, but only includes spectrum plot of worst value of each mode.
- Pre-Scan has been conducted to determine the worst-case mode from all possible combinations between available modulations, data rates and antenna ports (if EUT with antenna diversity architecture).
- Following channel(s) was (were) selected for the final test as listed below.

EUT Configure Mode	Mode	Available Channel	Tested Channel	Modulation Technology	Modulation Type	Data Rate (Mbps)
A	802.11b	1 to 11	1, 6, 11	DSSS	DBPSK	1.0
	802.11g	1 to 11	1, 6, 11	OFDM	BPSK	6.0
B	802.11n (HT20)	1 to 11	1, 6, 11	OFDM	BPSK	MCS0
	802.11n (HT40)	3 to 9	3, 6, 9	OFDM	BPSK	MCS0

Test Condition:

Applicable To	Environmental Conditions	Input Power	Tested by
RE \geq 1G	25 deg. C, 65 % RH	120 Vac, 60 Hz	Toby Tian
RE<1G	25 deg. C, 65 % RH	120 Vac, 60 Hz	Toby Tian
PLC	25 deg. C, 65 % RH	120 Vac, 60 Hz	Getaz Yang
APCM	25 deg. C, 65 % RH	11.1 Vdc	Carlos Chen

3.3 Duty Cycle of Test Signal

Mode A

802.11b: Duty cycle of test signal is 100 %, duty factor is not required.

802.11g: Duty cycle = $2.052/2.164 = 0.948$, Duty factor = $10 * \log(1/0.948) = 0.23$

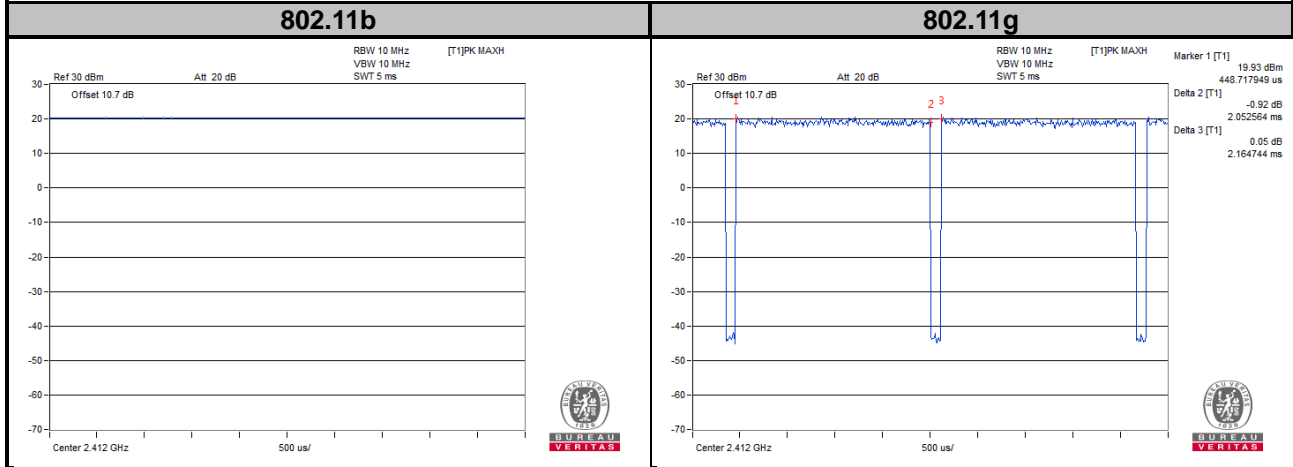

Mode B

802.11n (HT20): Duty cycle = $0.977/1.161 = 0.841$, Duty factor = $10 * \log(1/0.841) = 0.75$

802.11n (HT40): Duty cycle = $0.484/0.581 = 0.835$, Duty factor = $10 * \log(1/0.835) = 0.79$

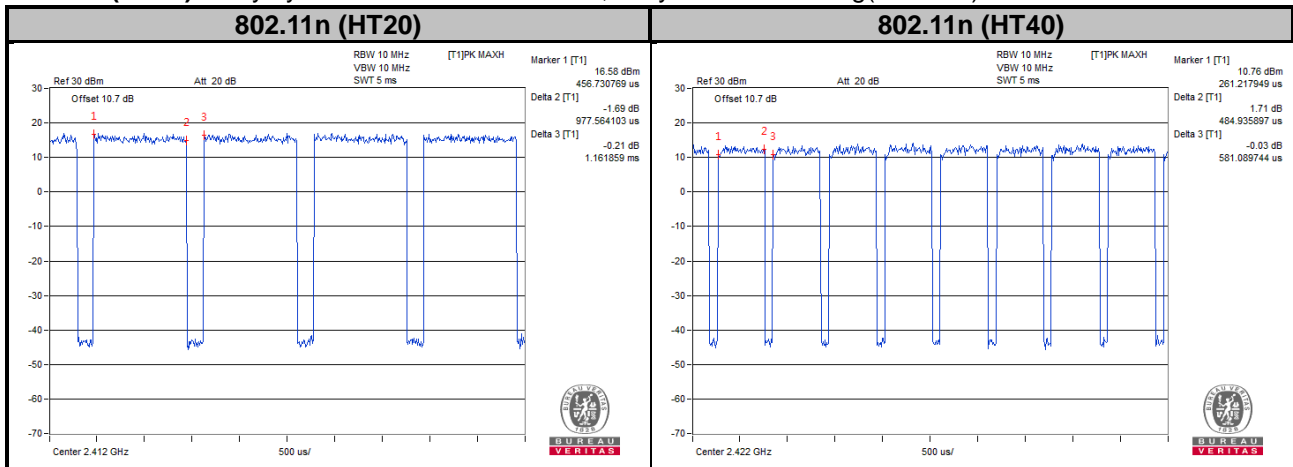

3.4 Description of Support Units

The EUT has been tested as an independent unit together with other necessary accessories or support units.

3.4.1 Configuration of System under Test

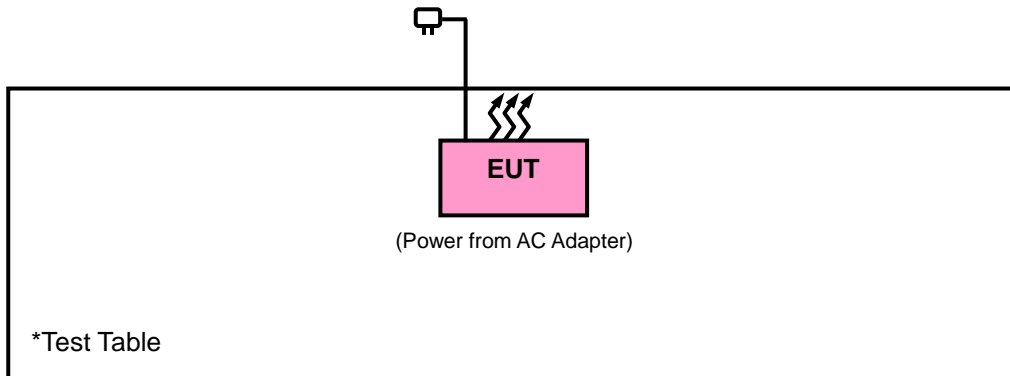

3.5 General Description of Applied Standards

The EUT is a RF Product. According to the specifications of the manufacturer, it must comply with the requirements of the following standards:

FCC Part 15, Subpart C (15.247)

558074 D01 DTS Meas Guidance v04

662911 D01 Multiple Transmitter Output v02r01

ANSI C63.10-2013

All test items have been performed and recorded as per the above standards.

NOTE: The EUT has been verified to comply with the requirements of FCC Part 15, Subpart B, Class B (DoC).
The test report has been issued separately.

4 Test Types and Results

4.1 Radiated Emission and Bandedge Measurement

4.1.1 Limits of Radiated Emission and Bandedge Measurement

Radiated emissions which fall in the restricted bands must comply with the radiated emission limits specified as below table. Other emissions shall be at least 20 dB below the highest level of the desired power:

Frequencies (MHz)	Field Strength (microvolts/meter)	Measurement Distance (meters)
0.009 ~ 0.490	2400/F (kHz)	300
0.490 ~ 1.705	24000/F (kHz)	30
1.705 ~ 30.0	30	30
30 ~ 88	100	3
88 ~ 216	150	3
216 ~ 960	200	3
Above 960	500	3

NOTE:

1. The lower limit shall apply at the transition frequencies.
2. Emission level (dBuV/m) = 20 log Emission level (uV/m).
3. For frequencies above 1000 MHz, the field strength limits are based on average detector, however, the peak field strength of any emission shall not exceed the maximum permitted average limits, specified above by more than 20 dB under any condition of modulation.

4.1.2 Test Instruments

Description & Manufacturer	Model No.	Serial No.	Date of Calibration	Due Date of Calibration
Test Receiver Agilent	N9038A	MY51210203	Feb. 17, 2017	Feb. 16, 2018
Spectrum Analyzer Agilent	N9010A	MY52220314	Dec. 16, 2016	Dec. 15, 2017
Spectrum Analyzer ROHDE & SCHWARZ	FSU43	101261	Dec. 13, 2016	Dec. 12, 2017
BILOG Antenna SCHWARZBECK	VULB9168	9168-472	Dec. 26, 2016	Dec. 27, 2017
HORN Antenna SCHWARZBECK	BBHA 9120 D	9120D-969	Dec. 12, 2016	Dec. 13, 2017
HORN Antenna SCHWARZBECK	BBHA 9170	9170-480	Dec. 14, 2016	Dec. 13, 2017
Fixed Attenuator Mini-Circuits	BW-N10W5+	NA	Jul. 08, 2016	Jul. 07, 2017
Loop Antenna	EM-6879	269	Aug. 11, 2016	Aug. 10, 2017
Preamplifier EMCI	EMC 012645	980115	Oct. 21, 2016	Oct. 20, 2017
Preamplifier EMCI	EMC 184045	980116	Oct. 21, 2016	Oct. 20, 2017
Preamplifier EMCI	EMC 330H	980112	Oct. 21, 2016	Oct. 20, 2017
Power Meter Anritsu	ML2495A	1232002	Sep. 08, 2016	Sep. 07, 2017
Power Sensor Anritsu	MA2411B	1207325	Sep. 08, 2016	Sep. 07, 2017
RF signal cable HUBER+SUHNNER	SUCOFLEX 104	309219/4 2950114	Oct. 21, 2016	Oct. 20, 2017
RF signal cable HUBER+SUHNNER	SUCOFLEX 104	250130/4	Oct. 21, 2016	Oct. 20, 2017
RF Coaxial Cable Worken	8D-FB	Cable-Ch10-01	Oct. 21, 2016	Oct. 20, 2017
Software BV ADT	E3 6.120103	NA	NA	NA
Antenna Tower MF	MFA-440H	NA	NA	NA
Turn Table MF	MFT-201SS	NA	NA	NA
Antenna Tower & Turn Table Controller MF	MF-7802	NA	NA	NA

- Note: 1. The calibration interval of the above test instruments is 12 months and the calibrations are traceable to NML/ROC and NIST/USA.
2. The test was performed in HwaYa Chamber 10.
3. The horn antenna and preamplifier (model: EMC 184045) are used only for the measurement of emission frequency above 1 GHz if tested.
4. The FCC Site Registration No. is 690701.
5. The IC Site Registration No. is IC7450F-10.

4.1.3 Test Procedures

- a. The EUT was placed on the top of a rotating table 0.8 meters (for below 1 GHz) / 1.5 meters (for above 1 GHz) above the ground at 3 meter chamber room for test. The table was rotated 360 degrees to determine the position of the highest radiation.
- b. The EUT was set 3 meters away from the interference-receiving antenna, which was mounted on the top of a variable-height antenna tower.
- c. The height of antenna is varied from one meter to four meters above the ground to determine the maximum value of the field strength. Both horizontal and vertical polarizations of the antenna are set to make the measurement.
- d. For each suspected emission, the EUT was arranged to its worst case and then the antenna was tuned to heights from 1 meter to 4 meters and the rotatable table was turned from 0 degrees to 360 degrees to find the maximum reading.
- e. The test-receiver system was set to quasi-peak detect function and specified bandwidth with maximum hold mode when the test frequency is below 1 GHz.
- f. The test-receiver system was set to peak and average detected function and specified bandwidth with maximum hold mode when the test frequency is above 1 GHz. If the peak reading value also meets average limit, measurement with the average detector is unnecessary.

Note:

1. The resolution bandwidth and video bandwidth of test receiver/spectrum analyzer is 120 kHz & 360 KHz for Quasi-peak detection (QP) at frequency below 1 GHz.
2. The resolution bandwidth of test receiver/spectrum analyzer is 1 MHz and the video bandwidth is 3 MHz for Peak detection (PK) at frequency above 1 GHz.
3. The resolution bandwidth of test receiver/spectrum analyzer is 1 MHz and the video bandwidth is 1/T for RMS Average (Duty cycle < 98 %) for Peak detection at frequency above 1 GHz.
4. The resolution bandwidth of test receiver/spectrum analyzer is 1 MHz and the video bandwidth is 10 Hz (Duty cycle \geq 98 %) for Average detection (AV) at frequency above 1 GHz.
5. All modes of operation were investigated and the worst-case emissions are reported.

4.1.4 Deviation from Test Standard

No deviation.

4.1.5 Test Set Up

<Frequency Range below 1 GHz>

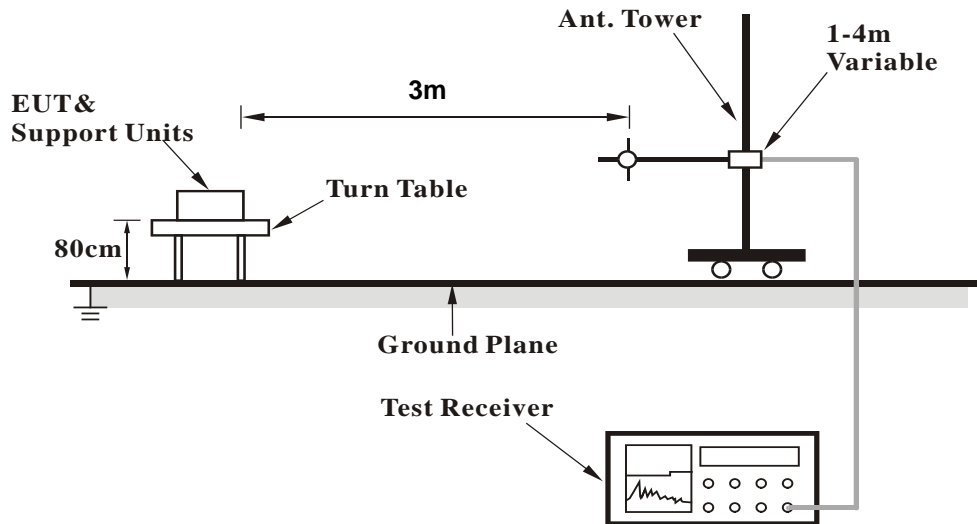

<Frequency Range above 1 GHz>

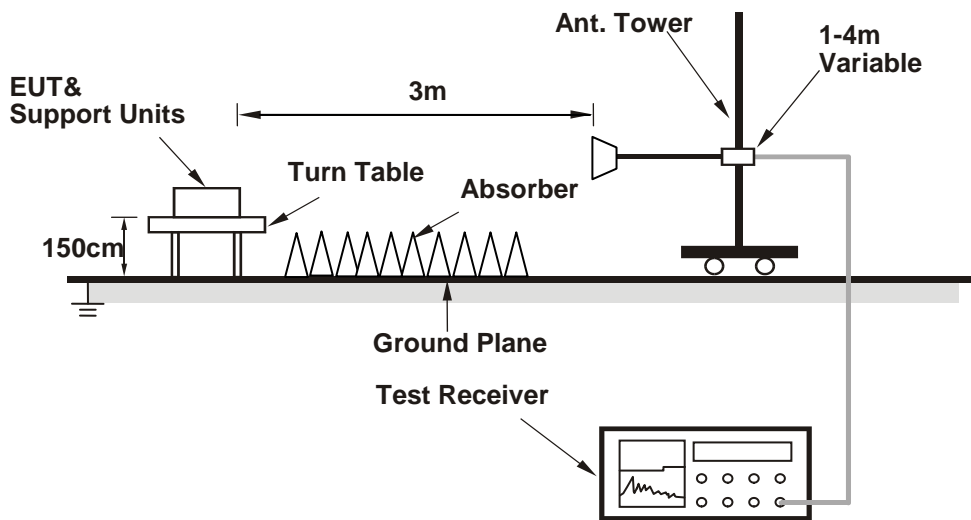

For the actual test configuration, please refer to the attached file (Test Setup Photo).

4.1.6 EUT Operating Conditions

- Placed the EUT on a testing table.
- Use the software to control the EUT under transmission condition continuously at specific channel frequency.

4.1.7 Test Results

Above 1 GHz Data :

Mode A

802.11b

EUT Test Condition		Measurement Detail	
Channel	Channel 1	Frequency Range	1 GHz ~ 25 GHz
Input Power	120 Vac, 60 Hz	Detector Function	Peak (PK) Average (AV)
Environmental Conditions	25 deg. C, 65 % RH	Tested By	Toby Tian

Antennal Polarity & Test Distance: Horizontal at 3 m										
Frequency (MHz)	Emission Level (dBuV/m)	Read Level (dBuV)	Limit (dBuV/m)	Margin (dB)	Antenna Factor (dB/m)	Cable Loss (dB)	Preamp Factor (dB)	Antenna Height (cm)	Table Angle (Degree)	Remark
2388.3	42.65	49.16	54	-11.35	26.91	4.08	37.5	105	125	Average
2388.48	50.61	57.12	74	-23.39	26.91	4.08	37.5	105	125	Peak
2412	99.69	106.16			26.96	4.09	37.52	105	125	Average
2412	105.1	111.57			26.96	4.09	37.52	105	125	Peak
4824	41.11	56.41	54	-12.89	30.99	6.79	53.08	168	301	Average
4824	48.32	63.62	74	-25.68	30.99	6.79	53.08	168	301	Peak
Antennal Polarity & Test Distance: Vertical at 3 m										
Frequency (MHz)	Emission Level (dBuV/m)	Read Level (dBuV)	Limit (dBuV/m)	Margin (dB)	Antenna Factor (dB/m)	Cable Loss (dB)	Preamp Factor (dB)	Antenna Height (cm)	Table Angle (Degree)	Remark
2389.92	37.67	44.2	54	-16.33	26.91	4.08	37.52	202	51	Average
2389.92	48.41	54.94	74	-25.59	26.91	4.08	37.52	202	51	Peak
2412	96.08	102.55			26.96	4.09	37.52	202	51	Average
2412	100.83	107.3			26.96	4.09	37.52	202	51	Peak
4824	37.38	52.68	54	-16.62	30.99	6.79	53.08	142	192	Average
4824	46.14	61.44	74	-27.86	30.99	6.79	53.08	142	192	Peak

Remarks:

- Emission Level = Read Level + Antenna Factor + Cable Loss - Preamp Factor
Margin value = Emission level – Limit value
- 2412 MHz: Fundamental frequency.

EUT Test Condition		Measurement Detail	
Channel	Channel 6	Frequency Range	1 GHz ~ 25 GHz
Input Power	120 Vac, 60 Hz	Detector Function	Peak (PK) Average (AV)
Environmental Conditions	25 deg. C, 65 % RH	Tested By	Toby Tian

Antennal Polarity & Test Distance: Horizontal at 3 m										
Frequency (MHz)	Emission Level (dBuV/m)	Read Level (dBuV)	Limit (dBuV/m)	Margin (dB)	Antenna Factor (dB/m)	Cable Loss (dB)	Preamp Factor (dB)	Antenna Height (cm)	Table Angle (Degree)	Remark
2369.76	47.87	54.44	74	-26.13	26.86	4.07	37.5	104	126	Peak
2379.84	36.56	43.12	54	-17.44	26.86	4.08	37.5	104	126	Average
2437	100.16	106.44			27.06	4.12	37.46	104	126	Average
2437	105.14	111.42			27.06	4.12	37.46	104	126	Peak
2495.52	41.17	47.06	54	-12.83	27.2	4.16	37.25	104	126	Average
2495.72	51.31	57.2	74	-22.69	27.2	4.16	37.25	104	126	Peak
4874	41.04	56.18	54	-12.96	31.06	6.85	53.05	166	308	Average
4874	48.2	63.34	74	-25.8	31.06	6.85	53.05	166	308	Peak
Antennal Polarity & Test Distance: Vertical at 3 m										
Frequency (MHz)	Emission Level (dBuV/m)	Read Level (dBuV)	Limit (dBuV/m)	Margin (dB)	Antenna Factor (dB/m)	Cable Loss (dB)	Preamp Factor (dB)	Antenna Height (cm)	Table Angle (Degree)	Remark
2362.65	35.71	42.32	54	-18.29	26.81	4.07	37.49	203	52	Average
2386.5	47.58	54.09	74	-26.42	26.91	4.08	37.5	203	52	Peak
2437	96.56	102.84			27.06	4.12	37.46	203	52	Average
2437	101.07	107.35			27.06	4.12	37.46	203	52	Peak
2486	50.47	56.49	74	-23.53	27.15	4.15	37.32	203	52	Peak
2491.36	39.28	45.24	54	-14.72	27.2	4.16	37.32	203	52	Average
4874	38.28	53.42	54	-15.72	31.06	6.85	53.05	139	208	Average
4874	47.56	62.7	74	-26.44	31.06	6.85	53.05	139	208	Peak

Remarks:

- Emission Level = Read Level + Antenna Factor + Cable Loss - Preamp Factor
Margin value = Emission level – Limit value
- 2437 MHz: Fundamental frequency.

EUT Test Condition		Measurement Detail	
Channel	Channel 11	Frequency Range	1 GHz ~ 25 GHz
Input Power	120 Vac, 60 Hz	Detector Function	Peak (PK) Average (AV)
Environmental Conditions	25 deg. C, 65 % RH	Tested By	Toby Tian

Antennal Polarity & Test Distance: Horizontal at 3 m										
Frequency (MHz)	Emission Level (dBuV/m)	Read Level (dBuV)	Limit (dBuV/m)	Margin (dB)	Antenna Factor (dB/m)	Cable Loss (dB)	Preamp Factor (dB)	Antenna Height (cm)	Table Angle (Degree)	Remark
2462	100.46	106.62			27.1	4.13	37.39	105	123	Average
2462	105.19	111.35			27.1	4.13	37.39	105	123	Peak
2488.88	47.71	53.67	54	-6.29	27.2	4.16	37.32	105	123	Average
2489	54.85	60.81	74	-19.15	27.2	4.16	37.32	105	123	Peak
4924	40.37	55.4	54	-13.63	31.12	6.88	53.03	172	311	Average
4924	45.69	60.72	74	-28.31	31.12	6.88	53.03	172	311	Peak
Antennal Polarity & Test Distance: Vertical at 3 m										
Frequency (MHz)	Emission Level (dBuV/m)	Read Level (dBuV)	Limit (dBuV/m)	Margin (dB)	Antenna Factor (dB/m)	Cable Loss (dB)	Preamp Factor (dB)	Antenna Height (cm)	Table Angle (Degree)	Remark
2462	96.55	102.71			27.1	4.13	37.39	202	54	Average
2462	101.26	107.42			27.1	4.13	37.39	202	54	Peak
2487.84	54.23	60.19	74	-19.77	27.2	4.16	37.32	202	54	Peak
2488.72	46.93	52.89	54	-7.07	27.2	4.16	37.32	202	54	Average
4924	36.54	51.57	54	-17.46	31.12	6.88	53.03	133	199	Average
4924	45.26	60.29	74	-28.74	31.12	6.88	53.03	133	199	Peak

Remarks:

- Emission Level = Read Level + Antenna Factor + Cable Loss - Preamp Factor
Margin value = Emission level – Limit value
- 2462 MHz: Fundamental frequency.

802.11g

EUT Test Condition		Measurement Detail	
Channel	Channel 1	Frequency Range	1 GHz ~ 25 GHz
Input Power	120 Vac, 60 Hz	Detector Function	Peak (PK) Average (AV)
Environmental Conditions	25 deg. C, 65 % RH	Tested By	Toby Tian

Antennal Polarity & Test Distance: Horizontal at 3 m

Frequency (MHz)	Emission Level (dBuV/m)	Read Level (dBuV)	Limit (dBuV/m)	Margin (dB)	Antenna Factor (dB/m)	Cable Loss (dB)	Preamp Factor (dB)	Antenna Height (cm)	Table Angle (Degree)	Remark
2368.68	67.39	73.96	74	-6.61	26.86	4.07	37.5	104	129	Peak
2389.92	40.96	47.49	54	-13.04	26.91	4.08	37.52	104	129	Average
2412	97.08	103.55			26.96	4.09	37.52	104	129	Average
2412	106.81	113.28			26.96	4.09	37.52	104	129	Peak
4824	34.19	49.49	54	-19.81	30.99	6.79	53.08	164	312	Average
4824	46.14	61.44	74	-27.86	30.99	6.79	53.08	164	312	Peak

Antennal Polarity & Test Distance: Vertical at 3 m

Frequency (MHz)	Emission Level (dBuV/m)	Read Level (dBuV)	Limit (dBuV/m)	Margin (dB)	Antenna Factor (dB/m)	Cable Loss (dB)	Preamp Factor (dB)	Antenna Height (cm)	Table Angle (Degree)	Remark
2365.08	64.79	71.41	74	-9.21	26.81	4.07	37.5	203	49	Peak
2389.92	39.71	46.24	54	-14.29	26.91	4.08	37.52	203	49	Average
2412	92.88	99.35			26.96	4.09	37.52	203	49	Average
2412	102.31	108.78			26.96	4.09	37.52	203	49	Peak
4824	33.06	48.36	54	-20.94	30.99	6.79	53.08	142	202	Average
4824	45.41	60.71	74	-28.59	30.99	6.79	53.08	142	202	Peak

Remarks:

- Emission Level = Read Level + Antenna Factor + Cable Loss - Preamp Factor
Margin value = Emission level – Limit value
- 2412 MHz: Fundamental frequency.

EUT Test Condition		Measurement Detail	
Channel	Channel 6	Frequency Range	1 GHz ~ 25 GHz
Input Power	120 Vac, 60 Hz	Detector Function	Peak (PK) Average (AV)
Environmental Conditions	25 deg. C, 65 % RH	Tested By	Toby Tian

Antennal Polarity & Test Distance: Horizontal at 3 m										
Frequency (MHz)	Emission Level (dBuV/m)	Read Level (dBuV)	Limit (dBuV/m)	Margin (dB)	Antenna Factor (dB/m)	Cable Loss (dB)	Preamp Factor (dB)	Antenna Height (cm)	Table Angle (Degree)	Remark
2361.12	63.26	69.89	74	-10.74	26.81	4.05	37.49	102	127	Peak
2389.92	35.99	42.52	54	-18.01	26.91	4.08	37.52	102	127	Average
2437	97.16	103.44			27.06	4.12	37.46	102	127	Average
2437	106.85	113.13			27.06	4.12	37.46	102	127	Peak
2483.56	41.89	47.91	54	-12.11	27.15	4.15	37.32	102	127	Average
2486.32	63.1	69.12	74	-10.9	27.15	4.15	37.32	102	127	Peak
4874	34.1	49.24	54	-19.9	31.06	6.85	53.05	178	305	Average
4874	46.25	61.39	74	-27.75	31.06	6.85	53.05	178	305	Peak

Antennal Polarity & Test Distance: Vertical at 3 m										
Frequency (MHz)	Emission Level (dBuV/m)	Read Level (dBuV)	Limit (dBuV/m)	Margin (dB)	Antenna Factor (dB/m)	Cable Loss (dB)	Preamp Factor (dB)	Antenna Height (cm)	Table Angle (Degree)	Remark
2382.81	62.32	68.88	74	-11.68	26.86	4.08	37.5	204	48	Peak
2388.21	35.28	41.79	54	-18.72	26.91	4.08	37.5	204	48	Average
2437	92.82	99.1			27.06	4.12	37.46	204	48	Average
2437	102.34	108.62			27.06	4.12	37.46	204	48	Peak
2484.76	57.43	63.45	74	-16.57	27.15	4.15	37.32	204	48	Peak
2488.44	38.55	44.51	54	-15.45	27.2	4.16	37.32	204	48	Average
4874	33.38	48.52	54	-20.62	31.06	6.85	53.05	138	206	Average
4874	45.82	60.96	74	-28.18	31.06	6.85	53.05	138	206	Peak

Remarks:

- Emission Level = Read Level + Antenna Factor + Cable Loss - Preamp Factor
Margin value = Emission level – Limit value
- 2437 MHz: Fundamental frequency.

EUT Test Condition		Measurement Detail	
Channel	Channel 11	Frequency Range	1 GHz ~ 25 GHz
Input Power	120 Vac, 60 Hz	Detector Function	Peak (PK) Average (AV)
Environmental Conditions	25 deg. C, 65 % RH	Tested By	Toby Tian

Antennal Polarity & Test Distance: Horizontal at 3 m										
Frequency (MHz)	Emission Level (dBuV/m)	Read Level (dBuV)	Limit (dBuV/m)	Margin (dB)	Antenna Factor (dB/m)	Cable Loss (dB)	Preamp Factor (dB)	Antenna Height (cm)	Table Angle (Degree)	Remark
2462	97.2	103.36			27.1	4.13	37.39	102	130	Average
2462	106.9	113.06			27.1	4.13	37.39	102	130	Peak
2483.52	47.73	53.75	54	-6.27	27.15	4.15	37.32	102	130	Average
2484.8	67.87	73.89	74	-6.13	27.15	4.15	37.32	102	130	Peak
4924	33.97	49	54	-20.03	31.12	6.88	53.03	162	316	Average
4924	46.36	61.39	74	-27.64	31.12	6.88	53.03	162	316	Peak
Antennal Polarity & Test Distance: Vertical at 3 m										
Frequency (MHz)	Emission Level (dBuV/m)	Read Level (dBuV)	Limit (dBuV/m)	Margin (dB)	Antenna Factor (dB/m)	Cable Loss (dB)	Preamp Factor (dB)	Antenna Height (cm)	Table Angle (Degree)	Remark
2462	93	99.16			27.1	4.13	37.39	202	50	Average
2462	102.59	108.75			27.1	4.13	37.39	202	50	Peak
2483.52	43.37	49.39	54	-10.63	27.15	4.15	37.32	202	50	Average
2486.2	63.21	69.23	74	-10.79	27.15	4.15	37.32	202	50	Peak
4924	33.08	48.11	54	-20.92	31.12	6.88	53.03	147	211	Average
4924	44.95	59.98	74	-29.05	31.12	6.88	53.03	147	211	Peak

Remarks:

- Emission Level = Read Level + Antenna Factor + Cable Loss - Preamp Factor
Margin value = Emission level – Limit value
- 2462 MHz: Fundamental frequency.

Mode B

802.11n (HT20)

EUT Test Condition		Measurement Detail	
Channel	Channel 1	Frequency Range	1 GHz ~ 25 GHz
Input Power	120 Vac, 60 Hz	Detector Function	Peak (PK) Average (AV)
Environmental Conditions	25 deg. C, 65 % RH	Tested By	Toby Tian

Antennal Polarity & Test Distance: Horizontal at 3 m										
Frequency (MHz)	Emission Level (dBuV/m)	Read Level (dBuV)	Limit (dBuV/m)	Margin (dB)	Antenna Factor (dB/m)	Cable Loss (dB)	Preamp Factor (dB)	Antenna Height (cm)	Table Angle (Degree)	Remark
2371.29	67.62	74.19	74	-6.38	26.86	4.07	37.5	133	120	Peak
2389.92	39.79	46.32	54	-14.21	26.91	4.08	37.52	133	120	Average
2412	93.02	99.49			26.96	4.09	37.52	133	120	Average
2412	101.47	107.94			26.96	4.09	37.52	133	120	Peak
4824	33.04	48.34	54	-20.96	30.99	6.79	53.08	172	322	Average
4824	45.48	60.78	74	-28.52	30.99	6.79	53.08	172	322	Peak

Antennal Polarity & Test Distance: Vertical at 3 m										
Frequency (MHz)	Emission Level (dBuV/m)	Read Level (dBuV)	Limit (dBuV/m)	Margin (dB)	Antenna Factor (dB/m)	Cable Loss (dB)	Preamp Factor (dB)	Antenna Height (cm)	Table Angle (Degree)	Remark
2373.99	65.91	72.48	74	-8.09	26.86	4.07	37.5	201	90	Peak
2389.92	37.88	44.41	54	-16.12	26.91	4.08	37.52	201	90	Average
2412	89.34	95.81			26.96	4.09	37.52	201	90	Average
2412	98.68	105.15			26.96	4.09	37.52	201	90	Peak
4824	32.79	48.09	54	-21.21	30.99	6.79	53.08	158	184	Average
4824	45.05	60.35	74	-28.95	30.99	6.79	53.08	158	184	Peak

Remarks:

- Emission Level = Read Level + Antenna Factor + Cable Loss - Preamp Factor
Margin value = Emission level – Limit value
- 2412 MHz: Fundamental frequency.

EUT Test Condition		Measurement Detail	
Channel	Channel 6	Frequency Range	1 GHz ~ 25 GHz
Input Power	120 Vac, 60 Hz	Detector Function	Peak (PK) Average (AV)
Environmental Conditions	25 deg. C, 65 % RH	Tested By	Toby Tian

Antennal Polarity & Test Distance: Horizontal at 3 m										
Frequency (MHz)	Emission Level (dBuV/m)	Read Level (dBuV)	Limit (dBuV/m)	Margin (dB)	Antenna Factor (dB/m)	Cable Loss (dB)	Preamp Factor (dB)	Antenna Height (cm)	Table Angle (Degree)	Remark
2387.67	35.02	41.53	54	-18.98	26.91	4.08	37.5	132	124	Average
2389.56	65.39	71.9	74	-8.61	26.91	4.08	37.5	132	124	Peak
2437	92.16	98.44			27.06	4.12	37.46	132	124	Average
2437	101.44	107.72			27.06	4.12	37.46	132	124	Peak
2487.12	37.98	44	54	-16.02	27.15	4.15	37.32	132	124	Average
2491.12	61.85	67.81	74	-12.15	27.2	4.16	37.32	132	124	Peak
4874	33.08	48.22	54	-20.92	31.06	6.85	53.05	179	329	Average
4874	44.68	59.82	74	-29.32	31.06	6.85	53.05	179	329	Peak

Antennal Polarity & Test Distance: Vertical at 3 m										
Frequency (MHz)	Emission Level (dBuV/m)	Read Level (dBuV)	Limit (dBuV/m)	Margin (dB)	Antenna Factor (dB/m)	Cable Loss (dB)	Preamp Factor (dB)	Antenna Height (cm)	Table Angle (Degree)	Remark
2364.36	34.39	41.01	54	-19.61	26.81	4.07	37.5	202	88	Average
2387.13	62.08	68.59	74	-11.92	26.91	4.08	37.5	202	88	Peak
2437	89.34	95.62			27.06	4.12	37.46	202	88	Average
2437	98.7	104.98			27.06	4.12	37.46	202	88	Peak
2484.04	56.34	62.36	74	-17.66	27.15	4.15	37.32	202	88	Peak
2484.84	36.91	42.93	54	-17.09	27.15	4.15	37.32	202	88	Average
4874	32.87	48.01	54	-21.13	31.06	6.85	53.05	152	182	Average
4874	44.36	59.5	74	-29.64	31.06	6.85	53.05	152	182	Peak

Remarks:

- Emission Level = Read Level + Antenna Factor + Cable Loss - Preamp Factor
Margin value = Emission level – Limit value
- 2437 MHz: Fundamental frequency.

EUT Test Condition		Measurement Detail	
Channel	Channel 11	Frequency Range	1 GHz ~ 25 GHz
Input Power	120 Vac, 60 Hz	Detector Function	Peak (PK) Average (AV)
Environmental Conditions	25 deg. C, 65 % RH	Tested By	Toby Tian

Antennal Polarity & Test Distance: Horizontal at 3 m										
Frequency (MHz)	Emission Level (dBuV/m)	Read Level (dBuV)	Limit (dBuV/m)	Margin (dB)	Antenna Factor (dB/m)	Cable Loss (dB)	Preamp Factor (dB)	Antenna Height (cm)	Table Angle (Degree)	Remark
2462	91.91	98.07			27.1	4.13	37.39	129	123	Average
2462	101.34	107.5			27.1	4.13	37.39	129	123	Peak
2483.52	42.02	48.04	54	-11.98	27.15	4.15	37.32	129	123	Average
2487.44	65.4	71.41	74	-8.6	27.15	4.16	37.32	129	123	Peak
4924	33.05	48.08	54	-20.95	31.12	6.88	53.03	174	330	Average
4924	42.99	58.02	74	-31.01	31.12	6.88	53.03	174	330	Peak
Antennal Polarity & Test Distance: Vertical at 3 m										
Frequency (MHz)	Emission Level (dBuV/m)	Read Level (dBuV)	Limit (dBuV/m)	Margin (dB)	Antenna Factor (dB/m)	Cable Loss (dB)	Preamp Factor (dB)	Antenna Height (cm)	Table Angle (Degree)	Remark
2462	89.22	95.38			27.1	4.13	37.39	202	86	Average
2462	98.54	104.7			27.1	4.13	37.39	202	86	Peak
2483.52	39.51	45.53	54	-14.49	27.15	4.15	37.32	202	86	Average
2497.04	60.55	66.44	74	-13.45	27.2	4.16	37.25	202	86	Peak
4924	32.94	47.97	54	-21.06	31.12	6.88	53.03	144	179	Average
4924	43.31	58.34	74	-30.69	31.12	6.88	53.03	144	179	Peak

Remarks:

- Emission Level = Read Level + Antenna Factor + Cable Loss - Preamp Factor
Margin value = Emission level – Limit value
- 2462 MHz: Fundamental frequency.

802.11n (HT40)

EUT Test Condition		Measurement Detail	
Channel	Channel 3	Frequency Range	1 GHz ~ 25 GHz
Input Power	120 Vac, 60 Hz	Detector Function	Peak (PK) Average (AV)
Environmental Conditions	25 deg. C, 65 % RH	Tested By	Toby Tian

Antennal Polarity & Test Distance: Horizontal at 3 m

Frequency (MHz)	Emission Level (dBuV/m)	Read Level (dBuV)	Limit (dBuV/m)	Margin (dB)	Antenna Factor (dB/m)	Cable Loss (dB)	Preamp Factor (dB)	Antenna Height (cm)	Table Angle (Degree)	Remark
2386.86	54.37	60.88	74	-19.63	26.91	4.08	37.5	131	122	Peak
2388.93	41.56	48.07	54	-12.44	26.91	4.08	37.5	131	122	Average
2422	89.82	96.16			27.01	4.11	37.46	131	122	Average
2422	99.13	105.47			27.01	4.11	37.46	131	122	Peak
2485.2	52.21	58.23	74	-21.79	27.15	4.15	37.32	131	122	Peak
2489.92	39.22	45.18	54	-14.78	27.2	4.16	37.32	131	122	Average
4844	32.78	48.01	54	-21.22	31.01	6.82	53.06	181	328	Average
4844	42.03	57.26	74	-31.97	31.01	6.82	53.06	181	328	Peak

Antennal Polarity & Test Distance: Vertical at 3 m

Frequency (MHz)	Emission Level (dBuV/m)	Read Level (dBuV)	Limit (dBuV/m)	Margin (dB)	Antenna Factor (dB/m)	Cable Loss (dB)	Preamp Factor (dB)	Antenna Height (cm)	Table Angle (Degree)	Remark
2389.83	53.39	59.92	74	-20.61	26.91	4.08	37.52	200	92	Peak
2389.92	41.16	47.69	54	-12.84	26.91	4.08	37.52	200	92	Average
2422	87.17	93.51			27.01	4.11	37.46	200	92	Average
2422	96.7	103.04			27.01	4.11	37.46	200	92	Peak
2484.76	38.23	44.25	54	-15.77	27.15	4.15	37.32	200	92	Average
2488.28	50.21	56.17	74	-23.79	27.2	4.16	37.32	200	92	Peak
4844	32.64	47.87	54	-21.36	31.01	6.82	53.06	149	188	Average
4844	42.63	57.86	74	-31.37	31.01	6.82	53.06	149	188	Peak

Remarks:

- Emission Level = Read Level + Antenna Factor + Cable Loss - Preamp Factor
Margin value = Emission level – Limit value
- 2422 MHz: Fundamental frequency.

EUT Test Condition		Measurement Detail	
Channel	Channel 6	Frequency Range	1 GHz ~ 25 GHz
Input Power	120 Vac, 60 Hz	Detector Function	Peak (PK) Average (AV)
Environmental Conditions	25 deg. C, 65 % RH	Tested By	Toby Tian

Antennal Polarity & Test Distance: Horizontal at 3 m										
Frequency (MHz)	Emission Level (dBuV/m)	Read Level (dBuV)	Limit (dBuV/m)	Margin (dB)	Antenna Factor (dB/m)	Cable Loss (dB)	Preamp Factor (dB)	Antenna Height (cm)	Table Angle (Degree)	Remark
2389.2	48.63	55.14	74	-25.37	26.91	4.08	37.5	132	119	Peak
2389.83	36.57	43.1	54	-17.43	26.91	4.08	37.52	132	119	Average
2437	89.4	95.68			27.06	4.12	37.46	132	119	Average
2437	98.96	105.24			27.06	4.12	37.46	132	119	Peak
2484.68	40.98	47	54	-13.02	27.15	4.15	37.32	132	119	Average
2488.64	53.98	59.94	74	-20.02	27.2	4.16	37.32	132	119	Peak
4874	32.91	48.05	54	-21.09	31.06	6.85	53.05	185	327	Average
4874	43.22	58.36	74	-30.78	31.06	6.85	53.05	185	327	Peak

Antennal Polarity & Test Distance: Vertical at 3 m										
Frequency (MHz)	Emission Level (dBuV/m)	Read Level (dBuV)	Limit (dBuV/m)	Margin (dB)	Antenna Factor (dB/m)	Cable Loss (dB)	Preamp Factor (dB)	Antenna Height (cm)	Table Angle (Degree)	Remark
2389.56	35.34	41.85	54	-18.66	26.91	4.08	37.5	201	87	Average
2389.65	47.64	54.15	74	-26.36	26.91	4.08	37.5	201	87	Peak
2437	87.16	93.44			27.06	4.12	37.46	201	87	Average
2437	96.64	102.92			27.06	4.12	37.46	201	87	Peak
2483.72	39.07	45.09	54	-14.93	27.15	4.15	37.32	201	87	Average
2485.64	51.73	57.75	74	-22.27	27.15	4.15	37.32	201	87	Peak
4874	32.79	47.93	54	-21.21	31.06	6.85	53.05	157	185	Average
4874	42.5	57.64	74	-31.5	31.06	6.85	53.05	157	185	Peak

Remarks:

- Emission Level = Read Level + Antenna Factor + Cable Loss - Preamp Factor
Margin value = Emission level – Limit value
- 2437 MHz: Fundamental frequency.

EUT Test Condition		Measurement Detail	
Channel	Channel 9	Frequency Range	1 GHz ~ 25 GHz
Input Power	120 Vac, 60 Hz	Detector Function	Peak (PK) Average (AV)
Environmental Conditions	25 deg. C, 65 % RH	Tested By	Toby Tian

Antennal Polarity & Test Distance: Horizontal at 3 m										
Frequency (MHz)	Emission Level (dBuV/m)	Read Level (dBuV)	Limit (dBuV/m)	Margin (dB)	Antenna Factor (dB/m)	Cable Loss (dB)	Preamp Factor (dB)	Antenna Height (cm)	Table Angle (Degree)	Remark
2378.04	47.69	54.26	74	-26.31	26.86	4.07	37.5	130	125	Peak
2388.03	35.64	42.15	54	-18.36	26.91	4.08	37.5	130	125	Average
2452	89.4	95.6			27.06	4.13	37.39	130	125	Average
2452	98.96	105.16			27.06	4.13	37.39	130	125	Peak
2483.6	48.65	54.67	54	-5.35	27.15	4.15	37.32	130	125	Average
2484.56	60.31	66.33	74	-13.69	27.15	4.15	37.32	130	125	Peak
4904	33.02	48.07	54	-20.98	31.1	6.88	53.03	173	324	Average
4904	43.82	58.87	74	-30.18	31.1	6.88	53.03	173	324	Peak

Antennal Polarity & Test Distance: Vertical at 3 m										
Frequency (MHz)	Emission Level (dBuV/m)	Read Level (dBuV)	Limit (dBuV/m)	Margin (dB)	Antenna Factor (dB/m)	Cable Loss (dB)	Preamp Factor (dB)	Antenna Height (cm)	Table Angle (Degree)	Remark
2365.17	47.06	53.68	74	-26.94	26.81	4.07	37.5	203	84	Peak
2366.88	35.05	41.67	54	-18.95	26.81	4.07	37.5	203	84	Average
2452	88.08	94.28			27.06	4.13	37.39	203	84	Average
2452	96.61	102.81			27.06	4.13	37.39	203	84	Peak
2483.6	45.85	51.87	54	-8.15	27.15	4.15	37.32	203	84	Average
2484.32	58.13	64.15	74	-15.87	27.15	4.15	37.32	203	84	Peak
4904	32.8	47.85	54	-21.2	31.1	6.88	53.03	150	176	Average
4904	42.59	57.64	74	-31.41	31.1	6.88	53.03	150	176	Peak

Remarks:

- Emission Level = Read Level + Antenna Factor + Cable Loss - Preamp Factor
Margin value = Emission level – Limit value
- 2452 MHz: Fundamental frequency.

9 kHz ~ 30 MHz DATA:

The amplitude of spurious emissions attenuated more than 20 dB below the permissible value is not required to be report.

30 MHz ~ 1 GHz WORST-CASE DATA:

Mode A

802.11n (HT40)

EUT Test Condition		Measurement Detail	
Channel	Channel 9	Frequency Range	30 MHz ~ 1 GHz
Input Power	120 Vac, 60 Hz	Detector Function	Peak (PK) Quasi-peak (QP)
Environmental Conditions	25 deg. C, 65 % RH	Tested By	Toby Tian

Antennal Polarity & Test Distance: Horizontal at 3 m										
Frequency (MHz)	Emission Level (dBuV/m)	Read Level (dBuV)	Limit (dBuV/m)	Margin (dB)	Antenna Factor (dB/m)	Cable Loss (dB)	Preamp Factor (dB)	Antenna Height (cm)	Table Angle (Degree)	Remark
174.53	32.95	52.29	43.5	-10.55	11.28	1.16	31.78	136	200	Peak
298.69	33.26	50.54	46	-12.74	12.91	1.63	31.82	126	127	Peak
359.8	28.28	44.08	46	-17.72	14.38	1.79	31.97	128	14	Peak
483.96	31.92	44.68	46	-14.08	17	2.06	31.82	103	54	Peak
515.97	37.16	48.94	46	-8.84	17.68	2.12	31.58	132	258	Peak
612.97	28.42	38.48	46	-17.58	19.76	2.29	32.11	104	168	Peak

Antennal Polarity & Test Distance: Vertical at 3 m										
Frequency (MHz)	Emission Level (dBuV/m)	Read Level (dBuV)	Limit (dBuV/m)	Margin (dB)	Antenna Factor (dB/m)	Cable Loss (dB)	Preamp Factor (dB)	Antenna Height (cm)	Table Angle (Degree)	Remark
175.5	32.92	52.36	43.5	-10.58	11.19	1.16	31.79	104	321	Peak
238.55	24.37	43.72	46	-21.63	10.99	1.45	31.79	126	316	Peak
338.46	29.44	45.66	46	-16.56	13.87	1.73	31.82	118	172	Peak
483.96	31.93	44.69	46	-14.07	17	2.06	31.82	120	357	Peak
515.97	34.28	46.06	46	-11.72	17.68	2.12	31.58	128	240	Peak
612.97	29.27	39.33	46	-16.73	19.76	2.29	32.11	120	23	Peak

Remarks:

1. Emission Level = Read Level + Antenna Factor + Cable Loss - Preamp Factor

Margin value = Emission level – Limit value

4.2 Conducted Emission Measurement

4.2.1 Limits of Conducted Emission Measurement

Frequency (MHz)	Conducted Limit (dBuV)	
	Quasi-peak	Average
0.15 - 0.5	66 - 56	56 - 46
0.50 - 5.0	56	46
5.0 - 30.0	60	50

Note: 1. The lower limit shall apply at the transition frequencies.

2. The limit decreases in line with the logarithm of the frequency in the range of 0.15 to 0.50 MHz.

4.2.2 Test Instruments

Description & Manufacturer	Model No.	Serial No.	Date of Calibration	Due Date of Calibration
Test Receiver ROHDE & SCHWARZ	ESCS 30	100288	Aug. 18, 2016	Aug. 17, 2017
RF signal cable Woken	5D-FB	Cable-cond2-01	Dec. 22, 2016	Dec. 21, 2017
LISN ROHDE & SCHWARZ (EUT)	ESH2-Z5	100100	Jan. 17, 2017	Jan. 16, 2018
LISN ROHDE & SCHWARZ (Peripheral)	ESH3-Z5	100312	Jul. 26, 2016	Jul. 25, 2017
Software ADT	BV ADT_Cond_ V7.3.7.3	NA	NA	NA

Note: 1. The calibration interval of the above test instruments is 12 months and the calibrations are traceable to NML/ROC and NIST/USA.

2. The test was performed in HwaYa Shielded Room 2.

3. The VCCI Site Registration No. is C-2047.

4.2.3 Test Procedures

- The EUT was placed 0.4 meters from the conducting wall of the shielded room with EUT being connected to the power mains through a line impedance stabilization network (LISN). Other support units were connected to the power mains through another LISN. The two LISNs provide 50 ohm/50 uH of coupling impedance for the measuring instrument.
- Both lines of the power mains connected to the EUT were checked for maximum conducted interference.
- The frequency range from 150 kHz to 30 MHz was searched. Emission levels under (Limit – 20 dB) was not recorded.

NOTE: All modes of operation were investigated and the worst-case emissions are reported.

4.2.4 Deviation from Test Standard

No deviation.

4.2.5 Test Setup

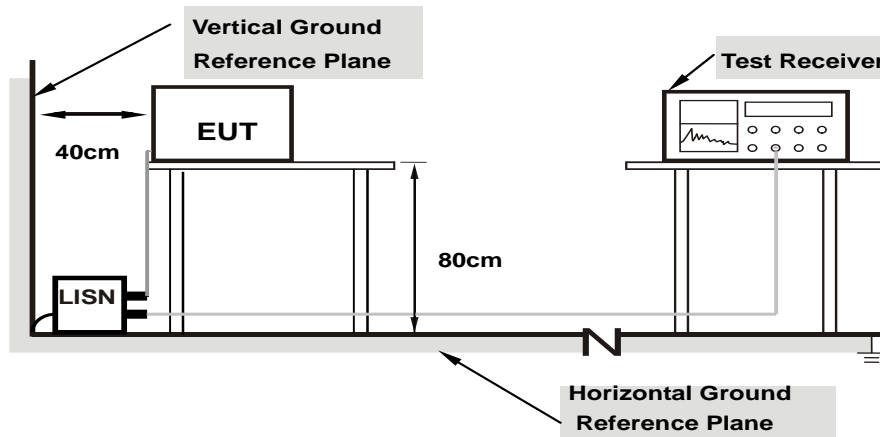

Note: 1. Support units were connected to second LISN.

For the actual test configuration, please refer to the attached file (Test Setup Photo).

4.2.6 EUT Operating Conditions

- Placed the EUT on a testing table.
- Use the software to control the EUT under transmission condition continuously at specific channel frequency.

4.2.7 Test Results

Frequency Range	150kHz ~ 30MHz	Detector Function & Resolution Bandwidth	Quasi-Peak (QP) / Average (AV), 9kHz
Input Power	120Vac, 60Hz	Environmental Conditions	25°C, 65%RH
Tested by	Getaz Yang	Test Date	2017/5/19

Phase Of Power : Line (L)										
No	Frequency (MHz)	Correction Factor (dB)	Reading Value (dBuV)		Emission Level (dBuV)		Limit (dBuV)		Margin (dB)	
			Q.P.	AV.	Q.P.	AV.	Q.P.	AV.	Q.P.	AV.
1	0.16562	10.01	38.45	21.55	48.46	31.56	65.18	55.18	-16.72	-23.62
2	0.18516	9.96	36.01	19.33	45.97	29.29	64.25	54.25	-18.28	-24.96
3	0.47813	9.92	22.20	15.88	32.12	25.80	56.37	46.37	-24.25	-20.57
4	0.97813	10.01	10.22	4.21	20.23	14.22	56.00	46.00	-35.77	-31.78
5	2.59375	9.97	9.20	3.65	19.17	13.62	56.00	46.00	-36.83	-32.38
6	13.87500	10.19	9.97	-0.21	20.16	9.98	60.00	50.00	-39.84	-40.02

Remarks:

1. Q.P. and AV. are abbreviations of quasi-peak and average individually.
2. The emission levels of other frequencies were very low against the limit.
3. Margin value = Emission level – Limit value
4. Correction factor = Insertion loss + Cable loss
5. Emission Level = Correction Factor + Reading Value

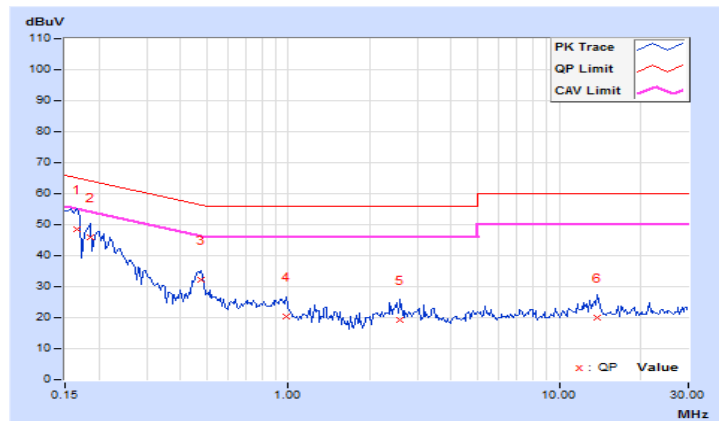

Frequency Range	150kHz ~ 30MHz	Detector Function & Resolution Bandwidth	Quasi-Peak (QP) / Average (AV), 9kHz
Input Power	120Vac, 60Hz	Environmental Conditions	25°C, 65%RH
Tested by	Getaz Yang	Test Date	2017/5/19

Phase Of Power : Neutral (N)										
No	Frequency (MHz)	Correction Factor (dB)	Reading Value (dBuV)		Emission Level (dBuV)		Limit (dBuV)		Margin (dB)	
			Q.P.	AV.	Q.P.	AV.	Q.P.	AV.	Q.P.	AV.
1	0.16172	9.86	39.10	22.64	48.96	32.50	65.38	55.38	-16.42	-22.88
2	0.22812	9.81	28.64	11.65	38.45	21.46	62.52	52.52	-24.07	-31.06
3	0.46641	9.95	22.51	16.07	32.46	26.02	56.58	46.58	-24.12	-20.56
4	0.93125	9.92	8.75	1.94	18.67	11.86	56.00	46.00	-37.33	-34.14
5	2.67188	10.05	11.07	6.27	21.12	16.32	56.00	46.00	-34.88	-29.68
6	7.72266	10.11	1.95	-3.69	12.06	6.42	60.00	50.00	-47.94	-43.58

Remarks:

1. Q.P. and AV. are abbreviations of quasi-peak and average individually.
2. The emission levels of other frequencies were very low against the limit.
3. Margin value = Emission level – Limit value
4. Correction factor = Insertion loss + Cable loss
5. Emission Level = Correction Factor + Reading Value

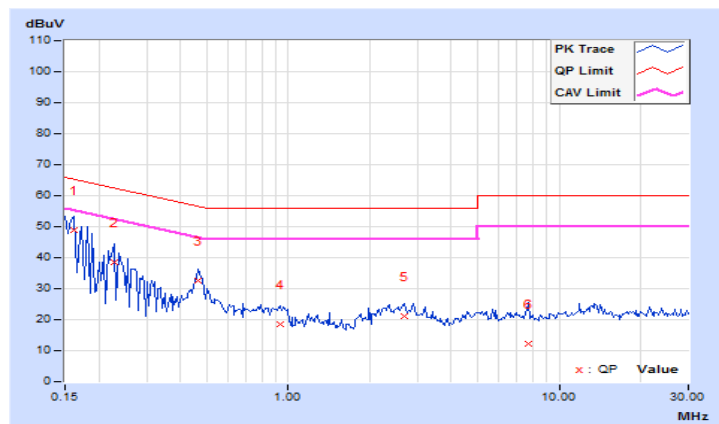

4.3 6 dB Bandwidth Measurement

4.3.1 Limits of 6 dB Bandwidth Measurement

The minimum of 6 dB Bandwidth Measurement is 0.5 MHz.

4.3.2 Test Setup

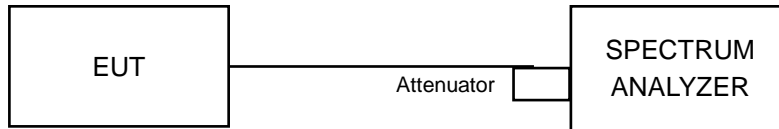

4.3.3 Test Instruments

Refer to section 4.1.2 to get information of above instrument.

4.3.4 Test Procedure

- a. Set resolution bandwidth (RBW) = 100 kHz
- b. Set the video bandwidth (VBW) $\geq 3 \times$ RBW, Detector = Peak.
- c. Trace mode = max hold.
- d. Sweep = auto couple.
- e. Measure the maximum width of the emission that is constrained by the frequencies associated with the two amplitude points (upper and lower) that are attenuated by 6 dB relative to the maximum level measured in the fundamental emission

4.3.5 Deviation from Test Standard

No deviation.

4.3.6 EUT Operating Conditions

The software provided by client to enable the EUT under transmission condition continuously at lowest, middle and highest channel frequencies individually.

4.3.7 Test Result

Mode A

802.11b

Channel	Frequency (MHz)	6 dB Bandwidth (MHz)	Minimum Limit (MHz)	Pass / Fail
1	2412	9.59	0.5	Pass
6	2437	10.13	0.5	Pass
11	2462	9.62	0.5	Pass

802.11g

Channel	Frequency (MHz)	6 dB Bandwidth (MHz)	Minimum Limit (MHz)	Pass / Fail
1	2412	15.14	0.5	Pass
6	2437	15.16	0.5	Pass
11	2462	14.85	0.5	Pass

Mode B

802.11n (HT20)

Channel	Frequency (MHz)	6 dB Bandwidth (MHz)		Minimum Limit (MHz)	Pass / Fail
		Chain 0	Chain 1		
1	2412	15.12	15.15	0.5	Pass
6	2437	15.17	16.31	0.5	Pass
11	2462	15.18	16.31	0.5	Pass

802.11n (HT40)

Channel	Frequency (MHz)	6 dB Bandwidth (MHz)		Minimum Limit (MHz)	Pass / Fail
		Chain 0	Chain 1		
3	2422	33.94	35.14	0.5	Pass
6	2437	33.94	35.22	0.5	Pass
9	2452	33.96	35.15	0.5	Pass

Spectrum Plot of Worst Value

802.11b

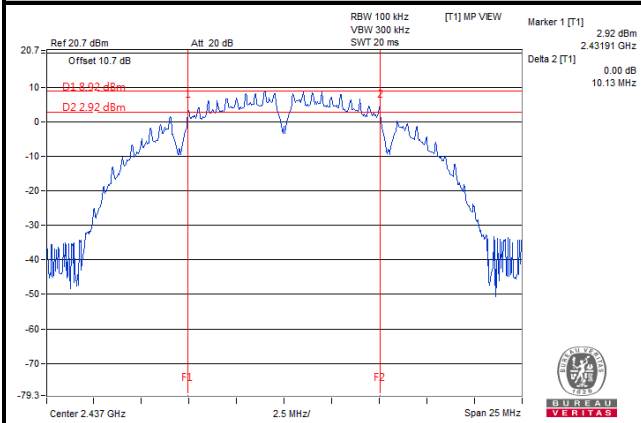

802.11g

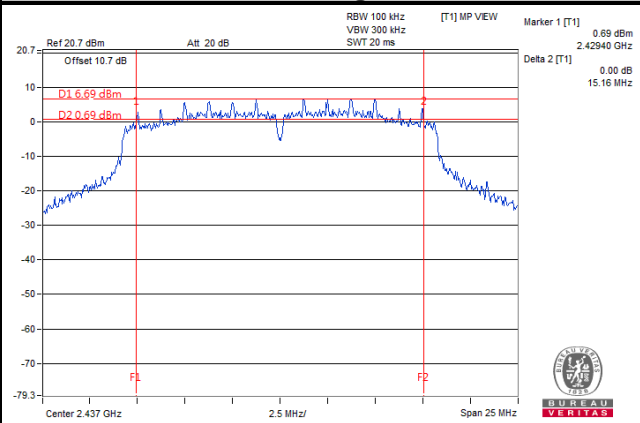

802.11n (HT20)

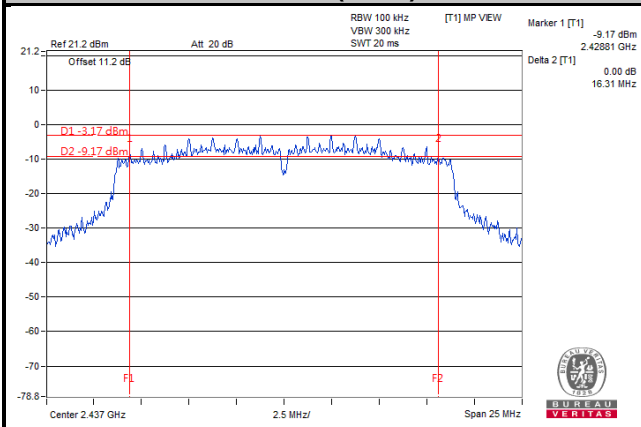

802.11n (HT40)

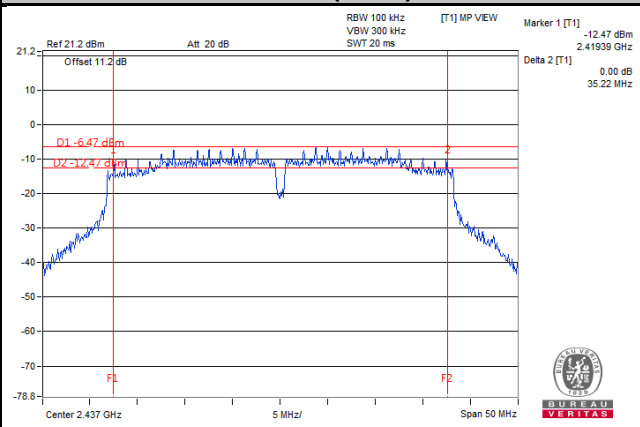

4.4 Conducted Output Power Measurement

4.4.1 Limits of Conducted Output Power Measurement

For systems using digital modulation in the 2400–2483.5 MHz bands: 1 Watt (30 dBm)

Per KDB 662911 D01 Multiple Transmitter Output Method of conducted output power measurement on IEEE 802.11 devices,

Array Gain = 0 dB (i.e., no array gain) for $NANT \leq 4$;

Array Gain = 0 dB (i.e., no array gain) for channel widths ≥ 40 MHz for any NANT;

Array Gain = $5 \log(NANT/NSS)$ dB or 3 dB, whichever is less for 20 MHz channel widths with $NANT \geq 5$.

For power measurements on all other devices: Array Gain = $10 \log(NANT/NSS)$ dB.

4.4.2 Test Setup

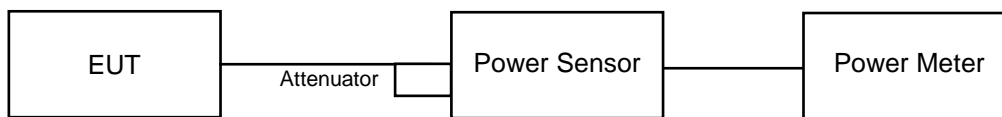

4.4.3 Test Instruments

Refer to section 4.1.2 to get information of above instrument.

4.4.4 Test Procedures

A peak power sensor was used on the output port of the EUT. A power meter was used to read the response of the peak power sensor. Record the power level.

4.4.5 Deviation from Test Standard

No deviation.

4.4.6 EUT Operating Conditions

The software provided by client to enable the EUT under transmission condition continuously at lowest, middle and highest channel frequencies individually.

4.4.7 Test Results

Mode A

802.11b

Channel	Frequency (MHz)	Peak Power (mW)	Peak Power (dBm)	Limit (dBm)	Pass / Fail
1	2412	116.145	20.65	30	Pass
6	2437	117.761	20.71	30	Pass
11	2462	118.577	20.74	30	Pass

802.11g

Channel	Frequency (MHz)	Peak Power (mW)	Peak Power (dBm)	Limit (dBm)	Pass / Fail
1	2412	279.254	24.46	30	Pass
6	2437	270.396	24.32	30	Pass
11	2462	277.332	24.43	30	Pass

Mode B

802.11n (HT20)

Channel	Frequency (MHz)	Peak Power (dBm)		Total Power (mW)	Total Power (dBm)	Limit (dBm)	Pass / Fail
		Chain 0	Chain 1				
1	2412	20.85	12.57	139.691	21.45	30	Pass
6	2437	21.01	12.63	144.506	21.60	30	Pass
11	2462	20.77	12.14	135.767	21.33	30	Pass

802.11n (HT40)

Channel	Frequency (MHz)	Peak Power (dBm)		Total Power (mW)	Total Power (dBm)	Limit (dBm)	Pass / Fail
		Chain 0	Chain 1				
3	2422	19.67	11.75	107.645	20.32	30	Pass
6	2437	19.46	11.26	101.674	20.07	30	Pass
9	2452	19.39	11.15	99.928	20.00	30	Pass

4.5 Power Spectral Density Measurement

4.5.1 Limits of Power Spectral Density Measurement

The Maximum of Power Spectral Density Measurement is 8 dBm.

4.5.2 Test Setup

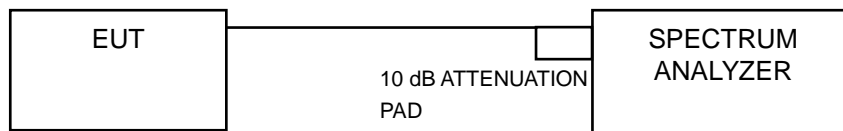

4.5.3 Test Instruments

Refer to section 4.1.2 to get information of above instrument.

4.5.4 Test Procedure

- a. Set analyzer center frequency to DTS channel center frequency.
- b. Set the span to 1.5 times the DTS bandwidth.
- c. Set the RBW to: $3 \text{ kHz} \leq \text{RBW} \leq 100 \text{ kHz}$.
- d. Set the VBW $\geq 3 \times \text{RBW}$.
- e. Detector = peak.
- f. Sweep time = auto couple.
- g. Trace mode = max hold.
- h. Allow trace to fully stabilize.
- i. Use the peak marker function to determine the maximum amplitude level within the RBW.

4.5.5 Deviation from Test Standard

No deviation.

4.5.6 EUT Operating Condition

The software provided by client to enable the EUT under transmission condition continuously at lowest, middle and highest channel frequencies individually.

4.5.7 Test Results

Mode A

802.11b

Channel	Frequency (MHz)	PSD (dBm)	Limit (dBm)	Pass / Fail
1	2412	-5.59	8	Pass
6	2437	-5.33	8	Pass
11	2462	-5.76	8	Pass

802.11g

Channel	Frequency (MHz)	PSD (dBm)	Limit (dBm)	Pass / Fail
1	2412	-9.49	8	Pass
6	2437	-9.37	8	Pass
11	2462	-10.29	8	Pass

Mode B

802.11n (HT20)

TX Chain	Channel	Freq. (MHz)	PSD (dBm)	10 log (N=2) dB	Total PSD (dBm)	Limit (dBm)	Pass / Fail
0	1	2412	-12.89	3.01	-9.88	6.5	Pass
	6	2437	-12.96	3.01	-9.95	6.5	Pass
	11	2462	-12.58	3.01	-9.57	6.5	Pass
1	1	2412	-17.88	3.01	-14.87	6.5	Pass
	6	2437	-17.89	3.01	-14.88	6.5	Pass
	11	2462	-17.31	3.01	-14.30	6.5	Pass

Directional gain = $10\log[(10^{G1/20} + 10^{G2/20})^2 / N_{ANT}] = 7.5 \text{ dBi} > 6 \text{ dBi}$, so the power density limit shall be reduced to $8 - (7.5 - 6) = 6.5 \text{ dBm}$.

802.11n (HT40)

TX Chain	Channel	Freq. (MHz)	PSD (dBm)	10 log (N=2) dB	Total PSD (dBm)	Limit (dBm)	Pass / Fail
0	3	2422	-15.61	3.01	-12.60	6.5	Pass
	6	2437	-15.28	3.01	-12.27	6.5	Pass
	9	2452	-15.44	3.01	-12.43	6.5	Pass
1	3	2422	-21.41	3.01	-18.40	6.5	Pass
	6	2437	-21.33	3.01	-18.32	6.5	Pass
	9	2452	-21.67	3.01	-18.66	6.5	Pass

Directional gain = $10\log[(10^{G1/20} + 10^{G2/20})^2 / N_{ANT}] = 7.5 \text{ dBi} > 6 \text{ dBi}$, so the power density limit shall be reduced to $8 - (7.5 - 6) = 6.5 \text{ dBm}$.

Spectrum Plot of Worst Value

802.11b

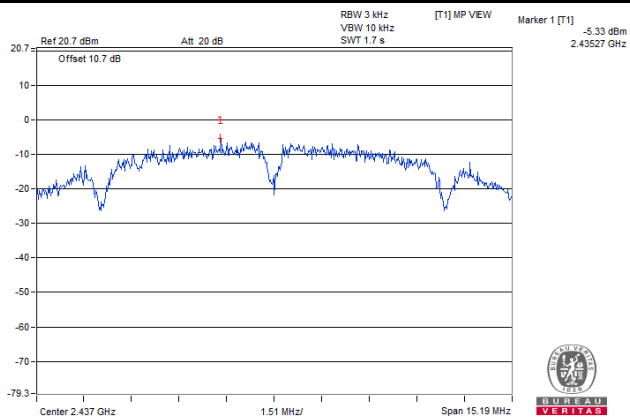

802.11g

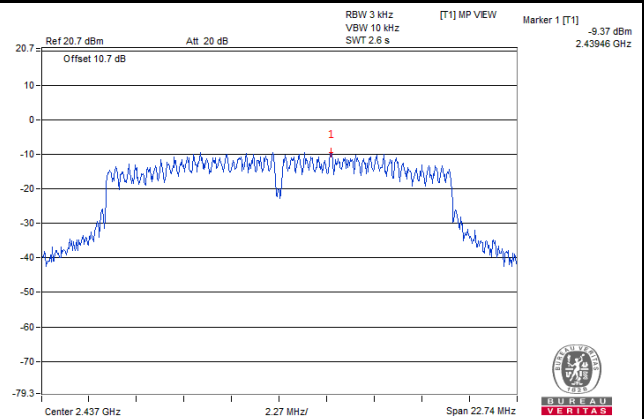

802.11n (HT20)

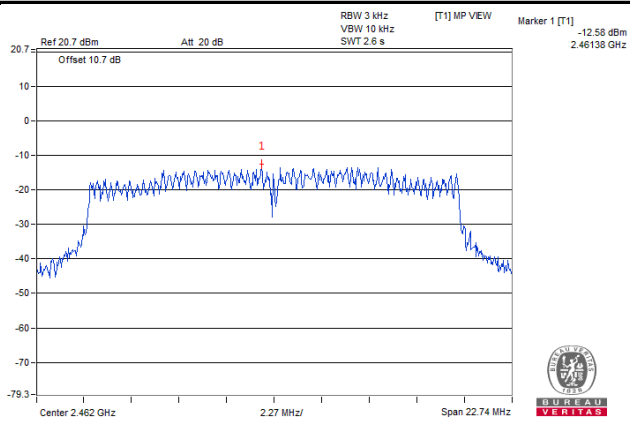

802.11n (HT40)

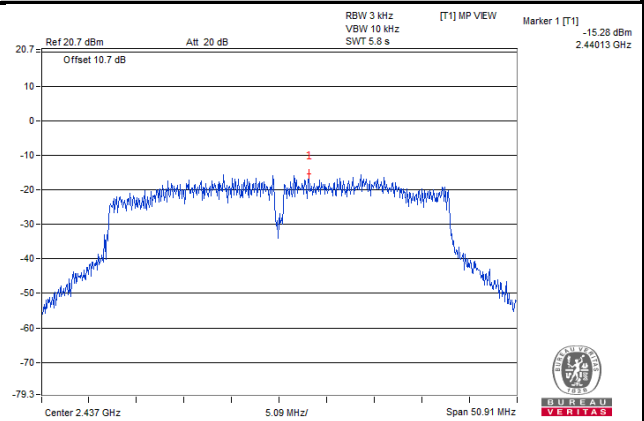

4.6 Conducted Out of Band Emission Measurement

4.6.1 Limits of Conducted Out of Band Emission Measurement

Below 20 dB of the highest emission level of operating band (in 100 kHz Resolution Bandwidth).

4.6.2 Test Setup

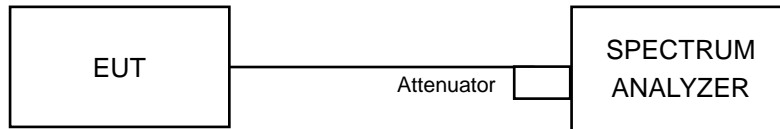

4.6.3 Test Instruments

Refer to section 4.1.2 to get information of above instrument.

4.6.4 Test Procedure

MEASUREMENT PROCEDURE REF

1. Set the RBW = 100 kHz.
2. Set the VBW \geq 300 kHz.
3. Detector = peak.
4. Sweep time = auto couple.
5. Trace mode = max hold.
6. Allow trace to fully stabilize.
7. Use the peak marker function to determine the maximum power level in any 100 kHz band segment within the fundamental EBW.

MEASUREMENT PROCEDURE OOB

1. Set RBW = 100 kHz.
2. Set VBW \geq 300 kHz.
3. Detector = peak.
4. Sweep = auto couple.
5. Trace Mode = max hold.
6. Allow trace to fully stabilize.
7. Use the peak marker function to determine the maximum amplitude level.

4.6.5 Deviation from Test Standard

No deviation.

4.6.6 EUT Operating Condition

The software provided by client to enable the EUT under transmission condition continuously at lowest, middle and highest channel frequencies individually.

4.6.7 Test Results

The conducted emission test is performed on each TX port of operating mode without summing or adding 10log (N) since the limit is relative emission limit.

The spectrum plots are attached on the following images. D1 line indicates the highest level, and D2 line indicates the 20 dB offset below D1. It shows compliance with the requirement.

Mode A 802.11b

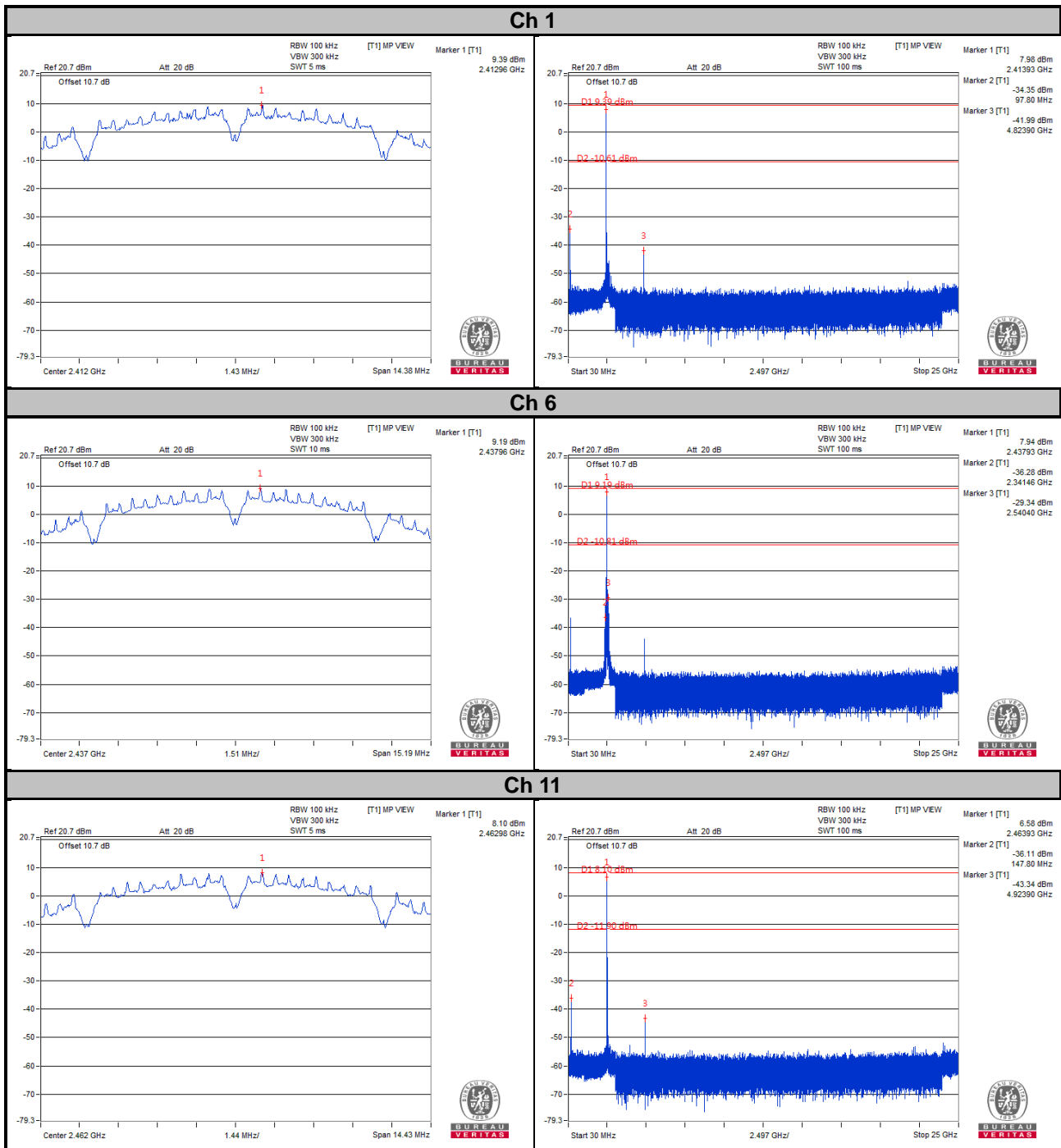

Ch 1 Band Edge

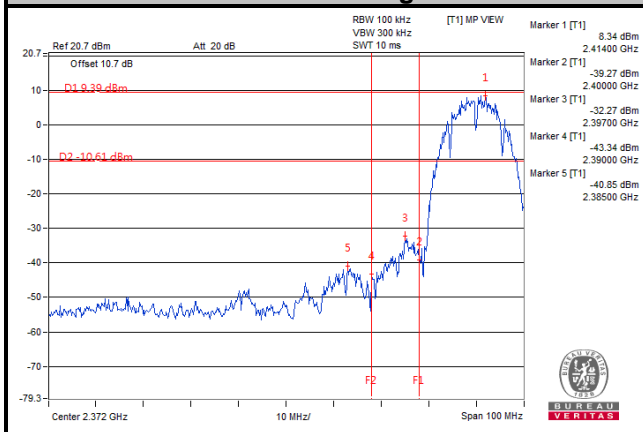

Ch 11 Band Edge

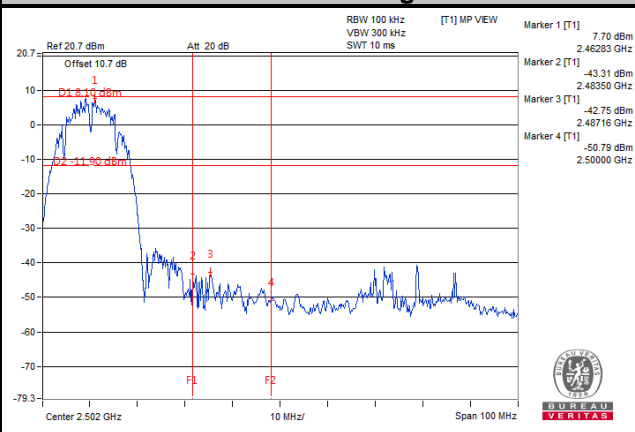

802.11g

Ch 1

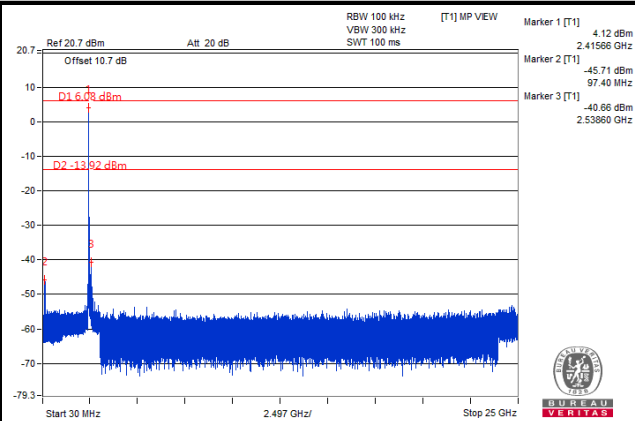
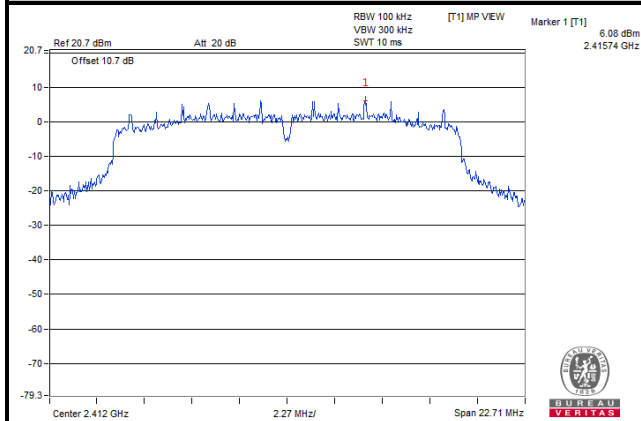

Ch 6

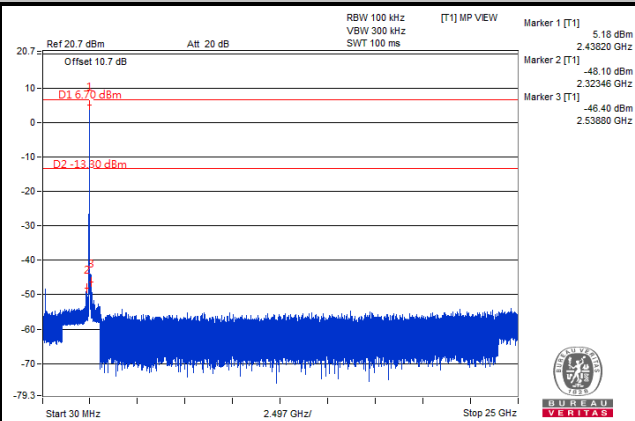
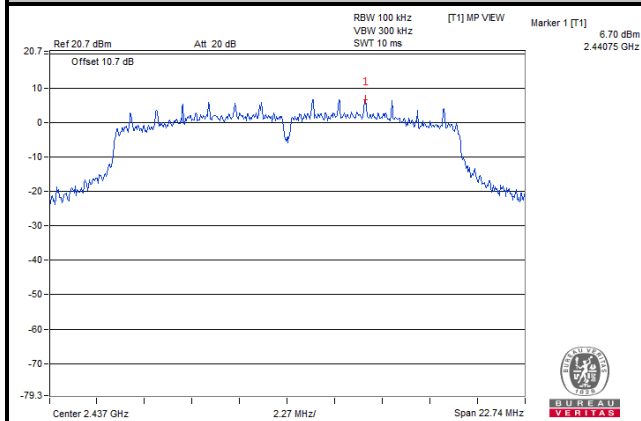

Ch 11

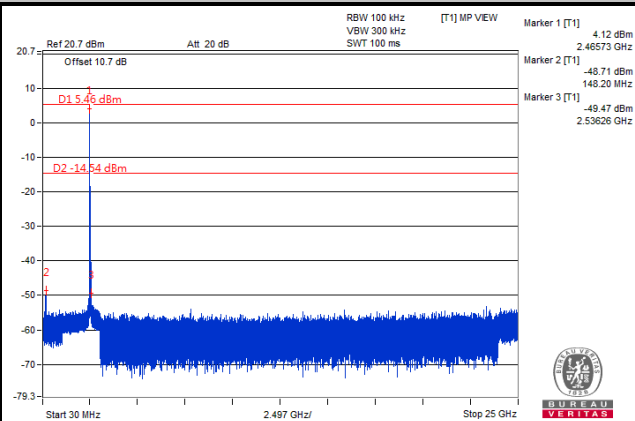
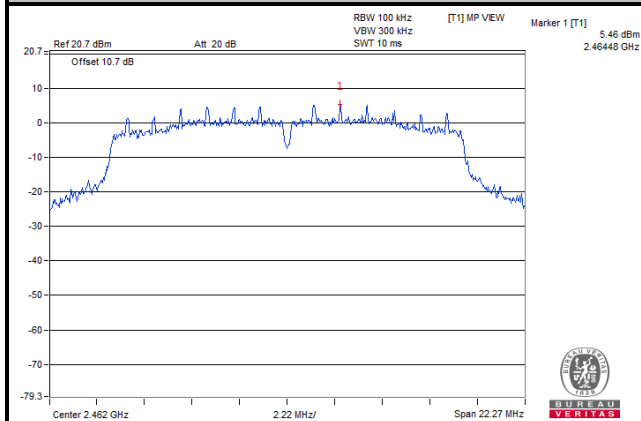

Ch 1 Band Edge

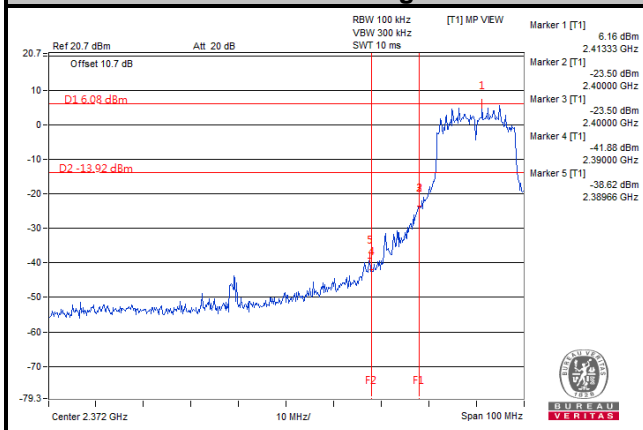

Ch 11 Band Edge

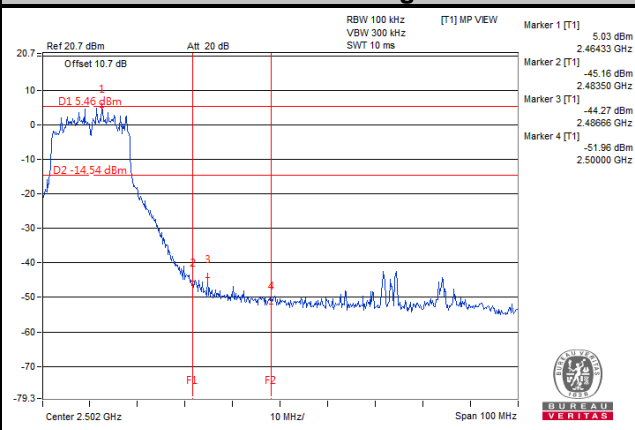

Mode B

802.11n (HT20)

CHAIN 0

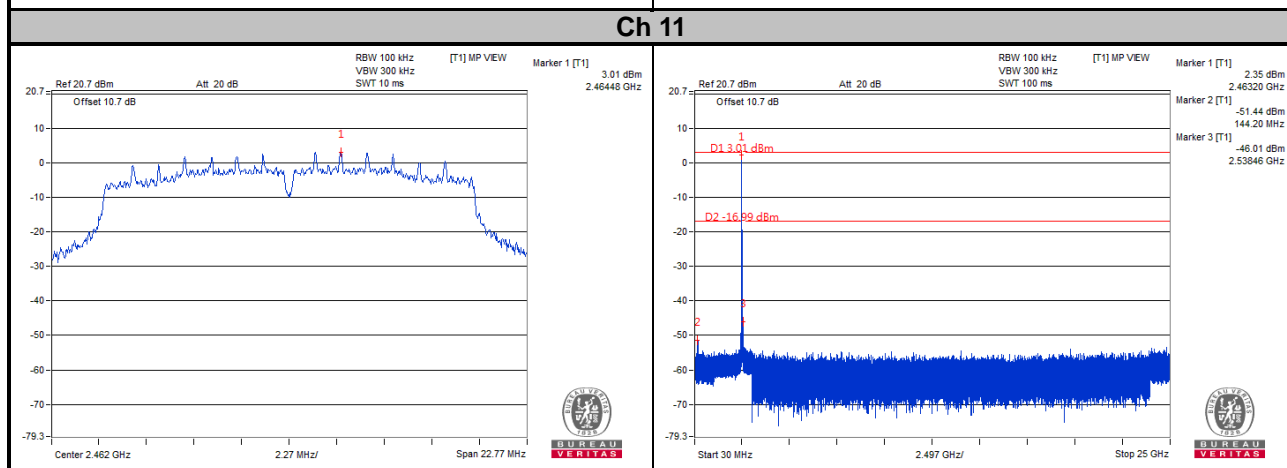
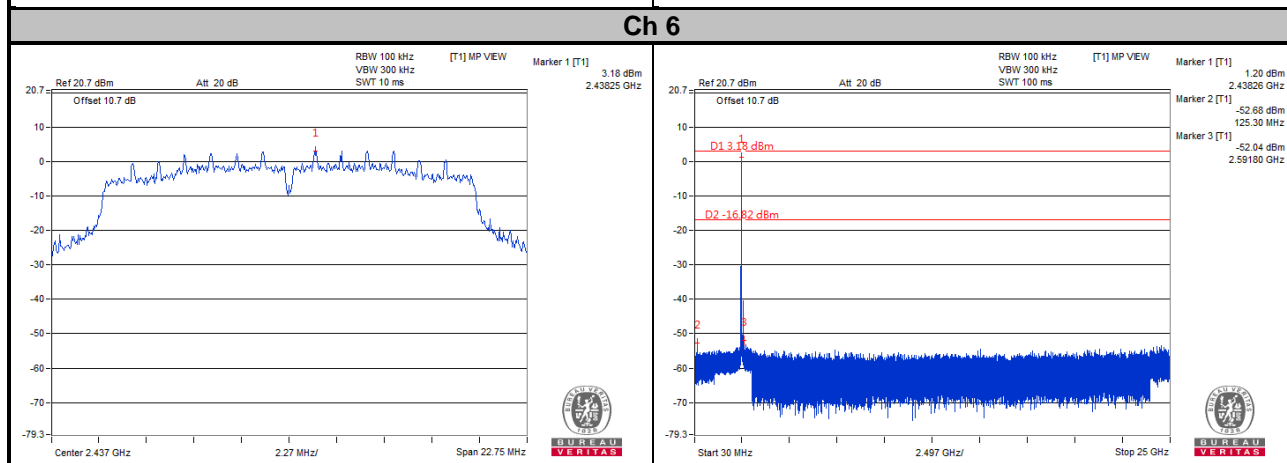
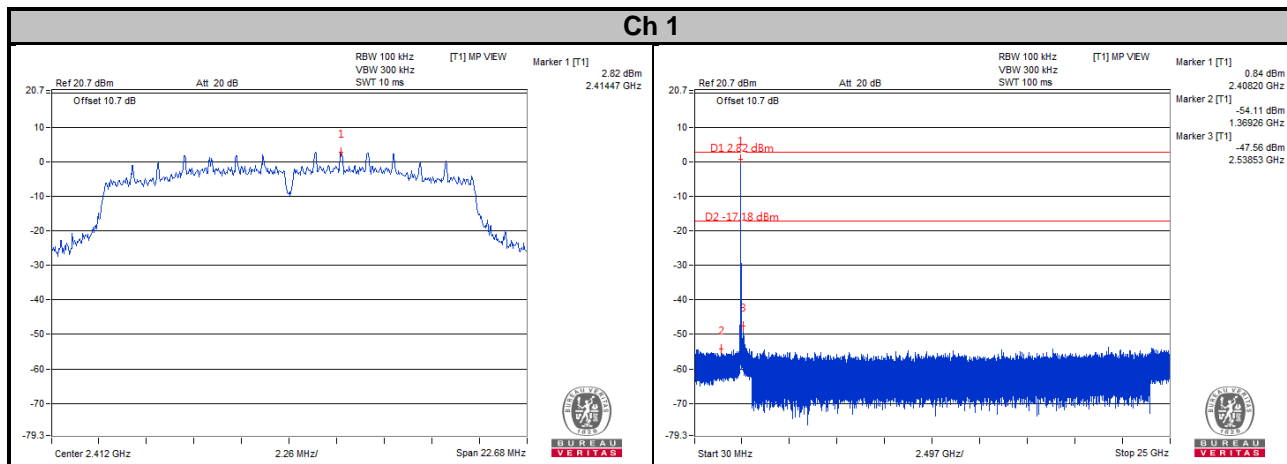

Ch 1 Band Edge

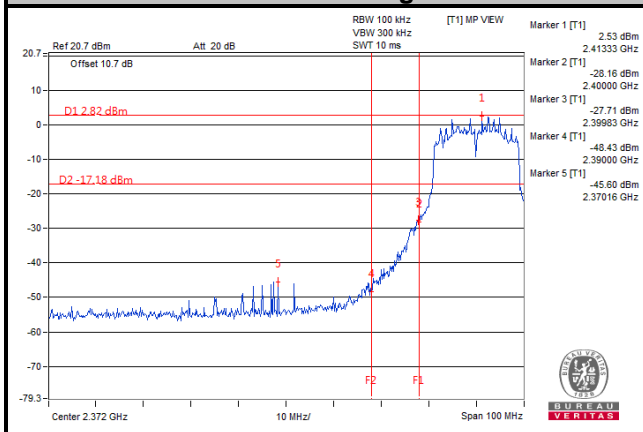

Ch 11 Band Edge

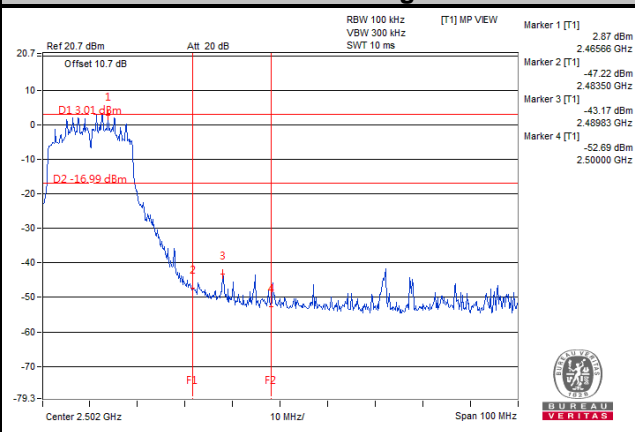

CHAIN 1

Ch 1

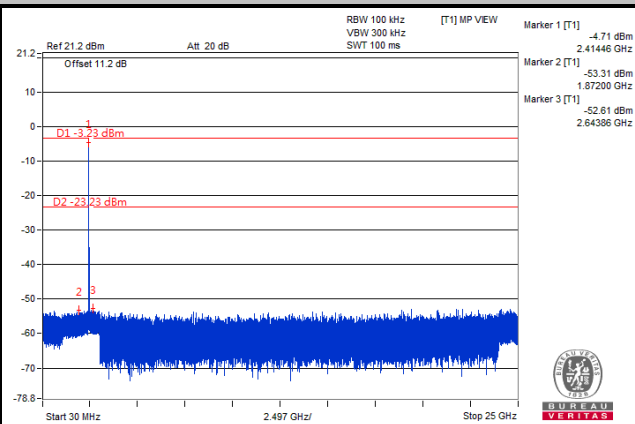
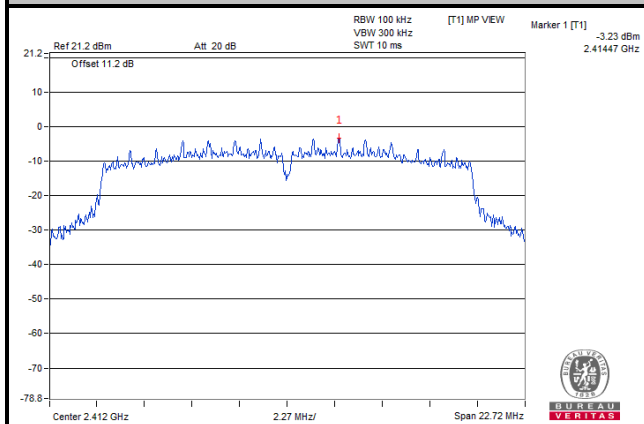

Ch 6

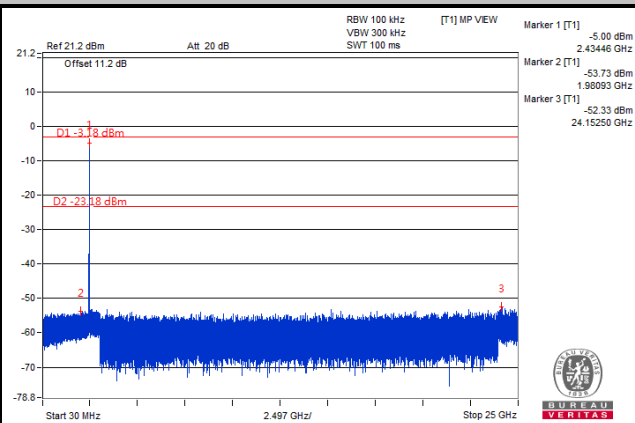
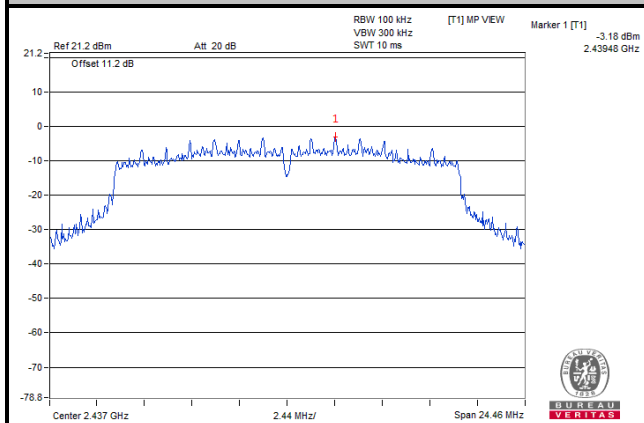

Ch 11

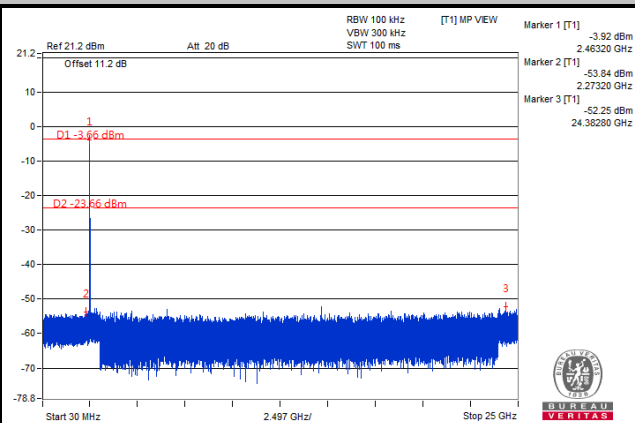
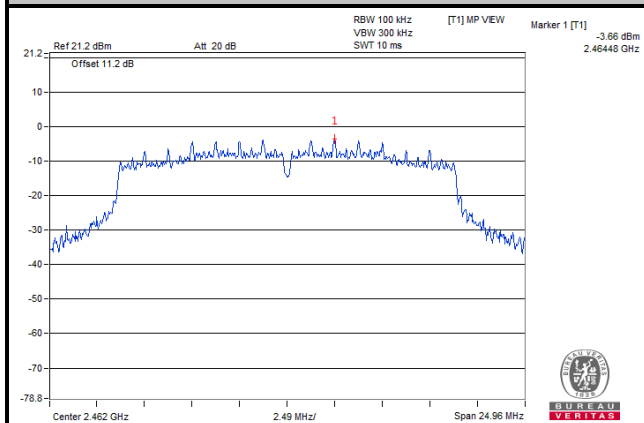

Ch 1 Band Edge

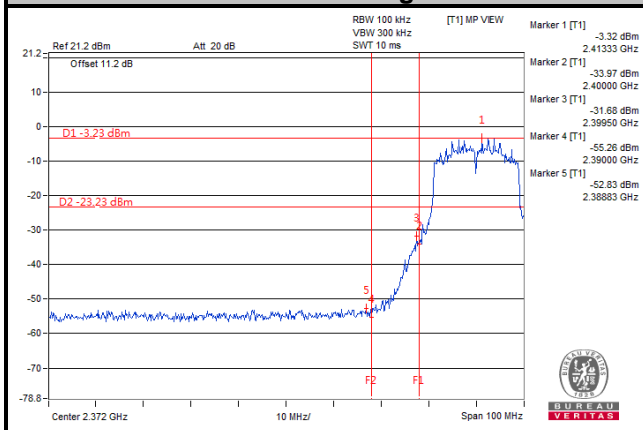

Ch 11 Band Edge

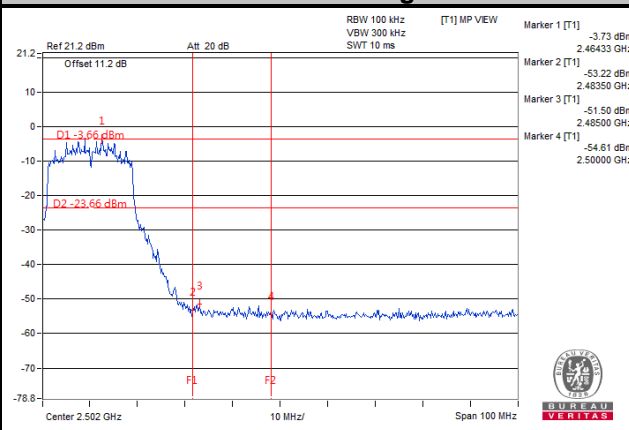

802.11n (HT40)
CHAIN 0

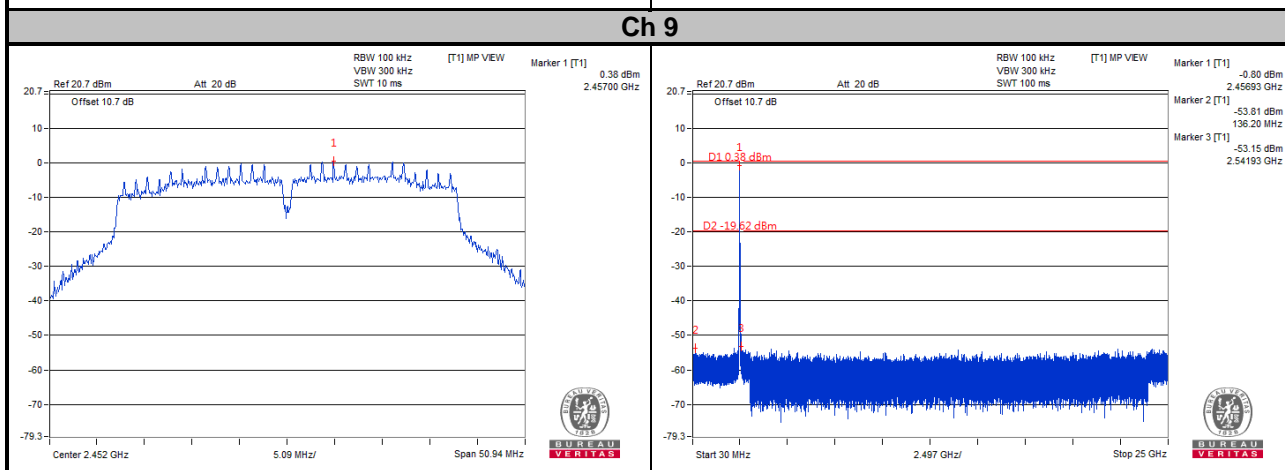
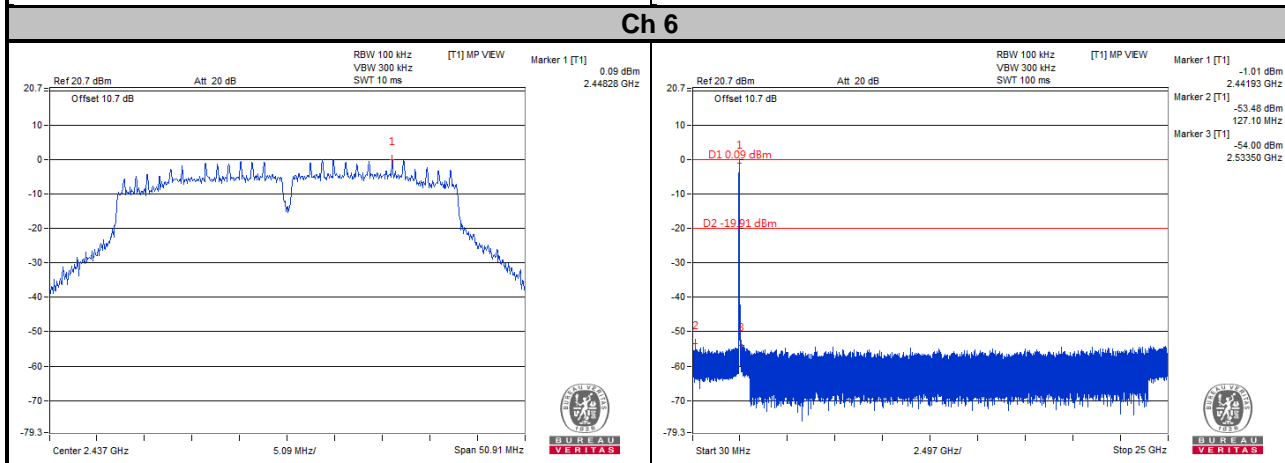
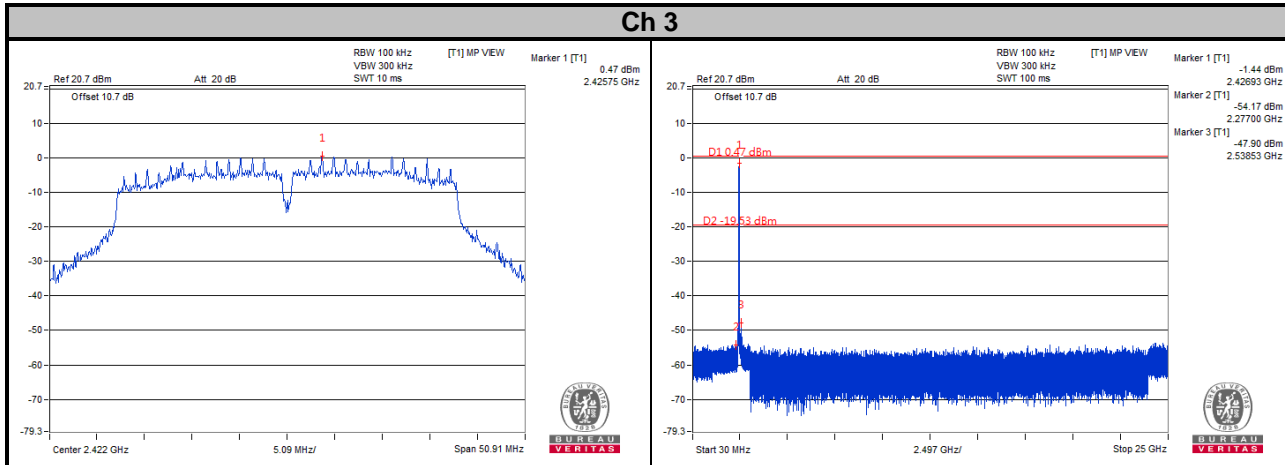

Ch 3 Band Edge

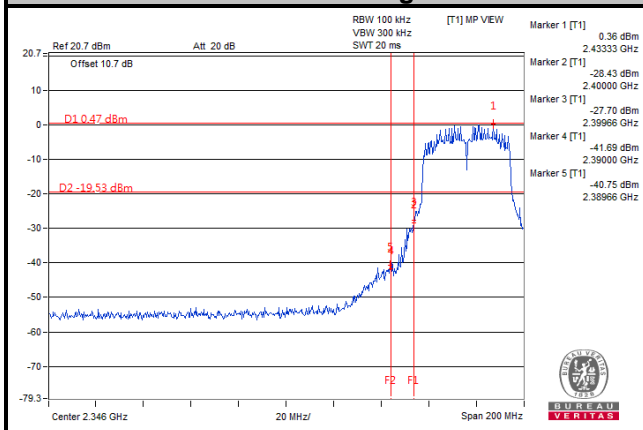

Ch 9 Band Edge

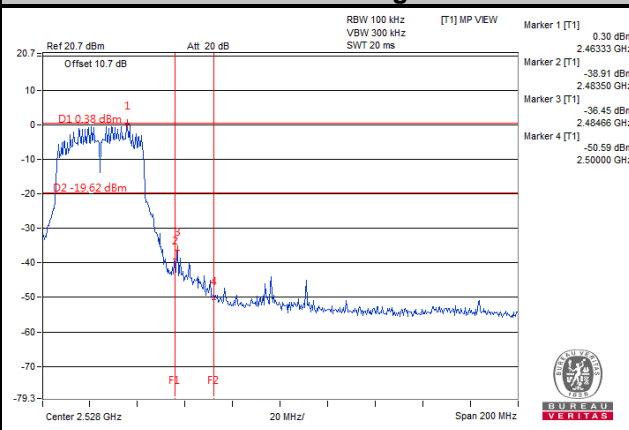

CHAIN 1

Ch 3

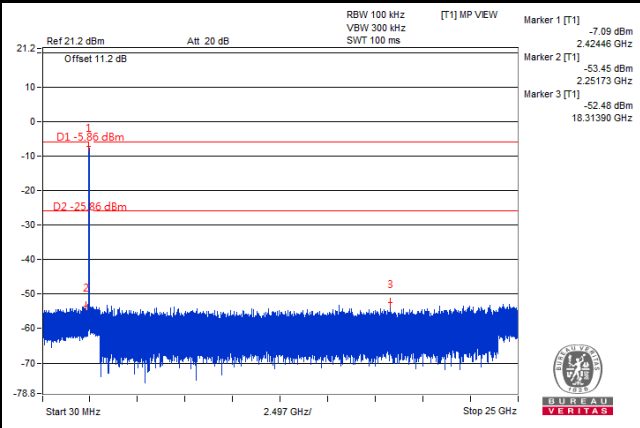
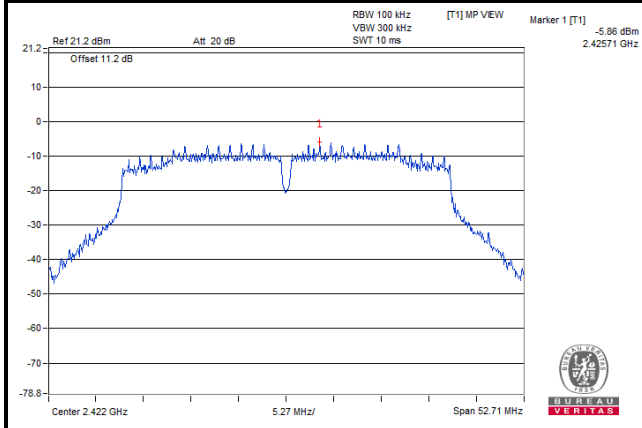

Ch 6

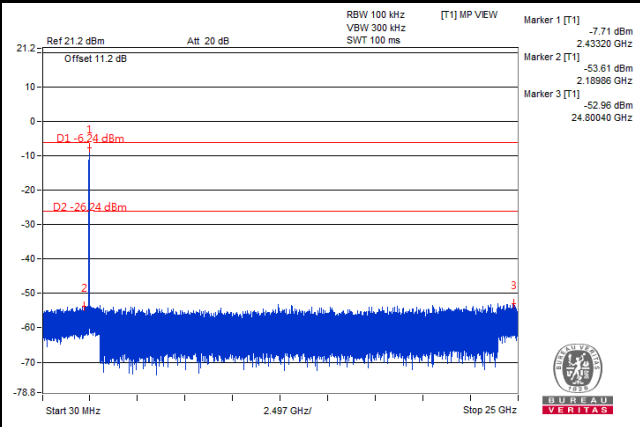
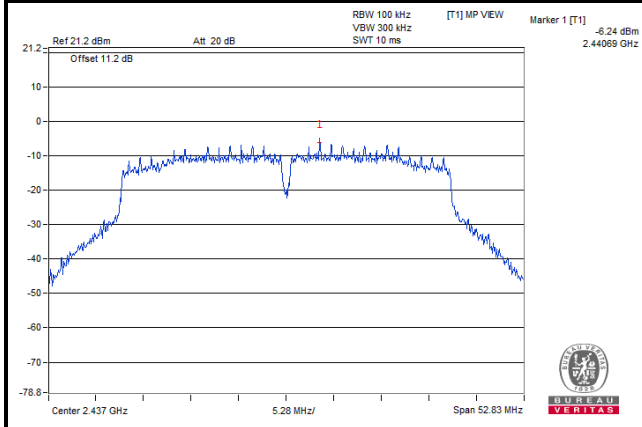

Ch 9

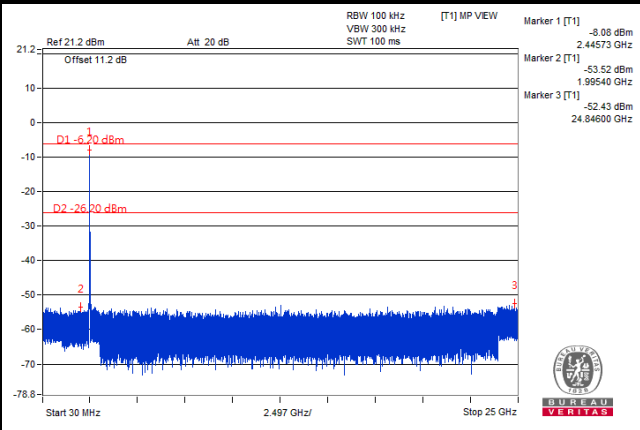
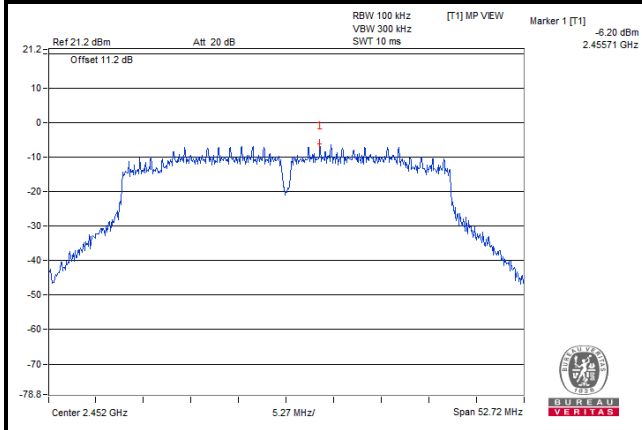

Ch 3 Band Edge

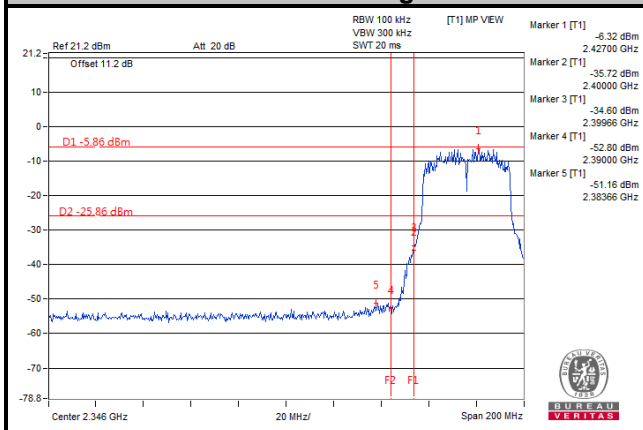

Ch 9 Band Edge

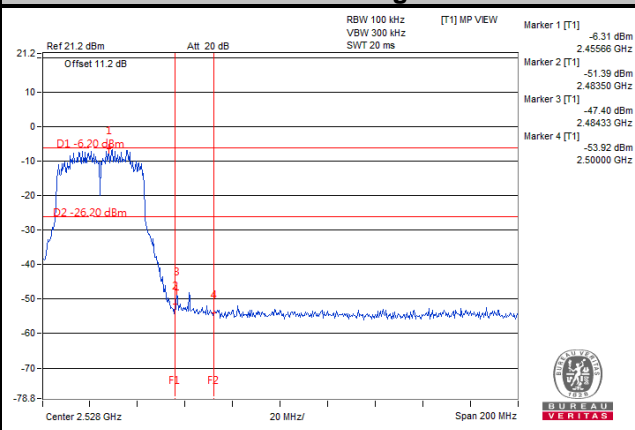

5 Pictures of Test Arrangements

Please refer to the attached file (Test Setup Photo).

Appendix – Information on the Testing Laboratories

We, Bureau Veritas Consumer Products Services (H.K.) Ltd., Taoyuan Branch, were founded in 1988 to provide our best service in EMC, Radio, Telecom and Safety consultation. Our laboratories are accredited and approved according to ISO/IEC 17025.

If you have any comments, please feel free to contact us at the following:

Linko EMC/RF Lab

Tel: 886-2-26052180

Fax: 886-2-26051924

Hsin Chu EMC/RF/Telecom Lab

Tel: 886-3-6668565

Fax: 886-3-6668323

Hwa Ya EMC/RF/Safety Lab

Tel: 886-3-3183232

Fax: 886-3-3270892

Email: service.adt@tw.bureauveritas.com

Web Site: www.bureauveritas-adt.com

The address and road map of all our labs can be found in our web site also.

--- END ---