

FCC SAR Test Report

APPLICANT : Getac Technology Corporation.
EQUIPMENT : WLAN module
BRAND NAME : Getac
MODEL NAME : 7265NGW
FCC ID : QYL7265NG
STANDARD : FCC 47 CFR Part 2 (2.1093)
ANSI/IEEE C95.1-1992
IEEE 1528-2003

The product was installed into Tablet (Brand Name: Getac, Model Name: RX10) during test.

We, SPORTON INTERNATIONAL INC., would like to declare that the tested sample has been evaluated in accordance with the procedures and had been in compliance with the applicable technical standards.

The test results in this report apply exclusively to the tested model / sample. Without written approval of SPORTON INTERNATIONAL INC., the test report shall not be reproduced except in full.

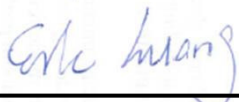

Reviewed by: Eric Huang / Deputy Manager



Approved by: Jones Tsai / Manager



SPORTON INTERNATIONAL INC.

No.52, Hwa Ya 1st Rd., Hwa Ya Technology Park, Kwei-Shan District, Taoyuan City, Taiwan (R.O.C.)



Table of Contents

1. Statement of Compliance 4

2. Administration Data 4

3. Guidance Standard 5

4. Equipment Under Test (EUT) 5

 4.1 General Information 5

5. RF Exposure Limits..... 6

 5.1 Uncontrolled Environment..... 6

 5.2 Controlled Environment..... 6

6. Specific Absorption Rate (SAR)..... 7

 6.1 Introduction 7

 6.2 SAR Definition..... 7

7. System Description and Setup 8

 7.1 E-Field Probe 9

 7.2 Data Acquisition Electronics (DAE) 9

 7.3 Phantom.....10

 7.4 Device Holder.....11

8. Measurement Procedures12

 8.1 Spatial Peak SAR Evaluation.....12

 8.2 Power Reference Measurement.....13

 8.3 Area Scan13

 8.4 Zoom Scan.....14

 8.5 Volume Scan Procedures.....14

 8.6 Power Drift Monitoring.....14

9. Test Equipment List15

10. System Verification16

 10.1 Tissue Verification16

 10.2 System Performance Check Results.....17

11. RF Exposure Positions17

 11.1 SAR Testing for Tablet17

12. Conducted RF Output Power (Unit: dBm).....18

13. Bluetooth Exclusions Applied27

14. Antenna Location28

15. SAR Test Results30

 15.1 Body SAR30

16. Simultaneous Transmission Analysis31

 16.1 Body Exposure Conditions31

17. Uncertainty Assessment32

18. References35

Appendix A. Plots of System Performance Check

Appendix B. Plots of High SAR Measurement

Appendix C. DASY Calibration Certificate

Appendix D. Test Setup Photos



Revision History

REPORT NO.	VERSION	DESCRIPTION	ISSUED DATE
FA570164-22	Rev. 01	Variant report to include verification of worst case found in the original report (Sporton Report No. FA570164-02) performed testing for WLAN Antenna A and full test for WLAN Antenna B and the difference which can be referred to class II Permissive Change declaration.	Aug. 17, 2016

1. Statement of Compliance

The maximum results of Specific Absorption Rate (SAR) found during testing for Getac Technology Corporation., WLAN module, 7265NGW, are as follows.

Equipment Class	Frequency Band	Highest SAR Summary	
		Body (Separation 0mm)	Highest Simultaneous Transmission 1g SAR (W/kg)
		1g SAR (W/kg)	
DTS	2.4GHz WLAN	0.28	0.31
NII	5GHz WLAN	0.43	0.53
Date of Testing:		2016/7/27	

This device is in compliance with Specific Absorption Rate (SAR) for general population/uncontrolled exposure limits (1.6 W/kg) specified in FCC 47 CFR part 2 (2.1093) and ANSI/IEEE C95.1-1992, and had been tested in accordance with the measurement methods and procedures specified in IEEE 1528-2013 and FCC KDB publications

2. Administration Data

Testing Laboratory	
Test Site	SPORTON INTERNATIONAL INC.
Test Site Location	No.52, Hwa Ya 1st Rd., Hwa Ya Technology Park, Kwei-Shan District, Taoyuan City, Taiwan (R.O.C.) TEL: +886-3-327-3456 FAX: +886-3-328-4978

Applicant	
Company Name	Getac Technology Corporation.
Address	5F., Building A, No. 209, Sec.1, Nangang Rd.,Nangang Dist., Taipei City 11568, Taiwan, R.O.C.

Manufacturer	
Company Name	Intel Mobile Communications
Address	100 Center Point Circle, Suite 200, Columbia, South Carolina 29210 USA

3. Guidance Standard

The Specific Absorption Rate (SAR) testing specification, method, and procedure for this device is in accordance with the following standards:

- FCC 47 CFR Part 2 (2.1093)
- ANSI/IEEE C95.1-1992
- IEEE 1528-2013
- FCC KDB 865664 D01 SAR Measurement 100 MHz to 6 GHz v01r04
- FCC KDB 865664 D02 SAR Reporting v01r02
- FCC KDB 447498 D01 General RF Exposure Guidance v06
- FCC KDB 248227 D01 802.11 Wi-Fi SAR v02r02
- FCC KDB 616217 D04 SAR for laptop and tablets v01r02

4. Equipment Under Test (EUT)

4.1 General Information

Product Feature & Specification	
Equipment Name	WLAN module
Brand Name	Getac
Model Name	7265NGW
FCC ID	QYL7265NG
Wireless Technology and Frequency Range	WLAN 2.4GHz Band: 2412 MHz ~ 2462 MHz WLAN 5.2GHz Band: 5180 MHz ~ 5240 MHz WLAN 5.3GHz Band: 5260 MHz ~ 5320 MHz WLAN 5.5GHz Band: 5500 MHz ~ 5700 MHz WLAN 5.8GHz Band: 5745 MHz ~ 5825 MHz Bluetooth: 2402 MHz ~ 2480 MHz
Mode	• 802.11a/b/g/n/ac HT20/HT40/VHT20/VHT40/VHT80 • Bluetooth v3.0+EDR, Bluetooth v4.0-LE
EUT Stage	Production Unit

Host Information	
Host Name	Tablet
Brand Name	Getac
Model Name	RX10
Mode	• NFC



5. RF Exposure Limits

5.1 Uncontrolled Environment

Uncontrolled Environments are defined as locations where there is the exposure of individuals who have no knowledge or control of their exposure. The general population/uncontrolled exposure limits are applicable to situations in which the general public may be exposed or in which persons who are exposed as a consequence of their employment may not be made fully aware of the potential for exposure or cannot exercise control over their exposure. Members of the general public would come under this category when exposure is not employment-related; for example, in the case of a wireless transmitter that exposes persons in its vicinity.

5.2 Controlled Environment

Controlled Environments are defined as locations where there is exposure that may be incurred by persons who are aware of the potential for exposure, (i.e. as a result of employment or occupation). In general, occupational/controlled exposure limits are applicable to situations in which persons are exposed as a consequence of their employment, who have been made fully aware of the potential for exposure and can exercise control over their exposure. The exposure category is also applicable when the exposure is of a transient nature due to incidental passage through a location where the exposure levels may be higher than the general population/uncontrolled limits, but the exposed person is fully aware of the potential for exposure and can exercise control over his or her exposure by leaving the area or by some other appropriate means.

Limits for Occupational/Controlled Exposure (W/kg)

Whole-Body	Partial-Body	Hands, Wrists, Feet and Ankles
0.4	8.0	20.0

Limits for General Population/Uncontrolled Exposure (W/kg)

Whole-Body	Partial-Body	Hands, Wrists, Feet and Ankles
0.08	1.6	4.0

1. Whole-Body SAR is averaged over the entire body, partial-body SAR is averaged over any 1gram of tissue defined as a tissue volume in the shape of a cube. SAR for hands, wrists, feet and ankles is averaged over any 10 grams of tissue defined as a tissue volume in the shape of a cube.

6. Specific Absorption Rate (SAR)

6.1 Introduction

SAR is related to the rate at which energy is absorbed per unit mass in an object exposed to a radio field. The SAR distribution in a biological body is complicated and is usually carried out by experimental techniques or numerical modeling. The standard recommends limits for two tiers of groups, occupational/controlled and general population/uncontrolled, based on a person's awareness and ability to exercise control over his or her exposure. In general, occupational/controlled exposure limits are higher than the limits for general population/uncontrolled.

6.2 SAR Definition

The SAR definition is the time derivative (rate) of the incremental energy (dW) absorbed by (dissipated in) an incremental mass (dm) contained in a volume element (dv) of a given density (ρ). The equation description is as below:

$$SAR = \frac{d}{dt} \left(\frac{dW}{dm} \right) = \frac{d}{dt} \left(\frac{dW}{\rho dv} \right)$$

SAR is expressed in units of Watts per kilogram (W/kg)

$$SAR = \frac{\sigma |E|^2}{\rho}$$

Where: σ is the conductivity of the tissue, ρ is the mass density of the tissue and E is the RMS electrical field strength.

7. System Description and Setup

The DASY system used for performing compliance tests consists of the following items:

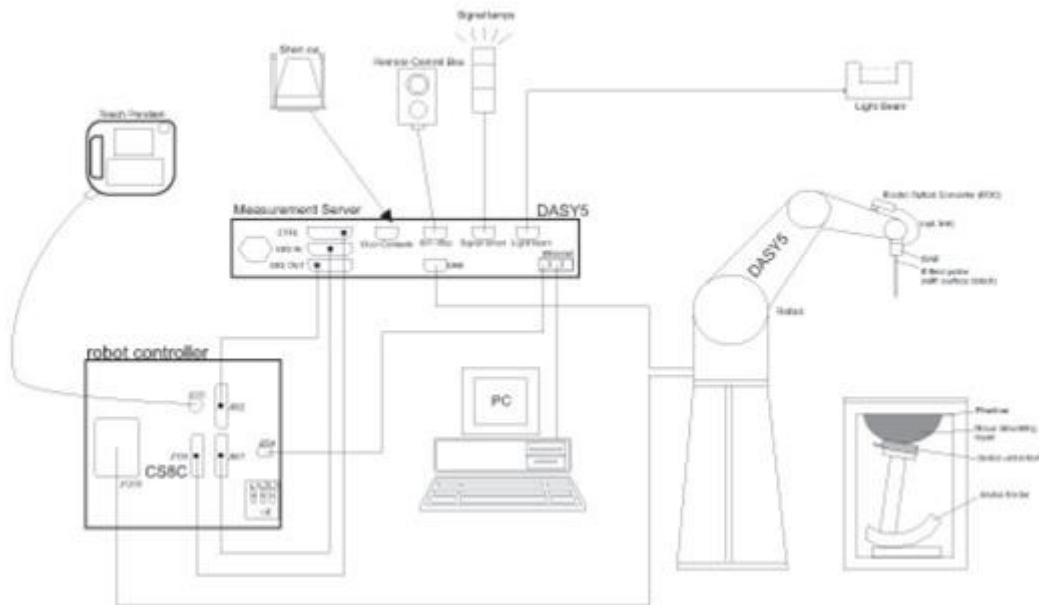

- A standard high precision 6-axis robot with controller, teach pendant and software. An arm extension for accommodating the data acquisition electronics (DAE).
- An isotropic Field probe optimized and calibrated for the targeted measurement.
- A data acquisition electronics (DAE) which performs the signal amplification, signal multiplexing, AD-conversion, offset measurements, mechanical surface detection, collision detection, etc. The unit is battery powered with standard or rechargeable batteries. The signal is optically transmitted to the EOC.
- The Electro-optical converter (EOC) performs the conversion from optical to electrical signals for the digital communication to the DAE. To use optical surface detection, a special version of the EOC is required. The EOC signal is transmitted to the measurement server.
- The function of the measurement server is to perform the time critical tasks such as signal filtering, control of the robot operation and fast movement interrupts.
- The Light Beam used is for probe alignment. This improves the (absolute) accuracy of the probe positioning.
- A computer running WinXP or Win7 and the DASY5 software.
- Remote control and teach pendant as well as additional circuitry for robot safety such as warning lamps, etc.
- The phantom, the device holder and other accessories according to the targeted measurement.

7.1 E-Field Probe

The SAR measurement is conducted with the dosimetric probe (manufactured by SPEAG). The probe is specially designed and calibrated for use in liquid with high permittivity. The dosimetric probe has special calibration in liquid at different frequency. This probe has a built in optical surface detection system to prevent from collision with phantom.

<ES3DV3 Probe>

Construction	Symmetric design with triangular core Interleaved sensors Built-in shielding against static charges PEEK enclosure material (resistant to organic solvents, e.g., DGBE)	
Frequency	10 MHz – 4 GHz; Linearity: ± 0.2 dB (30 MHz – 4 GHz)	
Directivity	± 0.2 dB in TSL (rotation around probe axis) ± 0.3 dB in TSL (rotation normal to probe axis)	
Dynamic Range	5 μ W/g – >100 mW/g; Linearity: ± 0.2 dB	
Dimensions	Overall length: 337 mm (tip: 20 mm) Tip diameter: 3.9 mm (body: 12 mm) Distance from probe tip to dipole centers: 3.0 mm	

<EX3DV4 Probe>

Construction	Symmetric design with triangular core Built-in shielding against static charges PEEK enclosure material (resistant to organic solvents, e.g., DGBE)	
Frequency	10 MHz – >6 GHz Linearity: ± 0.2 dB (30 MHz – 6 GHz)	
Directivity	± 0.3 dB in TSL (rotation around probe axis) ± 0.5 dB in TSL (rotation normal to probe axis)	
Dynamic Range	10 μ W/g – >100 mW/g Linearity: ± 0.2 dB (noise: typically <1 μ W/g)	
Dimensions	Overall length: 337 mm (tip: 20 mm) Tip diameter: 2.5 mm (body: 12 mm) Typical distance from probe tip to dipole centers: 1 mm	

7.2 Data Acquisition Electronics (DAE)

The data acquisition electronics (DAE) consists of a highly sensitive electrometer-grade preamplifier with auto-zeroing, a channel and gain-switching multiplexer, a fast 16 bit AD-converter and a command decoder and control logic unit. Transmission to the measurement server is accomplished through an optical downlink for data and status information as well as an optical uplink for commands and the clock.

The input impedance of the DAE is 200 MOhm; the inputs are symmetrical and floating. Common mode rejection is above 80 dB.



Fig 5.1 Photo of DAE

7.3 Phantom

<SAM Twin Phantom>

Shell Thickness	2 ± 0.2 mm; Center ear point: 6 ± 0.2 mm	
Filling Volume	Approx. 25 liters	
Dimensions	Length: 1000 mm; Width: 500 mm; Height: adjustable feet	
Measurement Areas	Left Hand, Right Hand, Flat Phantom	

The bottom plate contains three pair of bolts for locking the device holder. The device holder positions are adjusted to the standard measurement positions in the three sections. A white cover is provided to tap the phantom during off-periods to prevent water evaporation and changes in the liquid parameters. On the phantom top, three reference markers are provided to identify the phantom position with respect to the robot.

<ELI Phantom>

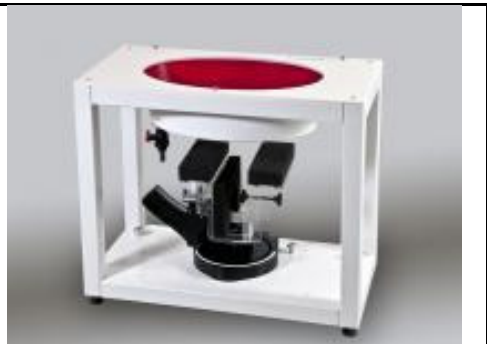
Shell Thickness	2 ± 0.2 mm (sagging: <1%)	
Filling Volume	Approx. 30 liters	
Dimensions	Major ellipse axis: 600 mm Minor axis: 400 mm	

The ELI phantom is intended for compliance testing of handheld and body-mounted wireless devices in the frequency range of 30 MHz to 6 GHz. ELI4 is fully compatible with standard and all known tissue simulating liquids.

7.4 Device Holder

<Mounting Device for Hand-Held Transmitter>

In combination with the Twin SAM V5.0/V5.0c or ELI phantoms, the Mounting Device for Hand-Held Transmitters enables rotation of the mounted transmitter device to specified spherical coordinates. At the heads, the rotation axis is at the ear opening. Transmitter devices can be easily and accurately positioned according to IEC 62209-1, IEEE 1528, FCC, or other specifications. The device holder can be locked for positioning at different phantom sections (left head, right head, flat). And upgrade kit to Mounting Device to enable easy mounting of wider devices like big smart-phones, e-books, small tablets, etc. It holds devices with width up to 140 mm.



Mounting Device for Hand-Held Transmitters



Mounting Device Adaptor for Wide-Phones

<Mounting Device for Laptops and other Body-Worn Transmitters>

The extension is lightweight and made of POM, acrylic glass and foam. It fits easily on the upper part of the mounting device in place of the phone positioned. The extension is fully compatible with the SAM Twin and ELI phantoms.



Mounting Device for Laptops

8. Measurement Procedures

The measurement procedures are as follows:

<Conducted power measurement>

- (a) For WWAN power measurement, use base station simulator to configure EUT WWAN transmission in conducted connection with RF cable, at maximum power in each supported wireless interface and frequency band.
- (b) Read the WWAN RF power level from the base station simulator.
- (c) For WLAN/BT power measurement, use engineering software to configure EUT WLAN/BT continuously transmission, at maximum RF power in each supported wireless interface and frequency band
- (d) Connect EUT RF port through RF cable to the power meter, and measure WLAN/BT output power

<SAR measurement>

- (a) Use base station simulator to configure EUT WWAN transmission in radiated connection, and engineering software to configure EUT WLAN/BT continuously transmission, at maximum RF power, in the highest power channel.
- (b) Place the EUT in the positions as Appendix D demonstrates.
- (c) Set scan area, grid size and other setting on the DASY software.
- (d) Measure SAR results for the highest power channel on each testing position.
- (e) Find out the largest SAR result on these testing positions of each band
- (f) Measure SAR results for other channels in worst SAR testing position if the reported SAR of highest power channel is larger than 0.8 W/kg

According to the test standard, the recommended procedure for assessing the peak spatial-average SAR value consists of the following steps:

- (a) Power reference measurement
- (b) Area scan
- (c) Zoom scan
- (d) Power drift measurement

8.1 Spatial Peak SAR Evaluation

The procedure for spatial peak SAR evaluation has been implemented according to the test standard. It can be conducted for 1g and 10g, as well as for user-specific masses. The DASY software includes all numerical procedures necessary to evaluate the spatial peak SAR value.

The base for the evaluation is a "cube" measurement. The measured volume must include the 1g and 10g cubes with the highest averaged SAR values. For that purpose, the center of the measured volume is aligned to the interpolated peak SAR value of a previously performed area scan.

The entire evaluation of the spatial peak values is performed within the post-processing engine (SEMCAD). The system always gives the maximum values for the 1g and 10g cubes. The algorithm to find the cube with highest averaged SAR is divided into the following stages:

- (a) Extraction of the measured data (grid and values) from the Zoom Scan
- (b) Calculation of the SAR value at every measurement point based on all stored data (A/D values and measurement parameters)
- (c) Generation of a high-resolution mesh within the measured volume
- (d) Interpolation of all measured values from the measurement grid to the high-resolution grid
- (e) Extrapolation of the entire 3-D field distribution to the phantom surface over the distance from sensor to surface
- (f) Calculation of the averaged SAR within masses of 1g and 10g

8.2 Power Reference Measurement

The Power Reference Measurement and Power Drift Measurements are for monitoring the power drift of the device under test in the batch process. The minimum distance of probe sensors to surface determines the closest measurement point to phantom surface. This distance cannot be smaller than the distance of sensor calibration points to probe tip as defined in the probe properties.

8.3 Area Scan

The area scan is used as a fast scan in two dimensions to find the area of high field values, before doing a fine measurement around the hot spot. The sophisticated interpolation routines implemented in DASY software can find the maximum found in the scanned area, within a range of the global maximum. The range (in dB0) is specified in the standards for compliance testing. For example, a 2 dB range is required in IEEE standard 1528 and IEC 62209 standards, whereby 3 dB is a requirement when compliance is assessed in accordance with the ARIB standard (Japan), if only one zoom scan follows the area scan, then only the absolute maximum will be taken as reference. For cases where multiple maximums are detected, the number of zoom scans has to be increased accordingly.

Area scan parameters extracted from FCC KDB 865664 D01v01r04 SAR measurement 100 MHz to 6 GHz.

	≤ 3 GHz	> 3 GHz
Maximum distance from closest measurement point (geometric center of probe sensors) to phantom surface	5 ± 1 mm	$\frac{1}{2} \cdot \delta \cdot \ln(2) \pm 0.5$ mm
Maximum probe angle from probe axis to phantom surface normal at the measurement location	30° ± 1°	20° ± 1°
Maximum area scan spatial resolution: $\Delta x_{Area}, \Delta y_{Area}$	≤ 2 GHz: ≤ 15 mm 2 – 3 GHz: ≤ 12 mm	3 – 4 GHz: ≤ 12 mm 4 – 6 GHz: ≤ 10 mm
	When the x or y dimension of the test device, in the measurement plane orientation, is smaller than the above, the measurement resolution must be ≤ the corresponding x or y dimension of the test device with at least one measurement point on the test device.	

8.4 Zoom Scan

Zoom scans are used assess the peak spatial SAR values within a cubic averaging volume containing 1 gram and 10 gram of simulated tissue. The zoom scan measures points (refer to table below) within a cube shoes base faces are centered on the maxima found in a preceding area scan job within the same procedure. When the measurement is done, the zoom scan evaluates the averaged SAR for 1 gram and 10 gram and displays these values next to the job's label.

Zoom scan parameters extracted from FCC KDB 865664 D01v01r04 SAR measurement 100 MHz to 6 GHz.

		≤ 3 GHz	> 3 GHz	
Maximum zoom scan spatial resolution: $\Delta x_{Zoom}, \Delta y_{Zoom}$		≤ 2 GHz: ≤ 8 mm 2 – 3 GHz: ≤ 5 mm*	3 – 4 GHz: ≤ 5 mm* 4 – 6 GHz: ≤ 4 mm*	
Maximum zoom scan spatial resolution, normal to phantom surface	uniform grid: $\Delta z_{Zoom}(n)$	≤ 5 mm	3 – 4 GHz: ≤ 4 mm 4 – 5 GHz: ≤ 3 mm 5 – 6 GHz: ≤ 2 mm	
	graded grid	$\Delta z_{Zoom}(1)$: between 1 st two points closest to phantom surface	≤ 4 mm	3 – 4 GHz: ≤ 3 mm 4 – 5 GHz: ≤ 2.5 mm 5 – 6 GHz: ≤ 2 mm
		$\Delta z_{Zoom}(n>1)$: between subsequent points	$\leq 1.5 \cdot \Delta z_{Zoom}(n-1)$	
Minimum zoom scan volume	x, y, z	≥ 30 mm	3 – 4 GHz: ≥ 28 mm 4 – 5 GHz: ≥ 25 mm 5 – 6 GHz: ≥ 22 mm	
Note: δ is the penetration depth of a plane-wave at normal incidence to the tissue medium; see draft standard IEEE P1528-2011 for details. * When zoom scan is required and the <i>reported</i> SAR from the <i>area scan based 1-g SAR estimation</i> procedures of KDB 447498 is ≤ 1.4 W/kg, ≤ 8 mm, ≤ 7 mm and ≤ 5 mm zoom scan resolution may be applied, respectively, for 2 GHz to 3 GHz, 3 GHz to 4 GHz and 4 GHz to 6 GHz.				

8.5 Volume Scan Procedures

The volume scan is used for assess overlapping SAR distributions for antennas transmitting in different frequency bands. It is equivalent to an oversized zoom scan used in standalone measurements. The measurement volume will be used to enclose all the simultaneous transmitting antennas. For antennas transmitting simultaneously in different frequency bands, the volume scan is measured separately in each frequency band. In order to sum correctly to compute the 1g aggregate SAR, the EUT remain in the same test position for all measurements and all volume scan use the same spatial resolution and grid spacing. When all volume scan were completed, the software, SEMCAD postprocessor can combine and subsequently superpose these measurement data to calculating the multiband SAR.

8.6 Power Drift Monitoring

All SAR testing is under the EUT install full charged battery and transmit maximum output power. In DASy measurement software, the power reference measurement and power drift measurement procedures are used for monitoring the power drift of EUT during SAR test. Both these procedures measure the field at a specified reference position before and after the SAR testing. The software will calculate the field difference in dB. If the power drifts more than 5%, the SAR will be retested.



9. Test Equipment List

Manufacturer	Name of Equipment	Type/Model	Serial Number	Calibration	
				Last Cal.	Due Date
SPEAG	2450MHz System Validation Kit	D2450V2	736	Aug. 20, 2015	Aug. 19, 2016
SPEAG	5GHz System Validation Kit	D5GHzV2	1006	Oct. 06, 2015	Oct. 05, 2016
SPEAG	Data Acquisition Electronics	DAE3	577	Sep. 24, 2015	Sep. 23, 2016
SPEAG	Dosimetric E-Field Probe	EX3DV4	3931	Oct. 01, 2015	Sep. 30, 2016
Wisewind	Thermometer	HTC-1	TM225	Oct. 16, 2015	Oct. 15, 2016
Anritsu	Radio Communication Analyzer	MT8820C	6201381760	May. 10, 2016	May. 09, 2017
Agilent	Wireless Communication Test Set	E5515C	MY50266977	May. 17, 2016	May. 16, 2017
SPEAG	Device Holder	N/A	N/A	N/A	N/A
R&S	Signal Generator	MG3710A	6201502524	Dec. 18, 2015	Dec. 17, 2016
Agilent	ENA Network Analyzer	E5071C	MY46316648	Jan. 12, 2016	Jan. 11, 2017
SPEAG	Dielectric Probe Kit	DAKS-3.5	0004	Mar. 23, 2016	Mar. 22, 2017
LINE SEIKI	Digital Thermometer	LKMelectronic	DTM3000SPEZIAL/90900	Aug. 26, 2015	Aug. 25, 2016
Anritsu	Power Meter	ML2495A	1419002	May. 10, 2016	May. 09, 2017
Anritsu	Power Sensor	MA2411B	1339124	May. 10, 2016	May. 09, 2017
Agilent	Spectrum Analyzer	E4408B	MY44211028	Aug. 24, 2015	Aug. 23, 2016
ATM	Dual Directional Coupler	C122H-10	P610410z-02	Note 1	
Woken	Attenuator 1	WK0602-XX	N/A	Note 1	
PE	Attenuator 2	PE7005-10	N/A	Note 1	
PE	Attenuator 3	PE7005-3	N/A	Note 1	
AR	Power Amplifier	5S1G4M2	0328767	Note 1	
Mini-Circuits	Power Amplifier	ZVE-3W	162601250	Note 1	

General Note:

1. Prior to system verification and validation, the path loss from the signal generator to the system check source and the power meter, which includes the amplifier, cable, attenuator and directional coupler, was measured by the network analyzer. The reading of the power meter was offset by the path loss difference between the path to the power meter and the path to the system check source to monitor the actual power level fed to the system check source.



10. System Verification

10.1 Tissue Verification

The following tissue formulations are provided for reference only as some of the parameters have not been thoroughly verified. The composition of ingredients may be modified accordingly to achieve the desired target tissue parameters required for routine SAR evaluation.

Frequency (MHz)	Water (%)	Sugar (%)	Cellulose (%)	Salt (%)	Preventol (%)	DGBE (%)	Conductivity (σ)	Permittivity (ϵ_r)
For Head								
750	41.1	57.0	0.2	1.4	0.2	0	0.89	41.9
835	40.3	57.9	0.2	1.4	0.2	0	0.90	41.5
900	40.3	57.9	0.2	1.4	0.2	0	0.97	41.5
1800, 1900, 2000	55.2	0	0	0.3	0	44.5	1.40	40.0
2450	55.0	0	0	0	0	45.0	1.80	39.2
2600	54.8	0	0	0.1	0	45.1	1.96	39.0
For Body								
750	51.7	47.2	0	0.9	0.1	0	0.96	55.5
835	50.8	48.2	0	0.9	0.1	0	0.97	55.2
900	50.8	48.2	0	0.9	0.1	0	1.05	55.0
1800, 1900, 2000	70.2	0	0	0.4	0	29.4	1.52	53.3
2450	68.6	0	0	0	0	31.4	1.95	52.7
2600	68.1	0	0	0.1	0	31.8	2.16	52.5

Simulating Liquid for 5GHz, Manufactured by SPEAG

Ingredients	(% by weight)
Water	64~78%
Mineral oil	11~18%
Emulsifiers	9~15%
Additives and Salt	2~3%

<Tissue Dielectric Parameter Check Results>

Frequency (MHz)	Tissue Type	Liquid Temp. (°C)	Conductivity (σ)	Permittivity (ϵ_r)	Conductivity Target (σ)	Permittivity Target (ϵ_r)	Delta (σ) (%)	Delta (ϵ_r) (%)	Limit (%)	Date
2450	MSL	22.5	1.919	53.745	1.95	52.70	-1.59	1.98	±5	2016/7/27
5200	MSL	22.6	5.207	46.906	5.30	49.00	-1.75	-4.27	±5	2016/7/27
5300	MSL	22.6	5.331	46.739	5.42	48.90	-1.64	-4.42	±5	2016/7/27
5600	MSL	22.6	5.706	46.276	5.77	48.50	-1.11	-4.59	±5	2016/7/27
5800	MSL	22.6	5.967	45.983	6.00	48.20	-0.55	-4.60	±5	2016/7/27

10.2 System Performance Check Results

Comparing to the original SAR value provided by SPEAG, the verification data should be within its specification of 10 %. Below table shows the target SAR and measured SAR after normalized to 1W input power. The table below indicates the system performance check can meet the variation criterion and the plots can be referred to Appendix A of this report.

Date	Frequency (MHz)	Tissue Type	Input Power (mW)	Dipole S/N	Probe S/N	DAE S/N	Measured 1g SAR (W/kg)	Targeted 1g SAR (W/kg)	Normalized 1g SAR (W/kg)	Deviation (%)
2016/7/27	2450	MSL	250	D2450V2-736	EX3DV4 - SN3931	DAE3 Sn577	12.50	51.90	50.00	-3.66
2016/7/27	5200	MSL	100	D5GHzV2-1006-5200	EX3DV4 - SN3931	DAE3 Sn577	8.13	75.60	81.30	7.54
2016/7/27	5300	MSL	100	D5GHzV2-1006-5300	EX3DV4 - SN3931	DAE3 Sn577	8.48	79.50	84.80	6.67
2016/7/27	5600	MSL	100	D5GHzV2-1006-5600	EX3DV4 - SN3931	DAE3 Sn577	8.85	82.30	88.50	7.53
2016/7/27	5800	MSL	100	D5GHzV2-1006-5800	EX3DV4 - SN3931	DAE3 Sn577	7.30	79.00	73.00	-7.59

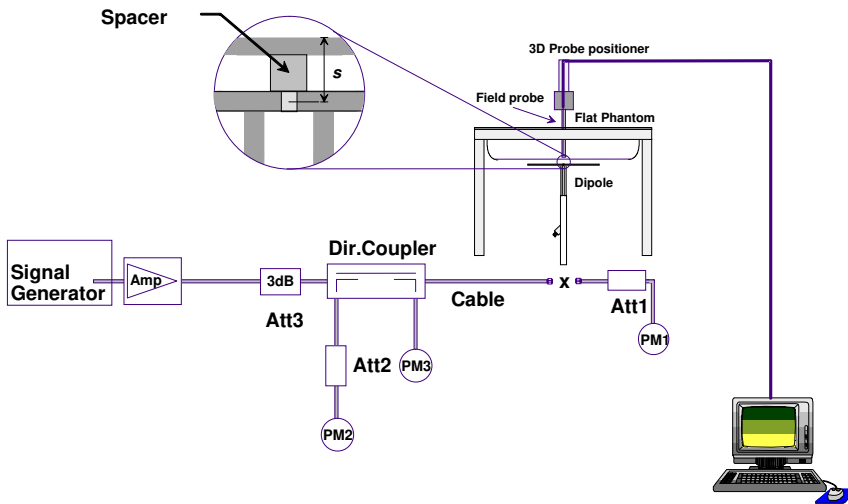

Fig 8.3.1 System Performance Check Setup



Fig 8.3.2 Setup Photo

11. RF Exposure Positions

11.1 SAR Testing for Tablet

This device can be used also in full sized tablet exposure conditions, due to its size. Per FCC KDB 616217, the back surface and edges of the tablet should be tested for SAR compliance with the tablet touching the phantom. The SAR exclusion threshold in KDB 447498 D01v06 can be applied to determine SAR test exclusion for adjacent edge configurations. The closest distance from the antenna to an adjacent tablet edge is used to determine if SAR testing is required for the adjacent edges, with the adjacent edge positioned against the phantom and the edge containing the antenna positioned perpendicular to the phantom.



12. Conducted RF Output Power (Unit: dBm)

<WLAN Conducted Power>

General Note:

1. For WLAN SAR testing was performed on single antenna RF power in SISO mode is larger or equal to the single antenna RF power in MIMO mode, and for RF exposure assessment of MIMO mode simultaneous transmission exclusion analysis was performed with SAR test results of each antenna in SISO mode.
2. Per KDB 248227 D01v02r02, the simultaneous SAR provisions in KDB publication 447498 should be applied to determine simultaneous transmission SAR test exclusion for WiFi MIMO. If the sum of 1g single transmission chain SAR measurements is < 1.6W/kg and SAR peak to location ratio < 0.04, no additional SAR measurements for MIMO.
3. Per KDB 248227 D01v02r02, SAR test reduction is determined according to 802.11 transmission mode configurations and certain exposure conditions with multiple test positions. In the 2.4 GHz band, separate SAR procedures are applied to DSSS and OFDM configurations to simplify DSSS test requirements. For OFDM, in both 2.4 and 5 GHz bands, an initial test configuration must be determined for each standalone and aggregated frequency band, according to the transmission mode configuration with the highest maximum output power specified for production units to perform SAR measurements. If the same highest maximum output power applies to different combinations of channel bandwidths, modulations and data rates, additional procedures are applied to determine which test configurations require SAR measurement. When applicable, an initial test position may be applied to reduce the number of SAR measurements required for next to the ear, UMPC mini-tablet or hotspot mode configurations with multiple test positions.
4. For 2.4 GHz 802.11b DSSS, either the initial test position procedure for multiple exposure test positions or the DSSS procedure for fixed exposure position is applied; these are mutually exclusive. For 2.4 GHz and 5 GHz OFDM configurations, the initial test configuration is applied to measure SAR using either the initial test position procedure for multiple exposure test position configurations or the initial test configuration procedures for fixed exposure test conditions. Based on the reported SAR of the measured configurations and maximum output power of the transmission mode configurations that are not included in the initial test configuration, the subsequent test configuration and initial test position procedures are applied to determine if SAR measurements are required for the remaining OFDM transmission configurations. In general, the number of test channels that require SAR measurement is minimized based on maximum output power measured for the test sample(s).
5. For OFDM transmission configurations in the 2.4 GHz and 5 GHz bands, When the same maximum power is specified for multiple transmission modes in a frequency band, the largest channel bandwidth, lowest order modulation, lowest data rate and lowest order 802.11a/g/n/ac mode is used for SAR measurement, on the highest measured output power channel for each frequency band.
6. DSSS and OFDM configurations are considered separately according to the required SAR procedures. SAR is measured in the initial test position using the 802.11 transmission mode configuration required by the DSSS procedure or initial test configuration and subsequent test configuration(s) according to the OFDM procedures.¹⁸ The initial test position procedure is described in the following:
 - a. When the reported SAR of the initial test position is ≤ 0.4 W/kg, further SAR measurement is not required for the other test positions in that exposure configuration and 802.11 transmission mode combinations within the frequency band or aggregated band.
 - b. When the reported SAR of the test position is > 0.4 W/kg, SAR is repeated for the 802.11 transmission mode configuration tested in the initial test position to measure the subsequent next closet/smallest test separation distance and maximum coupling test position on the highest maximum output power channel, until the report SAR is ≤ 0.8 W/kg or all required test position are tested.
 - c. For all positions/configurations, when the reported SAR is > 0.8 W/kg, SAR is measured for these test positions/configurations on the subsequent next highest measured output power channel(s) until the reported SAR is ≤ 1.2 W/kg or all required channels are tested.

<2.4GHz WLAN Antenna A>

	Mode	Channel	Frequency (MHz)	Data Rate	Average power (dBm)	Duty Cycle %
2.4GHz WLAN Antenna A	802.11b	CH 1	2412	1Mbps	15.90	98.96
		CH 6	2437		17.20	
		CH 11	2462		16.49	
	802.11g	CH 1	2412	6Mbps	13.82	98.57
		CH 6	2437		17.10	
		CH 11	2462		12.11	
	802.11n-HT20	CH 1	2412	MCS0	13.74	98.47
		CH 6	2437		17.17	
		CH 11	2462		12.11	
	802.11n-HT40	CH 3	2422	MCS0	13.07	97.53
		CH 6	2437		17.17	
		CH 9	2452		12.06	

<2.4GHz WLAN Antenna B>

	Mode	Channel	Frequency (MHz)	Data Rate	Average power (dBm)	Duty Cycle %
2.4GHz WLAN Antenna B	802.11b	CH 1	2412	1Mbps	16.19	98.96
		CH 6	2437		17.16	
		CH 11	2462		16.05	
	802.11g	CH 1	2412	6Mbps	14.32	99.04
		CH 6	2437		17.49	
		CH 11	2462		12.41	
	802.11n-HT20	CH 1	2412	MCS0	14.23	98.46
		CH 6	2437		17.48	
		CH 11	2462		12.17	
	802.11n-HT40	CH 3	2422	MCS0	13.47	97.53
		CH 6	2437		17.29	
		CH 9	2452		11.27	

<2.4GHz WLAN Antenna A+B>

	Mode	Channel	Frequency (MHz)	Data Rate	Average power (dBm)	Duty Cycle %
2.4GHz WLAN Antenna A+B	802.11n-HT20	CH 1	2412	MCS0	14.81	96.82
		CH 6	2437		19.99	
		CH 11	2462		14.96	
	802.11n-HT40	CH 3	2422	MCS0	12.47	95.13
		CH 6	2437		16.44	
		CH 9	2452		12.28	



<5GHz WLAN Antenna A>

	Mode	Channel	Frequency (MHz)	Data Rate	Average power (dBm)	Duty Cycle %
5.2GHz WLAN Antenna A	802.11a	CH 36	5180	6Mbps	13.83	98.47
		CH 40	5200		14.31	
		CH 44	5220		14.38	
		CH 48	5240		14.34	
	802.11n-HT20	CH 36	5180	MCS0	13.62	98.36
		CH 40	5200		13.63	
		CH 44	5220		14.25	
		CH 48	5240		14.20	
	802.11n-HT40	CH 38	5190	MCS0	11.49	96.94
		CH 46	5230		16.26	
	802.11ac-VHT20	CH 36	5180	MCS0	13.70	98.37
		CH 40	5200		13.99	
		CH 44	5220		14.03	
		CH 48	5240		14.50	
802.11ac-VHT40	CH 38	5190	MCS0	11.42	96.97	
	CH 46	5230		16.11		
802.11ac-VHT80	CH 42	5210	MCS0	13.49	93.67	

	Mode	Channel	Frequency (MHz)	Data Rate	Average power (dBm)	Duty Cycle %
5.3GHz WLAN Antenna A	802.11a	CH 52	5260	6Mbps	15.21	98.47
		CH 56	5280		15.14	
		CH 60	5300		15.17	
		CH 64	5320		12.95	
	802.11n-HT20	CH 52	5260	MCS0	15.18	98.36
		CH 56	5280		15.23	
		CH 60	5300		15.48	
		CH 64	5320		13.14	
	802.11n-HT40	CH 54	5270	MCS0	16.05	96.94
		CH 62	5310		13.14	
	802.11ac-VHT20	CH 52	5260	MCS0	15.08	98.37
		CH 56	5280		15.41	
		CH 60	5300		15.45	
		CH 64	5320		13.03	
802.11ac-VHT40	CH 54	5270	MCS0	16.05	96.97	
	CH 62	5310		13.04		
802.11ac-VHT80	CH 58	5290	MCS0	13.00	93.67	



	Mode	Channel	Frequency (MHz)	Data Rate	Average power (dBm)	Duty Cycle %
5.5GHz WLAN Antenna A	802.11a	CH 100	5500	6Mbps	13.50	98.47
		CH 116	5580		15.25	
		CH 124	5620		15.12	
		CH 132	5660		15.19	
		CH 144	5720		15.14	
	802.11n-HT20	CH 100	5500	MCS0	13.01	98.36
		CH 116	5580		15.41	
		CH 124	5620		15.21	
		CH 132	5660		15.31	
		CH 144	5720		15.14	
	802.11n-HT40	CH 102	5510	MCS0	13.01	96.94
		CH 110	5550		15.94	
		CH 126	5630		15.93	
		CH 134	5670		15.94	
		CH 142	5710		15.48	
	802.11ac-VHT20	CH 100	5500	MCS0	13.24	98.37
		CH 116	5580		15.38	
		CH 124	5620		15.36	
		CH 132	5660		15.37	
		CH 144	5720		15.43	
	802.11ac-VHT40	CH 102	5510	MCS0	12.94	96.97
		CH 110	5550		15.84	
		CH 126	5630		15.75	
		CH 134	5670		15.95	
		CH 142	5710		15.92	
	802.11ac-VHT80	CH 106	5530	MCS0	13.21	93.67
		CH 122	5610		16.20	
		CH 138	5690		16.11	



	Mode	Channel	Frequency (MHz)	Data Rate	Average power (dBm)	Duty Cycle %
5.8GHz WLAN Antenna A	802.11a	CH 149	5745	MCS0	15.18	98.47
		CH 157	5785		15.43	
		CH 165	5825		15.22	
	802.11n-HT20	CH 149	5745	MCS0	15.41	98.36
		CH 157	5785		15.16	
		CH 165	5825		15.08	
	802.11n-HT40	CH 151	5755	MCS0	16.24	96.94
		CH 159	5795		16.28	
	802.11ac-VHT20	CH 149	5745	MCS0	15.35	98.37
		CH 157	5785		15.00	
		CH 165	5825		14.98	
	802.11ac-VHT40	CH 151	5755	MCS0	16.07	96.97
		CH 159	5795		15.99	
	802.11ac-VHT80	CH 155	5775	MCS0	16.25	93.67

<5GHz WLAN Antenna B>

	Mode	Channel	Frequency (MHz)	Data Rate	Average power (dBm)	Duty Cycle %
5.2GHz WLAN Antenna B	802.11a	CH 36	5180	6Mbps	13.68	98.47
		CH 40	5200		14.09	
		CH 44	5220		14.22	
		CH 48	5240		14.40	
	802.11n-HT20	CH 36	5180	MCS0	13.83	98.36
		CH 40	5200		13.68	
		CH 44	5220		14.51	
		CH 48	5240		14.44	
	802.11n-HT40	CH 38	5190	MCS0	13.08	96.91
		CH 46	5230		15.93	
	802.11ac-VHT20	CH 36	5180	MCS0	13.60	98.37
		CH 40	5200		14.30	
		CH 44	5220		14.49	
		CH 48	5240		14.20	
	802.11ac-VHT40	CH 38	5190	MCS0	12.92	96.94
		CH 46	5230		16.08	
802.11ac-VHT80	CH 42	5210	MCS0	13.48	93.67	



	Mode	Channel	Frequency (MHz)	Data Rate	Average power (dBm)	Duty Cycle %
5.3GHz WLAN Antenna B	802.11a	CH 52	5260	6Mbps	15.79	98.47
		CH 56	5280		15.45	
		CH 60	5300		15.67	
		CH 64	5320		13.07	
	802.11n-HT20	CH 52	5260	MCS0	15.66	98.36
		CH 56	5280		15.73	
		CH 60	5300		15.74	
		CH 64	5320		12.95	
	802.11n-HT40	CH 54	5270	MCS0	15.90	96.91
		CH 62	5310		12.93	
	802.11ac-VHT20	CH 52	5260	MCS0	15.79	98.37
		CH 56	5280		15.78	
		CH 60	5300		15.77	
		CH 64	5320		12.99	
	802.11ac-VHT40	CH 54	5270	MCS0	15.92	96.94
		CH 62	5310		12.94	
802.11ac-VHT80	CH 58	5290	MCS0	13.02	93.67	



	Mode	Channel	Frequency (MHz)	Data Rate	Average power (dBm)	Duty Cycle %
5.5GHz WLAN Antenna B	802.11a	CH 100	5500	6Mbps	12.98	98.47
		CH 116	5580		15.65	
		CH 124	5620		15.61	
		CH 132	5660		12.98	
		CH 144	5720		15.60	
	802.11n-HT20	CH 100	5500	MCS0	12.93	98.36
		CH 116	5580		15.99	
		CH 124	5620		15.97	
		CH 132	5660		15.98	
		CH 144	5720		15.98	
	802.11n-HT40	CH 102	5510	MCS0	13.13	96.91
		CH 110	5550		15.92	
		CH 126	5630		15.80	
		CH 134	5670		16.49	
		CH 142	5710		16.13	
	802.11ac-VHT20	CH 100	5500	MCS0	13.26	98.37
		CH 116	5580		15.92	
		CH 124	5620		15.91	
		CH 132	5660		15.87	
		CH 144	5720		15.85	
	802.11ac-VHT40	CH 102	5510	MCS0	13.19	96.94
		CH 110	5550		15.91	
		CH 126	5630		15.80	
		CH 134	5670		16.49	
CH 142		5710	16.20			
802.11ac-VHT80	CH 106	5530	MCS0	13.48	93.67	
	CH 122	5610		16.31		
	CH 138	5690		16.16		



	Mode	Channel	Frequency (MHz)	Data Rate	Average power (dBm)	Duty Cycle %
5.8GHz WLAN Antenna B	802.11a	CH 149	5745	MCS0	14.85	98.47
		CH 157	5785		14.68	
		CH 165	5825		14.97	
	802.11n-HT20	CH 149	5745	MCS0	14.78	98.36
		CH 157	5785		14.59	
		CH 165	5825		14.55	
	802.11n-HT40	CH 151	5755	MCS0	16.17	96.91
		CH 159	5795		16.12	
	802.11ac-VHT20	CH 149	5745	MCS0	14.99	98.37
		CH 157	5785		14.53	
		CH 165	5825		14.83	
	802.11ac-VHT40	CH 151	5755	MCS0	16.18	96.94
		CH 159	5795		16.09	
	802.11ac-VHT80	CH 155	5775	MCS0	16.44	93.67

<5GHz WLAN Antenna A+B>

	Mode	Channel	Frequency (MHz)	Data Rate	Average power (dBm)	Duty Cycle %
5.2GHz WLAN Antenna A+B	802.11n-HT20	CH 36	5180	MCS0	14.15	97.03
		CH 40	5200		14.26	
		CH 44	5220		14.33	
		CH 48	5240		14.29	
	802.11n-HT40	CH 38	5190	MCS0	12.76	94.32
		CH 46	5230		16.83	
	802.11ac-VHT20	CH 36	5180	MCS0	14.27	97.06
		CH 40	5200		14.32	
		CH 44	5220		14.30	
		CH 48	5240		14.37	
	802.11ac-VHT40	CH 38	5190	MCS0	12.59	94.38
		CH 46	5230		16.80	
	802.11ac-VHT80	CH 42	5210	MCS0	14.49	90.14



	Mode	Channel	Frequency (MHz)	Data Rate	Average power (dBm)	Duty Cycle %
5.5GHz WLAN Antenna A+B	802.11n-HT20	CH 52	5260	MCS0	16.43	97.03
		CH 56	5280		16.45	
		CH 60	5300		16.49	
		CH 64	5320		14.38	
	802.11n-HT40	CH 54	5270	MCS0	19.42	94.32
		CH 62	5310		14.45	
	802.11ac-VHT20	CH 52	5260	MCS0	16.47	97.06
		CH 56	5280		16.48	
		CH 60	5300		16.28	
		CH 64	5320		14.45	
	802.11ac-VHT40	CH 54	5270	MCS0	19.46	94.38
		CH 62	5310		14.49	
802.11ac-VHT80	CH 58	5290	MCS0	14.48	90.14	

	Mode	Channel	Frequency (MHz)	Data Rate	Average power (dBm)	Duty Cycle %
5.5GHz WLAN Antenna A+B	802.11n-HT20	CH 100	5500	MCS0	13.31	97.03
		CH 116	5580		17.40	
		CH 124	5620		17.28	
		CH 132	5660		17.25	
		CH 144	5720		16.01	
	802.11n-HT40	CH 102	5510	MCS0	14.15	94.32
		CH 110	5550		19.28	
		CH 126	5630		19.28	
		CH 134	5670		19.37	
	802.11ac-VHT20	CH 142	5710	MCS0	19.18	97.06
		CH 100	5500		13.41	
		CH 116	5580		17.44	
		CH 124	5620		17.41	
		CH 132	5660		17.36	
	802.11ac-VHT40	CH 144	5720	MCS0	16.34	94.38
		CH 102	5510		14.36	
		CH 110	5550		19.24	
		CH 126	5630		19.33	
		CH 134	5670		19.40	
	802.11ac-VHT80	CH 142	5710	MCS0	19.36	90.14
CH 106		5530	14.31			
CH 122		5610	19.47			
CH 138		5690	19.35			

	Mode	Channel	Frequency (MHz)	Data Rate	Average power (dBm)	Duty Cycle %
5.8GHz WLAN Antenna A+B	802.11n-HT20	CH 149	5745	MCS0	16.20	97.03
		CH 157	5785		16.10	
		CH 165	5825		16.33	
	802.11n-HT40	CH 151	5755	MCS0	19.42	94.32
		CH 159	5795		19.15	
	802.11ac-VHT20	CH 149	5745	MCS0	16.17	97.06
		CH 157	5785		16.12	
		CH 165	5825		16.48	
	802.11ac-VHT40	CH 151	5755	MCS0	19.23	94.38
		CH 159	5795		19.14	
	802.11ac-VHT80	CH 155	5775	MCS0	19.43	90.14

13. Bluetooth Exclusions Applied

Mode Band	Average power(dBm)	
	v3.0+EDR	v4.0+LE
2.4GHz Bluetooth	4.0	4.0

Note:

- Per KDB 447498 D01v06, the 1-g and 10-g SAR test exclusion thresholds for 100 MHz to 6 GHz at *test separation distances* ≤ 50 mm are determined by:

$$[(\text{max. power of channel, including tune-up tolerance, mW}) / (\text{min. test separation distance, mm})] \cdot \sqrt{f(\text{GHz})} \leq 3.0$$
 for 1-g SAR and ≤ 7.5 for 10-g extremity SAR
 - f(GHz) is the RF channel transmit frequency in GHz
 - Power and distance are rounded to the nearest mW and mm before calculation
 - The result is rounded to one decimal place for comparison

Bluetooth Max Power (dBm)	Separation Distance (mm)	Frequency (GHz)	exclusion thresholds
4	< 5	2.48	0.94

Note:

Per KDB 447498 D01v06, when the minimum test separation distance is < 5 mm, a distance of 5 mm is applied to determine SAR test exclusion. The test exclusion threshold is 0.94 which is ≤ 3, SAR testing is not required.

14. Antenna Location

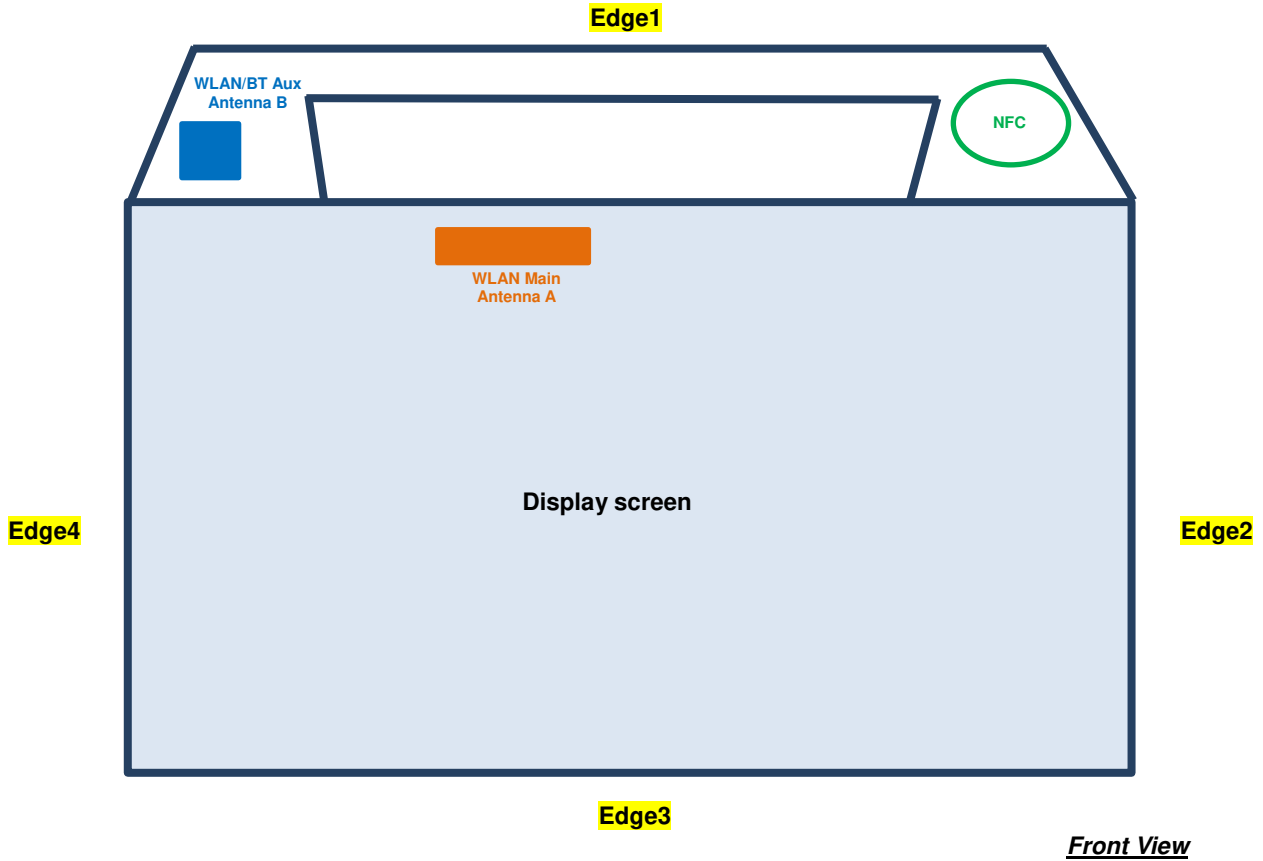

Minimum separation distance for antenna to edge:

Antenna	Bottom Face (mm)	To Edge1 (mm)	To Edge2 (mm)	To Edge3 (mm)	To Edge4 (mm)
WLAN Antenna A	≤ 5	55.40	133.80	182.10	99.70
WLAN Antenna B	≤ 5	32.00	256.00	201.00	7.00



<SAR test exclusion table>

General Note:

1. The below table, when the distance is < 50 mm exclusion threshold is "Ratio", when the distance is > 50 mm exclusion threshold is "mW"
2. Maximum power is the source-based time-average power and represents the maximum RF output power among production units
3. Per KDB 447498 D01v06, for larger devices, the test separation distance of adjacent edge configuration is determined by the closest separation between the antenna and the user.
4. Per KDB 447498 D01v06, standalone SAR test exclusion threshold is applied; If the test separation distance is < 5mm, 5mm is used to determine SAR exclusion threshold.
5. Per KDB 447498 D01v06, the 1-g and 10-g SAR test exclusion thresholds for 100 MHz to 6 GHz at *test separation distances* ≤ 50 mm are determined by:
 - $[(max. power of channel, including tune-up tolerance, mW)/(min. test separation distance, mm)] \cdot \sqrt{f(GHz)} \leq 3.0$ for 1-g SAR and ≤ 7.5 for 10-g extremity SAR
 - f(GHz) is the RF channel transmit frequency in GHz
 - Power and distance are rounded to the nearest mW and mm before calculation
 - The result is rounded to one decimal place for comparison
6. Per KDB 447498 D01v06, at 100 MHz to 6 GHz and for *test separation distances* > 50 mm, the SAR test exclusion threshold is determined according to the following
 - a) [Threshold at 50 mm in step 1) + (test separation distance - 50 mm)·(f(MHz)/150)] mW, at 100 MHz to 1500 MHz
 - b) [Threshold at 50 mm in step 1) + (test separation distance - 50 mm)·10] mW at > 1500 MHz and ≤ 6 GHz

Exposure Position	Wireless Interface	2.4GHz WLAN ANT A	2.4GHz WLAN ANT B	5GHz WLAN ANT A	5GHz WLAN ANT B
	Calculated Frequency	2462MHz	2462MHz	5825MHz	5825MHz
	Maximum power (dBm)	17.5	17.5	16.5	16.5
	Maximum rated power(mW)	56.0	56.0	45.0	45.0
Bottom Face	Separation distance(mm)	5.0	5.0	5.0	5.0
	exclusion threshold	17.6	17.6	21.7	21.7
	Testing required?	Yes	Yes	Yes	Yes
Edge 1	Separation distance(mm)	55.4	32.0	55.4	32.0
	exclusion threshold	150.0	2.8	116.0	3.4
	Testing required?	No	No	No	Yes
Edge 2	Separation distance(mm)	133.8	256.0	133.8	256.0
	exclusion threshold	934.0	2156.0	900.0	2122.0
	Testing required?	No	No	No	No
Edge 3	Separation distance(mm)	182.1	201.0	182.1	201.0
	exclusion threshold	1417.0	1606.0	1383.0	1572.0
	Testing required?	No	No	No	No
Edge 4	Separation distance(mm)	99.7	7.0	99.7	7.0
	exclusion threshold	593.0	12.6	559.0	15.5
	Testing required?	No	Yes	No	Yes



15. SAR Test Results

General Note:

1. Per KDB 447498 D01v06, the reported SAR is the measured SAR value adjusted for maximum tune-up tolerance.
 - a. Tune-up scaling Factor = tune-up limit power (mW) / EUT RF power (mW), where tune-up limit is the maximum rated power among all production units.
 - b. For SAR testing of WLAN signal with non-100% duty cycle, the measured SAR is scaled-up by the duty cycle scaling factor which is equal to "1/(duty cycle)"
 - c. For WLAN: Reported SAR(W/kg)= Measured SAR(W/kg)* Duty Cycle scaling factor * Tune-up scaling factor
2. Per KDB 865664 D01v01r04, for each frequency band, repeated SAR measurement is required only when the measured SAR is ≥0.8W/kg.
3. Per KDB 248227 D01v02r02, for 2.4GHz 802.11g/n SAR testing is not required when the highest reported SAR for DSSS is adjusted by the ratio of OFDM to DSSS specified maximum output power and the adjusted SAR is ≤ 1.2 W/kg.
4. Per KDB 248227 D01v02r02, for U-NII-1 Body SAR testing is not required when the U-NII-2A band highest reported SAR for a test configuration is ≤ 1.2 W/kg, SAR is not required for U-NII-1 band.
5. When the reported SAR of the test position is > 0.4 W/kg, SAR is repeated for the 802.11 transmission mode configuration tested in the initial test position to measure the subsequent next closet/smallest test separation distance and maximum coupling test position on the highest maximum output power channel, until the report SAR is ≤ 0.8 W/kg or all required test position are tested.
6. For all positions / configurations, when the reported SAR is > 0.8 W/kg, SAR is measured for these test positions / configurations on the subsequent next highest measured output power channel(s) until the reported SAR is ≤ 1.2 W/kg or all required channels are tested.
7. For WLAN SAR testing was performed on single antenna RF power in SISO mode is larger or equal to the single antenna RF power in MIMO mode, and for RF exposure assessment of MIMO mode simultaneous transmission exclusion analysis was performed with SAR test results of each antenna in SISO mode.
8. Per KDB 248227 D01v02r02, the simultaneous SAR provisions in KDB publication 447498 should be applied to determine simultaneous transmission SAR test exclusion for WiFi MIMO. If the sum of 1g single transmission chain SAR measurements is < 1.6W/kg and SAR peak to location ratio < 0.04, no additional SAR measurements for MIMO.
9. During SAR testing the WLAN transmission was verified using a spectrum analyzer.

15.1 Body SAR

<WLAN SAR>

Plot No.	Band	Mode	Test Position	Gap (mm)	Antenna	Ch.	Freq. (MHz)	Average Power (dBm)	Tune-Up Limit (dBm)	Tune-up Scaling Factor	Duty Cycle %	Duty Cycle Scaling Factor	Power Drift (dB)	Measured 1g SAR (W/kg)	Reported 1g SAR (W/kg)
	WLAN2.4GHz	802.11b 1Mbps	Bottom Face	0mm	Ant A	6	2437	17.20	17.50	1.073	98.96	1.011	0.11	0.031	0.034
	WLAN2.4GHz	802.11b 1Mbps	Bottom Face	0mm	Ant B	6	2437	17.16	17.50	1.081	98.96	1.011	-0.12	0.032	0.035
01	WLAN2.4GHz	802.11b 1Mbps	Edge 4	0mm	Ant B	6	2437	17.16	17.50	1.081	98.96	1.011	0.14	0.253	0.277
02	WLAN5GHz	802.11n-HT40 MCS0	Bottom Face	0mm	Ant A	54	5270	16.05	16.50	1.108	96.94	1.032	-0.02	0.071	0.081
	WLAN5GHz	802.11n-HT40 MCS0	Bottom Face	0mm	Ant B	54	5270	15.90	16.50	1.148	96.91	1.032	-0.17	0.026	0.031
	WLAN5GHz	802.11n-HT40 MCS0	Edge 1	0mm	Ant B	54	5270	15.90	16.50	1.148	96.91	1.032	-0.03	0.011	0.013
	WLAN5GHz	802.11n-HT40 MCS0	Edge 4	0mm	Ant B	54	5270	15.90	16.50	1.148	96.91	1.032	0.18	0.049	0.058
	WLAN5GHz	802.11ac-VHT80 MCS0	Bottom Face	0mm	Ant A	122	5610	16.20	16.50	1.071	93.67	1.068	-0.1	0.093	0.106
	WLAN5GHz	802.11ac-VHT80 MCS0	Bottom Face	0mm	Ant B	122	5610	16.31	16.50	1.045	93.67	1.068	0.12	0.021	0.023
	WLAN5GHz	802.11ac-VHT80 MCS0	Edge 1	0mm	Ant B	122	5610	16.31	16.50	1.045	93.67	1.068	0.06	0.106	0.118
03	WLAN5GHz	802.11ac-VHT80 MCS0	Edge 4	0mm	Ant B	122	5610	16.31	16.50	1.045	93.67	1.068	0.03	0.384	0.428
	WLAN5GHz	802.11ac-VHT80 MCS0	Bottom Face	0mm	Ant A	155	5775	16.25	16.50	1.059	93.67	1.068	-0.17	0.066	0.075
	WLAN5GHz	802.11ac-VHT80 MCS0	Bottom Face	0mm	Ant B	155	5775	16.44	16.50	1.014	93.67	1.068	0.03	0.019	0.021
	WLAN5GHz	802.11ac-VHT80 MCS0	Edge 1	0mm	Ant B	155	5775	16.44	16.50	1.014	93.67	1.068	-0.12	0.098	0.106
04	WLAN5GHz	802.11ac-VHT80 MCS0	Edge 4	0mm	Ant B	155	5775	16.44	16.50	1.014	93.67	1.068	0.15	0.350	0.379

16. Simultaneous Transmission Analysis

NO.	Simultaneous Transmission Configurations	Support
1.	WLAN Ant A + Bluetooth Ant B	Yes
2.	WLAN Ant A + WLAN Ant B	Yes

General Note:

- For SAR testing was performed on single antenna RF power in SISO mode is larger or equal to the single antenna RF power in MIMO mode, and for RF exposure assessment of MIMO mode simultaneous transmission exclusion analysis was performed with SAR test results of each antenna in SISO mode.
- WLAN and Bluetooth share the same antenna B, and cannot transmit simultaneously.
- EUT will choose either WLAN 2.4GHz or WLAN 5GHz according to the network signal condition; therefore, 2.4GHz WLAN and 5GHz WLAN will not operate simultaneously at any moment.
- The Scaled SAR summation is calculated based on worst WLAN for each antenna.
- Per KDB 447498 D01v06, simultaneous transmission SAR is compliant if,
 - Scalar SAR summation < 1.6W/kg.
 - $SPLSR = (SAR1 + SAR2)^{1.5} / (\text{min. separation distance, mm})$, and the peak separation distance is determined from the square root of $[(x1-x2)^2 + (y1-y2)^2 + (z1-z2)^2]$, where (x1, y1, z1) and (x2, y2, z2) are the coordinates of the extrapolated peak SAR locations in the zoom scan.
 - If $SPLSR \leq 0.04$, simultaneously transmission SAR measurement is not necessary.
 - Simultaneously transmission SAR measurement, and the reported multi-band SAR < 1.6W/kg.
- For simultaneous transmission analysis, Bluetooth SAR is estimated per KDB 447498 D01v06 based on the formula below.
 - $(\text{max. power of channel, including tune-up tolerance, mW}) / (\text{min. test separation distance, mm}) \cdot [\sqrt{f(\text{GHz})} / x] \text{ W/kg}$ for test separation distances $\leq 50 \text{ mm}$; where $x = 7.5$ for 1-g SAR, and $x = 18.75$ for 10-g SAR.
 - When the minimum separation distance is < 5mm, the distance is used 5mm to determine SAR test exclusion.
 - 0.4 W/kg for 1-g SAR and 1.0 W/kg for 10-g SAR, when the test separation distances is > 50 mm.
 - Bluetooth estimated SAR is conservatively determined by 5mm separation, for all applicable exposure positions.

Bluetooth Max Power	Exposure Position	All Positions
4.0 dBm	Estimated SAR (W/kg)	0.126 W/kg

16.1 Body Exposure Conditions

1	2	3	4	5	1+2 Summed 1g SAR (W/kg)	3+4 Summed 1g SAR (W/kg)	1+5 Summed 1g SAR (W/kg)	3+5 Summed 1g SAR (W/kg)
2.4GHz WLAN Ant A	2.4GHz WLAN Ant B	5GHz WLAN Ant A	5GHz WLAN Ant B	Bluetooth Ant B				
1g SAR (W/kg)	1g SAR (W/kg)	1g SAR (W/kg)	1g SAR (W/kg)	Estimated 1g SAR (W/kg)				
0.034	0.277	0.106	0.428	0.126	0.311	0.534	0.160	0.232

Test Engineer : Thomas Wang and Iver Zhan

17. Uncertainty Assessment

The component of uncertainty may generally be categorized according to the methods used to evaluate them. The evaluation of uncertainty by the statistical analysis of a series of observations is termed a Type A evaluation of uncertainty. The evaluation of uncertainty by means other than the statistical analysis of a series of observation is termed a Type B evaluation of uncertainty. Each component of uncertainty, however evaluated, is represented by an estimated standard deviation, termed standard uncertainty, which is determined by the positive square root of the estimated variance.

A Type A evaluation of standard uncertainty may be based on any valid statistical method for treating data. This includes calculating the standard deviation of the mean of a series of independent observations; using the method of least squares to fit a curve to the data in order to estimate the parameter of the curve and their standard deviations; or carrying out an analysis of variance in order to identify and quantify random effects in certain kinds of measurement.

A type B evaluation of standard uncertainty is typically based on scientific judgment using all of the relevant information available. These may include previous measurement data, experience, and knowledge of the behavior and properties of relevant materials and instruments, manufacture’s specification, data provided in calibration reports and uncertainties assigned to reference data taken from handbooks. Broadly speaking, the uncertainty is either obtained from an outdoor source or obtained from an assumed distribution, such as the normal distribution, rectangular or triangular distributions indicated in table below.

Uncertainty Distributions	Normal	Rectangular	Triangular	U-Shape
Multi-plying Factor ^(a)	1/k ^(b)	1/√3	1/√6	1/√2

(a) standard uncertainty is determined as the product of the multiplying factor and the estimated range of variations in the measured quantity

(b) κ is the coverage factor

Table 17.1. Standard Uncertainty for Assumed Distribution

The combined standard uncertainty of the measurement result represents the estimated standard deviation of the result. It is obtained by combining the individual standard uncertainties of both Type A and Type B evaluation using the usual “root-sum-squares” (RSS) methods of combining standard deviations by taking the positive square root of the estimated variances.

Expanded uncertainty is a measure of uncertainty that defines an interval about the measurement result within which the measured value is confidently believed to lie. It is obtained by multiplying the combined standard uncertainty by a coverage factor. Typically, the coverage factor ranges from 2 to 3. Using a coverage factor allows the true value of a measured quantity to be specified with a defined probability within the specified uncertainty range. For purpose of this document, a coverage factor two is used, which corresponds to confidence interval of about 95 %. The DASY uncertainty Budget is shown in the following tables.



Error Description	Uncertainty Value (±%)	Probability	Divisor	(Ci) 1g	(Ci) 10g	Standard Uncertainty (1g) (±%)	Standard Uncertainty (10g) (±%)
Measurement System							
Probe Calibration	6.0	N	1	1	1	6.0	6.0
Axial Isotropy	4.7	R	1.732	0.7	0.7	1.9	1.9
Hemispherical Isotropy	9.6	R	1.732	0.7	0.7	3.9	3.9
Boundary Effects	1.0	R	1.732	1	1	0.6	0.6
Linearity	4.7	R	1.732	1	1	2.7	2.7
System Detection Limits	1.0	R	1.732	1	1	0.6	0.6
Modulation Response	3.2	R	1.732	1	1	1.8	1.8
Readout Electronics	0.3	N	1	1	1	0.3	0.3
Response Time	0.0	R	1.732	1	1	0.0	0.0
Integration Time	2.6	R	1.732	1	1	1.5	1.5
RF Ambient Noise	3.0	R	1.732	1	1	1.7	1.7
RF Ambient Reflections	3.0	R	1.732	1	1	1.7	1.7
Probe Positioner	0.4	R	1.732	1	1	0.2	0.2
Probe Positioning	2.9	R	1.732	1	1	1.7	1.7
Max. SAR Eval.	2.0	R	1.732	1	1	1.2	1.2
Test Sample Related							
Device Positioning	3.0	N	1	1	1	3.0	3.0
Device Holder	3.6	N	1	1	1	3.6	3.6
Power Drift	5.0	R	1.732	1	1	2.9	2.9
Power Scaling	0.0	R	1.732	1	1	0.0	0.0
Phantom and Setup							
Phantom Uncertainty	6.1	R	1.732	1	1	3.5	3.5
SAR correction	0.0	R	1.732	1	0.84	0.0	0.0
Liquid Conductivity Repeatability	0.2	N	1	0.78	0.71	0.1	0.1
Liquid Conductivity (target)	5.0	R	1.732	0.78	0.71	2.3	2.0
Liquid Conductivity (mea.)	2.5	R	1.732	0.78	0.71	1.1	1.0
Temp. unc. - Conductivity	3.4	R	1.732	0.78	0.71	1.5	1.4
Liquid Permittivity Repeatability	0.15	N	1	0.23	0.26	0.0	0.0
Liquid Permittivity (target)	5.0	R	1.732	0.23	0.26	0.7	0.8
Liquid Permittivity (mea.)	2.5	R	1.732	0.23	0.26	0.3	0.4
Temp. unc. - Permittivity	0.83	R	1.732	0.23	0.26	0.1	0.1
Combined Std. Uncertainty						11.4%	11.4%
Coverage Factor for 95 %						K=2	K=2
Expanded STD Uncertainty						22.9%	22.7%

Table 17.1. Uncertainty Budget for frequency range 300 MHz to 3 GHz



Error Description	Uncertainty Value (±%)	Probability	Divisor	(Ci) 1g	(Ci) 10g	Standard Uncertainty (1g) (±%)	Standard Uncertainty (10g) (±%)
Measurement System							
Probe Calibration	7.0	N	1	1	1	7.0	7.0
Axial Isotropy	4.7	R	1.732	0.7	0.7	1.9	1.9
Hemispherical Isotropy	9.6	R	1.732	0.7	0.7	3.9	3.9
Boundary Effects	2.0	R	1.732	1	1	1.2	1.2
Linearity	4.7	R	1.732	1	1	2.7	2.7
System Detection Limits	1.0	R	1.732	1	1	0.6	0.6
Modulation Response	3.2	R	1.732	1	1	1.8	1.8
Readout Electronics	0.3	N	1	1	1	0.3	0.3
Response Time	0.0	R	1.732	1	1	0.0	0.0
Integration Time	2.6	R	1.732	1	1	1.5	1.5
RF Ambient Noise	3.0	R	1.732	1	1	1.7	1.7
RF Ambient Reflections	3.0	R	1.732	1	1	1.7	1.7
Probe Positioner	0.4	R	1.732	1	1	0.2	0.2
Probe Positioning	6.7	R	1.732	1	1	3.9	3.9
Max. SAR Eval.	4.0	R	1.732	1	1	2.3	2.3
Test Sample Related							
Device Positioning	3.0	N	1	1	1	3.0	3.0
Device Holder	3.6	N	1	1	1	3.6	3.6
Power Drift	5.0	R	1.732	1	1	2.9	2.9
Power Scaling	0.0	R	1.732	1	1	0.0	0.0
Phantom and Setup							
Phantom Uncertainty	6.6	R	1.732	1	1	3.8	3.8
SAR correction	0.0	R	1.732	1	0.84	0.0	0.0
Liquid Conductivity Repeatability	0.2	N	1	0.78	0.71	0.1	0.1
Liquid Conductivity (target)	5.0	R	1.732	0.78	0.71	2.3	2.0
Liquid Conductivity (mea.)	2.5	R	1.732	0.78	0.71	1.1	1.0
Temp. unc. - Conductivity	3.4	R	1.732	0.78	0.71	1.5	1.4
Liquid Permittivity Repeatability	0.15	N	1	0.23	0.26	0.0	0.0
Liquid Permittivity (target)	5.0	R	1.732	0.23	0.26	0.7	0.8
Liquid Permittivity (mea.)	2.5	R	1.732	0.23	0.26	0.3	0.4
Temp. unc. - Permittivity	0.83	R	1.732	0.23	0.26	0.1	0.1
Combined Std. Uncertainty						12.8%	12.7%
Coverage Factor for 95 %						K=2	K=2
Expanded STD Uncertainty						25.5%	25.4%

Table 17.2. Uncertainty Budget for frequency range 3 GHz to 6 GHz



18. References

- [1] FCC 47 CFR Part 2 "Frequency Allocations and Radio Treaty Matters; General Rules and Regulations"
- [2] ANSI/IEEE Std. C95.1-1992, "IEEE Standard for Safety Levels with Respect to Human Exposure to Radio Frequency Electromagnetic Fields, 3 kHz to 300 GHz", September 1992
- [3] IEEE Std. 1528-2013, "IEEE Recommended Practice for Determining the Peak Spatial-Average Specific Absorption Rate (SAR) in the Human Head from Wireless Communications Devices: Measurement Techniques", Sep 2013
- [4] SPEAG DASY System Handbook
- [5] FCC KDB 248227 D01 v02r02, "SAR Guidance for IEEE 802.11 (WiFi) Transmitters", Oct 2015.
- [6] FCC KDB 447498 D01 v06, "Mobile and Portable Device RF Exposure Procedures and Equipment Authorization Policies", Oct 2015
- [7] FCC KDB 616217 D04 v01r02, "SAR Evaluation Considerations for Laptop, Notebook, Netbook and Tablet Computers", Oct 2015
- [8] FCC KDB 865664 D01 v01r04, "SAR Measurement Requirements for 100 MHz to 6 GHz", Aug 2015.
- [9] FCC KDB 865664 D02 v01r02, "RF Exposure Compliance Reporting and Documentation Considerations" Oct 2015.