



A D T

FCC TEST REPORT (PART 24)

REPORT NO.: RF120927C01-1

MODEL NO.: Gobi2000

FCC ID: QYL400GOBI2

RECEIVED: Sep. 27, 2012

TESTED: Oct. 06 ~ Oct. 12, 2012

ISSUED: Oct. 23, 2012

APPLICANT: Getac Technology Corporation

ADDRESS: 5F., Building A, No. 209, Sec. 1, Nangang Rd.,
Nangang Dist, Taipei City 11568, Taiwan, R.O.C.

ISSUED BY: Bureau Veritas Consumer Products Services
(H.K.) Ltd., Taoyuan Branch

LAB ADDRESS: No. 47, 14th Ling, Chia Pau Vil., Lin Kou Dist., New
Taipei City, Taiwan (R.O.C.)

TEST LOCATION: No. 19, Hwa Ya 2nd Rd, Wen Hwa Tsuen, Kwei
Shan Hsiang, Taoyuan Hsien 333, Taiwan, R.O.C.

This report should not be used by the client to claim product certification, approval, or endorsement by TAF or any government agencies.



This report is for your exclusive use. Any copying or replication of this report to or for any other person or entity, or use of our name or trademark, is permitted only with our prior written permission. This report sets forth our findings solely with respect to the test samples identified herein. The results set forth in this report are not indicative or representative of the quality or characteristics of the lot from which a test sample was taken or any similar or identical product unless specifically and expressly noted. Our report includes all of the tests requested by you and the results thereof based upon the information that you provided to us. You have 60 days from date of issuance of this report to notify us of any material error or omission caused by our negligence, provided, however, that such notice shall be in writing and shall specifically address the issue you wish to raise. A failure to raise such issue within the prescribed time shall constitute your unqualified acceptance of the completeness of this report, the tests conducted and the correctness of the report contents. Unless specific mention, the uncertainty of measurement has been explicitly taken into account to declare the compliance or non-compliance to the specification



TABLE OF CONTENTS

RELEASE CONTROL RECORD	3
1 CERTIFICATION	4
2 SUMMARY OF TEST RESULTS.....	5
2.1 MEASUREMENT UNCERTAINTY	5
2.2 TEST SITE AND INSTRUMENTS.....	6
3 GENERAL INFORMATION	7
3.1 GENERAL DESCRIPTION OF EUT	7
3.2 CONFIGURATION OF SYSTEM UNDER TEST	8
3.3 DESCRIPTION OF SUPPORT UNITS.....	8
3.4 TEST ITEM AND TEST CONFIGURATION	9
3.5 EUT OPERATING CONDITIONS.....	10
3.6 GENERAL DESCRIPTION OF APPLIED STANDARDS	10
4 TEST TYPES AND RESULTS.....	11
4.1 OUTPUT POWER MEASUREMENT	11
4.1.1 LIMITS OF OUTPUT POWER MEASUREMENT	11
4.1.2 TEST PROCEDURES	11
4.1.3 TEST SETUP	12
4.1.4 TEST RESULTS	13
4.2 FREQUENCY STABILITY MEASUREMENT	18
4.2.1 LIMITS OF FREQUENCY STABILITY MEASUREMENT	18
4.2.2 TEST PROCEDURE.....	18
4.2.3 TEST SETUP	18
4.2.4 TEST RESULTS	19
4.3 OCCUPIED BANDWIDTH MEASUREMENT	20
4.3.1 TEST PROCEDURES	20
4.3.2 TEST SETUP	20
4.3.3 TEST RESULTS	21
4.4 BAND EDGE MEASUREMENT	22
4.4.1 LIMITS OF BAND EDGE MEASUREMENT	22
4.4.2 TEST SETUP	22
4.4.3 TEST PROCEDURES	22
4.4.4 TEST RESULTS	23
4.5 CONDUCTED SPURIOUS EMISSIONS.....	25
4.5.1 LIMITS OF CONDUCTED SPURIOUS EMISSIONS MEASUREMENT	25
4.5.2 TEST PROCEDURE.....	25
4.5.3 TEST SETUP	25
4.5.4 TEST RESULTS	26
4.6 RADIATED EMISSION MEASUREMENT	38
4.6.1 LIMITS OF RADIATED EMISSION MEASUREMENT	38
4.6.2 TEST PROCEDURES	38
4.6.3 DEVIATION FROM TEST STANDARD	38
4.6.4 TEST SETUP	39
4.6.5 TEST RESULTS	40
5 PHOTOGRAPHS OF THE TEST CONFIGURATION.....	55
6 INFORMATION ON THE TESTING LABORATORIES	56
7 APPENDIX A – MODIFICATIONS RECORDERS FOR ENGINEERING CHANGES TO THE EUT BY THE LAB.....	57



A D T

RELEASE CONTROL RECORD

ISSUE NO.	REASON FOR CHANGE	DATE ISSUED
RF120927C01-1	Original release	Oct. 23, 2012



1 CERTIFICATION

PRODUCT: WWAN Module
MODEL: Gobi2000
BRAND: Qualcomm
APPLICANT: Getac Technology Corporation
TESTED: Oct. 06 ~ Oct. 12, 2012
TEST SAMPLE: ENGINEERING SAMPLE
STANDARDS: FCC Part 24, Subpart E

The above equipment (model: Gobi2000) has been tested by **Bureau Veritas Consumer Products Services (H.K.) Ltd., Taoyuan Branch**, and found compliance with the requirement of the above standards. The test record, data evaluation & Equipment Under Test (EUT) configurations represented herein are true and accurate accounts of the measurements of the sample's EMC characteristics under the conditions specified in this report.

PREPARED BY : Ivonne Wu , **DATE** : Oct. 23, 2012
Ivonne Wu / Senior Specialist

APPROVED BY : Anderson Chiu , **DATE** : Oct. 23, 2012
Anderson Chiu / Senior Engineer

2 SUMMARY OF TEST RESULTS

The EUT has been tested according to the following specifications:

APPLIED STANDARD: FCC Part 24 & Part 2			
STANDARD SECTION	TEST TYPE	RESULT	REMARK
2.1046 24.232	Equivalent isotropically radiated power	PASS	Meet the requirement of limit.
2.1055 24.235	Frequency Stability	PASS	Meet the requirement of limit.
2.1049 24.238(b)	Occupied Bandwidth	PASS	Meet the requirement of limit.
24.238(b)	Band Edge Measurements	PASS	Meet the requirement of limit.
2.1051 24.238	Conducted Spurious Emissions	PASS	Meet the requirement of limit.
2.1053 24.238	Radiated Spurious Emissions	PASS	Meet the requirement of limit. Minimum passing margin is -12.4dB at 3815.20MHz.

2.1 MEASUREMENT UNCERTAINTY

Where relevant, the following measurement uncertainty levels have been estimated for tests performed on the EUT as specified in CISPR 16-4-2:

MEASUREMENT	FREQUENCY	UNCERTAINTY
Conducted emissions	150kHz~30MHz	2.44 dB
Radiated emissions	30MHz ~ 200MHz	2.93 dB
	200MHz ~1000MHz	2.95 dB
	1GHz ~ 18GHz	2.26 dB
	18GHz ~ 40GHz	1.94 dB

This uncertainty represents an expanded uncertainty expressed at approximately the 95% confidence level using a coverage factor of k=2.

2.2 TEST SITE AND INSTRUMENTS

DESCRIPTION & MANUFACTURER	MODEL NO.	SERIAL NO.	DATE OF CALIBRATION	DUE DATE OF CALIBRATION
Test Receiver ROHDE & SCHWARZ	ESI7	838496/016	Jan. 03, 2012	Jan. 02, 2013
Spectrum Analyzer ROHDE & SCHWARZ	FSP 40	100039	Feb. 03, 2012	Feb. 02, 2013
BILOG Antenna SCHWARZBECK	VULB9168	9168-155	Apr. 06, 2012	Apr. 05, 2013
HORN Antenna SCHWARZBECK	BBHA 9120D	9120D-408	Jan. 05, 2012	Jan. 04, 2013
HORN Antenna SCHWARZBECK	BBHA 9170	148	Jul. 11, 2012	Jul. 10, 2013
Loop Antenna	HFH2-Z2	100070	Jan. 31, 2012	Jan. 30, 2014
Preamplifier Agilent	8449B	3008A01961	Oct. 29, 2011	Oct. 28, 2012
Preamplifier Agilent	8447D	2944A10738	Oct. 29, 2011	Oct. 28, 2012
RF signal cable HUBER+SUHNNER	SUCOFLEX 104	309220/4	Nov. 03, 2011	Nov. 02, 2012
RF signal cable HUBER+SUHNNER	SUCOFLEX 104	250724/4	Nov. 03, 2011	Nov. 02, 2012
RF signal cable HUBER+SUHNNER	SUCOFLEX 104	295012/4	Nov. 03, 2011	Nov. 02, 2012
Software ADT	ADT_Radiated_ V7.6.15.9.2	NA	NA	NA
Antenna Tower inn-co GmbH	MA 4000	010303	NA	NA
Antenna Tower Controller inn-co GmbH	CO2000	019303	NA	NA
Turn Table ADT	TT100.	TT93021704	NA	NA
Turn Table Controller ADT	SC100.	SC93021704	NA	NA

- NOTE:** 1. The calibration interval of the above test instruments is 12 months and the calibrations are traceable to NML/ROC and NIST/USA.
2. The test was performed in HwaYa Chamber 4.
3. The horn antenna and HP preamplifier (model: 8449B) are used only for the measurement of emission frequency above 1GHz if tested.
4. The FCC Site Registration No. is 460141.
5. The IC Site Registration No. is IC 7450F-4.

3 GENERAL INFORMATION

3.1 GENERAL DESCRIPTION OF EUT

EUT	WWAN Module	
MODEL NO.	Gobi2000	
POWER SUPPLY	3.3Vdc	
MODULATION TYPE	GPRS	GMSK
	EDGE	8PSK
	CDMA	QPSK, OQPSK, HPSK
	WCDMA	BPSK
FREQUENCY RANGE	GPRS/EDGE	1850.2MHz ~ 1909.8MHz
	CDMA	1851.3MHz ~ 1908.8MHz
	WCDMA	1852.4MHz ~ 1907.5 MHz
MAX. EIRP POWER	GPRS	426.58mW (26.3dBm)
	EDGE	218.273mW (23.39dBm)
	CDMA	100.231mW (20.01dBm)
	WCDMA	102.094mW (20.09dBm)
EMISSION DESIGNATOR	GPRS	367KGXW
	EDGE	367KG7W
	CDMA	1M29F9W
	WCDMA	4M20F9W
MULTI-SLOTS CLASS	10	
WCDMA RELEASE VERSION	6	
ANTENNA TYPE	Fixed Internal antenna with 0.87dBi gain	
I/O PORTS	Refer to users' manual	
DATA CABLE	NA	
ACCESSORY DEVICES	NA	

NOTE:

1. The transmitter module is authorized for use in specific End-product (Notebook, Brand: Getac, Model: S400).
2. The above EUT information was declared by manufacturer and for more detailed features description, please refer to the manufacturer's specifications or User's Manual.

3.2 CONFIGURATION OF SYSTEM UNDER TEST

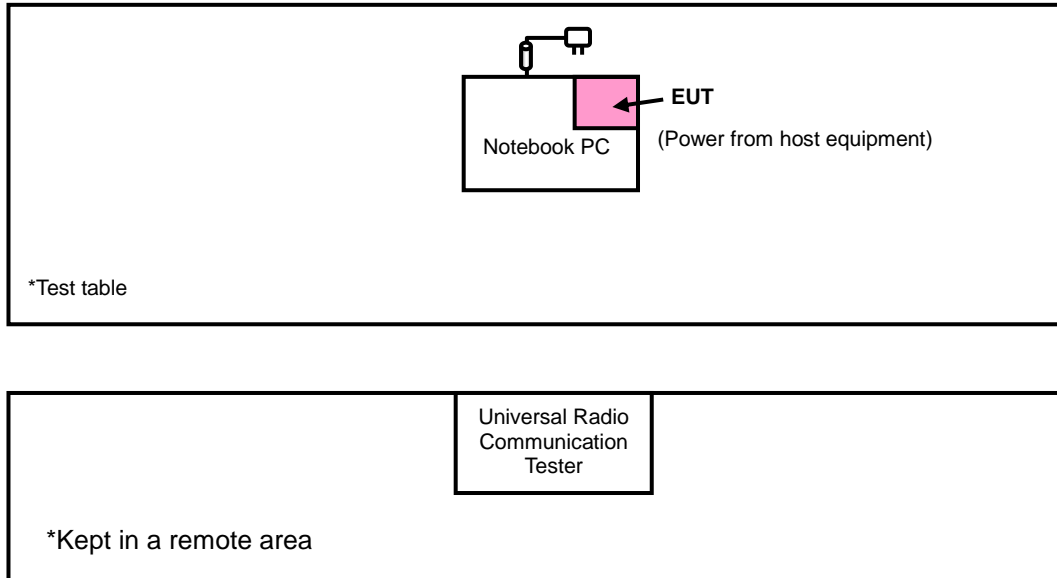

3.3 DESCRIPTION OF SUPPORT UNITS

The EUT has been tested as an independent unit together with other necessary accessories or support units. The following support units or accessories were used to form a representative test configuration during the tests.

NO.	PRODUCT	BRAND	MODEL NO.	SERIAL NO.	FCC ID
1	Notebook	Getac	S400	NA	NA

NO.	SIGNAL CABLE DESCRIPTION OF THE ABOVE SUPPORT UNITS
1	NA

NOTE:

1. All power cords of the above support units are non shielded (1.8m).
2. Item 1 was provided by client.



3.4 TEST ITEM AND TEST CONFIGURATION

GPRS MODE

EUT CONFIGURE MODE	TEST ITEM	AVAILABLE CHANNEL	TESTED CHANNEL	MODE
-	EIRP	512 to 810	512, 661, 810	GPRS, EDGE
-	FREQUENCY STABILITY	512 to 810	661	GPRS
-	OCCUPIED BANDWIDTH	512 to 810	512, 661, 810	GPRS, EDGE
-	BAND EDGE	512 to 810	512, 810	GPRS, EDGE
-	CONDCUDED EMISSION	512 to 810	512, 661, 810	GPRS, EDGE
-	RADIATED EMISSION	512 to 810	512, 661, 810	GPRS, EDGE

CDMA MODE

EUT CONFIGURE MODE	TEST ITEM	AVAILABLE CHANNEL	TESTED CHANNEL	MODE
-	EIRP	25 to 1175	25, 600, 1175	1xRTT
-	FREQUENCY STABILITY	25 to 1175	600	1xRTT
-	OCCUPIED BANDWIDTH	25 to 1175	25, 600, 1175	1xRTT
-	BAND EDGE	25 to 1175	25, 1175	1xRTT
-	CONDCUDED EMISSION	25 to 1175	25, 600, 1175	1xRTT
-	RADIATED EMISSION	25 to 1175	25, 600, 1175	1xRTT

WCDMA MODE

EUT CONFIGURE MODE	TEST ITEM	AVAILABLE CHANNEL	TESTED CHANNEL	MODE
-	EIRP	9262 to 9538	9262, 9400, 9538	WCDMA
-	FREQUENCY STABILITY	9262 to 9538	9400	WCDMA
-	OCCUPIED BANDWIDTH	9262 to 9538	9262, 9400, 9538	WCDMA
-	BAND EDGE	9262 to 9538	9262, 9538	WCDMA
-	CONDCUDED EMISSION	9262 to 9538	9262, 9400, 9538	WCDMA
-	RADIATED EMISSION	9262 to 9538	9262, 9400, 9538	WCDMA



A D T

TEST CONDITION:

TEST ITEM	ENVIRONMENTAL CONDITIONS	INPUT POWER	TESTED BY
EIRP	24deg. C, 66%RH	120Vac, 60Hz	Alan Wu
FREQUENCY STABILITY	26deg. C, 58%RH	120Vac, 60Hz	Brad Wu
OCCUPIED BANDWIDTH	26deg. C, 58%RH	120Vac, 60Hz	Brad Wu
BAND EDGE	26deg. C, 58%RH	120Vac, 60Hz	Brad Wu
CONDUCTED EMISSION	26deg. C, 58%RH	120Vac, 60Hz	Brad Wu
RADIATED EMISSION	24deg. C, 65%RH	120Vac, 60Hz	Alan Wu

3.5 EUT OPERATING CONDITIONS

The EUT makes a call to the communication simulator. The communication simulator station system controlled a EUT to export maximum output power under transmission mode and specific channel frequency

3.6 GENERAL DESCRIPTION OF APPLIED STANDARDS

The EUT is a RF product. According to the specifications of the manufacturer, it must comply with the requirements of the following standards:

FCC 47 CFR Part 2

FCC 47 CFR Part 24

ANSI/TIA/EIA-603-C 2004

NOTE: All test items have been performed and recorded as per the above standards.

4 TEST TYPES AND RESULTS

4.1 OUTPUT POWER MEASUREMENT

4.1.1 LIMITS OF OUTPUT POWER MEASUREMENT

Mobile and portable stations are limited to 2 watts EIRP

4.1.2 TEST PROCEDURES

EIRP MEASUREMENT:

- a. All measurements were done at low, middle and high operational frequency range. RBW and VBW is 1MHz for GPRS & EDGE and 5MHz for CDMA and WCDMA mode.
- b. Substitution method is used for E.I.R.P measurement. In the semi-anechoic chamber, EUT placed on the 0.8m height of Turn Table, rotated the table around 360 degrees to search the maximum radiation power and receiver antenna shall be rotated vertical and horizontal polarization and moved height from 1m to 4m to find the maximum polar radiated power. The “Read Value” is the spectrum reading the maximum power value.
- c. The substitution horn antenna is substituted for EUT at the same position and signals generator export the CW signal to the substitution antenna via a tx cable. Rotated the Turn Table and moved receiving antenna to find the maximum radiation power. Adjust output power level of S.G to get a Value of spectrum reading equal to “Read Value” of step b. Record the power level of S.G
- d. $EIRP = \text{Output power level of S.G} - \text{TX cable loss} + \text{Antenna gain of substitution horn.}$

CONDUCTED POWER MEASUREMENT:

The EUT was set up for the maximum power with GPRS, EDGE, CDMA & WCDMA link data modulation and link up with simulator. Set the EUT to transmit under low, middle and high channel and record the power level shown on simulator.

4.1.3 TEST SETUP

EIRP MEASUREMENT:

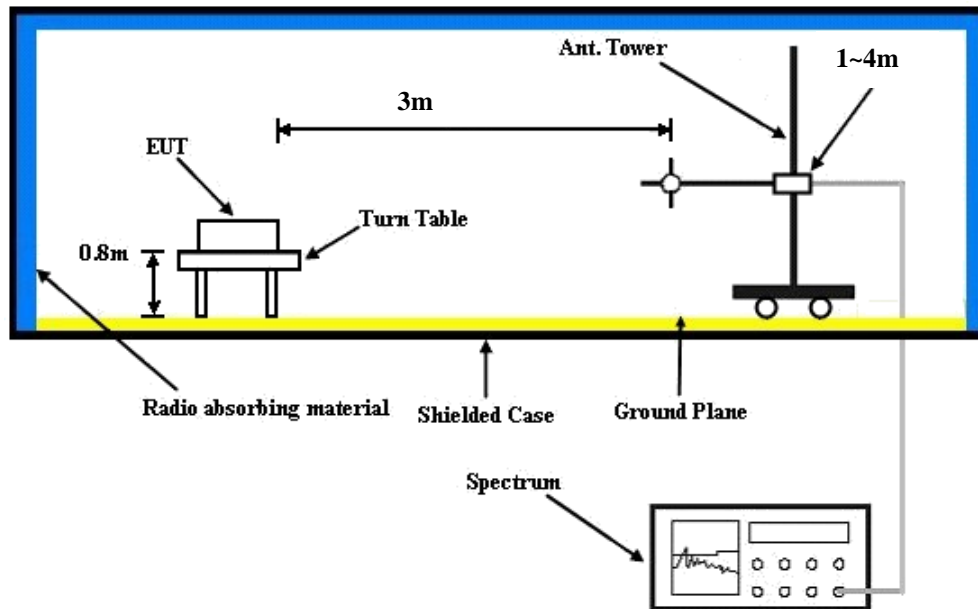

For the actual test configuration, please refer to the attached file (Test Setup Photo).

CONDUCTED POWER MEASUREMENT:

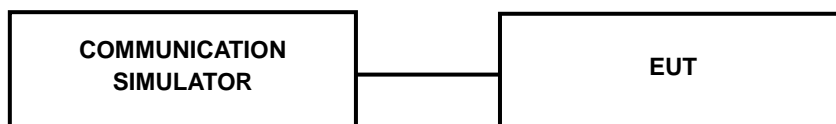

For the actual test configuration, please refer to the attached file (Test Setup Photo).



4.1.4 TEST RESULTS

CONDUCTED OUTPUT POWER (dBm)

Band	GPRS1900		
Channel	512	661	810
Frequency (MHz)	1850.2	1880.0	1909.8
GPRS 8 (GMSK, 1 Uplink)	27.49	28.05	28.89
GPRS 10 (GMSK, 2 Uplink)	27.17	28.01	28.26
EDGE 8 (8PSK, 1 Uplink)	24.46	25.01	25.25
EDGE 10 (8PSK, 2 Uplink)	24.42	24.98	25.23

Band	CDMA		
Channel	25	600	1175
Frequency (MHz)	1851.25	1880	1908.75
RC1+SO55	24.52	24.91	24.45
RC3+SO55	24.57	25.01	24.23
RC3+SO32(+ F-SCH)	24.49	24.76	24.23
RC3+SO32(+SCH)	24.49	24.86	24.17
RTAP 153.6	24.34	24.75	23.95
RETAP 4096	24.24	24.45	23.17

Band	WCDMA II		
Channel	9262	9400	9538
Frequency (MHz)	1852.4	1880.0	1907.5
RMC 12.2K	24.56	24.57	24.25
HSDPA Subtest-1	22.47	22.49	22.19
HSDPA Subtest-2	22.41	22.41	22.11
HSDPA Subtest-3	22.01	22.03	21.71
HSDPA Subtest-4	22.04	22.04	21.76
HSUPA Subtest-1	22.41	22.43	22.16
HSUPA Subtest-2	20.49	20.53	20.26
HSUPA Subtest-3	21.53	21.51	21.17
HSUPA Subtest-4	20.51	20.49	20.22
HSUPA Subtest-5	22.43	22.46	22.21



A D T

EIRP POWER (dBm)

FOR GPRS MODE:

MODE		TX channel 512					
ANTENNA POLARITY & TEST DISTANCE: HORIZONTAL AT 3 M							
No.	Freq. (MHz)	Reading (dBm)	S.G Power Value (dBm)	Correction Factor (dB)	EIRP (dBm)	Limit (dBm)	Margin (dB)
1	1850.2	-15.1	23.43	1.07	24.5	-13	37.5
ANTENNA POLARITY & TEST DISTANCE: VERTICAL AT 3 M							
No.	Freq. (MHz)	Reading (dBm)	S.G Power Value (dBm)	Correction Factor (dB)	EIRP (dBm)	Limit (dBm)	Margin (dB)
1	1850.20	-18.99	17.64	1.07	18.71	33	-14.29

NOTE: Power Value (dBm) = S.G Power Value (dBm) + Correction Factor (dB).

MODE		TX channel 661					
ANTENNA POLARITY & TEST DISTANCE: HORIZONTAL AT 3 M							
No.	Freq. (MHz)	Reading (dBm)	S.G Power Value (dBm)	Correction Factor (dB)	EIRP (dBm)	Limit (dBm)	Margin (dB)
1	1880.00	-14.03	24.69	1.12	25.81	33	-7.19
ANTENNA POLARITY & TEST DISTANCE: VERTICAL AT 3 M							
No.	Freq. (MHz)	Reading (dBm)	S.G Power Value (dBm)	Correction Factor (dB)	EIRP (dBm)	Limit (dBm)	Margin (dB)
1	1880.00	-18.44	17.82	1.12	18.94	33	-14.06

NOTE: Power Value (dBm) = S.G Power Value (dBm) + Correction Factor (dB).

MODE		TX channel 810					
ANTENNA POLARITY & TEST DISTANCE: HORIZONTAL AT 3 M							
No.	Freq. (MHz)	Reading (dBm)	S.G Power Value (dBm)	Correction Factor (dB)	EIRP (dBm)	Limit (dBm)	Margin (dB)
1	1909.80	-13.9	25.2	1.1	26.3	33	-6.7
ANTENNA POLARITY & TEST DISTANCE: VERTICAL AT 3 M							
No.	Freq. (MHz)	Reading (dBm)	S.G Power Value (dBm)	Correction Factor (dB)	EIRP (dBm)	Limit (dBm)	Margin (dB)
1	1909.80	-17.8	18.09	1.11	19.2	33	-13.8

NOTE: Power Value (dBm) = S.G Power Value (dBm) + Correction Factor (dB).



A D T

FOR EDGE MODE:

MODE		TX channel 512					
ANTENNA POLARITY & TEST DISTANCE: HORIZONTAL AT 3 M							
No.	Freq. (MHz)	Reading (dBm)	S.G Power Value (dBm)	Correction Factor (dB)	EIRP (dBm)	Limit (dBm)	Margin (dB)
1	1850.20	-18.1	20.43	1.07	21.5	33	-11.5
ANTENNA POLARITY & TEST DISTANCE: VERTICAL AT 3 M							
No.	Freq. (MHz)	Reading (dBm)	S.G Power Value (dBm)	Correction Factor (dB)	EIRP (dBm)	Limit (dBm)	Margin (dB)
1	1850.20	-18.72	17.91	1.07	18.98	33	-14.02

NOTE: Power Value (dBm) = S.G Power Value (dBm) + Correction Factor (dB).

MODE		TX channel 661					
ANTENNA POLARITY & TEST DISTANCE: HORIZONTAL AT 3 M							
No.	Freq. (MHz)	Reading (dBm)	S.G Power Value (dBm)	Correction Factor (dB)	EIRP (dBm)	Limit (dBm)	Margin (dB)
1	1880.00	-16.88	21.84	1.12	22.96	33	-10.04
ANTENNA POLARITY & TEST DISTANCE: VERTICAL AT 3 M							
No.	Freq. (MHz)	Reading (dBm)	S.G Power Value (dBm)	Correction Factor (dB)	EIRP (dBm)	Limit (dBm)	Margin (dB)
1	1880.00	-21.39	14.87	1.12	15.99	33	-17.01

NOTE: Power Value (dBm) = S.G Power Value (dBm) + Correction Factor (dB).

MODE		TX channel 810					
ANTENNA POLARITY & TEST DISTANCE: HORIZONTAL AT 3 M							
No.	Freq. (MHz)	Reading (dBm)	S.G Power Value (dBm)	Correction Factor (dB)	EIRP (dBm)	Limit (dBm)	Margin (dB)
1	1909.80	-16.83	22.28	1.11	23.39	33	-9.61
ANTENNA POLARITY & TEST DISTANCE: VERTICAL AT 3 M							
No.	Freq. (MHz)	Reading (dBm)	S.G Power Value (dBm)	Correction Factor (dB)	EIRP (dBm)	Limit (dBm)	Margin (dB)
1	1909.80	-20.58	15.31	1.11	16.42	33	-16.58

NOTE: Power Value (dBm) = S.G Power Value (dBm) + Correction Factor (dB).



A D T

FOR CDMA MODE:

MODE		TX channel 25					
ANTENNA POLARITY & TEST DISTANCE: HORIZONTAL AT 3 M							
No.	Freq. (MHz)	Reading (dBm)	S.G Power Value (dBm)	Correction Factor (dB)	ERP (dBm)	Limit (dBm)	Margin (dB)
1	1851.25	-20.8	17.74	1.07	18.81	33	-14.19
ANTENNA POLARITY & TEST DISTANCE: VERTICAL AT 3 M							
No.	Freq. (MHz)	Reading (dBm)	S.G Power Value (dBm)	Correction Factor (dB)	ERP (dBm)	Limit (dBm)	Margin (dB)
1	1851.25	-25.24	11.38	1.07	12.45	33	-20.55

NOTE: Power Value (dBm) = S.G Power Value (dBm) + Correction Factor (dB).

MODE		TX channel 600					
ANTENNA POLARITY & TEST DISTANCE: HORIZONTAL AT 3 M							
No.	Freq. (MHz)	Reading (dBm)	S.G Power Value (dBm)	Correction Factor (dB)	ERP (dBm)	Limit (dBm)	Margin (dB)
1	1880.00	-20.38	18.34	1.12	19.46	33	-13.54
ANTENNA POLARITY & TEST DISTANCE: VERTICAL AT 3 M							
No.	Freq. (MHz)	Reading (dBm)	S.G Power Value (dBm)	Correction Factor (dB)	ERP (dBm)	Limit (dBm)	Margin (dB)
1	1880.00	-24.5	11.76	1.12	12.88	33	-20.12

NOTE: Power Value (dBm) = S.G Power Value (dBm) + Correction Factor (dB).

MODE		TX channel 1175					
ANTENNA POLARITY & TEST DISTANCE: HORIZONTAL AT 3 M							
No.	Freq. (MHz)	Reading (dBm)	S.G Power Value (dBm)	Correction Factor (dB)	ERP (dBm)	Limit (dBm)	Margin (dB)
1	1908.75	-20.2	18.9	1.11	20.01	33	-12.99
ANTENNA POLARITY & TEST DISTANCE: VERTICAL AT 3 M							
No.	Freq. (MHz)	Reading (dBm)	S.G Power Value (dBm)	Correction Factor (dB)	ERP (dBm)	Limit (dBm)	Margin (dB)
1	1908.75	-23.4	12.5	1.11	13.61	33	-19.39

NOTE: Power Value (dBm) = S.G Power Value (dBm) + Correction Factor (dB).



A D T

FOR WCDMA MODE:

MODE		TX channel 9262					
ANTENNA POLARITY & TEST DISTANCE: HORIZONTAL AT 3 M							
No.	Freq. (MHz)	Reading (dBm)	S.G Power Value (dBm)	Correction Factor (dB)	EIRP (dBm)	Limit (dBm)	Margin (dB)
1	1852.40	-20.45	18.1	1.07	19.17	33	-13.83
ANTENNA POLARITY & TEST DISTANCE: VERTICAL AT 3 M							
No.	Freq. (MHz)	Reading (dBm)	S.G Power Value (dBm)	Correction Factor (dB)	EIRP (dBm)	Limit (dBm)	Margin (dB)
1	1852.40	-25.3	11.31	1.07	12.38	33	-20.62

NOTE: Power Value (dBm) = S.G Power Value (dBm) + Correction Factor (dB).

MODE		TX channel 9400					
ANTENNA POLARITY & TEST DISTANCE: HORIZONTAL AT 3 M							
No.	Freq. (MHz)	Reading (dBm)	S.G Power Value (dBm)	Correction Factor (dB)	EIRP (dBm)	Limit (dBm)	Margin (dB)
1	1880.00	-20	18.72	1.12	19.84	33	-13.16
ANTENNA POLARITY & TEST DISTANCE: VERTICAL AT 3 M							
No.	Freq. (MHz)	Reading (dBm)	S.G Power Value (dBm)	Correction Factor (dB)	EIRP (dBm)	Limit (dBm)	Margin (dB)
1	1880.00	-24.7	11.56	1.12	12.68	33	-20.32

NOTE: Power Value (dBm) = S.G Power Value (dBm) + Correction Factor (dB).

MODE		TX channel 9538					
ANTENNA POLARITY & TEST DISTANCE: HORIZONTAL AT 3 M							
No.	Freq. (MHz)	Reading (dBm)	S.G Power Value (dBm)	Correction Factor (dB)	EIRP (dBm)	Limit (dBm)	Margin (dB)
1	1907.50	-20.1	18.98	1.11	20.09	33	-12.91
ANTENNA POLARITY & TEST DISTANCE: VERTICAL AT 3 M							
No.	Freq. (MHz)	Reading (dBm)	S.G Power Value (dBm)	Correction Factor (dB)	EIRP (dBm)	Limit (dBm)	Margin (dB)
1	1907.50	-24.1	11.82	1.11	12.93	33	-20.07

NOTE: Power Value (dBm) = S.G Power Value (dBm) + Correction Factor (dB).

4.2 FREQUENCY STABILITY MEASUREMENT

4.2.1 LIMITS OF FREQUENCY STABILITY MEASUREMENT

The frequency stability shall be sufficient to ensure that the fundamental emission stays within the authorized frequency block.

4.2.2 TEST PROCEDURE

- a. Device is placed at the oven room. The oven room could control the temperatures and humidity. Power warm up is at least 15 min and power applied should perform before recording frequency error.
- b. EUT is connected the external power supply to control the DC input power. The test voltage range is from minimum to maximum working voltage. Each step shall be record the frequency error rate.
- c. The temperature range step is 10 degrees in this test items. All temperature levels shall be hold the $\pm 0.5^{\circ}\text{C}$ during the measurement testing. The each temperature step shall be at least 0.5 hours, consider the EUT could be test under the stability condition.

NOTE: The frequency error was recorded frequency error from the communication simulator.

4.2.3 TEST SETUP

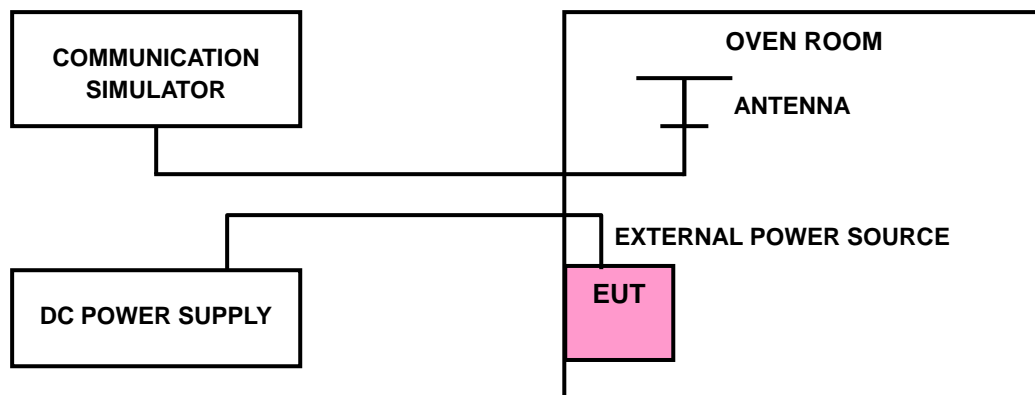

4.2.4 TEST RESULTS

FREQUENCY ERROR VS. VOLTAGE

VOLTAGE (Volts)	FREQUENCY ERROR (ppm)			LIMIT (ppm)
	GPRS	CDMA	WCDMA	
126.5	-0.014	-0.036	-0.016	2.5
93.5	-0.015	-0.032	-0.015	2.5

FREQUENCY ERROR vs. TEMPERATURE.

TEMP. (°C)	FREQUENCY ERROR (ppm)			LIMIT (ppm)
	GPRS	CDMA	WCDMA	
50	-0.018	-0.041	-0.018	2.5
40	-0.016	-0.039	-0.018	2.5
30	-0.016	-0.036	-0.019	2.5
20	-0.014	-0.038	-0.018	2.5
10	-0.018	-0.044	-0.017	2.5
0	-0.016	-0.045	-0.016	2.5
-10	-0.016	-0.042	-0.019	2.5
-20	-0.018	-0.048	-0.019	2.5
-30	-0.019	-0.047	-0.019	2.5

4.3 OCCUPIED BANDWIDTH MEASUREMENT

4.3.1 TEST PROCEDURES

The EUT makes a call to the communication simulator. All measurements were done at low, middle and high operational frequency range. The communication simulator station system controlled a EUT to export maximum output power under transmission mode and specific channel frequency. Use OBW measurement function of Spectrum analyzer to measure 99 % occupied bandwidth.

4.3.2 TEST SETUP

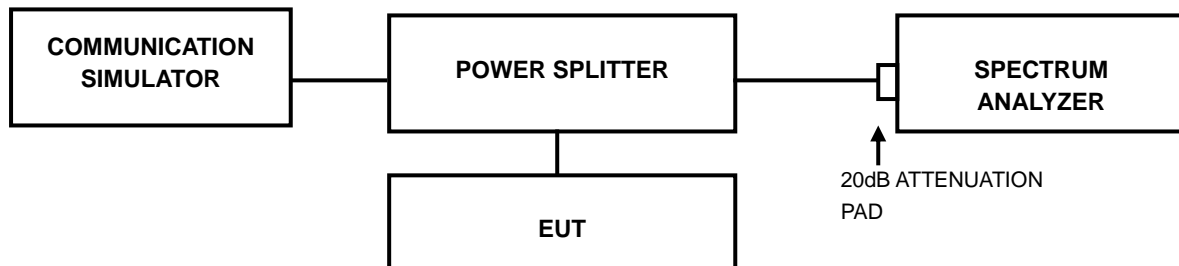



A D T

4.3.3 TEST RESULTS

CHANNEL	FREQUENCY (MHz)	99% OCCUPIED BANDWIDTH (kHz)		CHANNEL	FREQUENCY (MHz)	99% OCCUPIED BANDWIDTH (MHz)
		GPRS	EDGE			WCDMA
512	1850.2	366.67	366.67	9262	1852.4	4.20
661	1880.0	366.67	366.67	9400	1880.0	4.20
810	1909.8	366.67	366.67	9538	1907.5	4.18

CHANNEL	FREQUENCY (MHz)	99% OCCUPIED BANDWIDTH (MHz)
		CDMA
25	1851.3	1.27
600	1880.0	1.28
1175	1908.8	1.29

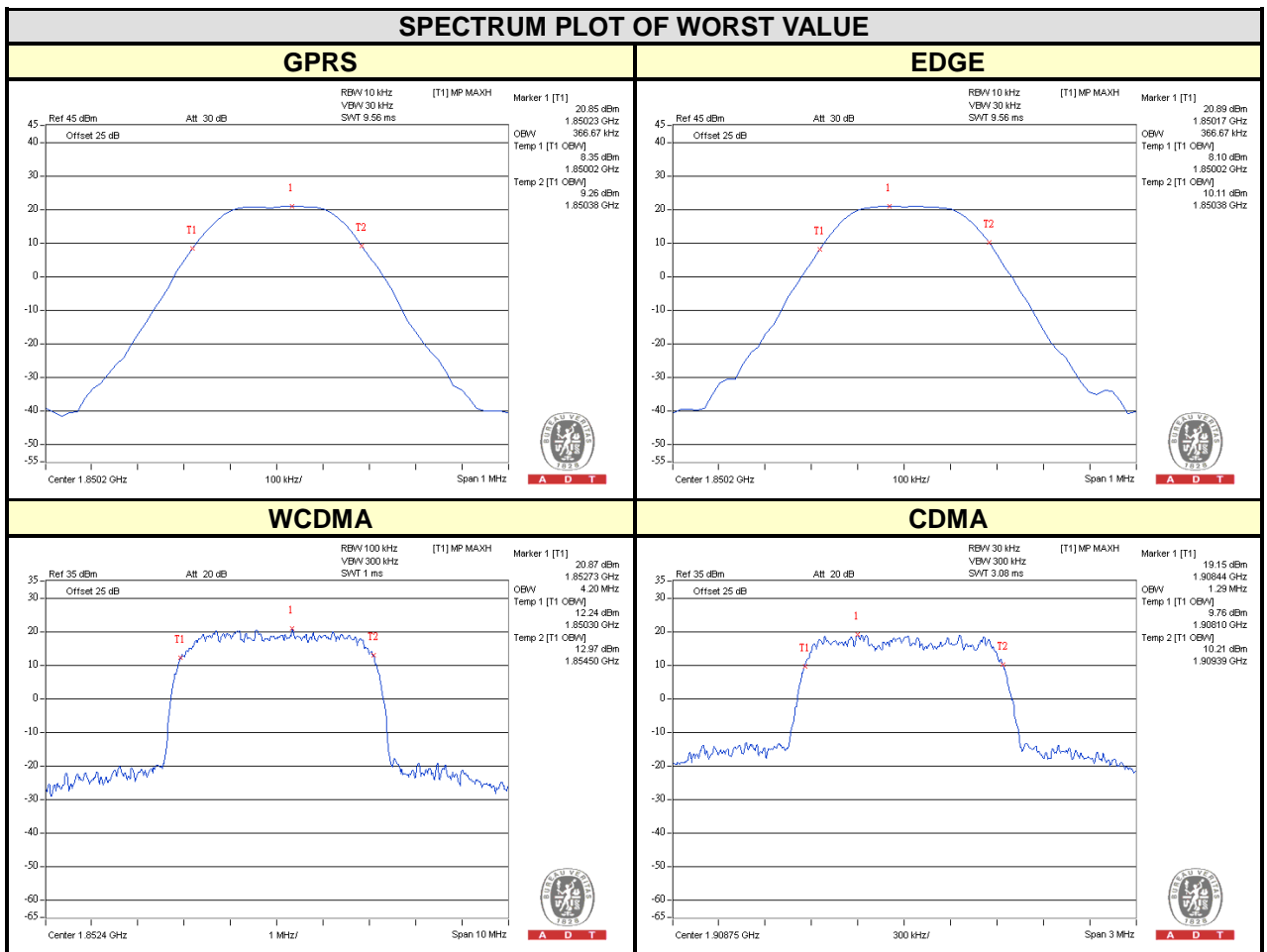

4.4 BAND EDGE MEASUREMENT

4.4.1 LIMITS OF BAND EDGE MEASUREMENT

Power of any emission outside of the authorized operating frequency ranges must be attenuated below the transmitting power (P) by a factor of at least $43 + 10 \log(P)$ dB. In the 1 MHz bands immediately outside and adjacent to the frequency block a resolution bandwidth of at least one percent of the emission bandwidth of the fundamental emission of the transmitter may be employed.

4.4.2 TEST SETUP

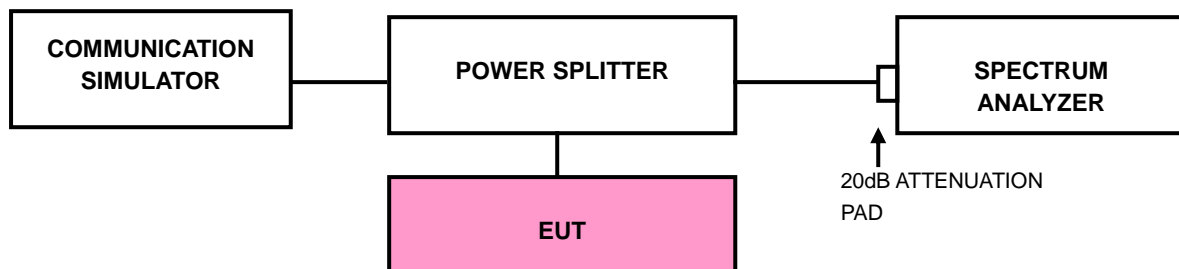

4.4.3 TEST PROCEDURES

- All measurements were done at low and high operational frequency range.
- The center frequency of spectrum is the band edge frequency and span is 1 MHz. RB of the spectrum is 3kHz and VB of the spectrum is 10kHz (GPRS/EDGE).
- The center frequency of spectrum is the band edge frequency and span is 2MHz. RB of the spectrum is 15kHz and VB of the spectrum is 15kHz (CDMA).
- The center frequency of spectrum is the band edge frequency and span is 5MHz. RB of the spectrum is 100kHz and VB of the spectrum is 300kHz (WCDMA).
- Record the max trace plot into the test report.



A D T

4.4.4 TEST RESULTS

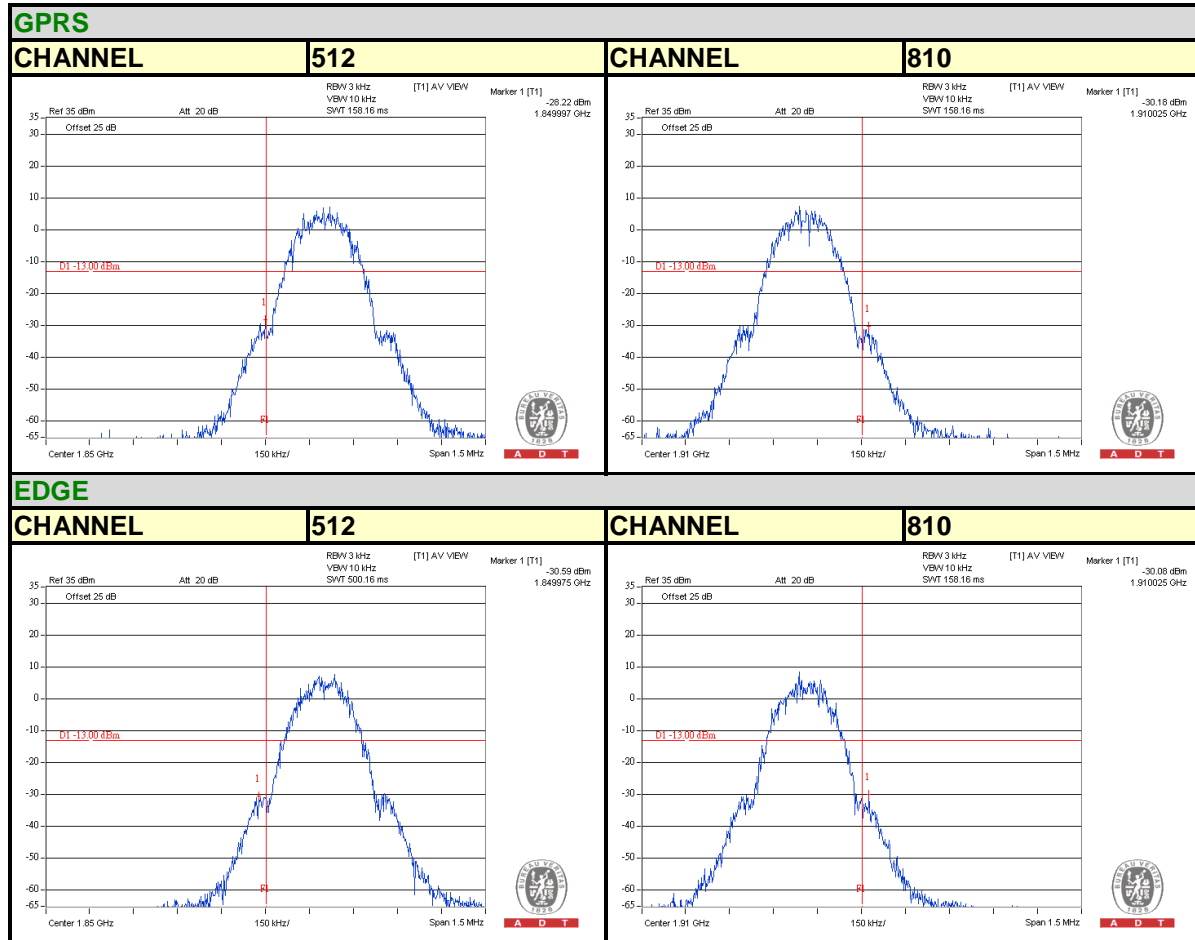



A D T

CDMA

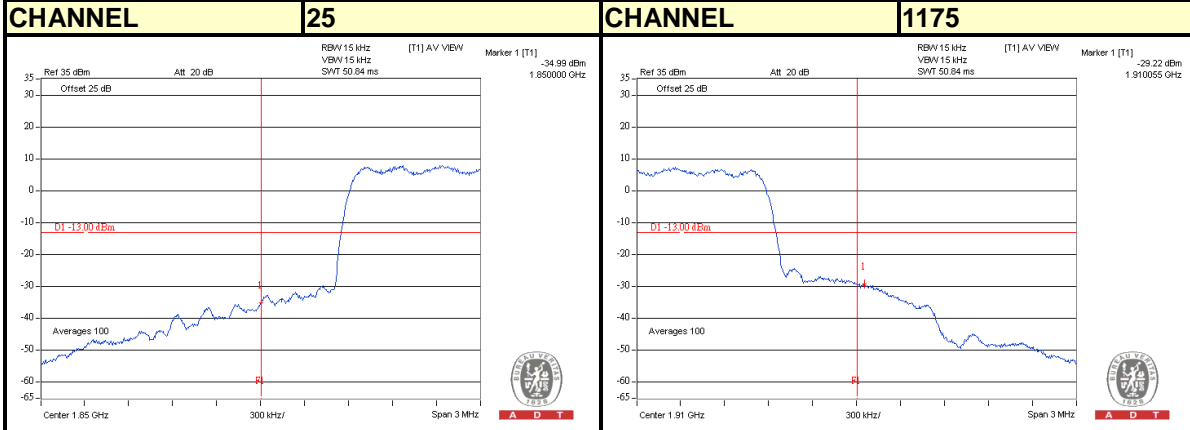

WCDMA

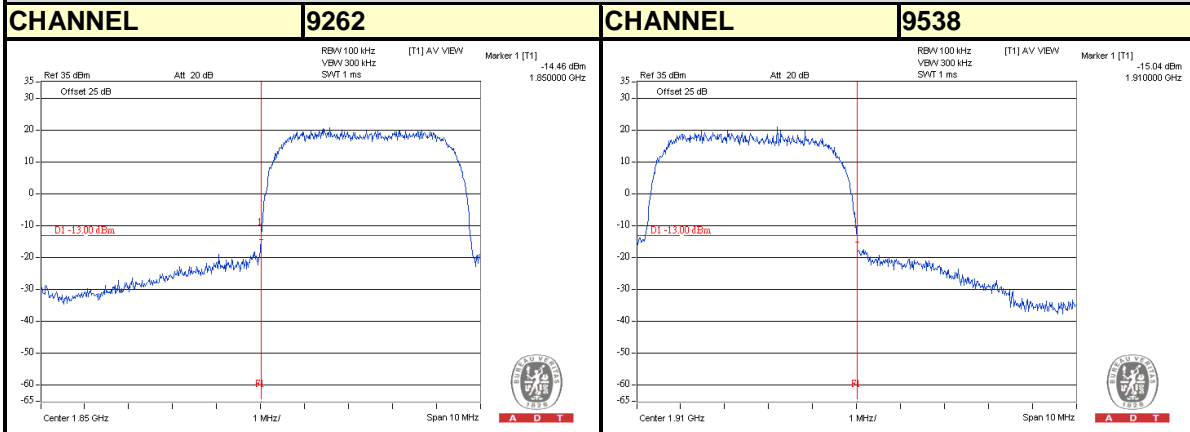

4.5 CONDUCTED SPURIOUS EMISSIONS

4.5.1 LIMITS OF CONDUCTED SPURIOUS EMISSIONS MEASUREMENT

The power of any emission outside of the authorized operating frequency ranges must be attenuated below the transmitting power (P) by a factor of at least $43 + 10 \log(P)$ dB. The emission limit equal to -13dBm .

4.5.2 TEST PROCEDURE

- a. The EUT makes a phone call to the communication simulator. All measurements were done at low, middle and high operational frequency range.
- b. Measuring frequency range is from 9kHz to 20GHz. 10dB attenuation pad is connected with spectrum. RBW=1MHz and VBW=3MHz is used for conducted emission measurement.

4.5.3 TEST SETUP

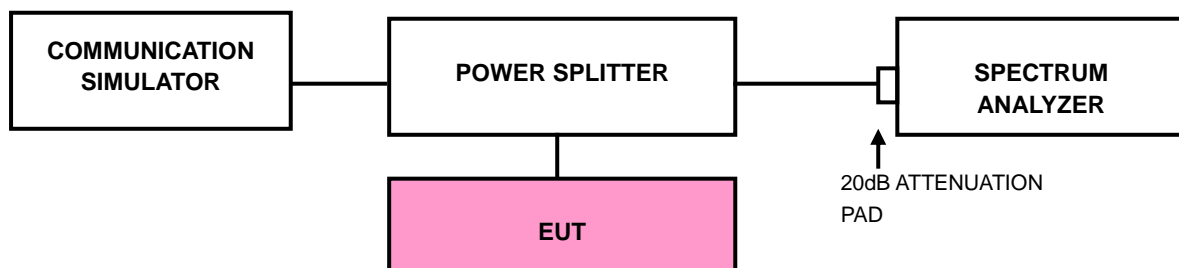



A D T

4.5.4 TEST RESULTS





A D T

GPRS

CHANNEL 661

FREQUENCY RANGE : 9kHz~3GHz

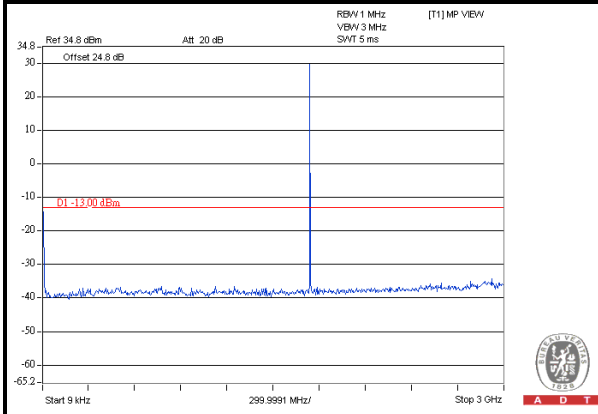

FREQUENCY RANGE : 3GHz~10GHz

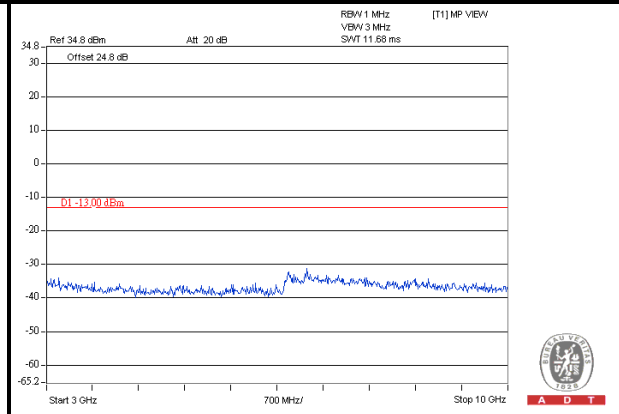

FREQUENCY RANGE : 10GHz~20GHz

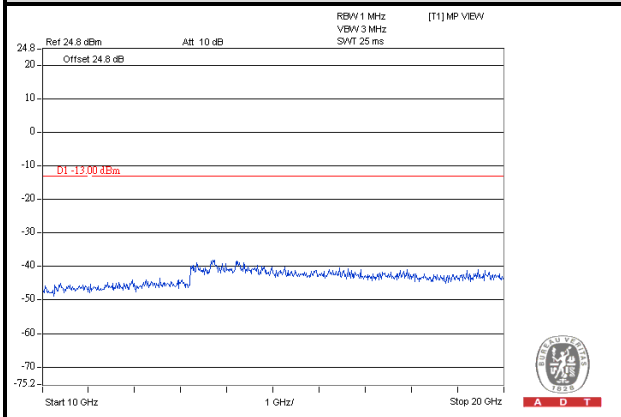



A D T

GPRS

CHANNEL 810

FREQUENCY RANGE : 9kHz~3GHz

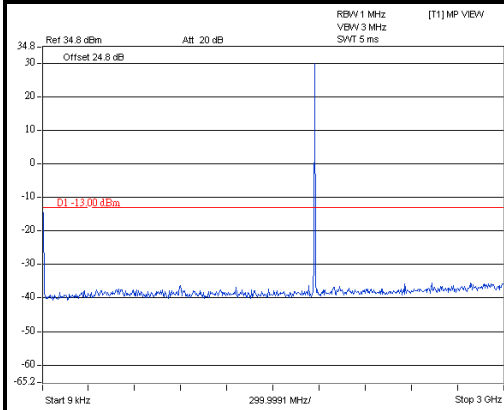

FREQUENCY RANGE : 3GHz~10GHz

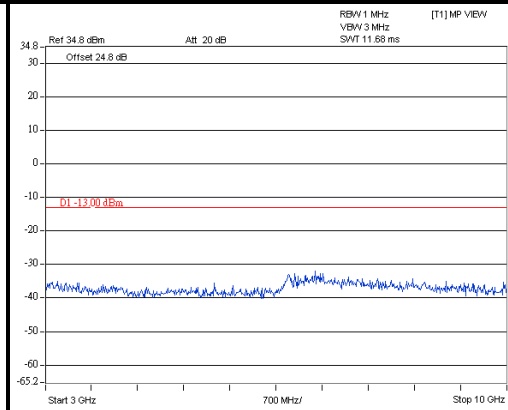

FREQUENCY RANGE : 10GHz~20GHz

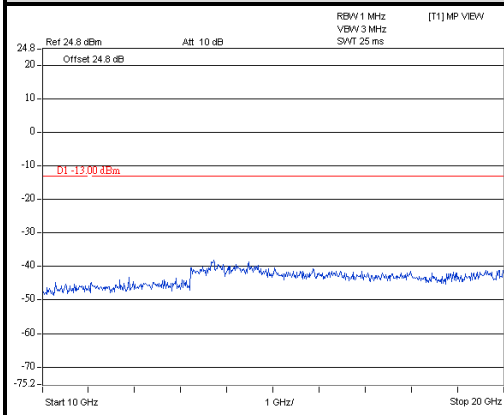



A D T

EDGE

CHANNEL 512

FREQUENCY RANGE : 9kHz~3GHz

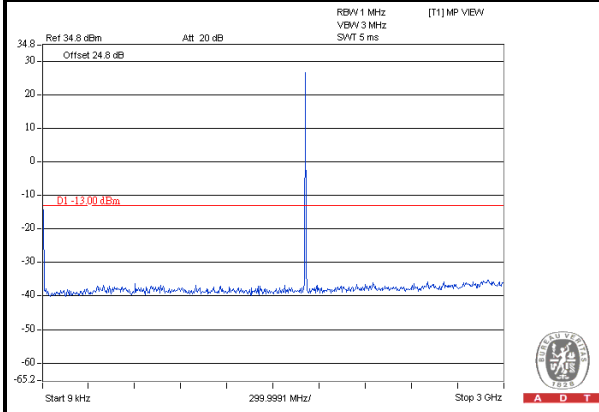

FREQUENCY RANGE : 3GHz~10GHz

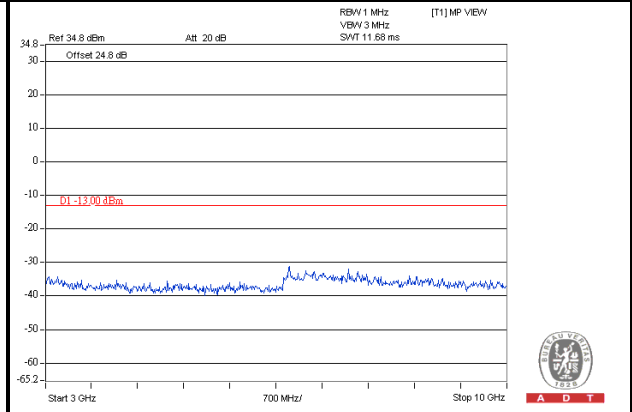

FREQUENCY RANGE : 10GHz~20GHz

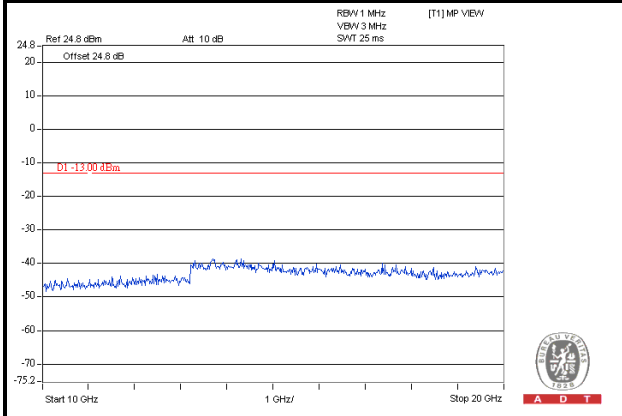



A D T

EDGE

CHANNEL 661

FREQUENCY RANGE : 9kHz~3GHz

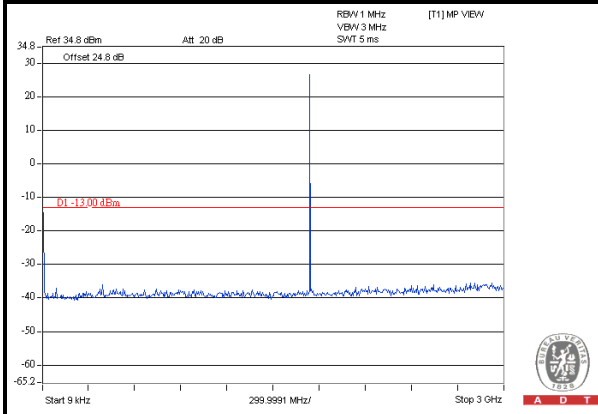

FREQUENCY RANGE : 3GHz~10GHz

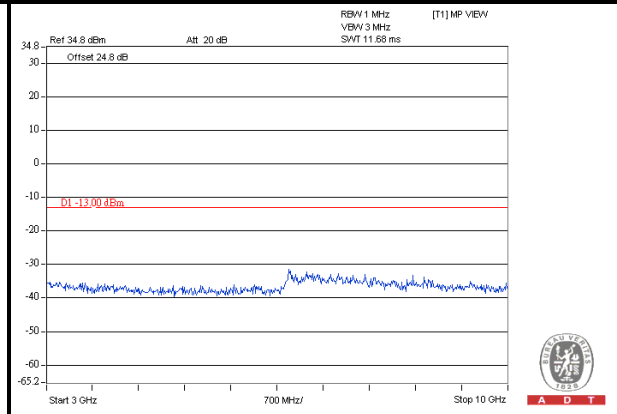

FREQUENCY RANGE : 10GHz~20GHz

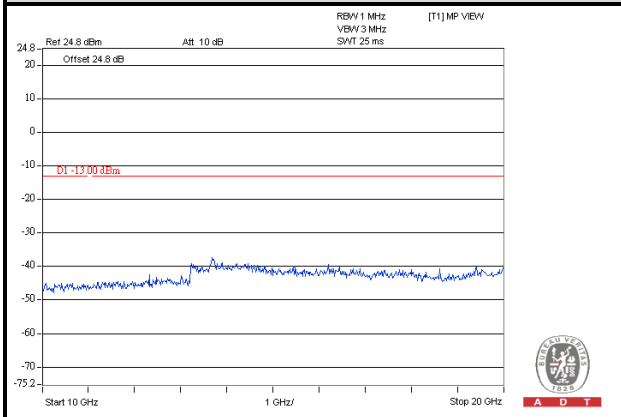



A D T

EDGE

CHANNEL 810

FREQUENCY RANGE : 9kHz~3GHz

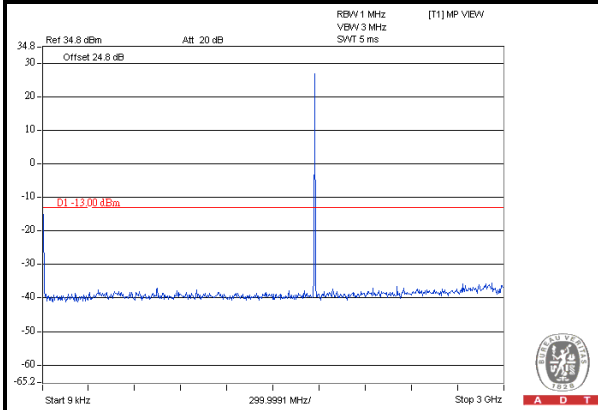

FREQUENCY RANGE : 3GHz~10GHz

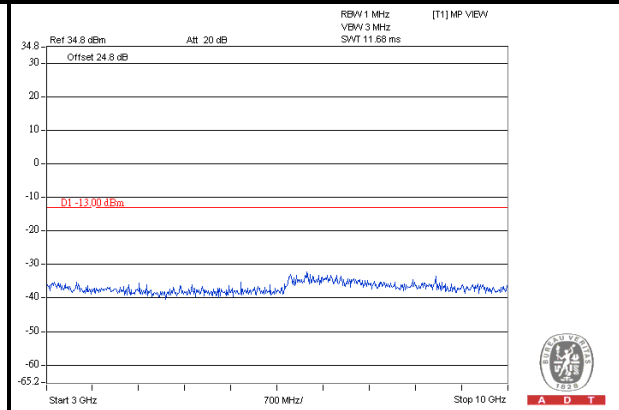

FREQUENCY RANGE : 10GHz~20GHz

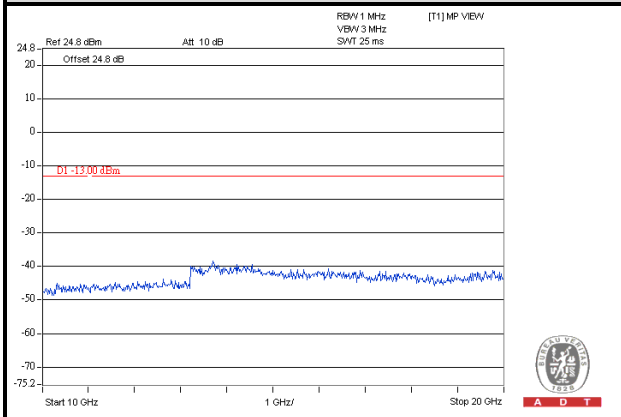



A D T

CDMA

CHANNEL 25

FREQUENCY RANGE : 9kHz~3GHz

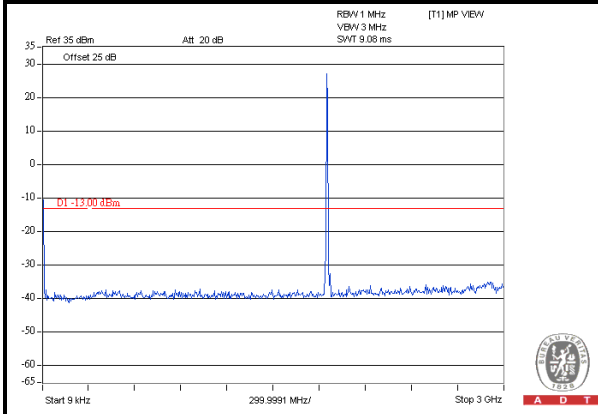

FREQUENCY RANGE : 3GHz~10GHz

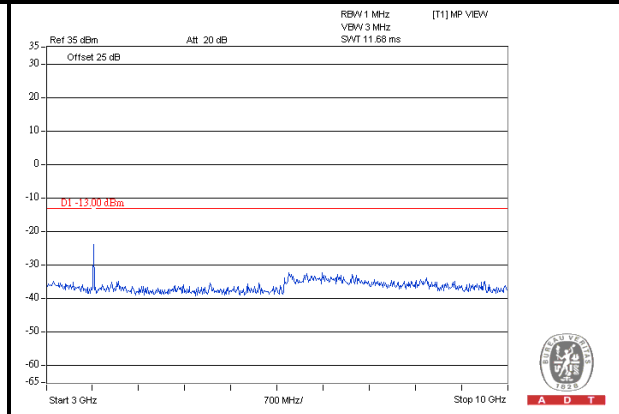

FREQUENCY RANGE : 10GHz~20GHz

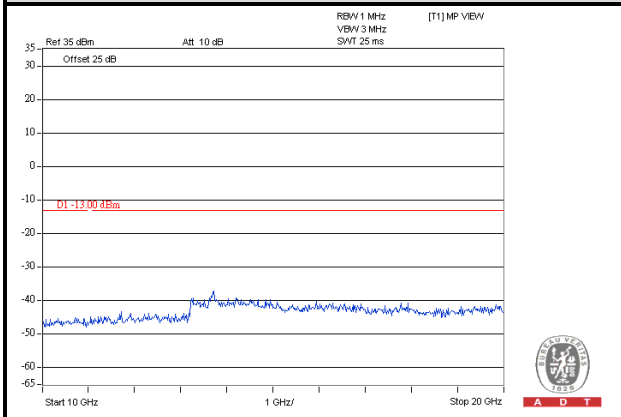



A D T

CDMA

CHANNEL 600

FREQUENCY RANGE : 9kHz~3GHz

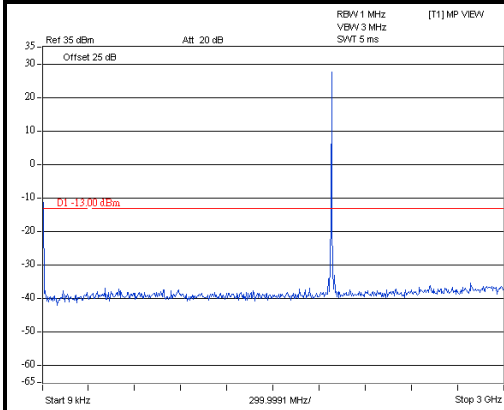

FREQUENCY RANGE : 3GHz~10GHz

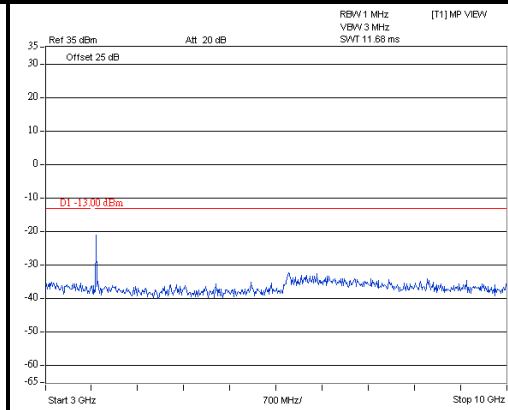

FREQUENCY RANGE : 10GHz~20GHz

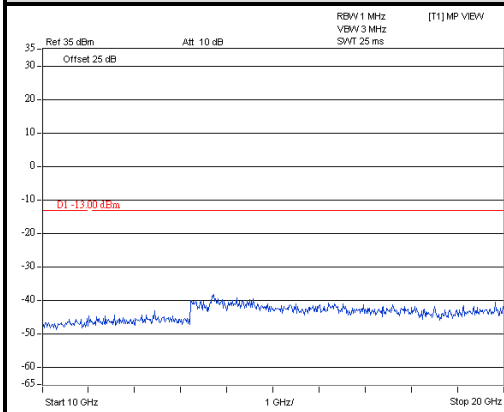



A D T

CDMA

CHANNEL 1175

FREQUENCY RANGE : 9kHz~3GHz

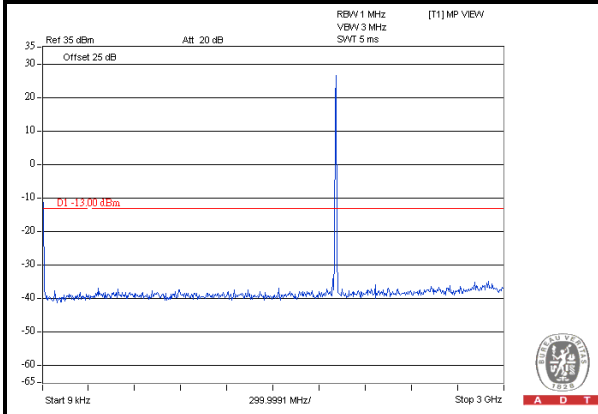

FREQUENCY RANGE : 3GHz~10GHz

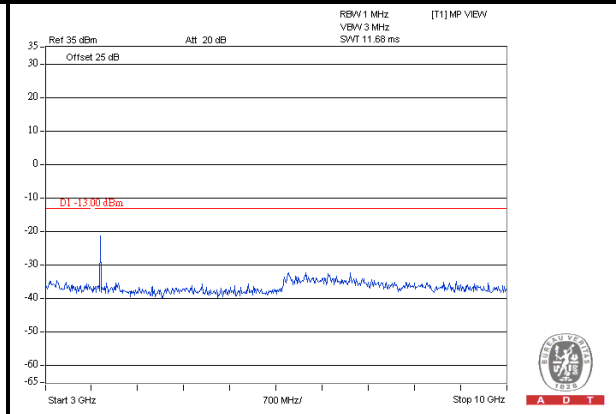

FREQUENCY RANGE : 10GHz~20GHz

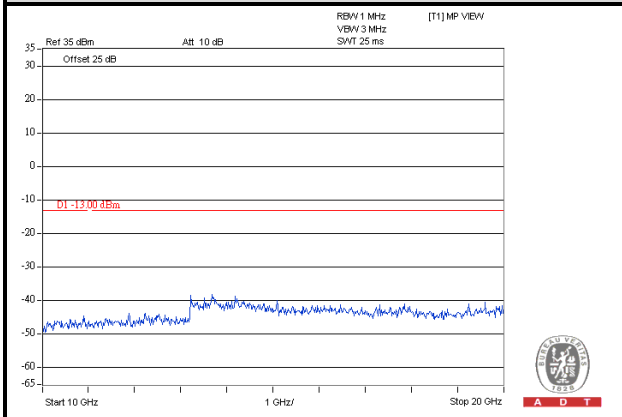



A D T

WCDMA

CHANNEL 9262

FREQUENCY RANGE : 9kHz~3GHz

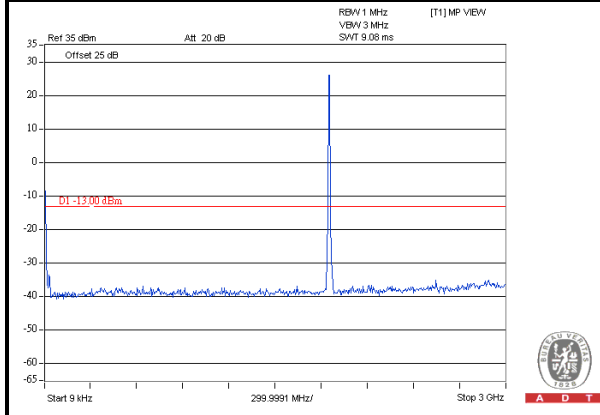

FREQUENCY RANGE : 3GHz~10GHz

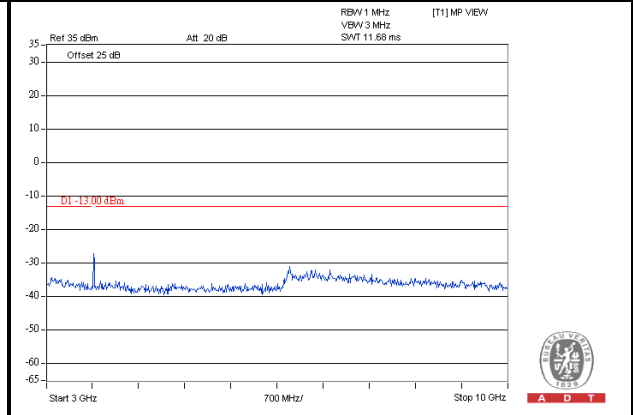

FREQUENCY RANGE : 10GHz~20GHz

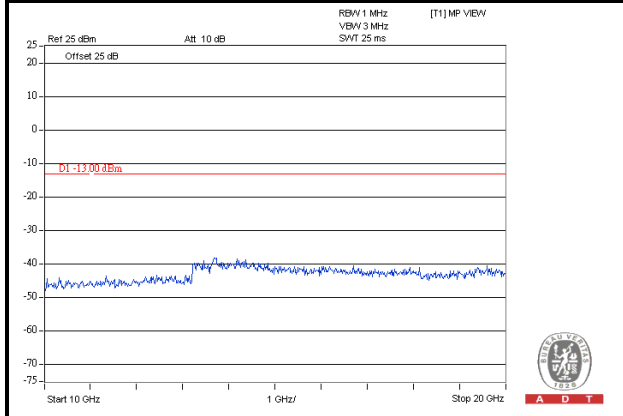



A D T

WCDMA

CHANNEL 9400

FREQUENCY RANGE : 9kHz~3GHz

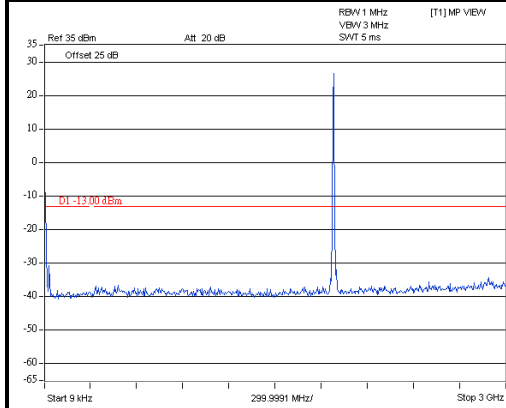

FREQUENCY RANGE : 3GHz~10GHz

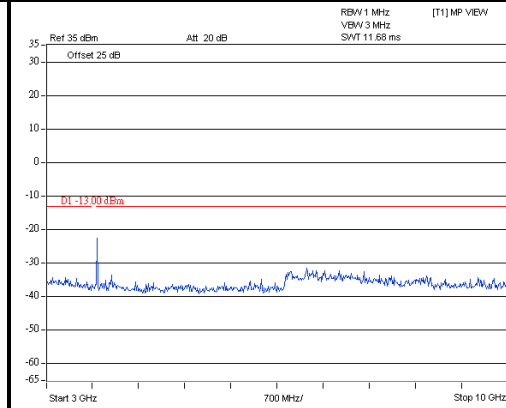

FREQUENCY RANGE : 10GHz~20GHz

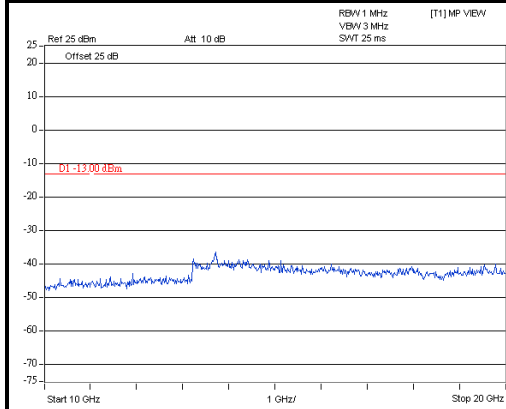



A D T

WCDMA

CHANNEL 9538

FREQUENCY RANGE : 9kHz~3GHz

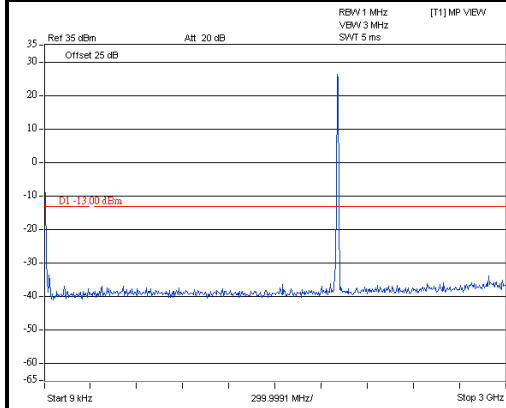

FREQUENCY RANGE : 3GHz~10GHz

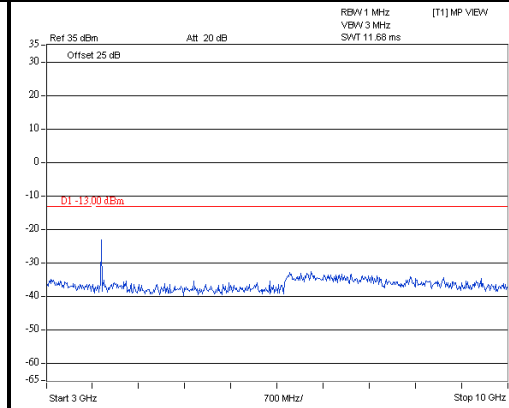

FREQUENCY RANGE : 10GHz~20GHz

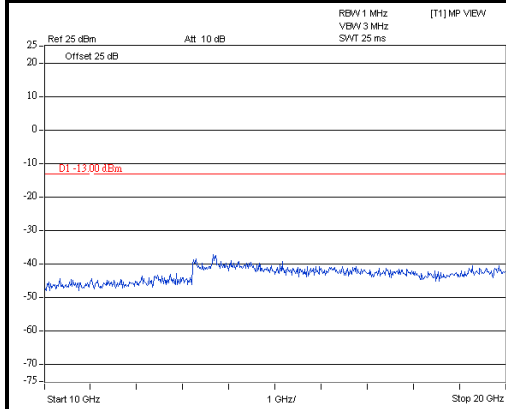

4.6 RADIATED EMISSION MEASUREMENT

4.6.1 LIMITS OF RADIATED EMISSION MEASUREMENT

The power of any emission outside of the authorized operating frequency ranges must be attenuated below the transmitting power (P) by a factor of at least $43 + 10 \log(P)$ dB. The emission limit equal to -13dBm .

4.6.2 TEST PROCEDURES

- a. Substitution method is used for E.I.R.P measurement. In the semi-anechoic chamber, EUT placed on the 0.8m height of Turn Table, rotated the table around 360 degrees to search the maximum radiation power and receiver antenna shall be rotated vertical and horizontal polarization and moved height from 1m to 4m to find the maximum polar radiated power. The “Read Value” is the spectrum reading the maximum power value.
- b. The substitution horn antenna is substituted for EUT at the same position and signals generator export the CW signal to the substitution antenna via a TX cable. Rotated the Turn Table and moved receiving antenna to find the maximum radiation power. Adjust output power level of S.G to get a Value of spectrum reading equal to “Read Value” of step a. Record the power level of S.G
- c. $\text{EIRP} = \text{Output power level of S.G} - \text{TX cable loss} + \text{Antenna gain of substitution horn}$.
- d. E.R.P power can be calculated form E.I.R.P power by subtracting the gain of dipole,
 $\text{E.R.P power} = \text{E.I.R.P power} - 2.15\text{dBi}$.

NOTE: The resolution bandwidth and video bandwidth of test receiver/spectrum analyzer is 1MHz/3MHz.

4.6.3 DEVIATION FROM TEST STANDARD

No deviation

4.6.4 TEST SETUP

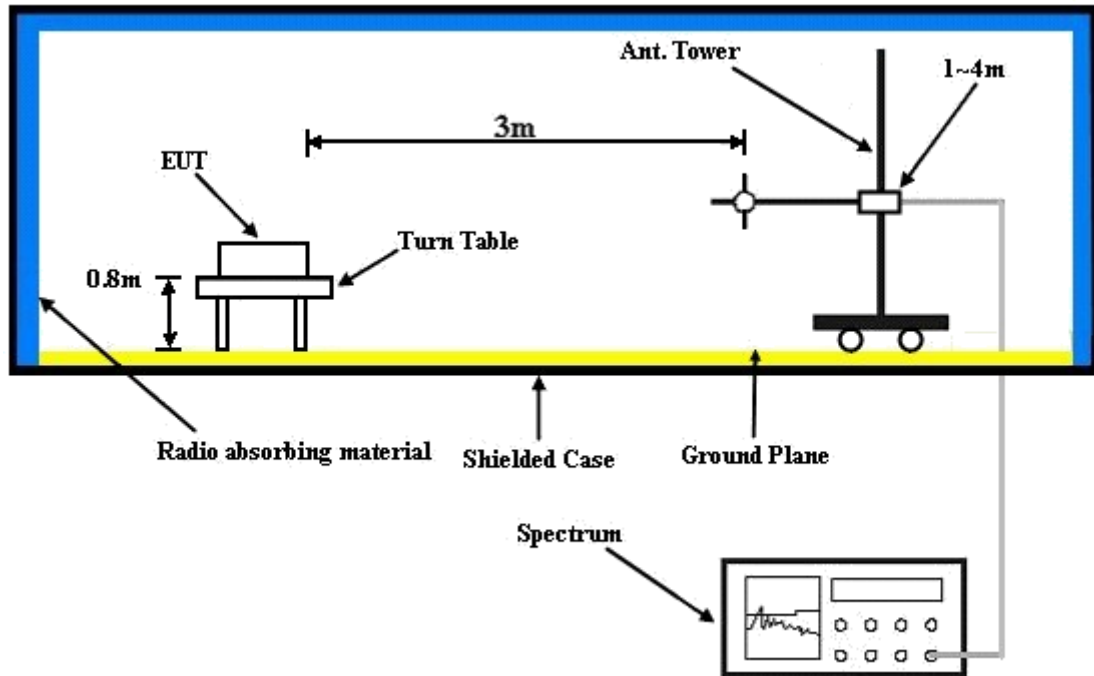

For the actual test configuration, please refer to the attached file (Test Setup Photo).



A D T

4.6.5 TEST RESULTS

BELOW 1GHz

GPRS

MODE	TX channel 810	FREQUENCY RANGE	Below 1000MHz
ENVIRONMENTAL CONDITIONS	25deg. C, 68%RH	INPUT POWER	120Vac, 60 Hz
TESTED BY	Sun Lin		

ANTENNA POLARITY & TEST DISTANCE: HORIZONTAL AT 3 M							
No.	Freq. (MHz)	Reading (dBm)	S.G Power Value (dBm)	Correction Factor (dB)	ERP (dBm)	Limit (dBm)	Margin (dB)
1	33.88	-48.51	-36.38	-12.13	-48.51	-13	-35.51
2	107.6	-56.86	-57.43	0.57	-56.86	-13	-43.86
3	130.88	-55.04	-55.04	0	-55.04	-13	-42.04
4	171.62	-62.42	-64.27	1.85	-62.42	-13	-49.42
5	237.58	-60.34	-65.75	5.41	-60.34	-13	-47.34
6	365.62	-59.84	-65.05	5.21	-59.84	-13	-46.84

ANTENNA POLARITY & TEST DISTANCE: VERTICAL AT 3 M							
No.	Freq. (MHz)	Reading (dBm)	S.G Power Value (dBm)	Correction Factor (dB)	ERP (dBm)	Limit (dBm)	Margin (dB)
1	30	-52.71	-40.1	-12.61	-52.71	-13	-39.71
2	94.02	-47.25	-48.28	1.03	-47.25	-13	-34.25
3	128.94	-54.5	-54.5	0	-54.5	-13	-41.5
4	243.4	-49.43	-54.84	5.41	-49.43	-13	-36.43
5	365.62	-50.3	-55.51	5.21	-50.3	-13	-37.3
6	553.8	-58.55	-63.17	4.62	-58.55	-13	-45.55

REMARKS:

1. Correction Factor = gain of substitution antenna + cable loss



A D T

CDMA

MODE	TX channel 600	FREQUENCY RANGE	Below 1000MHz
ENVIRONMENTAL CONDITIONS	25deg. C, 68%RH	INPUT POWER	120Vac, 60 Hz
TESTED BY	Sun Lin		

ANTENNA POLARITY & TEST DISTANCE: HORIZONTAL AT 3 M							
No.	Freq. (MHz)	Reading (dBm)	S.G Power Value (dBm)	Correction Factor (dB)	ERP (dBm)	Limit (dBm)	Margin (dB)
1	33.88	-49.53	-37.4	-12.13	-49.53	-13	-36.53
2	109.54	-57.02	-57.02	0	-57.02	-13	-44.02
3	130.88	-55.8	-55.8	0	-55.8	-13	-42.8
4	173.56	-61.54	-63.64	2.1	-61.54	-13	-48.54
5	237.58	-60.62	-66.03	5.41	-60.62	-13	-47.62
6	365.62	-60.15	-65.36	5.21	-60.15	-13	-47.15
ANTENNA POLARITY & TEST DISTANCE: VERTICAL AT 3 M							
No.	Freq. (MHz)	Reading (dBm)	S.G Power Value (dBm)	Correction Factor (dB)	ERP (dBm)	Limit (dBm)	Margin (dB)
1	30	-50.96	-38.35	-12.61	-50.96	-13	-37.96
2	107.6	-47.63	-48.2	0.57	-47.63	-13	-34.63
3	206.54	-51.42	-56.88	5.46	-51.42	-13	-38.42
4	241.46	-51.39	-56.8	5.41	-51.39	-13	-38.39
5	365.62	-50.45	-55.66	5.21	-50.45	-13	-37.45
6	483.96	-58.48	-63.42	4.94	-58.48	-13	-45.48

REMARKS:

- 1. Correction Factor = gain of substitution antenna + cable loss



A D T

WCDMA

MODE	TX channel 9400	FREQUENCY RANGE	Below 1000MHz
ENVIRONMENTAL CONDITIONS	25deg. C, 68%RH	INPUT POWER	120Vac, 60 Hz
TESTED BY	Sun Lin		

ANTENNA POLARITY & TEST DISTANCE: HORIZONTAL AT 3 M							
No.	Freq. (MHz)	Reading (dBm)	S.G Power Value (dBm)	Correction Factor (dB)	ERP (dBm)	Limit (dBm)	Margin (dB)
1	33.88	-48.62	-36.49	-12.13	-48.62	-13	-35.62
2	109.54	-56.95	-56.95	0	-56.95	-13	-43.95
3	130.88	-55.24	-55.24	0	-55.24	-13	-42.24
4	241.46	-61.69	-67.1	5.41	-61.69	-13	-48.69
5	363.68	-60.3	-65.52	5.22	-60.3	-13	-47.3
6	478.14	-56.03	-61	4.97	-56.03	-13	-43.03
ANTENNA POLARITY & TEST DISTANCE: VERTICAL AT 3 M							
No.	Freq. (MHz)	Reading (dBm)	S.G Power Value (dBm)	Correction Factor (dB)	ERP (dBm)	Limit (dBm)	Margin (dB)
1	30	-51.48	-38.87	-12.61	-51.48	-13	-38.48
2	94.02	-46.41	-47.44	1.03	-46.41	-13	-33.41
3	130.88	-53.55	-53.55	0	-53.55	-13	-40.55
4	239.52	-51.17	-56.58	5.41	-51.17	-13	-38.17
5	361.74	-50.77	-55.99	5.22	-50.77	-13	-37.77
6	485.9	-58.47	-63.41	4.94	-58.47	-13	-45.47

REMARKS:

1. Correction Factor = gain of substitution antenna + cable loss



A D T

ABOVE 1GHz

GPRS

MODE	TX channel 512	FREQUENCY RANGE	Above 1000MHz
ENVIRONMENTAL CONDITIONS	25deg. C, 68%RH	INPUT POWER	120Vac, 60 Hz
TESTED BY	Sun Lin		

ANTENNA POLARITY & TEST DISTANCE: HORIZONTAL AT 3 M							
No.	Freq. (MHz)	Reading (dBm)	S.G Power Value (dBm)	Correction Factor (dB)	ERP (dBm)	Limit (dBm)	Margin (dB)
1	3700.40 (PK)	-55.62	-53.9	7.16	-46.74	-13	-33.74
2	5550.60 (PK)	-55.48	-47.53	6.78	-40.75	-13	-27.75
3	7400.80 (PK)	-60.28	-46.9	4.31	-42.59	-13	-29.59
ANTENNA POLARITY & TEST DISTANCE: VERTICAL AT 3 M							
No.	Freq. (MHz)	Reading (dBm)	S.G Power Value (dBm)	Correction Factor (dB)	ERP (dBm)	Limit (dBm)	Margin (dB)
1	3700.40 (PK)	-55.94	-54.75	7.16	-47.59	-13	-34.59
2	5550.60 (PK)	-53.3	-48.34	6.78	-41.56	-13	-28.56
3	7400.80 (PK)	-59.88	-47.04	4.31	-42.73	-13	-29.73

REMARKS:

1. Correction Factor = gain of substitution antenna + cable loss



A D T

MODE	TX channel 661	FREQUENCY RANGE	Above 1000MHz
ENVIRONMENTAL CONDITIONS	25deg. C, 68%RH	INPUT POWER	120Vac, 60 Hz
TESTED BY	Sun Lin		

ANTENNA POLARITY & TEST DISTANCE: HORIZONTAL AT 3 M							
No.	Freq. (MHz)	Reading (dBm)	S.G Power Value (dBm)	Correction Factor (dB)	ERP (dBm)	Limit (dBm)	Margin (dB)
1	3760.00 (PK)	-53.8	-51.82	7.1	-44.72	-13	-31.72
2	5640.00 (PK)	-55.76	-47.6	6.77	-40.83	-13	-27.83
3	7520.00 (PK)	-60.51	-47.02	4.23	-42.79	-13	-29.79
ANTENNA POLARITY & TEST DISTANCE: VERTICAL AT 3 M							
No.	Freq. (MHz)	Reading (dBm)	S.G Power Value (dBm)	Correction Factor (dB)	ERP (dBm)	Limit (dBm)	Margin (dB)
1	3760.00 (PK)	-53.2	-51.94	7.1	-44.84	-13	-31.84
2	5640.00 (PK)	-53.8	-48.58	6.77	-41.81	-13	-28.81
3	7520.00 (PK)	-60.1	-46.86	4.23	-42.63	-13	-29.63

REMARKS:

1. Correction Factor = gain of substitution antenna + cable loss



A D T

MODE	TX channel 810	FREQUENCY RANGE	Above 1000MHz
ENVIRONMENTAL CONDITIONS	25deg. C, 68%RH	INPUT POWER	120Vac, 60 Hz
TESTED BY	Sun Lin		

ANTENNA POLARITY & TEST DISTANCE: HORIZONTAL AT 3 M							
No.	Freq. (MHz)	Reading (dBm)	S.G Power Value (dBm)	Correction Factor (dB)	ERP (dBm)	Limit (dBm)	Margin (dB)
1	3819.60 (PK)	-55.29	-53.07	7.06	-46.01	-13	-33.01
2	5729.40 (PK)	-55.1	-46.7	6.74	-39.96	-13	-26.96
3	7639.20 (PK)	-59.4	-45.73	4.2	-41.53	-13	-28.53
ANTENNA POLARITY & TEST DISTANCE: VERTICAL AT 3 M							
No.	Freq. (MHz)	Reading (dBm)	S.G Power Value (dBm)	Correction Factor (dB)	ERP (dBm)	Limit (dBm)	Margin (dB)
1	3819.60 (PK)	-55.8	-54.49	7.06	-47.43	-13	-34.43
2	5729.40 (PK)	-53.2	-47.69	6.74	-40.95	-13	-27.95
3	7639.20 (PK)	-60.3	-46.84	4.2	-42.64	-13	-29.64

REMARKS:

1. Correction Factor = gain of substitution antenna + cable loss



A D T

EDGE

MODE	TX channel 512	FREQUENCY RANGE	Above 1000MHz
ENVIRONMENTAL CONDITIONS	25deg. C, 68%RH	INPUT POWER	120Vac, 60 Hz
TESTED BY	Sun Lin		

ANTENNA POLARITY & TEST DISTANCE: HORIZONTAL AT 3 M							
No.	Freq. (MHz)	Reading (dBm)	S.G Power Value (dBm)	Correction Factor (dB)	ERP (dBm)	Limit (dBm)	Margin (dB)
1	3700.40 (PK)	-57.51	-55.79	7.16	-48.63	-13	-35.63
2	5550.60 (PK)	-57.72	-49.77	6.78	-42.99	-13	-29.99
3	7400.80 (PK)	-62.38	-49	4.31	-44.69	-13	-31.69

ANTENNA POLARITY & TEST DISTANCE: VERTICAL AT 3 M							
No.	Freq. (MHz)	Reading (dBm)	S.G Power Value (dBm)	Correction Factor (dB)	ERP (dBm)	Limit (dBm)	Margin (dB)
1	3700.40 (PK)	-58.2	-57.01	7.16	-49.85	-13	-36.85
2	5550.60 (PK)	-55.43	-50.47	6.78	-43.69	-13	-30.69
3	7400.80 (PK)	-62.11	-49.27	4.31	-44.96	-13	-31.96

REMARKS:

1. Correction Factor = gain of substitution antenna + cable loss



A D T

MODE	TX channel 661	FREQUENCY RANGE	Above 1000MHz
ENVIRONMENTAL CONDITIONS	25deg. C, 68%RH	INPUT POWER	120Vac, 60 Hz
TESTED BY	Sun Lin		

ANTENNA POLARITY & TEST DISTANCE: HORIZONTAL AT 3 M							
No.	Freq. (MHz)	Reading (dBm)	S.G Power Value (dBm)	Correction Factor (dB)	ERP (dBm)	Limit (dBm)	Margin (dB)
1	3760.00 (PK)	-55.93	-53.95	7.1	-46.85	-13	-33.85
2	5640.00 (PK)	-57.62	-49.46	6.77	-42.69	-13	-29.69
3	7520.00 (PK)	-62.1	-48.61	4.23	-44.38	-13	-31.38

ANTENNA POLARITY & TEST DISTANCE: VERTICAL AT 3 M							
No.	Freq. (MHz)	Reading (dBm)	S.G Power Value (dBm)	Correction Factor (dB)	ERP (dBm)	Limit (dBm)	Margin (dB)
1	3760.00 (PK)	-55.35	-54.09	7.1	-46.99	-13	-33.99
2	5640.00 (PK)	-55.83	-50.61	6.77	-43.84	-13	-30.84
3	7520.00 (PK)	-62.05	-48.81	4.23	-44.58	-13	-31.58

REMARKS:

1. Correction Factor = gain of substitution antenna + cable loss



A D T

MODE	TX channel 810	FREQUENCY RANGE	Above 1000MHz
ENVIRONMENTAL CONDITIONS	25deg. C, 68%RH	INPUT POWER	120Vac, 60 Hz
TESTED BY	Sun Lin		

ANTENNA POLARITY & TEST DISTANCE: HORIZONTAL AT 3 M							
No.	Freq. (MHz)	Reading (dBm)	S.G Power Value (dBm)	Correction Factor (dB)	ERP (dBm)	Limit (dBm)	Margin (dB)
1	3819.60 (PK)	-57.53	-55.31	7.06	-48.25	-13	-35.25
2	5729.40 (PK)	-57.5	-49.1	6.74	-42.36	-13	-29.36
3	7639.20 (PK)	-61.56	-47.89	4.2	-43.69	-13	-30.69
ANTENNA POLARITY & TEST DISTANCE: VERTICAL AT 3 M							
No.	Freq. (MHz)	Reading (dBm)	S.G Power Value (dBm)	Correction Factor (dB)	ERP (dBm)	Limit (dBm)	Margin (dB)
1	3819.60 (PK)	-58.03	-56.72	7.06	-49.66	-13	-36.66
2	5729.40 (PK)	-55.33	-49.82	6.74	-43.08	-13	-30.08
3	7639.20 (PK)	-63.49	-50.03	4.2	-45.83	-13	-32.83

REMARKS:

1. Correction Factor = gain of substitution antenna + cable loss



A D T

CDMA

MODE	TX channel 25	FREQUENCY RANGE	Above 1000MHz
ENVIRONMENTAL CONDITIONS	25deg. C, 68%RH	INPUT POWER	120Vac, 60 Hz
TESTED BY	Sun Lin		

ANTENNA POLARITY & TEST DISTANCE: HORIZONTAL AT 3 M							
No.	Freq. (MHz)	Reading (dBm)	S.G Power Value (dBm)	Correction Factor (dB)	ERP (dBm)	Limit (dBm)	Margin (dB)
1	3702.50 (PK)	-44.1	-42.37	7.16	-35.21	-13	-22.21
2	5553.75 (PK)	-60.1	-52.15	6.78	-45.37	-13	-32.37
3	7405.00 (PK)	-60.8	-47.42	4.31	-43.11	-13	-30.11
ANTENNA POLARITY & TEST DISTANCE: VERTICAL AT 3 M							
No.	Freq. (MHz)	Reading (dBm)	S.G Power Value (dBm)	Correction Factor (dB)	ERP (dBm)	Limit (dBm)	Margin (dB)
1	3702.50 (PK)	-44.7	-43.51	7.16	-36.35	-13	-23.35
2	5553.75 (PK)	-60.2	-55.24	6.78	-48.46	-13	-35.46
3	7405.00 (PK)	-61.7	-48.85	4.31	-44.54	-13	-31.54

REMARKS:

1. Correction Factor = gain of substitution antenna + cable loss



A D T

MODE	TX channel 600	FREQUENCY RANGE	Above 1000MHz
ENVIRONMENTAL CONDITIONS	25deg. C, 68%RH	INPUT POWER	120Vac, 60 Hz
TESTED BY	Sun Lin		

ANTENNA POLARITY & TEST DISTANCE: HORIZONTAL AT 3 M							
No.	Freq. (MHz)	Reading (dBm)	S.G Power Value (dBm)	Correction Factor (dB)	ERP (dBm)	Limit (dBm)	Margin (dB)
1	3760.00 (PK)	-42.86	-40.88	7.1	-33.78	-13	-20.78
2	5640.00 (PK)	-59.9	-51.74	6.77	-44.97	-13	-31.97
3	7520.00 (PK)	-60.4	-46.91	4.23	-42.68	-13	-29.68
ANTENNA POLARITY & TEST DISTANCE: VERTICAL AT 3 M							
No.	Freq. (MHz)	Reading (dBm)	S.G Power Value (dBm)	Correction Factor (dB)	ERP (dBm)	Limit (dBm)	Margin (dB)
1	3760.00 (PK)	-44.1	-42.84	7.1	-35.74	-13	-22.74
2	5640.00 (PK)	-60	-54.78	6.77	-48.01	-13	-35.01
3	7520.00 (PK)	-61.1	-47.86	4.23	-43.63	-13	-30.63

REMARKS:

1. Correction Factor = gain of substitution antenna + cable loss



A D T

MODE	TX channel 1175	FREQUENCY RANGE	Above 1000MHz
ENVIRONMENTAL CONDITIONS	25deg. C, 68%RH	INPUT POWER	120Vac, 60 Hz
TESTED BY	Sun Lin		

ANTENNA POLARITY & TEST DISTANCE: HORIZONTAL AT 3 M							
No.	Freq. (MHz)	Reading (dBm)	S.G Power Value (dBm)	Correction Factor (dB)	ERP (dBm)	Limit (dBm)	Margin (dB)
1	3817.50 (PK)	-37.27	-35.05	7.06	-27.99	-13	-14.99
2	5726.25 (PK)	-60.84	-52.45	6.74	-45.71	-13	-32.71
3	7635.00 (PK)	-61.1	-47.44	4.2	-43.24	-13	-30.24
ANTENNA POLARITY & TEST DISTANCE: VERTICAL AT 3 M							
No.	Freq. (MHz)	Reading (dBm)	S.G Power Value (dBm)	Correction Factor (dB)	ERP (dBm)	Limit (dBm)	Margin (dB)
1	3817.50 (PK)	-37.8	-36.49	7.06	-29.43	-13	-16.43
2	5726.25 (PK)	-59.25	-53.75	6.74	-47.01	-13	-34.01
3	7635.00 (PK)	-61.4	-47.95	4.2	-43.75	-13	-30.75

REMARKS:

1. Correction Factor = gain of substitution antenna + cable loss



A D T

WCDMA

MODE	TX channel 9262	FREQUENCY RANGE	Above 1000MHz
ENVIRONMENTAL CONDITIONS	25deg. C, 68%RH	INPUT POWER	120Vac, 60 Hz
TESTED BY	Sun Lin		

ANTENNA POLARITY & TEST DISTANCE: HORIZONTAL AT 3 M							
No.	Freq. (MHz)	Reading (dBm)	S.G Power Value (dBm)	Correction Factor (dB)	ERP (dBm)	Limit (dBm)	Margin (dB)
1	3704.80 (PK)	-46.85	-45.11	7.16	-37.95	-13	-24.95
2	5557.20 (PK)	-58.9	-50.94	6.78	-44.16	-13	-31.16
3	7409.60 (PK)	-58.8	-45.41	4.3	-41.11	-13	-28.11
ANTENNA POLARITY & TEST DISTANCE: VERTICAL AT 3 M							
No.	Freq. (MHz)	Reading (dBm)	S.G Power Value (dBm)	Correction Factor (dB)	ERP (dBm)	Limit (dBm)	Margin (dB)
1	3704.80 (PK)	-46.53	-45.34	7.16	-38.18	-13	-25.18
2	5557.20 (PK)	-58.2	-53.23	6.78	-46.45	-13	-33.45
3	7409.60 (PK)	-59.1	-46.22	4.3	-41.92	-13	-28.92

REMARKS:

1. Correction Factor = gain of substitution antenna + cable loss



A D T

MODE	TX channel 9400	FREQUENCY RANGE	Above 1000MHz
ENVIRONMENTAL CONDITIONS	25deg. C, 68%RH	INPUT POWER	120Vac, 60 Hz
TESTED BY	Sun Lin		

ANTENNA POLARITY & TEST DISTANCE: HORIZONTAL AT 3 M							
No.	Freq. (MHz)	Reading (dBm)	S.G Power Value (dBm)	Correction Factor (dB)	ERP (dBm)	Limit (dBm)	Margin (dB)
1	3760.00 (PK)	-43.42	-41.44	7.1	-34.34	-13	-21.34
2	5640.00 (PK)	-60.1	-51.94	6.77	-45.17	-13	-32.17
3	7520.00 (PK)	-59.8	-46.31	4.23	-42.08	-13	-29.08
ANTENNA POLARITY & TEST DISTANCE: VERTICAL AT 3 M							
No.	Freq. (MHz)	Reading (dBm)	S.G Power Value (dBm)	Correction Factor (dB)	ERP (dBm)	Limit (dBm)	Margin (dB)
1	3760.00 (PK)	-45.8	-44.54	7.1	-37.44	-13	-24.44
2	5640.00 (PK)	-61.7	-56.48	6.77	-49.71	-13	-36.71
3	7520.00 (PK)	-61	-47.76	4.23	-43.53	-13	-30.53

REMARKS:

1. Correction Factor = gain of substitution antenna + cable loss



A D T

MODE	TX channel 9538	FREQUENCY RANGE	Above 1000MHz
ENVIRONMENTAL CONDITIONS	25deg. C, 68%RH	INPUT POWER	120Vac, 60 Hz
TESTED BY	Sun Lin		

ANTENNA POLARITY & TEST DISTANCE: HORIZONTAL AT 3 M							
No.	Freq. (MHz)	Reading (dBm)	S.G Power Value (dBm)	Correction Factor (dB)	ERP (dBm)	Limit (dBm)	Margin (dB)
1	3815.20 (PK)	-34.67	-32.46	7.06	-25.4	-13	-12.4
2	5722.80 (PK)	-60.96	-52.58	6.74	-45.84	-13	-32.84
3	7630.40 (PK)	-60.8	-47.14	4.2	-42.94	-13	-29.94
ANTENNA POLARITY & TEST DISTANCE: VERTICAL AT 3 M							
No.	Freq. (MHz)	Reading (dBm)	S.G Power Value (dBm)	Correction Factor (dB)	ERP (dBm)	Limit (dBm)	Margin (dB)
1	3815.20 (PK)	-35.6	-34.29	7.06	-27.23	-13	-14.23
2	5722.80 (PK)	-61.75	-56.26	6.74	-49.52	-13	-36.52
3	7630.40 (PK)	-61.2	-47.75	4.2	-43.55	-13	-30.55

REMARKS:

1. Correction Factor = gain of substitution antenna + cable loss

5 PHOTOGRAPHS OF THE TEST CONFIGURATION

Please refer to the attached file (Test Setup Photo).



6 INFORMATION ON THE TESTING LABORATORIES

We, Bureau Veritas Consumer Products Services (H.K.) Ltd., Taoyuan Branch, were founded in 1988 to provide our best service in EMC, Radio, Telecom and Safety consultation. Our laboratories are accredited and approved according to ISO/IEC 17025.

If you have any comments, please feel free to contact us at the following:

Linko EMC/RF Lab:

Tel: 886-2-26052180

Fax: 886-2-26051924

Hsin Chu EMC/RF Lab:

Tel: 886-3-5935343

Fax: 886-3-5935342

Hwa Ya EMC/RF/Safety/Telecom Lab:

Tel: 886-3-3183232

Fax: 886-3-3270892

Email: service.adt@tw.bureauveritas.com

Web Site: www.bureauveritas-adt.com

The address and road map of all our labs can be found in our web site also.



A D T

7 APPENDIX A – MODIFICATIONS RECORDERS FOR ENGINEERING CHANGES TO THE EUT BY THE LAB

No any modifications were made to the EUT by the lab during the test.

---END---