



# PHOTOS EXHIBIT

**Report Number:** R14066249-EP1

**Applicant :** Abbott Diabetes Care Inc.  
1360 South Loop Road  
Alameda, CA, 94502 USA

**Model :** Project 45000

**FCC ID :** QXS-LIB03S

**IC :** 12106A-LIB03S

**EUT Description :** Freestyle Libre 3

**Test Standard(s) :** FCC 47 CFR PART 15 SUBPART C: 2022  
ISED RSS-247 ISSUE 2: 2017  
ISED RSS-GEN ISSUE 5 + A2: 2021

**Date Of Issue:**  
2022-03-29

**Prepared by:**  
UL LLC  
12 Laboratory Dr.  
Research Triangle Park, NC 27709 U.S.A.  
TEL: (919) 549-1400



## REPORT REVISION HISTORY

Rev.	Issue Date	Revisions	Revised By
V1	2022-03-29	Initial Issue	Haley Ackun

## TABLE OF CONTENTS

REPORT REVISION HISTORY.....	2
TABLE OF CONTENTS.....	3
1. SETUP DIAGRAM .....	4
2. SETUP PHOTOS .....	4
END OF PHOTOS EXHIBIT.....	10

## 1. SETUP DIAGRAM

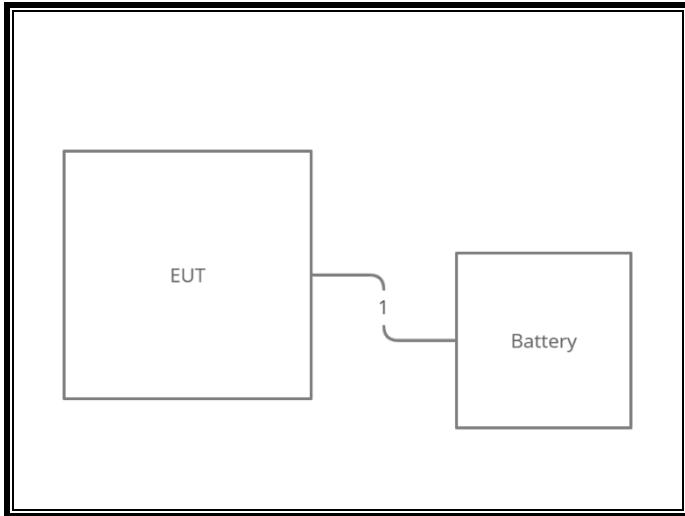

## 2. SETUP PHOTOS

### CONDUCTED RF MEASUREMENT SETUP

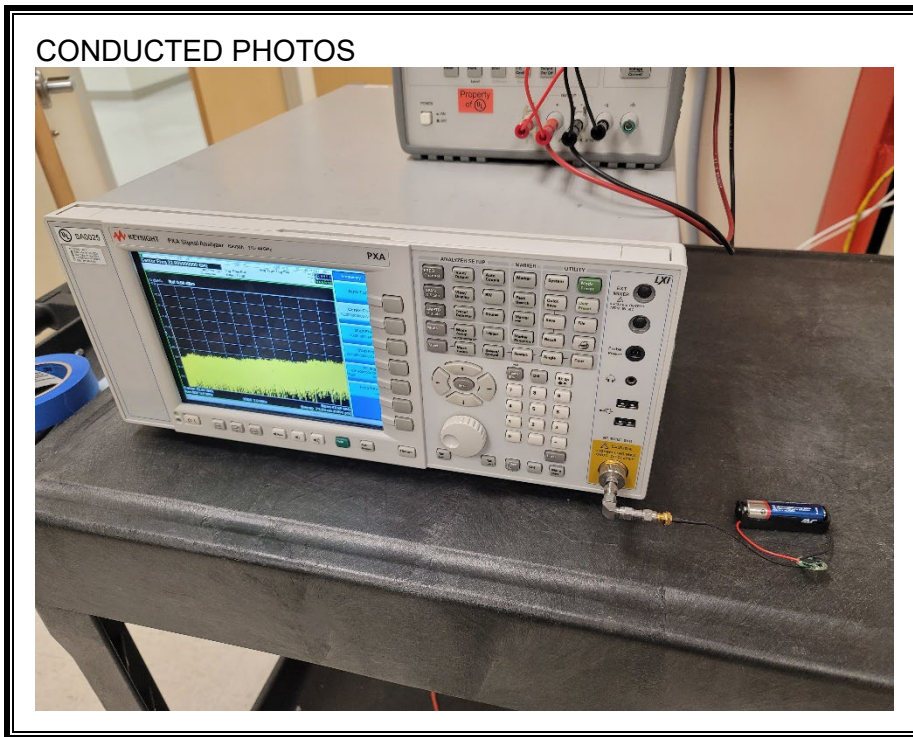

**RADIATED RF MEASUREMENT SETUP**

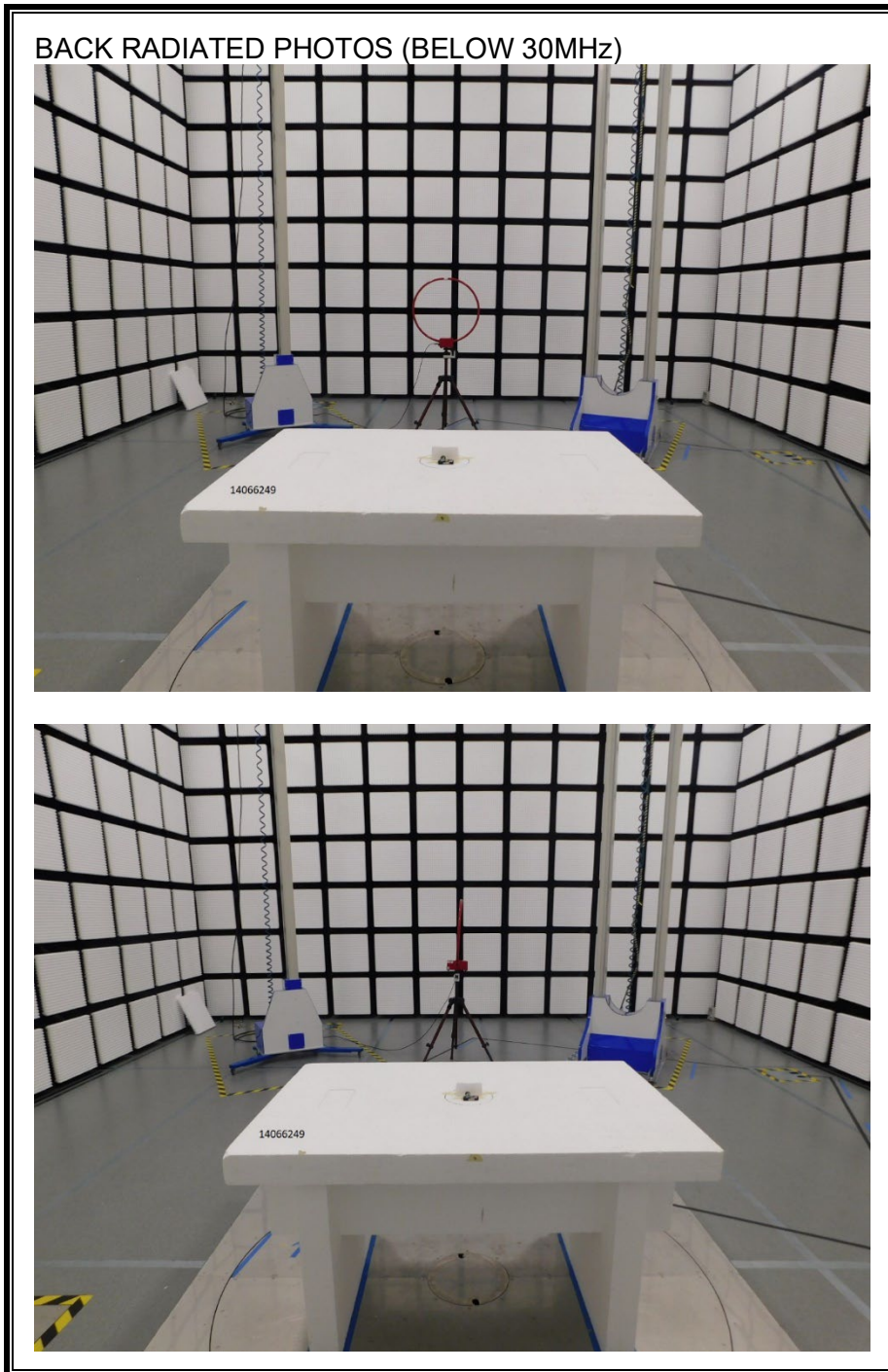

RADIATED PHOTO (BELOW 30MHz)

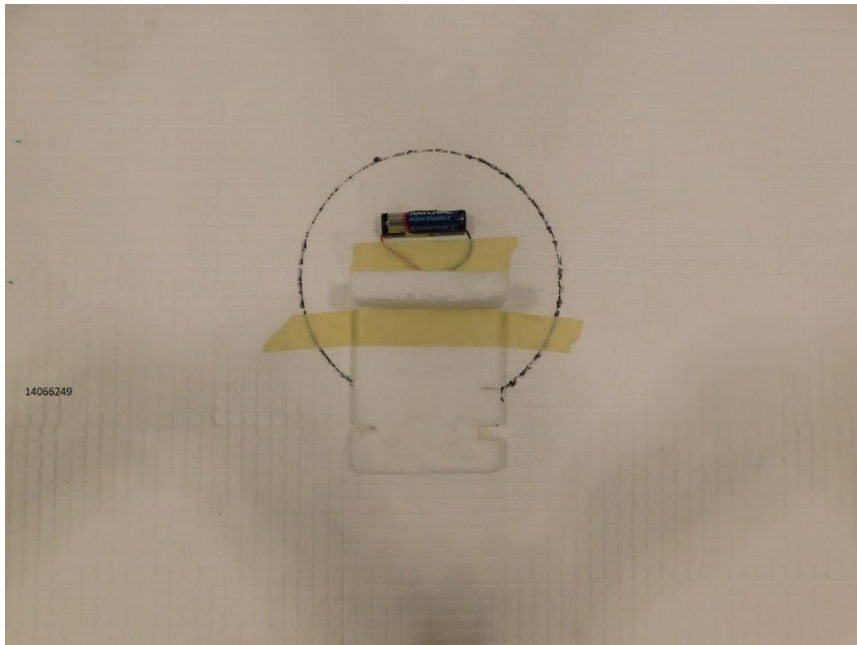
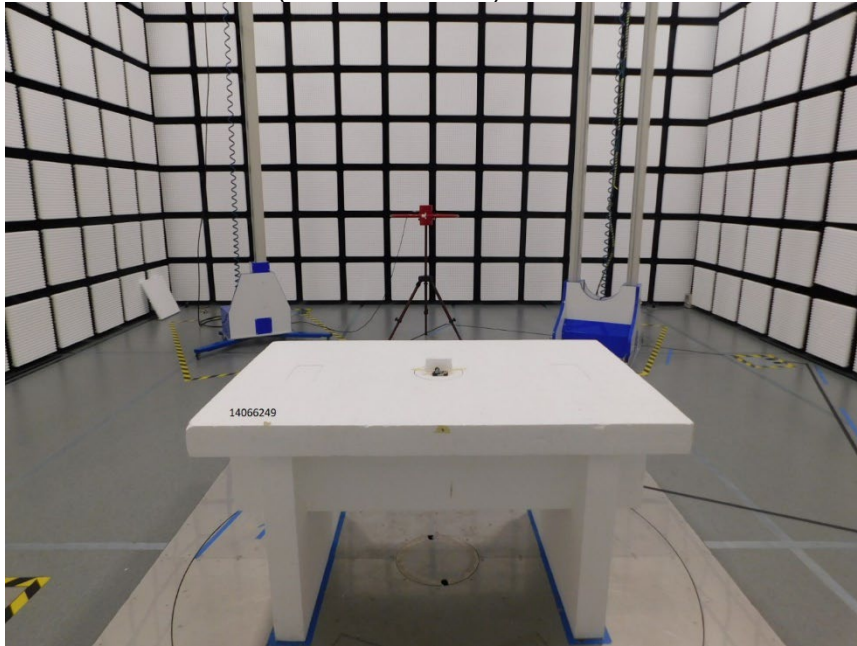



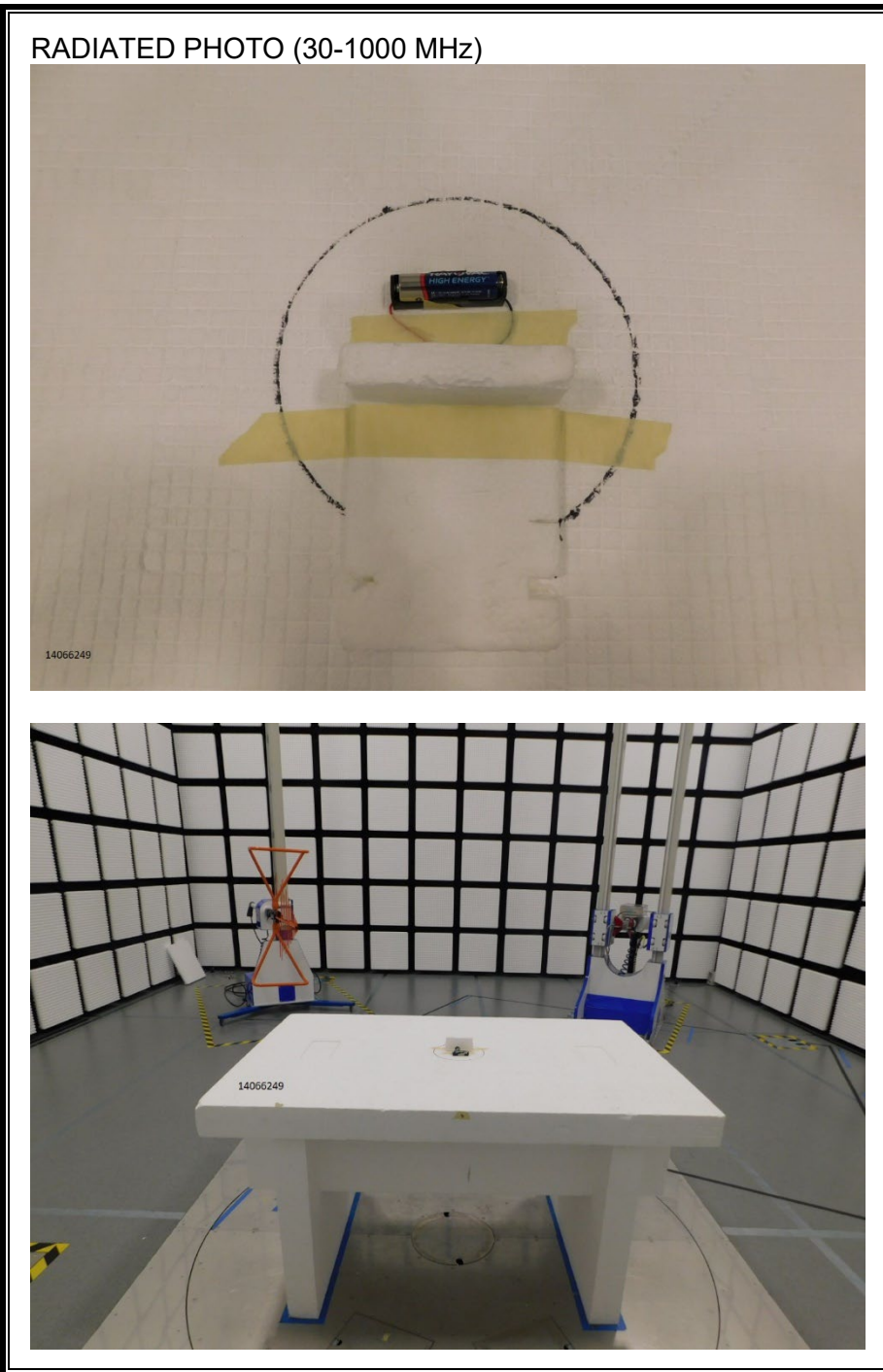

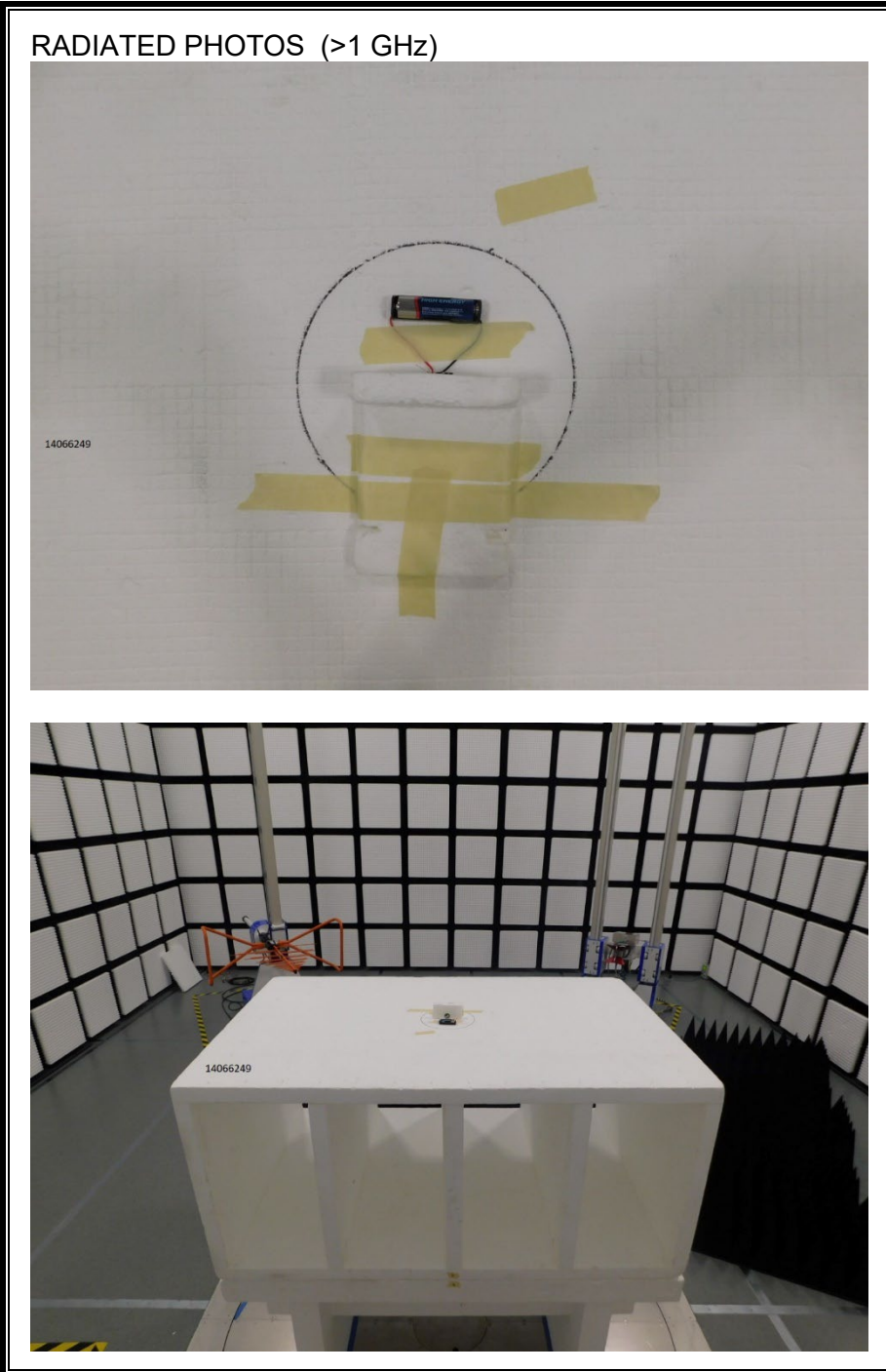



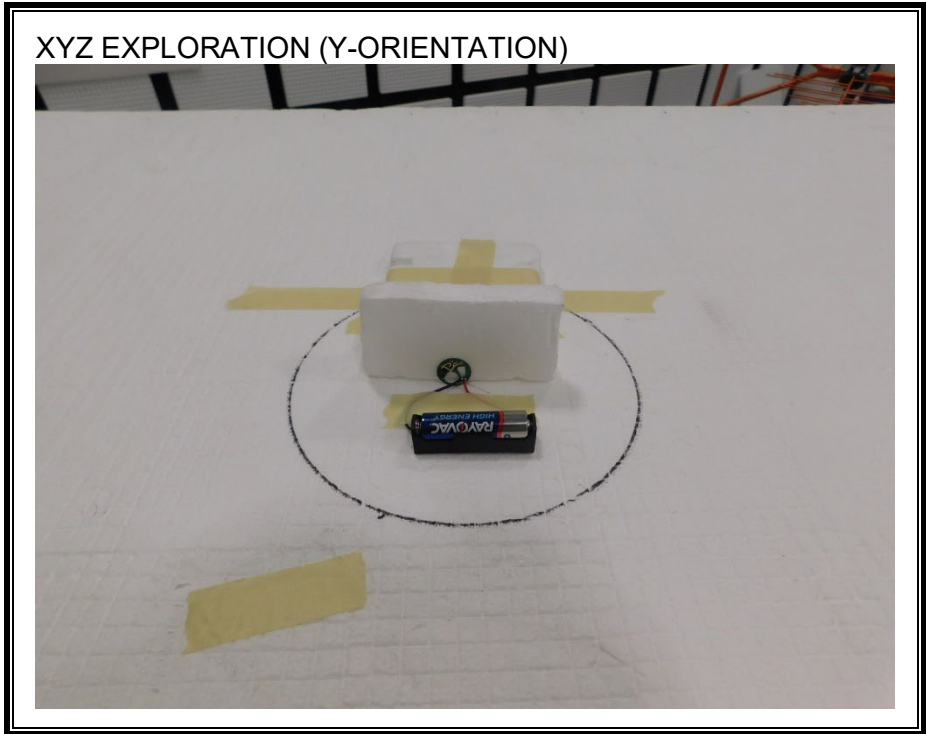
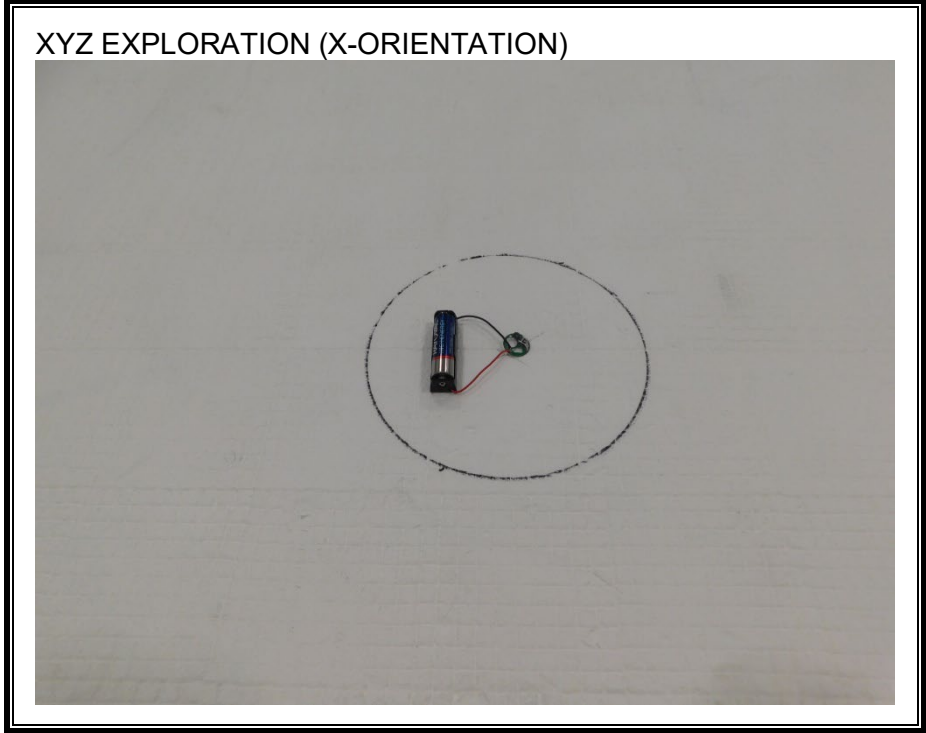

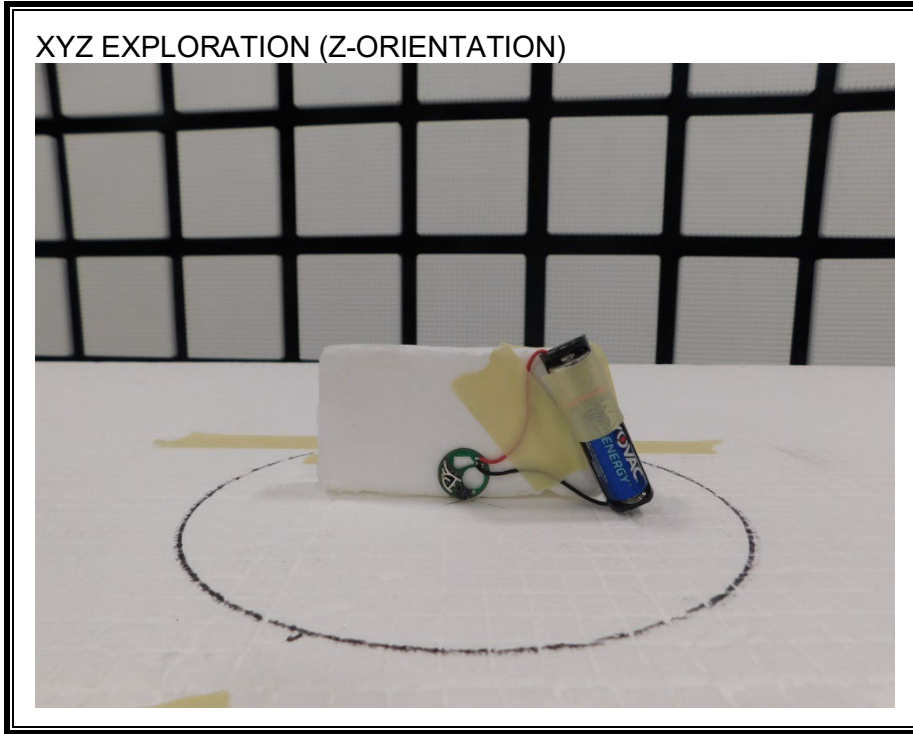

**END OF PHOTOS EXHIBIT**