

Profile: 2032034R	Page No.: 121
Engineer: Neil	
Site: AC5	Time: 2020/06/18 - 20:35
Limit: FCC_Part15.209_RE(3m)	Margin: 0
Probe: Horn_3117_00167055(1-18GHz)	Polarity: Vertical
EUT: Wireless Access Point	Power: AC 120V/60Hz
Note: Mode 4:Transmit at 5745MHz by 802.11ac(20MHz)	

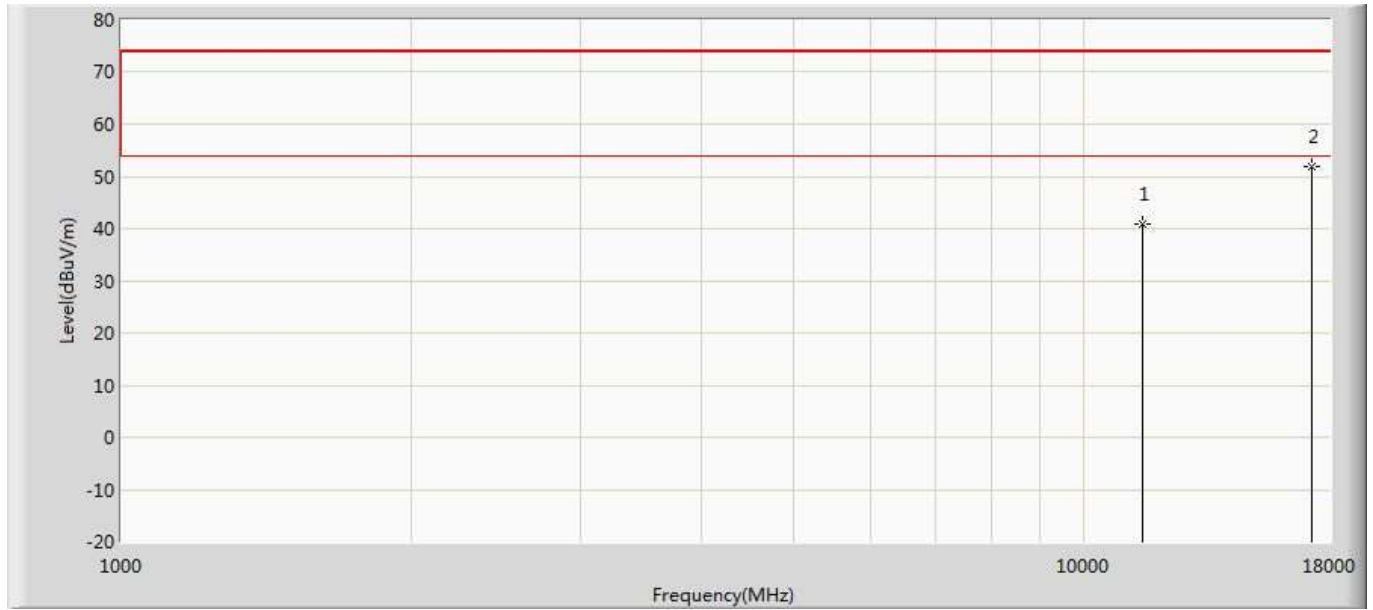

No	Mark	Frequency (MHz)	Measure Level (dBuV/m)	Reading Level (dBuV)	Over Limit (dB)	Limit (dBuV/m)	Factor (dB)	Type
1		11490.000	40.251	27.500	-33.749	74.000	12.751	PK
2	*	17235.000	51.144	30.918	-22.856	74.000	20.226	PK

Profile: 2032034R	Page No.: 122
Engineer: Neil	
Site: AC5	Time: 2020/06/18 - 20:35
Limit: FCC_Part15.209_RE(3m)	Margin: 0
Probe: Horn_3117_00167055(1-18GHz)	Polarity: Horizontal
EUT: Wireless Access Point	Power: AC 120V/60Hz
Note: Mode 4:Transmit at 5785MHz by 802.11ac(20MHz)	

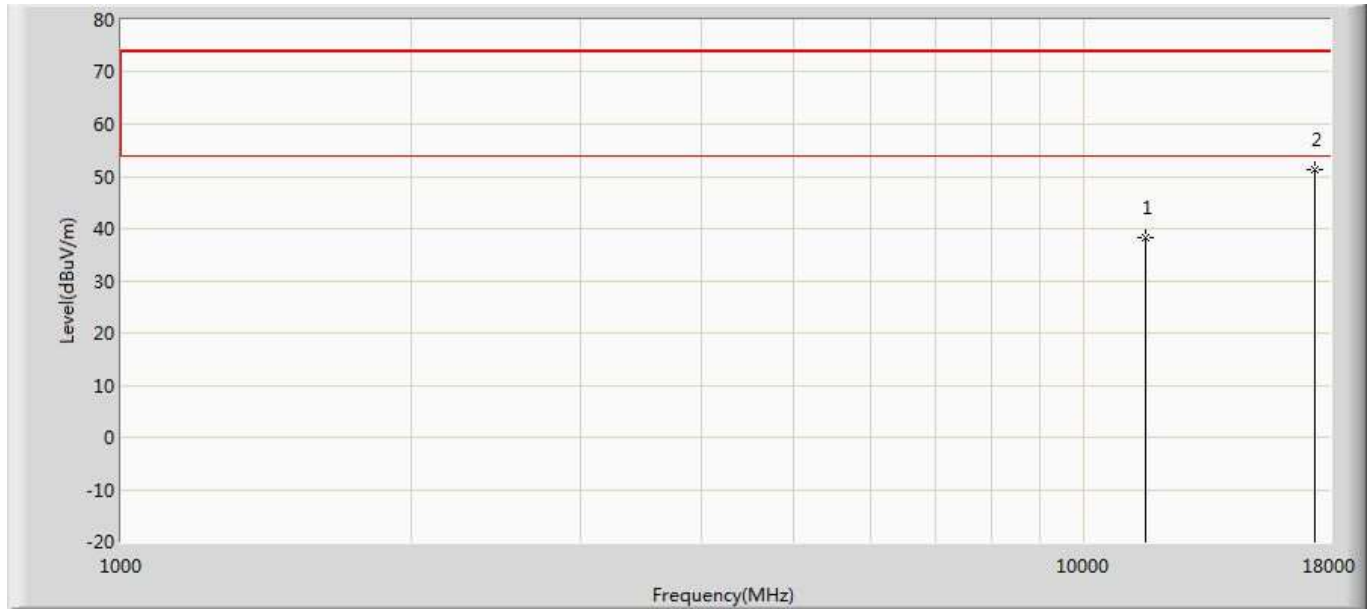

No	Mark	Frequency (MHz)	Measure Level (dBuV/m)	Reading Level (dBuV)	Over Limit (dB)	Limit (dBuV/m)	Factor (dB)	Type
1		11570.000	38.235	25.079	-35.765	74.000	13.156	PK
2	*	17355.000	50.707	27.709	-23.293	74.000	22.998	PK

Profile: 2032034R	Page No.: 123
Engineer: Neil	
Site: AC5	Time: 2020/06/18 - 20:36
Limit: FCC_Part15.209_RE(3m)	Margin: 0
Probe: Horn_3117_00167055(1-18GHz)	Polarity: Vertical
EUT: Wireless Access Point	Power: AC 120V/60Hz
Note: Mode 4:Transmit at 5785MHz by 802.11ac(20MHz)	

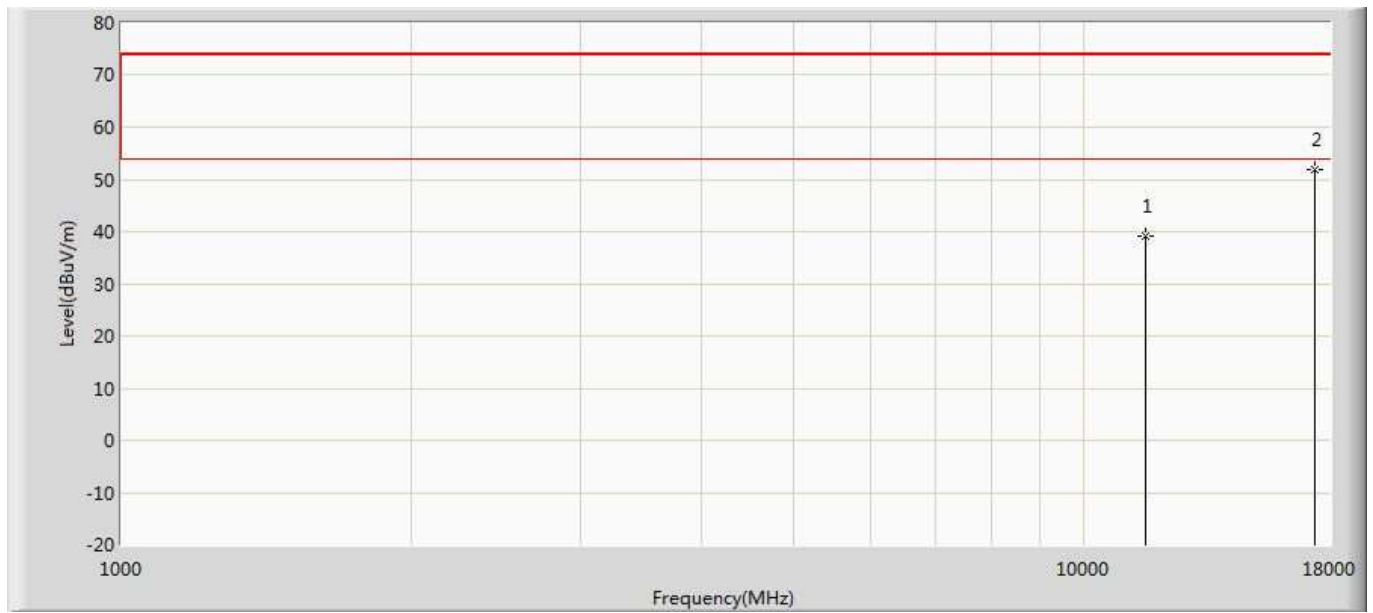

No	Mark	Frequency (MHz)	Measure Level (dBuV/m)	Reading Level (dBuV)	Over Limit (dB)	Limit (dBuV/m)	Factor (dB)	Type
1		11570.000	39.589	26.433	-34.411	74.000	13.156	PK
2	*	17355.000	52.351	29.353	-21.649	74.000	22.998	PK

Profile: 2032034R	Page No.: 124
Engineer: Neil	
Site: AC5	Time: 2020/06/18 - 20:36
Limit: FCC_Part15.209_RE(3m)	Margin: 0
Probe: Horn_3117_00167055(1-18GHz)	Polarity: Horizontal
EUT: Wireless Access Point	Power: AC 120V/60Hz
Note: Mode 4:Transmit at 5825MHz by 802.11ac(20MHz)	

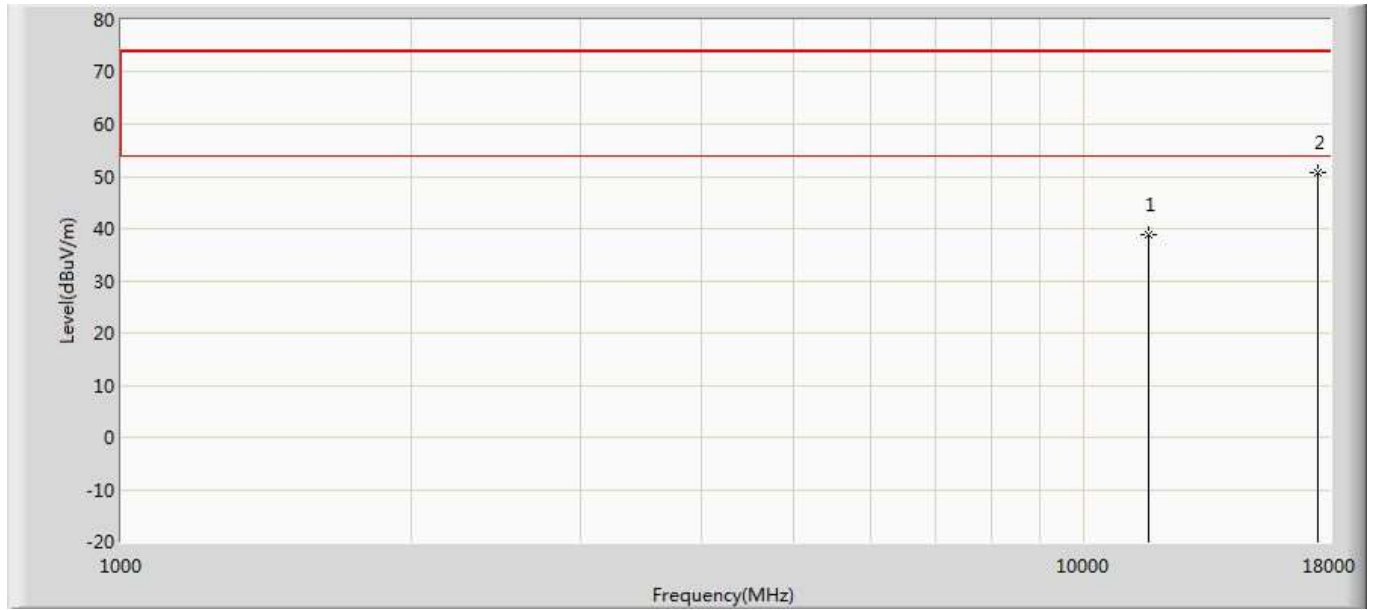

No	Mark	Frequency (MHz)	Measure Level (dBuV/m)	Reading Level (dBuV)	Over Limit (dB)	Limit (dBuV/m)	Factor (dB)	Type
1		11650.000	38.876	24.987	-35.124	74.000	13.889	PK
2	*	17475.000	50.271	28.688	-23.729	74.000	21.583	PK

Profile: 2032034R	Page No.: 125
Engineer: Neil	
Site: AC5	Time: 2020/06/18 - 20:36
Limit: FCC_Part15.209_RE(3m)	Margin: 0
Probe: Horn_3117_00167055(1-18GHz)	Polarity: Vertical
EUT: Wireless Access Point	Power: AC 120V/60Hz
Note: Mode 4:Transmit at 5825MHz by 802.11ac(20MHz)	

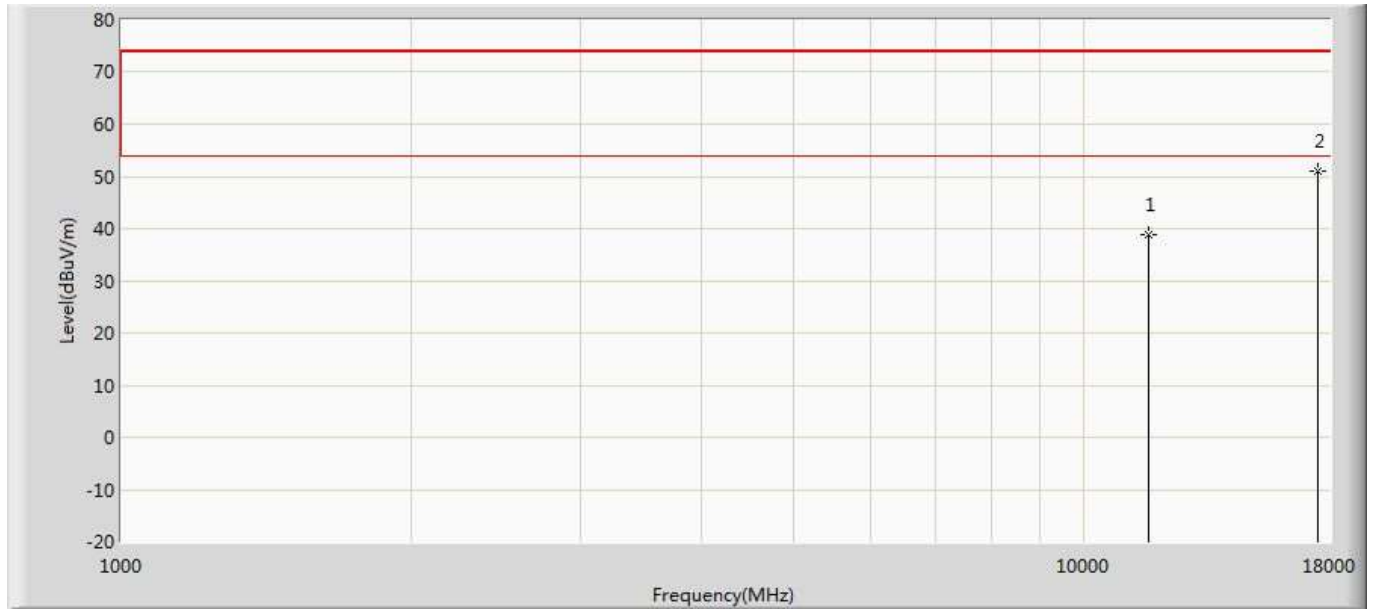

No	Mark	Frequency (MHz)	Measure Level (dBuV/m)	Reading Level (dBuV)	Over Limit (dB)	Limit (dBuV/m)	Factor (dB)	Type
1		11650.000	39.460	25.571	-34.540	74.000	13.889	PK
2	*	17475.000	50.469	28.886	-23.531	74.000	21.583	PK

Profile: 2032034R	Page No.: 126
Engineer: Neil	
Site: AC5	Time: 2020/06/18 - 20:37
Limit: FCC_Part15.209_RE(3m)	Margin: 0
Probe: Horn_3117_00167055(1-18GHz)	Polarity: Horizontal
EUT: Wireless Access Point	Power: AC 120V/60Hz
Note: Mode 5:Transmit at 5190MHz by 802.11ac(40MHz)	

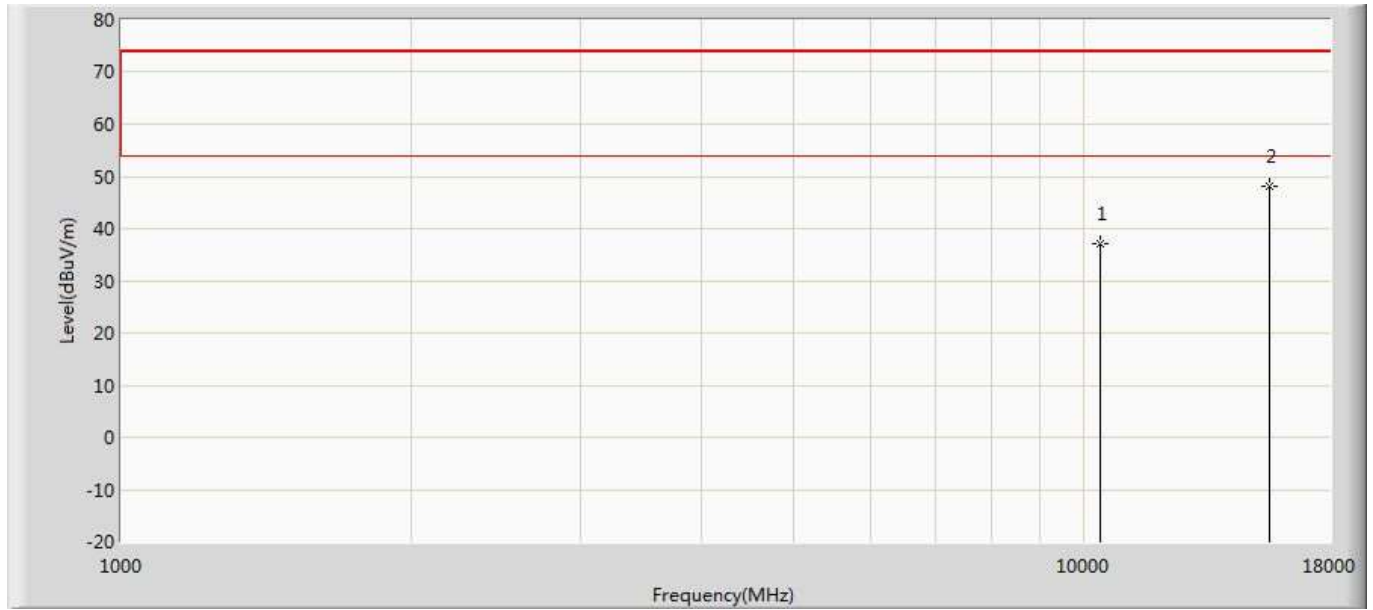

No	Mark	Frequency (MHz)	Measure Level (dBuV/m)	Reading Level (dBuV)	Over Limit (dB)	Limit (dBuV/m)	Factor (dB)	Type
1		10380.000	36.182	25.019	-37.818	74.000	11.163	PK
2	*	15570.000	47.430	30.401	-26.570	74.000	17.029	PK

Profile: 2032034R	Page No.: 127
Engineer: Neil	
Site: AC5	Time: 2020/06/18 - 20:37
Limit: FCC_Part15.209_RE(3m)	Margin: 0
Probe: Horn_3117_00167055(1-18GHz)	Polarity: Vertical
EUT: Wireless Access Point	Power: AC 120V/60Hz
Note: Mode 5:Transmit at 5190MHz by 802.11ac(40MHz)	

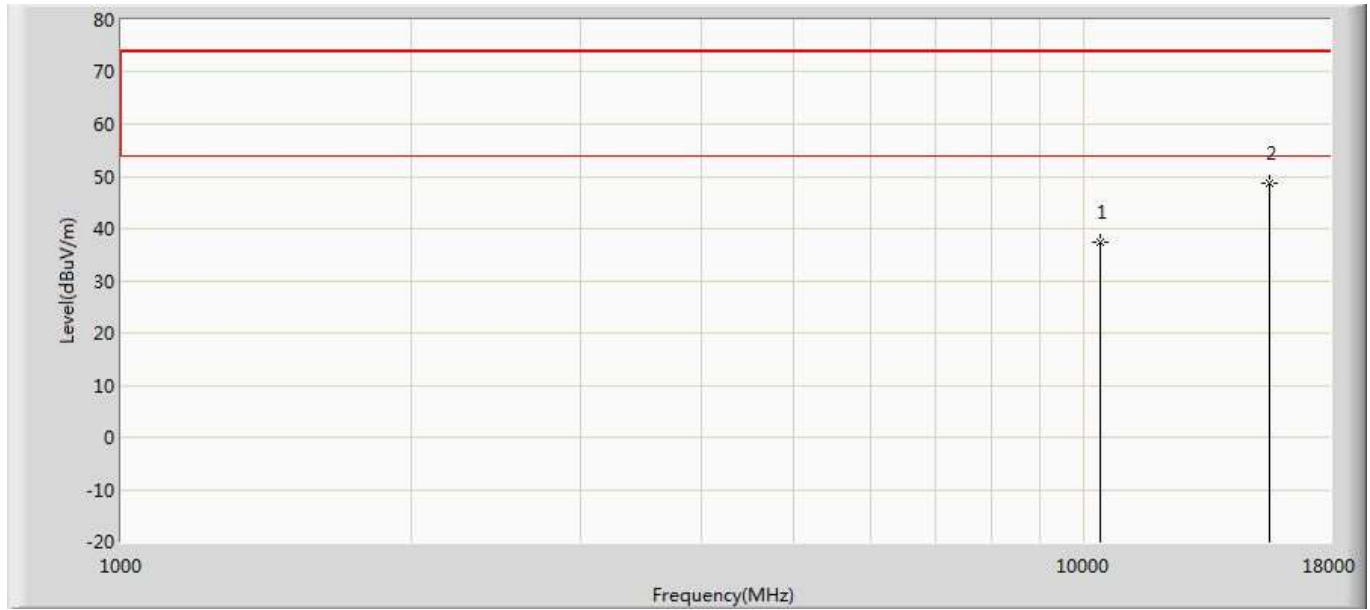

No	Mark	Frequency (MHz)	Measure Level (dBuV/m)	Reading Level (dBuV)	Over Limit (dB)	Limit (dBuV/m)	Factor (dB)	Type
1		10380.000	37.368	26.205	-36.632	74.000	11.163	PK
2	*	15570.000	49.142	32.113	-24.858	74.000	17.029	PK

Profile: 2032034R	Page No.: 128
Engineer: Neil	
Site: AC5	Time: 2020/06/18 - 20:37
Limit: FCC_Part15.209_RE(3m)	Margin: 0
Probe: Horn_3117_00167055(1-18GHz)	Polarity: Horizontal
EUT: Wireless Access Point	Power: AC 120V/60Hz
Note: Mode 5:Transmit at 5230MHz by 802.11ac(40MHz)	

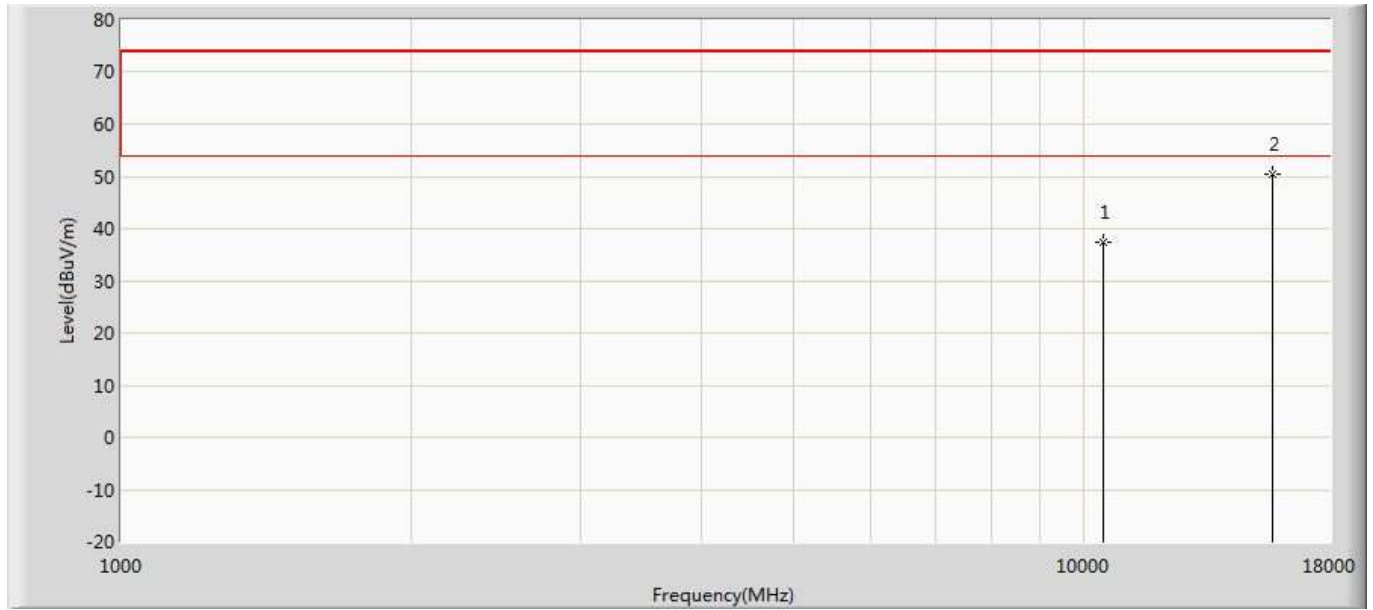

No	Mark	Frequency (MHz)	Measure Level (dBuV/m)	Reading Level (dBuV)	Over Limit (dB)	Limit (dBuV/m)	Factor (dB)	Type
1		10460.000	37.104	26.137	-36.896	74.000	10.967	PK
2	*	15690.000	50.813	32.237	-23.187	74.000	18.576	PK



Profile: 2032034R	Page No.: 129
Engineer: Neil	
Site: AC5	Time: 2020/06/18 - 20:38
Limit: FCC_Part15.209_RE(3m)	Margin: 0
Probe: Horn_3117_00167055(1-18GHz)	Polarity: Vertical
EUT: Wireless Access Point	Power: AC 120V/60Hz
Note: Mode 5:Transmit at 5230MHz by 802.11ac(40MHz)	

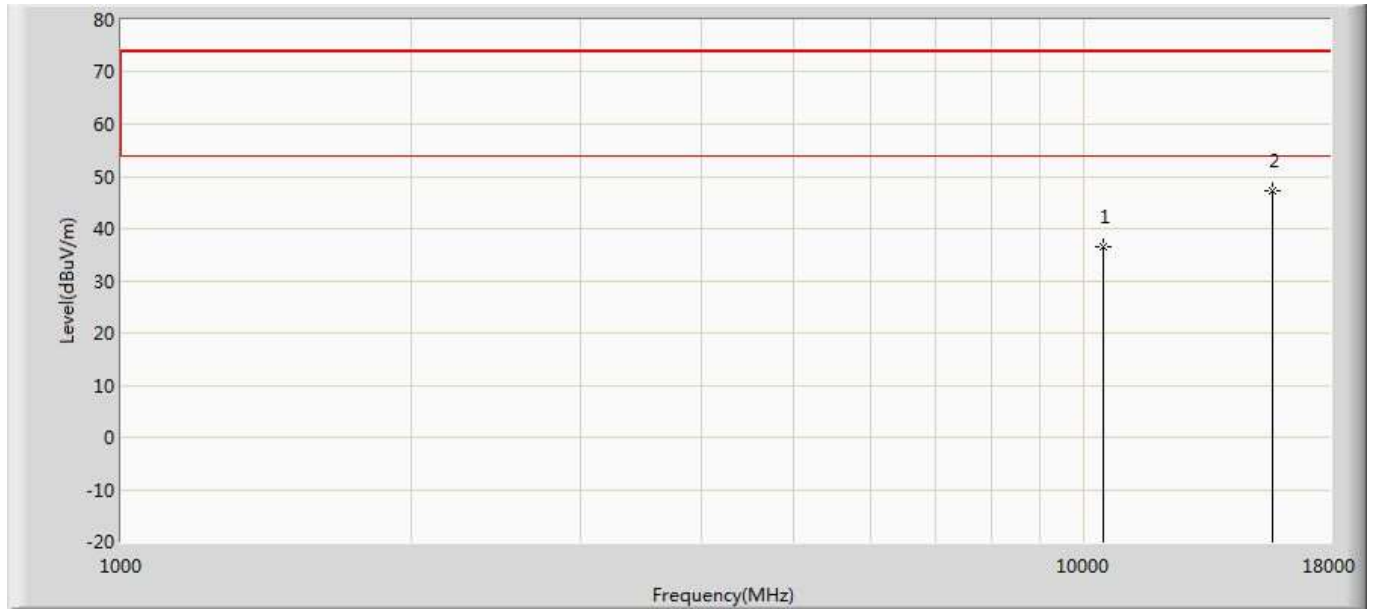

No	Mark	Frequency (MHz)	Measure Level (dBuV/m)	Reading Level (dBuV)	Over Limit (dB)	Limit (dBuV/m)	Factor (dB)	Type
1		10460.000	36.543	25.576	-37.457	74.000	10.967	PK
2	*	15690.000	47.617	29.041	-26.383	74.000	18.576	PK

Profile: 2032034R	Page No.: 130
Engineer: Neil	
Site: AC5	Time: 2020/06/18 - 20:38
Limit: FCC_Part15.209_RE(3m)	Margin: 0
Probe: Horn_3117_00167055(1-18GHz)	Polarity: Horizontal
EUT: Wireless Access Point	Power: AC 120V/60Hz
Note: Mode 5:Transmit at 5755MHz by 802.11ac(40MHz)	

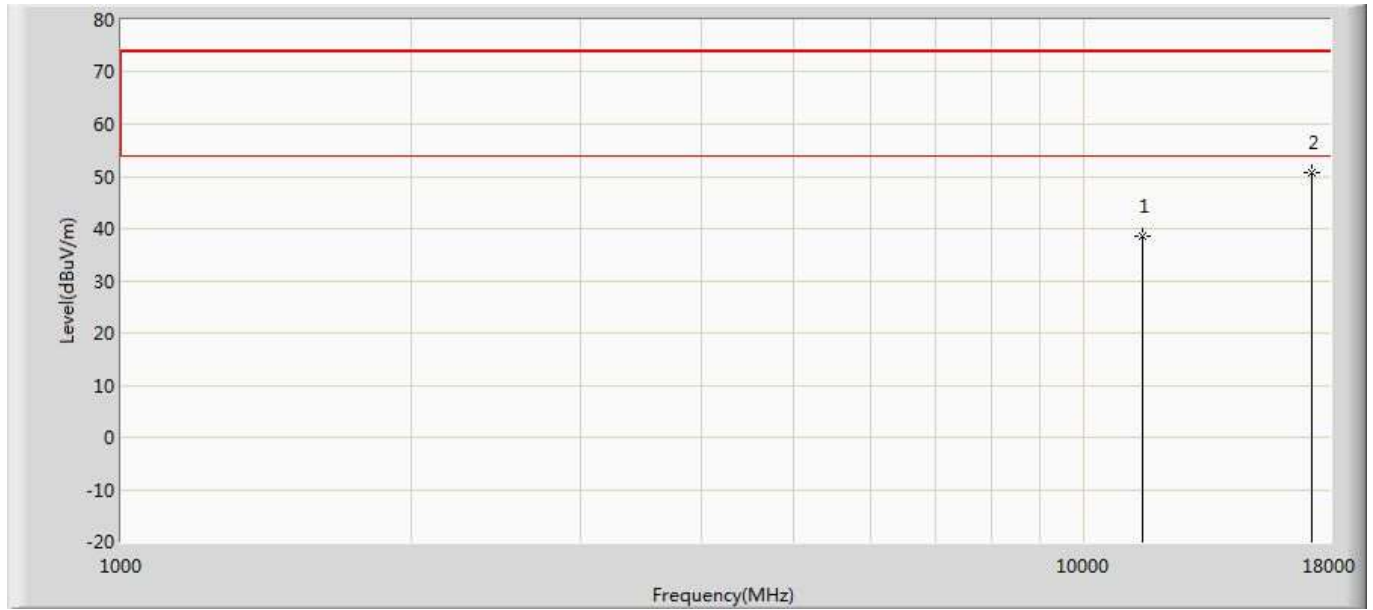

No	Mark	Frequency (MHz)	Measure Level (dBuV/m)	Reading Level (dBuV)	Over Limit (dB)	Limit (dBuV/m)	Factor (dB)	Type
1		11510.000	38.853	25.802	-35.147	74.000	13.051	PK
2	*	17265.000	50.407	29.679	-23.593	74.000	20.728	PK

Profile: 2032034R	Page No.: 131
Engineer: Neil	
Site: AC5	Time: 2020/06/18 - 20:38
Limit: FCC_Part15.209_RE(3m)	Margin: 0
Probe: Horn_3117_00167055(1-18GHz)	Polarity: Vertical
EUT: Wireless Access Point	Power: AC 120V/60Hz
Note: Mode 5:Transmit at 5755MHz by 802.11ac(40MHz)	

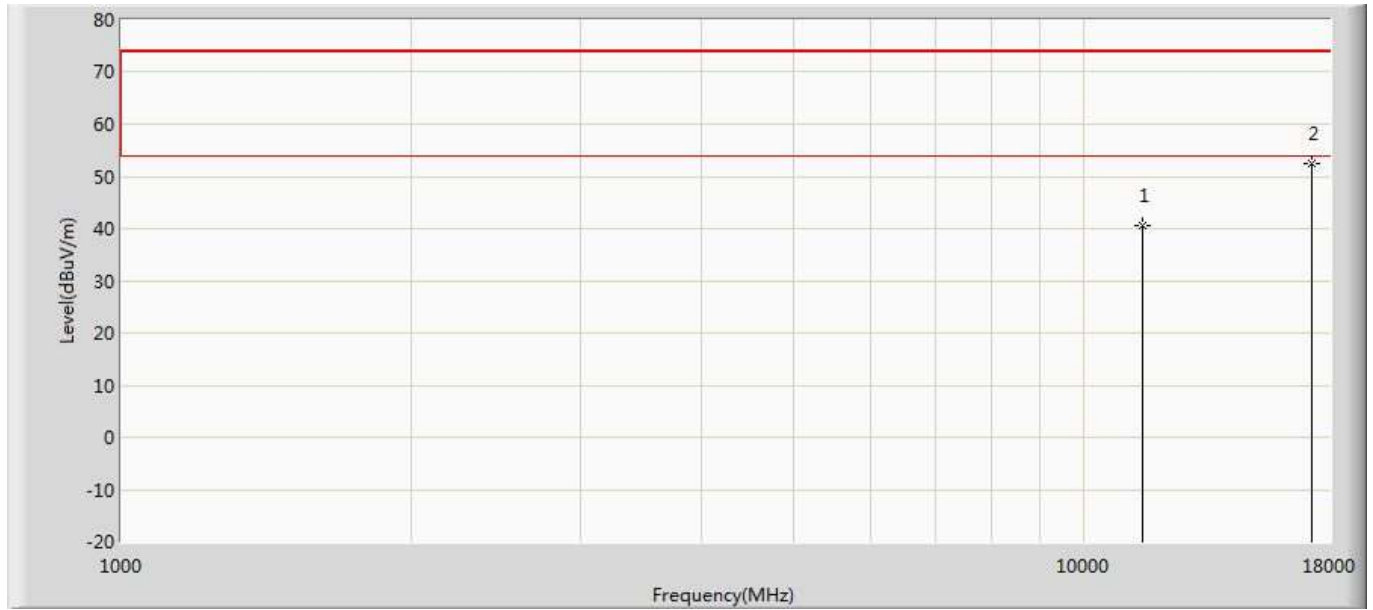

No	Mark	Frequency (MHz)	Measure Level (dBuV/m)	Reading Level (dBuV)	Over Limit (dB)	Limit (dBuV/m)	Factor (dB)	Type
1		11510.000	40.354	27.303	-33.646	74.000	13.051	PK
2	*	17265.000	51.587	30.859	-22.413	74.000	20.728	PK

Profile: 2032034R	Page No.: 132
Engineer: Neil	
Site: AC5	Time: 2020/06/18 - 20:39
Limit: FCC_Part15.209_RE(3m)	Margin: 0
Probe: Horn_3117_00167055(1-18GHz)	Polarity: Horizontal
EUT: Wireless Access Point	Power: AC 120V/60Hz
Note: Mode 5:Transmit at 5795MHz by 802.11ac(40MHz)	

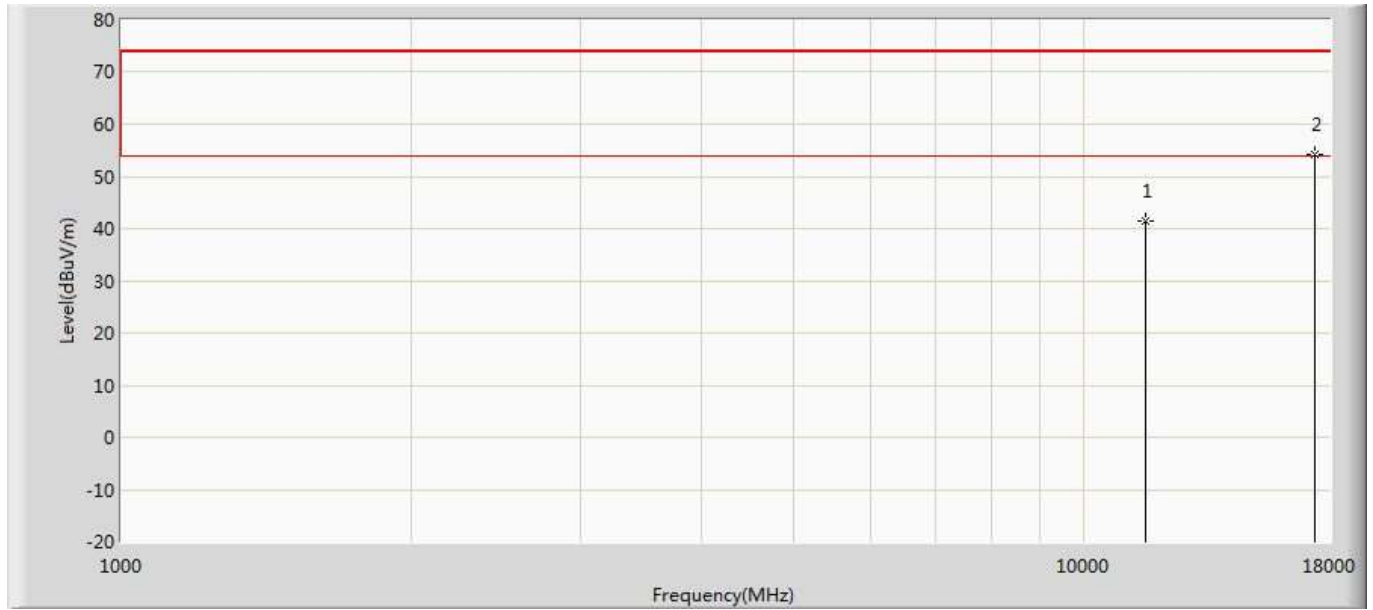

No	Mark	Frequency (MHz)	Measure Level (dBuV/m)	Reading Level (dBuV)	Over Limit (dB)	Limit (dBuV/m)	Factor (dB)	Type
1		11590.000	40.608	27.284	-33.392	74.000	13.324	PK
2	*	17385.000	54.018	31.843	-19.982	74.000	22.175	PK

Profile: 2032034R	Page No.: 133
Engineer: Neil	
Site: AC5	Time: 2020/06/18 - 20:39
Limit: FCC_Part15.209_RE(3m)	Margin: 0
Probe: Horn_3117_00167055(1-18GHz)	Polarity: Vertical
EUT: Wireless Access Point	Power: AC 120V/60Hz
Note: Mode 5:Transmit at 5795MHz by 802.11ac(40MHz)	

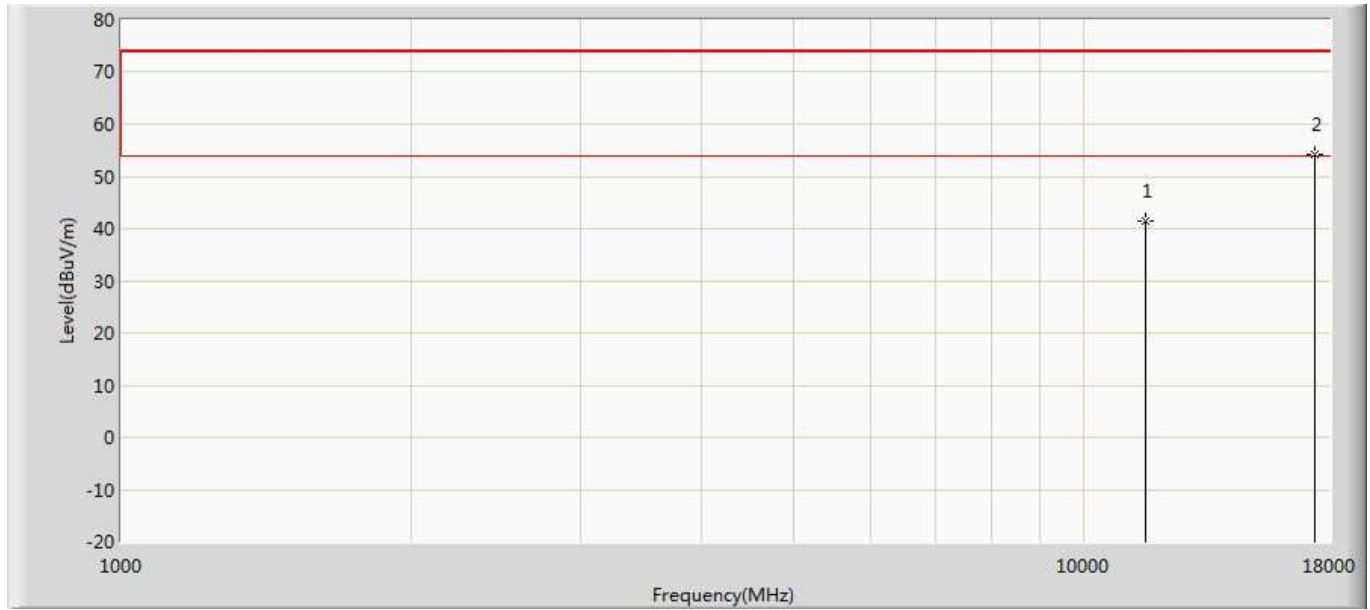

No	Mark	Frequency (MHz)	Measure Level (dBuV/m)	Reading Level (dBuV)	Over Limit (dB)	Limit (dBuV/m)	Factor (dB)	Type
1		11590.000	40.920	27.596	-33.080	74.000	13.324	PK
2	*	17385.000	53.554	31.379	-20.446	74.000	22.175	PK

Profile: 2032034R	Page No.: 134
Engineer: Neil	
Site: AC5	Time: 2020/06/18 - 20:40
Limit: FCC_Part15.209_RE(3m)	Margin: 0
Probe: Horn_3117_00167055(1-18GHz)	Polarity: Horizontal
EUT: Wireless Access Point	Power: AC 120V/60Hz
Note: Mode 6:Transmit at 5210MHz by 802.11ac(80MHz)	

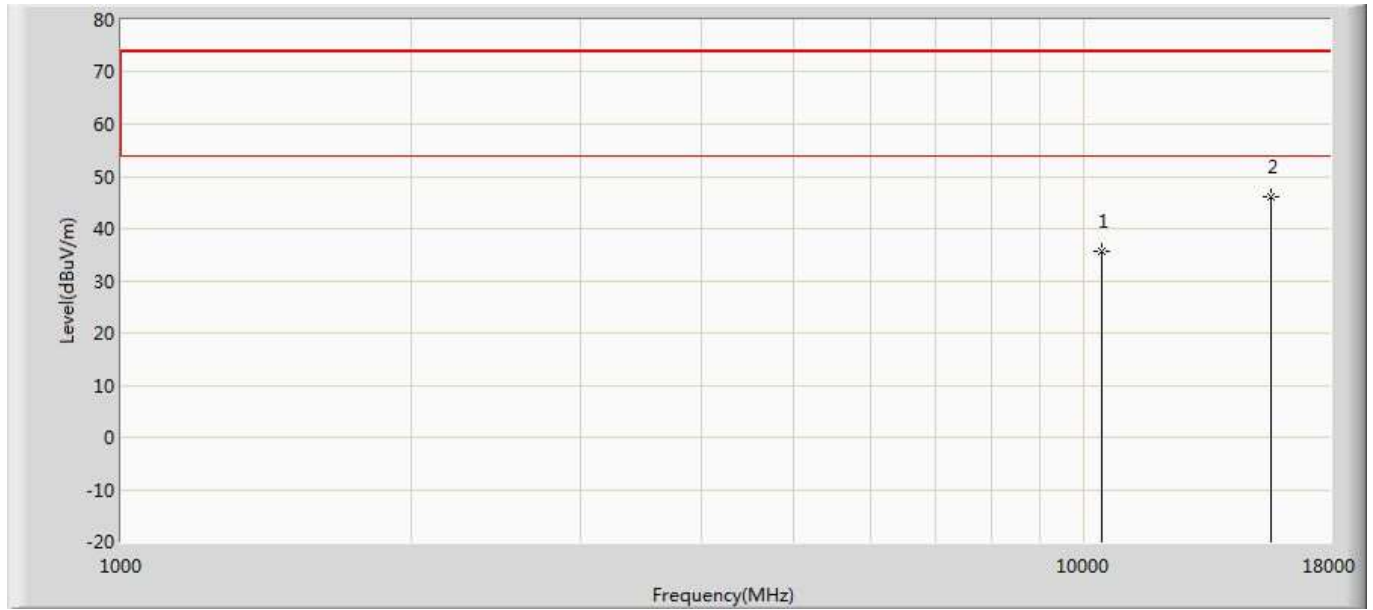

No	Mark	Frequency (MHz)	Measure Level (dBuV/m)	Reading Level (dBuV)	Over Limit (dB)	Limit (dBuV/m)	Factor (dB)	Type
1		10420.000	36.402	25.757	-37.598	74.000	10.645	PK
2	*	15630.000	47.914	31.572	-26.086	74.000	16.342	PK

Profile: 2032034R	Page No.: 135
Engineer: Neil	
Site: AC5	Time: 2020/06/18 - 20:40
Limit: FCC_Part15.209_RE(3m)	Margin: 0
Probe: Horn_3117_00167055(1-18GHz)	Polarity: Vertical
EUT: Wireless Access Point	Power: AC 120V/60Hz
Note: Mode 6:Transmit at 5210MHz by 802.11ac(80MHz)	

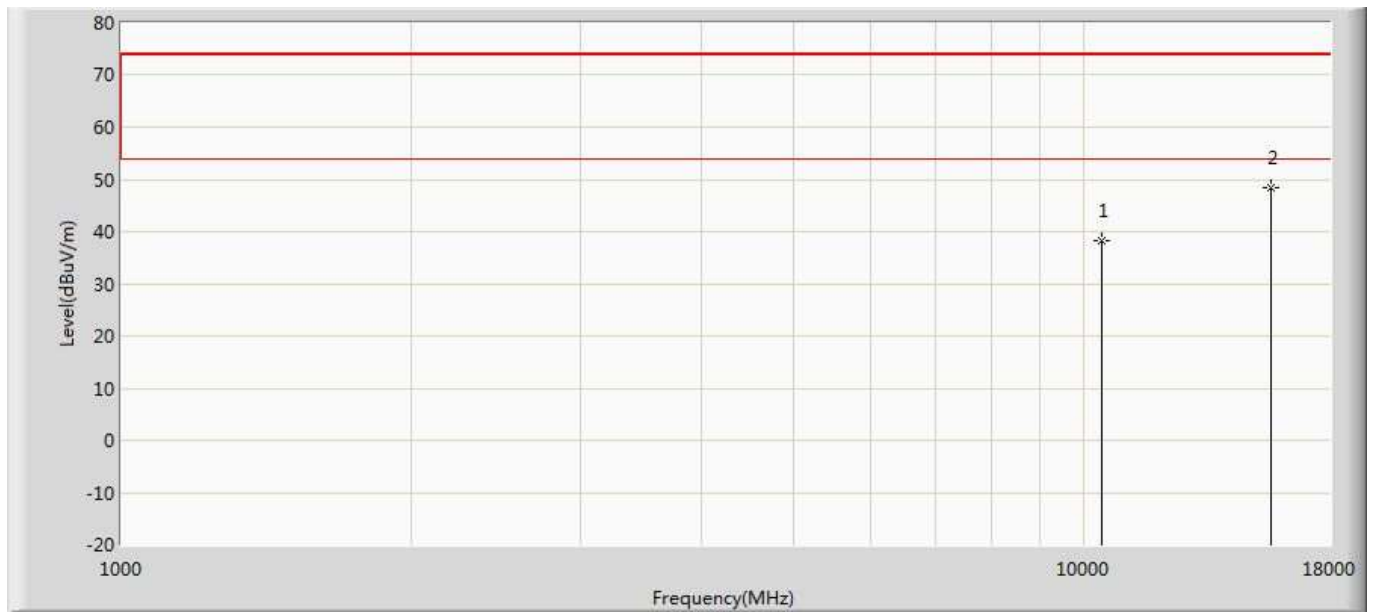

No	Mark	Frequency (MHz)	Measure Level (dBuV/m)	Reading Level (dBuV)	Over Limit (dB)	Limit (dBuV/m)	Factor (dB)	Type
1		10420.000	38.121	27.476	-35.879	74.000	10.645	PK
2	*	15630.000	49.054	32.712	-24.946	74.000	16.342	PK

Profile: 2032034R	Page No.: 164
Engineer: Neil	
Site: AC5	Time: 2020/06/18 - 20:52
Limit: FCC_Part15.209_RE(3m)	Margin: 0
Probe: Horn_3117_00167055(1-18GHz)	Polarity: Horizontal
EUT: Wireless Access Point	Power: AC 120V/60Hz
Note: Mode 6:Transmit at 5775MHz by 802.11ac(80MHz)	

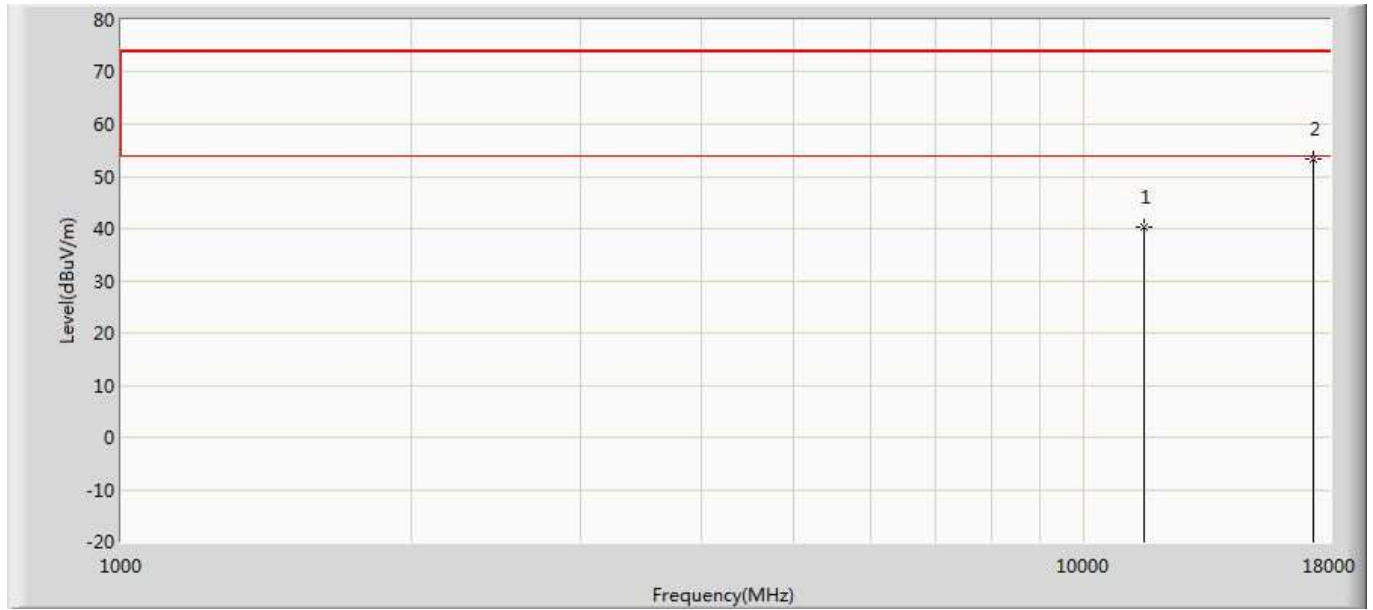

No	Mark	Frequency (MHz)	Measure Level (dBuV/m)	Reading Level (dBuV)	Over Limit (dB)	Limit (dBuV/m)	Factor (dB)	Type
1		11550.000	40.530	27.258	-33.470	74.000	13.272	PK
2	*	17325.000	52.705	30.425	-21.295	74.000	22.280	PK



Profile: 2032034R	Page No.: 165
Engineer: Neil	
Site: AC5	Time: 2020/06/18 - 20:53
Limit: FCC_Part15.209_RE(3m)	Margin: 0
Probe: Horn_3117_00167055(1-18GHz)	Polarity: Vertical
EUT: Wireless Access Point	Power: AC 120V/60Hz
Note: Mode 6:Transmit at 5775MHz by 802.11ac(80MHz)	

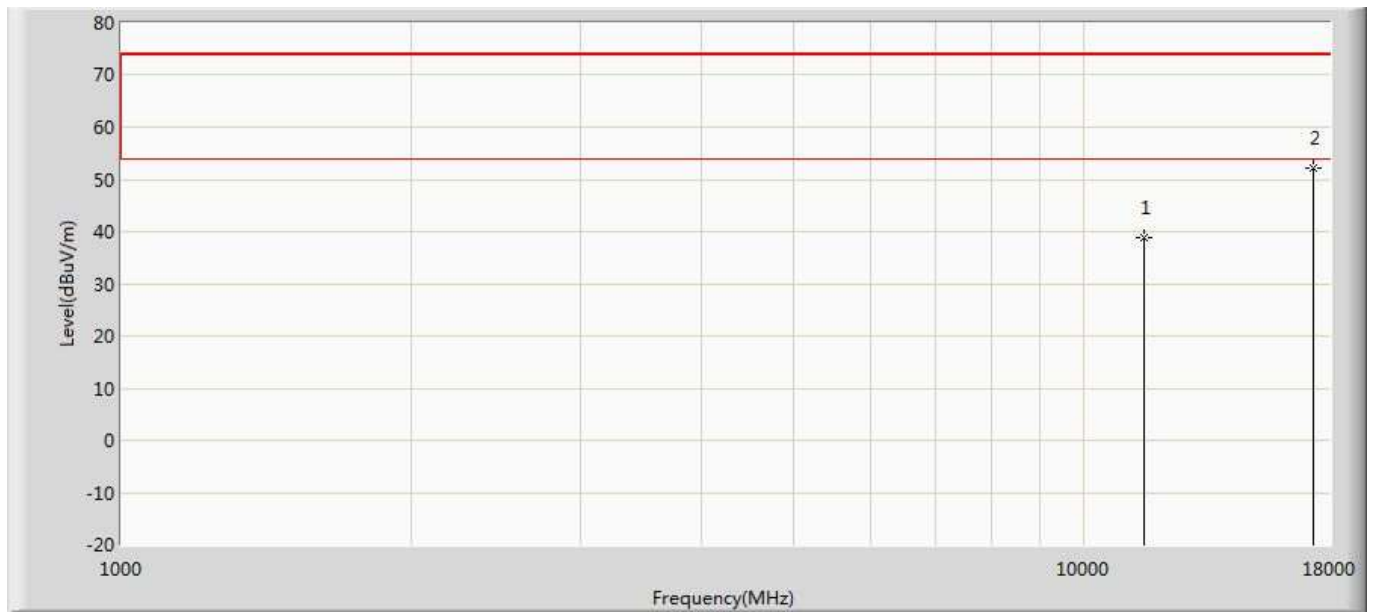

No	Mark	Frequency (MHz)	Measure Level (dBuV/m)	Reading Level (dBuV)	Over Limit (dB)	Limit (dBuV/m)	Factor (dB)	Type
1		11550.000	38.202	24.930	-35.798	74.000	13.272	PK
2	*	17325.000	53.936	31.656	-20.064	74.000	22.280	PK

Profile: 2032034R	Page No.: 138
Engineer: Neil	
Site: AC5	Time: 2020/06/18 - 20:41
Limit: FCC_Part15.209_RE(3m)	Margin: 0
Probe: Horn_3117_00167055(1-18GHz)	Polarity: Horizontal
EUT: Wireless Access Point	Power: AC 120V/60Hz
Note: Mode 7:Transmit at 5180MHz by 802.11ax(20MHz)	

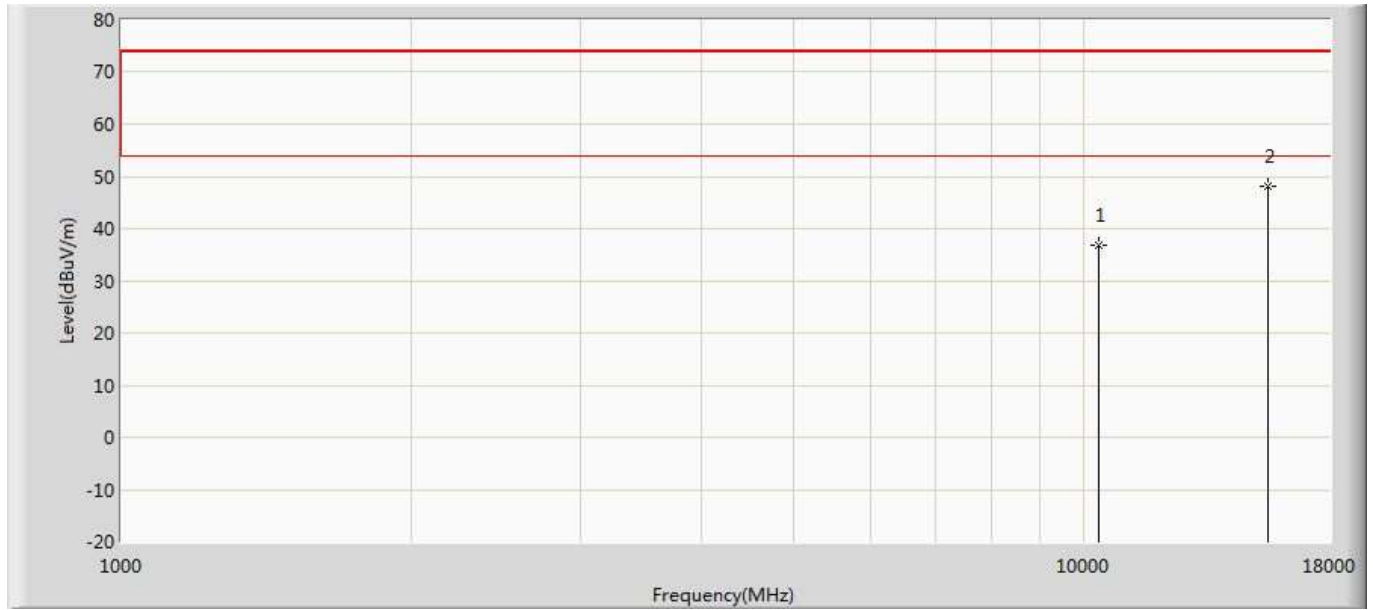

No	Mark	Frequency (MHz)	Measure Level (dBuV/m)	Reading Level (dBuV)	Over Limit (dB)	Limit (dBuV/m)	Factor (dB)	Type
1		10360.000	36.953	25.827	-37.047	74.000	11.126	PK
2	*	15540.000	48.095	30.207	-25.905	74.000	17.888	PK

Profile: 2032034R	Page No.: 139
Engineer: Neil	
Site: AC5	Time: 2020/06/18 - 20:41
Limit: FCC_Part15.209_RE(3m)	Margin: 0
Probe: Horn_3117_00167055(1-18GHz)	Polarity: Vertical
EUT: Wireless Access Point	Power: AC 120V/60Hz
Note: Mode 7:Transmit at 5180MHz by 802.11ax(20MHz)	

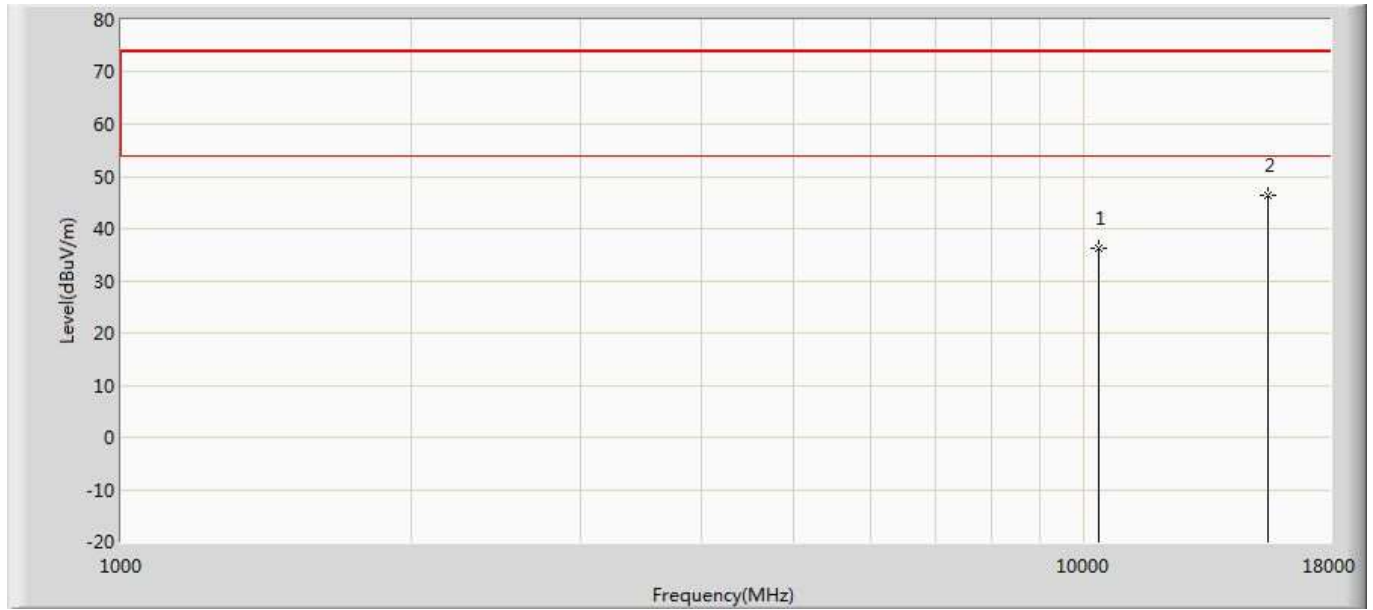

No	Mark	Frequency (MHz)	Measure Level (dBuV/m)	Reading Level (dBuV)	Over Limit (dB)	Limit (dBuV/m)	Factor (dB)	Type
1		10360.000	37.651	26.525	-36.349	74.000	11.126	PK
2	*	15540.000	47.001	29.113	-26.999	74.000	17.888	PK

Profile: 2032034R	Page No.: 140
Engineer: Neil	
Site: AC5	Time: 2020/06/18 - 20:41
Limit: FCC_Part15.209_RE(3m)	Margin: 0
Probe: Horn_3117_00167055(1-18GHz)	Polarity: Horizontal
EUT: Wireless Access Point	Power: AC 120V/60Hz
Note: Mode 7:Transmit at 5220MHz by 802.11ax(20MHz)	

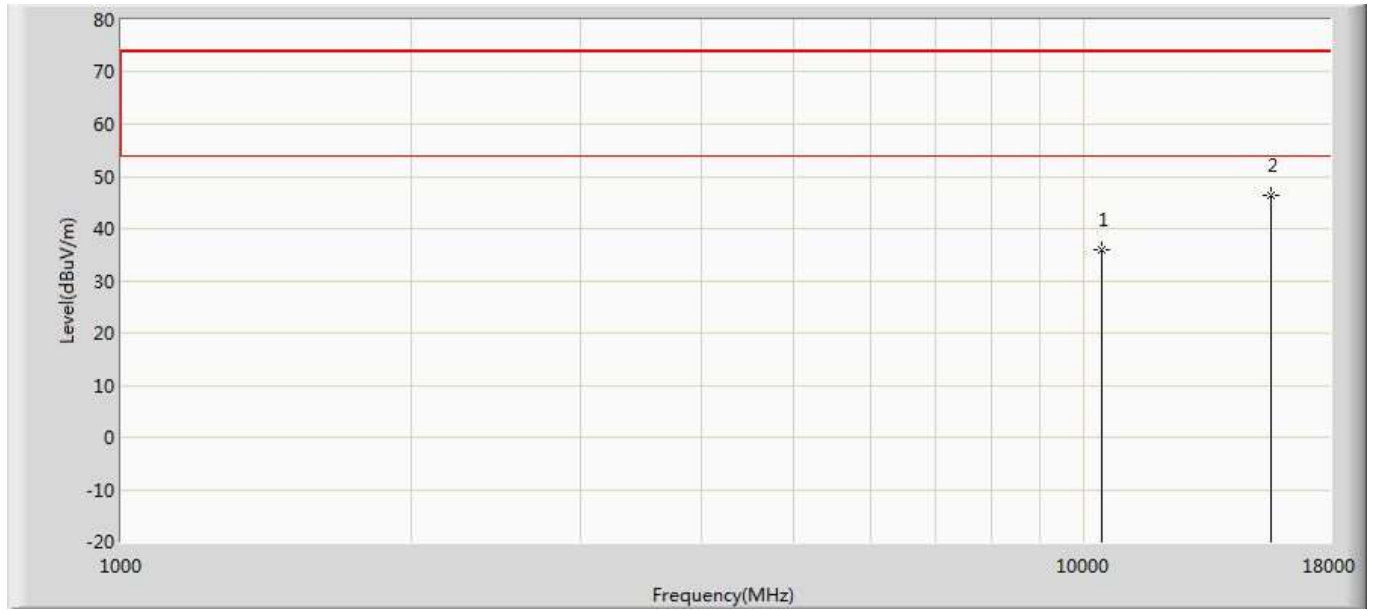

No	Mark	Frequency (MHz)	Measure Level (dBuV/m)	Reading Level (dBuV)	Over Limit (dB)	Limit (dBuV/m)	Factor (dB)	Type
1		10440.000	36.501	25.387	-37.499	74.000	11.114	PK
2	*	15660.000	46.374	29.241	-27.626	74.000	17.133	PK

Profile: 2032034R	Page No.: 141
Engineer: Neil	
Site: AC5	Time: 2020/06/18 - 20:41
Limit: FCC_Part15.209_RE(3m)	Margin: 0
Probe: Horn_3117_00167055(1-18GHz)	Polarity: Vertical
EUT: Wireless Access Point	Power: AC 120V/60Hz
Note: Mode 7:Transmit at 5220MHz by 802.11ax(20MHz)	

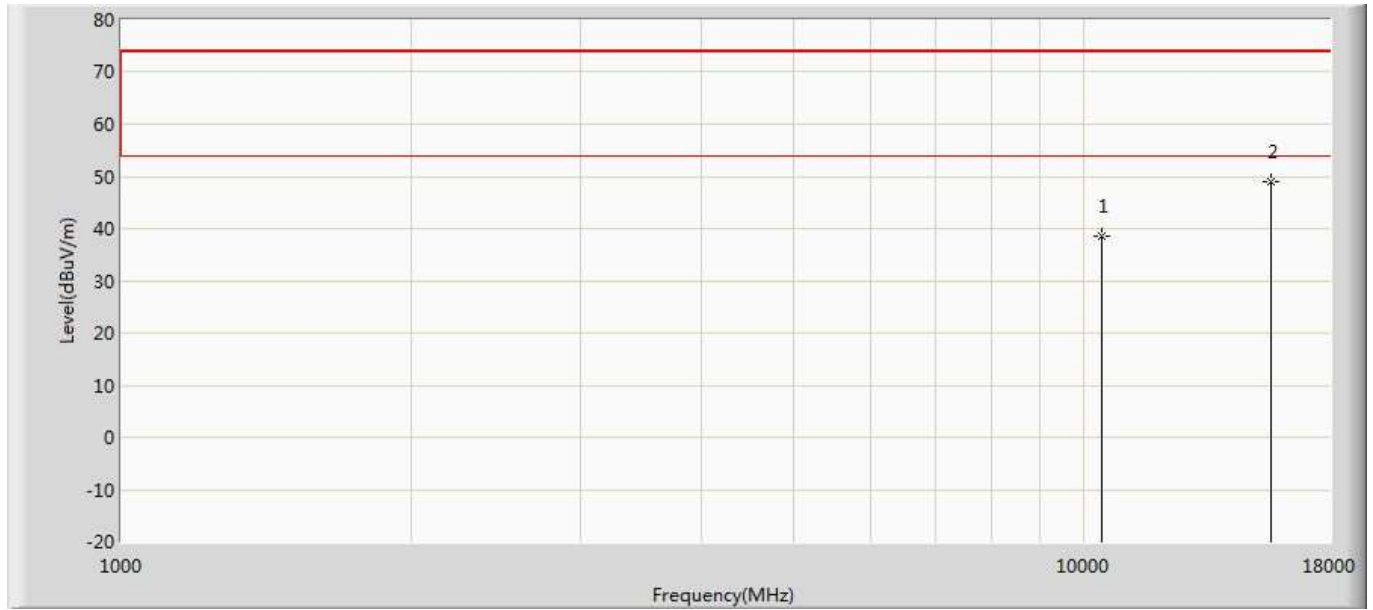

No	Mark	Frequency (MHz)	Measure Level (dBuV/m)	Reading Level (dBuV)	Over Limit (dB)	Limit (dBuV/m)	Factor (dB)	Type
1		10440.000	37.484	26.370	-36.516	74.000	11.114	PK
2	*	15660.000	48.778	31.645	-25.222	74.000	17.133	PK

Profile: 2032034R	Page No.: 142
Engineer: Neil	
Site: AC5	Time: 2020/06/18 - 20:42
Limit: FCC_Part15.209_RE(3m)	Margin: 0
Probe: Horn_3117_00167055(1-18GHz)	Polarity: Horizontal
EUT: Wireless Access Point	Power: AC 120V/60Hz
Note: Mode 7:Transmit at 5240MHz by 802.11ax(20MHz)	

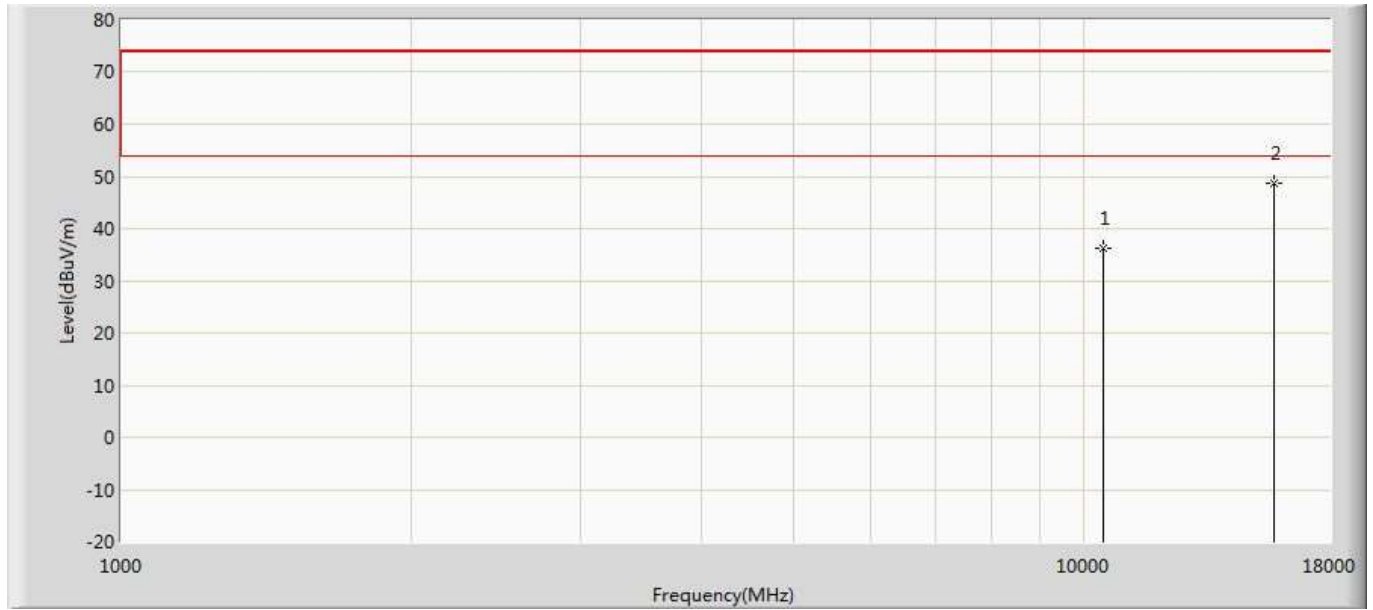

No	Mark	Frequency (MHz)	Measure Level (dBuV/m)	Reading Level (dBuV)	Over Limit (dB)	Limit (dBuV/m)	Factor (dB)	Type
1		10480.000	36.092	25.192	-37.908	74.000	10.900	PK
2	*	15720.000	47.327	28.583	-26.673	74.000	18.744	PK

Profile: 2032034R	Page No.: 143
Engineer: Neil	
Site: AC5	Time: 2020/06/18 - 20:42
Limit: FCC_Part15.209_RE(3m)	Margin: 0
Probe: Horn_3117_00167055(1-18GHz)	Polarity: Vertical
EUT: Wireless Access Point	Power: AC 120V/60Hz
Note: Mode 7: Transmit at 5240MHz by 802.11ax(20MHz)	

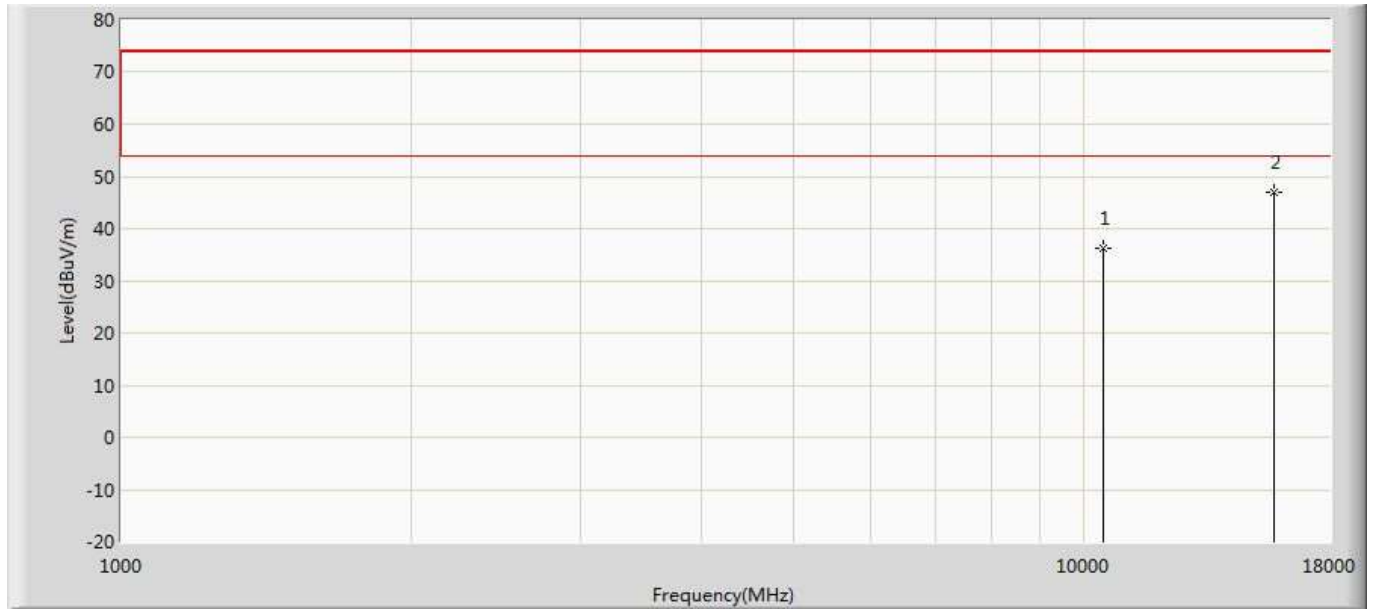

No	Mark	Frequency (MHz)	Measure Level (dBuV/m)	Reading Level (dBuV)	Over Limit (dB)	Limit (dBuV/m)	Factor (dB)	Type
1		10480.000	36.979	26.079	-37.021	74.000	10.900	PK
2	*	15720.000	48.146	29.402	-25.854	74.000	18.744	PK

Profile: 2032034R	Page No.: 144
Engineer: Neil	
Site: AC5	Time: 2020/06/18 - 20:42
Limit: FCC_Part15.209_RE(3m)	Margin: 0
Probe: Horn_3117_00167055(1-18GHz)	Polarity: Horizontal
EUT: Wireless Access Point	Power: AC 120V/60Hz
Note: Mode 7:Transmit at 5745MHz by 802.11ax(20MHz)	

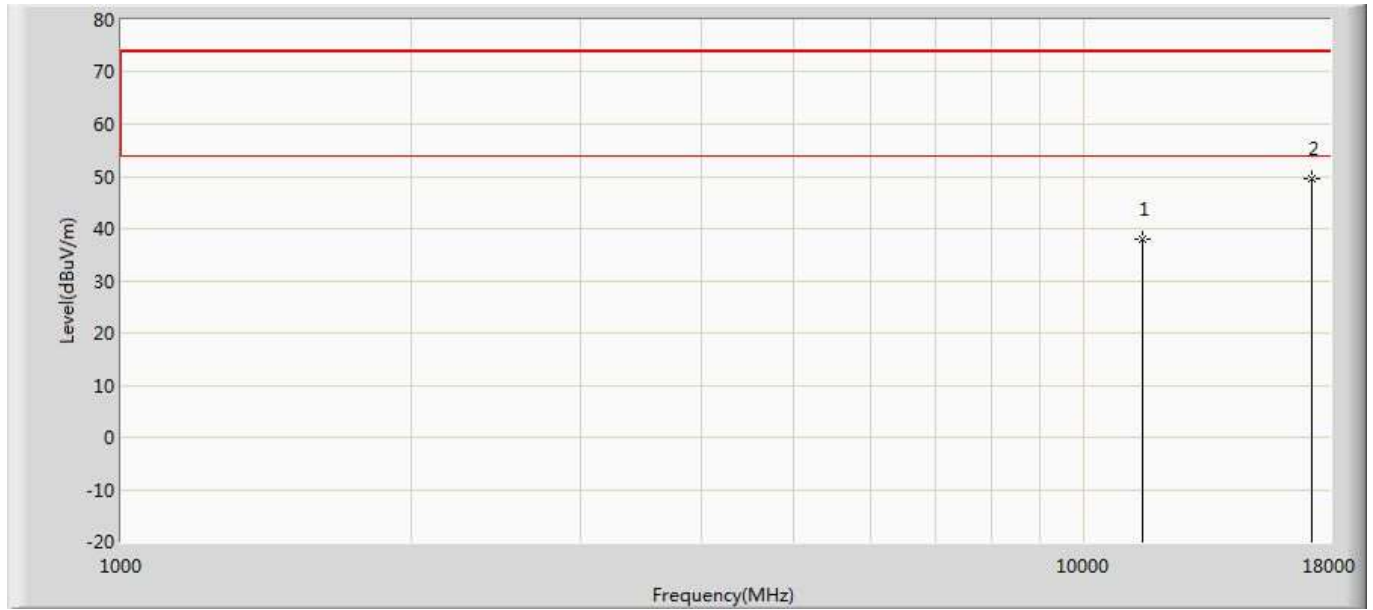

No	Mark	Frequency (MHz)	Measure Level (dBuV/m)	Reading Level (dBuV)	Over Limit (dB)	Limit (dBuV/m)	Factor (dB)	Type
1		11490.000	37.917	25.166	-36.083	74.000	12.751	PK
2	*	17235.000	48.925	28.699	-25.075	74.000	20.226	PK



Profile: 2032034R	Page No.: 145
Engineer: Neil	
Site: AC5	Time: 2020/06/18 - 20:43
Limit: FCC_Part15.209_RE(3m)	Margin: 0
Probe: Horn_3117_00167055(1-18GHz)	Polarity: Vertical
EUT: Wireless Access Point	Power: AC 120V/60Hz
Note: Mode 7:Transmit at 5745MHz by 802.11ax(20MHz)	

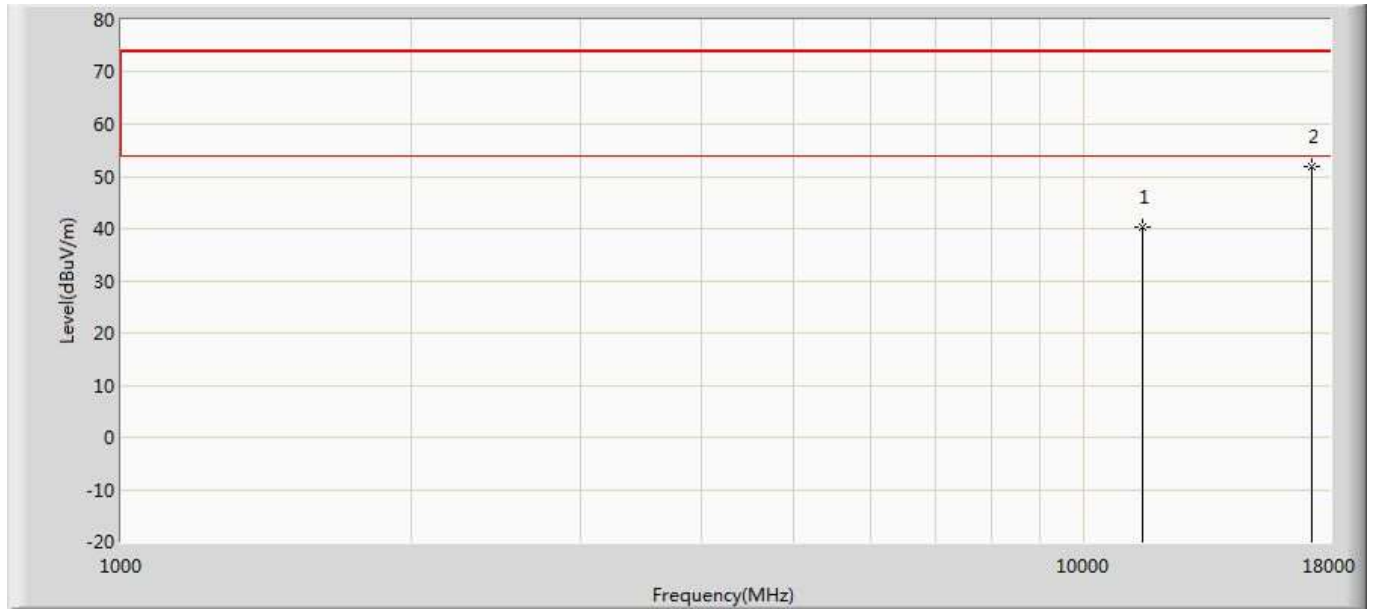

No	Mark	Frequency (MHz)	Measure Level (dBuV/m)	Reading Level (dBuV)	Over Limit (dB)	Limit (dBuV/m)	Factor (dB)	Type
1		11490.000	40.263	27.512	-33.737	74.000	12.751	PK
2	*	17235.000	51.103	30.877	-22.897	74.000	20.226	PK

Profile: 2032034R	Page No.: 146
Engineer: Neil	
Site: AC5	Time: 2020/06/18 - 20:43
Limit: FCC_Part15.209_RE(3m)	Margin: 0
Probe: Horn_3117_00167055(1-18GHz)	Polarity: Horizontal
EUT: Wireless Access Point	Power: AC 120V/60Hz
Note: Mode 7:Transmit at 5785MHz by 802.11ax(20MHz)	

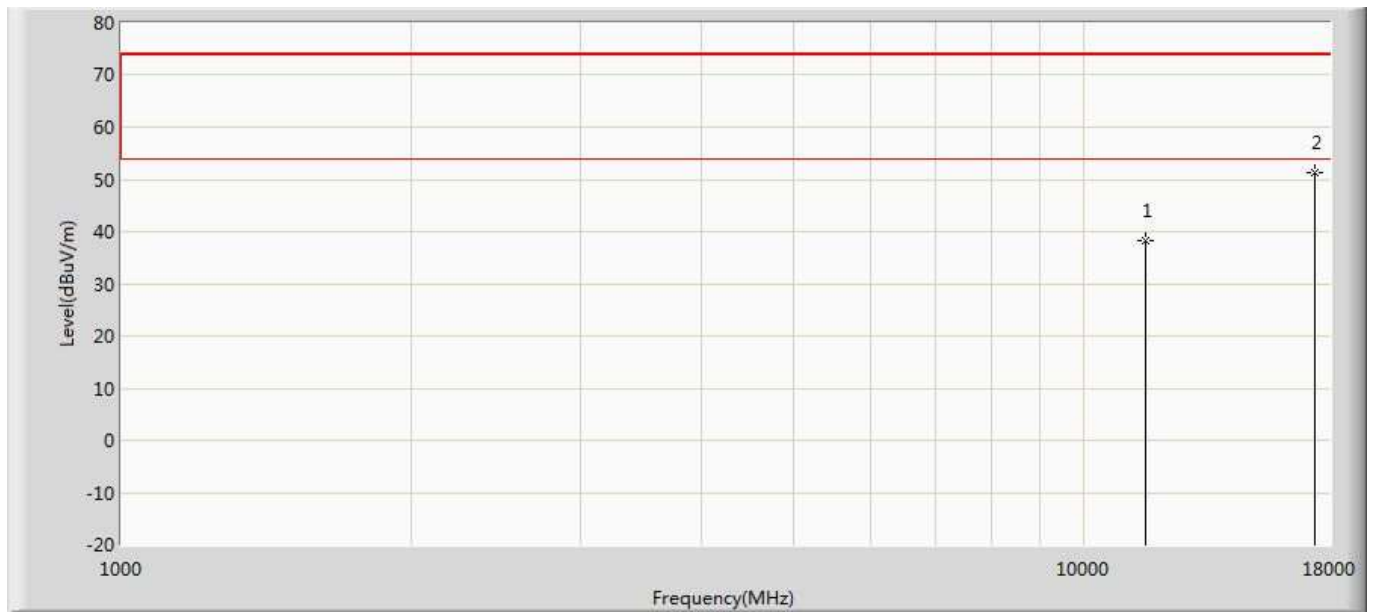

No	Mark	Frequency (MHz)	Measure Level (dBuV/m)	Reading Level (dBuV)	Over Limit (dB)	Limit (dBuV/m)	Factor (dB)	Type
1		11570.000	37.978	24.822	-36.022	74.000	13.156	PK
2	*	17355.000	51.018	28.020	-22.982	74.000	22.998	PK

Profile: 2032034R	Page No.: 147
Engineer: Neil	
Site: AC5	Time: 2020/06/18 - 20:43
Limit: FCC_Part15.209_RE(3m)	Margin: 0
Probe: Horn_3117_00167055(1-18GHz)	Polarity: Vertical
EUT: Wireless Access Point	Power: AC 120V/60Hz
Note: Mode 7: Transmit at 5785MHz by 802.11ax(20MHz)	

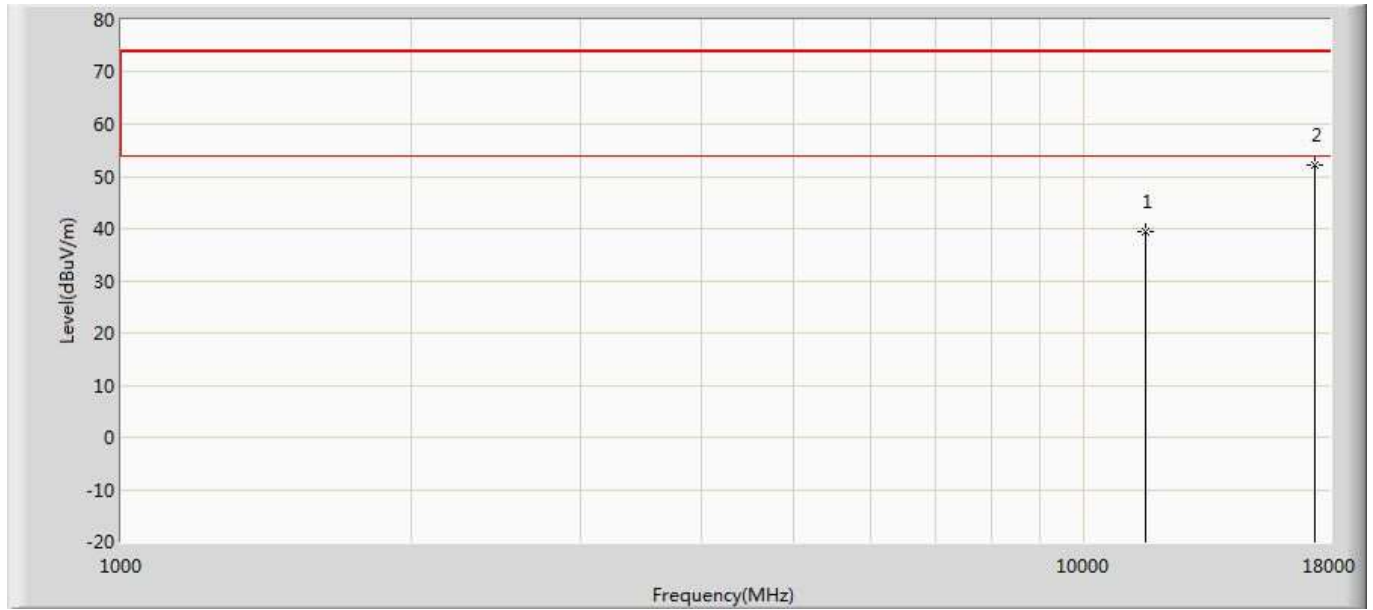

No	Mark	Frequency (MHz)	Measure Level (dBuV/m)	Reading Level (dBuV)	Over Limit (dB)	Limit (dBuV/m)	Factor (dB)	Type
1		11570.000	38.976	25.820	-35.024	74.000	13.156	PK
2	*	17355.000	52.112	29.114	-21.888	74.000	22.998	PK

Profile: 2032034R	Page No.: 148
Engineer: Neil	
Site: AC5	Time: 2020/06/18 - 20:44
Limit: FCC_Part15.209_RE(3m)	Margin: 0
Probe: Horn_3117_00167055(1-18GHz)	Polarity: Horizontal
EUT: Wireless Access Point	Power: AC 120V/60Hz
Note: Mode 7: Transmit at 5825MHz by 802.11ax(20MHz)	

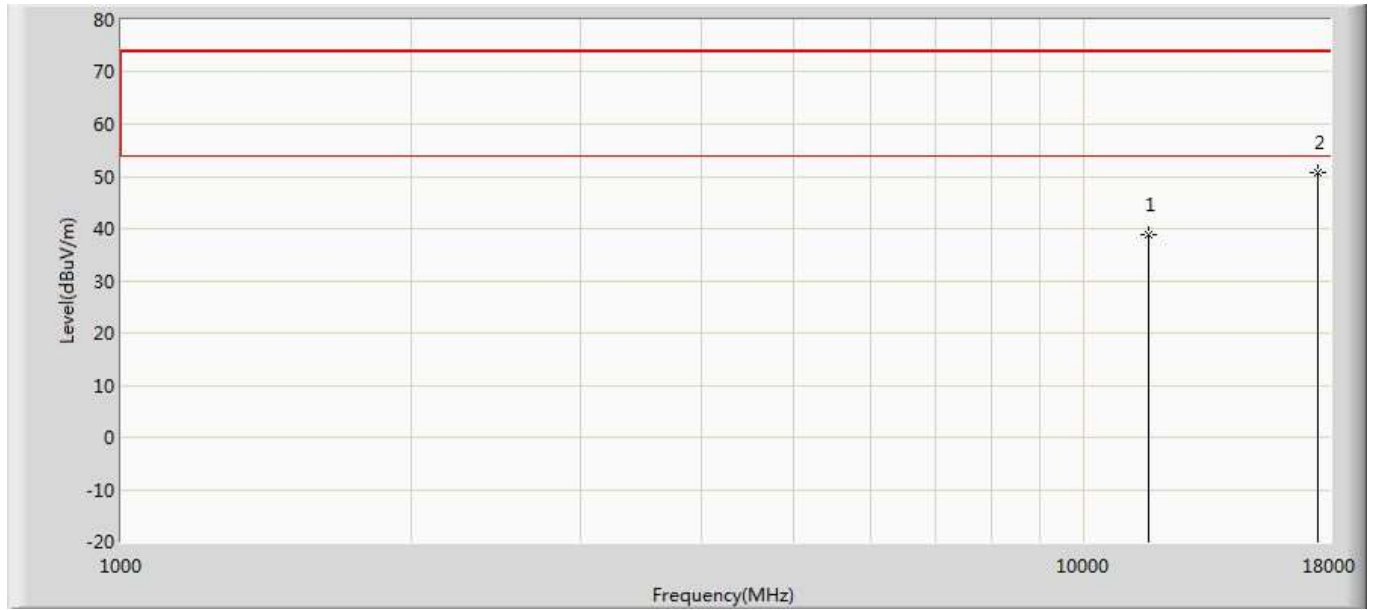

No	Mark	Frequency (MHz)	Measure Level (dBuV/m)	Reading Level (dBuV)	Over Limit (dB)	Limit (dBuV/m)	Factor (dB)	Type
1		11650.000	38.869	24.980	-35.131	74.000	13.889	PK
2	*	17475.000	50.458	28.875	-23.542	74.000	21.583	PK

Profile: 2032034R	Page No.: 149
Engineer: Neil	
Site: AC5	Time: 2020/06/18 - 20:44
Limit: FCC_Part15.209_RE(3m)	Margin: 0
Probe: Horn_3117_00167055(1-18GHz)	Polarity: Vertical
EUT: Wireless Access Point	Power: AC 120V/60Hz
Note: Mode 7: Transmit at 5825MHz by 802.11ax(20MHz)	

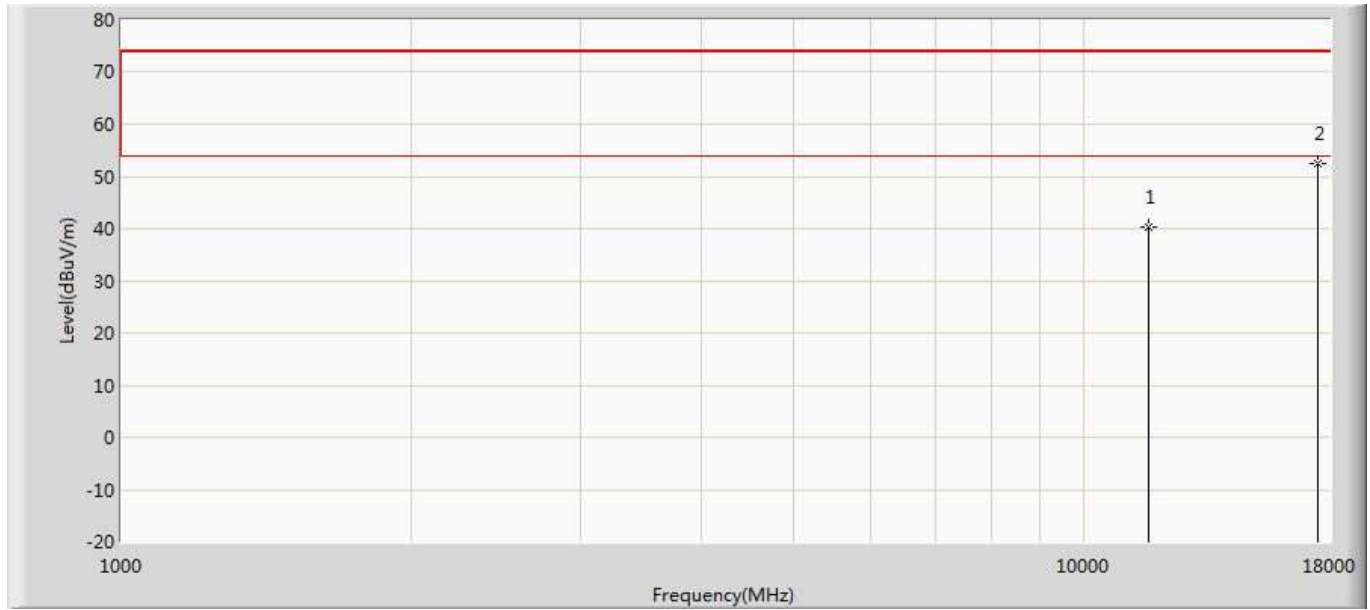

No	Mark	Frequency (MHz)	Measure Level (dBuV/m)	Reading Level (dBuV)	Over Limit (dB)	Limit (dBuV/m)	Factor (dB)	Type
1		11650.000	40.500	26.611	-33.500	74.000	13.889	PK
2	*	17475.000	53.092	31.509	-20.908	74.000	21.583	PK

Profile: 2032034R	Page No.: 150
Engineer: Neil	
Site: AC5	Time: 2020/06/18 - 20:44
Limit: FCC_Part15.209_RE(3m)	Margin: 0
Probe: Horn_3117_00167055(1-18GHz)	Polarity: Horizontal
EUT: Wireless Access Point	Power: AC 120V/60Hz
Note: Mode 8:Transmit at 5190MHz by 802.11ax(40MHz)	

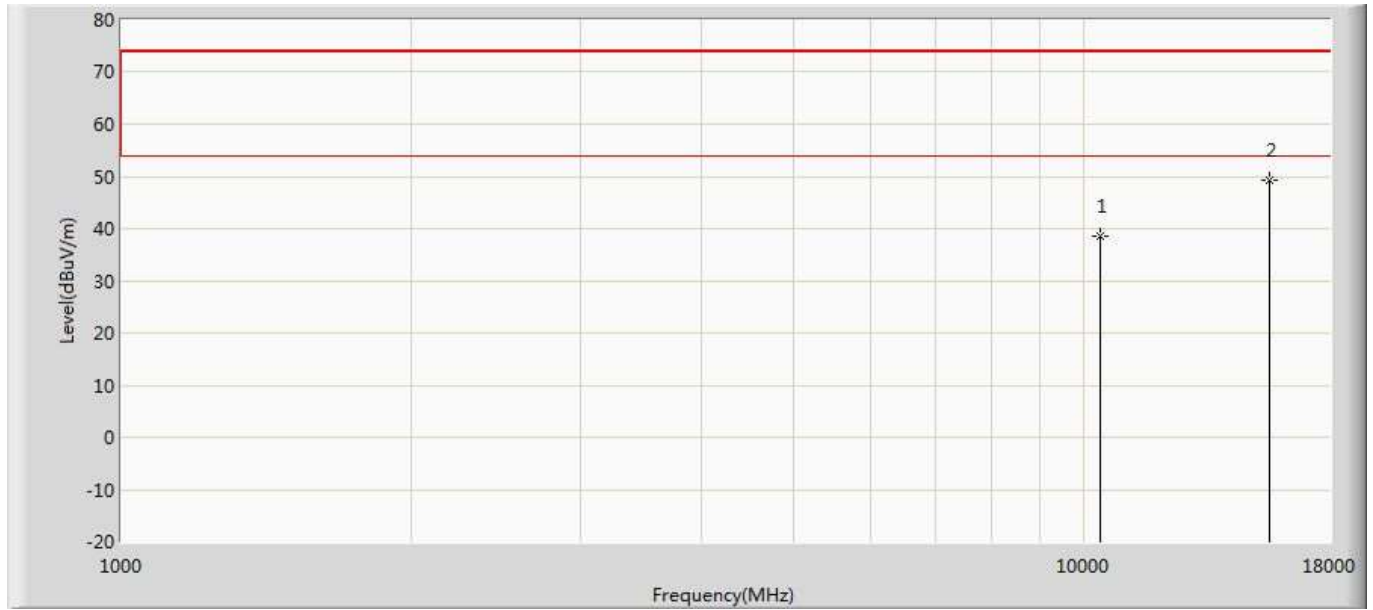

No	Mark	Frequency (MHz)	Measure Level (dBuV/m)	Reading Level (dBuV)	Over Limit (dB)	Limit (dBuV/m)	Factor (dB)	Type
1		10380.000	39.136	27.973	-34.864	74.000	11.163	PK
2	*	15570.000	49.572	32.543	-24.428	74.000	17.029	PK

Profile: 2032034R	Page No.: 151
Engineer: Neil	
Site: AC5	Time: 2020/06/18 - 20:45
Limit: FCC_Part15.209_RE(3m)	Margin: 0
Probe: Horn_3117_00167055(1-18GHz)	Polarity: Vertical
EUT: Wireless Access Point	Power: AC 120V/60Hz
Note: Mode 8:Transmit at 5190MHz by 802.11ax(40MHz)	

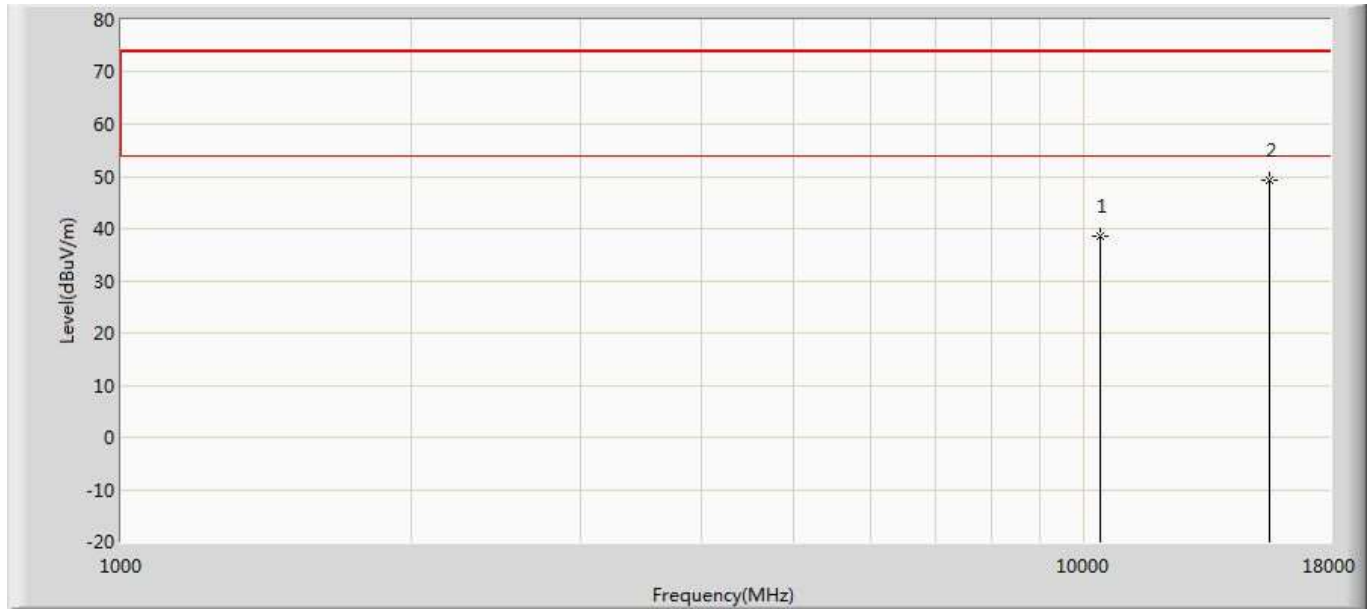

No	Mark	Frequency (MHz)	Measure Level (dBuV/m)	Reading Level (dBuV)	Over Limit (dB)	Limit (dBuV/m)	Factor (dB)	Type
1		10380.000	39.952	28.789	-34.048	74.000	11.163	PK
2	*	15570.000	49.005	31.976	-24.995	74.000	17.029	PK

Profile: 2032034R	Page No.: 152
Engineer: Neil	
Site: AC5	Time: 2020/06/18 - 20:45
Limit: FCC_Part15.209_RE(3m)	Margin: 0
Probe: Horn_3117_00167055(1-18GHz)	Polarity: Horizontal
EUT: Wireless Access Point	Power: AC 120V/60Hz
Note: Mode 8:Transmit at 5230MHz by 802.11ax(40MHz)	

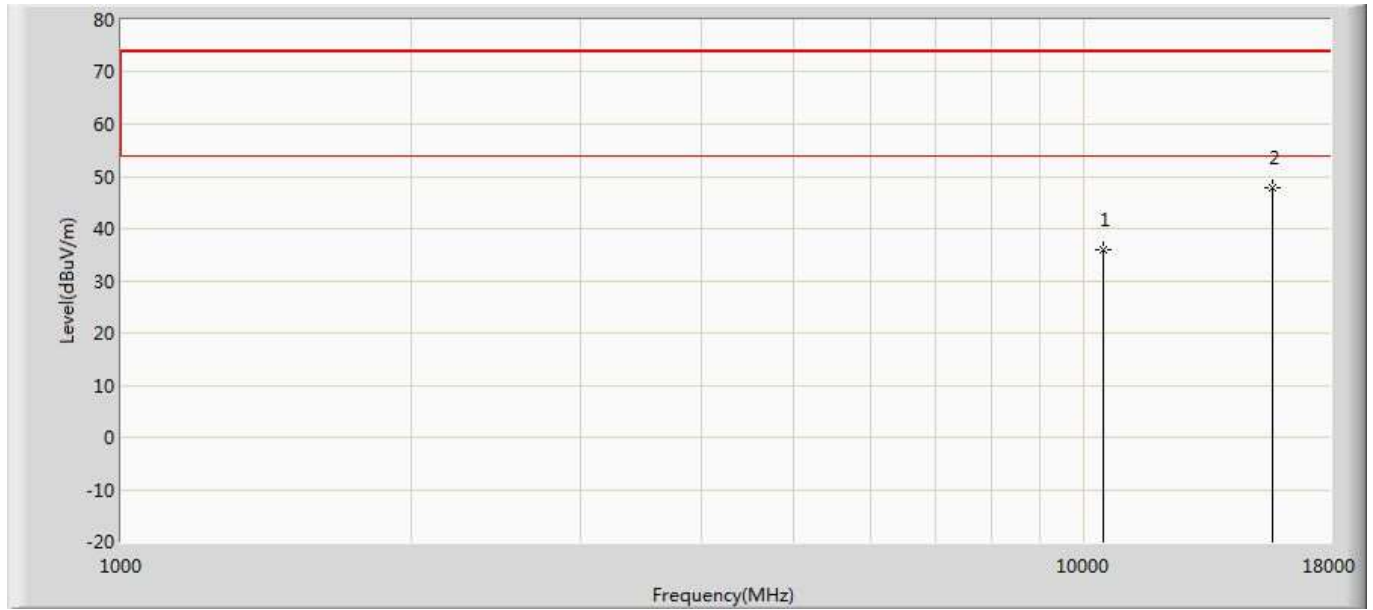

No	Mark	Frequency (MHz)	Measure Level (dBuV/m)	Reading Level (dBuV)	Over Limit (dB)	Limit (dBuV/m)	Factor (dB)	Type
1		10460.000	36.817	25.850	-37.183	74.000	10.967	PK
2	*	15690.000	47.987	29.411	-26.013	74.000	18.576	PK



Profile: 2032034R	Page No.: 153
Engineer: Neil	
Site: AC5	Time: 2020/06/18 - 20:45
Limit: FCC_Part15.209_RE(3m)	Margin: 0
Probe: Horn_3117_00167055(1-18GHz)	Polarity: Vertical
EUT: Wireless Access Point	Power: AC 120V/60Hz
Note: Mode 8:Transmit at 5230MHz by 802.11ax(40MHz)	

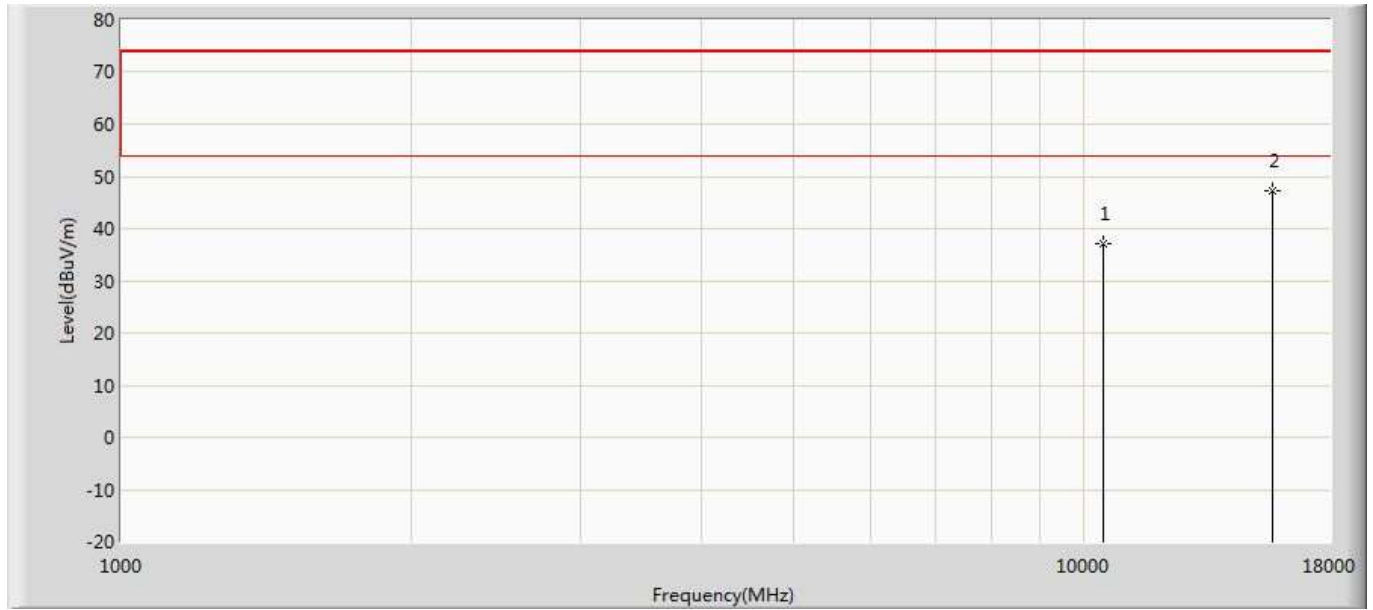

No	Mark	Frequency (MHz)	Measure Level (dBuV/m)	Reading Level (dBuV)	Over Limit (dB)	Limit (dBuV/m)	Factor (dB)	Type
1		10460.000	36.071	25.104	-37.929	74.000	10.967	PK
2	*	15690.000	47.656	29.080	-26.344	74.000	18.576	PK

Profile: 2032034R	Page No.: 154
Engineer: Neil	
Site: AC5	Time: 2020/06/18 - 20:45
Limit: FCC_Part15.209_RE(3m)	Margin: 0
Probe: Horn_3117_00167055(1-18GHz)	Polarity: Horizontal
EUT: Wireless Access Point	Power: AC 120V/60Hz
Note: Mode 8:Transmit at 5755MHz by 802.11ax(40MHz)	

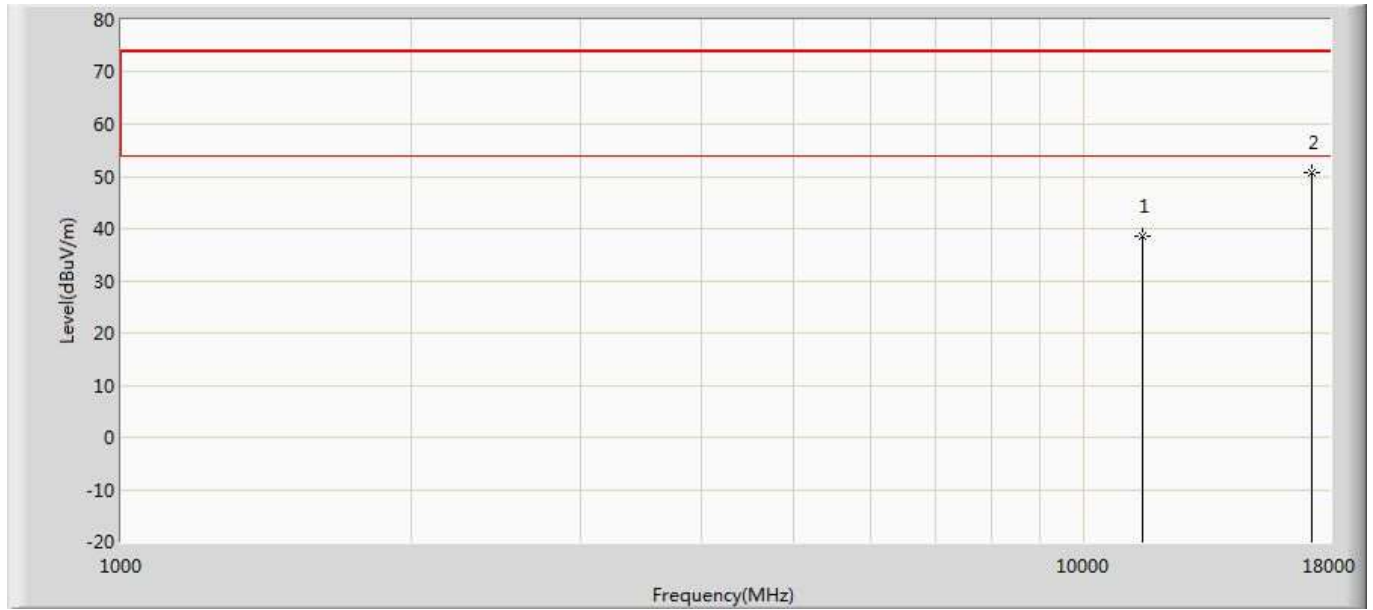

No	Mark	Frequency (MHz)	Measure Level (dBuV/m)	Reading Level (dBuV)	Over Limit (dB)	Limit (dBuV/m)	Factor (dB)	Type
1		11510.000	38.154	25.103	-35.846	74.000	13.051	PK
2	*	17265.000	50.726	29.998	-23.274	74.000	20.728	PK

Profile: 2032034R	Page No.: 155
Engineer: Neil	
Site: AC5	Time: 2020/06/18 - 20:46
Limit: FCC_Part15.209_RE(3m)	Margin: 0
Probe: Horn_3117_00167055(1-18GHz)	Polarity: Vertical
EUT: Wireless Access Point	Power: AC 120V/60Hz
Note: Mode 8:Transmit at 5755MHz by 802.11ax(40MHz)	

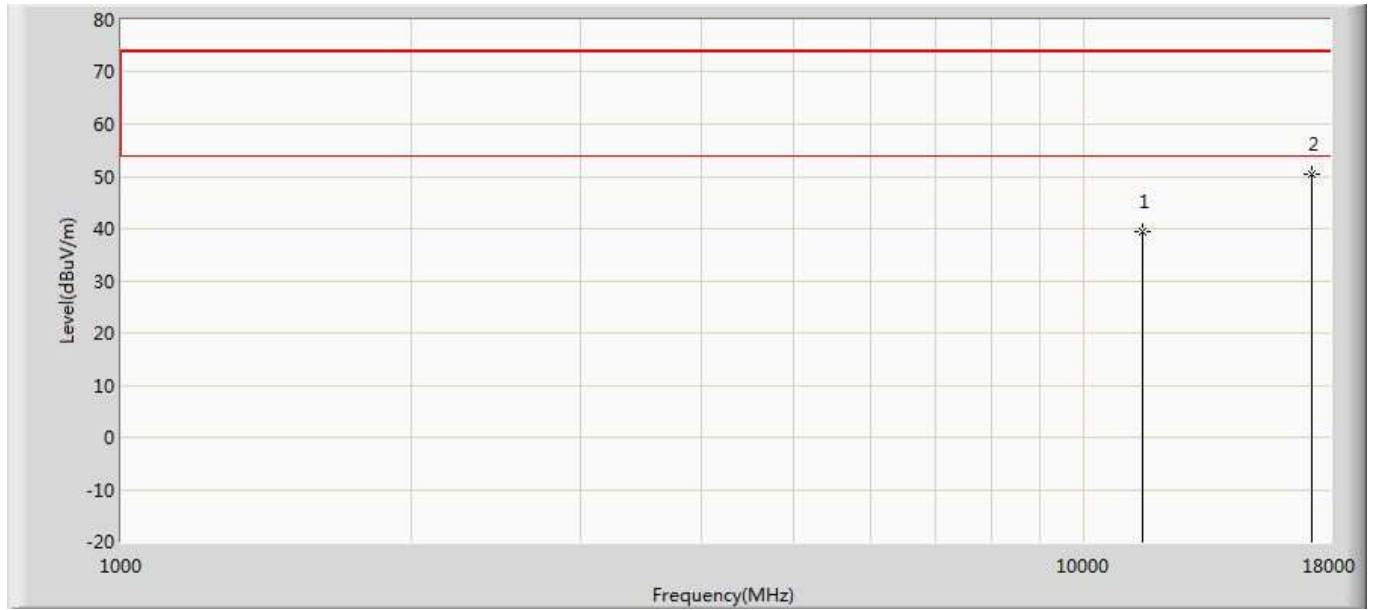

No	Mark	Frequency (MHz)	Measure Level (dBuV/m)	Reading Level (dBuV)	Over Limit (dB)	Limit (dBuV/m)	Factor (dB)	Type
1		11510.000	39.693	26.642	-34.307	74.000	13.051	PK
2	*	17265.000	50.022	29.294	-23.978	74.000	20.728	PK

Profile: 2032034R	Page No.: 156
Engineer: Neil	
Site: AC5	Time: 2020/06/18 - 20:46
Limit: FCC_Part15.209_RE(3m)	Margin: 0
Probe: Horn_3117_00167055(1-18GHz)	Polarity: Horizontal
EUT: Wireless Access Point	Power: AC 120V/60Hz
Note: Mode 8:Transmit at 5795MHz by 802.11ax(40MHz)	

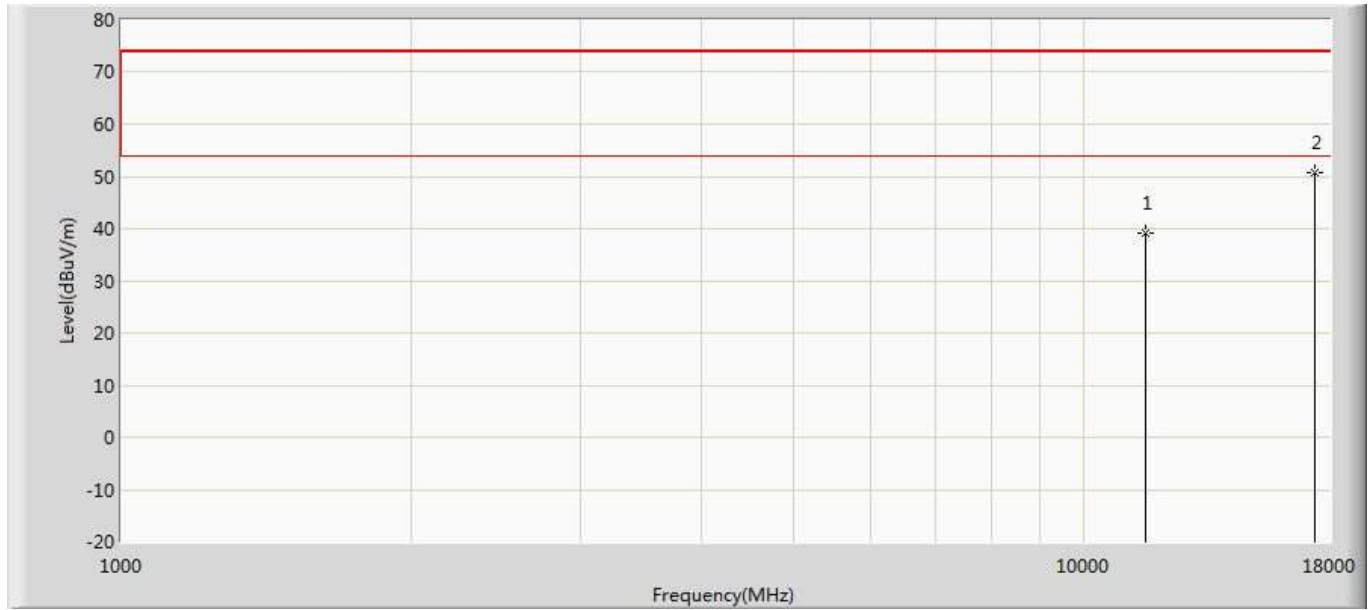

No	Mark	Frequency (MHz)	Measure Level (dBuV/m)	Reading Level (dBuV)	Over Limit (dB)	Limit (dBuV/m)	Factor (dB)	Type
1		11590.000	38.454	25.130	-35.546	74.000	13.324	PK
2	*	17385.000	51.638	29.463	-22.362	74.000	22.175	PK

Profile: 2032034R	Page No.: 157
Engineer: Neil	
Site: AC5	Time: 2020/06/18 - 20:46
Limit: FCC_Part15.209_RE(3m)	Margin: 0
Probe: Horn_3117_00167055(1-18GHz)	Polarity: Vertical
EUT: Wireless Access Point	Power: AC 120V/60Hz
Note: Mode 8:Transmit at 5795MHz by 802.11ax(40MHz)	

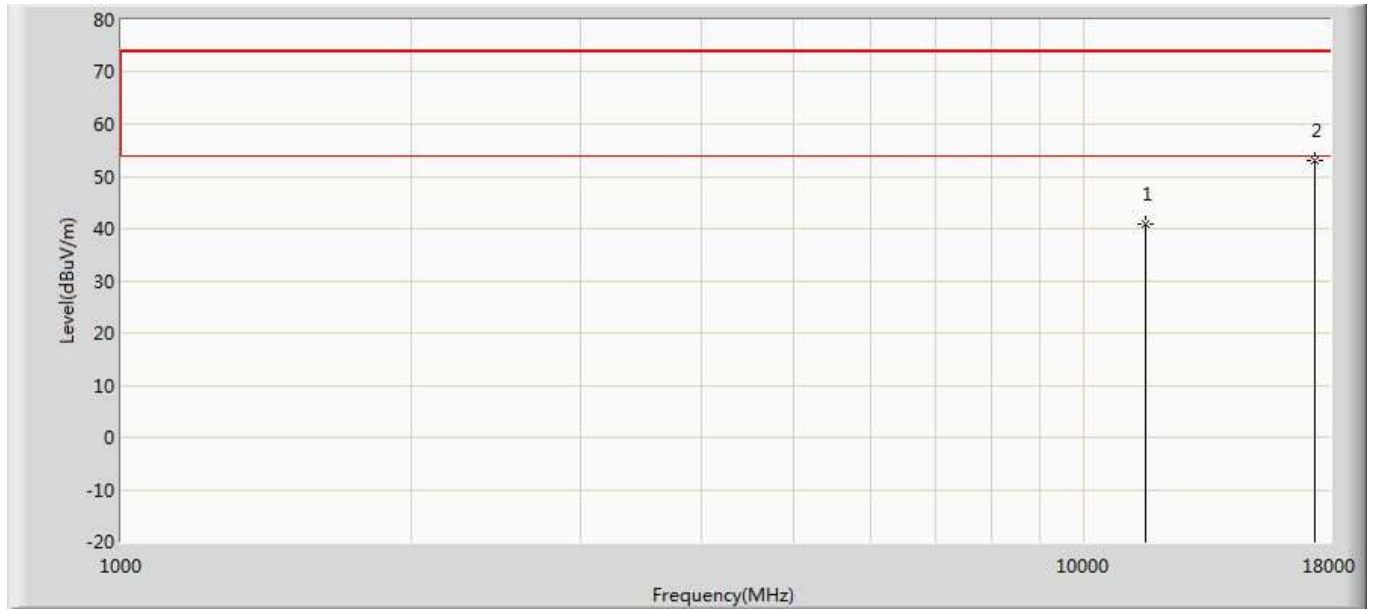

No	Mark	Frequency (MHz)	Measure Level (dBuV/m)	Reading Level (dBuV)	Over Limit (dB)	Limit (dBuV/m)	Factor (dB)	Type
1		11590.000	41.466	28.142	-32.534	74.000	13.324	PK
2	*	17385.000	53.961	31.786	-20.039	74.000	22.175	PK

Profile: 2032034R	Page No.: 158
Engineer: Neil	
Site: AC5	Time: 2020/06/18 - 20:47
Limit: FCC_Part15.209_RE(3m)	Margin: 0
Probe: Horn_3117_00167055(1-18GHz)	Polarity: Horizontal
EUT: Wireless Access Point	Power: AC 120V/60Hz
Note: Mode 9:Transmit at 5210MHz by 802.11ax(80MHz)	

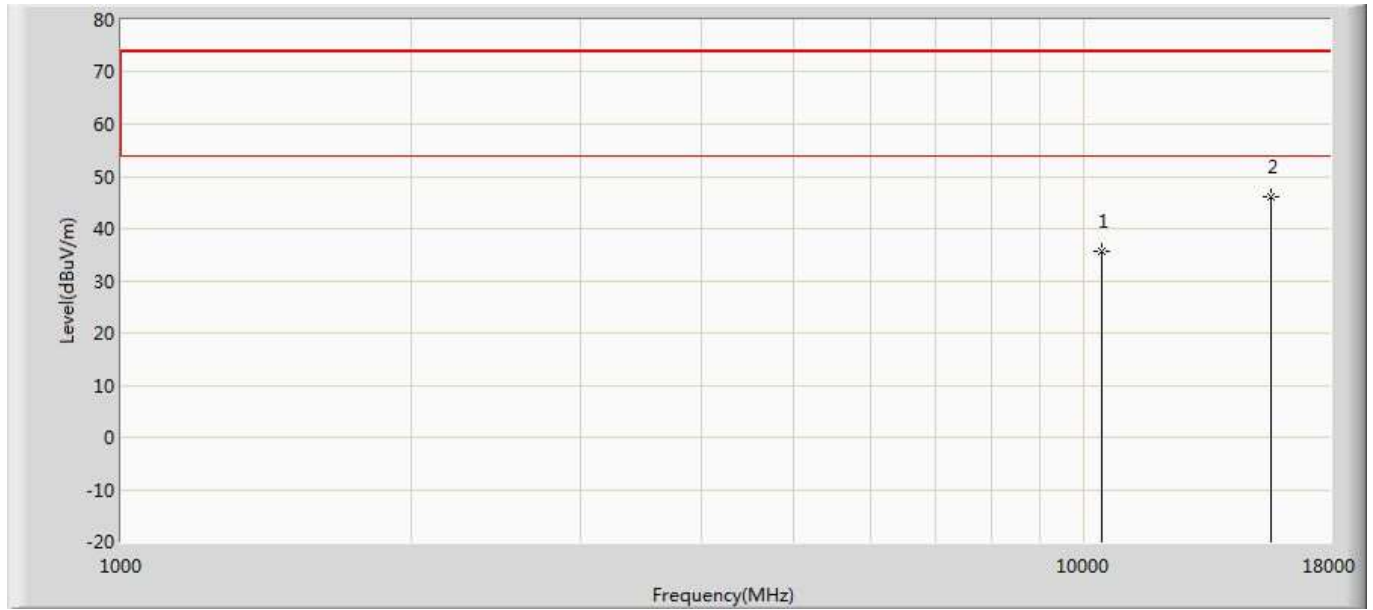

No	Mark	Frequency (MHz)	Measure Level (dBuV/m)	Reading Level (dBuV)	Over Limit (dB)	Limit (dBuV/m)	Factor (dB)	Type
1		10420.000	36.288	25.643	-37.712	74.000	10.645	PK
2	*	15630.000	45.831	29.489	-28.169	74.000	16.342	PK

Profile: 2032034R	Page No.: 159
Engineer: Neil	
Site: AC5	Time: 2020/06/18 - 20:47
Limit: FCC_Part15.209_RE(3m)	Margin: 0
Probe: Horn_3117_00167055(1-18GHz)	Polarity: Vertical
EUT: Wireless Access Point	Power: AC 120V/60Hz
Note: Mode 9:Transmit at 5210MHz by 802.11ax(80MHz)	

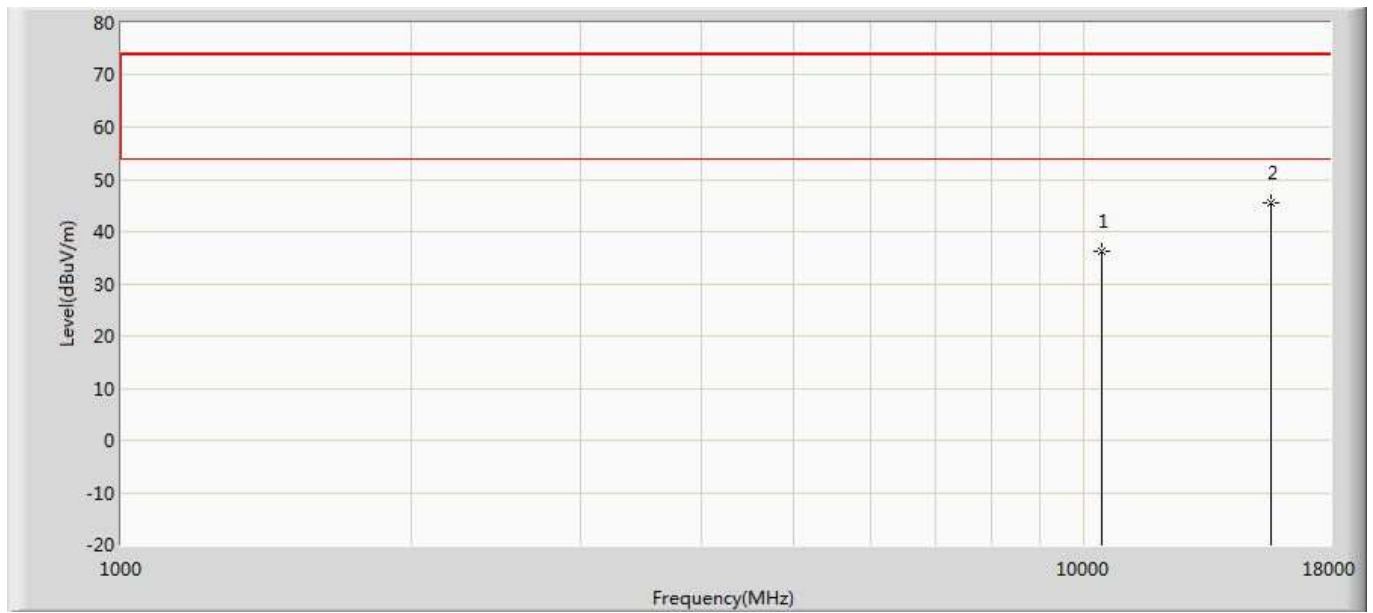

No	Mark	Frequency (MHz)	Measure Level (dBuV/m)	Reading Level (dBuV)	Over Limit (dB)	Limit (dBuV/m)	Factor (dB)	Type
1		10420.000	37.570	26.925	-36.430	74.000	10.645	PK
2	*	15630.000	45.374	29.032	-28.626	74.000	16.342	PK

Profile: 2032034R	Page No.: 160
Engineer: Neil	
Site: AC5	Time: 2020/06/18 - 20:48
Limit: FCC_Part15.209_RE(3m)	Margin: 0
Probe: Horn_3117_00167055(1-18GHz)	Polarity: Horizontal
EUT: Wireless Access Point	Power: AC 120V/60Hz
Note: Mode 9:Transmit at 5775MHz by 802.11ax(80MHz)	

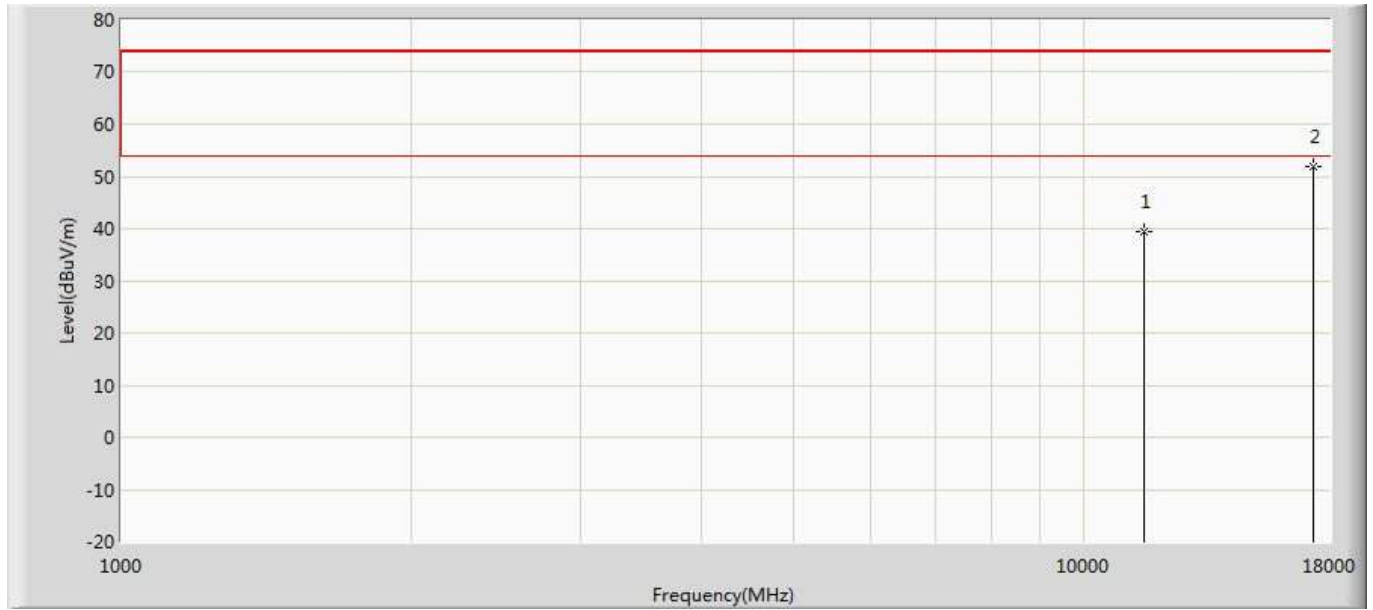

No	Mark	Frequency (MHz)	Measure Level (dBuV/m)	Reading Level (dBuV)	Over Limit (dB)	Limit (dBuV/m)	Factor (dB)	Type
1		11550.000	39.021	25.749	-34.979	74.000	13.272	PK
2	*	17325.000	50.601	28.321	-23.399	74.000	22.280	PK



Profile: 2032034R	Page No.: 161
Engineer: Neil	
Site: AC5	Time: 2020/06/18 - 20:48
Limit: FCC_Part15.209_RE(3m)	Margin: 0
Probe: Horn_3117_00167055(1-18GHz)	Polarity: Vertical
EUT: Wireless Access Point	Power: AC 120V/60Hz
Note: Mode 9:Transmit at 5775MHz by 802.11ax(80MHz)	

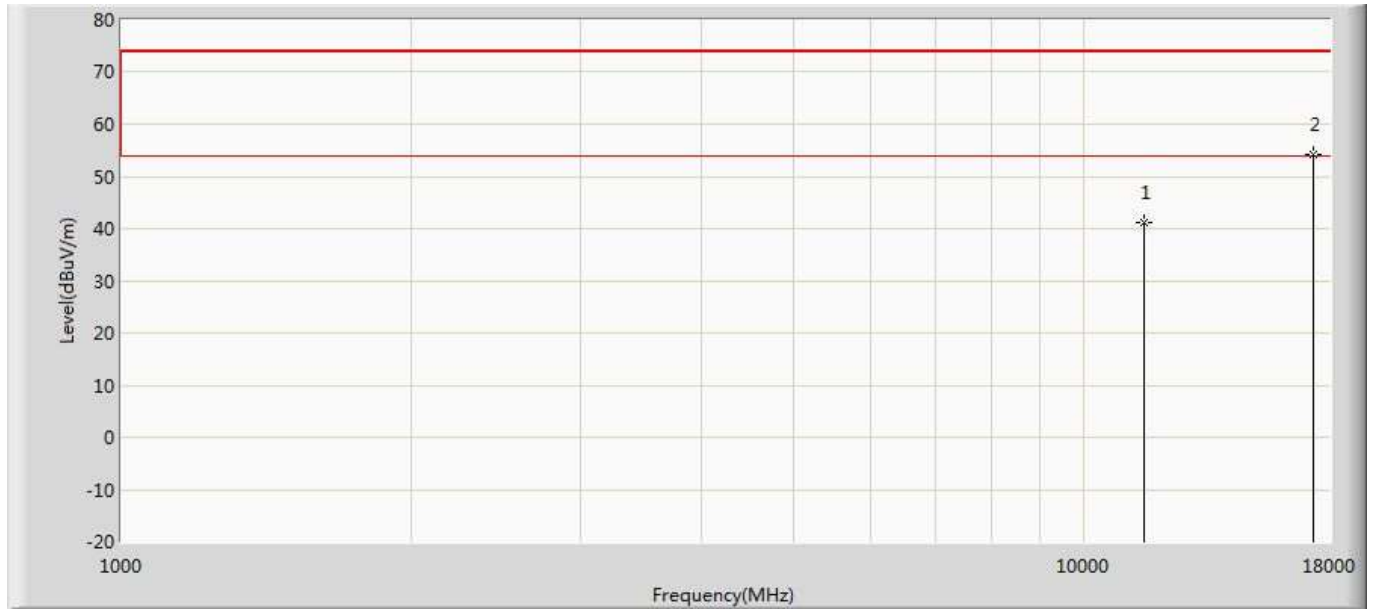

No	Mark	Frequency (MHz)	Measure Level (dBuV/m)	Reading Level (dBuV)	Over Limit (dB)	Limit (dBuV/m)	Factor (dB)	Type
1		11550.000	40.897	27.625	-33.103	74.000	13.272	PK
2	*	17325.000	53.811	31.531	-20.189	74.000	22.280	PK

### Radio3-5G high band mode-2\*2 CDD

Profile: 2032034R	Page No.: 8
Engineer: Neil	
Site: AC5	Time: 2020/06/18 - 19:38
Limit: FCC_Part15.209_RE(3m)	Margin: 0
Probe: Horn_3117_00167055(1-18GHz)	Polarity: Horizontal
EUT: Wireless Access Point	Power: AC 120V/60Hz
Note: Mode 1:Transmit at 5745MHz by 802.11a	

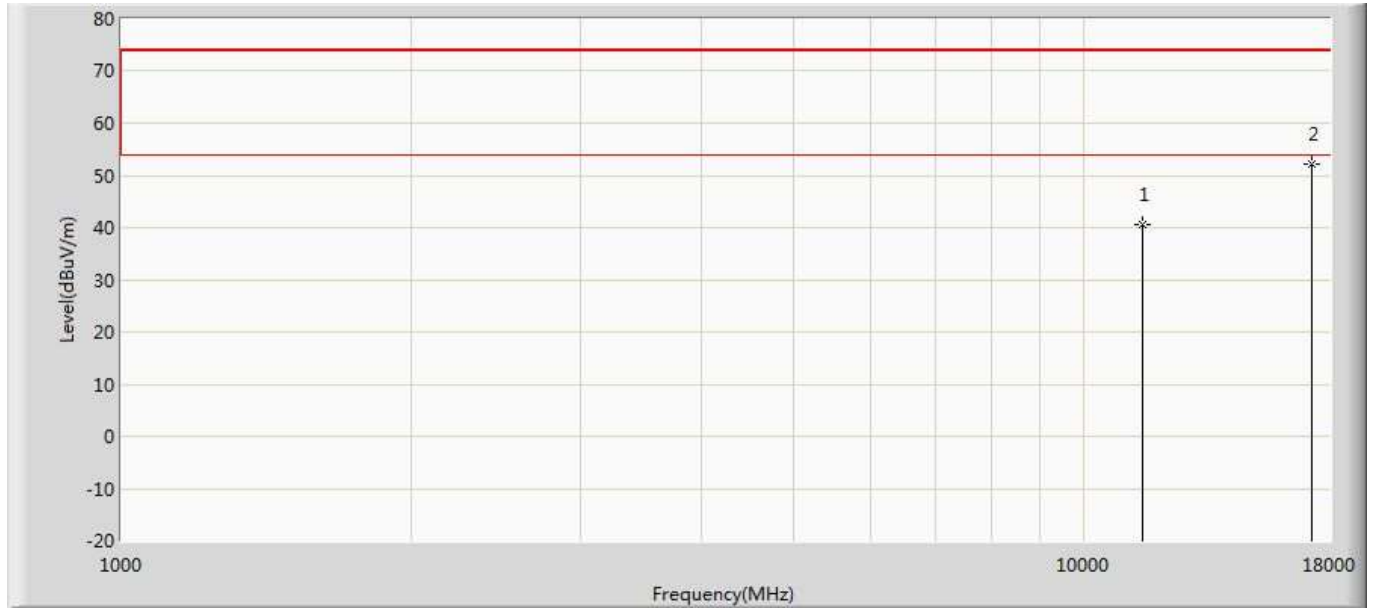

No	Mark	Frequency (MHz)	Measure Level (dBuV/m)	Reading Level (dBuV)	Over Limit (dB)	Limit (dBuV/m)	Factor (dB)	Type
1		11490.000	41.110	28.359	-32.890	74.000	12.751	PK
2	*	17235.000	52.022	31.796	-21.978	74.000	20.226	PK

Profile: 2032034R	Page No.: 9
Engineer: Neil	
Site: AC5	Time: 2020/06/18 - 19:38
Limit: FCC_Part15.209_RE(3m)	Margin: 0
Probe: Horn_3117_00167055(1-18GHz)	Polarity: Vertical
EUT: Wireless Access Point	Power: AC 120V/60Hz
Note: Mode 1:Transmit at 5745MHz by 802.11a	

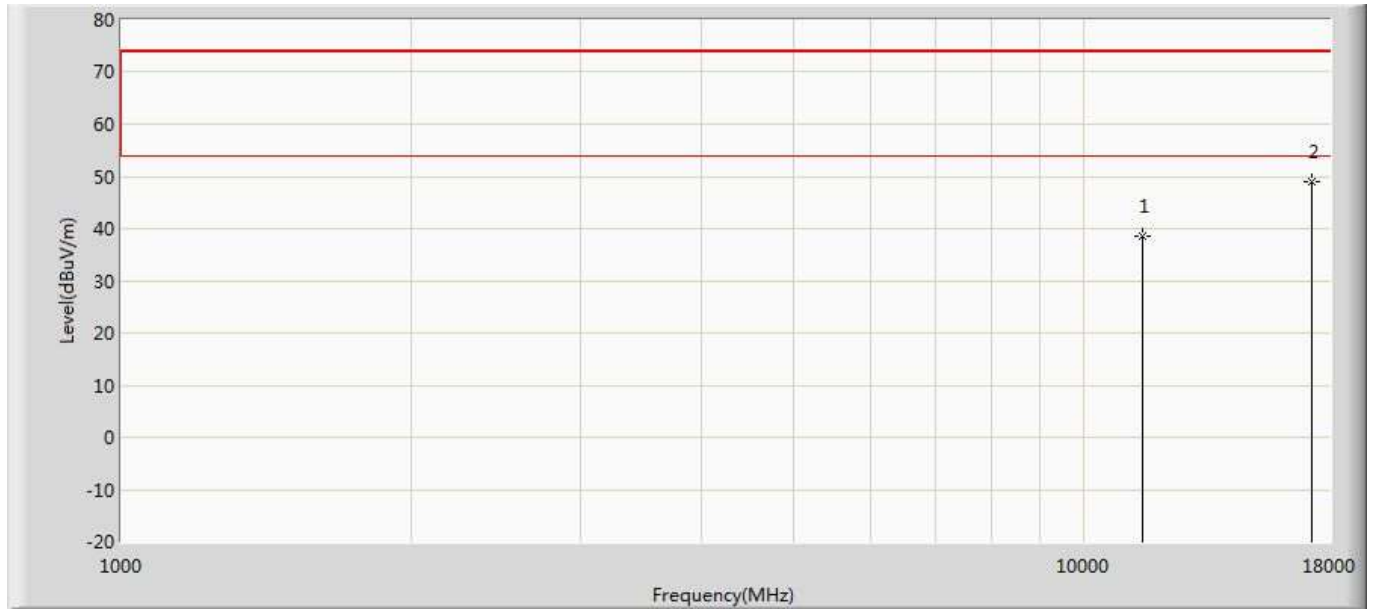

No	Mark	Frequency (MHz)	Measure Level (dBuV/m)	Reading Level (dBuV)	Over Limit (dB)	Limit (dBuV/m)	Factor (dB)	Type
1		11490.000	38.771	26.020	-35.229	74.000	12.751	PK
2	*	17235.000	48.586	28.360	-25.414	74.000	20.226	PK

Profile: 2032034R	Page No.: 10
Engineer: Neil	
Site: AC5	Time: 2020/06/18 - 19:40
Limit: FCC_Part15.209_RE(3m)	Margin: 0
Probe: Horn_3117_00167055(1-18GHz)	Polarity: Horizontal
EUT: Wireless Access Point	Power: AC 120V/60Hz
Note: Mode 1:Transmit at 5785MHz by 802.11a	

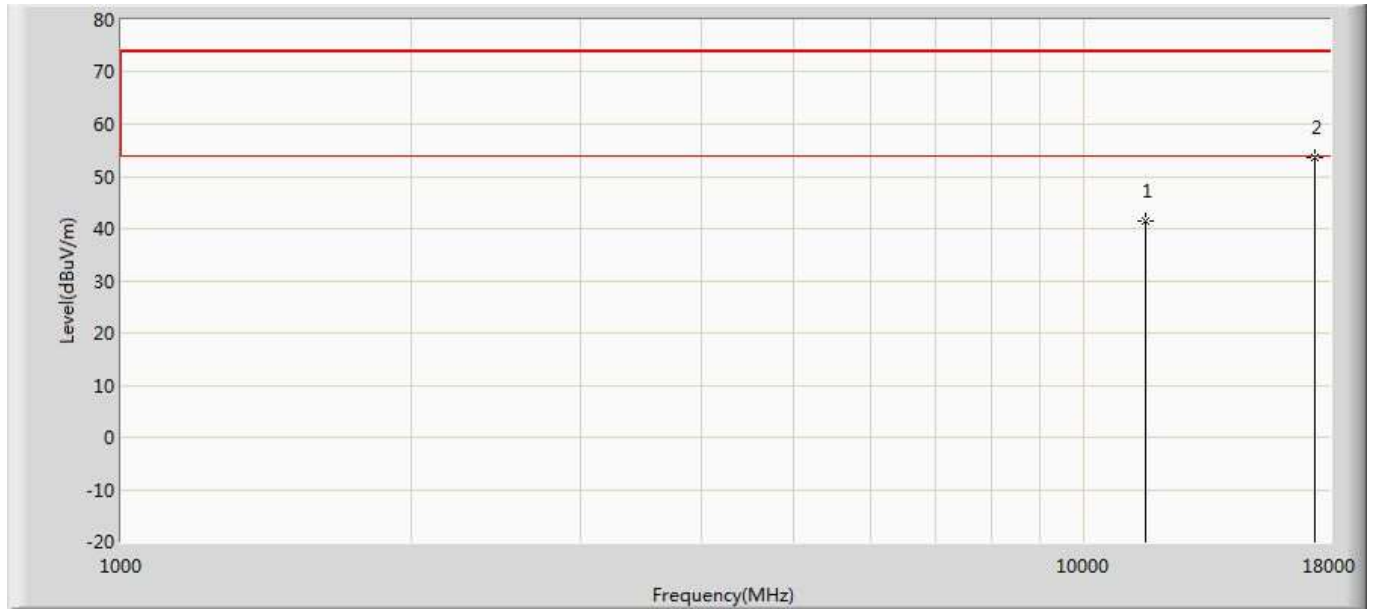

No	Mark	Frequency (MHz)	Measure Level (dBuV/m)	Reading Level (dBuV)	Over Limit (dB)	Limit (dBuV/m)	Factor (dB)	Type
1		11570.000	42.074	28.918	-31.926	74.000	13.156	PK
2	*	17355.000	52.989	29.991	-21.011	74.000	22.998	PK

Profile: 2032034R	Page No.: 11
Engineer: Neil	
Site: AC5	Time: 2020/06/18 - 19:40
Limit: FCC_Part15.209_RE(3m)	Margin: 0
Probe: Horn_3117_00167055(1-18GHz)	Polarity: Vertical
EUT: Wireless Access Point	Power: AC 120V/60Hz
Note: Mode 1:Transmit at 5785MHz by 802.11a	

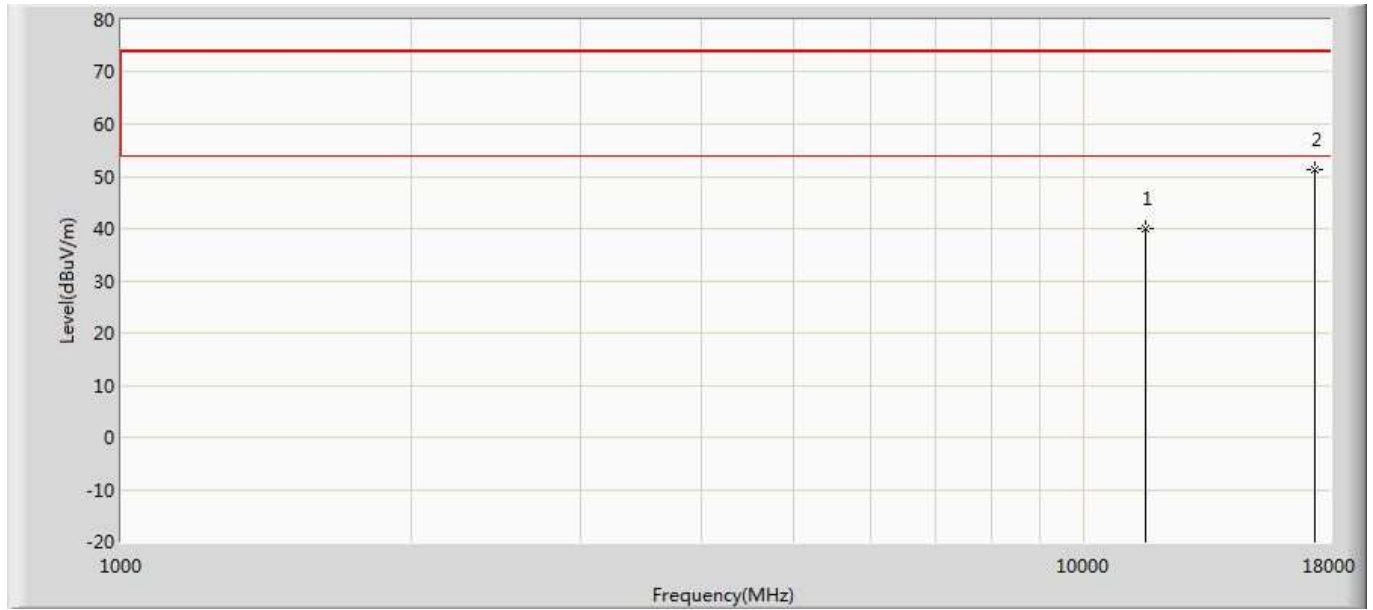

No	Mark	Frequency (MHz)	Measure Level (dBuV/m)	Reading Level (dBuV)	Over Limit (dB)	Limit (dBuV/m)	Factor (dB)	Type
1		11570.000	40.678	27.522	-33.322	74.000	13.156	PK
2	*	17355.000	51.939	28.941	-22.061	74.000	22.998	PK

Profile: 2032034R	Page No.: 12
Engineer: Neil	
Site: AC5	Time: 2020/06/18 - 19:41
Limit: FCC_Part15.209_RE(3m)	Margin: 0
Probe: Horn_3117_00167055(1-18GHz)	Polarity: Horizontal
EUT: Wireless Access Point	Power: AC 120V/60Hz
Note: Mode 1:Transmit at 5825MHz by 802.11a	

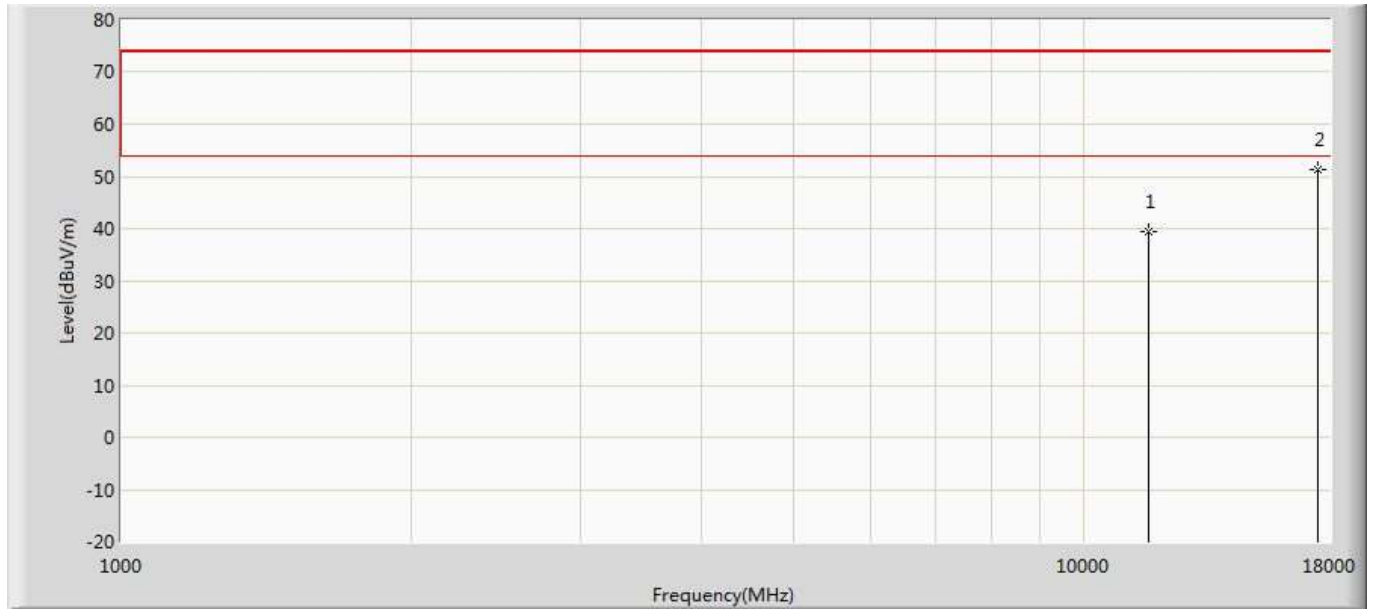

No	Mark	Frequency (MHz)	Measure Level (dBuV/m)	Reading Level (dBuV)	Over Limit (dB)	Limit (dBuV/m)	Factor (dB)	Type
1		11650.000	39.135	25.246	-34.865	74.000	13.889	PK
2	*	17475.000	52.307	30.724	-21.693	74.000	21.583	PK

Profile: 2032034R	Page No.: 13
Engineer: Neil	
Site: AC5	Time: 2020/06/18 - 19:41
Limit: FCC_Part15.209_RE(3m)	Margin: 0
Probe: Horn_3117_00167055(1-18GHz)	Polarity: Vertical
EUT: Wireless Access Point	Power: AC 120V/60Hz
Note: Mode 1:Transmit at 5825MHz by 802.11a	

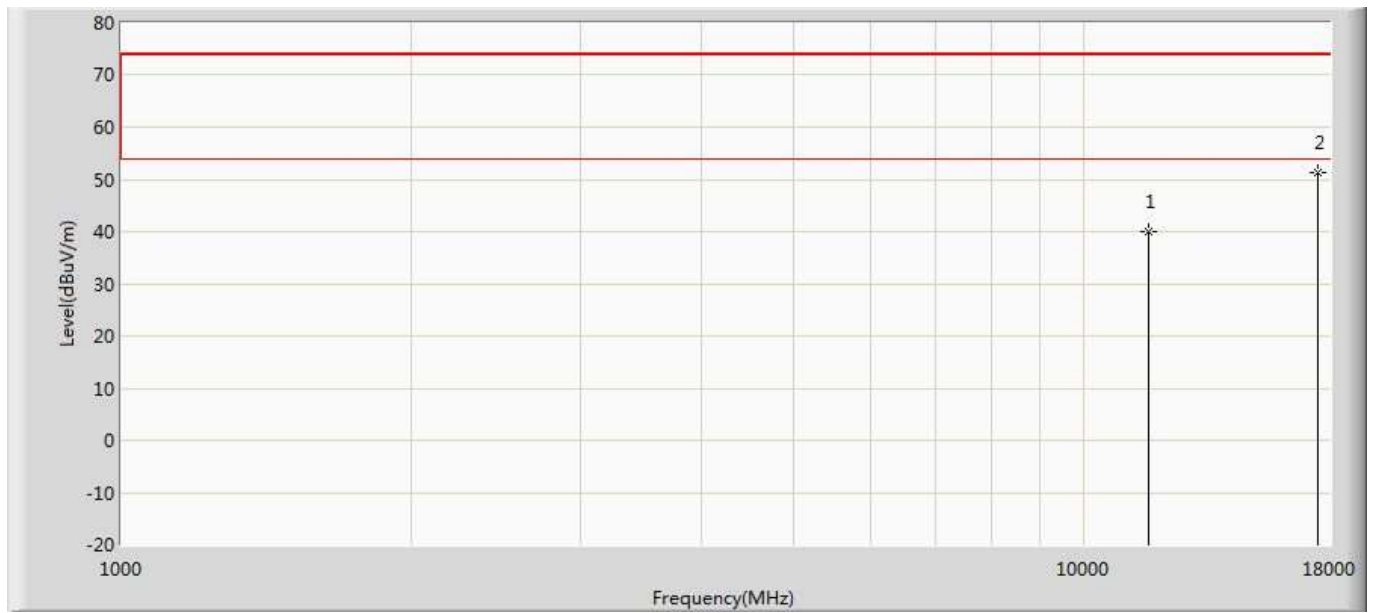

No	Mark	Frequency (MHz)	Measure Level (dBuV/m)	Reading Level (dBuV)	Over Limit (dB)	Limit (dBuV/m)	Factor (dB)	Type
1		11650.000	40.073	26.184	-33.927	74.000	13.889	PK
2	*	17475.000	51.328	29.745	-22.672	74.000	21.583	PK

Profile: 2032034R	Page No.: 20
Engineer: Neil	
Site: AC5	Time: 2020/06/18 - 19:54
Limit: FCC_Part15.209_RE(3m)	Margin: 0
Probe: Horn_3117_00167055(1-18GHz)	Polarity: Horizontal
EUT: Wireless Access Point	Power: AC 120V/60Hz
Note: Mode 2: Transmit at 5745MHz by 802.11n(20MHz)	

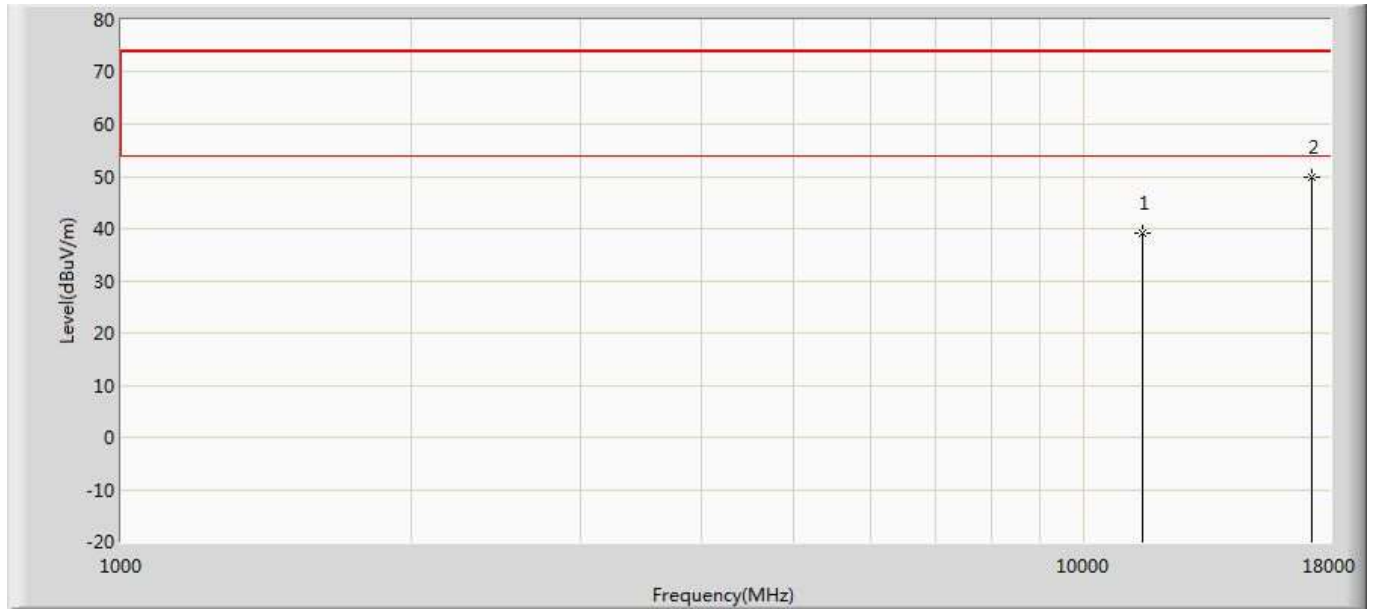

No	Mark	Frequency (MHz)	Measure Level (dBuV/m)	Reading Level (dBuV)	Over Limit (dB)	Limit (dBuV/m)	Factor (dB)	Type
1		11490.000	39.069	26.318	-34.931	74.000	12.751	PK
2	*	17235.000	50.232	30.006	-23.768	74.000	20.226	PK



Profile: 2032034R	Page No.: 21
Engineer: Neil	
Site: AC5	Time: 2020/06/18 - 19:54
Limit: FCC_Part15.209_RE(3m)	Margin: 0
Probe: Horn_3117_00167055(1-18GHz)	Polarity: Vertical
EUT: Wireless Access Point	Power: AC 120V/60Hz
Note: Mode 2: Transmit at 5745MHz by 802.11n(20MHz)	

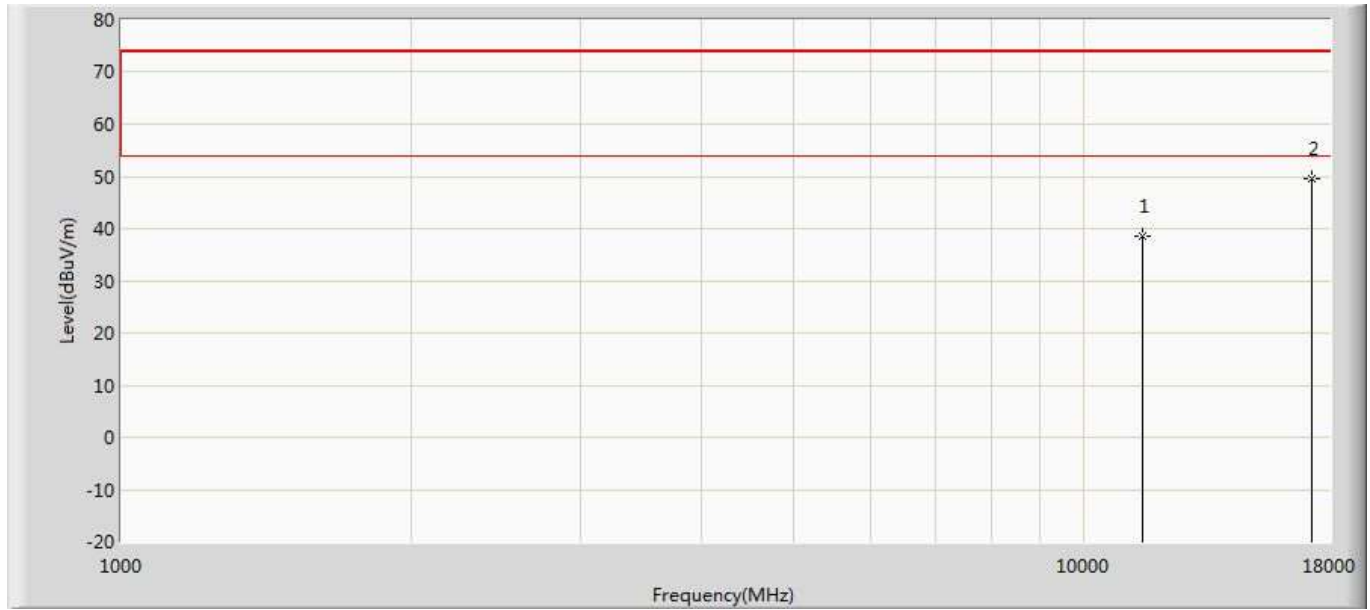

No	Mark	Frequency (MHz)	Measure Level (dBuV/m)	Reading Level (dBuV)	Over Limit (dB)	Limit (dBuV/m)	Factor (dB)	Type
1		11490.000	39.203	26.452	-34.797	74.000	12.751	PK
2	*	17235.000	50.789	30.563	-23.211	74.000	20.226	PK

Profile: 2032034R	Page No.: 22
Engineer: Neil	
Site: AC5	Time: 2020/06/18 - 19:54
Limit: FCC_Part15.209_RE(3m)	Margin: 0
Probe: Horn_3117_00167055(1-18GHz)	Polarity: Horizontal
EUT: Wireless Access Point	Power: AC 120V/60Hz
Note: Mode 2: Transmit at 5785MHz by 802.11n(20MHz)	

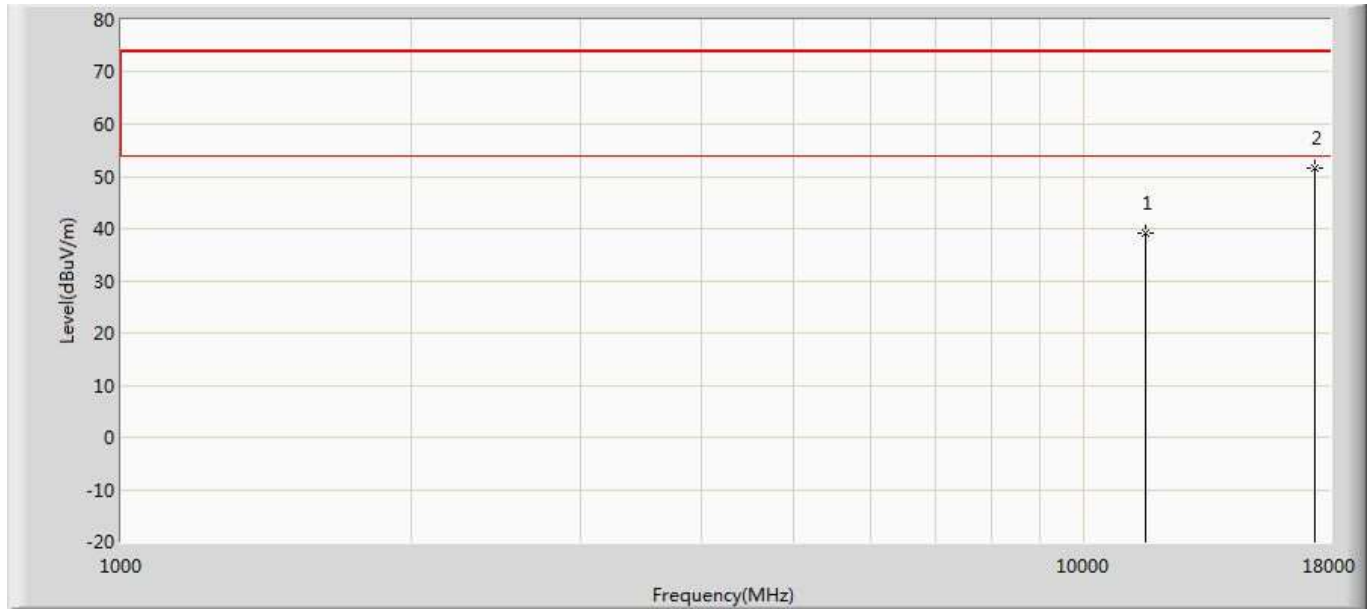

No	Mark	Frequency (MHz)	Measure Level (dBuV/m)	Reading Level (dBuV)	Over Limit (dB)	Limit (dBuV/m)	Factor (dB)	Type
1		11570.000	39.631	26.475	-34.369	74.000	13.156	PK
2	*	17355.000	52.783	29.785	-21.217	74.000	22.998	PK

Profile: 2032034R	Page No.: 23
Engineer: Neil	
Site: AC5	Time: 2020/06/18 - 19:54
Limit: FCC_Part15.209_RE(3m)	Margin: 0
Probe: Horn_3117_00167055(1-18GHz)	Polarity: Vertical
EUT: Wireless Access Point	Power: AC 120V/60Hz
Note: Mode 2:Transmit at 5785MHz by 802.11n(20MHz)	

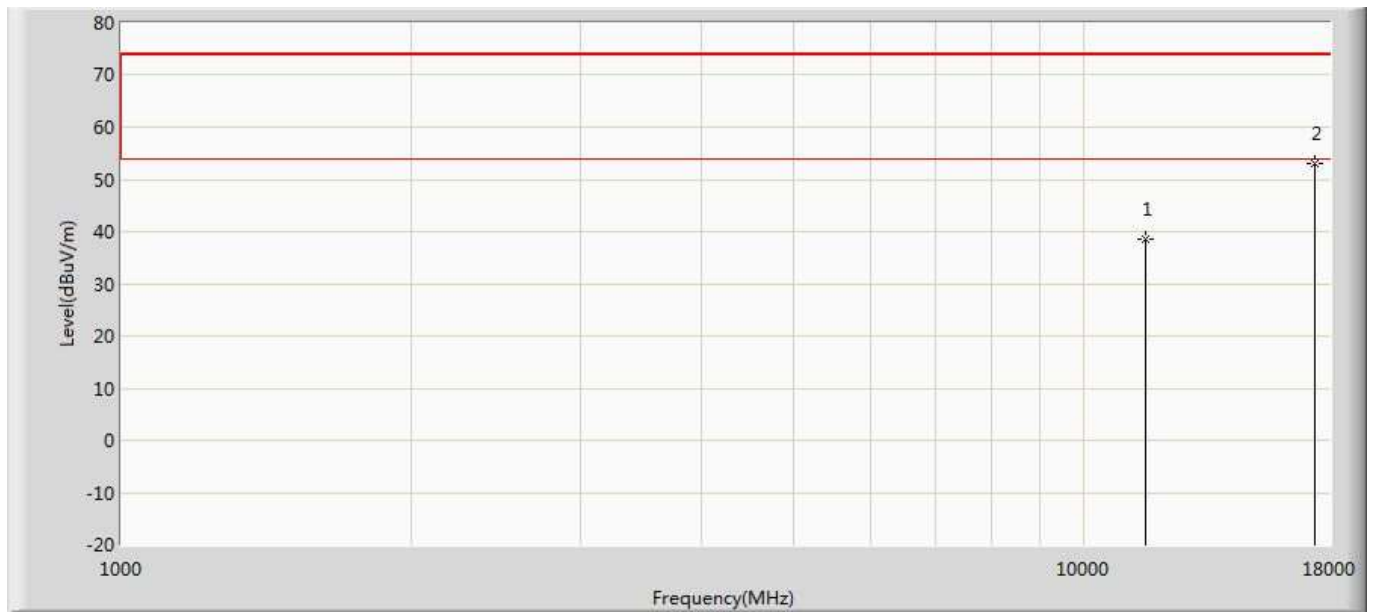

No	Mark	Frequency (MHz)	Measure Level (dBuV/m)	Reading Level (dBuV)	Over Limit (dB)	Limit (dBuV/m)	Factor (dB)	Type
1		11570.000	39.686	26.530	-34.314	74.000	13.156	PK
2	*	17355.000	53.763	30.765	-20.237	74.000	22.998	PK

Profile: 2032034R	Page No.: 24
Engineer: Neil	
Site: AC5	Time: 2020/06/18 - 19:55
Limit: FCC_Part15.209_RE(3m)	Margin: 0
Probe: Horn_3117_00167055(1-18GHz)	Polarity: Horizontal
EUT: Wireless Access Point	Power: AC 120V/60Hz
Note: Mode 2: Transmit at 5825MHz by 802.11n(20MHz)	

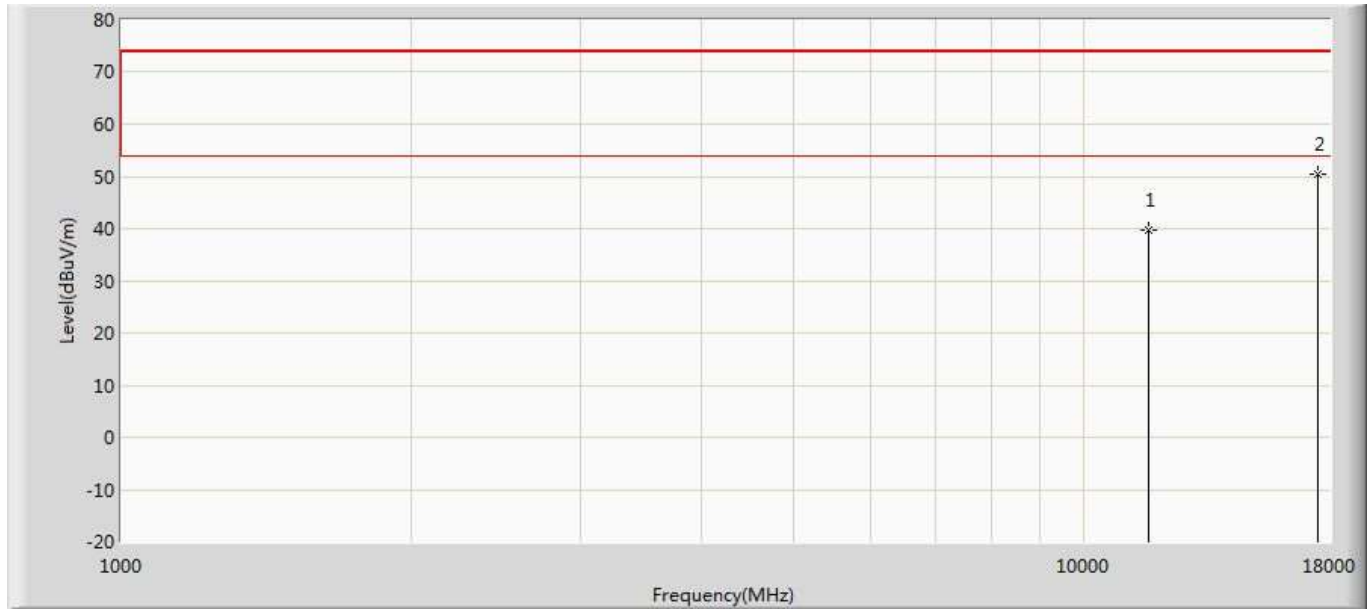

No	Mark	Frequency (MHz)	Measure Level (dBuV/m)	Reading Level (dBuV)	Over Limit (dB)	Limit (dBuV/m)	Factor (dB)	Type
1		11650.000	39.041	25.152	-34.959	74.000	13.889	PK
2	*	17475.000	50.171	28.588	-23.829	74.000	21.583	PK

Profile: 2032034R	Page No.: 25
Engineer: Neil	
Site: AC5	Time: 2020/06/18 - 19:55
Limit: FCC_Part15.209_RE(3m)	Margin: 0
Probe: Horn_3117_00167055(1-18GHz)	Polarity: Vertical
EUT: Wireless Access Point	Power: AC 120V/60Hz
Note: Mode 2: Transmit at 5825MHz by 802.11n(20MHz)	

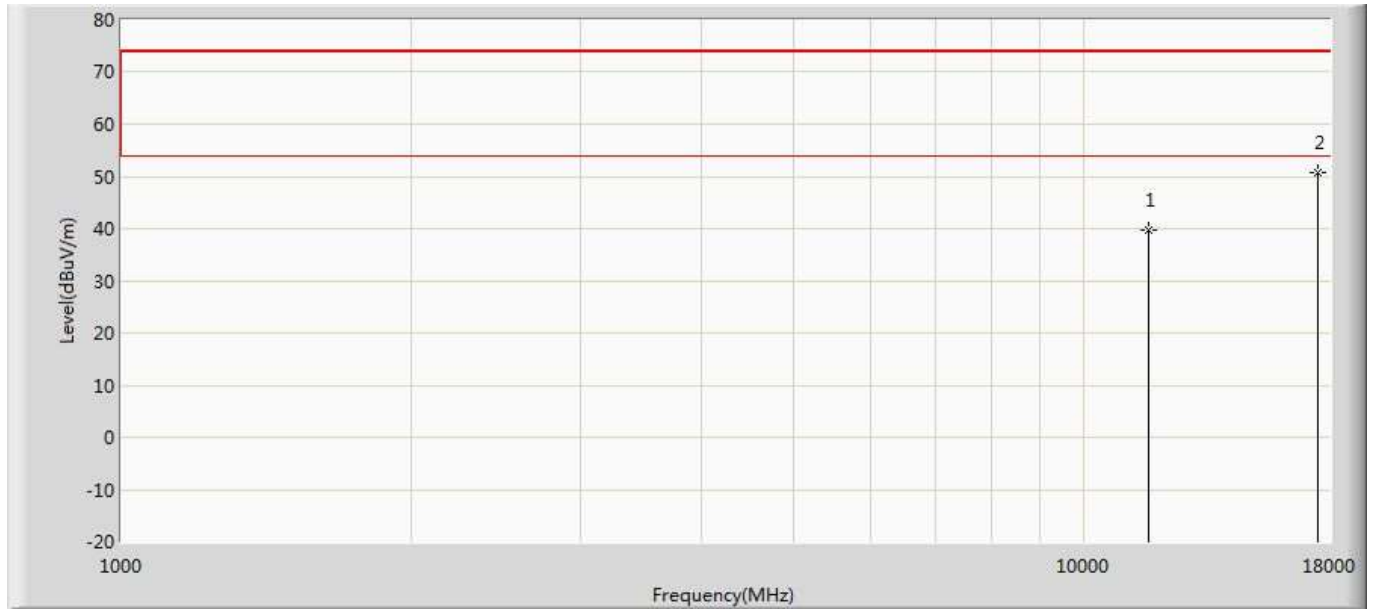

No	Mark	Frequency (MHz)	Measure Level (dBuV/m)	Reading Level (dBuV)	Over Limit (dB)	Limit (dBuV/m)	Factor (dB)	Type
1		11650.000	39.320	25.431	-34.680	74.000	13.889	PK
2	*	17475.000	51.178	29.595	-22.822	74.000	21.583	PK

Profile: 2032034R	Page No.: 30
Engineer: Neil	
Site: AC5	Time: 2020/06/18 - 19:57
Limit: FCC_Part15.209_RE(3m)	Margin: 0
Probe: Horn_3117_00167055(1-18GHz)	Polarity: Horizontal
EUT: Wireless Access Point	Power: AC 120V/60Hz
Note: Mode 3:Transmit at 5755MHz by 802.11n(40MHz)	

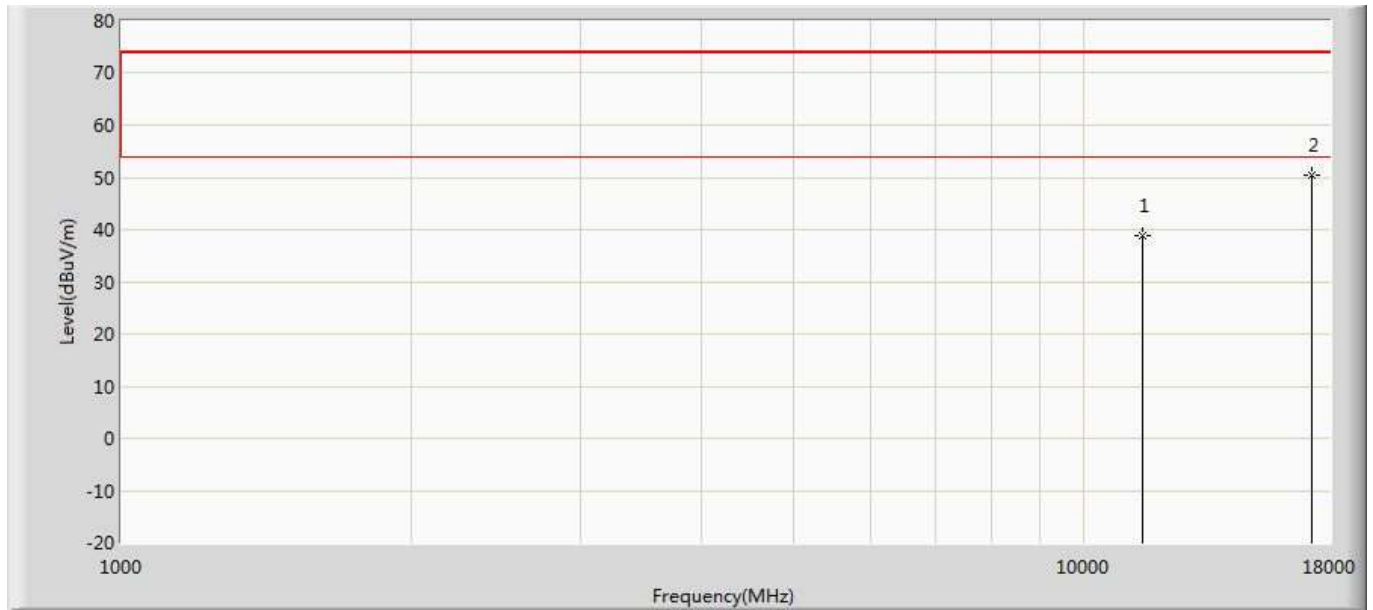

No	Mark	Frequency (MHz)	Measure Level (dBuV/m)	Reading Level (dBuV)	Over Limit (dB)	Limit (dBuV/m)	Factor (dB)	Type
1		11510.000	38.884	25.833	-35.116	74.000	13.051	PK
2	*	17265.000	51.260	30.532	-22.740	74.000	20.728	PK

Profile: 2032034R	Page No.: 31
Engineer: Neil	
Site: AC5	Time: 2020/06/18 - 19:58
Limit: FCC_Part15.209_RE(3m)	Margin: 0
Probe: Horn_3117_00167055(1-18GHz)	Polarity: Vertical
EUT: Wireless Access Point	Power: AC 120V/60Hz
Note: Mode 3:Transmit at 5755MHz by 802.11n(40MHz)	

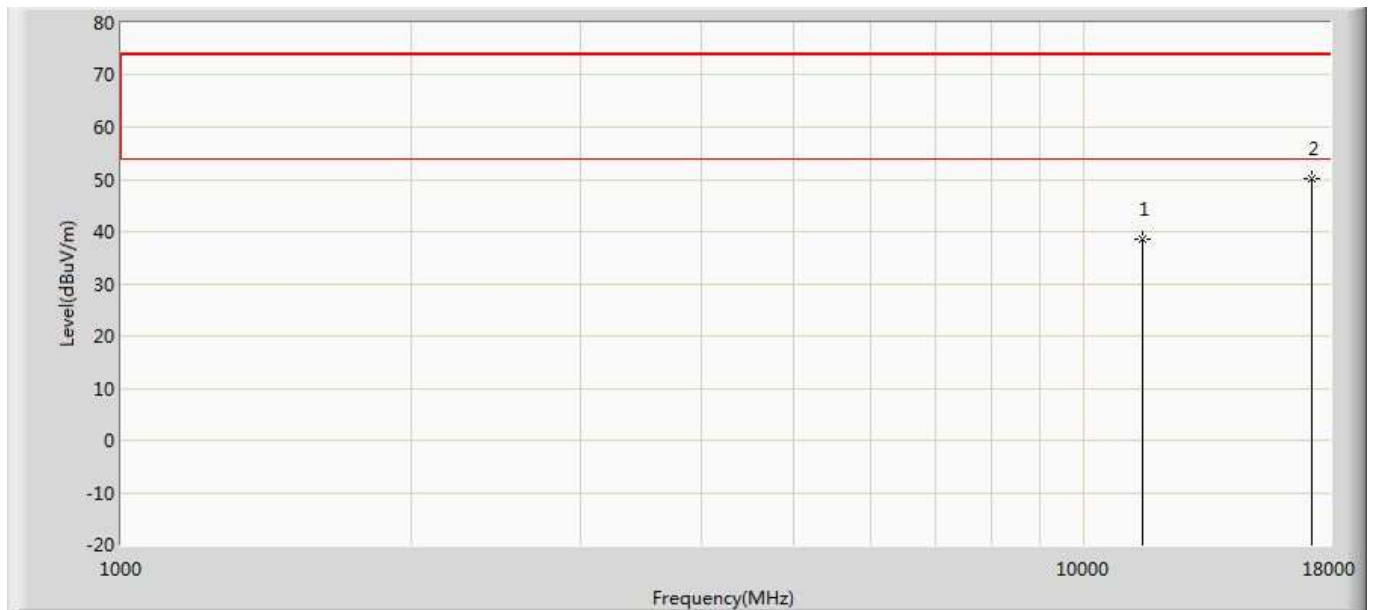

No	Mark	Frequency (MHz)	Measure Level (dBuV/m)	Reading Level (dBuV)	Over Limit (dB)	Limit (dBuV/m)	Factor (dB)	Type
1		11510.000	38.395	25.344	-35.605	74.000	13.051	PK
2	*	17265.000	50.842	30.114	-23.158	74.000	20.728	PK

Profile: 2032034R	Page No.: 32
Engineer: Neil	
Site: AC5	Time: 2020/06/18 - 19:58
Limit: FCC_Part15.209_RE(3m)	Margin: 0
Probe: Horn_3117_00167055(1-18GHz)	Polarity: Horizontal
EUT: Wireless Access Point	Power: AC 120V/60Hz
Note: Mode 3:Transmit at 5795MHz by 802.11n(40MHz)	

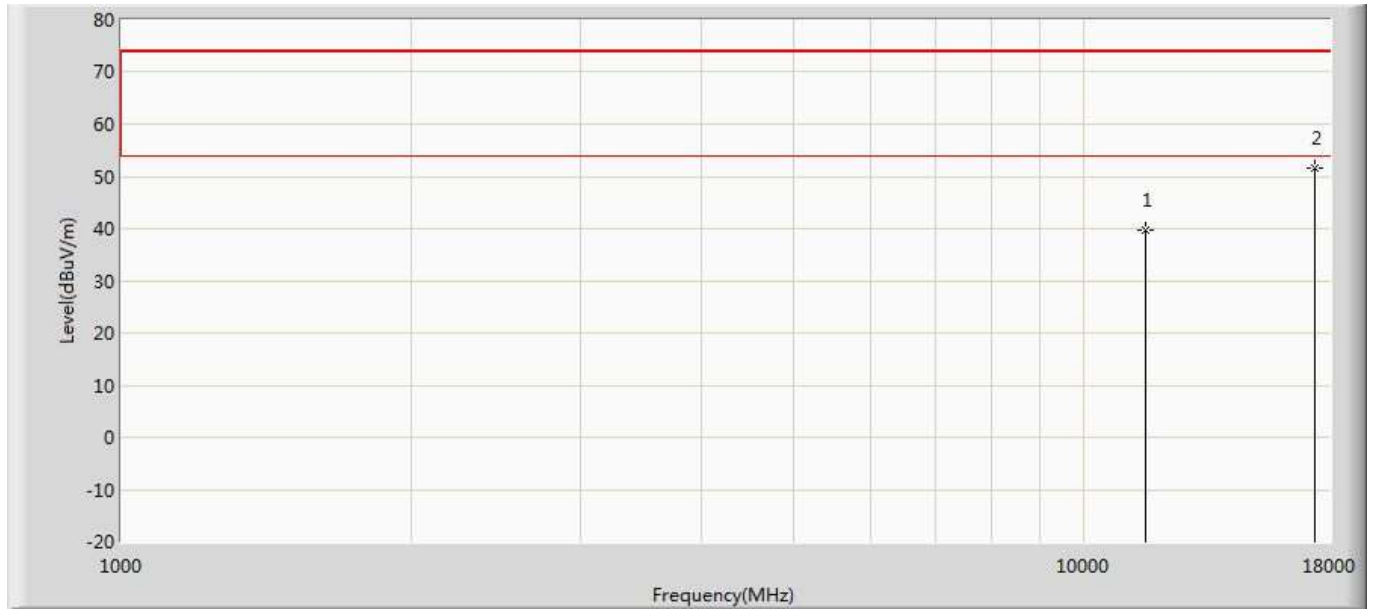

No	Mark	Frequency (MHz)	Measure Level (dBuV/m)	Reading Level (dBuV)	Over Limit (dB)	Limit (dBuV/m)	Factor (dB)	Type
1		11590.000	38.980	25.656	-35.020	74.000	13.324	PK
2	*	17385.000	51.547	29.372	-22.453	74.000	22.175	PK



Profile: 2032034R	Page No.: 33
Engineer: Neil	
Site: AC5	Time: 2020/06/18 - 19:58
Limit: FCC_Part15.209_RE(3m)	Margin: 0
Probe: Horn_3117_00167055(1-18GHz)	Polarity: Vertical
EUT: Wireless Access Point	Power: AC 120V/60Hz
Note: Mode 3:Transmit at 5795MHz by 802.11n(40MHz)	

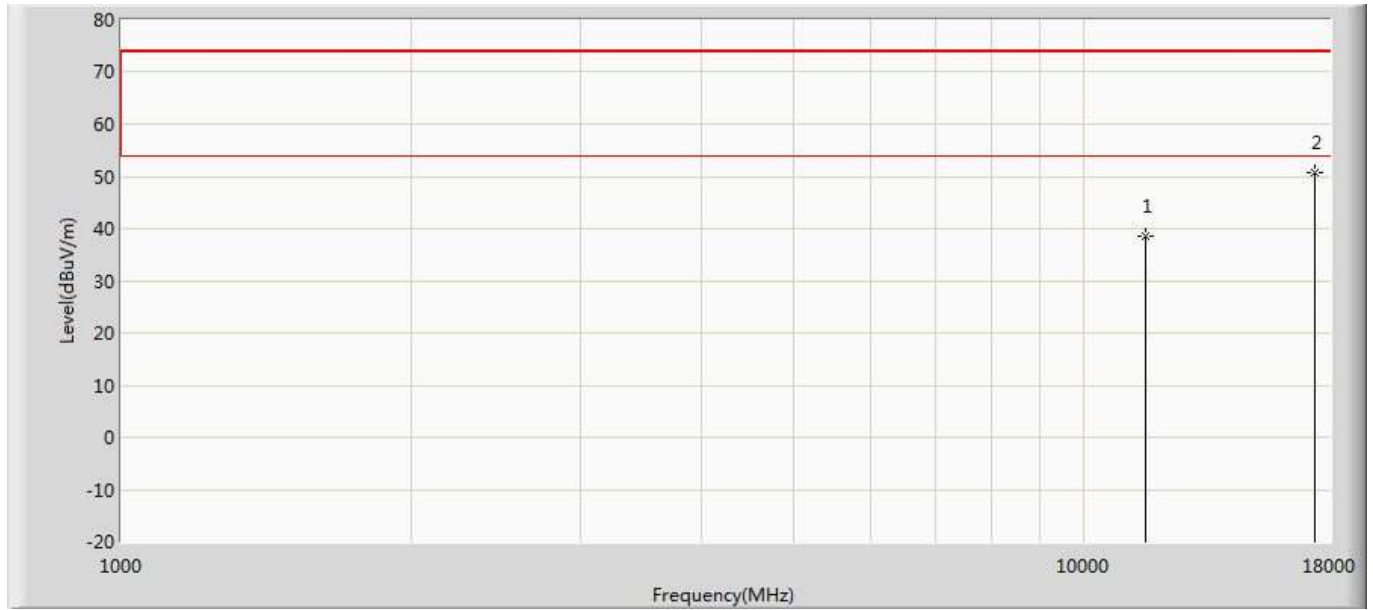

No	Mark	Frequency (MHz)	Measure Level (dBuV/m)	Reading Level (dBuV)	Over Limit (dB)	Limit (dBuV/m)	Factor (dB)	Type
1		11590.000	39.149	25.825	-34.851	74.000	13.324	PK
2	*	17385.000	51.614	29.439	-22.386	74.000	22.175	PK

Profile: 2032034R	Page No.: 40
Engineer: Neil	
Site: AC5	Time: 2020/06/18 - 20:02
Limit: FCC_Part15.209_RE(3m)	Margin: 0
Probe: Horn_3117_00167055(1-18GHz)	Polarity: Horizontal
EUT: Wireless Access Point	Power: AC 120V/60Hz
Note: Mode 4:Transmit at 5745MHz by 802.11ac(20MHz)	

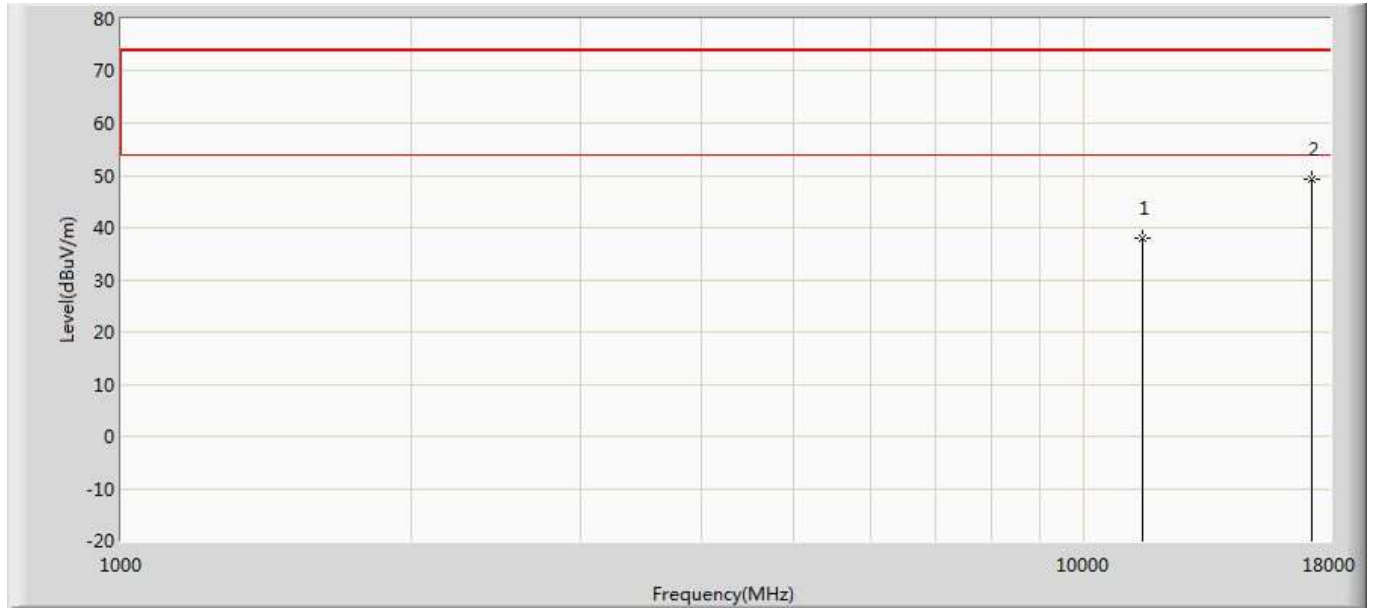

No	Mark	Frequency (MHz)	Measure Level (dBuV/m)	Reading Level (dBuV)	Over Limit (dB)	Limit (dBuV/m)	Factor (dB)	Type
1		11490.000	38.472	25.721	-35.528	74.000	12.751	PK
2	*	17235.000	50.252	30.026	-23.748	74.000	20.226	PK

Profile: 2032034R	Page No.: 41
Engineer: Neil	
Site: AC5	Time: 2020/06/18 - 20:03
Limit: FCC_Part15.209_RE(3m)	Margin: 0
Probe: Horn_3117_00167055(1-18GHz)	Polarity: Vertical
EUT: Wireless Access Point	Power: AC 120V/60Hz
Note: Mode 4:Transmit at 5745MHz by 802.11ac(20MHz)	

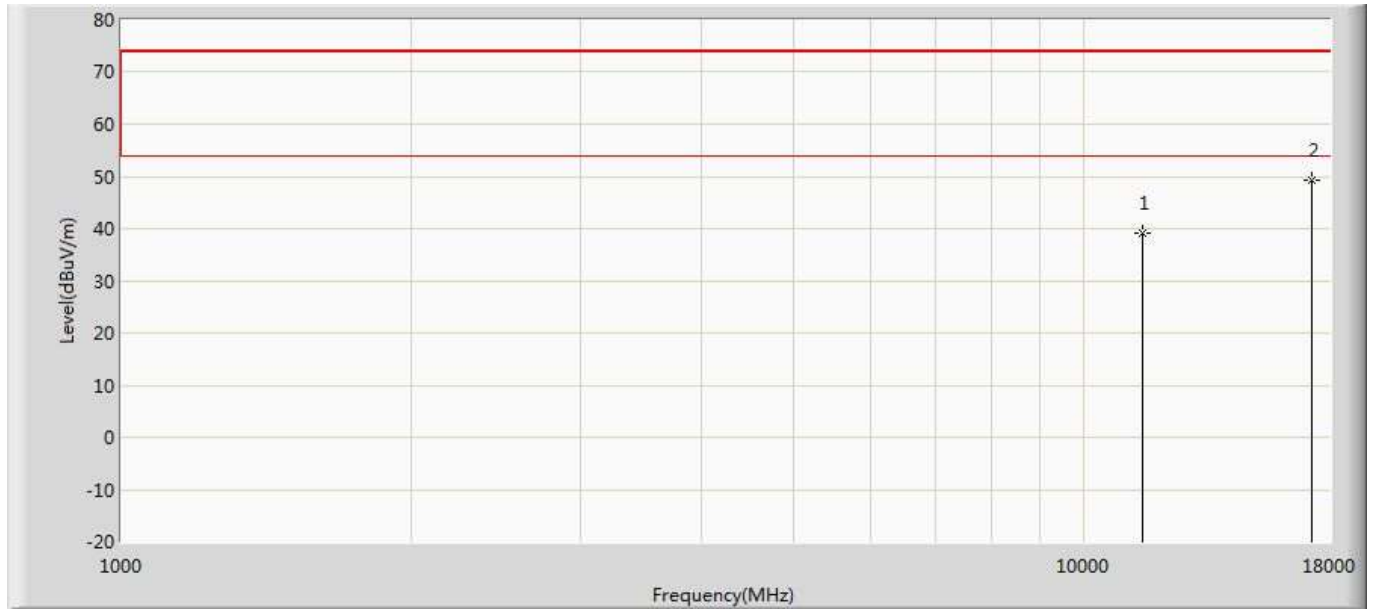

No	Mark	Frequency (MHz)	Measure Level (dBuV/m)	Reading Level (dBuV)	Over Limit (dB)	Limit (dBuV/m)	Factor (dB)	Type
1		11490.000	39.224	26.473	-34.776	74.000	12.751	PK
2	*	17235.000	50.050	29.824	-23.950	74.000	20.226	PK

Profile: 2032034R	Page No.: 42
Engineer: Neil	
Site: AC5	Time: 2020/06/18 - 20:03
Limit: FCC_Part15.209_RE(3m)	Margin: 0
Probe: Horn_3117_00167055(1-18GHz)	Polarity: Horizontal
EUT: Wireless Access Point	Power: AC 120V/60Hz
Note: Mode 4:Transmit at 5785MHz by 802.11ac(20MHz)	

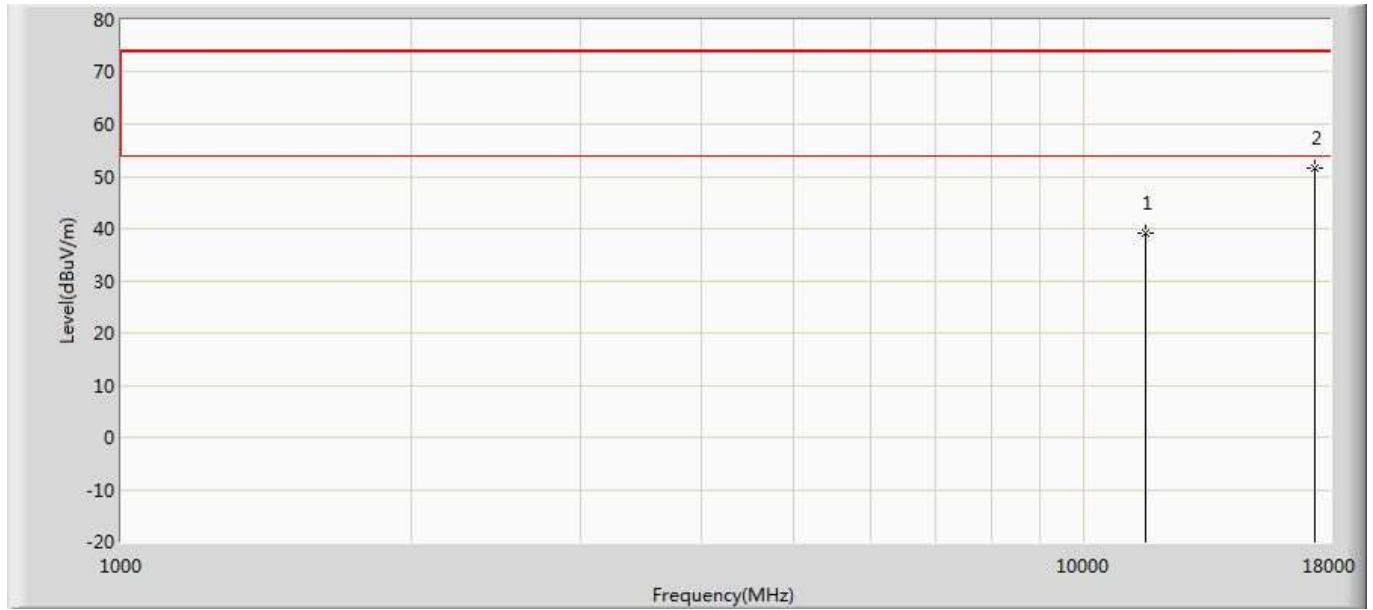

No	Mark	Frequency (MHz)	Measure Level (dBuV/m)	Reading Level (dBuV)	Over Limit (dB)	Limit (dBuV/m)	Factor (dB)	Type
1		11570.000	39.632	26.476	-34.368	74.000	13.156	PK
2	*	17355.000	53.109	30.111	-20.891	74.000	22.998	PK

Profile: 2032034R	Page No.: 43
Engineer: Neil	
Site: AC5	Time: 2020/06/18 - 20:03
Limit: FCC_Part15.209_RE(3m)	Margin: 0
Probe: Horn_3117_00167055(1-18GHz)	Polarity: Vertical
EUT: Wireless Access Point	Power: AC 120V/60Hz
Note: Mode 4:Transmit at 5785MHz by 802.11ac(20MHz)	

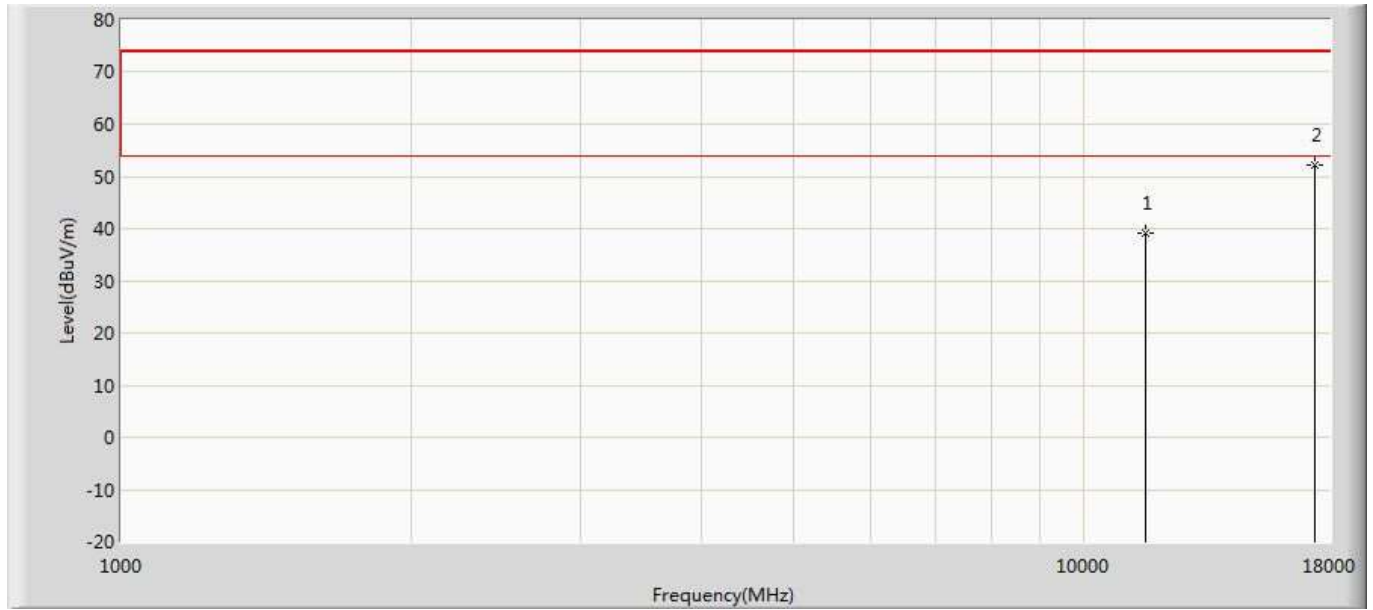

No	Mark	Frequency (MHz)	Measure Level (dBuV/m)	Reading Level (dBuV)	Over Limit (dB)	Limit (dBuV/m)	Factor (dB)	Type
1		11570.000	39.158	26.002	-34.842	74.000	13.156	PK
2	*	17355.000	52.275	29.277	-21.725	74.000	22.998	PK

Profile: 2032034R	Page No.: 44
Engineer: Neil	
Site: AC5	Time: 2020/06/18 - 20:04
Limit: FCC_Part15.209_RE(3m)	Margin: 0
Probe: Horn_3117_00167055(1-18GHz)	Polarity: Horizontal
EUT: Wireless Access Point	Power: AC 120V/60Hz
Note: Mode 4:Transmit at 5825MHz by 802.11ac(20MHz)	

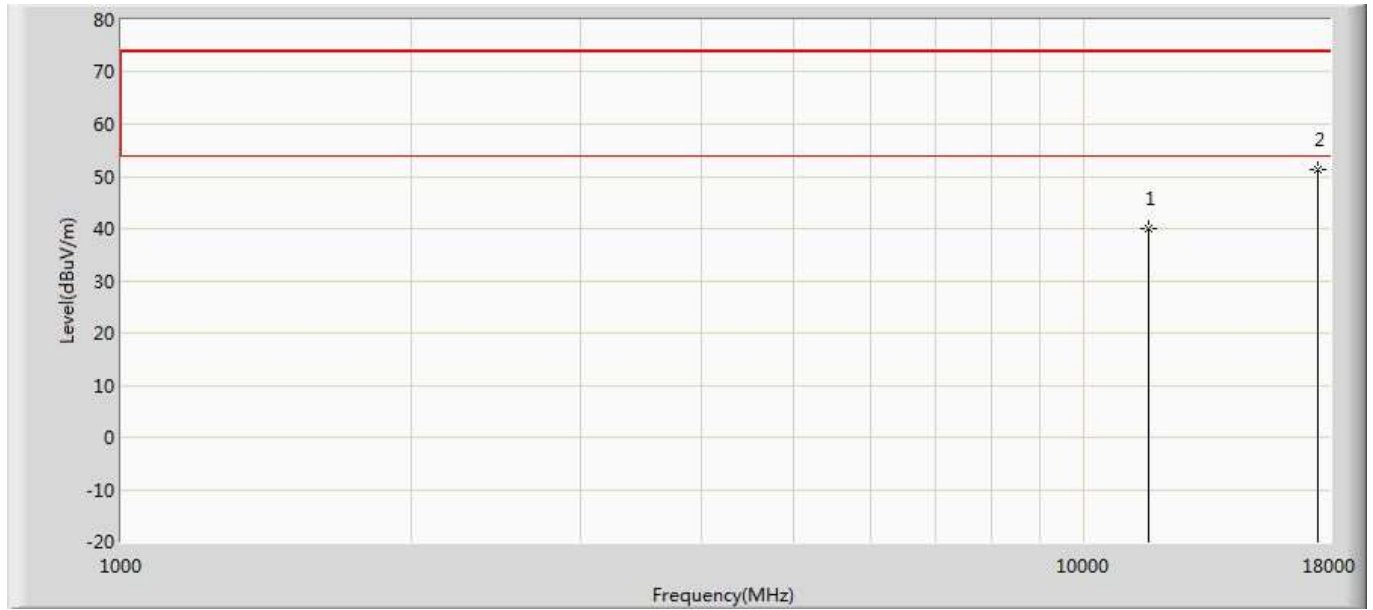

No	Mark	Frequency (MHz)	Measure Level (dBuV/m)	Reading Level (dBuV)	Over Limit (dB)	Limit (dBuV/m)	Factor (dB)	Type
1		11650.000	39.953	26.064	-34.047	74.000	13.889	PK
2	*	17475.000	51.043	29.460	-22.957	74.000	21.583	PK

Profile: 2032034R	Page No.: 45
Engineer: Neil	
Site: AC5	Time: 2020/06/18 - 20:04
Limit: FCC_Part15.209_RE(3m)	Margin: 0
Probe: Horn_3117_00167055(1-18GHz)	Polarity: Vertical
EUT: Wireless Access Point	Power: AC 120V/60Hz
Note: Mode 4:Transmit at 5825MHz by 802.11ac(20MHz)	

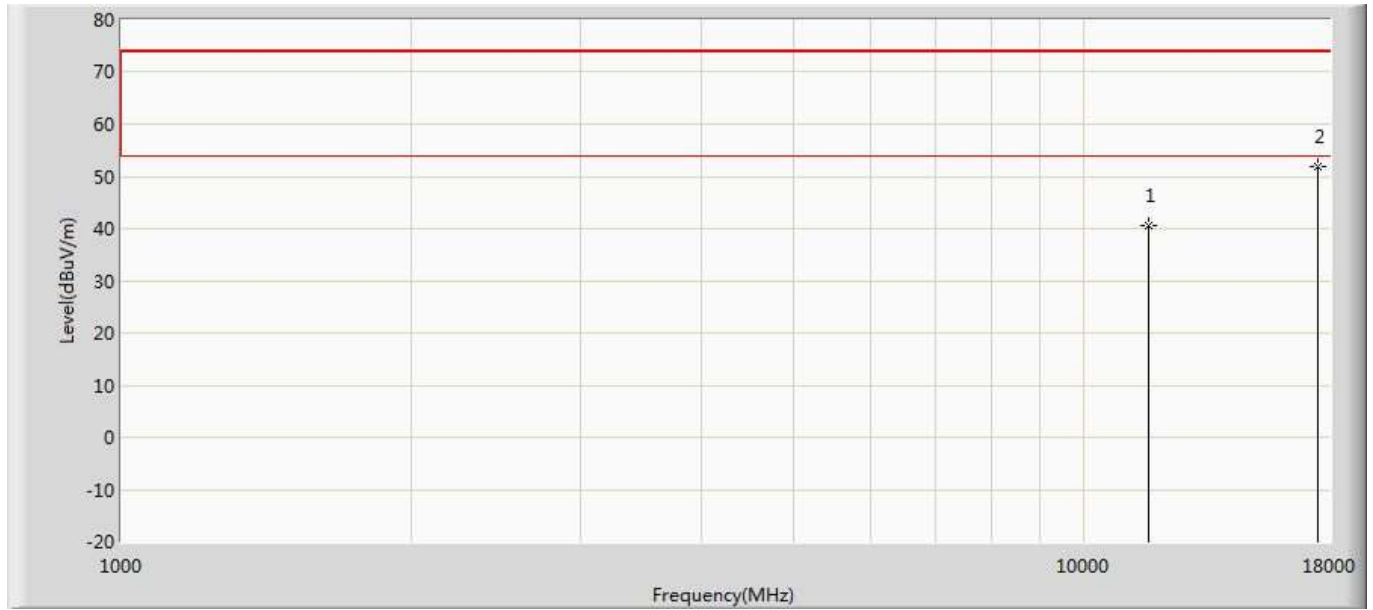

No	Mark	Frequency (MHz)	Measure Level (dBuV/m)	Reading Level (dBuV)	Over Limit (dB)	Limit (dBuV/m)	Factor (dB)	Type
1		11650.000	40.146	26.257	-33.854	74.000	13.889	PK
2	*	17475.000	51.838	30.255	-22.162	74.000	21.583	PK

Profile: 2032034R	Page No.: 50
Engineer: Neil	
Site: AC5	Time: 2020/06/18 - 20:06
Limit: FCC_Part15.209_RE(3m)	Margin: 0
Probe: Horn_3117_00167055(1-18GHz)	Polarity: Horizontal
EUT: Wireless Access Point	Power: AC 120V/60Hz
Note: Mode 5:Transmit at 5755MHz by 802.11ac(40MHz)	

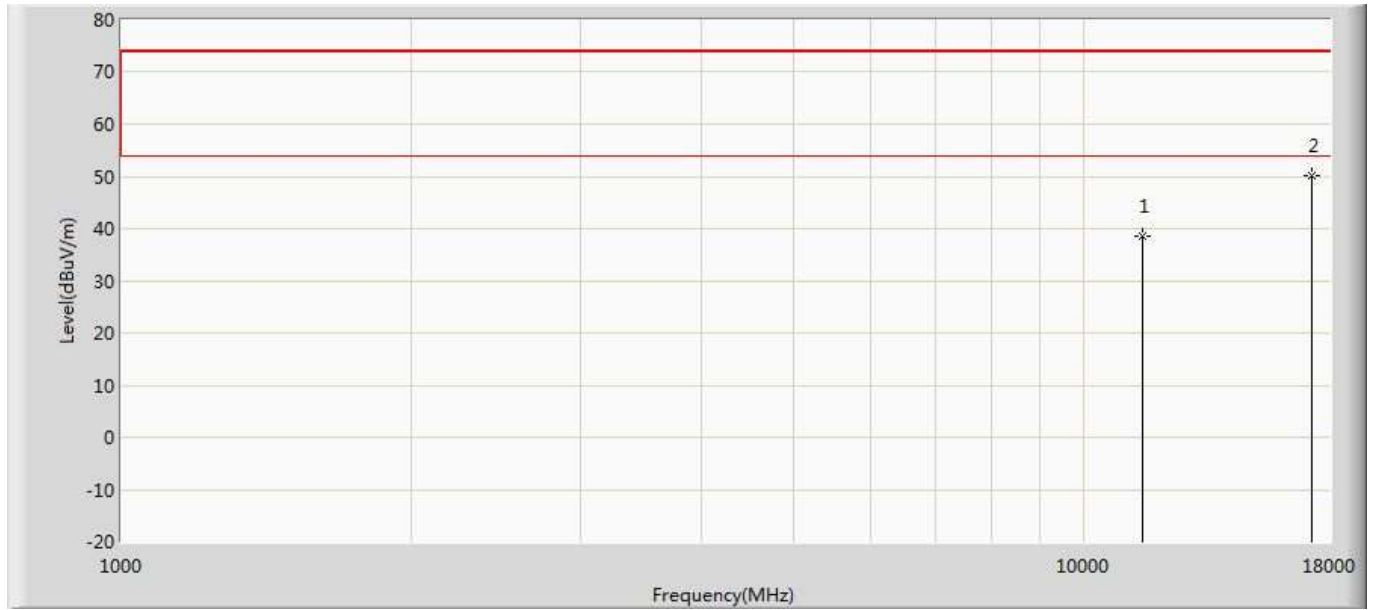

No	Mark	Frequency (MHz)	Measure Level (dBuV/m)	Reading Level (dBuV)	Over Limit (dB)	Limit (dBuV/m)	Factor (dB)	Type
1		11510.000	39.153	26.102	-34.847	74.000	13.051	PK
2	*	17265.000	51.161	30.433	-22.839	74.000	20.728	PK



Profile: 2032034R	Page No.: 51
Engineer: Neil	
Site: AC5	Time: 2020/06/18 - 20:06
Limit: FCC_Part15.209_RE(3m)	Margin: 0
Probe: Horn_3117_00167055(1-18GHz)	Polarity: Vertical
EUT: Wireless Access Point	Power: AC 120V/60Hz
Note: Mode 5:Transmit at 5755MHz by 802.11ac(40MHz)	

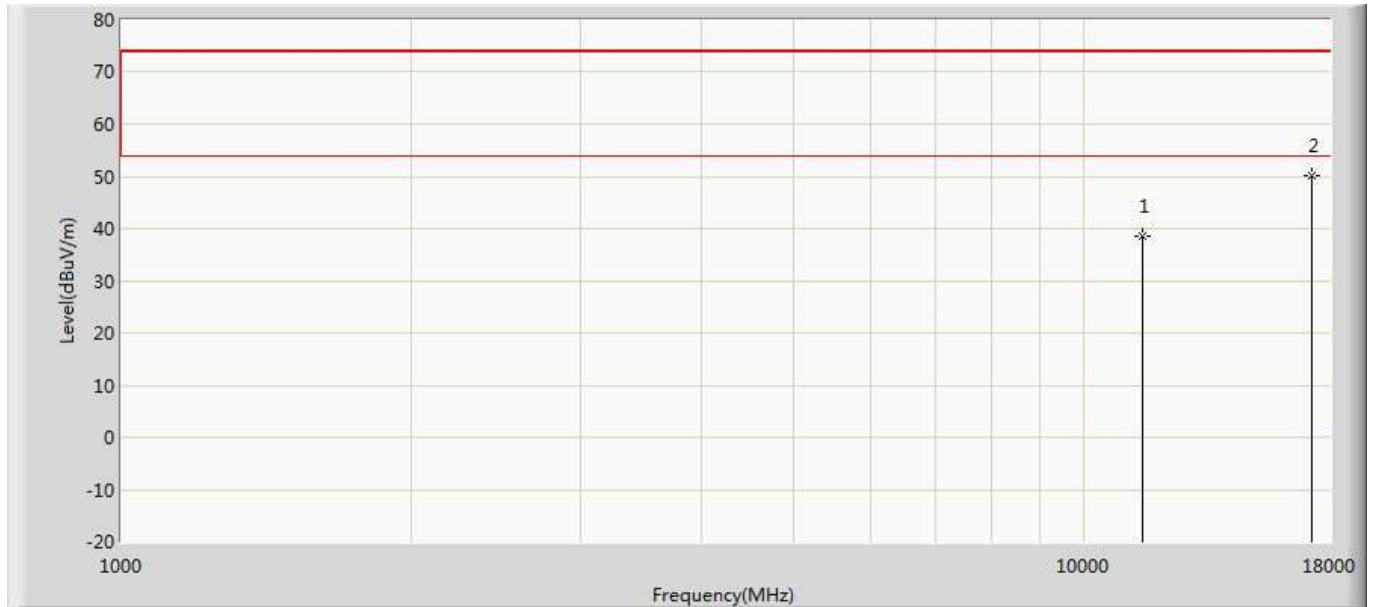

No	Mark	Frequency (MHz)	Measure Level (dBuV/m)	Reading Level (dBuV)	Over Limit (dB)	Limit (dBuV/m)	Factor (dB)	Type
1		11510.000	39.045	25.994	-34.955	74.000	13.051	PK
2	*	17265.000	51.499	30.771	-22.501	74.000	20.728	PK

Profile: 2032034R	Page No.: 52
Engineer: Neil	
Site: AC5	Time: 2020/06/18 - 20:06
Limit: FCC_Part15.209_RE(3m)	Margin: 0
Probe: Horn_3117_00167055(1-18GHz)	Polarity: Horizontal
EUT: Wireless Access Point	Power: AC 120V/60Hz
Note: Mode 5:Transmit at 5795MHz by 802.11ac(40MHz)	

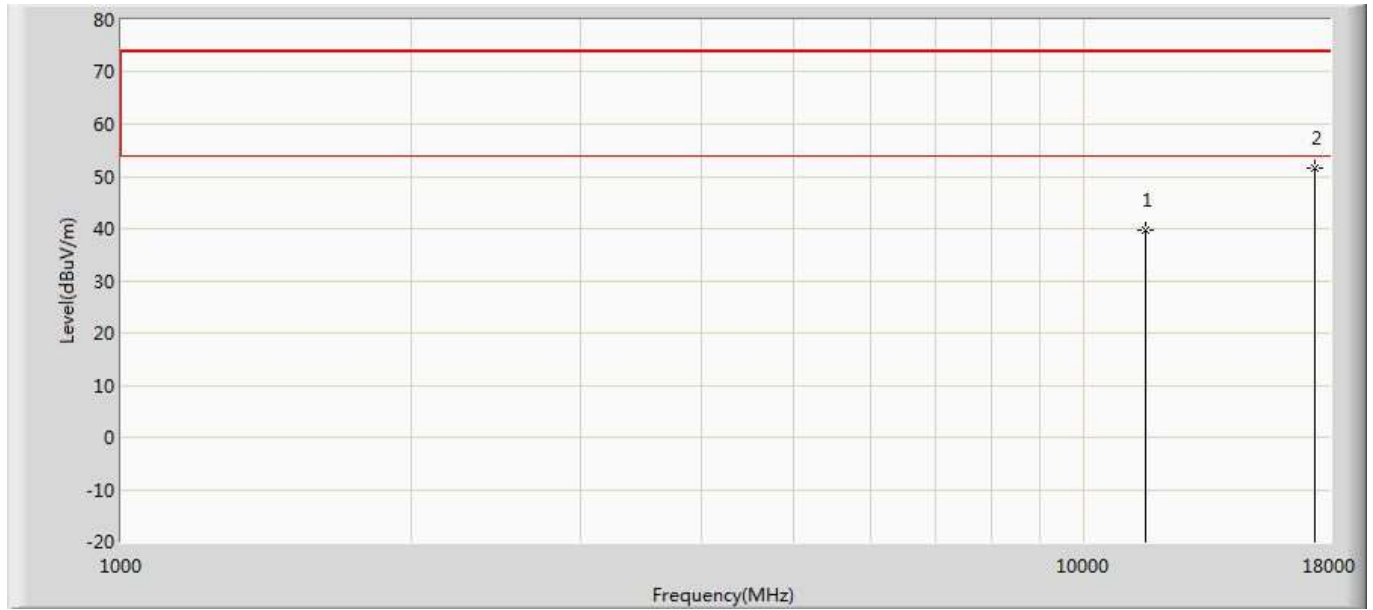

No	Mark	Frequency (MHz)	Measure Level (dBuV/m)	Reading Level (dBuV)	Over Limit (dB)	Limit (dBuV/m)	Factor (dB)	Type
1		11590.000	40.101	26.777	-33.899	74.000	13.324	PK
2	*	17385.000	51.271	29.096	-22.729	74.000	22.175	PK

Profile: 2032034R	Page No.: 53
Engineer: Neil	
Site: AC5	Time: 2020/06/18 - 20:06
Limit: FCC_Part15.209_RE(3m)	Margin: 0
Probe: Horn_3117_00167055(1-18GHz)	Polarity: Vertical
EUT: Wireless Access Point	Power: AC 120V/60Hz
Note: Mode 5:Transmit at 5795MHz by 802.11ac(40MHz)	

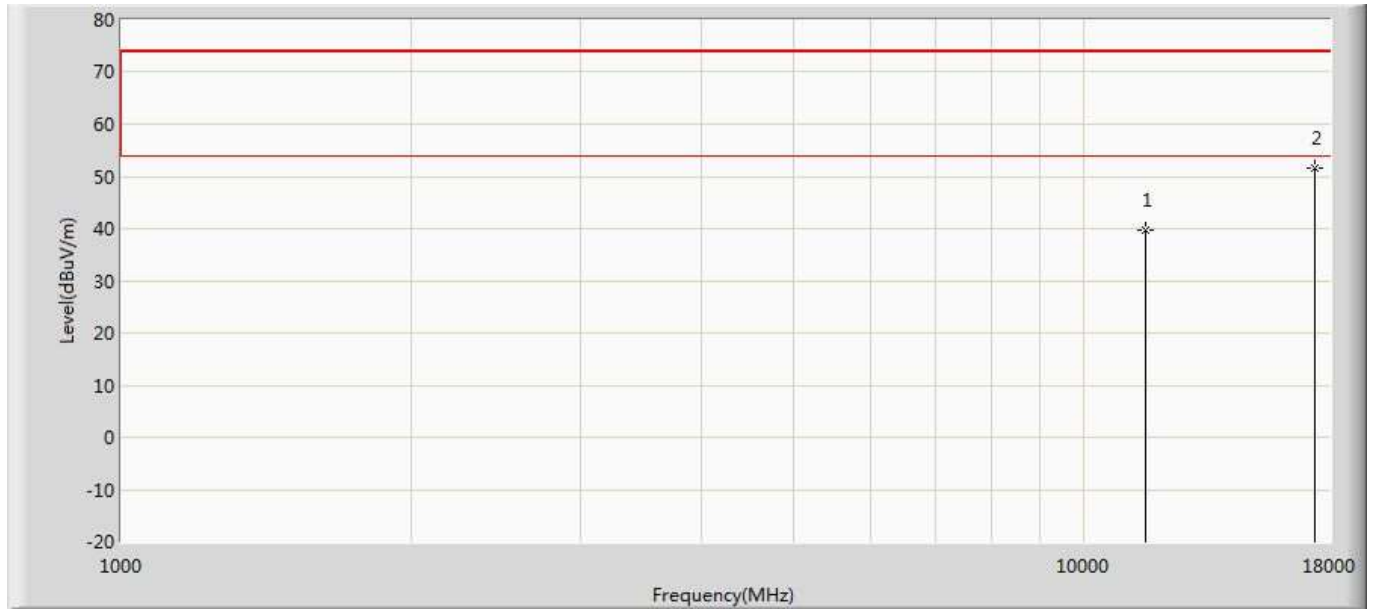

No	Mark	Frequency (MHz)	Measure Level (dBuV/m)	Reading Level (dBuV)	Over Limit (dB)	Limit (dBuV/m)	Factor (dB)	Type
1		11590.000	40.144	26.820	-33.856	74.000	13.324	PK
2	*	17385.000	51.512	29.337	-22.488	74.000	22.175	PK

Profile: 2032034R	Page No.: 162
Engineer: Neil	
Site: AC5	Time: 2020/06/18 - 20:52
Limit: FCC_Part15.209_RE(3m)	Margin: 0
Probe: Horn_3117_00167055(1-18GHz)	Polarity: Horizontal
EUT: Wireless Access Point	Power: AC 120V/60Hz
Note: Mode 6:Transmit at 5775MHz by 802.11ac(80MHz)	

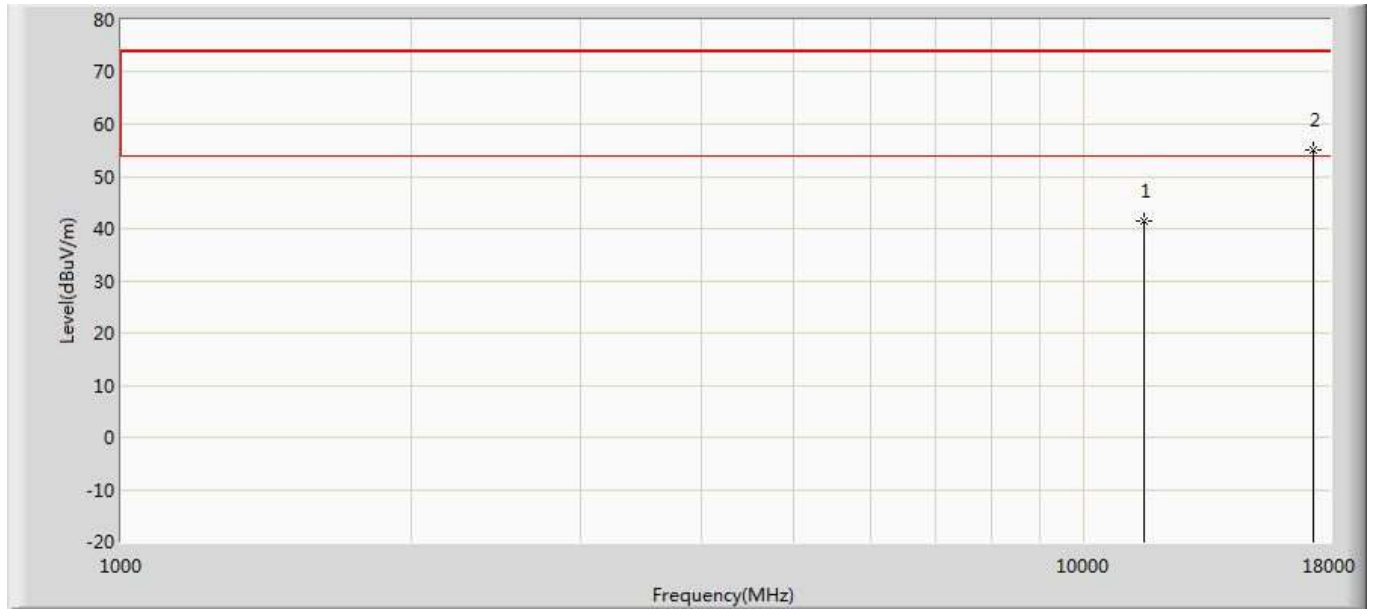

No	Mark	Frequency (MHz)	Measure Level (dBuV/m)	Reading Level (dBuV)	Over Limit (dB)	Limit (dBuV/m)	Factor (dB)	Type
1		11550.000	41.606	28.334	-32.394	74.000	13.272	PK
2	*	17325.000	53.529	31.249	-20.471	74.000	22.280	PK

Profile: 2032034R	Page No.: 163
Engineer: Neil	
Site: AC5	Time: 2020/06/18 - 20:52
Limit: FCC_Part15.209_RE(3m)	Margin: 0
Probe: Horn_3117_00167055(1-18GHz)	Polarity: Vertical
EUT: Wireless Access Point	Power: AC 120V/60Hz
Note: Mode 6:Transmit at 5775MHz by 802.11ac(80MHz)	

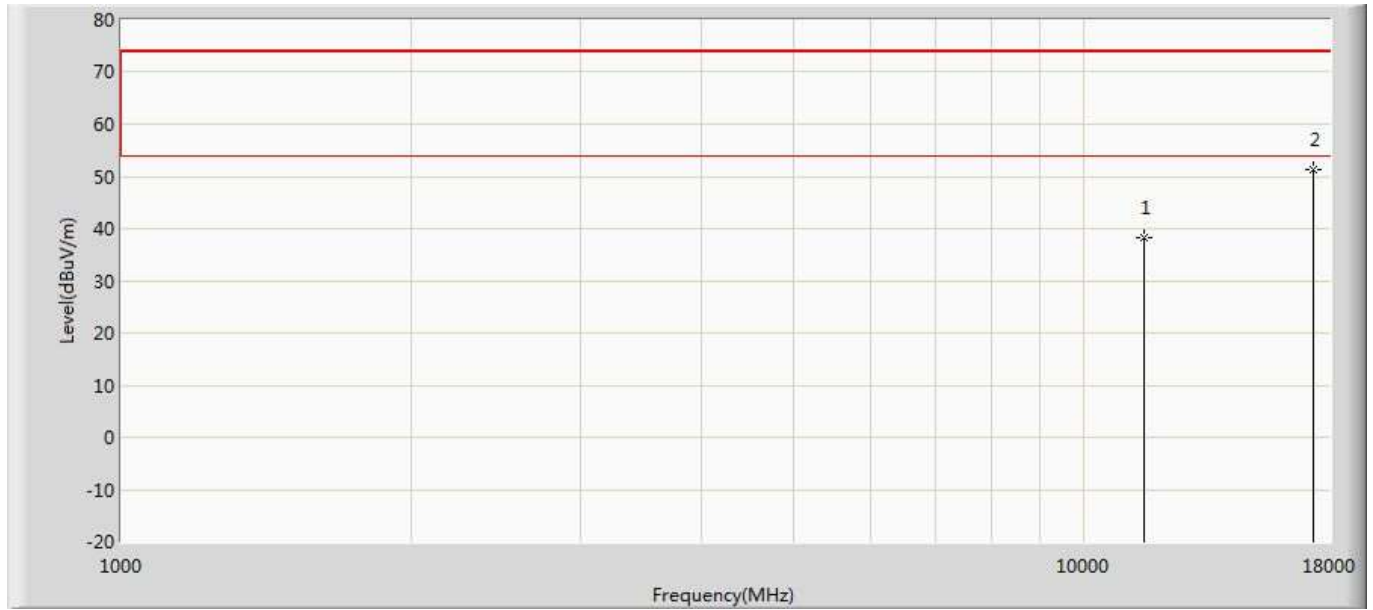

No	Mark	Frequency (MHz)	Measure Level (dBuV/m)	Reading Level (dBuV)	Over Limit (dB)	Limit (dBuV/m)	Factor (dB)	Type
1		11550.000	39.254	25.982	-34.746	74.000	13.272	PK
2	*	17325.000	51.755	29.475	-22.245	74.000	22.280	PK

Profile: 2032034R	Page No.: 64
Engineer: Neil	
Site: AC5	Time: 2020/06/18 - 20:10
Limit: FCC_Part15.209_RE(3m)	Margin: 0
Probe: Horn_3117_00167055(1-18GHz)	Polarity: Horizontal
EUT: Wireless Access Point	Power: AC 120V/60Hz
Note: Mode 7:Transmit at 5745MHz by 802.11ax(20MHz)	

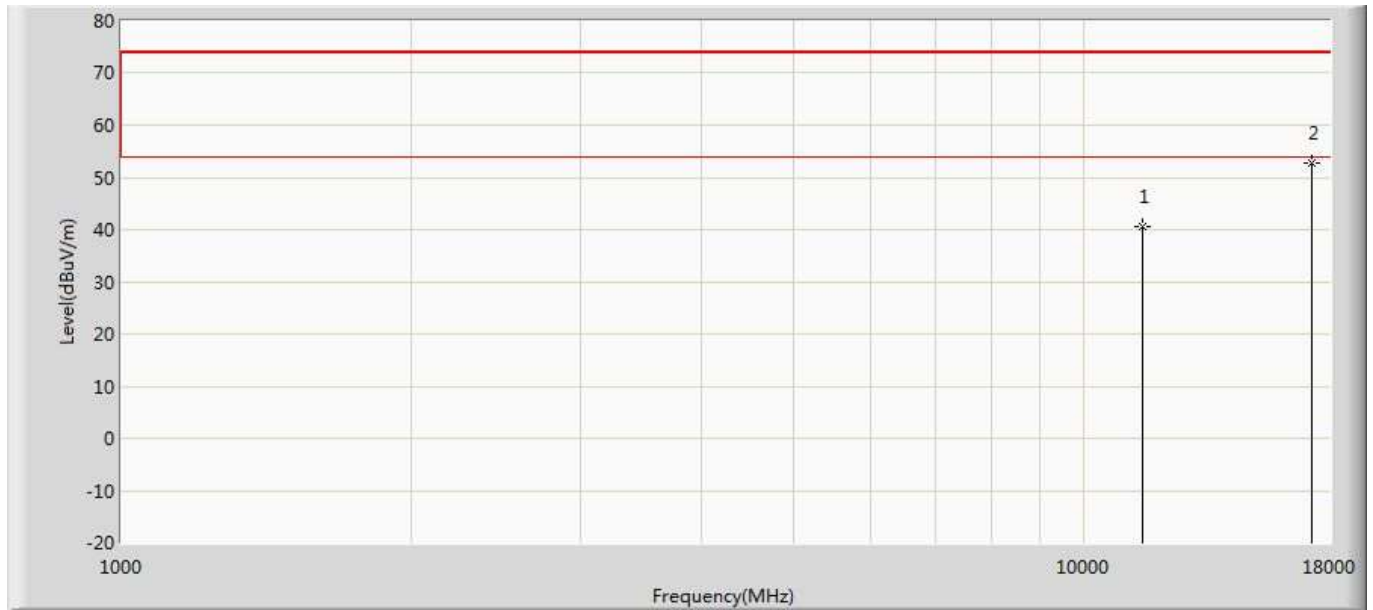

No	Mark	Frequency (MHz)	Measure Level (dBuV/m)	Reading Level (dBuV)	Over Limit (dB)	Limit (dBuV/m)	Factor (dB)	Type
1		11490.000	40.607	27.856	-33.393	74.000	12.751	PK
2	*	17235.000	51.942	31.716	-22.058	74.000	20.226	PK

Profile: 2032034R	Page No.: 65
Engineer: Neil	
Site: AC5	Time: 2020/06/18 - 20:10
Limit: FCC_Part15.209_RE(3m)	Margin: 0
Probe: Horn_3117_00167055(1-18GHz)	Polarity: Vertical
EUT: Wireless Access Point	Power: AC 120V/60Hz
Note: Mode 7:Transmit at 5745MHz by 802.11ax(20MHz)	

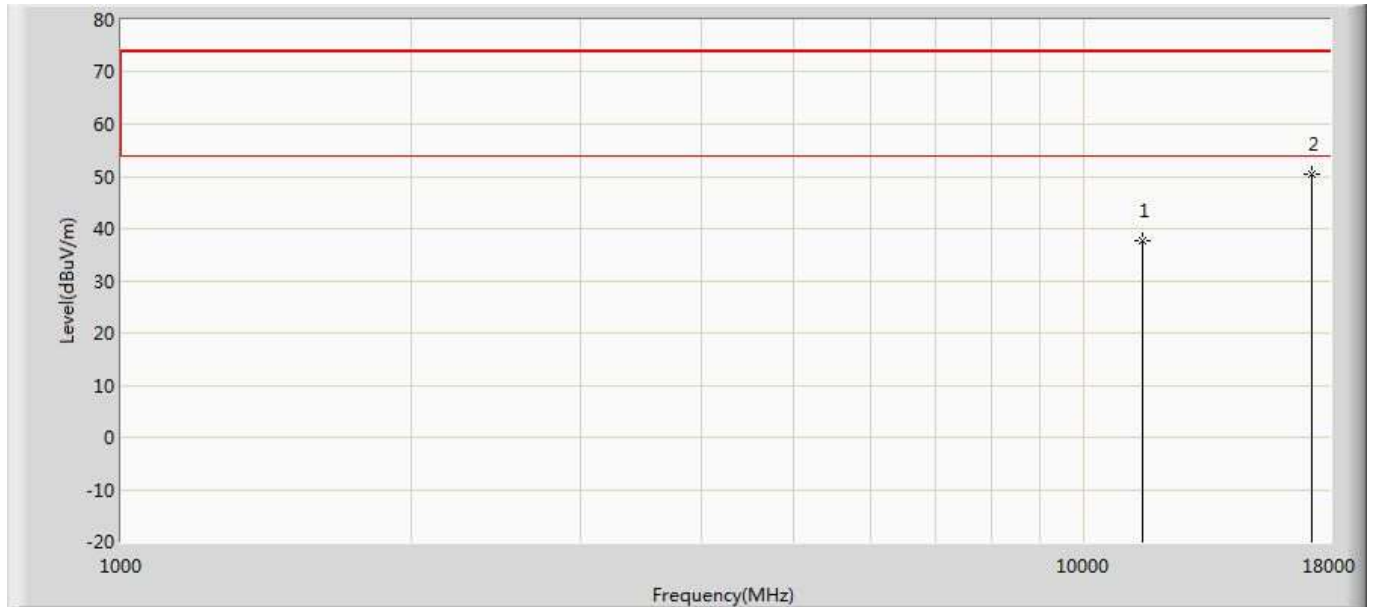

No	Mark	Frequency (MHz)	Measure Level (dBuV/m)	Reading Level (dBuV)	Over Limit (dB)	Limit (dBuV/m)	Factor (dB)	Type
1		11490.000	37.782	25.031	-36.218	74.000	12.751	PK
2	*	17235.000	50.236	30.010	-23.764	74.000	20.226	PK

Profile: 2032034R	Page No.: 66
Engineer: Neil	
Site: AC5	Time: 2020/06/18 - 20:10
Limit: FCC_Part15.209_RE(3m)	Margin: 0
Probe: Horn_3117_00167055(1-18GHz)	Polarity: Horizontal
EUT: Wireless Access Point	Power: AC 120V/60Hz
Note: Mode 7:Transmit at 5785MHz by 802.11ax(20MHz)	

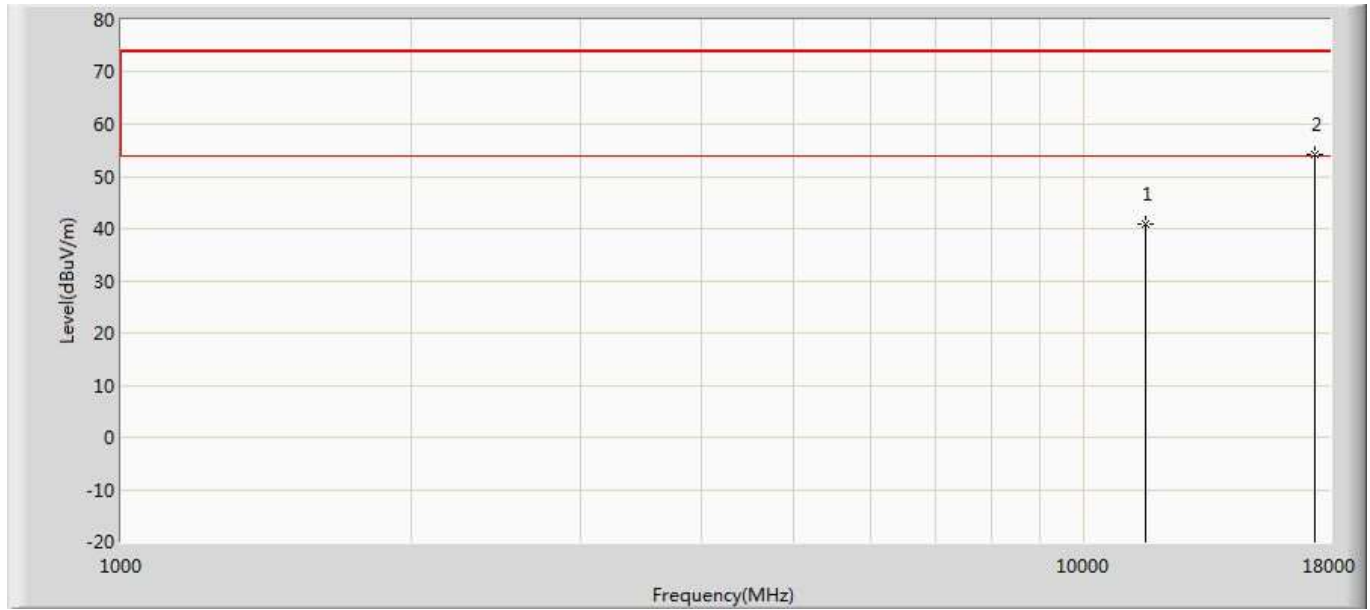

No	Mark	Frequency (MHz)	Measure Level (dBuV/m)	Reading Level (dBuV)	Over Limit (dB)	Limit (dBuV/m)	Factor (dB)	Type
1		11570.000	41.690	28.534	-32.310	74.000	13.156	PK
2	*	17355.000	53.223	30.225	-20.777	74.000	22.998	PK



Profile: 2032034R	Page No.: 67
Engineer: Neil	
Site: AC5	Time: 2020/06/18 - 20:11
Limit: FCC_Part15.209_RE(3m)	Margin: 0
Probe: Horn_3117_00167055(1-18GHz)	Polarity: Vertical
EUT: Wireless Access Point	Power: AC 120V/60Hz
Note: Mode 7:Transmit at 5785MHz by 802.11ax(20MHz)	

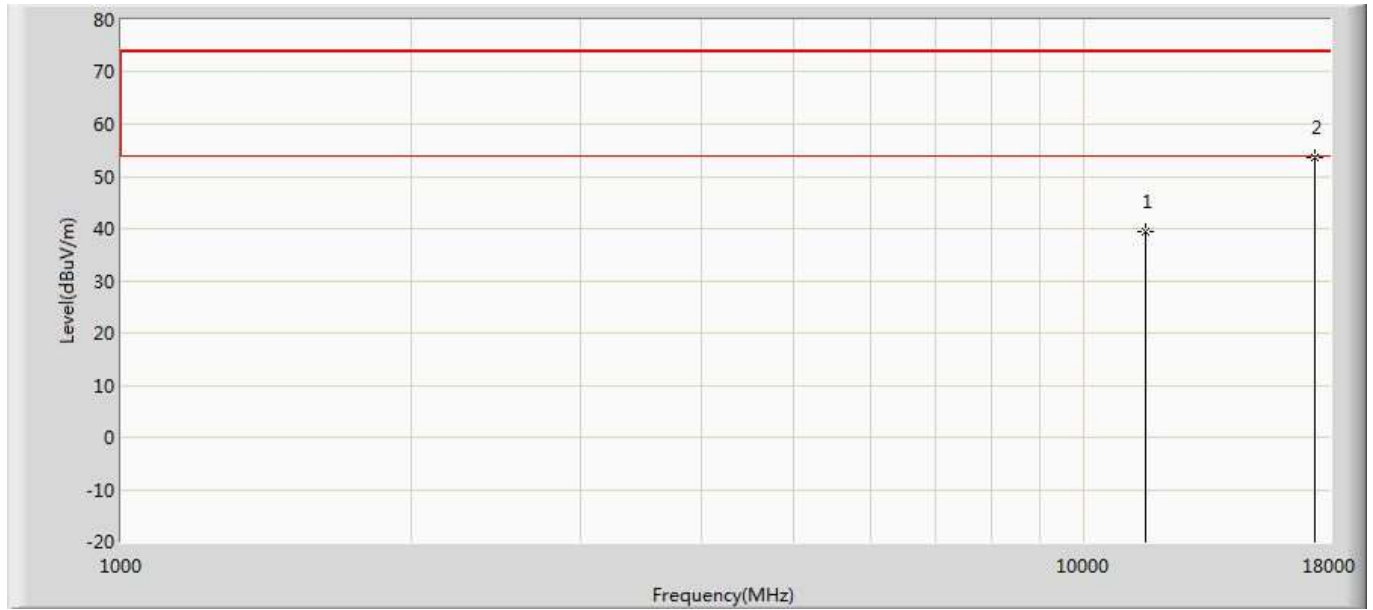

No	Mark	Frequency (MHz)	Measure Level (dBuV/m)	Reading Level (dBuV)	Over Limit (dB)	Limit (dBuV/m)	Factor (dB)	Type
1		11570.000	39.129	25.973	-34.871	74.000	13.156	PK
2	*	17355.000	53.124	30.126	-20.876	74.000	22.998	PK

Profile: 2032034R	Page No.: 68
Engineer: Neil	
Site: AC5	Time: 2020/06/18 - 20:11
Limit: FCC_Part15.209_RE(3m)	Margin: 0
Probe: Horn_3117_00167055(1-18GHz)	Polarity: Horizontal
EUT: Wireless Access Point	Power: AC 120V/60Hz
Note: Mode 7:Transmit at 5825MHz by 802.11ax(20MHz)	

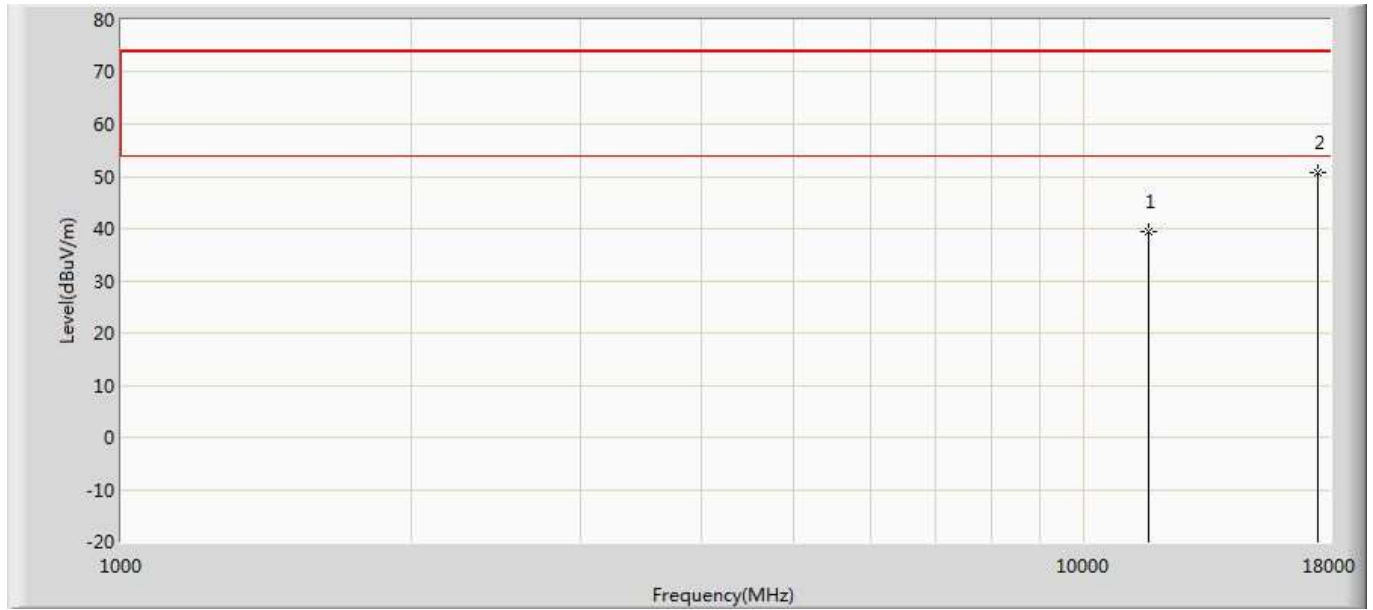

No	Mark	Frequency (MHz)	Measure Level (dBuV/m)	Reading Level (dBuV)	Over Limit (dB)	Limit (dBuV/m)	Factor (dB)	Type
1		11650.000	39.728	25.839	-34.272	74.000	13.889	PK
2	*	17475.000	50.858	29.275	-23.142	74.000	21.583	PK

Profile: 2032034R	Page No.: 69
Engineer: Neil	
Site: AC5	Time: 2020/06/18 - 20:12
Limit: FCC_Part15.209_RE(3m)	Margin: 0
Probe: Horn_3117_00167055(1-18GHz)	Polarity: Vertical
EUT: Wireless Access Point	Power: AC 120V/60Hz
Note: Mode 7: Transmit at 5825MHz by 802.11ax(20MHz)	

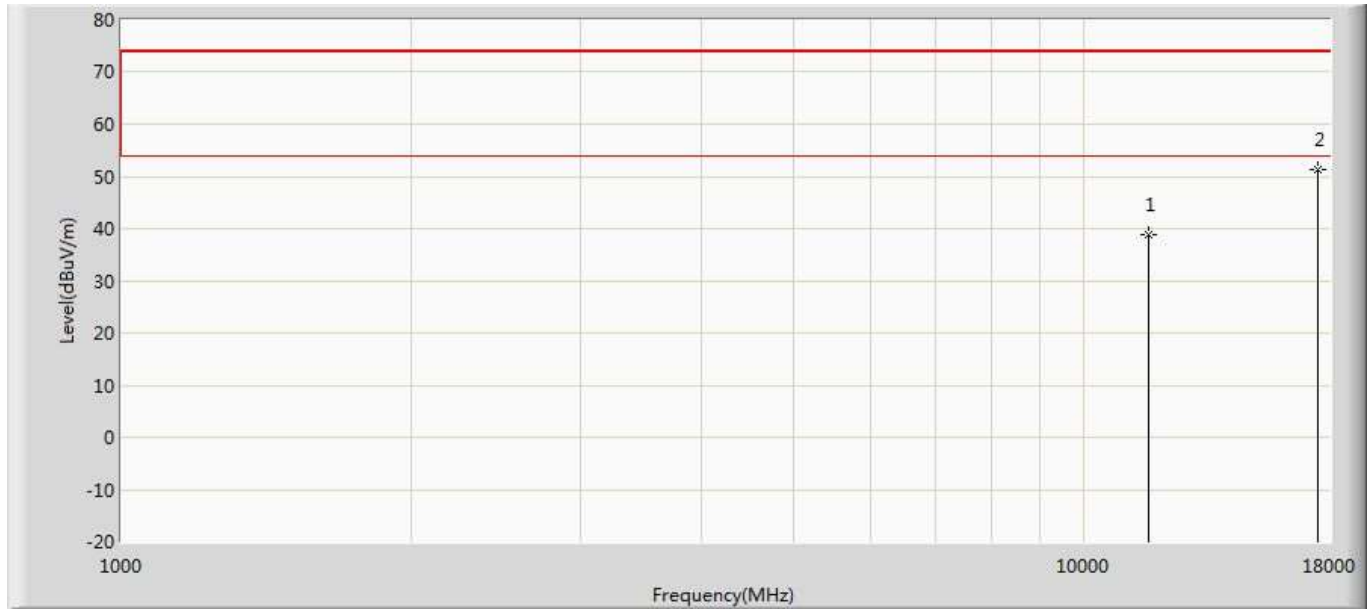

No	Mark	Frequency (MHz)	Measure Level (dBuV/m)	Reading Level (dBuV)	Over Limit (dB)	Limit (dBuV/m)	Factor (dB)	Type
1		11650.000	39.423	25.534	-34.577	74.000	13.889	PK
2	*	17475.000	50.897	29.314	-23.103	74.000	21.583	PK

Profile: 2032034R	Page No.: 74
Engineer: Neil	
Site: AC5	Time: 2020/06/18 - 20:13
Limit: FCC_Part15.209_RE(3m)	Margin: 0
Probe: Horn_3117_00167055(1-18GHz)	Polarity: Horizontal
EUT: Wireless Access Point	Power: AC 120V/60Hz
Note: Mode 8:Transmit at 5755MHz by 802.11ax(40MHz)	

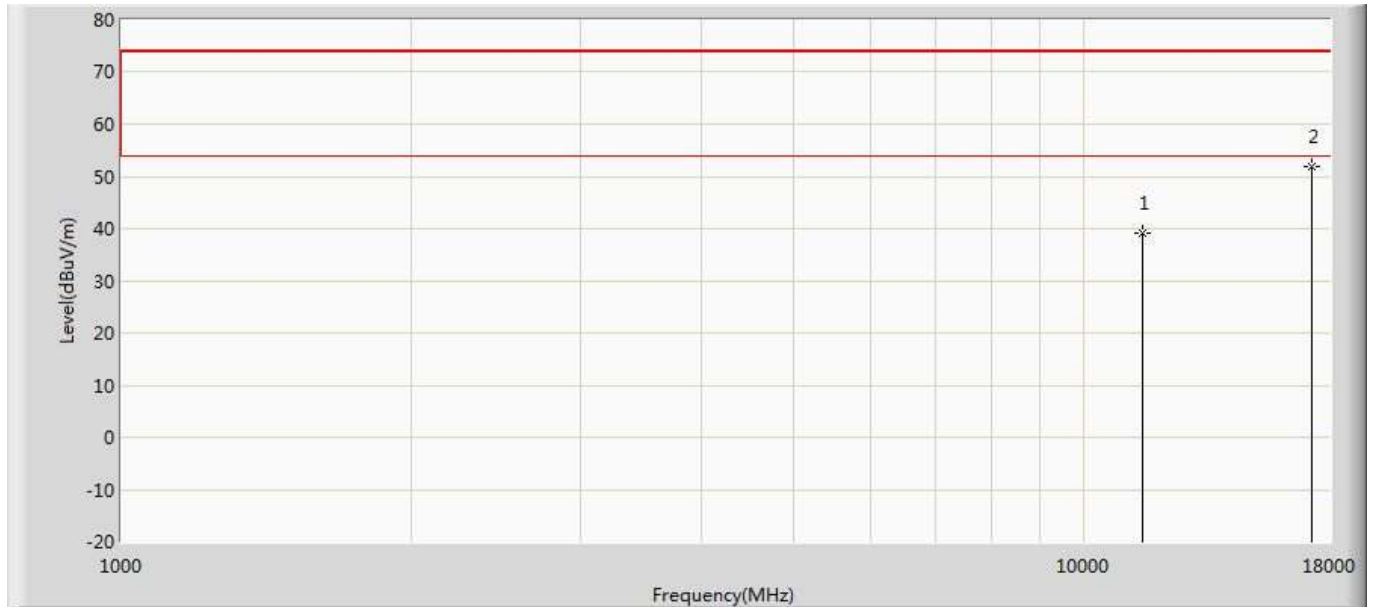

No	Mark	Frequency (MHz)	Measure Level (dBuV/m)	Reading Level (dBuV)	Over Limit (dB)	Limit (dBuV/m)	Factor (dB)	Type
1		11510.000	39.807	26.756	-34.193	74.000	13.051	PK
2	*	17265.000	51.931	31.203	-22.069	74.000	20.728	PK

Profile: 2032034R	Page No.: 75
Engineer: Neil	
Site: AC5	Time: 2020/06/18 - 20:14
Limit: FCC_Part15.209_RE(3m)	Margin: 0
Probe: Horn_3117_00167055(1-18GHz)	Polarity: Vertical
EUT: Wireless Access Point	Power: AC 120V/60Hz
Note: Mode 8:Transmit at 5755MHz by 802.11ax(40MHz)	

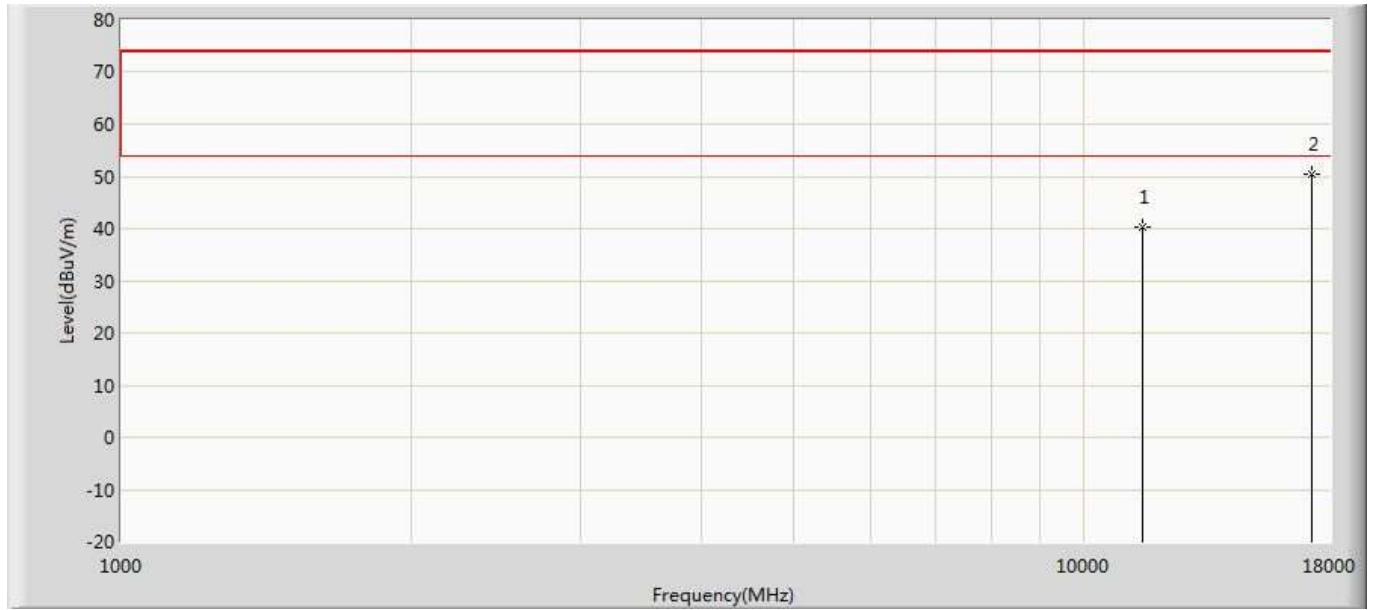

No	Mark	Frequency (MHz)	Measure Level (dBuV/m)	Reading Level (dBuV)	Over Limit (dB)	Limit (dBuV/m)	Factor (dB)	Type
1		11510.000	39.059	26.008	-34.941	74.000	13.051	PK
2	*	17265.000	52.035	31.307	-21.965	74.000	20.728	PK

Profile: 2032034R	Page No.: 76
Engineer: Neil	
Site: AC5	Time: 2020/06/18 - 20:14
Limit: FCC_Part15.209_RE(3m)	Margin: 0
Probe: Horn_3117_00167055(1-18GHz)	Polarity: Horizontal
EUT: Wireless Access Point	Power: AC 120V/60Hz
Note: Mode 8:Transmit at 5795MHz by 802.11ax(40MHz)	

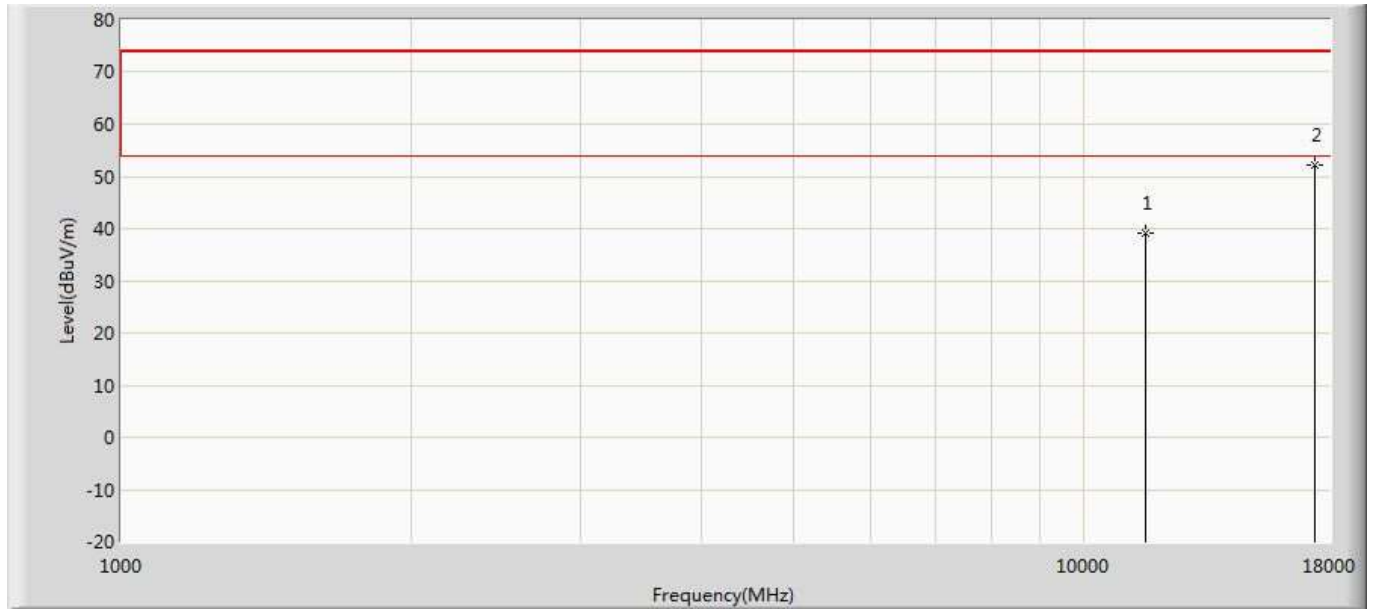

No	Mark	Frequency (MHz)	Measure Level (dBuV/m)	Reading Level (dBuV)	Over Limit (dB)	Limit (dBuV/m)	Factor (dB)	Type
1		11590.000	38.821	25.497	-35.179	74.000	13.324	PK
2	*	17385.000	52.721	30.546	-21.279	74.000	22.175	PK

Profile: 2032034R	Page No.: 77
Engineer: Neil	
Site: AC5	Time: 2020/06/18 - 20:14
Limit: FCC_Part15.209_RE(3m)	Margin: 0
Probe: Horn_3117_00167055(1-18GHz)	Polarity: Vertical
EUT: Wireless Access Point	Power: AC 120V/60Hz
Note: Mode 8:Transmit at 5795MHz by 802.11ax(40MHz)	

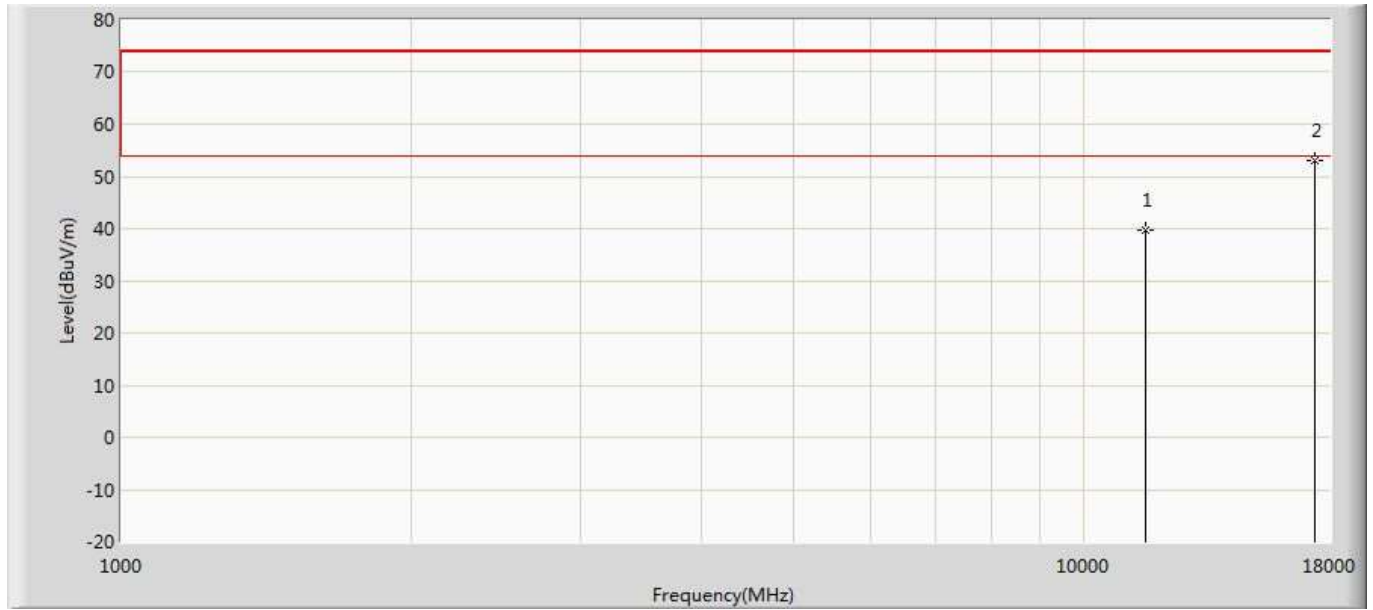

No	Mark	Frequency (MHz)	Measure Level (dBuV/m)	Reading Level (dBuV)	Over Limit (dB)	Limit (dBuV/m)	Factor (dB)	Type
1		11590.000	40.033	26.709	-33.967	74.000	13.324	PK
2	*	17385.000	54.032	31.857	-19.968	74.000	22.175	PK

Profile: 2032034R	Page No.: 166
Engineer: Neil	
Site: AC5	Time: 2020/06/18 - 20:53
Limit: FCC_Part15.209_RE(3m)	Margin: 0
Probe: Horn_3117_00167055(1-18GHz)	Polarity: Horizontal
EUT: Wireless Access Point	Power: AC 120V/60Hz
Note: Mode 9:Transmit at 5775MHz by 802.11ax(80MHz)	

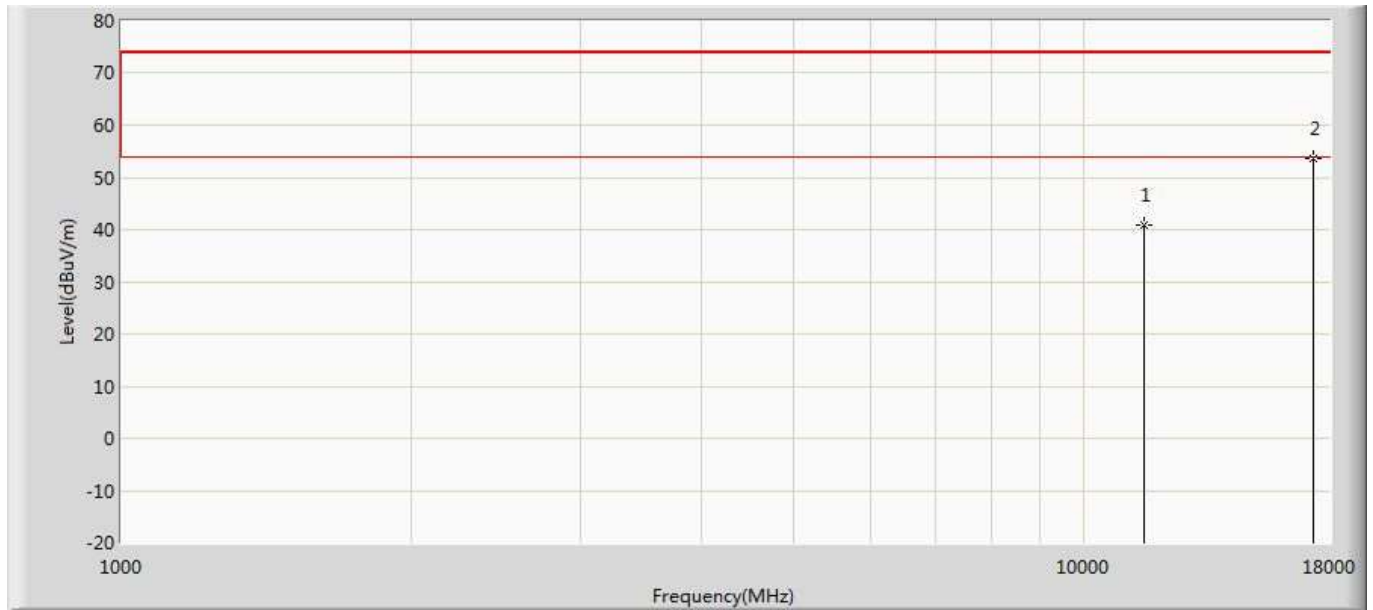

No	Mark	Frequency (MHz)	Measure Level (dBuV/m)	Reading Level (dBuV)	Over Limit (dB)	Limit (dBuV/m)	Factor (dB)	Type
1		11550.000	41.031	27.759	-32.969	74.000	13.272	PK
2	*	17325.000	53.937	31.657	-20.063	74.000	22.280	PK



Profile: 2032034R	Page No.: 167
Engineer: Neil	
Site: AC5	Time: 2020/06/18 - 20:54
Limit: FCC_Part15.209_RE(3m)	Margin: 0
Probe: Horn_3117_00167055(1-18GHz)	Polarity: Vertical
EUT: Wireless Access Point	Power: AC 120V/60Hz
Note: Mode 9:Transmit at 5775MHz by 802.11ax(80MHz)	

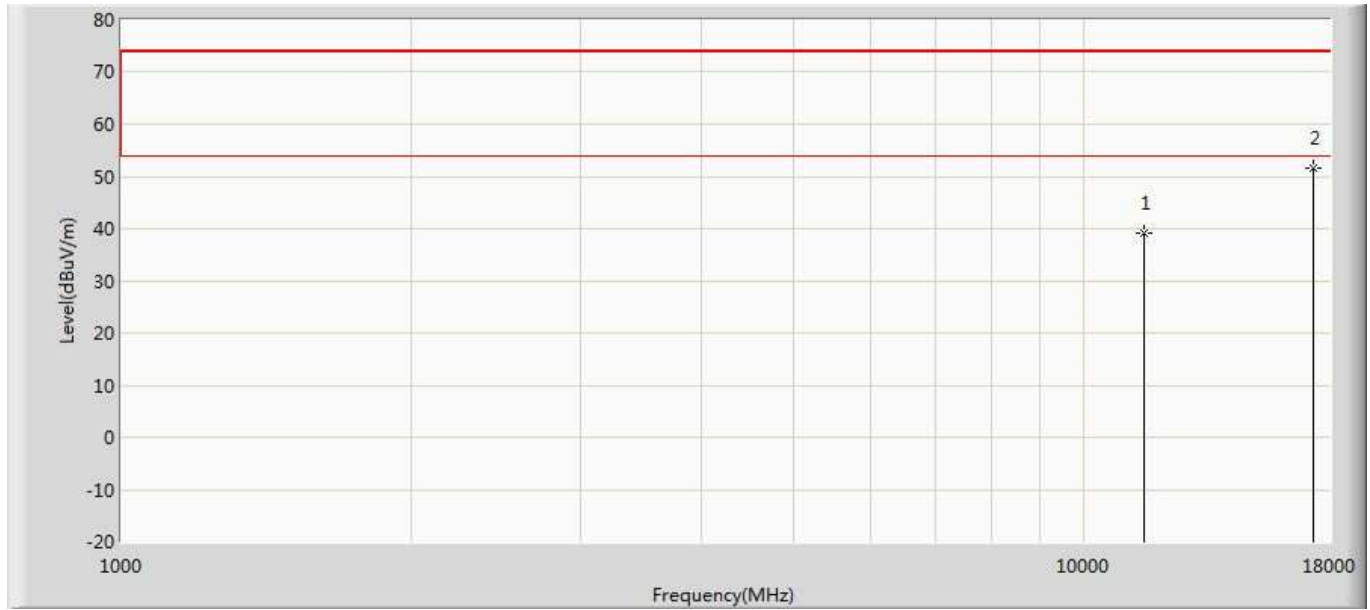

No	Mark	Frequency (MHz)	Measure Level (dBuV/m)	Reading Level (dBuV)	Over Limit (dB)	Limit (dBuV/m)	Factor (dB)	Type
1		11550.000	39.481	26.209	-34.519	74.000	13.272	PK
2	*	17325.000	52.743	30.463	-21.257	74.000	22.280	PK

### Radio3-5G high band mode-4\*4 CDD

Profile: 2032034R	Page No.: 2
Engineer: Neil	
Site: AC5	Time: 2020/06/19 - 02:28
Limit: FCC_Part15.209_RE(3m)	Margin: 0
Probe: Horn_3117_00167055(1-18GHz)	Polarity: Horizontal
EUT: Wireless Access Point	Power: AC 120V/60Hz
Note: Mode 1:Transmit at 5745MHz by 802.11a	

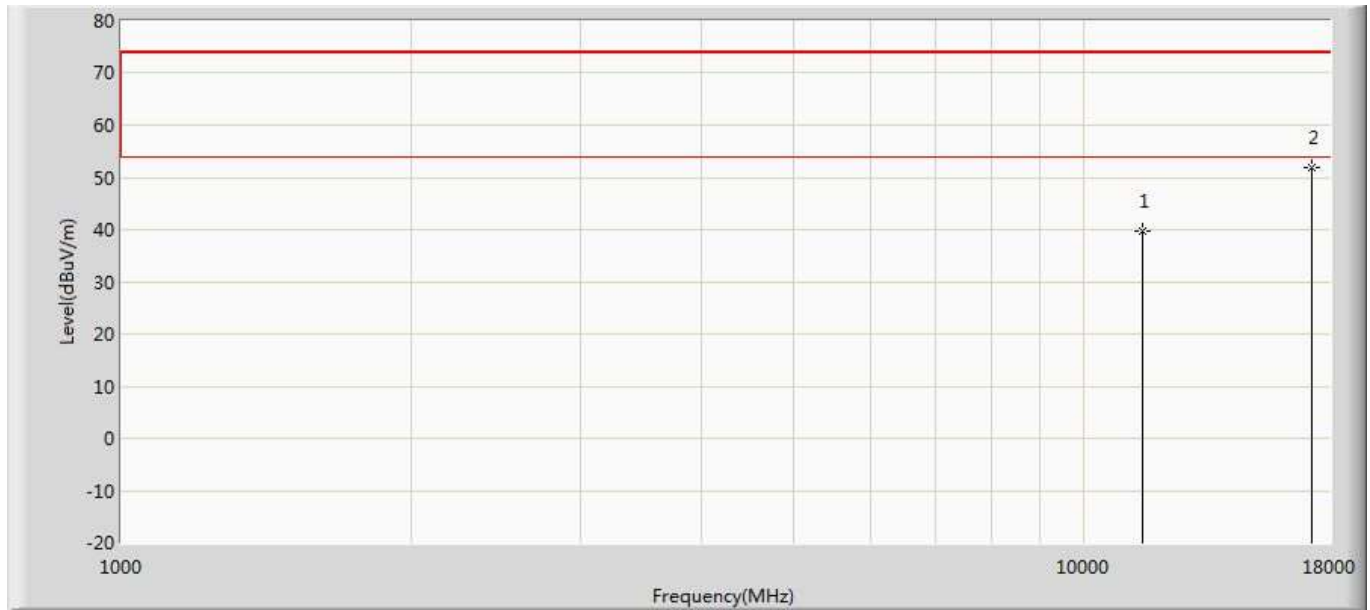

No	Mark	Frequency (MHz)	Measure Level (dBuV/m)	Reading Level (dBuV)	Over Limit (dB)	Limit (dBuV/m)	Factor (dB)	Type
1		11490.000	39.627	26.877	-34.373	74.000	12.751	PK
2	*	17235.000	51.991	31.765	-22.009	74.000	20.226	PK

Profile: 2032034R	Page No.: 3
Engineer: Neil	
Site: AC5	Time: 2020/06/19 - 02:28
Limit: FCC_Part15.209_RE(3m)	Margin: 0
Probe: Horn_3117_00167055(1-18GHz)	Polarity: Vertical
EUT: Wireless Access Point	Power: AC 120V/60Hz
Note: Mode 1:Transmit at 5745MHz by 802.11a	

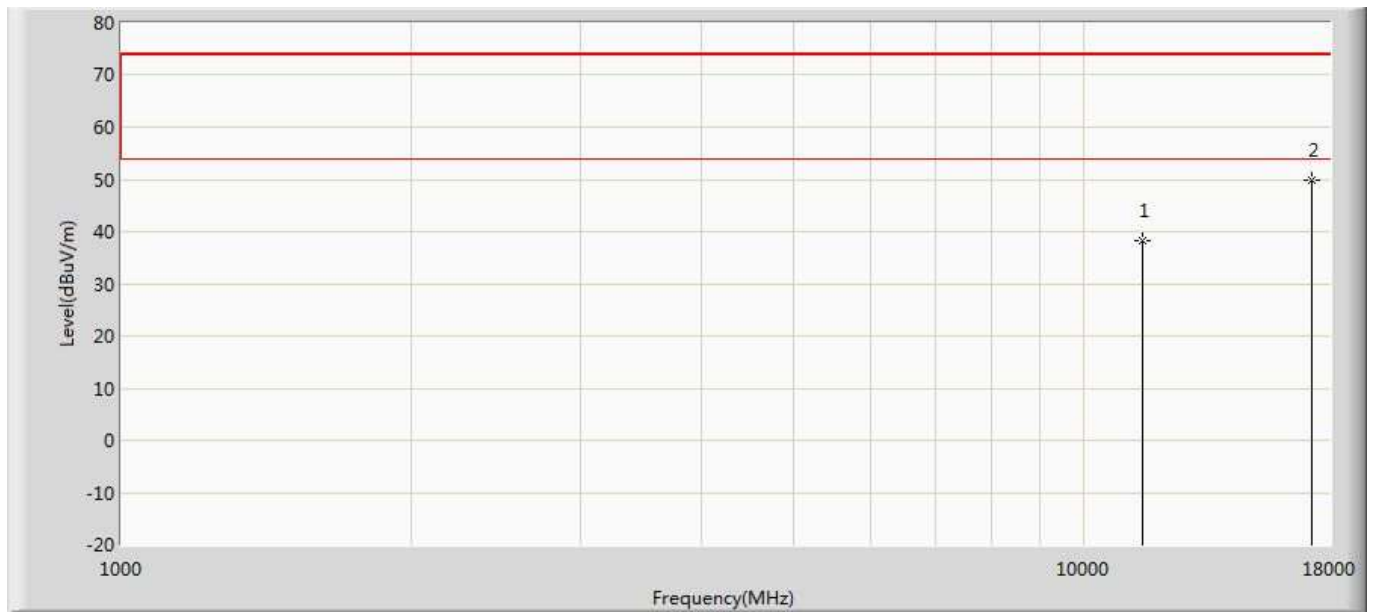

No	Mark	Frequency (MHz)	Measure Level (dBuV/m)	Reading Level (dBuV)	Over Limit (dB)	Limit (dBuV/m)	Factor (dB)	Type
1		11490.000	38.237	25.487	-35.763	74.000	12.751	PK
2	*	17235.000	49.904	29.678	-24.096	74.000	20.226	PK

Profile: 2032034R	Page No.: 4
Engineer: Neil	
Site: AC5	Time: 2020/06/19 - 02:28
Limit: FCC_Part15.209_RE(3m)	Margin: 0
Probe: Horn_3117_00167055(1-18GHz)	Polarity: Horizontal
EUT: Wireless Access Point	Power: AC 120V/60Hz
Note: Mode 1:Transmit at 5785MHz by 802.11a	

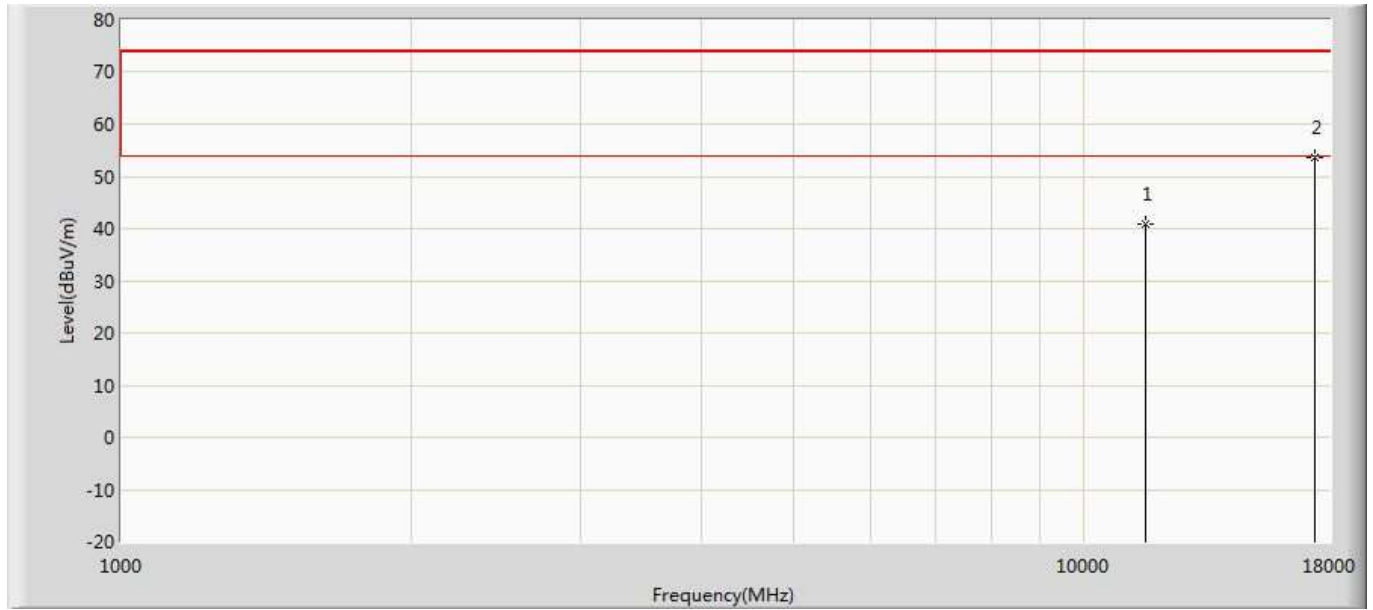

No	Mark	Frequency (MHz)	Measure Level (dBuV/m)	Reading Level (dBuV)	Over Limit (dB)	Limit (dBuV/m)	Factor (dB)	Type
1		11570.000	40.977	27.821	-33.023	74.000	13.156	PK
2	*	17355.000	53.708	30.709	-20.292	74.000	22.998	PK

Profile: 2032034R	Page No.: 5
Engineer: Neil	
Site: AC5	Time: 2020/06/19 - 02:29
Limit: FCC_Part15.209_RE(3m)	Margin: 0
Probe: Horn_3117_00167055(1-18GHz)	Polarity: Vertical
EUT: Wireless Access Point	Power: AC 120V/60Hz
Note: Mode 1:Transmit at 5785MHz by 802.11a	

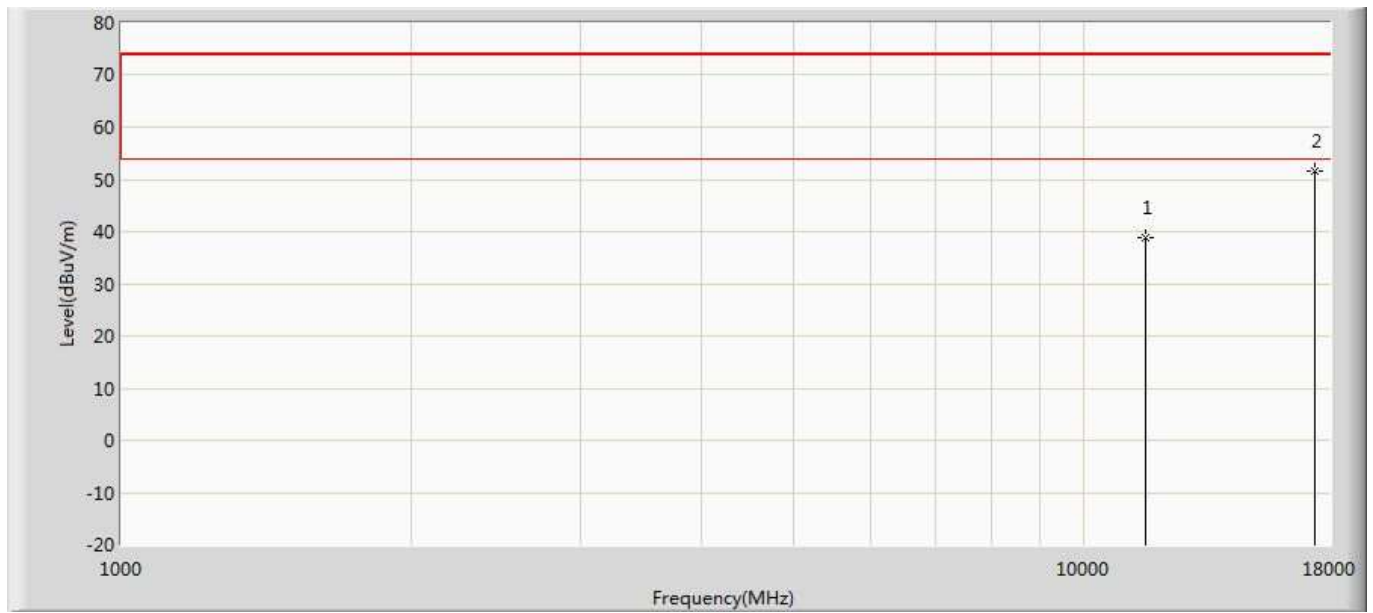

No	Mark	Frequency (MHz)	Measure Level (dBuV/m)	Reading Level (dBuV)	Over Limit (dB)	Limit (dBuV/m)	Factor (dB)	Type
1		11570.000	38.888	25.732	-35.112	74.000	13.156	PK
2	*	17355.000	51.712	28.713	-22.288	74.000	22.998	PK

Profile: 2032034R	Page No.: 6
Engineer: Neil	
Site: AC5	Time: 2020/06/19 - 02:29
Limit: FCC_Part15.209_RE(3m)	Margin: 0
Probe: Horn_3117_00167055(1-18GHz)	Polarity: Horizontal
EUT: Wireless Access Point	Power: AC 120V/60Hz
Note: Mode 1:Transmit at 5825MHz by 802.11a	

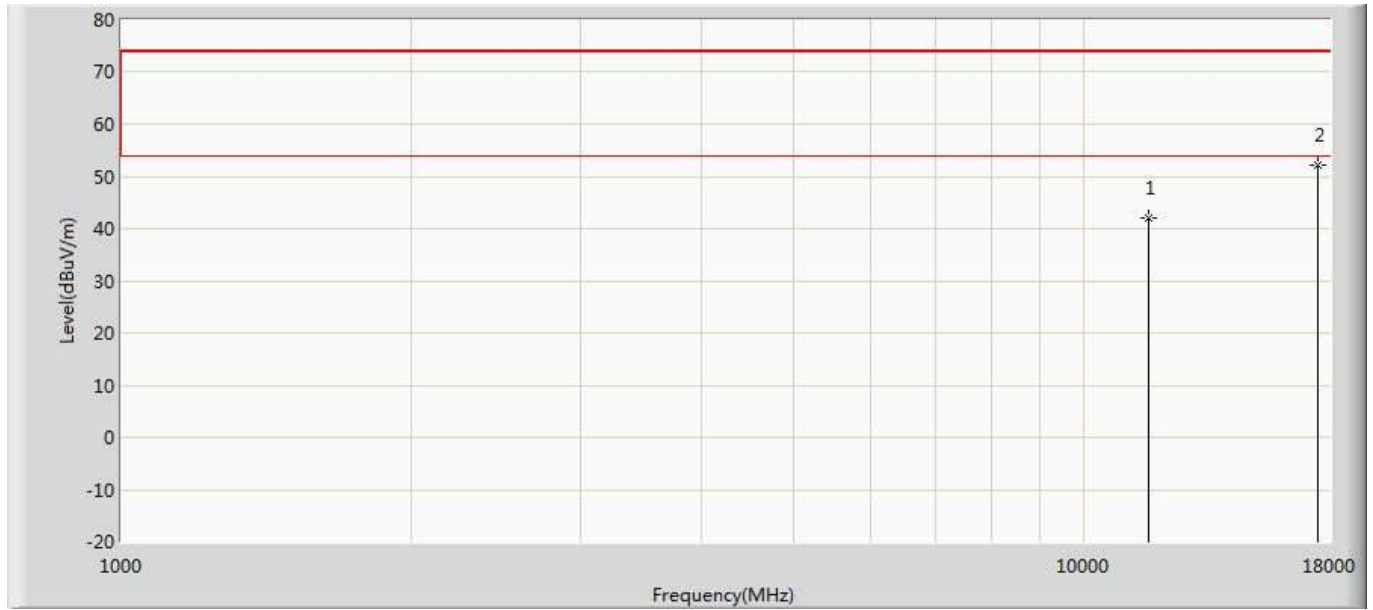

No	Mark	Frequency (MHz)	Measure Level (dBuV/m)	Reading Level (dBuV)	Over Limit (dB)	Limit (dBuV/m)	Factor (dB)	Type
1		11650.000	42.142	28.252	-31.858	74.000	13.889	PK
2	*	17475.000	52.101	30.518	-21.899	74.000	21.583	PK

Profile: 2032034R	Page No.: 7
Engineer: Neil	
Site: AC5	Time: 2020/06/19 - 02:29
Limit: FCC_Part15.209_RE(3m)	Margin: 0
Probe: Horn_3117_00167055(1-18GHz)	Polarity: Vertical
EUT: Wireless Access Point	Power: AC 120V/60Hz
Note: Mode 1:Transmit at 5825MHz by 802.11a	

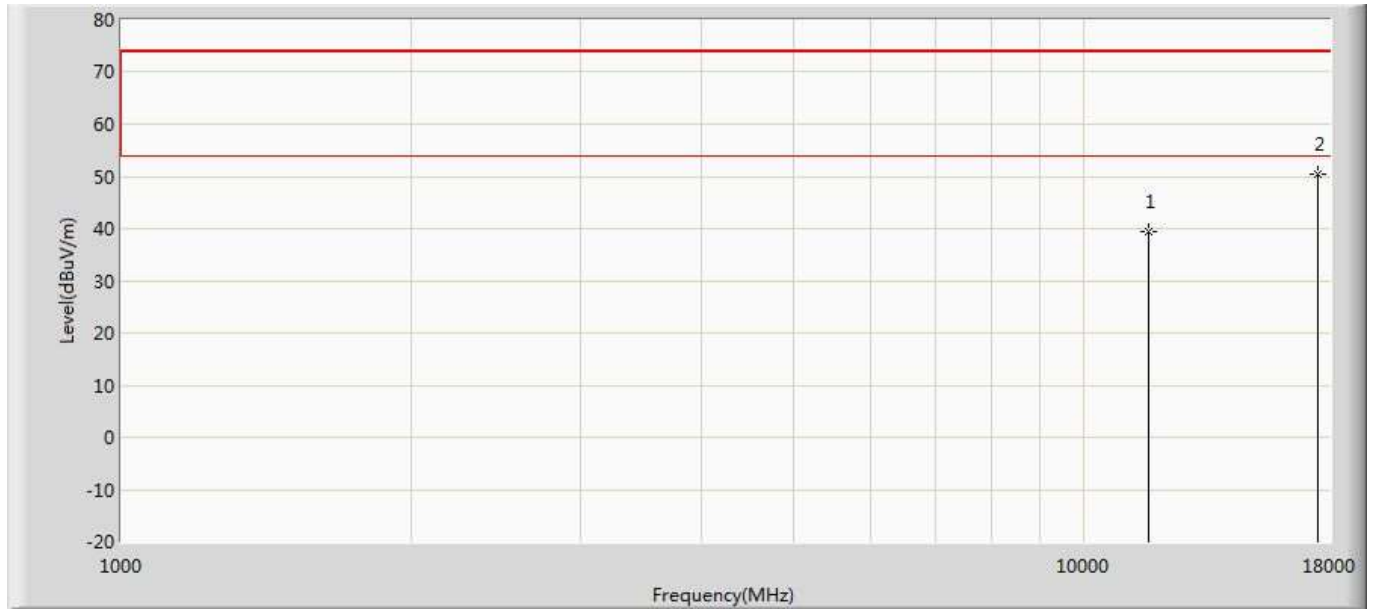

No	Mark	Frequency (MHz)	Measure Level (dBuV/m)	Reading Level (dBuV)	Over Limit (dB)	Limit (dBuV/m)	Factor (dB)	Type
1		11650.000	39.473	25.583	-34.527	74.000	13.889	PK
2	*	17475.000	50.438	28.855	-23.562	74.000	21.583	PK

Profile: 2032034R	Page No.: 8
Engineer: Neil	
Site: AC5	Time: 2020/06/19 - 02:30
Limit: FCC_Part15.209_RE(3m)	Margin: 0
Probe: Horn_3117_00167055(1-18GHz)	Polarity: Horizontal
EUT: Wireless Access Point	Power: AC 120V/60Hz
Note: Mode 2: Transmit at 5745MHz by 802.11n(20MHz)	

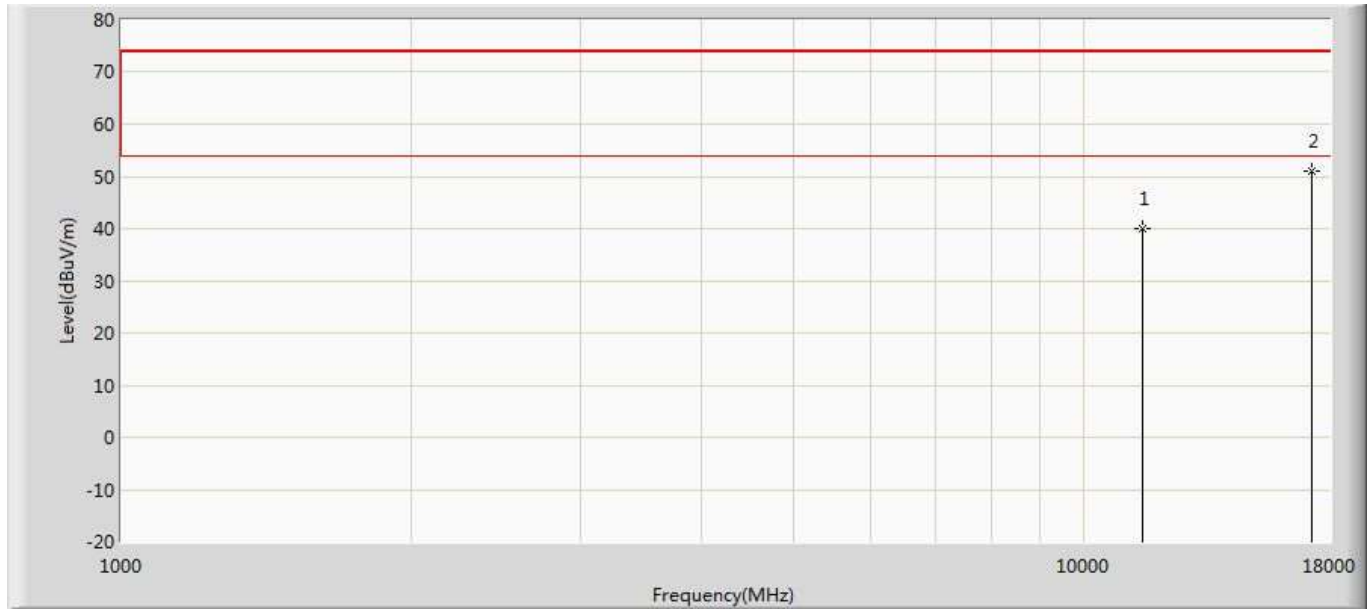

No	Mark	Frequency (MHz)	Measure Level (dBuV/m)	Reading Level (dBuV)	Over Limit (dB)	Limit (dBuV/m)	Factor (dB)	Type
1		11490.000	39.992	27.242	-34.008	74.000	12.751	PK
2	*	17235.000	50.968	30.742	-23.032	74.000	20.226	PK



Profile: 2032034R	Page No.: 9
Engineer: Neil	
Site: AC5	Time: 2020/06/19 - 02:31
Limit: FCC_Part15.209_RE(3m)	Margin: 0
Probe: Horn_3117_00167055(1-18GHz)	Polarity: Vertical
EUT: Wireless Access Point	Power: AC 120V/60Hz
Note: Mode 2: Transmit at 5745MHz by 802.11n(20MHz)	

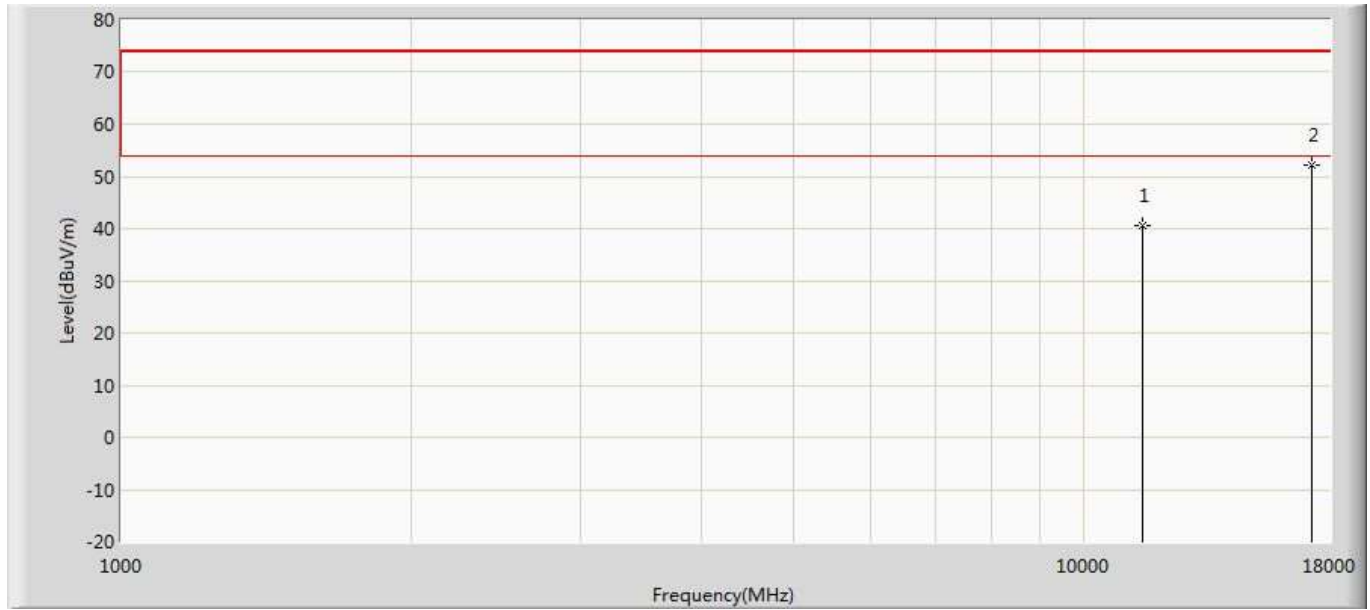

No	Mark	Frequency (MHz)	Measure Level (dBuV/m)	Reading Level (dBuV)	Over Limit (dB)	Limit (dBuV/m)	Factor (dB)	Type
1		11490.000	40.487	27.737	-33.513	74.000	12.751	PK
2	*	17235.000	52.109	31.883	-21.891	74.000	20.226	PK

Profile: 2032034R	Page No.: 10
Engineer: Neil	
Site: AC5	Time: 2020/06/19 - 02:31
Limit: FCC_Part15.209_RE(3m)	Margin: 0
Probe: Horn_3117_00167055(1-18GHz)	Polarity: Horizontal
EUT: Wireless Access Point	Power: AC 120V/60Hz
Note: Mode 2: Transmit at 5785MHz by 802.11n(20MHz)	

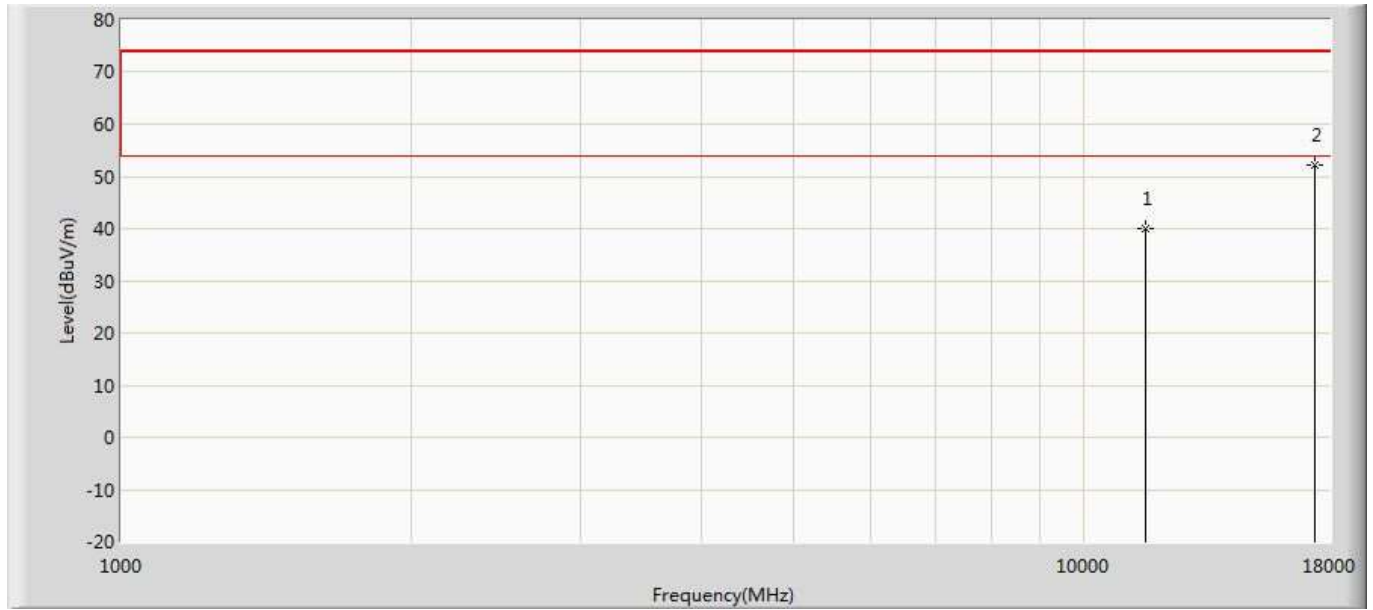

No	Mark	Frequency (MHz)	Measure Level (dBuV/m)	Reading Level (dBuV)	Over Limit (dB)	Limit (dBuV/m)	Factor (dB)	Type
1		11570.000	40.048	26.892	-33.952	74.000	13.156	PK
2	*	17355.000	52.286	29.287	-21.714	74.000	22.998	PK

Profile: 2032034R	Page No.: 11
Engineer: Neil	
Site: AC5	Time: 2020/06/19 - 02:31
Limit: FCC_Part15.209_RE(3m)	Margin: 0
Probe: Horn_3117_00167055(1-18GHz)	Polarity: Vertical
EUT: Wireless Access Point	Power: AC 120V/60Hz
Note: Mode 2: Transmit at 5785MHz by 802.11n(20MHz)	

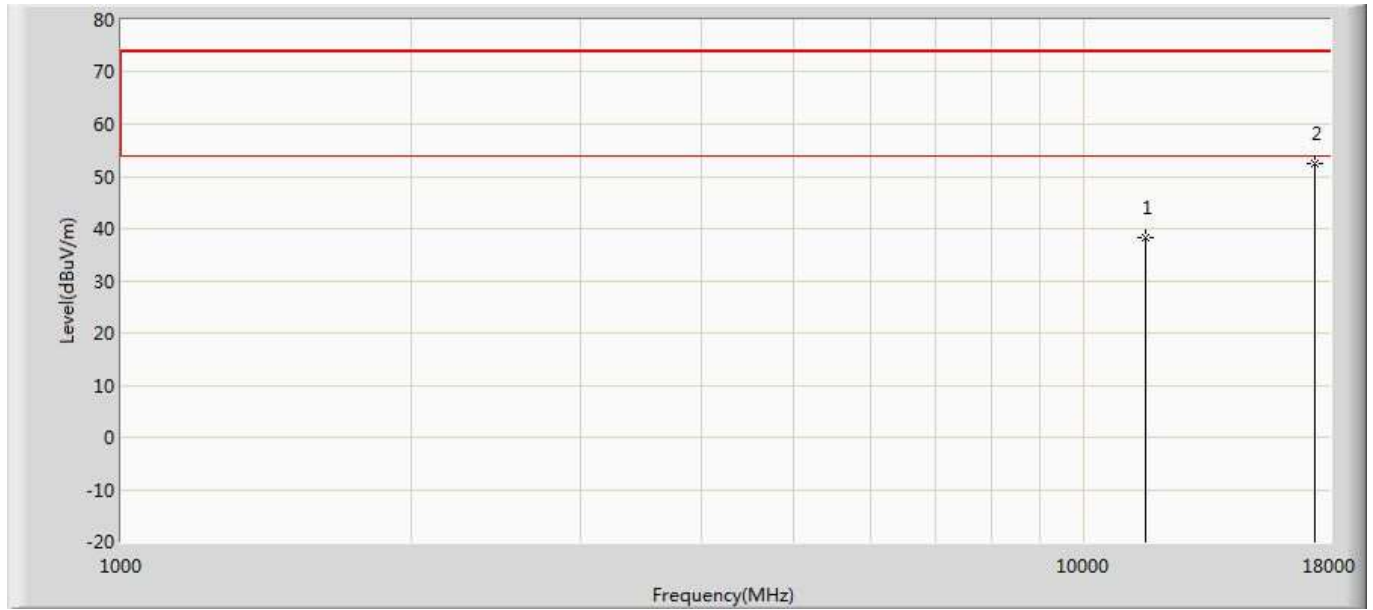

No	Mark	Frequency (MHz)	Measure Level (dBuV/m)	Reading Level (dBuV)	Over Limit (dB)	Limit (dBuV/m)	Factor (dB)	Type
1		11570.000	38.304	25.148	-35.696	74.000	13.156	PK
2	*	17355.000	52.468	29.469	-21.532	74.000	22.998	PK

Profile: 2032034R	Page No.: 12
Engineer: Neil	
Site: AC5	Time: 2020/06/19 - 02:31
Limit: FCC_Part15.209_RE(3m)	Margin: 0
Probe: Horn_3117_00167055(1-18GHz)	Polarity: Horizontal
EUT: Wireless Access Point	Power: AC 120V/60Hz
Note: Mode 2: Transmit at 5825MHz by 802.11n(20MHz)	

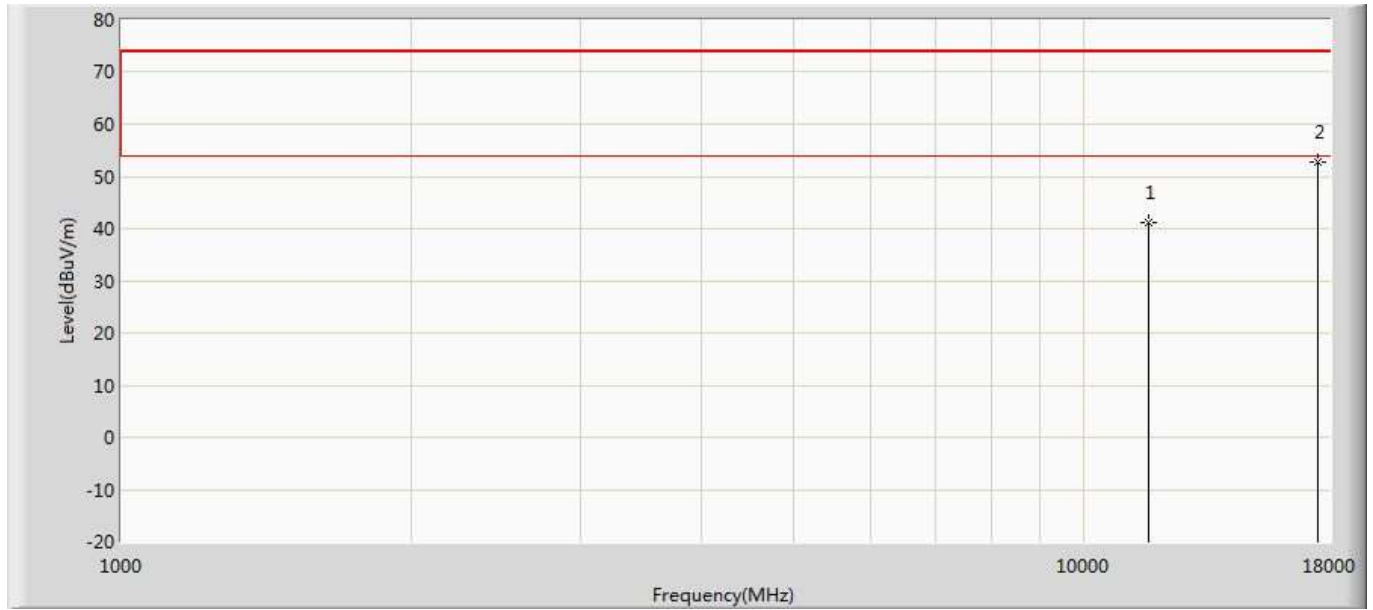

No	Mark	Frequency (MHz)	Measure Level (dBuV/m)	Reading Level (dBuV)	Over Limit (dB)	Limit (dBuV/m)	Factor (dB)	Type
1		11650.000	41.067	27.177	-32.933	74.000	13.889	PK
2	*	17475.000	52.757	31.174	-21.243	74.000	21.583	PK

Profile: 2032034R	Page No.: 13
Engineer: Neil	
Site: AC5	Time: 2020/06/19 - 02:32
Limit: FCC_Part15.209_RE(3m)	Margin: 0
Probe: Horn_3117_00167055(1-18GHz)	Polarity: Vertical
EUT: Wireless Access Point	Power: AC 120V/60Hz
Note: Mode 2: Transmit at 5825MHz by 802.11n(20MHz)	

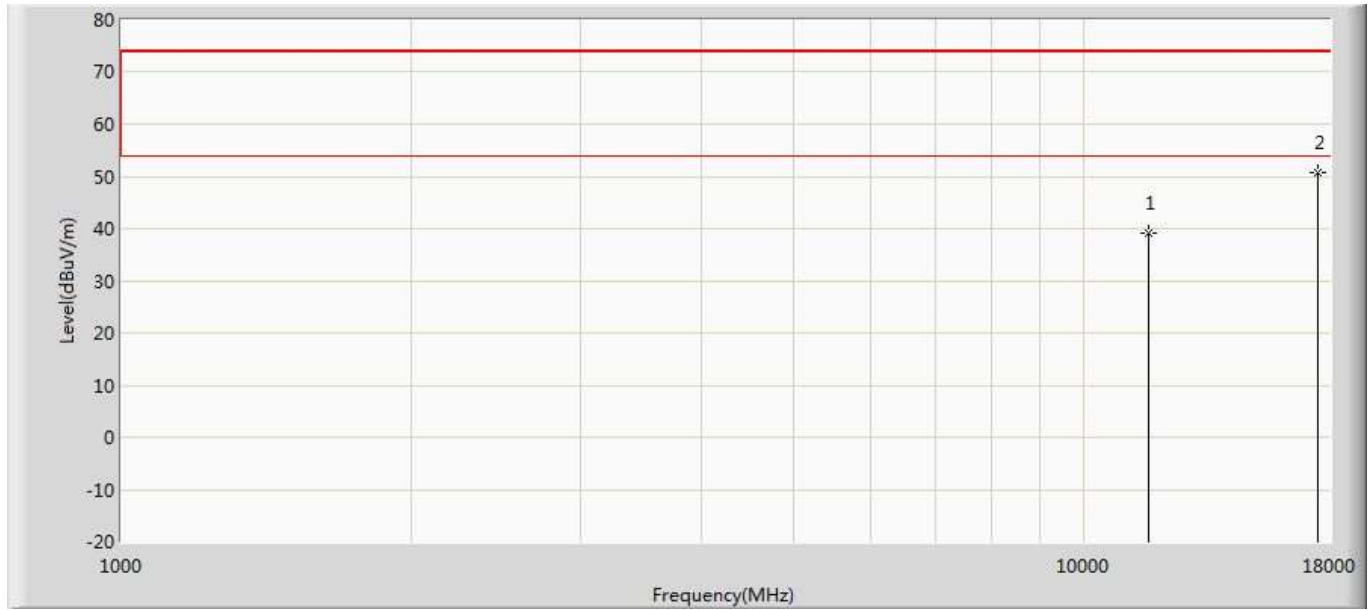

No	Mark	Frequency (MHz)	Measure Level (dBuV/m)	Reading Level (dBuV)	Over Limit (dB)	Limit (dBuV/m)	Factor (dB)	Type
1		11650.000	39.125	25.235	-34.875	74.000	13.889	PK
2	*	17475.000	50.687	29.104	-23.313	74.000	21.583	PK

Profile: 2032034R	Page No.: 14
Engineer: Neil	
Site: AC5	Time: 2020/06/19 - 02:32
Limit: FCC_Part15.209_RE(3m)	Margin: 0
Probe: Horn_3117_00167055(1-18GHz)	Polarity: Horizontal
EUT: Wireless Access Point	Power: AC 120V/60Hz
Note: Mode 3:Transmit at 5755MHz by 802.11n(40MHz)	

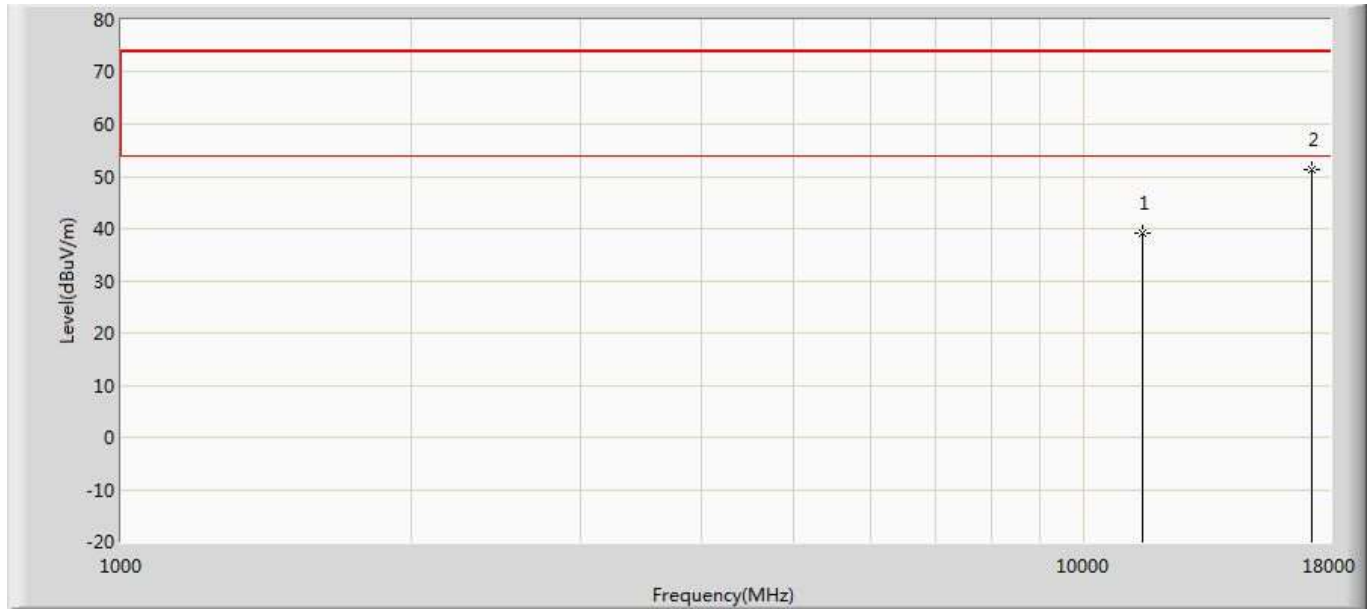

No	Mark	Frequency (MHz)	Measure Level (dBuV/m)	Reading Level (dBuV)	Over Limit (dB)	Limit (dBuV/m)	Factor (dB)	Type
1		11510.000	39.100	26.049	-34.900	74.000	13.051	PK
2	*	17265.000	51.386	30.658	-22.614	74.000	20.728	PK

Profile: 2032034R	Page No.: 15
Engineer: Neil	
Site: AC5	Time: 2020/06/19 - 02:32
Limit: FCC_Part15.209_RE(3m)	Margin: 0
Probe: Horn_3117_00167055(1-18GHz)	Polarity: Vertical
EUT: Wireless Access Point	Power: AC 120V/60Hz
Note: Mode 3:Transmit at 5755MHz by 802.11n(40MHz)	

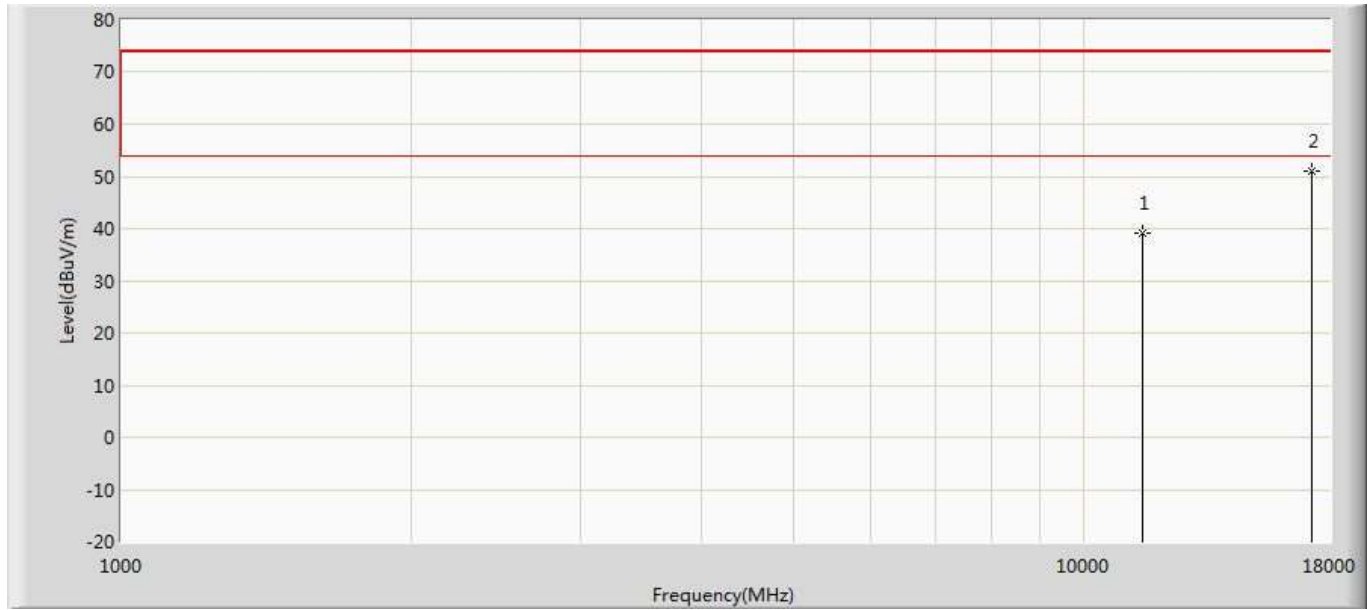

No	Mark	Frequency (MHz)	Measure Level (dBuV/m)	Reading Level (dBuV)	Over Limit (dB)	Limit (dBuV/m)	Factor (dB)	Type
1		11510.000	39.074	26.023	-34.926	74.000	13.051	PK
2	*	17265.000	51.098	30.370	-22.902	74.000	20.728	PK

Profile: 2032034R	Page No.: 16
Engineer: Neil	
Site: AC5	Time: 2020/06/19 - 02:33
Limit: FCC_Part15.209_RE(3m)	Margin: 0
Probe: Horn_3117_00167055(1-18GHz)	Polarity: Horizontal
EUT: Wireless Access Point	Power: AC 120V/60Hz
Note: Mode 3:Transmit at 5795MHz by 802.11n(40MHz)	

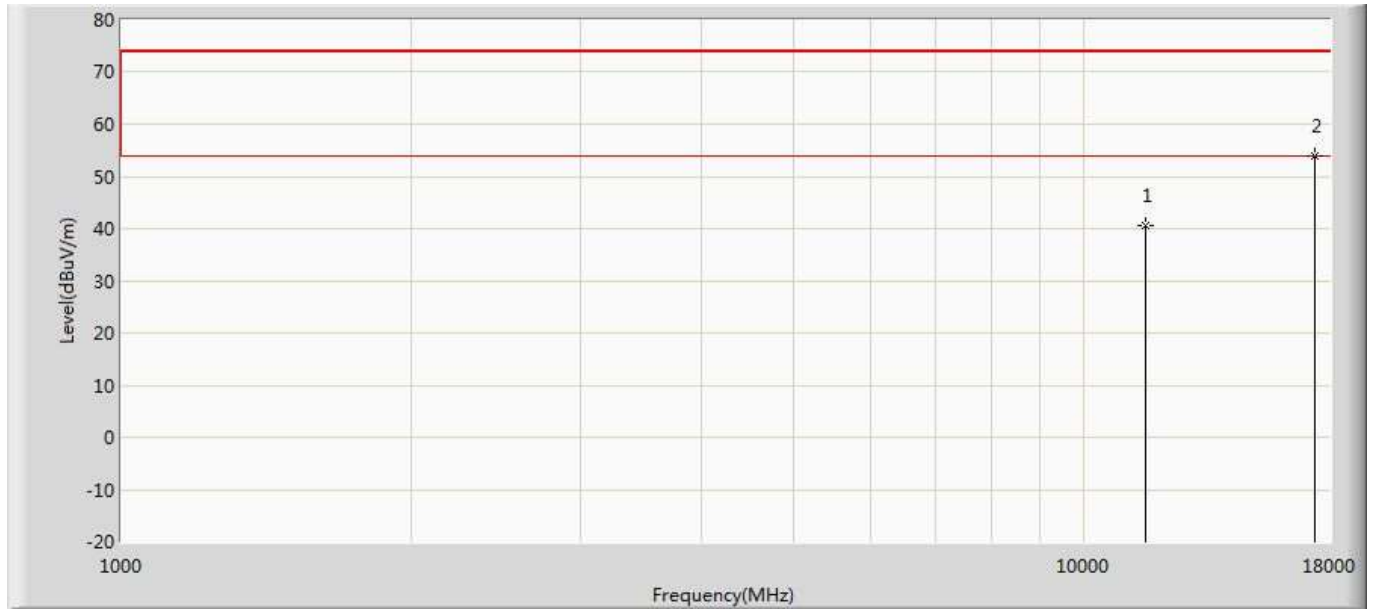

No	Mark	Frequency (MHz)	Measure Level (dBuV/m)	Reading Level (dBuV)	Over Limit (dB)	Limit (dBuV/m)	Factor (dB)	Type
1		11590.000	40.606	27.283	-33.394	74.000	13.324	PK
2	*	17385.000	53.918	31.743	-20.082	74.000	22.175	PK



Profile: 2032034R	Page No.: 17
Engineer: Neil	
Site: AC5	Time: 2020/06/19 - 02:33
Limit: FCC_Part15.209_RE(3m)	Margin: 0
Probe: Horn_3117_00167055(1-18GHz)	Polarity: Vertical
EUT: Wireless Access Point	Power: AC 120V/60Hz
Note: Mode 3:Transmit at 5795MHz by 802.11n(40MHz)	

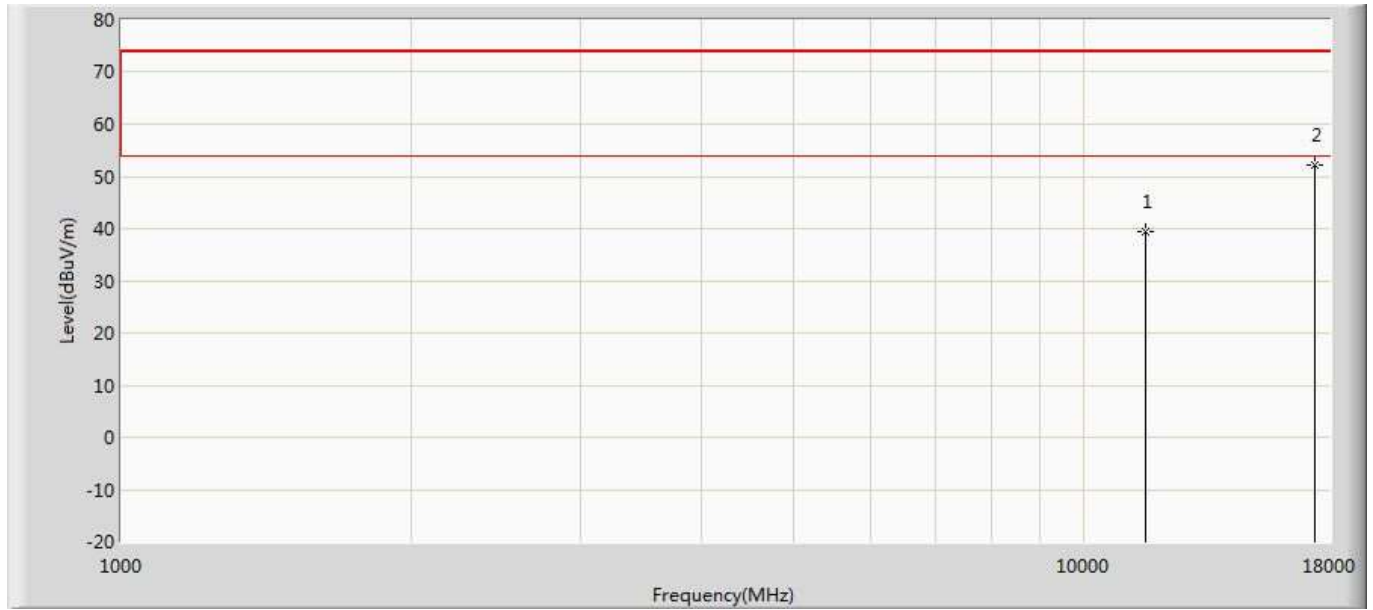

No	Mark	Frequency (MHz)	Measure Level (dBuV/m)	Reading Level (dBuV)	Over Limit (dB)	Limit (dBuV/m)	Factor (dB)	Type
1		11590.000	39.281	25.958	-34.719	74.000	13.324	PK
2	*	17385.000	52.049	29.874	-21.951	74.000	22.175	PK

Profile: 2032034R	Page No.: 18
Engineer: Neil	
Site: AC5	Time: 2020/06/19 - 02:33
Limit: FCC_Part15.209_RE(3m)	Margin: 0
Probe: Horn_3117_00167055(1-18GHz)	Polarity: Horizontal
EUT: Wireless Access Point	Power: AC 120V/60Hz
Note: Mode 4:Transmit at 5745MHz by 802.11ac(20MHz)	

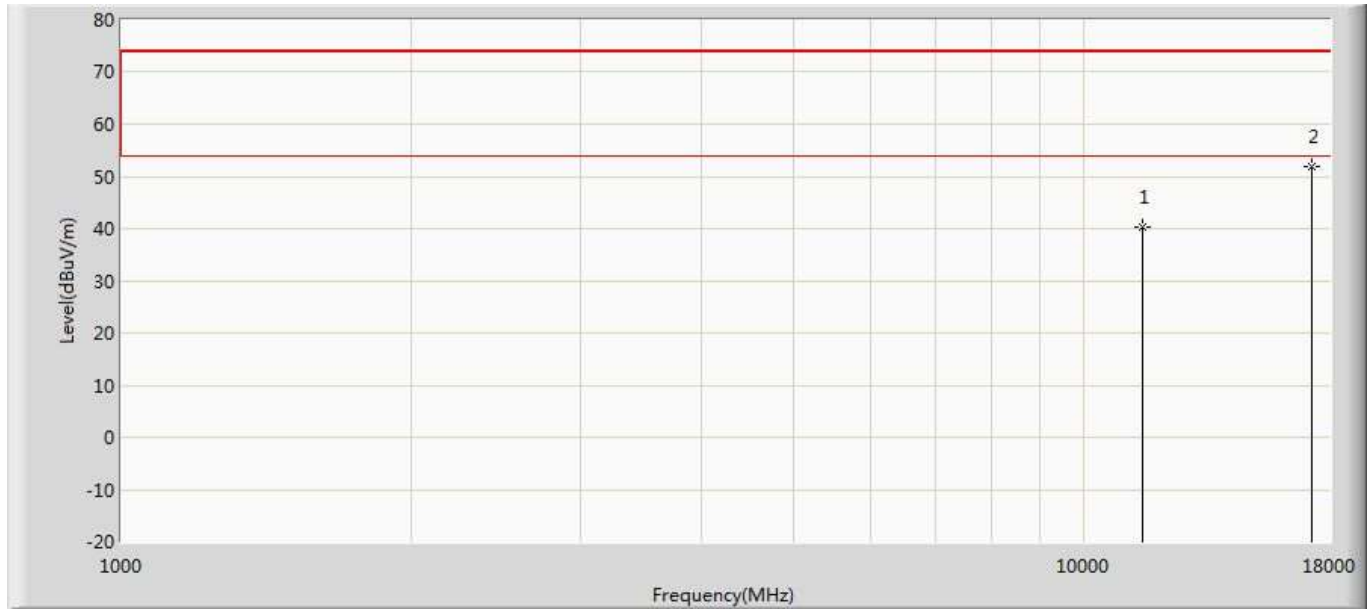

No	Mark	Frequency (MHz)	Measure Level (dBuV/m)	Reading Level (dBuV)	Over Limit (dB)	Limit (dBuV/m)	Factor (dB)	Type
1		11490.000	40.402	27.652	-33.598	74.000	12.751	PK
2	*	17235.000	51.833	31.607	-22.167	74.000	20.226	PK

Profile: 2032034R	Page No.: 19
Engineer: Neil	
Site: AC5	Time: 2020/06/19 - 02:34
Limit: FCC_Part15.209_RE(3m)	Margin: 0
Probe: Horn_3117_00167055(1-18GHz)	Polarity: Vertical
EUT: Wireless Access Point	Power: AC 120V/60Hz
Note: Mode 4:Transmit at 5745MHz by 802.11ac(20MHz)	

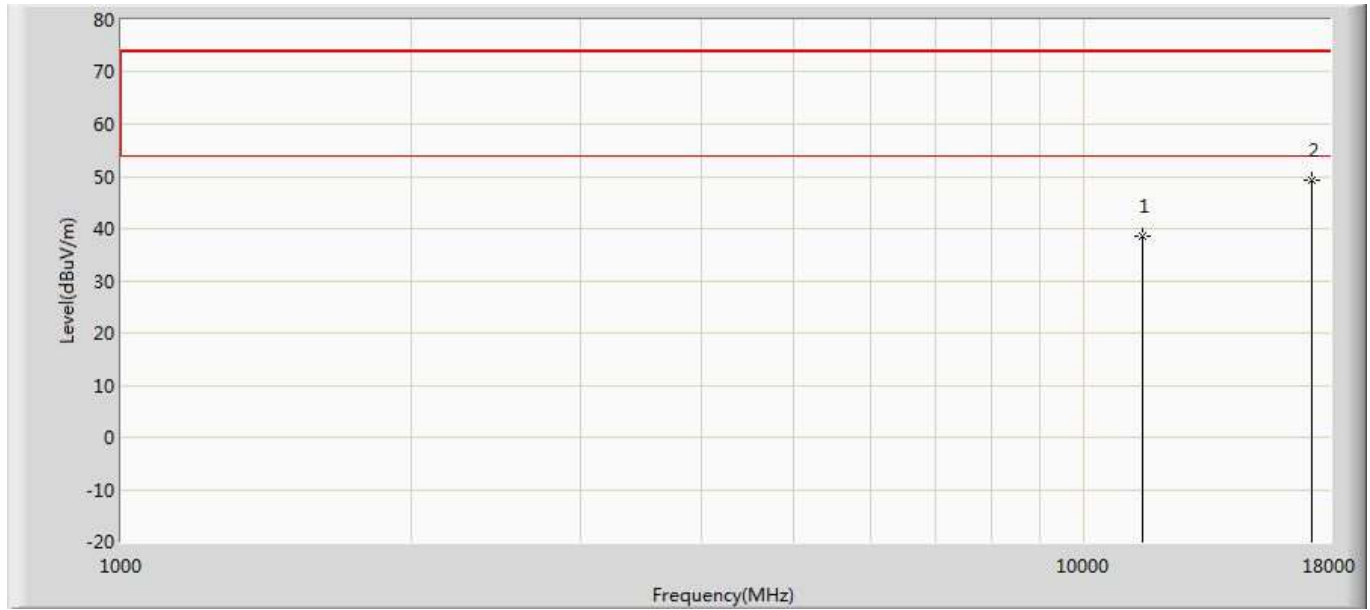

No	Mark	Frequency (MHz)	Measure Level (dBuV/m)	Reading Level (dBuV)	Over Limit (dB)	Limit (dBuV/m)	Factor (dB)	Type
1		11490.000	38.660	25.910	-35.340	74.000	12.751	PK
2	*	17235.000	49.282	29.056	-24.718	74.000	20.226	PK

Profile: 2032034R	Page No.: 20
Engineer: Neil	
Site: AC5	Time: 2020/06/19 - 02:34
Limit: FCC_Part15.209_RE(3m)	Margin: 0
Probe: Horn_3117_00167055(1-18GHz)	Polarity: Horizontal
EUT: Wireless Access Point	Power: AC 120V/60Hz
Note: Mode 4:Transmit at 5785MHz by 802.11ac(20MHz)	

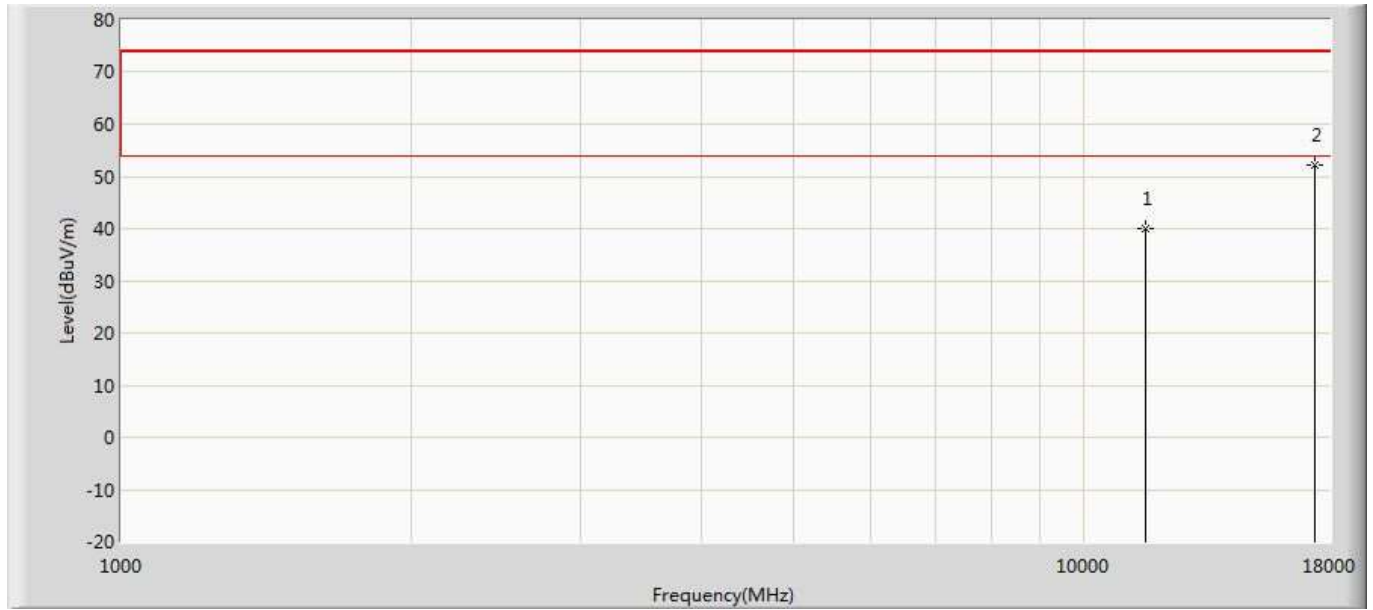

No	Mark	Frequency (MHz)	Measure Level (dBuV/m)	Reading Level (dBuV)	Over Limit (dB)	Limit (dBuV/m)	Factor (dB)	Type
1		11570.000	40.048	26.892	-33.952	74.000	13.156	PK
2	*	17355.000	52.286	29.287	-21.714	74.000	22.998	PK

Profile: 2032034R	Page No.: 21
Engineer: Neil	
Site: AC5	Time: 2020/06/19 - 02:35
Limit: FCC_Part15.209_RE(3m)	Margin: 0
Probe: Horn_3117_00167055(1-18GHz)	Polarity: Vertical
EUT: Wireless Access Point	Power: AC 120V/60Hz
Note: Mode 4:Transmit at 5785MHz by 802.11ac(20MHz)	

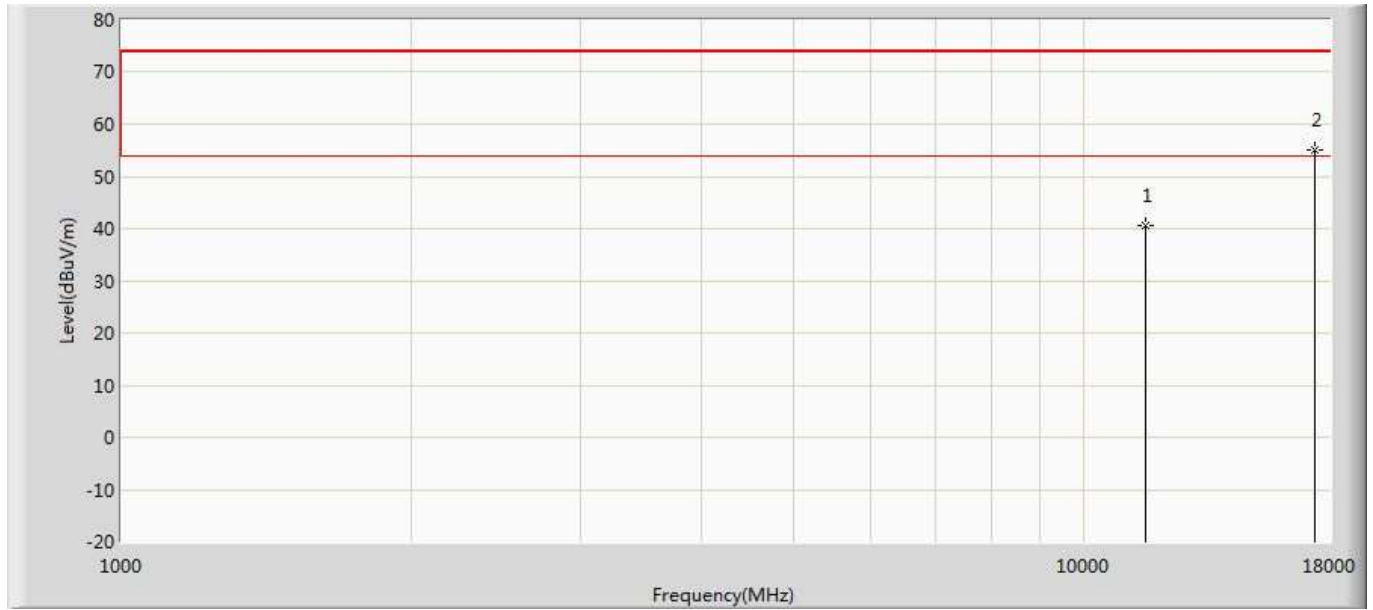

No	Mark	Frequency (MHz)	Measure Level (dBuV/m)	Reading Level (dBuV)	Over Limit (dB)	Limit (dBuV/m)	Factor (dB)	Type
1		11570.000	40.501	27.345	-33.499	74.000	13.156	PK
2	*	17355.000	54.979	31.980	-19.021	74.000	22.998	PK

Profile: 2032034R	Page No.: 22
Engineer: Neil	
Site: AC5	Time: 2020/06/19 - 02:35
Limit: FCC_Part15.209_RE(3m)	Margin: 0
Probe: Horn_3117_00167055(1-18GHz)	Polarity: Horizontal
EUT: Wireless Access Point	Power: AC 120V/60Hz
Note: Mode 4:Transmit at 5825MHz by 802.11ac(20MHz)	

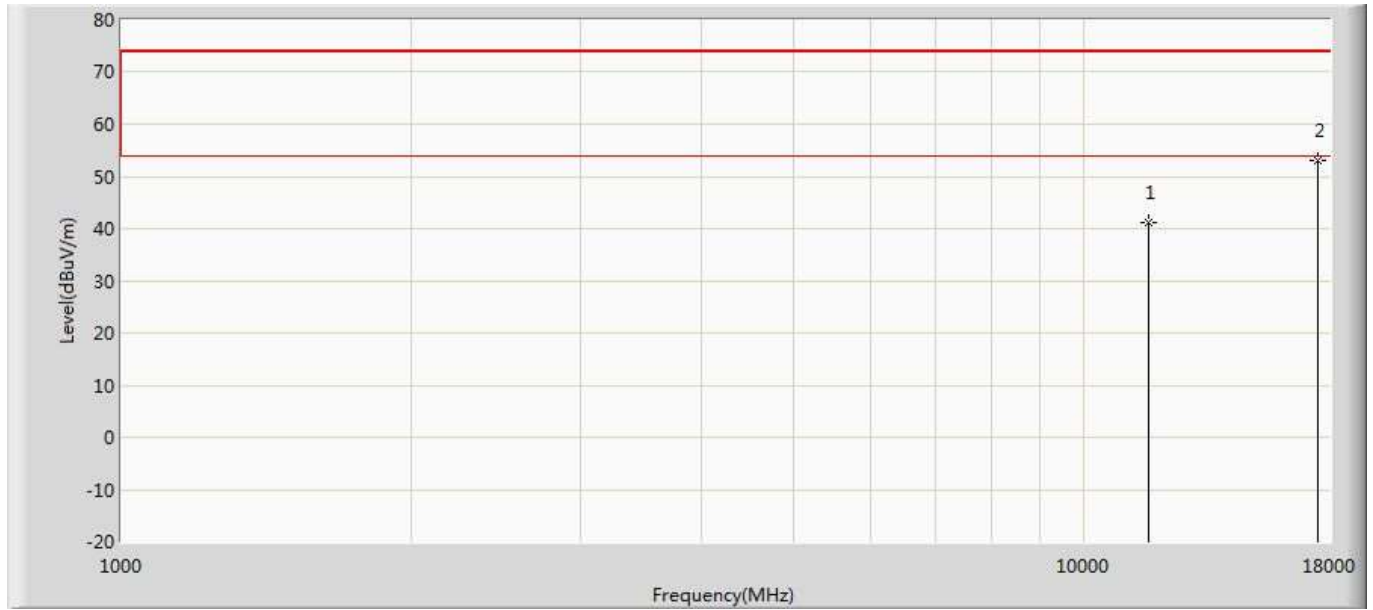

No	Mark	Frequency (MHz)	Measure Level (dBuV/m)	Reading Level (dBuV)	Over Limit (dB)	Limit (dBuV/m)	Factor (dB)	Type
1		11650.000	41.273	27.383	-32.727	74.000	13.889	PK
2	*	17475.000	53.125	31.542	-20.875	74.000	21.583	PK

Profile: 2032034R	Page No.: 23
Engineer: Neil	
Site: AC5	Time: 2020/06/19 - 02:35
Limit: FCC_Part15.209_RE(3m)	Margin: 0
Probe: Horn_3117_00167055(1-18GHz)	Polarity: Vertical
EUT: Wireless Access Point	Power: AC 120V/60Hz
Note: Mode 4:Transmit at 5825MHz by 802.11ac(20MHz)	

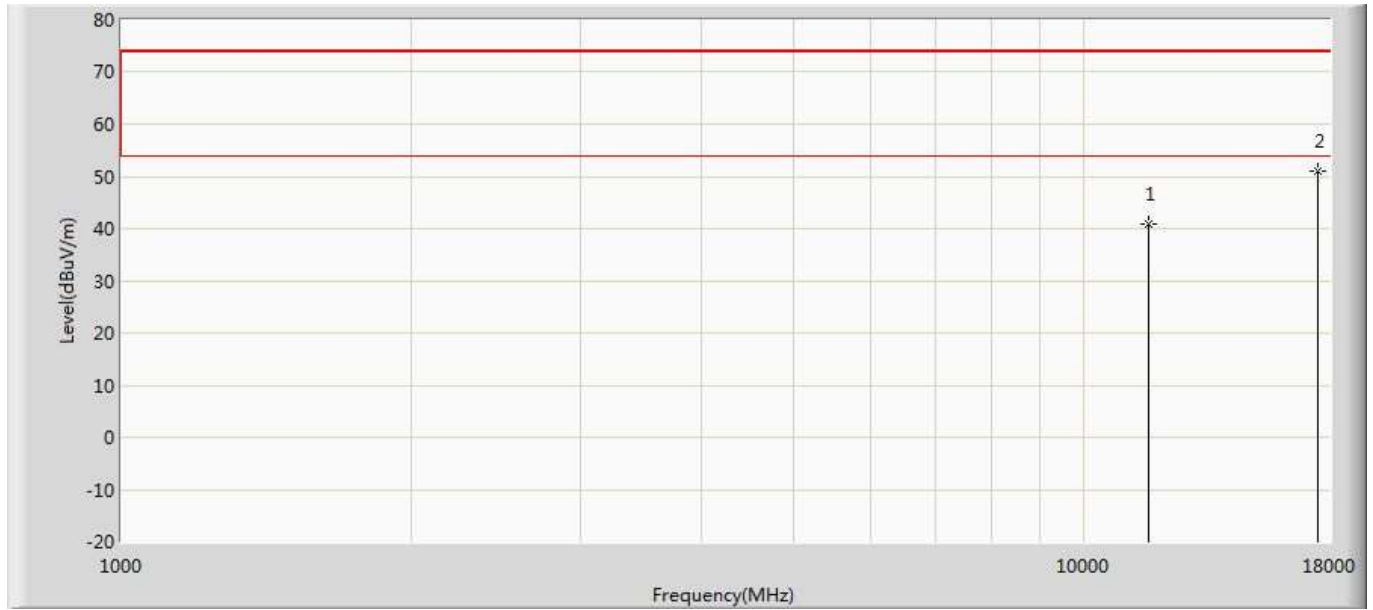

No	Mark	Frequency (MHz)	Measure Level (dBuV/m)	Reading Level (dBuV)	Over Limit (dB)	Limit (dBuV/m)	Factor (dB)	Type
1		11650.000	41.013	27.123	-32.987	74.000	13.889	PK
2	*	17475.000	50.960	29.377	-23.040	74.000	21.583	PK

Profile: 2032034R	Page No.: 24
Engineer: Neil	
Site: AC5	Time: 2020/06/19 - 02:36
Limit: FCC_Part15.209_RE(3m)	Margin: 0
Probe: Horn_3117_00167055(1-18GHz)	Polarity: Horizontal
EUT: Wireless Access Point	Power: AC 120V/60Hz
Note: Mode 5:Transmit at 5755MHz by 802.11ac(40MHz)	

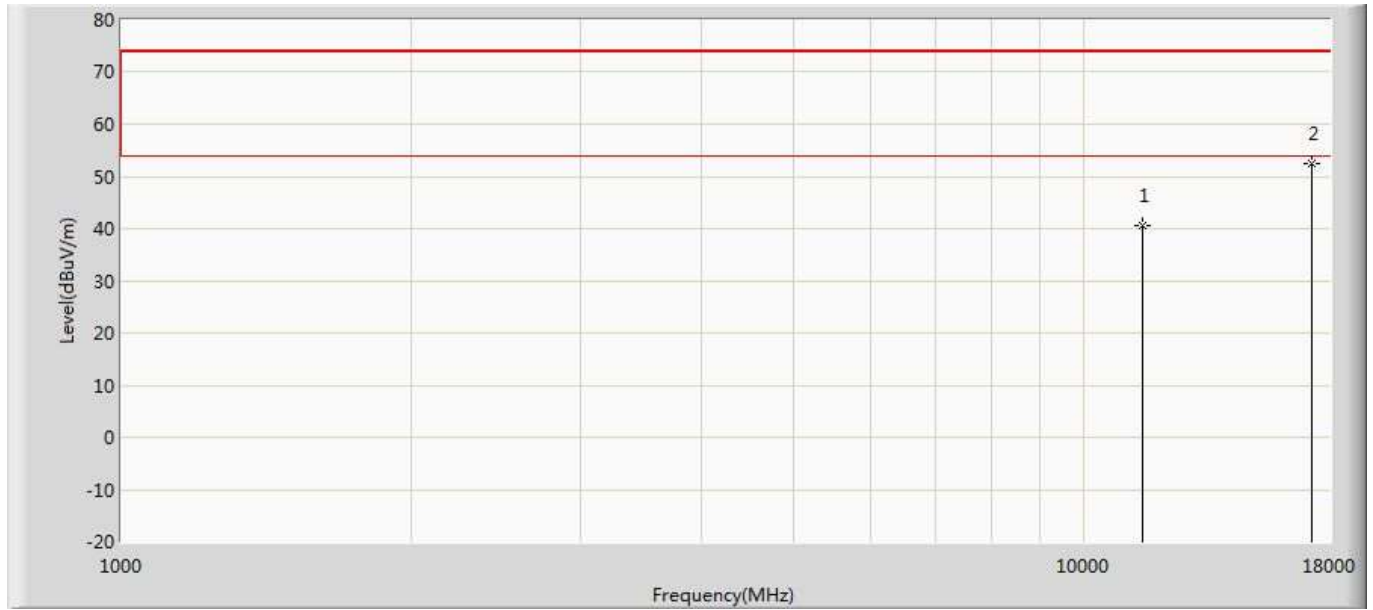

No	Mark	Frequency (MHz)	Measure Level (dBuV/m)	Reading Level (dBuV)	Over Limit (dB)	Limit (dBuV/m)	Factor (dB)	Type
1		11510.000	40.583	27.532	-33.417	74.000	13.051	PK
2	*	17265.000	52.383	31.655	-21.617	74.000	20.728	PK



Profile: 2032034R	Page No.: 25
Engineer: Neil	
Site: AC5	Time: 2020/06/19 - 02:36
Limit: FCC_Part15.209_RE(3m)	Margin: 0
Probe: Horn_3117_00167055(1-18GHz)	Polarity: Vertical
EUT: Wireless Access Point	Power: AC 120V/60Hz
Note: Mode 5:Transmit at 5755MHz by 802.11ac(40MHz)	

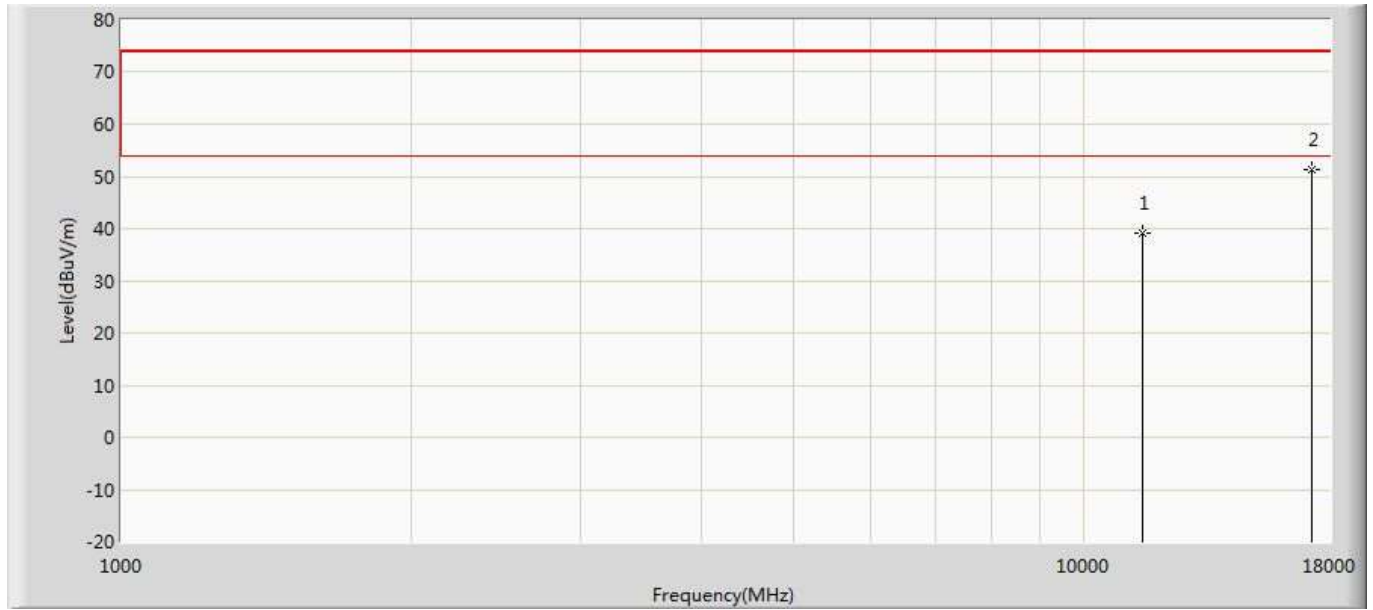

No	Mark	Frequency (MHz)	Measure Level (dBuV/m)	Reading Level (dBuV)	Over Limit (dB)	Limit (dBuV/m)	Factor (dB)	Type
1		11510.000	39.114	26.063	-34.886	74.000	13.051	PK
2	*	17265.000	51.362	30.634	-22.638	74.000	20.728	PK

Profile: 2032034R	Page No.: 26
Engineer: Neil	
Site: AC5	Time: 2020/06/19 - 02:36
Limit: FCC_Part15.209_RE(3m)	Margin: 0
Probe: Horn_3117_00167055(1-18GHz)	Polarity: Horizontal
EUT: Wireless Access Point	Power: AC 120V/60Hz
Note: Mode 5:Transmit at 5795MHz by 802.11ac(40MHz)	

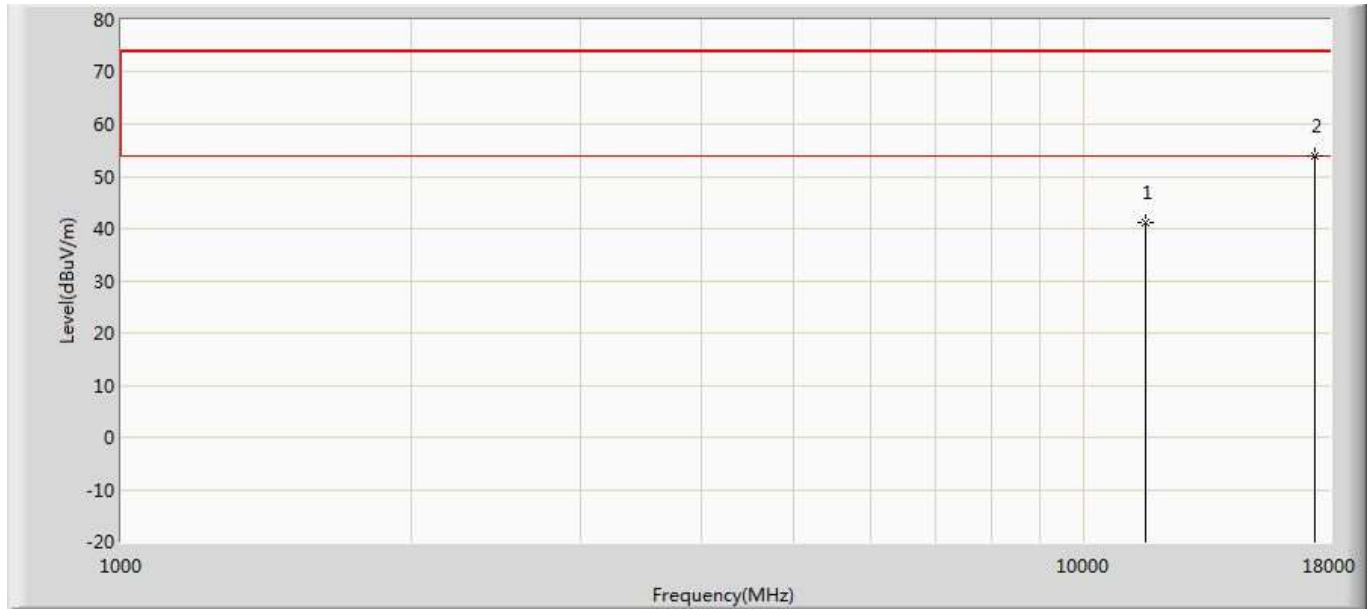

No	Mark	Frequency (MHz)	Measure Level (dBuV/m)	Reading Level (dBuV)	Over Limit (dB)	Limit (dBuV/m)	Factor (dB)	Type
1		11590.000	41.051	27.728	-32.949	74.000	13.324	PK
2	*	17385.000	53.839	31.664	-20.161	74.000	22.175	PK

Profile: 2032034R	Page No.: 27
Engineer: Neil	
Site: AC5	Time: 2020/06/19 - 02:37
Limit: FCC_Part15.209_RE(3m)	Margin: 0
Probe: Horn_3117_00167055(1-18GHz)	Polarity: Vertical
EUT: Wireless Access Point	Power: AC 120V/60Hz
Note: Mode 5:Transmit at 5795MHz by 802.11ac(40MHz)	

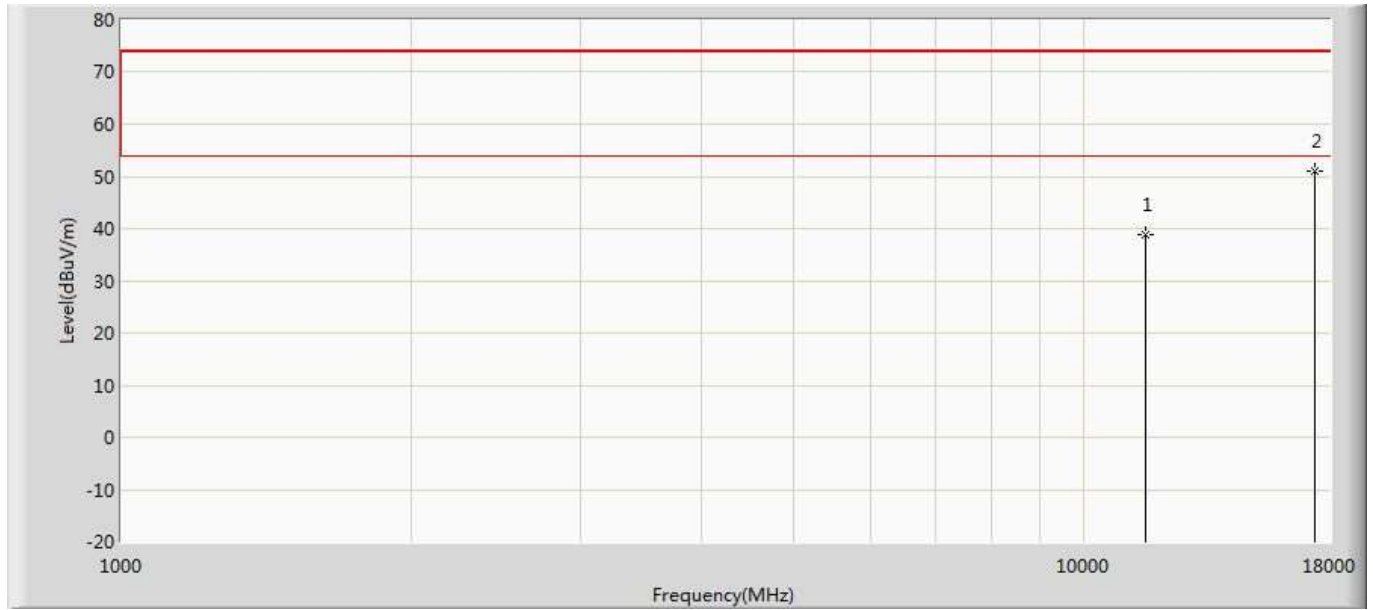

No	Mark	Frequency (MHz)	Measure Level (dBuV/m)	Reading Level (dBuV)	Over Limit (dB)	Limit (dBuV/m)	Factor (dB)	Type
1		11590.000	38.812	25.489	-35.188	74.000	13.324	PK
2	*	17385.000	51.046	28.871	-22.954	74.000	22.175	PK

Profile: 2032034R	Page No.: 28
Engineer: Neil	
Site: AC5	Time: 2020/06/19 - 02:37
Limit: FCC_Part15.209_RE(3m)	Margin: 0
Probe: Horn_3117_00167055(1-18GHz)	Polarity: Horizontal
EUT: Wireless Access Point	Power: AC 120V/60Hz
Note: Mode 6:Transmit at 5775MHz by 802.11ac(80MHz)	

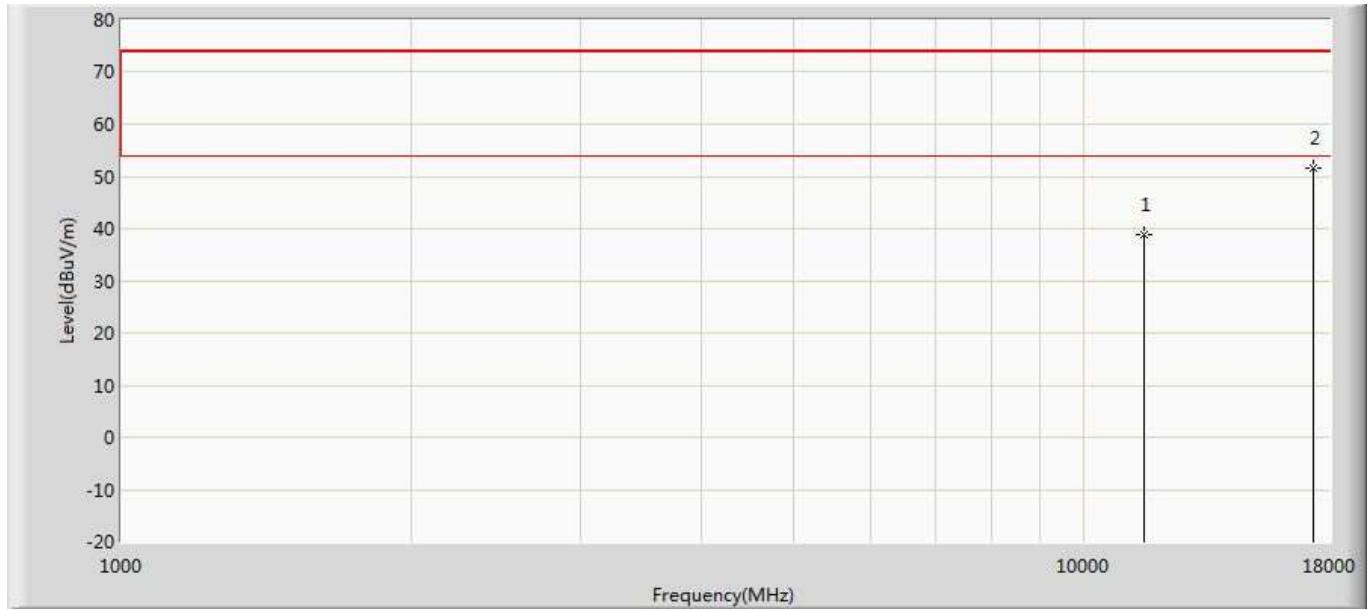

No	Mark	Frequency (MHz)	Measure Level (dBuV/m)	Reading Level (dBuV)	Over Limit (dB)	Limit (dBuV/m)	Factor (dB)	Type
1		11550.000	38.777	25.504	-35.223	74.000	13.272	PK
2	*	17325.000	51.541	29.261	-22.459	74.000	22.280	PK

Profile: 2032034R	Page No.: 29
Engineer: Neil	
Site: AC5	Time: 2020/06/19 - 02:37
Limit: FCC_Part15.209_RE(3m)	Margin: 0
Probe: Horn_3117_00167055(1-18GHz)	Polarity: Vertical
EUT: Wireless Access Point	Power: AC 120V/60Hz
Note: Mode 6:Transmit at 5775MHz by 802.11ac(80MHz)	

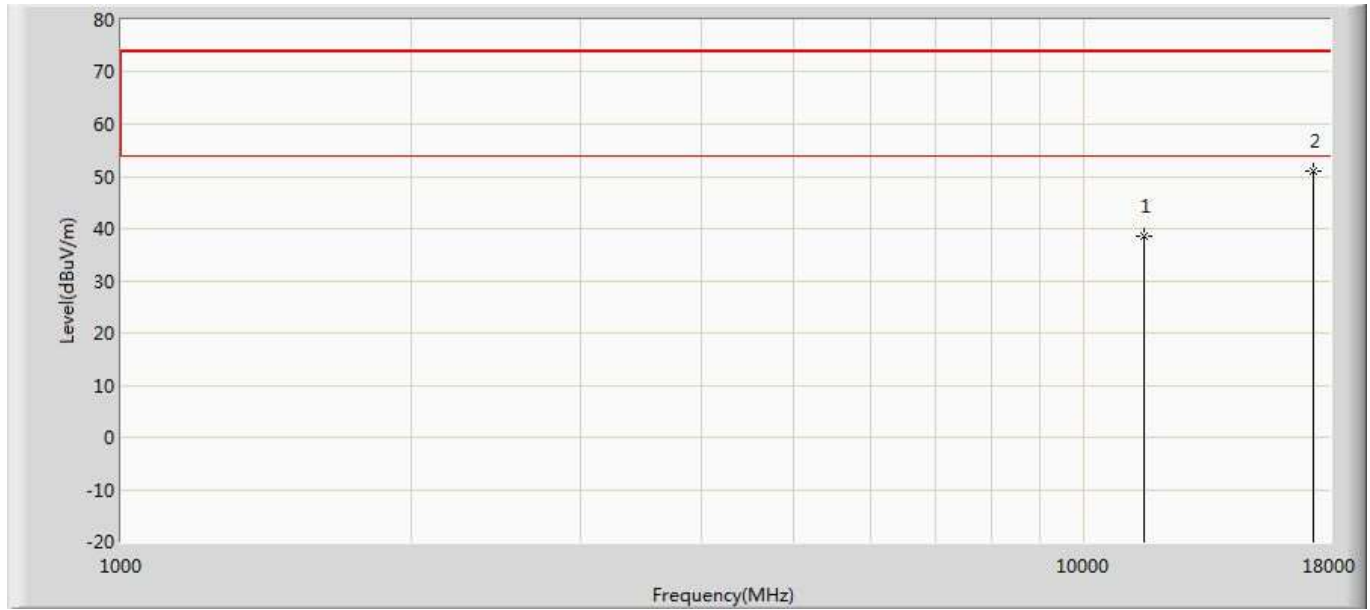

No	Mark	Frequency (MHz)	Measure Level (dBuV/m)	Reading Level (dBuV)	Over Limit (dB)	Limit (dBuV/m)	Factor (dB)	Type
1		11550.000	38.642	25.369	-35.358	74.000	13.272	PK
2	*	17325.000	50.957	28.677	-23.043	74.000	22.280	PK

Profile: 2032034R	Page No.: 30
Engineer: Neil	
Site: AC5	Time: 2020/06/19 - 02:38
Limit: FCC_Part15.209_RE(3m)	Margin: 0
Probe: Horn_3117_00167055(1-18GHz)	Polarity: Horizontal
EUT: Wireless Access Point	Power: AC 120V/60Hz
Note: Mode 7: Transmit at 5745MHz by 802.11ax(20MHz)	

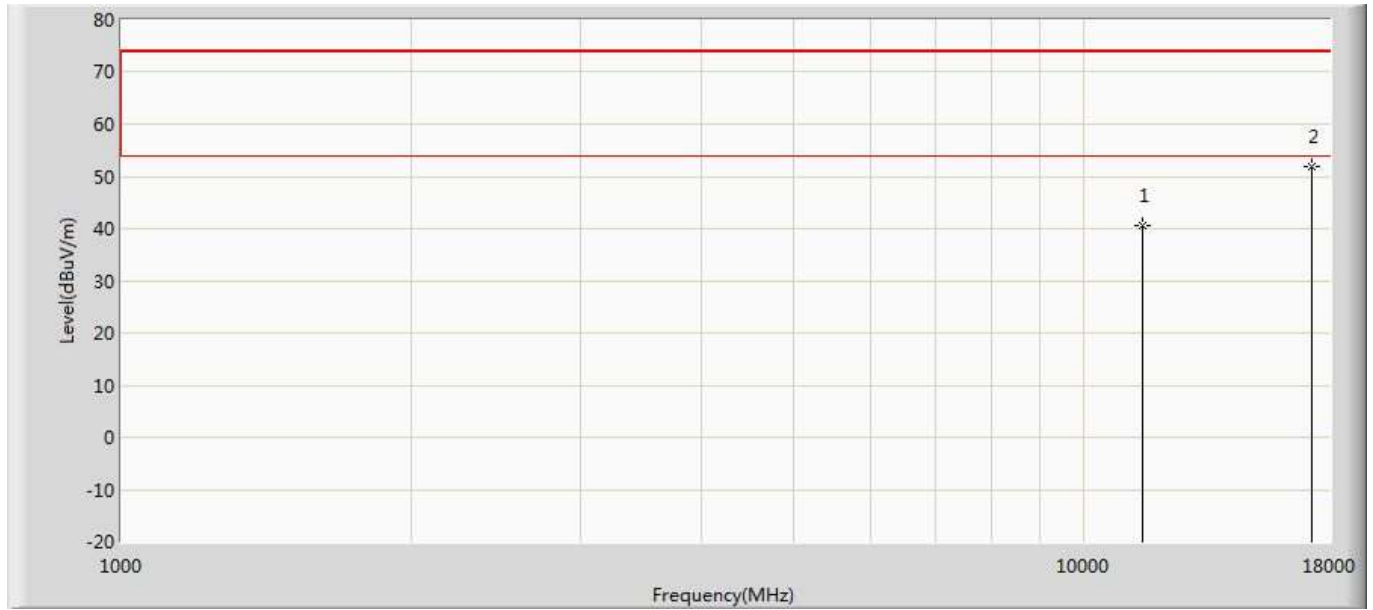

No	Mark	Frequency (MHz)	Measure Level (dBuV/m)	Reading Level (dBuV)	Over Limit (dB)	Limit (dBuV/m)	Factor (dB)	Type
1		11490.000	40.554	27.804	-33.446	74.000	12.751	PK
2	*	17235.000	51.772	31.546	-22.228	74.000	20.226	PK

Profile: 2032034R	Page No.: 31
Engineer: Neil	
Site: AC5	Time: 2020/06/19 - 02:38
Limit: FCC_Part15.209_RE(3m)	Margin: 0
Probe: Horn_3117_00167055(1-18GHz)	Polarity: Vertical
EUT: Wireless Access Point	Power: AC 120V/60Hz
Note: Mode 7:Transmit at 5745MHz by 802.11ax(20MHz)	

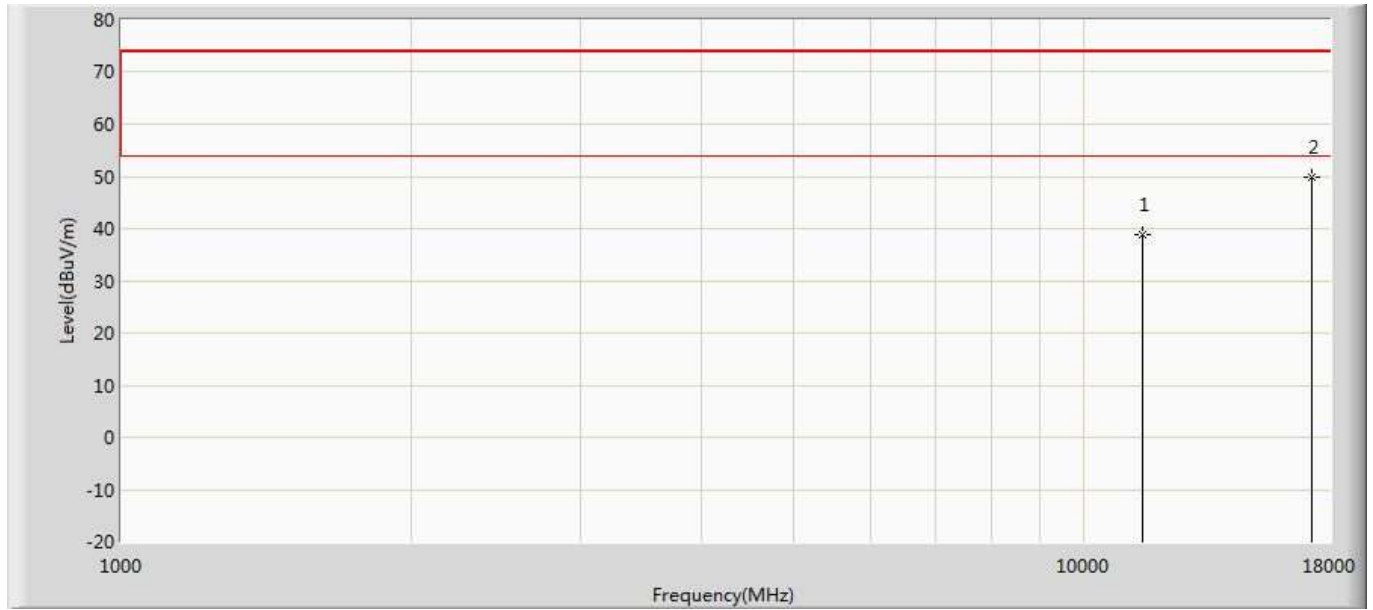

No	Mark	Frequency (MHz)	Measure Level (dBuV/m)	Reading Level (dBuV)	Over Limit (dB)	Limit (dBuV/m)	Factor (dB)	Type
1		11490.000	38.789	26.039	-35.211	74.000	12.751	PK
2	*	17235.000	49.810	29.584	-24.190	74.000	20.226	PK

Profile: 2032034R	Page No.: 32
Engineer: Neil	
Site: AC5	Time: 2020/06/19 - 02:38
Limit: FCC_Part15.209_RE(3m)	Margin: 0
Probe: Horn_3117_00167055(1-18GHz)	Polarity: Horizontal
EUT: Wireless Access Point	Power: AC 120V/60Hz
Note: Mode 7: Transmit at 5785MHz by 802.11ax(20MHz)	

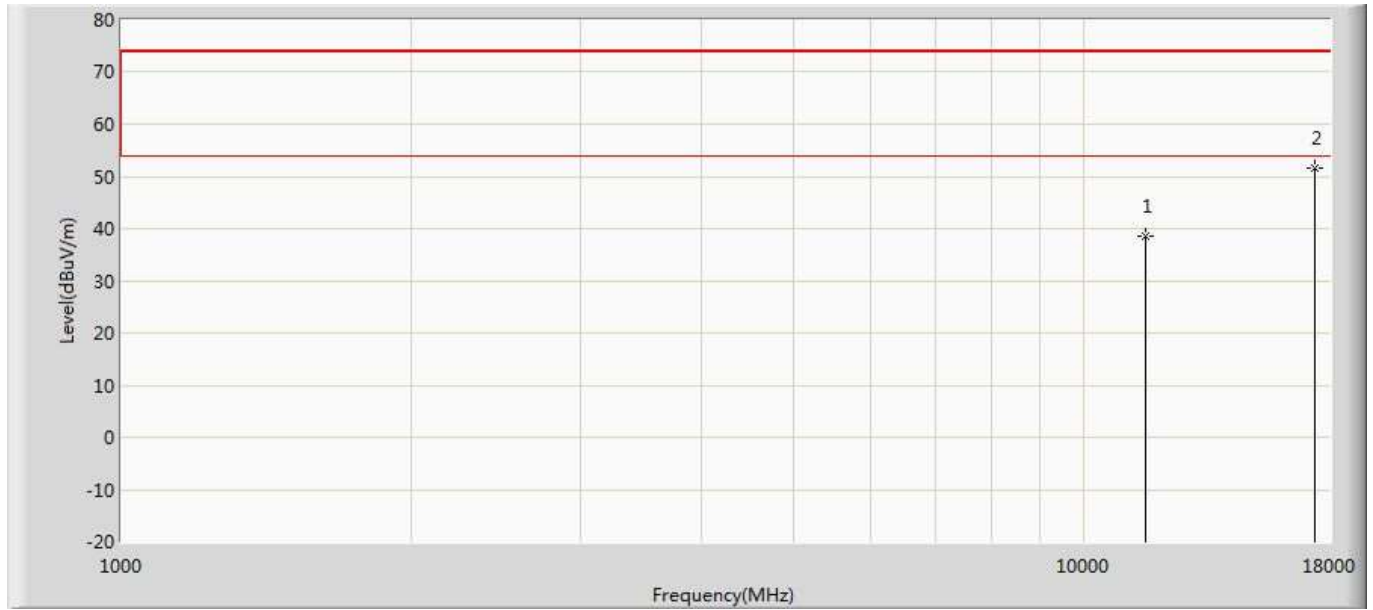

No	Mark	Frequency (MHz)	Measure Level (dBuV/m)	Reading Level (dBuV)	Over Limit (dB)	Limit (dBuV/m)	Factor (dB)	Type
1		11570.000	38.510	25.354	-35.490	74.000	13.156	PK
2	*	17355.000	51.719	28.720	-22.281	74.000	22.998	PK



Profile: 2032034R	Page No.: 33
Engineer: Neil	
Site: AC5	Time: 2020/06/19 - 02:39
Limit: FCC_Part15.209_RE(3m)	Margin: 0
Probe: Horn_3117_00167055(1-18GHz)	Polarity: Vertical
EUT: Wireless Access Point	Power: AC 120V/60Hz
Note: Mode 7:Transmit at 5785MHz by 802.11ax(20MHz)	

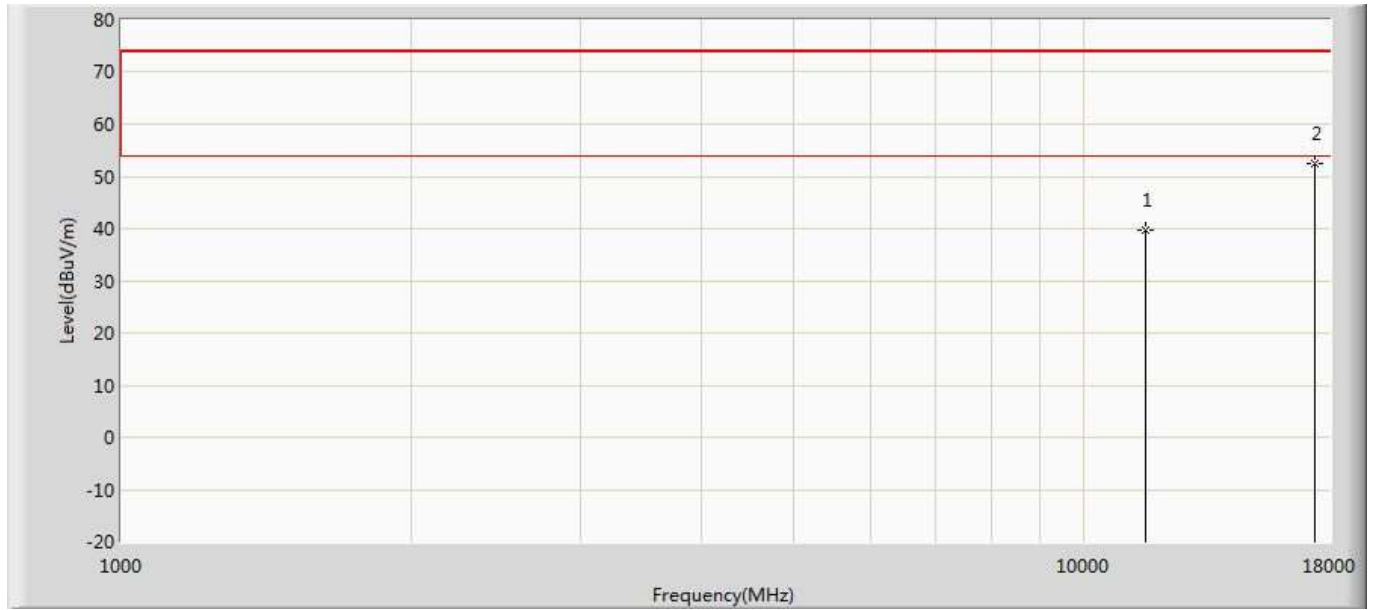

No	Mark	Frequency (MHz)	Measure Level (dBuV/m)	Reading Level (dBuV)	Over Limit (dB)	Limit (dBuV/m)	Factor (dB)	Type
1		11570.000	39.781	26.625	-34.219	74.000	13.156	PK
2	*	17355.000	52.585	29.586	-21.415	74.000	22.998	PK

Profile: 2032034R	Page No.: 34
Engineer: Neil	
Site: AC5	Time: 2020/06/19 - 02:39
Limit: FCC_Part15.209_RE(3m)	Margin: 0
Probe: Horn_3117_00167055(1-18GHz)	Polarity: Horizontal
EUT: Wireless Access Point	Power: AC 120V/60Hz
Note: Mode 7: Transmit at 5825MHz by 802.11ax(20MHz)	

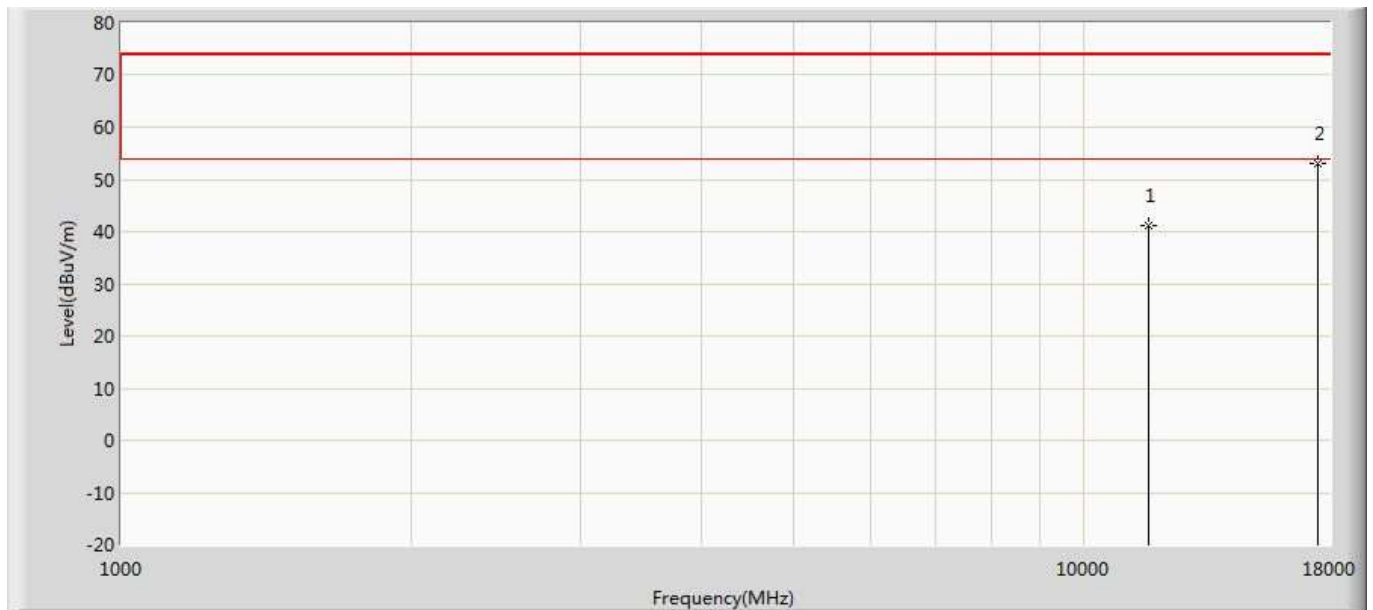

No	Mark	Frequency (MHz)	Measure Level (dBuV/m)	Reading Level (dBuV)	Over Limit (dB)	Limit (dBuV/m)	Factor (dB)	Type
1		11650.000	41.091	27.201	-32.909	74.000	13.889	PK
2	*	17475.000	53.125	31.542	-20.875	74.000	21.583	PK

Profile: 2032034R	Page No.: 35
Engineer: Neil	
Site: AC5	Time: 2020/06/19 - 02:39
Limit: FCC_Part15.209_RE(3m)	Margin: 0
Probe: Horn_3117_00167055(1-18GHz)	Polarity: Vertical
EUT: Wireless Access Point	Power: AC 120V/60Hz
Note: Mode 7:Transmit at 5825MHz by 802.11ax(20MHz)	

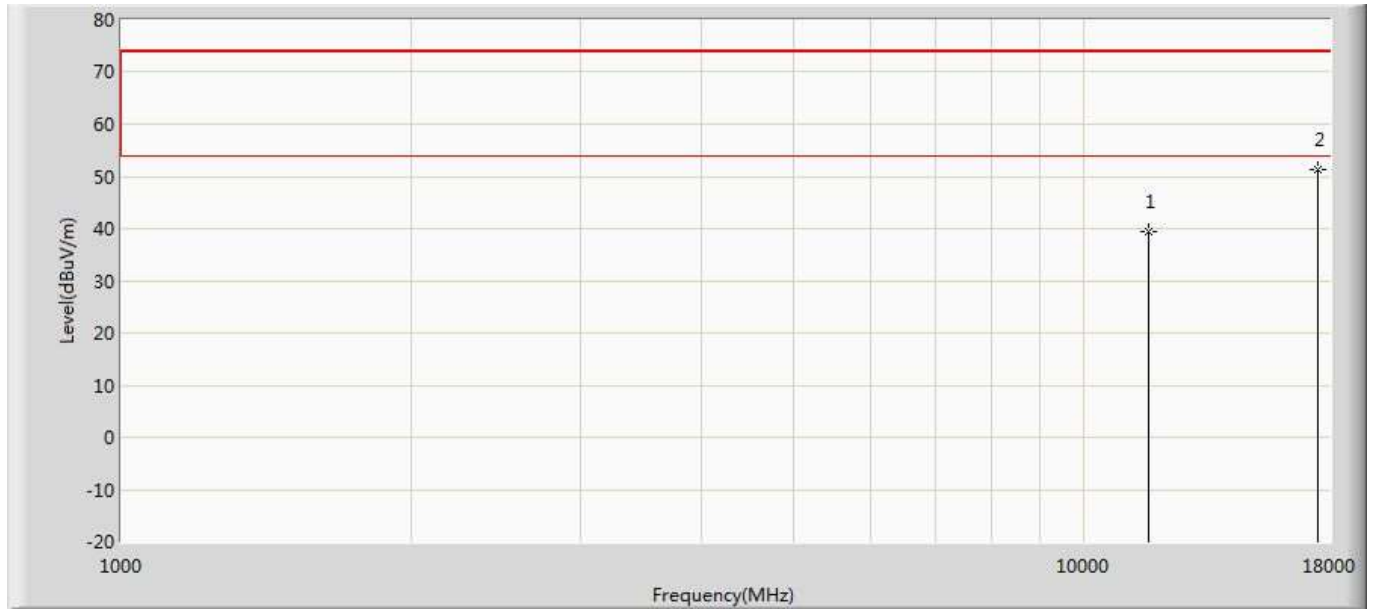

No	Mark	Frequency (MHz)	Measure Level (dBuV/m)	Reading Level (dBuV)	Over Limit (dB)	Limit (dBuV/m)	Factor (dB)	Type
1		11650.000	39.349	25.459	-34.651	74.000	13.889	PK
2	*	17475.000	51.298	29.715	-22.702	74.000	21.583	PK

Profile: 2032034R	Page No.: 36
Engineer: Neil	
Site: AC5	Time: 2020/06/19 - 02:40
Limit: FCC_Part15.209_RE(3m)	Margin: 0
Probe: Horn_3117_00167055(1-18GHz)	Polarity: Horizontal
EUT: Wireless Access Point	Power: AC 120V/60Hz
Note: Mode 8:Transmit at 5755MHz by 802.11ax(40MHz)	

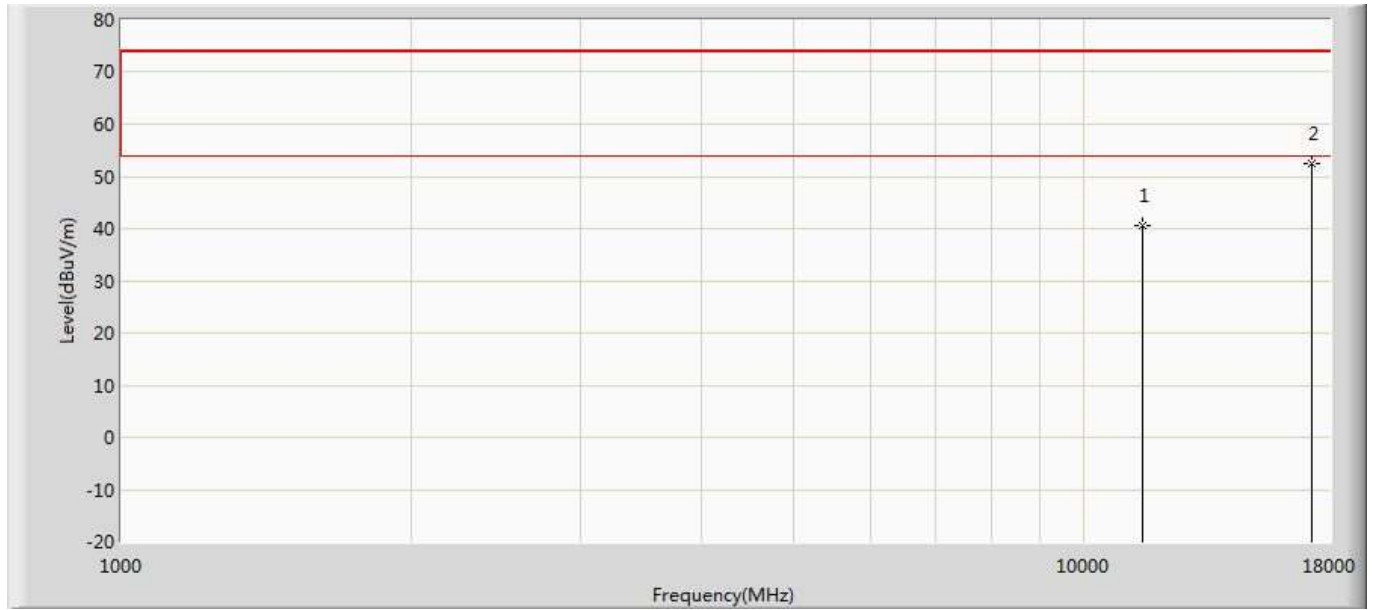

No	Mark	Frequency (MHz)	Measure Level (dBuV/m)	Reading Level (dBuV)	Over Limit (dB)	Limit (dBuV/m)	Factor (dB)	Type
1		11510.000	40.583	27.532	-33.417	74.000	13.051	PK
2	*	17265.000	52.383	31.655	-21.617	74.000	20.728	PK

Profile: 2032034R	Page No.: 37
Engineer: Neil	
Site: AC5	Time: 2020/06/19 - 02:40
Limit: FCC_Part15.209_RE(3m)	Margin: 0
Probe: Horn_3117_00167055(1-18GHz)	Polarity: Vertical
EUT: Wireless Access Point	Power: AC 120V/60Hz
Note: Mode 8:Transmit at 5755MHz by 802.11ax(40MHz)	

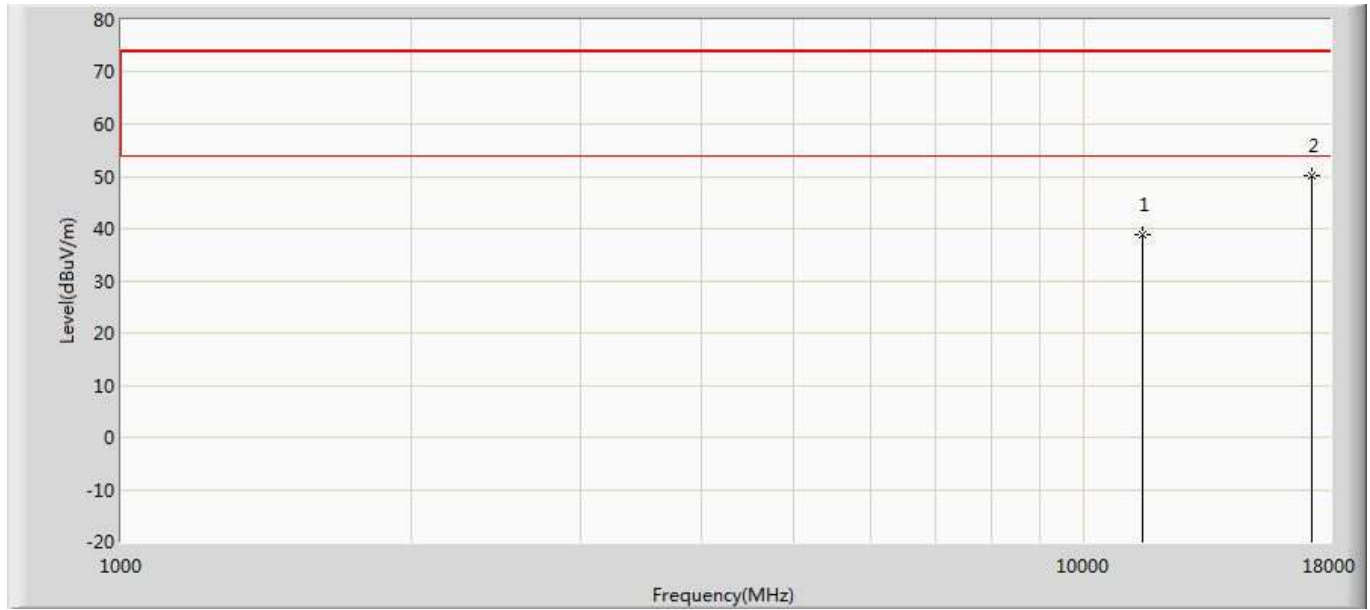

No	Mark	Frequency (MHz)	Measure Level (dBuV/m)	Reading Level (dBuV)	Over Limit (dB)	Limit (dBuV/m)	Factor (dB)	Type
1		11510.000	38.802	25.751	-35.198	74.000	13.051	PK
2	*	17265.000	50.020	29.292	-23.980	74.000	20.728	PK

Profile: 2032034R	Page No.: 38
Engineer: Neil	
Site: AC5	Time: 2020/06/19 - 02:40
Limit: FCC_Part15.209_RE(3m)	Margin: 0
Probe: Horn_3117_00167055(1-18GHz)	Polarity: Horizontal
EUT: Wireless Access Point	Power: AC 120V/60Hz
Note: Mode 8:Transmit at 5795MHz by 802.11ax(40MHz)	

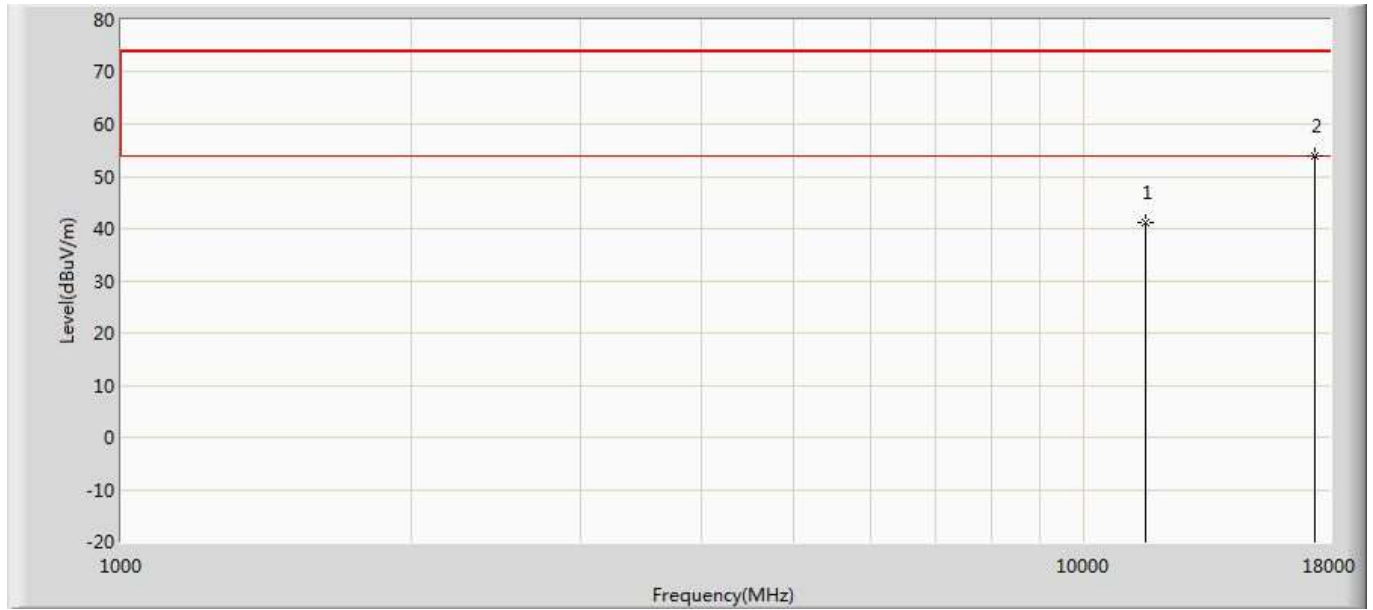

No	Mark	Frequency (MHz)	Measure Level (dBuV/m)	Reading Level (dBuV)	Over Limit (dB)	Limit (dBuV/m)	Factor (dB)	Type
1		11590.000	41.051	27.728	-32.949	74.000	13.324	PK
2	*	17385.000	53.839	31.664	-20.161	74.000	22.175	PK

Profile: 2032034R	Page No.: 39
Engineer: Neil	
Site: AC5	Time: 2020/06/19 - 02:40
Limit: FCC_Part15.209_RE(3m)	Margin: 0
Probe: Horn_3117_00167055(1-18GHz)	Polarity: Vertical
EUT: Wireless Access Point	Power: AC 120V/60Hz
Note: Mode 8:Transmit at 5795MHz by 802.11ax(40MHz)	

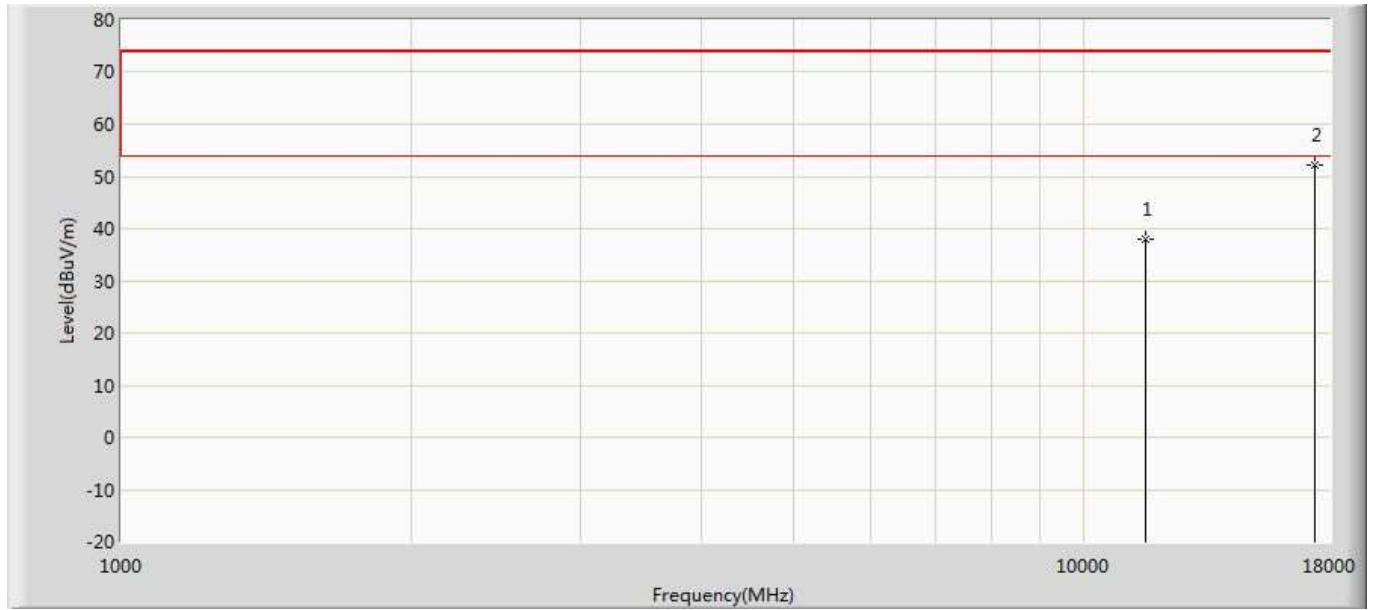

No	Mark	Frequency (MHz)	Measure Level (dBuV/m)	Reading Level (dBuV)	Over Limit (dB)	Limit (dBuV/m)	Factor (dB)	Type
1		11590.000	38.101	24.778	-35.899	74.000	13.324	PK
2	*	17385.000	52.068	29.893	-21.932	74.000	22.175	PK

Profile: 2032034R	Page No.: 40
Engineer: Neil	
Site: AC5	Time: 2020/06/19 - 02:41
Limit: FCC_Part15.209_RE(3m)	Margin: 0
Probe: Horn_3117_00167055(1-18GHz)	Polarity: Horizontal
EUT: Wireless Access Point	Power: AC 120V/60Hz
Note: Mode 9:Transmit at 5775MHz by 802.11ax(80MHz)	

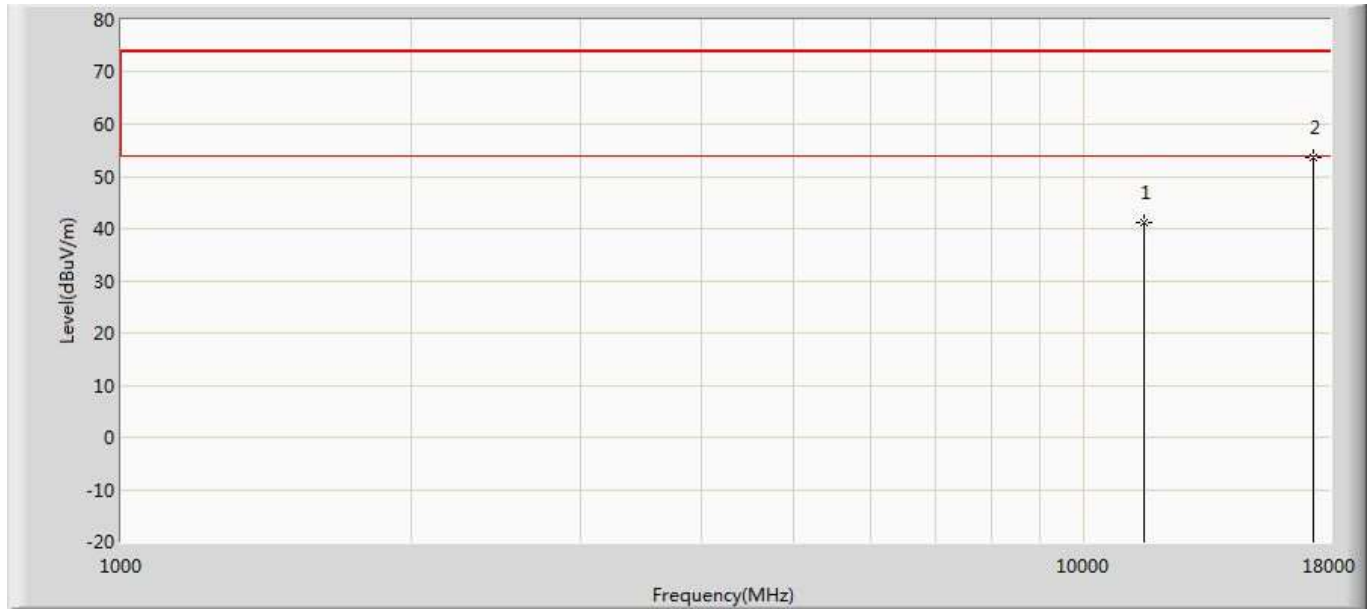

No	Mark	Frequency (MHz)	Measure Level (dBuV/m)	Reading Level (dBuV)	Over Limit (dB)	Limit (dBuV/m)	Factor (dB)	Type
1		11550.000	41.297	28.024	-32.703	74.000	13.272	PK
2	*	17325.000	53.668	31.388	-20.332	74.000	22.280	PK



Profile: 2032034R	Page No.: 41
Engineer: Neil	
Site: AC5	Time: 2020/06/19 - 02:41
Limit: FCC_Part15.209_RE(3m)	Margin: 0
Probe: Horn_3117_00167055(1-18GHz)	Polarity: Vertical
EUT: Wireless Access Point	Power: AC 120V/60Hz
Note: Mode 9:Transmit at 5775MHz by 802.11ax(80MHz)	

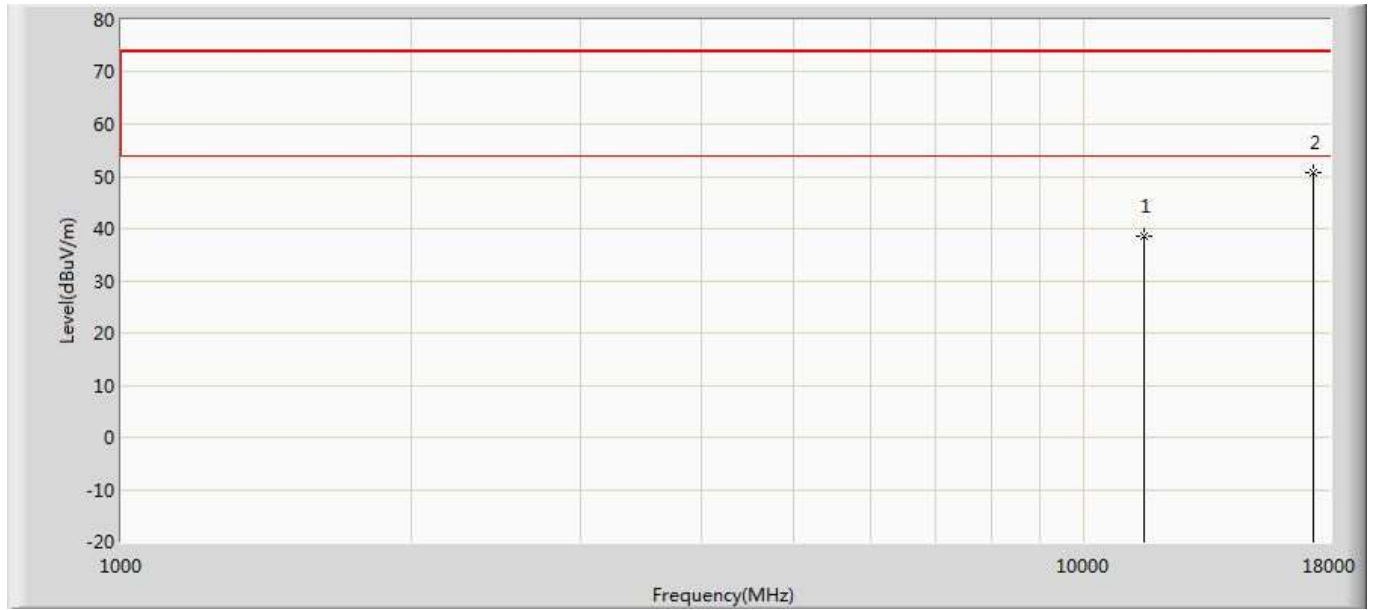

No	Mark	Frequency (MHz)	Measure Level (dBuV/m)	Reading Level (dBuV)	Over Limit (dB)	Limit (dBuV/m)	Factor (dB)	Type
1		11550.000	38.635	25.362	-35.365	74.000	13.272	PK
2	*	17325.000	50.605	28.325	-23.395	74.000	22.280	PK

## Appendix 2: 5GHz FCC RF output power

FCC 5GHz Power Table-Radio 1									
Standard:	FCC Part 15.407	Test Date:	2020.04.07	Temperature:	25°C	Humidity:	55%RH		
Project No. :	2032034R			Product Name:	Wireless Access Point	Model Name:	AP460SC	Test Site:	TR8
Antenna Gain(dBi)	Ant 4	6.46							
Test Eng:	Pawn								
Antenna Technology:	SISO								
Mode:	802.11a	Data Rate:	6Mbps	Conducted power					
				SISO mode					
				Ant 4			Total Power		Limit
Test Conditions		Channel	Frequency	Reading Level			Ant 4		
			(MHz)	Avg. (dBm)			Avg. (dBm)		Avg. (dBm) Pass/Fail
Tnom (25 °C)	Vnom (120V)	36	5180	16.04			16.04		29.54 Pass
		40	5200	16.13			16.13		29.54 Pass
		44	5220	16.14			16.14		29.54 Pass
		48	5240	16.17			16.17		29.54 Pass
		149	5745	19.63			19.63		29.54 Pass
		157	5785	19.59			19.59		29.54 Pass
		165	5825	19.39			19.39		29.54 Pass
Mode:	802.11n(20MHz)	Data Rate:	MCS0	Conducted power					
				SISO mode					
				Ant 4			Total Power		Limit
Test Conditions		Channel	Frequency	Reading Level			Ant 4		
			(MHz)	Avg. (dBm)			Avg. (dBm)		Avg. (dBm) Pass/Fail
Tnom (25 °C)	Vnom (120V)	36	5180	16.02			16.02		29.54 Pass
		40	5200	16.11			16.11		29.54 Pass
		44	5220	16.23			16.23		29.54 Pass
		48	5240	16.12			16.12		29.54 Pass
		149	5745	19.71			19.71		29.54 Pass
		157	5785	19.54			19.54		29.54 Pass
		165	5825	19.43			19.43		29.54 Pass
Mode:	802.11n(40MHz)	Data Rate:	MCS0	Conducted power					
				SISO mode					
				Ant 4			Total Power		Limit
Test Conditions		Channel	Frequency	Reading Level			Ant 4		
			(MHz)	Avg. (dBm)			Avg. (dBm)		Avg. (dBm) Pass/Fail
Tnom (25 °C)	Vnom (120V)	38	5190	15.98			15.98		29.54 Pass
		46	5230	15.84			15.84		29.54 Pass
		151	5755	19.66			19.66		29.54 Pass
		159	5795	19.64			19.64		29.54 Pass
Mode:	802.11ac(20MHz)	Data Rate:	MCS0NSS1	Conducted power					
				SISO mode					
				Ant 4			Total Power		Limit
			Frequency	Reading Level			Ant 4		



Test Conditions		Channel	(MHz)	Avg. (dBm)	Avg. (dBm)	Avg. (dBm)	Pass/Fail
Tnom (25 °C)	Vnom (120V)	36	5180	16.17	16.17	29.54	Pass
		40	5200	16.21	16.21	29.54	Pass
		44	5220	16.25	16.25	29.54	Pass
		48	5240	16.08	16.08	23.54	Pass
		149	5745	19.59	19.59	29.54	Pass
		157	5785	19.42	19.42	29.54	Pass
		165	5825	19.35	19.35	29.54	Pass
<b>Mode:</b>	<b>802.11ac(40MHz)</b>	<b>Data Rate:</b>	<b>MCS0NSS1</b>	<b>Conducted power SISO mode</b>			
<b>Test Conditions</b>		<b>Channel</b>	<b>Frequency</b>	<b>Ant 4 Reading Level</b>	<b>Total Power Ant 4</b>	<b>Limit</b>	
			(MHz)	Avg. (dBm)	Avg. (dBm)	Avg. (dBm)	Pass/Fail
Tnom (25 °C)	Vnom (120V)	38	5190	15.96	15.96	29.54	Pass
		46	5230	15.85	15.85	29.54	Pass
		151	5755	19.55	19.55	29.54	Pass
		159	5795	19.62	19.62	29.54	Pass
<b>Mode:</b>	<b>802.11ac(80MHz)</b>	<b>Data Rate:</b>	<b>MCS0NSS1</b>	<b>Conducted power SISO mode</b>			
<b>Test Conditions</b>		<b>Channel</b>	<b>Frequency</b>	<b>Ant 4 Reading Level</b>	<b>Total Power Ant 4</b>	<b>Limit</b>	
			(MHz)	Avg. (dBm)	Avg. (dBm)	Avg. (dBm)	Pass/Fail
Tnom (25 °C)	Vnom (120V)	42	5210	16.15	16.15	29.54	Pass
		155	5775	19.83	19.83	29.54	Pass
<b>Mode:</b>	<b>802.11ax(20MHz)</b>	<b>Data Rate:</b>	<b>HE0NSS1</b>	<b>Conducted power SISO mode</b>			
<b>Test Conditions</b>		<b>Channel</b>	<b>Frequency</b>	<b>Ant 4 Reading Level</b>	<b>Total Power Ant 4</b>	<b>Limit</b>	
			(MHz)	Avg. (dBm)	Avg. (dBm)	Avg. (dBm)	Pass/Fail
Tnom (25 °C)	Vnom (120V)	36	5180	16.13	16.13	29.54	Pass
		40	5200	16.18	16.18	29.54	Pass
		44	5220	16.30	16.30	29.54	Pass
		48	5240	16.07	16.07	29.54	Pass
		149	5745	19.61	19.61	29.54	Pass
		157	5785	19.43	19.43	29.54	Pass
		165	5825	19.42	19.42	29.54	Pass
<b>Mode:</b>	<b>802.11ax(40MHz)</b>	<b>Data Rate:</b>	<b>HE0NSS1</b>	<b>Conducted power SISO mode</b>			
<b>Test Conditions</b>		<b>Channel</b>	<b>Frequency</b>	<b>Ant 4 Reading Level</b>	<b>Total Power Ant 4</b>	<b>Limit</b>	
			(MHz)	Avg. (dBm)	Avg. (dBm)	Avg. (dBm)	Pass/Fail
Tnom (25 °C)	Vnom (120V)	38	5190	15.89	15.89	29.54	Pass
		46	5230	15.91	15.91	29.54	Pass
		151	5755	19.63	19.63	29.54	Pass
		159	5795	19.60	19.60	29.54	Pass
<b>Mode:</b>	<b>802.11ax(80MHz)</b>	<b>Data Rate:</b>	<b>HE0NSS1</b>	<b>Conducted power SISO mode</b>			
<b>Test Conditions</b>		<b>Channel</b>	<b>Frequency</b>	<b>Ant 4 Reading Level</b>	<b>Total Power Ant 4</b>	<b>Limit</b>	
			(MHz)	Avg. (dBm)	Avg. (dBm)	Avg. (dBm)	Pass/Fail

Tnom (25 °C)	Vnom (120V)	42	5210	16.22	16.22	29.54	Pass
		155	5775	19.76	19.76	29.54	Pass

## FCC 5GHz Power Table-Radio 2



Standard:	FCC Part 15.407	Test Date:	2020.04.07	Temperature:	25°C	Humidity:	55%RH
Project No. :	2032034R			Product Name:	Wireless Access Point	Model Name:	AP460SC
		Test Site:	TR8				
Antenna Gain(dBi)	Ant 1	7.77		Ant 2	7.79		
2*2 CDD-Directional Gain-Power(dBi)	7.79		2*2 BF-Directional Gain-Power(dBi)	10.80			

Test Eng:	Pawn						
Antenna Technology:	SISO						

Mode:	802.11a	Data Rate:	6Mbps	Conducted power SISO mode					
				Ant 1	Ant 2	Total Power		Limit	
		Channel	Frequency	Reading Level	Reading Level	Ant 1	Ant 2	Avg. (dBm)	Pass/Fail
			(MHz)	Avg. (dBm)	Avg. (dBm)	Avg. (dBm)	Avg. (dBm)	Avg. (dBm)	Pass/Fail
Tnom (25 °C)	Vnom (120V)	36	5180	14.60	14.86	14.60	14.86	28.21	Pass
		40	5200	14.82	14.98	14.82	14.98	28.21	Pass
		44	5220	14.74	15.07	14.74	15.07	28.21	Pass
		48	5240	14.58	14.93	14.58	14.93	28.21	Pass

Mode:	802.11n(20MHz)	Data Rate:	MCS0	Conducted power SISO mode					
				Ant 1	Ant 2	Total Power		Limit	
		Channel	Frequency	Reading Level	Reading Level	Ant 1	Ant 2	Avg. (dBm)	Pass/Fail
			(MHz)	Avg. (dBm)	Avg. (dBm)	Avg. (dBm)	Avg. (dBm)	Avg. (dBm)	Pass/Fail
Tnom (25 °C)	Vnom (120V)	36	5180	14.53	14.89	14.53	14.89	28.21	Pass
		40	5200	14.80	14.94	14.80	14.94	28.21	Pass
		44	5220	14.85	15.01	14.85	15.01	28.21	Pass
		48	5240	14.59	14.87	14.59	14.87	28.21	Pass

Mode:	802.11n(40MHz)	Data Rate:	MCS0	Conducted power SISO mode					
				Ant 1	Ant 2	Total Power		Limit	
		Channel	Frequency	Reading Level	Reading Level	Ant 1	Ant 2	Avg. (dBm)	Pass/Fail
			(MHz)	Avg. (dBm)	Avg. (dBm)	Avg. (dBm)	Avg. (dBm)	Avg. (dBm)	Pass/Fail
Tnom (25 °C)	Vnom (120V)	38	5190	14.39	14.73	14.39	14.73	28.21	Pass
		46	5230	14.78	15.04	14.78	15.04	28.21	Pass

Mode:	802.11ac(20MHz)	Data Rate:	MCS0NSS1	Conducted power SISO mode					
				Ant 1	Ant 2	Total Power		Limit	
		Channel	Frequency	Reading Level	Reading Level	Ant 1	Ant 2	Avg. (dBm)	Pass/Fail
			(MHz)	Avg. (dBm)	Avg. (dBm)	Avg. (dBm)	Avg. (dBm)	Avg. (dBm)	Pass/Fail
Tnom (25 °C)	Vnom (120V)	36	5180	14.56	14.85	14.56	14.85	28.21	Pass
		40	5200	14.76	14.93	14.76	14.93	28.21	Pass
		44	5220	14.82	15.02	14.82	15.02	28.21	Pass
		48	5240	14.52	14.80	14.52	14.80	28.21	Pass

Mode:	802.11ac(40MHz)	Data Rate:	MCS0NSS1	Conducted power SISO mode					
				Ant 1	Ant 2	Total Power		Limit	
		Channel	Frequency	Reading Level	Reading Level	Ant 1	Ant 2	Avg. (dBm)	Pass/Fail
			(MHz)	Avg. (dBm)	Avg. (dBm)	Avg. (dBm)	Avg. (dBm)	Avg. (dBm)	Pass/Fail
Tnom (25 °C)	Vnom (120V)	38	5190	14.44	14.69	14.44	14.69	28.21	Pass
		46	5230	14.77	14.98	14.77	14.98	28.21	Pass

Mode:	802.11ac(80MHz)	Data Rate:	MCS0NSS1	Conducted power SISO mode				
				Ant 1	Ant 2	Total Power		Limit

Test Conditions		Channel	Frequency (MHz)	Reading Level Avg. (dBm)	Reading Level Avg. (dBm)	Ant 1 Avg. (dBm)	Ant 2 Avg. (dBm)	Avg. (dBm)	Pass/Fail		
Tnom (25 °C)	Vnom (120V)	42	5210	14.77	14.96	14.77	14.96	28.21	Pass		
Mode:	802.11ax(20MHz)	Data Rate:	HE0NSS1	Conducted power SISO mode							
Test Conditions		Channel	Frequency (MHz)	Reading Level Avg. (dBm)	Reading Level Avg. (dBm)	Ant 1 Avg. (dBm)	Ant 2 Avg. (dBm)	Limit Avg. (dBm) Pass/Fail			
Tnom (25 °C)	Vnom (120V)	36	5180	14.50	14.76	14.50	14.76	28.21	Pass		
		40	5200	14.80	15.04	14.80	15.04	28.21	Pass		
		44	5220	14.70	15.10	14.70	15.10	28.21	Pass		
		48	5240	14.59	14.93	14.59	14.93	28.21	Pass		
Mode:	802.11ax(40MHz)	Data Rate:	HE0NSS1	Conducted power SISO mode							
Test Conditions		Channel	Frequency (MHz)	Reading Level Avg. (dBm)	Reading Level Avg. (dBm)	Ant 1 Avg. (dBm)	Ant 2 Avg. (dBm)	Limit Avg. (dBm) Pass/Fail			
Tnom (25 °C)	Vnom (120V)	38	5190	14.37	14.73	14.37	14.73	28.21	Pass		
		46	5230	14.76	14.97	14.76	14.97	28.21	Pass		
Mode:	802.11ax(80MHz)	Data Rate:	HE0NSS1	Conducted power SISO mode							
Test Conditions		Channel	Frequency (MHz)	Reading Level Avg. (dBm)	Reading Level Avg. (dBm)	Ant 1 Avg. (dBm)	Ant 2 Avg. (dBm)	Limit Avg. (dBm) Pass/Fail			
Tnom (25 °C)	Vnom (120V)	42	5210	14.73	14.92	14.73	14.92	28.21	Pass		

Antenna Technology:	CDD 2*2										
Mode:	802.11a	Data Rate:	6Mbps	Conducted power MIMO Mode(2TX+2RX)							
Test Conditions		Channel	Frequency (MHz)	Ant 1+2 Reading Level Avg. (dBm)		Total Power Avg. (dBm) (Ant 1+2)		Limit Avg. (dBm) Pass/Fail			
Tnom (25 °C)	Vnom (120V)	36	5180	11.45	11.21	14.34	28.21	Pass			
		40	5200	11.72	11.53	14.64	28.21	Pass			
		44	5220	11.96	11.51	14.75	28.21	Pass			
		48	5240	11.58	11.20	14.40	28.21	Pass			
Mode:	802.11n(20MHz)	Data Rate:	MCS0	Conducted power MIMO Mode(2TX+2RX)							
Test Conditions		Channel	Frequency (MHz)	Ant 1+2 Reading Level Avg. (dBm)		Total Power Avg. (dBm) (Ant 1+2)		Limit Avg. (dBm) Pass/Fail			
Tnom (25 °C)	Vnom (120V)	36	5180	11.41	11.17	14.30	28.21	Pass			
		40	5200	11.68	11.56	14.63	28.21	Pass			
		44	5220	11.91	11.59	14.76	28.21	Pass			
		48	5240	11.49	11.26	14.39	28.21	Pass			
Mode:	802.11n(40MHz)	Data Rate:	MCS0	Conducted power MIMO Mode(2TX+2RX)							
Test Conditions		Channel	Frequency (MHz)	Ant 1+2 Reading Level Avg. (dBm)		Total Power Avg. (dBm) (Ant 1+2)		Limit Avg. (dBm) Pass/Fail			
Tnom (25 °C)	Vnom (120V)	42	5210	14.73	14.92	14.73	14.92	28.21	Pass		

Tnom (25 °C)	Vnom (120V)	38	5190	11.70	11.51	14.62	28.21	Pass		
		46	5230	11.92	11.59	14.77	28.21	Pass		
Mode:	802.11ac(20MHz)	Data Rate:	MCS0NSS1	Conducted power						
				MIMO Mode(2TX+2RX)						
Test Conditions	Channel	Frequency	Ant 1+2		Total Power	Limit				
			Reading Level			Avg. (dBm)	Avg. (dBm)	Pass/Fail		
			Avg. (dBm)							
		(MHz)	Ant 1	Ant 2	Avg. (dBm)	Avg. (dBm)	Pass/Fail			
Tnom (25 °C)	Vnom (120V)	36	5180	11.51	11.30	14.42	28.21	Pass		
		40	5200	11.81	11.51	14.67	28.21	Pass		
		44	5220	11.85	11.54	14.71	28.21	Pass		
		48	5240	11.45	11.37	14.42	28.21	Pass		
Mode:	802.11ac(40MHz)	Data Rate:	MCS0NSS1	Conducted power						
				MIMO Mode(2TX+2RX)						
Test Conditions	Channel	Frequency	Ant 1+2		Total Power	Limit				
			Reading Level			Avg. (dBm)	Avg. (dBm)	Pass/Fail		
			Avg. (dBm)							
		(MHz)	Ant 1	Ant 2	Avg. (dBm)	Avg. (dBm)	Pass/Fail			
Tnom (25 °C)	Vnom (120V)	38	5190	11.57	11.38	14.49	28.21	Pass		
		46	5230	11.89	11.65	14.78	28.21	Pass		
Mode:	802.11ac(80MHz)	Data Rate:	MCS0NSS1	Conducted power						
				MIMO Mode(2TX+2RX)						
Test Conditions	Channel	Frequency	Ant 1+2		Total Power	Limit				
			Reading Level			Avg. (dBm)	Avg. (dBm)	Pass/Fail		
			Avg. (dBm)							
		(MHz)	Ant 1	Ant 2	Avg. (dBm)	Avg. (dBm)	Pass/Fail			
Tnom (25 °C)	Vnom (120V)	42	5210	11.63	11.43	14.54	28.21	Pass		
Mode:	802.11ax(20MHz)	Data Rate:	HE0NSS1	Conducted power						
				MIMO Mode(2TX+2RX)						
Test Conditions	Channel	Frequency	Ant 1+2		Total Power	Limit				
			Reading Level			Avg. (dBm)	Avg. (dBm)	Pass/Fail		
			Avg. (dBm)							
		(MHz)	Ant 1	Ant 2	Avg. (dBm)	Avg. (dBm)	Pass/Fail			
Tnom (25 °C)	Vnom (120V)	36	5180	11.53	11.24	14.40	28.21	Pass		
		40	5200	11.70	11.45	14.59	28.21	Pass		
		44	5220	11.91	11.55	14.74	28.21	Pass		
		48	5240	11.57	11.36	14.48	28.21	Pass		
Mode:	802.11ax(40MHz)	Data Rate:	HE0NSS1	Conducted power						
				MIMO Mode(2TX+2RX)						
Test Conditions	Channel	Frequency	Ant 1+2		Total Power	Limit				
			Reading Level			Avg. (dBm)	Avg. (dBm)	Pass/Fail		
			Avg. (dBm)							
		(MHz)	Ant 1	Ant 2	Avg. (dBm)	Avg. (dBm)	Pass/Fail			
Tnom (25 °C)	Vnom (120V)	38	5190	11.57	11.40	14.50	28.21	Pass		
		46	5230	11.94	11.62	14.79	28.21	Pass		
Mode:	802.11ax(80MHz)	Data Rate:	HE0NSS1	Conducted power						
				MIMO Mode(2TX+2RX)						
Test Conditions	Channel	Frequency	Ant 1+2		Total Power	Limit				
			Reading Level			Avg. (dBm)	Avg. (dBm)	Pass/Fail		
			Avg. (dBm)							
		(MHz)	Ant 1	Ant 2	Avg. (dBm)	Avg. (dBm)	Pass/Fail			
Tnom (25 °C)	Vnom (120V)	42	5210	11.61	11.49	14.56	28.21	Pass		

Antenna Technology:		Beamforming 2*2													
Mode:	802.11n(20MHz)	Data Rate:	MCS0	Conducted power											
				MIMO Mode(2TX+2RX)											
Test Conditions		Channel	Frequency	Ant 1+2				Total Power		Limit					
			Reading Level				Avg. (dBm)		Avg. (dBm)		Avg. (dBm)				
			Ant 1		Ant 2										
Tnom (25 °C)	Vnom (120V)	36	5180	8.60		8.36		11.49		25.20	Pass				
		40	5200	9.00		8.66		11.84		25.20	Pass				
		44	5220	9.24		8.73		12.00		25.20	Pass				
		48	5240	8.78		8.38		11.59		25.20	Pass				
Mode:	802.11n(40MHz)	Data Rate:	MCS0	Conducted power											
				MIMO Mode(2TX+2RX)											
Test Conditions		Channel	Frequency	Ant 1+2				Total Power		Limit					
			Reading Level				Avg. (dBm)		Avg. (dBm)		Avg. (dBm)				
			Ant 1		Ant 2										
Tnom (25 °C)	Vnom (120V)	38	5190	8.81		8.49		11.66		25.20	Pass				
		46	5230	9.12		8.86		12.00		25.20	Pass				
		Mode:	802.11ac(20MHz)	Data Rate:	MCS0NSS1	Conducted power									
						MIMO Mode(2TX+2RX)									
Test Conditions		Channel	Frequency	Ant 1+2				Total Power		Limit					
			Reading Level				Avg. (dBm)		Avg. (dBm)		Avg. (dBm)				
			Ant 1		Ant 2										
Tnom (25 °C)	Vnom (120V)	36	5180	8.65		8.44		11.56		25.20	Pass				
		40	5200	9.00		8.78		11.90		25.20	Pass				
		44	5220	9.11		8.62		11.88		25.20	Pass				
		48	5240	8.87		8.38		11.64		25.20	Pass				
Mode:	802.11ac(40MHz)	Data Rate:	MCS0NSS1	Conducted power											
				MIMO Mode(2TX+2RX)											
Test Conditions		Channel	Frequency	Ant 1+2				Total Power		Limit					
			Reading Level				Avg. (dBm)		Avg. (dBm)		Avg. (dBm)				
			Ant 1		Ant 2										
Tnom (25 °C)	Vnom (120V)	38	5190	8.65		8.55		11.61		25.20	Pass				
		46	5230	9.13		8.79		11.97		25.20	Pass				
		Mode:	802.11ac(80MHz)	Data Rate:	MCS0NSS1	Conducted power									
						MIMO Mode(2TX+2RX)									
Test Conditions		Channel	Frequency	Ant 1+2				Total Power		Limit					
			Reading Level				Avg. (dBm)		Avg. (dBm)		Avg. (dBm)				
			Ant 1		Ant 2										
Tnom (25 °C)	Vnom (120V)	42	5210	8.89		8.75		11.83		25.20	Pass				
Mode:	802.11ax(20MHz)	Data Rate:	HE0NSS1	Conducted power											
				MIMO Mode(2TX+2RX)											
Test Conditions		Channel	Frequency	Ant 1+2				Total Power		Limit					
			Reading Level				Avg. (dBm)		Avg. (dBm)		Avg. (dBm)				
			Ant 1		Ant 2										
Tnom (25 °C)	Vnom (120V)	36	5180	8.71		8.34		11.54		25.20	Pass				
		40	5200	8.89		8.82		11.87		25.20	Pass				
		44	5220	9.18		8.67		11.94		25.20	Pass				
		48	5240	8.79		8.29		11.56		25.20	Pass				



Mode:		802.11ax(40MHz)		Data Rate:		HE0NSS1		MIMO Mode(2TX+2RX)			
Test Conditions		Channel		Ant 1+2		Reading Level		Total Power		Limit	
				Frequency							
				Avg. (dBm)		Avg. (dBm (Ant 1+2))		Avg. (dBm)		Pass/Fail	
		(MHz)		Ant 1		Ant 2					
Tnom (25 °C)	Vnom (120V)	38	5190	8.65	8.66	11.67	25.20	Pass			
		46	5230	9.17	8.82	12.01	25.20	Pass			
Mode:		802.11ax(80MHz)		Data Rate:		HE0NSS1		Conducted power			
								MIMO Mode(2TX+2RX)			
Test Conditions		Channel		Ant 1+2		Reading Level		Total Power		Limit	
				Frequency							
				Avg. (dBm)		Avg. (dBm (Ant 1+2))		Avg. (dBm)		Pass/Fail	
		(MHz)		Ant 1		Ant 2					
Tnom (25 °C)	Vnom (120V)	42	5210	8.83	8.61	11.73	25.20	Pass			

# FCC 5GHz Power Table-Radio 3(5G Full band mode)



<b>Standard:</b>	FCC Part 15.407	<b>Test Date:</b>	2020.04.07	<b>Temperature:</b>	25°C		<b>Humidity:</b>	55%RH	
<b>Project No. :</b>	2032034R			<b>Product Name:</b>	Wireless Access Point	<b>Model Name:</b>	AP460SC	<b>Test Site:</b>	TR8
<b>Antenna Gain(dBi)</b>	<b>Ant 3</b>	7.84	<b>Ant 5</b>	8.06	<b>Ant 6</b>	7.91	<b>Ant 7</b>	7.65	
<b>2*2 CDD-Directional Gain-Power(dBi)</b>	8.06		<b>2*2 BF-Directional Gain-Power(dBi)</b>	11.07					
<b>4*4 CDD-Directional Gain-Power(dBi)</b>	8.06		<b>4*4 BF-Directional Gain-Power(dBi)</b>	14.08					

**Test Eng:** Pawn

**Antenna Technology:** CDD 2\*2

<b>Mode:</b>	802.11a	<b>Data Rate:</b>	6Mbps	<b>Conducted power MIMO Mode(2TX+2RX)</b>						
<b>Test Conditions</b>	<b>Channel</b>	<b>Frequency</b>		<b>Ant 3+5</b>		<b>Total Power</b>		<b>Limit</b>		
		<b>Reading Level</b>								
		<b>Avg. (dBm)</b>								
		<b>(MHz)</b>		<b>Ant3</b>		<b>Ant5</b>		<b>Avg. (dBm) (Ant 3+5)</b>	<b>Avg. (dBm)</b>	<b>Pass/Fail</b>
Tnom (25°C)	Vnom (120V)	36	5180	12.44		12.76		15.61	27.94	Pass
		40	5200	12.40		12.91		15.67	27.94	Pass
		44	5220	12.50		13.11		15.83	27.94	Pass
		48	5240	12.41		13.06		15.76	27.94	Pass
		149	5745	22.04		22.43		25.25	27.94	Pass
		157	5785	21.97		22.00		25.00	27.94	Pass
		165	5825	21.91		21.78		24.86	27.94	Pass

<b>Mode:</b>	802.11n(20MHz)	<b>Data Rate:</b>	MCS0	<b>Conducted power MIMO Mode(2TX+2RX)</b>						
<b>Test Conditions</b>	<b>Channel</b>	<b>Frequency</b>		<b>Ant 3+5</b>		<b>Total Power</b>		<b>Limit</b>		
		<b>Reading Level</b>								
		<b>Avg. (dBm)</b>								
		<b>(MHz)</b>		<b>Ant3</b>		<b>Ant5</b>		<b>Avg. (dBm) (Ant 3+5)</b>	<b>Avg. (dBm)</b>	<b>Pass/Fail</b>
Tnom (25°C)	Vnom (120V)	36	5180	12.33		12.86		15.61	27.94	Pass
		40	5200	12.38		13.04		15.73	27.94	Pass
		44	5220	12.54		13.10		15.84	27.94	Pass
		48	5240	12.38		13.04		15.73	27.94	Pass
		149	5745	22.01		22.45		25.25	27.94	Pass
		157	5785	21.97		22.08		25.04	27.94	Pass
		165	5825	21.88		21.78		24.84	27.94	Pass

<b>Mode:</b>	802.11n(40MHz)	<b>Data Rate:</b>	MCS0	<b>Conducted power MIMO Mode(2TX+2RX)</b>						
<b>Test Conditions</b>	<b>Channel</b>	<b>Frequency</b>		<b>Ant 3+5</b>		<b>Total Power</b>		<b>Limit</b>		
		<b>Reading Level</b>								
		<b>Avg. (dBm)</b>								
		<b>(MHz)</b>		<b>Ant3</b>		<b>Ant5</b>		<b>Avg. (dBm) (Ant 3+5)</b>	<b>Avg. (dBm)</b>	<b>Pass/Fail</b>
Tnom (25°C)	Vnom (120V)	38	5190	12.44		13.07		15.78	27.94	Pass
		46	5230	12.43		13.10		15.79	27.94	Pass
		151	5755	22.15		22.40		25.29	27.94	Pass
		159	5795	21.89		22.06		24.99	27.94	Pass

<b>Mode:</b>	802.11ac(20MHz)	<b>Data Rate:</b>	MCS0NSS1	<b>Conducted power MIMO Mode(2TX+2RX)</b>					
				<b>Ant 3+5</b>					

Test Conditions		Channel	Frequency	Reading Level		Total Power	Limit	
				Avg. (dBm)			Avg. (dBm) (Ant 3+5)	Avg. (dBm)
			(MHz)	Ant3	Ant5			
Tnom (25 °C)	Vnom (120V)	36	5180	12.42	12.72	15.58	27.94	Pass
		40	5200	12.25	13.01	15.66	27.94	Pass
		44	5220	12.44	12.97	15.72	27.94	Pass
		48	5240	12.32	13.00	15.68	27.94	Pass
		149	5745	22.01	22.41	25.22	27.94	Pass
		157	5785	21.96	22.06	25.02	27.94	Pass
		165	5825	21.91	21.80	24.87	27.94	Pass
Mode:	802.11ac(40MHz)	Data Rate:	MCS0NSS1	Conducted power MIMO Mode(2TX+2RX)				
Test Conditions		Channel	Frequency	Reading Level		Total Power	Limit	
				Avg. (dBm)			Avg. (dBm) (Ant 3+5)	Avg. (dBm)
			(MHz)	Ant3	Ant5			
Tnom (25 °C)	Vnom (120V)	38	5190	12.42	13.08	15.77	27.94	Pass
		46	5230	12.58	13.17	15.90	27.94	Pass
		151	5755	22.11	22.39	25.26	27.94	Pass
		159	5795	21.86	22.05	24.97	27.94	Pass
Mode:	802.11ac(80MHz)	Data Rate:	MCS0NSS1	Conducted power MIMO Mode(2TX+2RX)				
Test Conditions		Channel	Frequency	Reading Level		Total Power	Limit	
				Avg. (dBm)			Avg. (dBm) (Ant 3+5)	Avg. (dBm)
			(MHz)	Ant3	Ant5			
Tnom (25 °C)	Vnom (120V)	42	5210	12.27	12.65	15.47	27.94	Pass
		155	5775	15.93	16.21	19.08	27.94	Pass
Mode:	802.11ax(20MHz)	Data Rate:	HE0NSS1	Conducted power MIMO Mode(2TX+2RX)				
Test Conditions		Channel	Frequency	Reading Level		Total Power	Limit	
				Avg. (dBm)			Avg. (dBm) (Ant 3+5)	Avg. (dBm)
			(MHz)	Ant3	Ant5			
Tnom (25 °C)	Vnom (120V)	36	5180	12.40	12.73	15.58	27.94	Pass
		40	5200	12.39	12.98	15.71	27.94	Pass
		44	5220	12.44	13.13	15.81	27.94	Pass
		48	5240	12.31	13.09	15.73	27.94	Pass
		149	5745	22.04	22.43	25.25	27.94	Pass
		157	5785	21.95	22.00	24.99	27.94	Pass
		165	5825	21.92	21.79	24.87	27.94	Pass
Mode:	802.11ax(40MHz)	Data Rate:	HE0NSS1	Conducted power MIMO Mode(2TX+2RX)				
Test Conditions		Channel	Frequency	Reading Level		Total Power	Limit	
				Avg. (dBm)			Avg. (dBm) (Ant 3+5)	Avg. (dBm)
			(MHz)	Ant3	Ant5			
Tnom (25 °C)	Vnom (120V)	38	5190	12.44	12.92	15.70	27.94	Pass
		46	5230	12.60	13.15	15.89	27.94	Pass
		151	5755	22.11	22.42	25.28	27.94	Pass
		159	5795	21.89	22.05	24.98	27.94	Pass

Mode:	802.11ax(80MHz)	Data Rate:	HE0NSS1	Conducted power						
				MIMO Mode(2TX+2RX)						
Test Conditions		Channel	Frequency	Ant 3+5		Ant 3+5		Total Power	Limit	
			(MHz)	Reading Level	Avg. (dBm)	Reading Level	Avg. (dBm)		Avg. (dBm)	Avg. (dBm)
Tnom (25 °C)	Vnom (120V)	42	5210	12.21	12.59	15.41	27.94	27.94	Pass	
		155	5775	15.96	16.18	19.08	27.94	27.94	Pass	

Antenna Technology:		CDD 4*4								
Mode:	802.11a	Data Rate:	6Mbps	Conducted power						
				MIMO Mode(4TX+4RX)						
Test Conditions		Channel	Frequency	Ant3	Ant5	Ant6	Ant7	Total Power	Limit	
			(MHz)	Reading Level	Reading Level	Reading Level	Reading Level		Avg. (dBm)	Avg. (dBm)
Tnom (25 °C)	Vnom (120V)	36	5180	9.41	9.81	9.27	9.56	15.54	27.94	Pass
		40	5200	9.25	10.05	9.34	9.84	15.65	27.94	Pass
		44	5220	9.58	9.96	9.60	9.98	15.80	27.94	Pass
		48	5240	9.40	10.00	9.42	9.82	15.69	27.94	Pass
		149	5745	21.04	21.48	21.58	21.51	27.43	27.94	Pass
		157	5785	20.97	21.11	21.31	21.17	27.16	27.94	Pass
		165	5825	20.93	20.88	20.91	20.81	26.90	27.94	Pass

Mode:	802.11n(20MHz)	Data Rate:	MCS0	Conducted power						
				MIMO Mode(4TX+4RX)						
Test Conditions		Channel	Frequency	Ant3	Ant5	Ant6	Ant7	Total Power	Limit	
			(MHz)	Reading Level	Reading Level	Reading Level	Reading Level		Avg. (dBm)	Avg. (dBm)
Tnom (25 °C)	Vnom (120V)	36	5180	9.47	9.73	9.37	9.62	15.57	27.94	Pass
		40	5200	9.28	9.98	9.35	9.91	15.66	27.94	Pass
		44	5220	9.58	10.15	9.48	10.07	15.85	27.94	Pass
		48	5240	9.32	10.00	9.35	9.77	15.64	27.94	Pass
		149	5745	21.10	21.51	21.60	21.52	27.46	27.94	Pass
		157	5785	20.98	21.09	21.30	21.16	27.15	27.94	Pass
		165	5825	20.91	20.90	20.99	20.79	26.92	27.94	Pass

Mode:	802.11n(40MHz)	Data Rate:	MCS0	Conducted power						
				MIMO Mode(4TX+4RX)						
Test Conditions		Channel	Frequency	Ant3	Ant5	Ant6	Ant7	Total Power	Limit	
			(MHz)	Reading Level	Reading Level	Reading Level	Reading Level		Avg. (dBm)	Avg. (dBm)
Tnom (25 °C)	Vnom (120V)	38	5190	9.54	10.07	9.88	10.14	15.93	27.94	Pass
		46	5230	9.60	10.12	10.04	10.13	16.00	27.94	Pass
		151	5755	21.22	21.53	21.68	21.55	27.52	27.94	Pass
		159	5795	20.91	21.12	21.22	21.17	27.13	27.94	Pass

Mode:	802.11ac(20MHz)	Data Rate:	MCS0NSS1	Conducted power						
				MIMO Mode(4TX+4RX)						
Test Conditions		Channel	Frequency	Ant3	Ant5	Ant6	Ant7	Total Power	Limit	
			(MHz)	Reading Level	Reading Level	Reading Level	Reading Level		Avg. (dBm)	Avg. (dBm)

Test Conditions		Channel	Reading Level		Reading Level		Reading Level		Reading Level		Avg. (dBm) (Ant 3+5+6+7)	Avg. (dBm)	Pass/Fail
			(MHz)	Avg. (dBm)	Avg. (dBm)	Avg. (dBm)	Avg. (dBm)	Avg. (dBm)					
Tnom (25 °C)	Vnom (120V)	36	5180	9.40	9.73	9.34	9.51	15.52	27.94	Pass			
		40	5200	9.39	10.02	9.46	9.94	15.73	27.94	Pass			
		44	5220	9.54	10.11	9.67	9.91	15.83	27.94	Pass			
		48	5240	9.24	10.07	9.36	9.68	15.62	27.94	Pass			
		149	5745	21.11	21.57	21.59	21.49	27.46	27.94	Pass			
		157	5785	21.02	21.14	21.32	21.18	27.19	27.94	Pass			
		165	5825	20.99	20.95	20.89	20.90	26.95	27.94	Pass			
Mode:	802.11ac(40MHz)	Data Rate:	MCS0NSS1	Conducted power MIMO Mode(4TX+4RX)									
Test Conditions		Channel	Frequency	Ant3	Ant5	Ant6	Ant7	Total Power		Limit			
				Reading Level	Reading Level	Reading Level	Reading Level						
			(MHz)	Avg. (dBm)	Avg. (dBm)	Avg. (dBm)	Avg. (dBm)	Avg. (dBm) (Ant 3+5+6+7)		Avg. (dBm)	Pass/Fail		
Tnom (25 °C)	Vnom (120V)	38	5190	9.46	9.97	9.84	10.23	15.90		27.94	Pass		
		46	5230	9.49	10.09	10.05	10.10	15.96		27.94	Pass		
		151	5755	21.15	21.51	21.68	21.45	27.47		27.94	Pass		
		159	5795	20.96	21.16	21.22	21.09	27.13		27.94	Pass		
Mode:	802.11ac(80MHz)	Data Rate:	MCS0NSS1	Conducted power MIMO Mode(4TX+4RX)									
Test Conditions		Channel	Frequency	Ant3	Ant5	Ant6	Ant7	Total Power		Limit			
				Reading Level	Reading Level	Reading Level	Reading Level						
			(MHz)	Avg. (dBm)	Avg. (dBm)	Avg. (dBm)	Avg. (dBm)	Avg. (dBm) (Ant 3+5+6+7)		Avg. (dBm)	Pass/Fail		
Tnom (25 °C)	Vnom (120V)	42	5210	9.03	9.52	9.46	9.61	15.43		27.94	Pass		
		155	5775	14.52	14.68	14.56	15.01	20.72		27.94	Pass		
Mode:	802.11ax(20MHz)	Data Rate:	HE0NSS1	Conducted power MIMO Mode(4TX+4RX)									
Test Conditions		Channel	Frequency	Ant3	Ant5	Ant6	Ant7	Total Power		Limit			
				Reading Level	Reading Level	Reading Level	Reading Level						
			(MHz)	Avg. (dBm)	Avg. (dBm)	Avg. (dBm)	Avg. (dBm)	Avg. (dBm) (Ant 3+5+6+7)		Avg. (dBm)	Pass/Fail		
Tnom (25 °C)	Vnom (120V)	36	5180	9.32	9.87	9.40	9.57	15.57		27.94	Pass		
		40	5200	9.37	10.02	9.46	9.95	15.73		27.94	Pass		
		44	5220	9.46	10.11	9.60	10.07	15.84		27.94	Pass		
		48	5240	9.31	9.91	9.36	9.75	15.61		27.94	Pass		
		149	5745	21.05	21.52	21.59	21.56	27.46		27.94	Pass		
		157	5785	21.07	21.09	21.31	21.18	27.18		27.94	Pass		
		165	5825	20.91	20.97	20.91	20.91	26.95		27.94	Pass		
Mode:	802.11ax(40MHz)	Data Rate:	HE0NSS1	Conducted power MIMO Mode(4TX+4RX)									
Test Conditions		Channel	Frequency	Ant3	Ant5	Ant6	Ant7	Total Power		Limit			
				Reading Level	Reading Level	Reading Level	Reading Level						
			(MHz)	Avg. (dBm)	Avg. (dBm)	Avg. (dBm)	Avg. (dBm)	Avg. (dBm) (Ant 3+5+6+7)		Avg. (dBm)	Pass/Fail		
Tnom (25 °C)	Vnom (120V)	38	5190	9.55	9.93	9.81	10.23	15.91		27.94	Pass		
		46	5230	9.48	10.22	9.91	10.20	15.98		27.94	Pass		
		151	5755	21.23	21.50	21.60	21.46	27.47		27.94	Pass		
		159	5795	20.92	21.07	21.21	21.10	27.10		27.94	Pass		
Conducted power													



Test Conditions		Channel	(MHz)	Ant3	Ant5	Avg. (dBm (Ant 3+5))	Avg. (dBm)	Pass/Fail
Tnom (25 °C)	Vnom (120V)	38	5190	9.35	10.06	12.73	24.93	Pass
		46	5230	9.64	10.24	12.96	24.93	Pass
		151	5755	21.51	21.80	24.67	24.93	Pass
		159	5795	21.33	21.41	24.38	24.93	Pass
Mode:	802.11ac(80MHz)	Data Rate:	MCS0NSS1	Conducted power MIMO Mode(2TX+2RX)				
Test Conditions	Channel	Frequency	Ant 3+5			Total Power	Limit	
			Reading Level				Avg. (dBm (Ant 3+5))	Avg. (dBm)
		(MHz)	Ant3	Ant5				
Tnom (25 °C)	Vnom (120V)	42	5210	9.83	10.08	12.97	24.93	Pass
		155	5775	15.89	16.13	19.02	24.93	Pass
Mode:	802.11ax(20MHz)	Data Rate:	HE0NSS1	Conducted power MIMO Mode(2TX+2RX)				
Test Conditions	Channel	Frequency	Ant 3+5			Total Power	Limit	
			Reading Level				Avg. (dBm (Ant 3+5))	Avg. (dBm)
		(MHz)	Ant3	Ant5				
Tnom (25 °C)	Vnom (120V)	36	5180	9.38	9.82	12.62	24.93	Pass
		40	5200	9.43	9.86	12.66	24.93	Pass
		44	5220	9.50	10.18	12.86	24.93	Pass
		48	5240	9.40	10.13	12.79	24.93	Pass
		149	5745	21.42	21.79	24.62	24.93	Pass
		157	5785	21.37	21.46	24.43	24.93	Pass
		165	5825	21.28	21.23	24.27	24.93	Pass
Mode:	802.11ax(40MHz)	Data Rate:	HE0NSS1	Conducted power MIMO Mode(2TX+2RX)				
Test Conditions	Channel	Frequency	Ant 3+5			Total Power	Limit	
			Reading Level				Avg. (dBm (Ant 3+5))	Avg. (dBm)
		(MHz)	Ant3	Ant5				
Tnom (25 °C)	Vnom (120V)	38	5190	9.39	10.02	12.73	24.93	Pass
		46	5230	9.56	10.13	12.86	24.93	Pass
		151	5755	21.54	21.78	24.67	24.93	Pass
		159	5795	21.22	21.52	24.38	24.93	Pass
Mode:	802.11ax(80MHz)	Data Rate:	HE0NSS1	Conducted power MIMO Mode(2TX+2RX)				
Test Conditions	Channel	Frequency	Ant 3+5			Total Power	Limit	
			Reading Level				Avg. (dBm (Ant 3+5))	Avg. (dBm)
		(MHz)	Ant3	Ant5				
Tnom (25 °C)	Vnom (120V)	42	5210	9.77	10.15	12.97	24.93	Pass
		155	5775	15.90	16.15	19.04	24.93	Pass

Antenna Technology:	Beamforming 4*4							
Mode:	802.11n(20MHz)	Data Rate:	MCS0	Conducted power MIMO Mode(4TX+4RX)				
				Ant 3+5+6+7				

Test Conditions		Channel	Frequency	Ant3	Ant5	Ant6	Ant7	Total Power		Limit	
				Reading Level	Reading Level	Reading Level	Reading Level				
			(MHz)	Avg. (dBm)	Avg. (dBm)	Avg. (dBm)	Avg. (dBm)	Avg. (dBm)	Avg. (dBm)	Avg. (dBm)	Pass/Fail
Tnom (25 °C)	Vnom (120V)	36	5180	3.40	3.82	3.21	3.53	9.52	21.92	Pass	
		40	5200	3.17	4.05	3.35	3.73	9.61	21.92	Pass	
		44	5220	3.45	3.97	3.50	3.98	9.75	21.92	Pass	
		48	5240	3.33	3.97	3.35	3.84	9.65	21.92	Pass	
		149	5745	14.98	15.46	15.54	15.51	21.40	21.92	Pass	
		157	5785	14.89	15.08	15.31	15.17	21.14	21.92	Pass	
		165	5825	14.96	14.91	14.87	14.85	20.92	21.92	Pass	
Mode:	802.11n(40MHz)	Data Rate:	MCS0	Conducted power MIMO Mode(4TX+4RX)							
				Ant 3+5+6+7							
Test Conditions		Channel	Frequency	Ant3	Ant5	Ant6	Ant7	Total Power		Limit	
				Reading Level	Reading Level	Reading Level	Reading Level				
			(MHz)	Avg. (dBm)	Avg. (dBm)	Avg. (dBm)	Avg. (dBm)	Avg. (dBm)	Avg. (dBm)	Avg. (dBm)	Pass/Fail
Tnom (25 °C)	Vnom (120V)	38	5190	3.44	3.86	3.72	4.11	9.81	21.92	Pass	
		46	5230	3.43	4.10	3.90	4.13	9.92	21.92	Pass	
		151	5755	15.22	15.54	15.60	15.52	21.49	21.92	Pass	
		159	5795	14.93	15.10	15.19	15.11	21.10	21.92	Pass	
Mode:	802.11ac(20MHz)	Data Rate:	MCS0NSS1	Conducted power MIMO Mode(4TX+4RX)							
				Ant 3+5+6+7							
Test Conditions		Channel	Frequency	Ant3	Ant5	Ant6	Ant7	Total Power		Limit	
				Reading Level	Reading Level	Reading Level	Reading Level				
			(MHz)	Avg. (dBm)	Avg. (dBm)	Avg. (dBm)	Avg. (dBm)	Avg. (dBm)	Avg. (dBm)	Avg. (dBm)	Pass/Fail
Tnom (25 °C)	Vnom (120V)	36	5180	3.37	3.79	3.21	3.43	9.48	21.92	Pass	
		40	5200	3.19	3.97	3.26	3.76	9.58	21.92	Pass	
		44	5220	3.58	3.91	3.57	3.88	9.76	21.92	Pass	
		48	5240	3.32	4.00	3.43	3.70	9.64	21.92	Pass	
		149	5745	14.97	15.50	15.54	15.45	21.39	21.92	Pass	
		157	5785	14.93	15.13	15.24	15.17	21.14	21.92	Pass	
		165	5825	14.85	14.86	14.87	14.79	20.86	21.92	Pass	
Mode:	802.11ac(40MHz)	Data Rate:	MCS0NSS1	Conducted power MIMO Mode(4TX+4RX)							
				Ant 3+5+6+7							
Test Conditions		Channel	Frequency	Ant3	Ant5	Ant6	Ant7	Total Power		Limit	
				Reading Level	Reading Level	Reading Level	Reading Level				
			(MHz)	Avg. (dBm)	Avg. (dBm)	Avg. (dBm)	Avg. (dBm)	Avg. (dBm)	Avg. (dBm)	Avg. (dBm)	Pass/Fail
Tnom (25 °C)	Vnom (120V)	38	5190	3.43	3.82	3.71	4.25	9.83	21.92	Pass	
		46	5230	3.45	4.15	3.81	4.08	9.90	21.92	Pass	
		151	5755	15.15	15.49	15.60	15.55	21.47	21.92	Pass	
		159	5795	14.90	15.10	15.15	15.10	21.08	21.92	Pass	
Mode:	802.11ac(80MHz)	Data Rate:	MCS0NSS1	Conducted power MIMO Mode(4TX+4RX)							
				Ant 3+5+6+7							
Test Conditions		Channel	Frequency	Ant3	Ant5	Ant6	Ant7	Total Power		Limit	
				Reading Level	Reading Level	Reading Level	Reading Level				
			(MHz)	Avg. (dBm)	Avg. (dBm)	Avg. (dBm)	Avg. (dBm)	Avg. (dBm)	Avg. (dBm)	Avg. (dBm)	Pass/Fail
Tnom (25 °C)	Vnom (120V)	42	5210	3.68	4.22	3.92	4.07	10.00	21.92	Pass	
		155	5775	14.51	14.59	14.61	14.92	20.68	21.92	Pass	



Mode:	802.11ax(20MHz)	Data Rate:	HE0NSS1	Conducted power						
				MIMO Mode(4TX+4RX)						
Test Conditions		Channel	Ant 3+5+6+7				Total Power	Limit		
			Frequency	Ant3	Ant5	Ant6		Ant7	Avg. (dBm)	Avg. (dBm)
			(MHz)	Reading Level	Reading Level	Reading Level	Reading Level	Avg. (dBm)		
Tnom (25 °C)	Vnom (120V)	36	5180	3.39	3.78	3.21	3.50	9.50	21.92	Pass
		40	5200	3.16	3.98	3.20	3.71	9.55	21.92	Pass
		44	5220	3.45	3.83	3.49	3.99	9.72	21.92	Pass
		48	5240	3.27	3.91	3.28	3.78	9.59	21.92	Pass
		149	5745	15.03	15.47	15.60	15.48	21.42	21.92	Pass
		157	5785	14.96	15.10	15.25	15.14	21.13	21.92	Pass
		165	5825	14.86	14.80	14.86	14.83	20.86	21.92	Pass
Mode:	802.11ax(40MHz)	Data Rate:	HE0NSS1	Conducted power						
				MIMO Mode(4TX+4RX)						
Test Conditions		Channel	Ant 3+5+6+7				Total Power	Limit		
			Frequency	Ant3	Ant5	Ant6		Ant7	Avg. (dBm)	Avg. (dBm)
			(MHz)	Reading Level	Reading Level	Reading Level	Reading Level	Avg. (dBm)		
Tnom (25 °C)	Vnom (120V)	38	5190	3.48	3.83	3.74	4.22	9.85	21.92	Pass
		46	5230	3.34	4.21	3.80	4.20	9.92	21.92	Pass
		151	5755	15.20	15.53	15.66	15.49	21.49	21.92	Pass
		159	5795	14.86	15.04	15.18	15.18	21.09	21.92	Pass
Mode:	802.11ax(80MHz)	Data Rate:	HE0NSS1	Conducted power						
				MIMO Mode(4TX+4RX)						
Test Conditions		Channel	Ant 3+5+6+7				Total Power	Limit		
			Frequency	Ant3	Ant5	Ant6		Ant7	Avg. (dBm)	Avg. (dBm)
			(MHz)	Reading Level	Reading Level	Reading Level	Reading Level	Avg. (dBm)		
Tnom (25 °C)	Vnom (120V)	42	5210	3.61	4.16	3.92	4.21	10.00	21.92	Pass
		155	5775	14.53	14.56	14.64	14.94	20.69	21.92	Pass

# FCC 5GHz Power Table-Radio 3(5G High band mode)



Standard:	FCC Part 15.407	Test Date:	2020.04.07	Temperature:	25°C	Humidity:	55%RH		
Project No. :	2032034R			Product Name:	Wireless Access Point	Model Name:	AP460SC	Test Site:	TR8
Antenna Gain(dBi)	Ant 3	7.84	Ant 5	8.06	Ant 6	7.91	Ant 7	7.65	
2*2 CDD-Directional Gain-Power(dBi)	8.06			2*2 BF-Directional Gain-Power(dBi)	11.07				
4*4 CDD-Directional Gain-Power(dBi)	8.06			4*4 BF-Directional Gain-Power(dBi)	14.08				

Test Eng: Pawn

Antenna Technology: CDD 2\*2

Mode:		802.11a	Data Rate:	6Mbps	Conducted power MIMO Mode(2TX+2RX)				
Test Conditions		Channel	Frequency	Ant 3+5 Reading Level Avg. (dBm)		Total Power		Limit	
			(MHz)	Ant3	Ant5	Avg. (dBm)		Avg. (dBm)	Pass/Fail
Tnom (25 °C)	Vnom (120V)	149	5745	21.58	21.91	24.76		27.94	Pass
		157	5785	21.47	21.48	24.49		27.94	Pass
		165	5825	21.36	21.24	24.31		27.94	Pass
Mode:		802.11n(20MHz)	Data Rate:	MCS0	Conducted power MIMO Mode(2TX+2RX)				
Test Conditions		Channel	Frequency	Ant 3+5 Reading Level Avg. (dBm)		Total Power		Limit	
			(MHz)	Ant3	Ant5	Avg. (dBm)		Avg. (dBm)	Pass/Fail
Tnom (25 °C)	Vnom (120V)	149	5745	21.47	21.92	24.71		27.94	Pass
		157	5785	21.40	21.62	24.52		27.94	Pass
		165	5825	21.38	21.22	24.31		27.94	Pass
Mode:		802.11n(40MHz)	Data Rate:	MCS0	Conducted power MIMO Mode(2TX+2RX)				
Test Conditions		Channel	Frequency	Ant 3+5 Reading Level Avg. (dBm)		Total Power		Limit	
			(MHz)	Ant3	Ant5	Avg. (dBm)		Avg. (dBm)	Pass/Fail
Tnom (25 °C)	Vnom (120V)	151	5755	21.64	21.91	24.79		27.94	Pass
		159	5795	21.41	21.57	24.50		27.94	Pass
Mode:		802.11ac(20MHz)	Data Rate:	MCS0NSS1	Conducted power MIMO Mode(2TX+2RX)				
Test Conditions		Channel	Frequency	Ant 3+5 Reading Level Avg. (dBm)		Total Power		Limit	
			(MHz)	Ant3	Ant5	Avg. (dBm)		Avg. (dBm)	Pass/Fail
Tnom (25 °C)	Vnom (120V)	149	5745	21.47	21.85	24.67		27.94	Pass
		157	5785	21.49	21.52	24.52		27.94	Pass
		165	5825	21.36	21.33	24.36		27.94	Pass
Mode:		802.11ac(40MHz)	Data Rate:	MCS0NSS1	Conducted power MIMO Mode(2TX+2RX)				
Test Conditions		Channel	Frequency	Ant 3+5 Reading Level Avg. (dBm)		Total Power		Limit	
			(MHz)	Ant3	Ant5	Avg. (dBm)		Avg. (dBm)	Pass/Fail
Tnom (25 °C)	Vnom (120V)	151	5755	21.62	21.85	24.75		27.94	Pass

Tnom (25 °C)	Vnom (120V)	159	5795	21.31	21.58	24.46	27.94	Pass	
Mode:	802.11ac(80MHz)	Data Rate:	MCS0NSS1	Conducted power					
				MIMO Mode(2TX+2RX)					
Test Conditions	Channel	Frequency	Ant 3+5				Total Power	Limit	
			Reading Level						
			Avg. (dBm)						
Tnom (25 °C)	Vnom (120V)	155	5775	Ant3		Ant5		Pass/Fail	
				Avg. (dBm)		Avg. (dBm)			
				15.96		16.22		19.10	
Mode:	802.11ax(20MHz)	Data Rate:	HE0NSS1	Conducted power					
				MIMO Mode(2TX+2RX)					
Test Conditions	Channel	Frequency	Ant 3+5				Total Power	Limit	
			Reading Level						
			Avg. (dBm)						
Tnom (25 °C)	Vnom (120V)	149	5745	Ant3		Ant5		Pass/Fail	
				Avg. (dBm)		Avg. (dBm)			
				21.50		21.95		24.74	
Tnom (25 °C)	Vnom (120V)	157	5785	Ant3		Ant5		Pass/Fail	
				Avg. (dBm)		Avg. (dBm)			
				21.44		21.43		24.45	
Tnom (25 °C)	Vnom (120V)	165	5825	Ant3		Ant5		Pass/Fail	
				Avg. (dBm)		Avg. (dBm)			
				21.35		21.27		24.32	
Mode:	802.11ax(40MHz)	Data Rate:	HE0NSS1	Conducted power					
				MIMO Mode(2TX+2RX)					
Test Conditions	Channel	Frequency	Ant 3+5				Total Power	Limit	
			Reading Level						
			Avg. (dBm)						
Tnom (25 °C)	Vnom (120V)	151	5755	Ant3		Ant5		Pass/Fail	
				Avg. (dBm)		Avg. (dBm)			
				21.58		21.91		24.76	
Tnom (25 °C)	Vnom (120V)	159	5795	Ant3		Ant5		Pass/Fail	
				Avg. (dBm)		Avg. (dBm)			
				21.37		21.56		24.48	
Mode:	802.11ax(80MHz)	Data Rate:	HE0NSS1	Conducted power					
				MIMO Mode(2TX+2RX)					
Test Conditions	Channel	Frequency	Ant 3+5				Total Power	Limit	
			Reading Level						
			Avg. (dBm)						
Tnom (25 °C)	Vnom (120V)	155	5775	Ant3		Ant5		Pass/Fail	
				Avg. (dBm)		Avg. (dBm)			
				15.91		16.19		19.06	

Antenna Technology:	CDD 4*4									
Mode:	802.11a	Data Rate:	6Mbps	Conducted power						
				MIMO Mode(4TX+4RX)						
Test Conditions	Channel	Frequency	Ant 3+5+6+7				Total Power	Limit		
			Reading Level							
			Avg. (dBm)							
Tnom (25 °C)	Vnom (120V)	149	5745	Ant3		Ant5		Ant6		Pass/Fail
				Avg. (dBm)		Avg. (dBm)		Avg. (dBm)		
				20.76		21.30		21.52		21.42
Tnom (25 °C)	Vnom (120V)	157	5785	Ant3		Ant5		Ant6		Pass/Fail
				Avg. (dBm)		Avg. (dBm)		Avg. (dBm)		
				20.79		21.06		21.31		20.96
Tnom (25 °C)	Vnom (120V)	165	5825	Ant3		Ant5		Ant6		Pass/Fail
				Avg. (dBm)		Avg. (dBm)		Avg. (dBm)		
				20.80		20.82		20.81		20.77
Mode:	802.11n(20MHz)	Data Rate:	MCS0	Conducted power						
				MIMO Mode(4TX+4RX)						
Test Conditions	Channel	Frequency	Ant 3+5+6+7				Total Power	Limit		
			Reading Level							
			Avg. (dBm)							
Tnom (25 °C)	Vnom (120V)	149	5745	Ant3		Ant5		Ant6		Pass/Fail
				Avg. (dBm)		Avg. (dBm)		Avg. (dBm)		
				21.09		21.32		21.35		21.39
Tnom (25 °C)	Vnom (120V)	157	5785	Ant3		Ant5		Ant6		Pass/Fail
				Avg. (dBm)		Avg. (dBm)		Avg. (dBm)		
				20.92		20.92		21.18		21.01
Tnom (25 °C)	Vnom (120V)	165	5825	Ant3		Ant5		Ant6		Pass/Fail
				Avg. (dBm)		Avg. (dBm)		Avg. (dBm)		
				20.86		20.61		20.95		20.70
Mode:	802.11n(40MHz)	Data Rate:	MCS0	Conducted power						
				MIMO Mode(4TX+4RX)						
Test Conditions	Channel	Frequency	Ant 3+5+6+7				Total Power	Limit		
			Reading Level							
			Avg. (dBm)							

			(MHz)	Avg. (dBm)	Avg. (dBm)	Avg. (dBm)	Avg. (dBm)	Avg. (dBm)	Avg. (dBm)	Pass/Fail
Tnom (25 °C)	Vnom (120V)	151	5755	20.99	21.52	21.48	21.45	27.39	27.94	Pass
		159	5795	20.82	21.07	21.11	20.97	27.01	27.94	Pass
Mode:	802.11ac(20MHz)	Data Rate:	MCS0NSS1	Conducted power						
				MIMO Mode(4TX+4RX)						
Test Conditions	Channel	Frequency	Ant 3+5+6+7				Total Power	Limit		
			Ant3	Ant5	Ant6	Ant7				
			Reading Level	Reading Level	Reading Level	Reading Level	Avg. (dBm)	Avg. (dBm)	Pass/Fail	
			(MHz)	Avg. (dBm)	Avg. (dBm)	Avg. (dBm)				Avg. (dBm)
Tnom (25 °C)	Vnom (120V)	149	5745	21.03	21.37	21.36	21.22	27.27	27.94	Pass
		157	5785	21.01	20.86	21.13	20.98	27.02	27.94	Pass
		165	5825	20.75	20.72	20.61	20.85	26.75	27.94	Pass
Mode:	802.11ac(40MHz)	Data Rate:	MCS0NSS1	Conducted power						
				MIMO Mode(4TX+4RX)						
Test Conditions	Channel	Frequency	Ant 3+5+6+7				Total Power	Limit		
			Ant3	Ant5	Ant6	Ant7				
			Reading Level	Reading Level	Reading Level	Reading Level	Avg. (dBm)	Avg. (dBm)	Pass/Fail	
			(MHz)	Avg. (dBm)	Avg. (dBm)	Avg. (dBm)				Avg. (dBm)
Tnom (25 °C)	Vnom (120V)	151	5755	20.91	21.27	21.39	21.37	27.26	27.94	Pass
		159	5795	20.86	21.02	21.18	20.96	27.03	27.94	Pass
Mode:	802.11ac(80MHz)	Data Rate:	MCS0NSS1	Conducted power						
				MIMO Mode(4TX+4RX)						
Test Conditions	Channel	Frequency	Ant 3+5+6+7				Total Power	Limit		
			Ant3	Ant5	Ant6	Ant7				
			Reading Level	Reading Level	Reading Level	Reading Level	Avg. (dBm)	Avg. (dBm)	Pass/Fail	
			(MHz)	Avg. (dBm)	Avg. (dBm)	Avg. (dBm)				Avg. (dBm)
Tnom (25 °C)	Vnom (120V)	155	5775	14.32	14.58	14.31	14.85	20.54	27.94	Pass
Mode:	802.11ax(20MHz)	Data Rate:	HE0NSS1	Conducted power						
				MIMO Mode(4TX+4RX)						
Test Conditions	Channel	Frequency	Ant 3+5+6+7				Total Power	Limit		
			Ant3	Ant5	Ant6	Ant7				
			Reading Level	Reading Level	Reading Level	Reading Level	Avg. (dBm)	Avg. (dBm)	Pass/Fail	
			(MHz)	Avg. (dBm)	Avg. (dBm)	Avg. (dBm)				Avg. (dBm)
Tnom (25 °C)	Vnom (120V)	149	5745	20.99	21.36	21.46	21.31	27.30	27.94	Pass
		157	5785	20.97	20.95	21.19	20.95	27.04	27.94	Pass
		165	5825	20.62	20.95	20.86	20.81	26.83	27.94	Pass
Mode:	802.11ax(40MHz)	Data Rate:	HE0NSS1	Conducted power						
				MIMO Mode(4TX+4RX)						
Test Conditions	Channel	Frequency	Ant 3+5+6+7				Total Power	Limit		
			Ant3	Ant5	Ant6	Ant7				
			Reading Level	Reading Level	Reading Level	Reading Level	Avg. (dBm)	Avg. (dBm)	Pass/Fail	
			(MHz)	Avg. (dBm)	Avg. (dBm)	Avg. (dBm)				Avg. (dBm)
Tnom (25 °C)	Vnom (120V)	151	5755	21.18	21.48	21.58	21.30	27.41	27.94	Pass
		159	5795	20.64	20.88	21.01	20.94	26.89	27.94	Pass
Mode:	802.11ax(80MHz)	Data Rate:	HE0NSS1	Conducted power						
				MIMO Mode(4TX+4RX)						
Test Conditions	Channel	Frequency	Ant 3+5+6+7				Total Power	Limit		
			Ant3	Ant5	Ant6	Ant7				
			Reading Level	Reading Level	Reading Level	Reading Level	Avg. (dBm)	Avg. (dBm)	Pass/Fail	
			(MHz)	Avg. (dBm)	Avg. (dBm)	Avg. (dBm)				Avg. (dBm)
Tnom (25 °C)	Vnom (120V)	155	5775	14.46	14.63	14.49	14.91	20.65	27.94	Pass
Antenna Technology:	Beamforming 2*2									
Mode:	802.11n(20MHz)	Data Rate:	MCS0	Conducted power						
				MIMO Mode(2TX+2RX)						
				Ant 3+5						

Test Conditions		Channel	Frequency (MHz)	Reading Level		Total Power Avg. (dBm)	Limit	
				Ant3	Ant5		Avg. (dBm)	Pass/Fail
Tnom (25 °C)	Vnom (120V)	149	5745	21.16	21.71	24.45	24.93	Pass
		157	5785	21.22	21.17	24.21	24.93	Pass
		165	5825	21.10	21.22	24.17	24.93	Pass
Mode:	802.11n(40MHz)	Data Rate:	MCS0	Conducted power MIMO Mode(2TX+2RX)				
Test Conditions		Channel	Frequency	Reading Level		Total Power Avg. (dBm)	Limit	
			(MHz)	Ant3	Ant5		Avg. (dBm)	Pass/Fail
Tnom (25 °C)	Vnom (120V)	151	5755	21.36	21.78	24.59	24.93	Pass
		159	5795	21.12	21.47	24.31	24.93	Pass
Mode:	802.11ac(20MHz)	Data Rate:	MCS0NSS1	Conducted power MIMO Mode(2TX+2RX)				
Test Conditions		Channel	Frequency	Reading Level		Total Power Avg. (dBm)	Limit	
			(MHz)	Ant3	Ant5		Avg. (dBm)	Pass/Fail
Tnom (25 °C)	Vnom (120V)	149	5745	21.49	21.64	24.58	24.93	Pass
		157	5785	21.25	21.41	24.34	24.93	Pass
		165	5825	21.05	21.17	24.12	24.93	Pass
Mode:	802.11ac(40MHz)	Data Rate:	MCS0NSS1	Conducted power MIMO Mode(2TX+2RX)				
Test Conditions		Channel	Frequency	Reading Level		Total Power Avg. (dBm)	Limit	
			(MHz)	Ant3	Ant5		Avg. (dBm)	Pass/Fail
Tnom (25 °C)	Vnom (120V)	151	5755	21.50	21.60	24.56	24.93	Pass
		159	5795	21.10	21.22	24.17	24.93	Pass
Mode:	802.11ac(80MHz)	Data Rate:	MCS0NSS1	Conducted power MIMO Mode(2TX+2RX)				
Test Conditions		Channel	Frequency	Reading Level		Total Power Avg. (dBm)	Limit	
			(MHz)	Ant3	Ant5		Avg. (dBm)	Pass/Fail
Tnom (25 °C)	Vnom (120V)	155	5775	15.64	16.02	18.84	24.93	Pass
Mode:	802.11ax(20MHz)	Data Rate:	HE0NSS1	Conducted power MIMO Mode(2TX+2RX)				
Test Conditions		Channel	Frequency	Reading Level		Total Power Avg. (dBm)	Limit	
			(MHz)	Ant3	Ant5		Avg. (dBm)	Pass/Fail
Tnom (25 °C)	Vnom (120V)	149	5745	21.13	21.75	24.46	24.93	Pass
		157	5785	21.14	21.44	24.30	24.93	Pass
		165	5825	21.07	21.07	24.08	24.93	Pass
Mode:	802.11ax(40MHz)	Data Rate:	HE0NSS1	Conducted power MIMO Mode(2TX+2RX)				
Test Conditions		Channel	Frequency	Reading Level		Total Power Avg. (dBm)	Limit	
			(MHz)	Ant3	Ant5		Avg. (dBm)	Pass/Fail
Tnom (25 °C)	Vnom (120V)	151	5755	21.50	21.52	24.52	24.93	Pass
		159	5795	20.97	21.35	24.17	24.93	Pass
Mode:	802.11ax(80MHz)	Data Rate:	HE0NSS1	Conducted power MIMO Mode(2TX+2RX)				
Test Conditions		Channel	Frequency	Reading Level		Total Power Avg. (dBm)	Limit	
			(MHz)	Ant3	Ant5		Avg. (dBm)	Pass/Fail
				Ant 3+5				

Test Conditions		Channel	Frequency (MHz)	Reading Level		Total Power Avg. (dBm)	Limit	
				Ant3	Ant5		Avg. (dBm)	Pass/Fail
Tnom (25 °C)	Vnom (120V)	155	5775	15.63	15.90	18.78	24.93	Pass

**Antenna Technology:** Beamforming 4\*4

Mode:	802.11n(20MHz)	Data Rate:	MCS0	Conducted power MIMO Mode(4TX+4RX)						
				Ant 3+5+6+7				Total Power Avg. (dBm)	Limit	

Test Conditions		Channel	Frequency (MHz)	Ant3	Ant5	Ant6	Ant7	Total Power Avg. (dBm)	Limit	
				Reading Level Avg. (dBm)	Reading Level Avg. (dBm)	Reading Level Avg. (dBm)	Reading Level Avg. (dBm)		Avg. (dBm)	Pass/Fail
Tnom (25 °C)	Vnom (120V)	149	5745	14.87	15.23	15.30	15.31	21.20	21.92	Pass
		157	5785	14.86	14.93	15.11	14.89	20.97	21.92	Pass
		165	5825	14.81	14.87	14.77	14.82	20.84	21.92	Pass

Mode:	802.11n(40MHz)	Data Rate:	MCS0	Conducted power MIMO Mode(4TX+4RX)						
				Ant 3+5+6+7				Total Power Avg. (dBm)	Limit	

Test Conditions		Channel	Frequency (MHz)	Ant3	Ant5	Ant6	Ant7	Total Power Avg. (dBm)	Limit	
				Reading Level Avg. (dBm)	Reading Level Avg. (dBm)	Reading Level Avg. (dBm)	Reading Level Avg. (dBm)		Avg. (dBm)	Pass/Fail
Tnom (25 °C)	Vnom (120V)	151	5755	14.98	15.44	15.54	15.27	21.33	21.92	Pass
		159	5795	14.79	14.84	14.92	14.84	20.87	21.92	Pass

Mode:	802.11ac(20MHz)	Data Rate:	MCS0NSS1	Conducted power MIMO Mode(4TX+4RX)						
				Ant 3+5+6+7				Total Power Avg. (dBm)	Limit	

Test Conditions		Channel	Frequency (MHz)	Ant3	Ant5	Ant6	Ant7	Total Power Avg. (dBm)	Limit	
				Reading Level Avg. (dBm)	Reading Level Avg. (dBm)	Reading Level Avg. (dBm)	Reading Level Avg. (dBm)		Avg. (dBm)	Pass/Fail
Tnom (25 °C)	Vnom (120V)	149	5745	14.74	15.28	15.53	15.25	21.23	21.92	Pass
		157	5785	14.92	14.87	15.01	15.10	21.00	21.92	Pass
		165	5825	14.74	14.75	14.76	14.73	20.77	21.92	Pass

Mode:	802.11ac(40MHz)	Data Rate:	MCS0NSS1	Conducted power MIMO Mode(4TX+4RX)						
				Ant 3+5+6+7				Total Power Avg. (dBm)	Limit	

Test Conditions		Channel	Frequency (MHz)	Ant3	Ant5	Ant6	Ant7	Total Power Avg. (dBm)	Limit	
				Reading Level Avg. (dBm)	Reading Level Avg. (dBm)	Reading Level Avg. (dBm)	Reading Level Avg. (dBm)		Avg. (dBm)	Pass/Fail
Tnom (25 °C)	Vnom (120V)	151	5755	15.07	15.31	15.35	15.30	21.28	21.92	Pass
		159	5795	14.89	15.04	14.88	14.85	20.94	21.92	Pass

Mode:	802.11ac(80MHz)	Data Rate:	MCS0NSS1	Conducted power MIMO Mode(4TX+4RX)						
				Ant 3+5+6+7				Total Power Avg. (dBm)	Limit	

Test Conditions		Channel	Frequency (MHz)	Ant3	Ant5	Ant6	Ant7	Total Power Avg. (dBm)	Limit	
				Reading Level Avg. (dBm)	Reading Level Avg. (dBm)	Reading Level Avg. (dBm)	Reading Level Avg. (dBm)		Avg. (dBm)	Pass/Fail
Tnom (25 °C)	Vnom (120V)	155	5775	14.45	14.52	14.46	14.79	20.58	21.92	Pass

Mode:	802.11ax(20MHz)	Data Rate:	HE0NSS1	Conducted power MIMO Mode(4TX+4RX)						
				Ant 3+5+6+7				Total Power Avg. (dBm)	Limit	

Test Conditions		Channel	Frequency (MHz)	Ant3	Ant5	Ant6	Ant7	Total Power Avg. (dBm)	Limit	
				Reading Level Avg. (dBm)	Reading Level Avg. (dBm)	Reading Level Avg. (dBm)	Reading Level Avg. (dBm)		Avg. (dBm)	Pass/Fail
Tnom (25 °C)	Vnom (120V)	149	5745	14.98	15.45	15.41	15.23	21.29	21.92	Pass
		157	5785	14.93	15.04	15.13	15.01	21.05	21.92	Pass
		165	5825	14.78	14.79	14.77	14.61	20.76	21.92	Pass

Conducted power

Mode:		802.11ax(40MHz)		Data Rate:		HE0NSS1		MIMO Mode(4TX+4RX)					
Test Conditions		Channel		Ant 3+5+6+7				Total Power		Limit			
				Frequency	Ant3	Ant5	Ant6					Ant7	
				(MHz)	Reading Level	Reading Level	Reading Level	Reading Level	Avg. (dBm)	Avg. (dBm)	Pass/Fail		
Tnom (25 °C)	Vnom (120V)	151	5755	15.03	15.37	15.60	15.39	21.37	21.92	Pass			
		159	5795	14.60	14.94	14.90	15.14	20.92	21.92	Pass			
Mode:		802.11ax(80MHz)		Data Rate:		HE0NSS1		Conducted power					
Test Conditions		Channel		Ant 3+5+6+7				Total Power		Limit			
				Frequency	Ant3	Ant5	Ant6					Ant7	
				(MHz)	Reading Level	Reading Level	Reading Level	Reading Level	Avg. (dBm)	Avg. (dBm)	Pass/Fail		
Tnom (25 °C)	Vnom (120V)	155	5775	14.37	14.29	14.43	14.69	20.47	21.92	Pass			

# FCC 5GHz Power Table-Radio 3(5G High band mode)



Standard:	FCC Part 15.407	Test Date:	2020.04.07	Temperature:	25°C	Humidity:	55%RH		
Project No. :	2032034R			Product Name:	Wireless Access Point	Model Name:	AP460SC	Test Site:	TR8
Antenna Gain(dBi)	Ant 3	7.84	Ant 5	8.06	Ant 6	7.91	Ant 7	7.65	
2*2 CDD-Directional Gain-Power(dBi)	8.06			2*2 BF-Directional Gain-Power(dBi)	11.07				
4*4 CDD-Directional Gain-Power(dBi)	8.06			4*4 BF-Directional Gain-Power(dBi)	14.08				

Test Eng: Pawn

Antenna Technology: CDD 2\*2

Mode: 802.11a Data Rate: 6Mbps Conducted power MIMO Mode(2TX+2RX)

Test Conditions	Channel	Frequency (MHz)	Ant 3+5 Reading Level Avg. (dBm)		Total Power Avg. (dBm)	Limit	
			Ant3	Ant5		Avg. (dBm)	Pass/Fail
Tnom (25 °C) Vnom (120V)	149	5745	21.58	21.91	24.76	27.94	Pass
		157	5785	21.47	21.48	24.49	Pass
		165	5825	21.36	21.24	24.31	27.94

Mode: 802.11n(20MHz) Data Rate: MCS0 Conducted power MIMO Mode(2TX+2RX)

Test Conditions	Channel	Frequency (MHz)	Ant 3+5 Reading Level Avg. (dBm)		Total Power Avg. (dBm)	Limit		
			Ant3	Ant5		Avg. (dBm)	Pass/Fail	
Tnom (25 °C) Vnom (120V)	149	5745	21.47	21.92	24.71	27.94	Pass	
		157	5785	21.40	21.62	24.52	27.94	Pass
		165	5825	21.38	21.22	24.31	27.94	Pass

Mode: 802.11n(40MHz) Data Rate: MCS0 Conducted power MIMO Mode(2TX+2RX)

Test Conditions	Channel	Frequency (MHz)	Ant 3+5 Reading Level Avg. (dBm)		Total Power Avg. (dBm)	Limit	
			Ant3	Ant5		Avg. (dBm)	Pass/Fail
Tnom (25 °C) Vnom (120V)	151	5755	21.64	21.91	24.79	27.94	Pass
		159	5795	21.41	21.57	24.50	27.94

Mode: 802.11ac(20MHz) Data Rate: MCS0NSS1 Conducted power MIMO Mode(2TX+2RX)

Test Conditions	Channel	Frequency (MHz)	Ant 3+5 Reading Level Avg. (dBm)		Total Power Avg. (dBm)	Limit		
			Ant3	Ant5		Avg. (dBm)	Pass/Fail	
Tnom (25 °C) Vnom (120V)	149	5745	21.47	21.85	24.67	27.94	Pass	
		157	5785	21.49	21.52	24.52	27.94	Pass
		165	5825	21.36	21.33	24.36	27.94	Pass

Mode: 802.11ac(40MHz) Data Rate: MCS0NSS1 Conducted power MIMO Mode(2TX+2RX)

Test Conditions	Channel	Frequency (MHz)	Ant 3+5 Reading Level Avg. (dBm)		Total Power Avg. (dBm)	Limit	
			Ant3	Ant5		Avg. (dBm)	Pass/Fail
Tnom (25 °C) Vnom (120V)	151	5755	21.62	21.85	24.75	27.94	Pass



Tnom (25 °C)	Vnom (120V)	159	5795	21.31	21.58	24.46	27.94	Pass		
Mode:	802.11ac(80MHz)	Data Rate:	MCS0NSS1	Conducted power					Total Power	Limit
				MIMO Mode(2TX+2RX)						
Test Conditions	Channel	Frequency	Ant 3+5				Avg. (dBm)	Avg. (dBm)	Pass/Fail	
			Reading Level		Reading Level					
Tnom (25 °C)	Vnom (120V)	Channel	(MHz)	Ant3	Ant5	Avg. (dBm)	Avg. (dBm)	Pass/Fail		
			155	5775	15.96	16.22	19.10	27.94	Pass	
Mode:	802.11ax(20MHz)	Data Rate:	HE0NSS1	Conducted power					Total Power	Limit
				MIMO Mode(2TX+2RX)						
Test Conditions	Channel	Frequency	Ant 3+5				Avg. (dBm)	Avg. (dBm)	Pass/Fail	
			Reading Level		Reading Level					
Tnom (25 °C)	Vnom (120V)	Channel	(MHz)	Ant3	Ant5	Avg. (dBm)	Avg. (dBm)	Pass/Fail		
			149	5745	21.50	21.95	24.74	27.94	Pass	
			157	5785	21.44	21.43	24.45	27.94	Pass	
			165	5825	21.35	21.27	24.32	27.94	Pass	
Mode:	802.11ax(40MHz)	Data Rate:	HE0NSS1	Conducted power					Total Power	Limit
				MIMO Mode(2TX+2RX)						
Test Conditions	Channel	Frequency	Ant 3+5				Avg. (dBm)	Avg. (dBm)	Pass/Fail	
			Reading Level		Reading Level					
Tnom (25 °C)	Vnom (120V)	Channel	(MHz)	Ant3	Ant5	Avg. (dBm)	Avg. (dBm)	Pass/Fail		
			151	5755	21.58	21.91	24.76	27.94	Pass	
			159	5795	21.37	21.56	24.48	27.94	Pass	
Mode:	802.11ax(80MHz)	Data Rate:	HE0NSS1	Conducted power					Total Power	Limit
				MIMO Mode(2TX+2RX)						
Test Conditions	Channel	Frequency	Ant 3+5				Avg. (dBm)	Avg. (dBm)	Pass/Fail	
			Reading Level		Reading Level					
Tnom (25 °C)	Vnom (120V)	Channel	(MHz)	Ant3	Ant5	Avg. (dBm)	Avg. (dBm)	Pass/Fail		
			155	5775	15.91	16.19	19.06	27.94	Pass	

Antenna Technology:	CDD 4*4										
Mode:	802.11a	Data Rate:	6Mbps	Conducted power					Total Power	Limit	
				MIMO Mode(4TX+4RX)							
Test Conditions	Channel	Frequency	Ant 3+5+6+7				Avg. (dBm)	Avg. (dBm)	Pass/Fail		
			Reading Level		Reading Level						
Tnom (25 °C)	Vnom (120V)	Channel	(MHz)	Ant3	Ant5	Ant6	Ant7	Avg. (dBm)	Pass/Fail		
			149	5745	20.76	21.30	21.52	21.42	27.28	27.94	Pass
			157	5785	20.79	21.06	21.31	20.96	27.05	27.94	Pass
			165	5825	20.80	20.82	20.81	20.77	26.82	27.94	Pass
Mode:	802.11n(20MHz)	Data Rate:	MCS0	Conducted power					Total Power	Limit	
				MIMO Mode(4TX+4RX)							
Test Conditions	Channel	Frequency	Ant 3+5+6+7				Avg. (dBm)	Avg. (dBm)	Pass/Fail		
			Reading Level		Reading Level						
Tnom (25 °C)	Vnom (120V)	Channel	(MHz)	Ant3	Ant5	Ant6	Ant7	Avg. (dBm)	Pass/Fail		
			149	5745	21.09	21.32	21.35	21.39	27.31	27.94	Pass
			157	5785	20.92	20.92	21.18	21.01	27.03	27.94	Pass
			165	5825	20.86	20.61	20.95	20.70	26.80	27.94	Pass
Mode:	802.11n(40MHz)	Data Rate:	MCS0	Conducted power					Total Power	Limit	
				MIMO Mode(4TX+4RX)							
Test Conditions	Channel	Frequency	Ant 3+5+6+7				Avg. (dBm)	Avg. (dBm)	Pass/Fail		
			Reading Level		Reading Level						
Tnom (25 °C)	Vnom (120V)	Channel	(MHz)	Ant3	Ant5	Ant6	Ant7	Avg. (dBm)	Pass/Fail		
			149	5745	21.09	21.32	21.35	21.39	27.31	27.94	Pass
			157	5785	20.92	20.92	21.18	21.01	27.03	27.94	Pass
			165	5825	20.86	20.61	20.95	20.70	26.80	27.94	Pass

			(MHz)	Avg. (dBm)	Avg. (dBm)	Avg. (dBm)	Avg. (dBm)	Avg. (dBm)	Avg. (dBm)	Pass/Fail		
Tnom (25 °C)	Vnom (120V)	151	5755	20.99	21.52	21.48	21.45	27.39	27.94	Pass		
		159	5795	20.82	21.07	21.11	20.97	27.01	27.94	Pass		
Mode:	802.11ac(20MHz)	Data Rate:	MCS0NSS1	Conducted power								
				MIMO Mode(4TX+4RX)								
Test Conditions	Channel	Frequency	Ant 3+5+6+7				Total Power	Limit				
			Ant3	Ant5	Ant6	Ant7						
			Reading Level	Reading Level	Reading Level	Reading Level	Avg. (dBm)	Avg. (dBm)	Pass/Fail			
		(MHz)	Avg. (dBm)	Avg. (dBm)	Avg. (dBm)	Avg. (dBm)	Avg. (dBm)	Avg. (dBm)	Pass/Fail			
Tnom (25 °C)	Vnom (120V)	149	5745	21.03	21.37	21.36	21.22	27.27	27.94	Pass		
		157	5785	21.01	20.86	21.13	20.98	27.02	27.94	Pass		
		165	5825	20.75	20.72	20.61	20.85	26.75	27.94	Pass		
Mode:	802.11ac(40MHz)	Data Rate:	MCS0NSS1	Conducted power								
				MIMO Mode(4TX+4RX)								
Test Conditions	Channel	Frequency	Ant 3+5+6+7				Total Power	Limit				
			Ant3	Ant5	Ant6	Ant7						
			Reading Level	Reading Level	Reading Level	Reading Level	Avg. (dBm)	Avg. (dBm)	Pass/Fail			
		(MHz)	Avg. (dBm)	Avg. (dBm)	Avg. (dBm)	Avg. (dBm)	Avg. (dBm)	Avg. (dBm)	Pass/Fail			
Tnom (25 °C)	Vnom (120V)	151	5755	20.91	21.27	21.39	21.37	27.26	27.94	Pass		
		159	5795	20.86	21.02	21.18	20.96	27.03	27.94	Pass		
Mode:	802.11ac(80MHz)	Data Rate:	MCS0NSS1	Conducted power								
				MIMO Mode(4TX+4RX)								
Test Conditions	Channel	Frequency	Ant 3+5+6+7				Total Power	Limit				
			Ant3	Ant5	Ant6	Ant7						
			Reading Level	Reading Level	Reading Level	Reading Level	Avg. (dBm)	Avg. (dBm)	Pass/Fail			
		(MHz)	Avg. (dBm)	Avg. (dBm)	Avg. (dBm)	Avg. (dBm)	Avg. (dBm)	Avg. (dBm)	Pass/Fail			
Tnom (25 °C)	Vnom (120V)	155	5775	14.32	14.58	14.31	14.85	20.54	27.94	Pass		
Mode:	802.11ax(20MHz)	Data Rate:	HE0NSS1	Conducted power								
				MIMO Mode(4TX+4RX)								
Test Conditions	Channel	Frequency	Ant 3+5+6+7				Total Power	Limit				
			Ant3	Ant5	Ant6	Ant7						
			Reading Level	Reading Level	Reading Level	Reading Level	Avg. (dBm)	Avg. (dBm)	Pass/Fail			
		(MHz)	Avg. (dBm)	Avg. (dBm)	Avg. (dBm)	Avg. (dBm)	Avg. (dBm)	Avg. (dBm)	Pass/Fail			
Tnom (25 °C)	Vnom (120V)	149	5745	20.99	21.36	21.46	21.31	27.30	27.94	Pass		
		157	5785	20.97	20.95	21.19	20.95	27.04	27.94	Pass		
		165	5825	20.62	20.95	20.86	20.81	26.83	27.94	Pass		
Mode:	802.11ax(40MHz)	Data Rate:	HE0NSS1	Conducted power								
				MIMO Mode(4TX+4RX)								
Test Conditions	Channel	Frequency	Ant 3+5+6+7				Total Power	Limit				
			Ant3	Ant5	Ant6	Ant7						
			Reading Level	Reading Level	Reading Level	Reading Level	Avg. (dBm)	Avg. (dBm)	Pass/Fail			
		(MHz)	Avg. (dBm)	Avg. (dBm)	Avg. (dBm)	Avg. (dBm)	Avg. (dBm)	Avg. (dBm)	Pass/Fail			
Tnom (25 °C)	Vnom (120V)	151	5755	21.18	21.48	21.58	21.30	27.41	27.94	Pass		
		159	5795	20.64	20.88	21.01	20.94	26.89	27.94	Pass		
Mode:	802.11ax(80MHz)	Data Rate:	HE0NSS1	Conducted power								
				MIMO Mode(4TX+4RX)								
Test Conditions	Channel	Frequency	Ant 3+5+6+7				Total Power	Limit				
			Ant3	Ant5	Ant6	Ant7						
			Reading Level	Reading Level	Reading Level	Reading Level	Avg. (dBm)	Avg. (dBm)	Pass/Fail			
		(MHz)	Avg. (dBm)	Avg. (dBm)	Avg. (dBm)	Avg. (dBm)	Avg. (dBm)	Avg. (dBm)	Pass/Fail			
Tnom (25 °C)	Vnom (120V)	155	5775	14.46	14.63	14.49	14.91	20.65	27.94	Pass		
Antenna Technology:	Beamforming 2*2											
Mode:	802.11n(20MHz)	Data Rate:	MCS0	Conducted power								
				MIMO Mode(2TX+2RX)								
				Ant 3+5								

Test Conditions		Channel	Frequency (MHz)	Reading Level		Total Power Avg. (dBm)	Limit	
				Ant3	Ant5		Avg. (dBm)	Pass/Fail
Tnom (25 °C)	Vnom (120V)	149	5745	21.16	21.71	24.45	24.93	Pass
		157	5785	21.22	21.17	24.21	24.93	Pass
		165	5825	21.10	21.22	24.17	24.93	Pass
Mode:	802.11n(40MHz)	Data Rate:	MCS0	Conducted power MIMO Mode(2TX+2RX)				
Test Conditions		Channel	Frequency	Reading Level		Total Power Avg. (dBm)	Limit	
			(MHz)	Ant3	Ant5		Avg. (dBm)	Pass/Fail
Tnom (25 °C)	Vnom (120V)	151	5755	21.36	21.78	24.59	24.93	Pass
		159	5795	21.12	21.47	24.31	24.93	Pass
Mode:	802.11ac(20MHz)	Data Rate:	MCS0NSS1	Conducted power MIMO Mode(2TX+2RX)				
Test Conditions		Channel	Frequency	Reading Level		Total Power Avg. (dBm)	Limit	
			(MHz)	Ant3	Ant5		Avg. (dBm)	Pass/Fail
Tnom (25 °C)	Vnom (120V)	149	5745	21.49	21.64	24.58	24.93	Pass
		157	5785	21.25	21.41	24.34	24.93	Pass
		165	5825	21.05	21.17	24.12	24.93	Pass
Mode:	802.11ac(40MHz)	Data Rate:	MCS0NSS1	Conducted power MIMO Mode(2TX+2RX)				
Test Conditions		Channel	Frequency	Reading Level		Total Power Avg. (dBm)	Limit	
			(MHz)	Ant3	Ant5		Avg. (dBm)	Pass/Fail
Tnom (25 °C)	Vnom (120V)	151	5755	21.50	21.60	24.56	24.93	Pass
		159	5795	21.10	21.22	24.17	24.93	Pass
Mode:	802.11ac(80MHz)	Data Rate:	MCS0NSS1	Conducted power MIMO Mode(2TX+2RX)				
Test Conditions		Channel	Frequency	Reading Level		Total Power Avg. (dBm)	Limit	
			(MHz)	Ant3	Ant5		Avg. (dBm)	Pass/Fail
Tnom (25 °C)	Vnom (120V)	155	5775	15.64	16.02	18.84	24.93	Pass
Mode:	802.11ax(20MHz)	Data Rate:	HE0NSS1	Conducted power MIMO Mode(2TX+2RX)				
Test Conditions		Channel	Frequency	Reading Level		Total Power Avg. (dBm)	Limit	
			(MHz)	Ant3	Ant5		Avg. (dBm)	Pass/Fail
Tnom (25 °C)	Vnom (120V)	149	5745	21.13	21.75	24.46	24.93	Pass
		157	5785	21.14	21.44	24.30	24.93	Pass
		165	5825	21.07	21.07	24.08	24.93	Pass
Mode:	802.11ax(40MHz)	Data Rate:	HE0NSS1	Conducted power MIMO Mode(2TX+2RX)				
Test Conditions		Channel	Frequency	Reading Level		Total Power Avg. (dBm)	Limit	
			(MHz)	Ant3	Ant5		Avg. (dBm)	Pass/Fail
Tnom (25 °C)	Vnom (120V)	151	5755	21.50	21.52	24.52	24.93	Pass
		159	5795	20.97	21.35	24.17	24.93	Pass
Mode:	802.11ax(80MHz)	Data Rate:	HE0NSS1	Conducted power MIMO Mode(2TX+2RX)				
Test Conditions		Channel	Frequency	Reading Level		Total Power Avg. (dBm)	Limit	
			(MHz)	Ant3	Ant5		Avg. (dBm)	Pass/Fail
				Ant 3+5				

Test Conditions		Channel	Frequency (MHz)	Reading Level		Total Power Avg. (dBm)	Limit	
				Ant3	Ant5		Avg. (dBm)	Pass/Fail
Tnom (25 °C)	Vnom (120V)	155	5775	15.63	15.90	18.78	24.93	Pass

**Antenna Technology: Beamforming 4\*4**

Mode:	802.11n(20MHz)	Data Rate:	MCS0	Conducted power MIMO Mode(4TX+4RX)					Total Power	Limit
Test Conditions		Channel	Frequency	Ant3	Ant5	Ant6	Ant7	Avg. (dBm)	Avg. (dBm)	Pass/Fail
			(MHz)	Reading Level	Reading Level	Reading Level	Reading Level			
				Avg. (dBm)	Avg. (dBm)	Avg. (dBm)	Avg. (dBm)			

Test Conditions		Channel	Frequency	Ant3	Ant5	Ant6	Ant7	Total Power	Limit
Tnom (25 °C)	Vnom (120V)	149	5745	14.87	15.23	15.30	15.31	21.20	Pass
		157	5785	14.86	14.93	15.11	14.89	20.97	Pass
		165	5825	14.81	14.87	14.77	14.82	20.84	Pass

Mode:	802.11n(40MHz)	Data Rate:	MCS0	Conducted power MIMO Mode(4TX+4RX)					Total Power	Limit
Test Conditions		Channel	Frequency	Ant3	Ant5	Ant6	Ant7	Avg. (dBm)	Avg. (dBm)	Pass/Fail
			(MHz)	Reading Level	Reading Level	Reading Level	Reading Level			
				Avg. (dBm)	Avg. (dBm)	Avg. (dBm)	Avg. (dBm)			

Test Conditions		Channel	Frequency	Ant3	Ant5	Ant6	Ant7	Total Power	Limit
Tnom (25 °C)	Vnom (120V)	151	5755	14.98	15.44	15.54	15.27	21.33	Pass
		159	5795	14.79	14.84	14.92	14.84	20.87	Pass

Mode:	802.11ac(20MHz)	Data Rate:	MCS0NSS1	Conducted power MIMO Mode(4TX+4RX)					Total Power	Limit
Test Conditions		Channel	Frequency	Ant3	Ant5	Ant6	Ant7	Avg. (dBm)	Avg. (dBm)	Pass/Fail
			(MHz)	Reading Level	Reading Level	Reading Level	Reading Level			
				Avg. (dBm)	Avg. (dBm)	Avg. (dBm)	Avg. (dBm)			

Test Conditions		Channel	Frequency	Ant3	Ant5	Ant6	Ant7	Total Power	Limit
Tnom (25 °C)	Vnom (120V)	149	5745	14.74	15.28	15.53	15.25	21.23	Pass
		157	5785	14.92	14.87	15.01	15.10	21.00	Pass
		165	5825	14.74	14.75	14.76	14.73	20.77	Pass

Mode:	802.11ac(40MHz)	Data Rate:	MCS0NSS1	Conducted power MIMO Mode(4TX+4RX)					Total Power	Limit
Test Conditions		Channel	Frequency	Ant3	Ant5	Ant6	Ant7	Avg. (dBm)	Avg. (dBm)	Pass/Fail
			(MHz)	Reading Level	Reading Level	Reading Level	Reading Level			
				Avg. (dBm)	Avg. (dBm)	Avg. (dBm)	Avg. (dBm)			

Test Conditions		Channel	Frequency	Ant3	Ant5	Ant6	Ant7	Total Power	Limit
Tnom (25 °C)	Vnom (120V)	151	5755	15.07	15.31	15.35	15.30	21.28	Pass
		159	5795	14.89	15.04	14.88	14.85	20.94	Pass

Mode:	802.11ac(80MHz)	Data Rate:	MCS0NSS1	Conducted power MIMO Mode(4TX+4RX)					Total Power	Limit
Test Conditions		Channel	Frequency	Ant3	Ant5	Ant6	Ant7	Avg. (dBm)	Avg. (dBm)	Pass/Fail
			(MHz)	Reading Level	Reading Level	Reading Level	Reading Level			
				Avg. (dBm)	Avg. (dBm)	Avg. (dBm)	Avg. (dBm)			

Test Conditions		Channel	Frequency	Ant3	Ant5	Ant6	Ant7	Total Power	Limit
Tnom (25 °C)	Vnom (120V)	155	5775	14.45	14.52	14.46	14.79	20.58	Pass

Mode:	802.11ax(20MHz)	Data Rate:	HE0NSS1	Conducted power MIMO Mode(4TX+4RX)					Total Power	Limit
Test Conditions		Channel	Frequency	Ant3	Ant5	Ant6	Ant7	Avg. (dBm)	Avg. (dBm)	Pass/Fail
			(MHz)	Reading Level	Reading Level	Reading Level	Reading Level			
				Avg. (dBm)	Avg. (dBm)	Avg. (dBm)	Avg. (dBm)			

Test Conditions		Channel	Frequency	Ant3	Ant5	Ant6	Ant7	Total Power	Limit
Tnom (25 °C)	Vnom (120V)	149	5745	14.98	15.45	15.41	15.23	21.29	Pass
		157	5785	14.93	15.04	15.13	15.01	21.05	Pass
		165	5825	14.78	14.79	14.77	14.61	20.76	Pass

**Conducted power**

Mode:		802.11ax(40MHz)		Data Rate:		HE0NSS1		MIMO Mode(4TX+4RX)					
Test Conditions		Channel		Ant 3+5+6+7				Total Power		Limit			
				Frequency	Ant3	Ant5	Ant6					Ant7	
				(MHz)	Reading Level	Reading Level	Reading Level	Reading Level	Avg. (dBm)	Avg. (dBm)	Pass/Fail		
Tnom (25 °C)	Vnom (120V)	151	5755	15.03	15.37	15.60	15.39	21.37	21.92	Pass			
		159	5795	14.60	14.94	14.90	15.14	20.92	21.92	Pass			
Mode:		802.11ax(80MHz)		Data Rate:		HE0NSS1		Conducted power					
Test Conditions		Channel		Ant 3+5+6+7				Total Power		Limit			
				Frequency	Ant3	Ant5	Ant6					Ant7	
				(MHz)	Reading Level	Reading Level	Reading Level	Reading Level	Avg. (dBm)	Avg. (dBm)	Pass/Fail		
Tnom (25 °C)	Vnom (120V)	155	5775	14.37	14.29	14.43	14.69	20.47	21.92	Pass			

### Appendix 3: 5.15~5.25GHz FCC output power above 30° antenna gain

FCC 5GHz Power Table-Radio 1(>30° 5150~5250MHz Power)							
Standard:	FCC Part 15.407	Test Date:	2020.5.29	Temperature:	25°C	Humidity:	55%RH
Project No. :	2032034R			Product Name:	Wireless Access Point	Model Name:	AP460SC
Test Site:	TR8						
Antenna Gain(dBi)	Ant 4	4.31					
Test Eng:	Pawn						
Antenna Technology:	SISO						
Mode:	802.11a	Data Rate:	6Mbps	Conducted power		EIRP	
				SISO mode			
		Ant4		Total Power	Limit		
Test Conditions		Channel	Frequency	Reading Level	Ant4		
			(MHz)	Avg. (dBm)	Avg. (dBm)	Avg. (dBm)	Pass/Fail
Tnom (25 °C)	Vnom (120V)	36	5180	16.04	20.35	21.00	Pass
		40	5200	16.13	20.44	21.00	Pass
		44	5220	16.14	20.45	21.00	Pass
		48	5240	16.17	20.48	21.00	Pass
Mode:	802.11n(20MHz)	Data Rate:	MCS0	Conducted power		EIRP	
				SISO mode			
		Ant4		Total Power	Limit		
Test Conditions		Channel	Frequency	Reading Level	Ant4		
			(MHz)	Avg. (dBm)	Avg. (dBm)	Avg. (dBm)	Pass/Fail
Tnom (25 °C)	Vnom (120V)	36	5180	16.02	20.33	21.00	Pass
		40	5200	16.11	20.42	21.00	Pass
		44	5220	16.23	20.54	21.00	Pass
		48	5240	16.12	20.43	21.00	Pass
Mode:	802.11n(40MHz)	Data Rate:	MCS0	Conducted power		EIRP	
				SISO mode			
		Ant4		Total Power	Limit		
Test Conditions		Channel	Frequency	Reading Level	Ant4		
			(MHz)	Avg. (dBm)	Avg. (dBm)	Avg. (dBm)	Pass/Fail
Tnom (25 °C)	Vnom (120V)	38	5190	15.98	20.29	21.00	Pass
		46	5230	15.84	20.15	21.00	Pass
Mode:	802.11ac(20MHz)	Data Rate:	MCS0NSS1	Conducted power		EIRP	
				SISO mode			





Test Conditions		Channel	Frequency	Reading Level	Ant4		
			(MHz)	Avg. (dBm)	Avg. (dBm)	Avg. (dBm)	Pass/Fail
Tnom (25 °C)	Vnom (120V)	42	5210	16.22	20.53	21.00	Pass



# FCC 5GHz Power Table-Radio 2(>30° 5150~5250MHz Power)

Standard:	FCC Part 15.407	Test Date:	2020.5.29	Temperature:	25°C	Humidity:	55%RH			
Project No. :	2032034R			Product Name:	Wireless Access Point	Model Name:	AP460SC	Test Site:	TR8	
Antenna Gain(dBi)	Ant 1	5.72	Ant 2	5.46						
2*2 CDD-Directional Gain-Power(dBi)	5.72			2*2 BF-Directional Gain-Power(dBi)	8.73		Test Engineer	Pawn		
Test Eng:	Pawn									
Antenna Technology:	SISO									
Mode:	802.11a	Data Rate:	6Mbps	Conducted power				EIRP		
				SISO mode						
Test Conditions	Channel	Frequency	Reading Level		Reading Level		Total Power		Limit	
		(MHz)	Avg. (dBm)		Avg. (dBm)		Avg. (dBm)		Avg. (dBm)	Pass/Fail
Tnom (25°C)	Vnom (120V)	36	5180	14.60	14.86		20.32	20.32	21.00	Pass
		40	5200	14.82	14.98		20.54	20.44	21.00	Pass
		44	5220	14.74	15.07		20.46	20.53	21.00	Pass
		48	5240	14.58	14.93		20.30	20.39	21.00	Pass
Mode:	802.11n(20MHz)	Data Rate:	MCS0	Conducted power				EIRP		
				SISO mode						
Test Conditions	Channel	Frequency	Reading Level		Reading Level		Total Power		Limit	
		(MHz)	Avg. (dBm)		Avg. (dBm)		Avg. (dBm)		Avg. (dBm)	Pass/Fail
Tnom (25°C)	Vnom (120V)	36	5180	14.53	14.89		20.25	20.35	21.00	Pass
		40	5200	14.80	14.94		20.52	20.40	21.00	Pass
		44	5220	14.85	15.01		20.57	20.47	21.00	Pass
		48	5240	14.59	14.87		20.31	20.33	21.00	Pass
Mode:	802.11n(40MHz)	Data Rate:	MCS0	Conducted power				EIRP		
				SISO mode						
Test Conditions	Channel	Frequency	Reading Level		Reading Level		Total Power		Limit	
		(MHz)	Avg. (dBm)		Avg. (dBm)		Avg. (dBm)		Avg. (dBm)	Pass/Fail
Tnom (25°C)	Vnom (120V)	38	5190	14.39	14.73		20.11	20.19	21.00	Pass
		46	5230	14.78	15.04		20.50	20.50	21.00	Pass
Mode:	802.11ac(20MHz)	Data Rate:	MCS0NSS1	Conducted power				EIRP		
				SISO mode						
Test Conditions	Channel	Frequency	Reading Level		Reading Level		Total Power		Limit	
		(MHz)	Avg. (dBm)		Avg. (dBm)		Avg. (dBm)		Avg. (dBm)	Pass/Fail





Test Conditions		Channel	(MHz)	Avg. (dBm)		Avg. (dBm)		Avg. (dBm)	Pass/Fail		
Tnom (25 °C)	Vnom (120V)	42	5210	14.73		14.92		20.45	20.38	21.00	Pass
Antenna Technology:		CDD 2*2									
Mode:	802.11a	Data Rate:	6Mbps	Conducted power				EIRP			
				MIMO Mode(2TX+2RX)							
Test Conditions		Channel	Frequency	Reading Level				Total Power		Limit	
				Avg. (dBm)							
			(MHz)	Ant1	Ant2	Avg. (dBm) (Ant 1+2)		Avg. (dBm)	Pass/Fail		
Tnom (25 °C)	Vnom (120V)	36	5180	11.45	11.21	20.06		21.00	Pass		
		40	5200	11.72	11.53	20.36		21.00	Pass		
		44	5220	11.96	11.51	20.47		21.00	Pass		
		48	5240	11.58	11.20	20.12		21.00	Pass		
Mode:	802.11n(20MHz)	Data Rate:	MCS0	Conducted power				EIRP			
				MIMO Mode(2TX+2RX)							
Test Conditions		Channel	Frequency	Reading Level				Total Power		Limit	
				Avg. (dBm)							
			(MHz)	Ant1	Ant2	Avg. (dBm) (Ant 1+2)		Avg. (dBm)	Pass/Fail		
Tnom (25 °C)	Vnom (120V)	36	5180	11.41	11.17	20.02		21.00	Pass		
		40	5200	11.68	11.56	20.35		21.00	Pass		
		44	5220	11.91	11.59	20.48		21.00	Pass		
		48	5240	11.49	11.26	20.11		21.00	Pass		
Mode:	802.11n(40MHz)	Data Rate:	MCS0	Conducted power				EIRP			
				MIMO Mode(2TX+2RX)							
Test Conditions		Channel	Frequency	Reading Level				Total Power		Limit	
				Avg. (dBm)							
			(MHz)	Ant1	Ant2	Avg. (dBm) (Ant 1+2)		Avg. (dBm)	Pass/Fail		
Tnom (25 °C)	Vnom (120V)	38	5190	11.70	11.51	20.34		21.00	Pass		
		46	5230	11.92	11.59	20.49		21.00	Pass		
Mode:	802.11ac(20MHz)	Data Rate:	MCS0NSS1	Conducted power				EIRP			
				MIMO Mode(2TX+2RX)							
Test Conditions		Channel	Frequency	Reading Level				Total Power		Limit	
				Avg. (dBm)							
			(MHz)	Ant1	Ant2	Avg. (dBm) (Ant 1+2)		Avg. (dBm)	Pass/Fail		

Test Conditions		Channel		Ant1	Ant2	Avg. (dBm (Ant 1+2)	Avg. (dBm)	Pass/Fail
Tnom (25 °C)	Vnom (120V)	36	5180	11.51	11.30	20.14	21.00	Pass
		40	5200	11.81	11.51	20.39	21.00	Pass
		44	5220	11.85	11.54	20.43	21.00	Pass
		48	5240	11.45	11.37	20.14	21.00	Pass
Mode:	802.11ac(40MHz)	Data Rate:	MCS0NSS1	Conducted power		EIRP		
				MIMO Mode(2TX+2RX)		Total Power	Limit	
				Ant 1+2			Avg. (dBm (Ant 1+2)	Avg. (dBm)
				Frequency	Reading Level			
Test Conditions		Channel	Avg. (dBm)					
			(MHz)	Ant1	Ant2			
Tnom (25 °C)	Vnom (120V)	38	5190	11.57	11.38	20.21	21.00	Pass
		46	5230	11.89	11.65	20.50	21.00	Pass
Mode:	802.11ac(80MHz)	Data Rate:	MCS0NSS1	Conducted power		EIRP		
				MIMO Mode(2TX+2RX)		Total Power	Limit	
				Ant 1+2			Avg. (dBm (Ant 1+2)	Avg. (dBm)
				Frequency	Reading Level			
Test Conditions		Channel	Avg. (dBm)					
			(MHz)	Ant1	Ant2			
Tnom (25 °C)	Vnom (120V)	42	5210	11.63	11.43	20.26	21.00	Pass
Mode:	802.11ax(20MHz)	Data Rate:	HE0NSS1	Conducted power		EIRP		
				MIMO Mode(2TX+2RX)		Total Power	Limit	
				Ant 1+2			Avg. (dBm (Ant 1+2)	Avg. (dBm)
				Frequency	Reading Level			
Test Conditions		Channel	Avg. (dBm)					
			(MHz)	Ant1	Ant2			
Tnom (25 °C)	Vnom (120V)	36	5180	11.53	11.24	20.12	21.00	Pass
		40	5200	11.70	11.45	20.31	21.00	Pass
		44	5220	11.91	11.55	20.46	21.00	Pass
		48	5240	11.57	11.36	20.20	21.00	Pass
Mode:	802.11ax(40MHz)	Data Rate:	HE0NSS1	Conducted power		EIRP		
				MIMO Mode(2TX+2RX)		Total Power	Limit	
				Ant 1+2			Avg. (dBm (Ant 1+2)	Avg. (dBm)
				Frequency	Reading Level			
Test Conditions		Channel	Avg. (dBm)					
			(MHz)	Ant1	Ant2			
Tnom (25 °C)	Vnom (120V)	38	5190	11.57	11.40	20.22	21.00	Pass
		46	5230	11.94	11.62	20.51	21.00	Pass
				Conducted power		EIRP		

Test Conditions	Mode:	802.11ax(80MHz)	Data Rate:	HE0NSS1	MIMO Mode(2TX+2RX)			
	Channel	Frequency (MHz)	Ant 1+2		Total Power	Limit		
			Reading Level			Avg. (dBm) (Ant 1+2)	Avg. (dBm)	Pass/Fail
			Ant1	Ant2				
Tnom (25 °C)	Vnom (120V)	42	5210	11.61	11.49	20.28	21.00	Pass

Antenna Technology:	Beamforming 2*2							
Test Conditions	Mode:	802.11n(20MHz)	Data Rate:	MCS0	Conducted power		EIRP	
	Channel	Frequency (MHz)	Ant 1+2		Total Power	Limit		
			Reading Level			Avg. (dBm) (Ant 1+2)	Avg. (dBm)	Pass/Fail
			Ant1	Ant2				
Tnom (25 °C)	Vnom (120V)	36	5180	8.60	8.36	20.22	21.00	Pass
		40	5200	9.00	8.66	20.57	21.00	Pass
		44	5220	9.24	8.73	20.73	21.00	Pass
		48	5240	8.78	8.38	20.33	21.00	Pass
Test Conditions	Mode:	802.11n(40MHz)	Data Rate:	MCS0	Conducted power		EIRP	
	Channel	Frequency (MHz)	Ant 1+2		Total Power	Limit		
			Reading Level			Avg. (dBm) (Ant 1+2)	Avg. (dBm)	Pass/Fail
			Ant1	Ant2				
Tnom (25 °C)	Vnom (120V)	38	5190	8.81	8.49	20.39	21.00	Pass
		46	5230	9.12	8.86	20.73	21.00	Pass
Test Conditions	Mode:	802.11ac(20MHz)	Data Rate:	MCS0NSS1	Conducted power		EIRP	
	Channel	Frequency (MHz)	Ant 1+2		Total Power	Limit		
			Reading Level			Avg. (dBm) (Ant 1+2)	Avg. (dBm)	Pass/Fail
			Ant1	Ant2				
Tnom (25 °C)	Vnom (120V)	36	5180	8.65	8.44	20.29	21.00	Pass
		40	5200	9.00	8.78	20.63	21.00	Pass
		44	5220	9.11	8.62	20.61	21.00	Pass
		48	5240	8.87	8.38	20.37	21.00	Pass
					Conducted power		EIRP	

<b>Mode:</b>	<b>802.11ac(40MHz)</b>	<b>Data Rate:</b>	<b>MCS0NSS1</b>	<b>MIMO Mode(2TX+2RX)</b>						
<b>Test Conditions</b>		<b>Channel</b>	<b>Frequency</b>	<b>Ant 1+2</b>		<b>Total Power</b>	<b>Limit</b>			
			<b>Reading Level</b>							
			<b>Avg. (dBm)</b>							
		<b>(MHz)</b>	<b>Ant1</b>	<b>Ant2</b>	<b>Avg. (dBm)</b> <b>(Ant 1+2)</b>	<b>Avg. (dBm)</b>	<b>Pass/Fail</b>			
Tnom (25 °C)	Vnom (120V)	38	5190	8.65	8.55	20.34	21.00	Pass		
		46	5230	9.13	8.79	20.70	23.00	Pass		
<b>Mode:</b>	<b>802.11ac(80MHz)</b>	<b>Data Rate:</b>	<b>MCS0NSS1</b>	<b>Conducted power</b>					<b>EIRP</b>	
<b>Test Conditions</b>		<b>Channel</b>	<b>Frequency</b>	<b>Ant 1+2</b>		<b>Total Power</b>	<b>Limit</b>			
			<b>Reading Level</b>							
			<b>Avg. (dBm)</b>							
		<b>(MHz)</b>	<b>Ant1</b>	<b>Ant2</b>	<b>Avg. (dBm)</b> <b>(Ant 1+2)</b>	<b>Avg. (dBm)</b>	<b>Pass/Fail</b>			
Tnom (25 °C)	Vnom (120V)	42	5210	8.89	8.75	20.56	21.00	Pass		
<b>Mode:</b>	<b>802.11ax(20MHz)</b>	<b>Data Rate:</b>	<b>HE0NSS1</b>	<b>Conducted power</b>					<b>EIRP</b>	
<b>Test Conditions</b>		<b>Channel</b>	<b>Frequency</b>	<b>Ant 1+2</b>		<b>Total Power</b>	<b>Limit</b>			
			<b>Reading Level</b>							
			<b>Avg. (dBm)</b>							
		<b>(MHz)</b>	<b>Ant1</b>	<b>Ant2</b>	<b>Avg. (dBm)</b> <b>(Ant 1+2)</b>	<b>Avg. (dBm)</b>	<b>Pass/Fail</b>			
Tnom (25 °C)	Vnom (120V)	36	5180	8.71	8.34	20.27	21.00	Pass		
		40	5200	8.89	8.82	20.60	21.00	Pass		
		44	5220	9.18	8.67	20.67	21.00	Pass		
		48	5240	8.79	8.29	20.29	21.00	Pass		
<b>Mode:</b>	<b>802.11ax(40MHz)</b>	<b>Data Rate:</b>	<b>HE0NSS1</b>	<b>Conducted power</b>					<b>EIRP</b>	
<b>Test Conditions</b>		<b>Channel</b>	<b>Frequency</b>	<b>Ant 1+2</b>		<b>Total Power</b>	<b>Limit</b>			
			<b>Reading Level</b>							
			<b>Avg. (dBm)</b>							
		<b>(MHz)</b>	<b>Ant1</b>	<b>Ant2</b>	<b>Avg. (dBm)</b> <b>(Ant 1+2)</b>	<b>Avg. (dBm)</b>	<b>Pass/Fail</b>			
Tnom (25 °C)	Vnom (120V)	38	5190	8.65	8.66	20.40	21.00	Pass		
		46	5230	9.17	8.82	20.74	21.00	Pass		
<b>Mode:</b>	<b>802.11ax(80MHz)</b>	<b>Data Rate:</b>	<b>HE0NSS1</b>	<b>Conducted power</b>					<b>EIRP</b>	
<b>Test Conditions</b>		<b>Channel</b>	<b>Frequency</b>	<b>Ant 1+2</b>		<b>Total Power</b>	<b>Limit</b>			
			<b>Reading Level</b>							
			<b>Avg. (dBm)</b>							
		<b>(MHz)</b>	<b>Ant1</b>	<b>Ant2</b>	<b>Avg. (dBm)</b> <b>(Ant 1+2)</b>	<b>Avg. (dBm)</b>	<b>Pass/Fail</b>			
Tnom (25 °C)	Vnom (120V)	42	5210	8.83	8.61	20.46	21.00	Pass		

# FCC 5GHz Power Table-Radio 3(5G Full band mode)(> 30° 5150~5250MHz Power)



Standard:	FCC Part 15.407	Test Date:	2020.5.29	Temperature:	25°C	Humidity:	55%RH			
Project No. :	2032034R			Product Name:	Wireless Access Point	Model Name:	AP460SC	Test Site:	TR8	
Antenna Gain(dBi)	Ant 3	3.36	Ant 5	2.87	Ant 6	4.38	Ant 7	4.67		
2*2 CDD-Directional Gain-Power(dBi)	4.67			2*2 BF-Directional Gain-Power(dBi)	7.68					
4*4 CDD-Directional Gain-Power(dBi)	4.67			4*4 BF-Directional Gain-Power(dBi)	10.69					
Test Eng:	Pawn									
Antenna Technology:	CDD 2*2									
Mode:	802.11a	Data Rate:	6Mbps	Conducted power				EIRP		
Test Conditions	Channel	Frequency		Ant 3+5				Total Power		Limit
		Reading Level								
		Avg. (dBm)		Ant3		Ant5		Avg. (dBm (Ant 3+5))	Avg. (dBm)	Pass/Fail
Tnom (25°C)	Vnom (120V)	36	5180	12.44	12.76	20.28	21.00	Pass		
		40	5200	12.40	12.91	20.34	21.00	Pass		
		44	5220	12.50	13.11	20.50	21.00	Pass		
		48	5240	12.41	13.06	20.43	21.00	Pass		
Mode:	802.11n(20MHz)	Data Rate:	MCS0	Conducted power				EIRP		
Test Conditions	Channel	Frequency		Ant 3+5				Total Power		Limit
		Reading Level								
		Avg. (dBm)		Ant3		Ant5		Avg. (dBm (Ant 3+5))	Avg. (dBm)	Pass/Fail
Tnom (25°C)	Vnom (120V)	36	5180	12.33	12.86	20.28	21.00	Pass		
		40	5200	12.38	13.04	20.40	21.00	Pass		
		44	5220	12.54	13.10	20.51	21.00	Pass		
		48	5240	12.38	13.04	20.40	21.00	Pass		
Mode:	802.11n(40MHz)	Data Rate:	MCS0	Conducted power				EIRP		
Test Conditions	Channel	Frequency		Ant 3+5				Total Power		Limit
		Reading Level								
		Avg. (dBm)		Ant3		Ant5		Avg. (dBm (Ant 3+5))	Avg. (dBm)	Pass/Fail
Tnom (25°C)	Vnom (120V)	38	5190	12.44	13.07	20.45	21.00	Pass		
		46	5230	12.43	13.10	20.46	21.00	Pass		
Mode:	802.11ac(20MHz)	Data Rate:	MCS0NSS1	Conducted power				EIRP		
Test Conditions	Channel	Frequency		Ant 3+5				Total Power		Limit
		Reading Level								
		Avg. (dBm)		Ant3		Ant5		Avg. (dBm (Ant 3+5))	Avg. (dBm)	Pass/Fail
Tnom (25°C)	Vnom (120V)	36	5180	12.42	12.72	20.25	21.00	Pass		
		40	5200	12.25	13.01	20.33	21.00	Pass		
		44	5220	12.44	12.97	20.39	21.00	Pass		
		48	5240	12.32	13.00	20.35	21.00	Pass		
Mode:	802.11ac(40MHz)	Data Rate:	MCS0NSS1	Conducted power				EIRP		
Test Conditions	Channel	Frequency		Ant 3+5				Total Power		Limit
		Reading Level								

Test Conditions		Channel	Avg. (dBm)				Avg. (dBm)		Avg. (dBm)		Pass/Fail
			(MHz)	Ant3	Ant5	Avg. (dBm)		Avg. (dBm)	Pass/Fail		
				Conducted power		EIRP					
				MIMO Mode(2TX+2RX)							
				Ant 3+5		Total Power		Limit			
				Reading Level		Avg. (dBm)					
			(MHz)	Ant3	Ant5	Avg. (dBm)		Avg. (dBm)	Pass/Fail		
Tnom (25°C)	Vnom (120V)	38	5190	12.42	13.08	20.44		21.00	Pass		
		46	5230	12.58	13.17	20.57		21.00	Pass		
Mode:	802.11ac(80MHz)	Data Rate:	MCS0NSS1	Conducted power				EIRP			
				MIMO Mode(2TX+2RX)							
				Ant 3+5		Total Power		Limit			
				Reading Level		Avg. (dBm)					
			(MHz)	Ant3	Ant5	Avg. (dBm)		Avg. (dBm)	Pass/Fail		
Tnom (25°C)	Vnom (120V)	42	5210	12.27	12.65	20.14		21.00	Pass		
						Conducted power		EIRP			
Mode:	802.11ax(20MHz)	Data Rate:	HE0NSS1	MIMO Mode(2TX+2RX)							
				Ant 3+5		Total Power		Limit			
				Reading Level		Avg. (dBm)					
			(MHz)	Ant3	Ant5	Avg. (dBm)		Avg. (dBm)	Pass/Fail		
Tnom (25°C)	Vnom (120V)	36	5180	12.40	12.73	20.25		21.00	Pass		
		40	5200	12.39	12.98	20.38		21.00	Pass		
		44	5220	12.44	13.13	20.48		21.00	Pass		
		48	5240	12.31	13.09	20.40		21.00	Pass		
Mode:	802.11ax(40MHz)	Data Rate:	HE0NSS1	Conducted power				EIRP			
				MIMO Mode(2TX+2RX)							
				Ant 3+5		Total Power		Limit			
				Reading Level		Avg. (dBm)					
			(MHz)	Ant3	Ant5	Avg. (dBm)		Avg. (dBm)	Pass/Fail		
Tnom (25°C)	Vnom (120V)	38	5190	12.44	12.92	20.37		21.00	Pass		
		46	5230	12.60	13.15	20.56		21.00	Pass		
Mode:	802.11ax(80MHz)	Data Rate:	HE0NSS1	Conducted power				EIRP			
				MIMO Mode(2TX+2RX)							
				Ant 3+5		Total Power		Limit			
				Reading Level		Avg. (dBm)					
			(MHz)	Ant3	Ant5	Avg. (dBm)		Avg. (dBm)	Pass/Fail		
Tnom (25°C)	Vnom (120V)	42	5210	12.21	12.59	20.08		21.00	Pass		

Antenna Technology:		CDD 4*4											
			Conducted power				EIRP						
			MIMO Mode(4TX+4RX)										
			Ant 3+5+6+7				Total Power		Limit				
			Ant3	Ant5	Ant6	Ant7	Avg. (dBm)		Avg. (dBm)	Pass/Fail			
			Reading Level	Reading Level	Reading Level	Reading Level	Avg. (dBm)		Avg. (dBm)	Pass/Fail			
			(MHz)	Avg. (dBm)	Avg. (dBm)	Avg. (dBm)	Avg. (dBm)	Avg. (dBm)		Avg. (dBm)	Pass/Fail		
Tnom (25°C)	Vnom (120V)	36	5180	9.41	9.81	9.27	9.56	20.21		21.00	Pass		
		40	5200	9.25	10.05	9.34	9.84	20.32		21.00	Pass		
		44	5220	9.58	9.96	9.60	9.98	20.47		21.00	Pass		
		48	5240	9.40	10.00	9.42	9.82	20.36		21.00	Pass		
Mode:	802.11n(20MHz)	Data Rate:	MCS0	Conducted power				EIRP					
				MIMO Mode(4TX+4RX)									
				Ant 3+5+6+7				Total Power		Limit			
				Ant3		Ant5		Ant6		Ant7			
				Reading Level		Reading Level		Reading Level		Reading Level			



Test Conditions		Channel	(MHz)	Avg. (dBm)	Avg. (dBm)	Avg. (dBm)	Avg. (dBm)	Avg. (dBm) (Ant 3+5+6+7)	Avg. (dBm)	Pass/Fail
Tnom (25 °C)	Vnom (120V)	36	5180	9.47	9.73	9.37	9.62	20.24	21.00	Pass
		40	5200	9.28	9.98	9.35	9.91	20.33	21.00	Pass
		44	5220	9.58	10.15	9.48	10.07	20.52	21.00	Pass
		48	5240	9.32	10.00	9.35	9.77	20.31	21.00	Pass
Mode:	802.11n(40MHz)	Data Rate:	MCS0	Conducted power				EIRP		
				MIMO Mode(4TX+4RX)						
				Ant 3+5+6+7						
Test Conditions		Channel	Frequency	Ant3	Ant5	Ant6	Ant7	Total Power		Limit
				Reading Level	Reading Level	Reading Level	Reading Level			
			(MHz)	Avg. (dBm)	Avg. (dBm)	Avg. (dBm)	Avg. (dBm)	Avg. (dBm) (Ant 3+5+6+7)		Avg. (dBm)
Tnom (25 °C)	Vnom (120V)	38	5190	9.54	10.07	9.88	10.14	20.60	21.00	Pass
		46	5230	9.60	10.12	10.04	10.13	20.67	21.00	Pass
Mode:	802.11ac(20MHz)	Data Rate:	MCS0NSS1	Conducted power				EIRP		
				MIMO Mode(4TX+4RX)						
				Ant 3+5+6+7						
Test Conditions		Channel	Frequency	Ant3	Ant5	Ant6	Ant7	Total Power		Limit
				Reading Level	Reading Level	Reading Level	Reading Level			
			(MHz)	Avg. (dBm)	Avg. (dBm)	Avg. (dBm)	Avg. (dBm)	Avg. (dBm) (Ant 3+5+6+7)		Avg. (dBm)
Tnom (25 °C)	Vnom (120V)	36	5180	9.40	9.73	9.34	9.51	20.19	21.00	Pass
		40	5200	9.39	10.02	9.46	9.94	20.40	21.00	Pass
		44	5220	9.54	10.11	9.67	9.91	20.50	21.00	Pass
		48	5240	9.24	10.07	9.36	9.68	20.29	21.00	Pass
Mode:	802.11ac(40MHz)	Data Rate:	MCS0NSS1	Conducted power				EIRP		
				MIMO Mode(4TX+4RX)						
				Ant 3+5+6+7						
Test Conditions		Channel	Frequency	Ant3	Ant5	Ant6	Ant7	Total Power		Limit
				Reading Level	Reading Level	Reading Level	Reading Level			
			(MHz)	Avg. (dBm)	Avg. (dBm)	Avg. (dBm)	Avg. (dBm)	Avg. (dBm) (Ant 3+5+6+7)		Avg. (dBm)
Tnom (25 °C)	Vnom (120V)	38	5190	9.46	9.97	9.84	10.23	20.57	21.00	Pass
		46	5230	9.49	10.09	10.05	10.10	20.63	21.00	Pass
Mode:	802.11ac(80MHz)	Data Rate:	MCS0NSS1	Conducted power				EIRP		
				MIMO Mode(4TX+4RX)						
				Ant 3+5+6+7						
Test Conditions		Channel	Frequency	Ant3	Ant5	Ant6	Ant7	Total Power		Limit
				Reading Level	Reading Level	Reading Level	Reading Level			
			(MHz)	Avg. (dBm)	Avg. (dBm)	Avg. (dBm)	Avg. (dBm)	Avg. (dBm) (Ant 3+5+6+7)		Avg. (dBm)
Tnom (25 °C)	Vnom (120V)	42	5210	9.03	9.52	9.46	9.61	20.10	21.00	Pass
Mode:	802.11ax(20MHz)	Data Rate:	HE0NSS1	Conducted power				EIRP		
				MIMO Mode(4TX+4RX)						
				Ant 3+5+6+7						
Test Conditions		Channel	Frequency	Ant3	Ant5	Ant6	Ant7	Total Power		Limit
				Reading Level	Reading Level	Reading Level	Reading Level			
			(MHz)	Avg. (dBm)	Avg. (dBm)	Avg. (dBm)	Avg. (dBm)	Avg. (dBm) (Ant 3+5+6+7)		Avg. (dBm)
Tnom (25 °C)	Vnom (120V)	36	5180	9.32	9.87	9.40	9.57	20.24	21.00	Pass
		40	5200	9.37	10.02	9.46	9.95	20.40	21.00	Pass
		44	5220	9.46	10.11	9.60	10.07	20.51	21.00	Pass
		48	5240	9.31	9.91	9.36	9.75	20.28	21.00	Pass
Mode:	802.11ax(40MHz)	Data Rate:	HE0NSS1	Conducted power				EIRP		
				MIMO Mode(4TX+4RX)						
				Ant 3+5+6+7						
Test Conditions		Channel	Frequency	Ant3	Ant5	Ant6	Ant7	Total Power		Limit
				Reading Level	Reading Level	Reading Level	Reading Level			
			(MHz)	Avg. (dBm)	Avg. (dBm)	Avg. (dBm)	Avg. (dBm)	Avg. (dBm) (Ant 3+5+6+7)		Avg. (dBm)
Tnom (25 °C)	Vnom (120V)	38	5190	9.55	9.93	9.81	10.23	20.58	21.00	Pass

Tnom (25 °C)	Vnom (120V)	46	5230	9.48	10.22	9.91	10.20	20.65	21.00	Pass			
Mode:	802.11ax(80MHz)	Data Rate:	HE0NSS1	Conducted power				EIRP					
				MIMO Mode(4TX+4RX)									
Test Conditions	Channel	Frequency (MHz)	Ant3		Ant5		Ant6		Ant7		Total Power	Limit	
			Reading Level		Reading Level		Reading Level		Reading Level			Avg. (dBm (Ant 3+5+6+7))	Avg. (dBm)
			Avg. (dBm)		Avg. (dBm)		Avg. (dBm)		Avg. (dBm)				
Tnom (25 °C)	Vnom (120V)	42	5210	9.01	9.52	9.49	9.56	20.09	21.00	Pass			

Antenna Technology:		Beamforming 2*2									
Mode:	802.11n(20MHz)	Data Rate:	MCS0	Conducted power				EIRP			
				MIMO Mode(2TX+2RX)							
Test Conditions	Channel	Frequency (MHz)	Ant3		Ant5		Total Power		Limit		
			Reading Level		Reading Level		Avg. (dBm (Ant 3+5))		Avg. (dBm)	Pass/Fail	
			Avg. (dBm)		Avg. (dBm)						
Tnom (25 °C)	Vnom (120V)	36	5180	9.50		9.73		20.31		21.00	Pass
		40	5200	9.39		9.85		20.32		21.00	Pass
		44	5220	9.45		10.07		20.46		21.00	Pass
		48	5240	9.43		9.99		20.41		21.00	Pass
Mode:	802.11n(40MHz)	Data Rate:	MCS0	Conducted power				EIRP			
				MIMO Mode(2TX+2RX)							
Test Conditions	Channel	Frequency (MHz)	Ant3		Ant5		Total Power		Limit		
			Reading Level		Reading Level		Avg. (dBm (Ant 3+5))		Avg. (dBm)	Pass/Fail	
			Avg. (dBm)		Avg. (dBm)						
Tnom (25 °C)	Vnom (120V)	38	5190	9.45		10.01		20.43		21.00	Pass
		46	5230	9.53		10.12		20.53		21.00	Pass
Mode:	802.11ac(20MHz)	Data Rate:	MCS0NSS1	Conducted power				EIRP			
				MIMO Mode(2TX+2RX)							
Test Conditions	Channel	Frequency (MHz)	Ant3		Ant5		Total Power		Limit		
			Reading Level		Reading Level		Avg. (dBm (Ant 3+5))		Avg. (dBm)	Pass/Fail	
			Avg. (dBm)		Avg. (dBm)						
Tnom (25 °C)	Vnom (120V)	36	5180	9.43		9.70		20.26		21.00	Pass
		40	5200	9.45		9.85		20.35		21.00	Pass
		44	5220	9.53		10.05		20.49		21.00	Pass
		48	5240	9.36		10.01		20.39		21.00	Pass
Mode:	802.11ac(40MHz)	Data Rate:	MCS0NSS1	Conducted power				EIRP			
				MIMO Mode(2TX+2RX)							
Test Conditions	Channel	Frequency (MHz)	Ant3		Ant5		Total Power		Limit		
			Reading Level		Reading Level		Avg. (dBm (Ant 3+5))		Avg. (dBm)	Pass/Fail	
			Avg. (dBm)		Avg. (dBm)						
Tnom (25 °C)	Vnom (120V)	38	5190	9.35		10.06		20.41		21.00	Pass
		46	5230	9.64		10.24		20.64		21.00	Pass
Mode:	802.11ac(80MHz)	Data Rate:	MCS0NSS1	Conducted power				EIRP			
				MIMO Mode(2TX+2RX)							
Test Conditions	Channel	Frequency (MHz)	Ant3		Ant5		Total Power		Limit		
			Reading Level		Reading Level		Avg. (dBm (Ant 3+5))		Avg. (dBm)	Pass/Fail	
			Avg. (dBm)		Avg. (dBm)						
Tnom (25 °C)	Vnom (120V)	42	5210	9.83		10.08		20.65		21.00	Pass
				Conducted power				EIRP			

Mode:	802.11ax(20MHz)	Data Rate:	HE0NSS1	MIMO Mode(2TX+2RX)				EIRP	
Test Conditions	Channel	Frequency (MHz)	Ant3		Ant5		Total Power Avg. (dBm) (Ant 3+5)	Limit	
			Reading Level	Reading Level	Reading Level	Reading Level		Avg. (dBm)	Pass/Fail
			Avg. (dBm)	Avg. (dBm)	Avg. (dBm)	Avg. (dBm)			
Tnom (25 °C)	Vnom (120V)	36	5180	9.38	9.82	20.30	21.00	Pass	
		40	5200	9.43	9.86	20.34	21.00	Pass	
		44	5220	9.50	10.18	20.54	21.00	Pass	
		48	5240	9.40	10.13	20.47	21.00	Pass	
Mode:	802.11ax(40MHz)	Data Rate:	HE0NSS1	MIMO Mode(2TX+2RX)				EIRP	
Test Conditions	Channel	Frequency (MHz)	Ant3		Ant5		Total Power Avg. (dBm) (Ant 3+5)	Limit	
			Reading Level	Reading Level	Reading Level	Reading Level		Avg. (dBm)	Pass/Fail
			Avg. (dBm)	Avg. (dBm)	Avg. (dBm)	Avg. (dBm)			
Tnom (25 °C)	Vnom (120V)	38	5190	9.39	10.02	20.41	21.00	Pass	
		46	5230	9.56	10.13	20.54	21.00	Pass	
Mode:	802.11ax(80MHz)	Data Rate:	HE0NSS1	MIMO Mode(2TX+2RX)				EIRP	
Test Conditions	Channel	Frequency (MHz)	Ant3		Ant5		Total Power Avg. (dBm) (Ant 3+5)	Limit	
			Reading Level	Reading Level	Reading Level	Reading Level		Avg. (dBm)	Pass/Fail
			Avg. (dBm)	Avg. (dBm)	Avg. (dBm)	Avg. (dBm)			
Tnom (25 °C)	Vnom (120V)	42	5210	9.77	10.15	20.65	21.00	Pass	

Antenna Technology:	Beamforming 4*4										
Mode:	802.11n(20MHz)	Data Rate:	MCS0	MIMO Mode(4TX+4RX)				EIRP			
Test Conditions	Channel	Frequency (MHz)	Ant3		Ant5		Ant6		Ant7		
			Reading Level	Reading Level	Reading Level	Reading Level	Reading Level	Reading Level	Total Power Avg. (dBm) (Ant 3+5+6+7)	Limit	
			Avg. (dBm)	Avg. (dBm)	Avg. (dBm)	Avg. (dBm)	Avg. (dBm)	Avg. (dBm)		Avg. (dBm)	Pass/Fail
Tnom (25 °C)	Vnom (120V)	36	5180	3.40	3.82	3.21	3.53	20.21	21.00	Pass	
		40	5200	3.17	4.05	3.35	3.73	20.30	21.00	Pass	
		44	5220	3.45	3.97	3.50	3.98	20.44	21.00	Pass	
		48	5240	3.33	3.97	3.35	3.84	20.34	21.00	Pass	
Mode:	802.11n(40MHz)	Data Rate:	MCS0	MIMO Mode(4TX+4RX)				EIRP			
Test Conditions	Channel	Frequency (MHz)	Ant3		Ant5		Ant6		Ant7		
			Reading Level	Reading Level	Reading Level	Reading Level	Reading Level	Reading Level	Total Power Avg. (dBm) (Ant 3+5+6+7)	Limit	
			Avg. (dBm)	Avg. (dBm)	Avg. (dBm)	Avg. (dBm)	Avg. (dBm)	Avg. (dBm)		Avg. (dBm)	Pass/Fail
Tnom (25 °C)	Vnom (120V)	38	5190	3.44	3.86	3.72	4.11	20.50	21.00	Pass	
		46	5230	3.43	4.10	3.90	4.13	20.61	21.00	Pass	
Mode:	802.11ac(20MHz)	Data Rate:	MCS0NSS1	MIMO Mode(4TX+4RX)				EIRP			
Test Conditions	Channel	Frequency (MHz)	Ant3		Ant5		Ant6		Ant7		
			Reading Level	Reading Level	Reading Level	Reading Level	Reading Level	Reading Level	Total Power Avg. (dBm) (Ant 3+5+6+7)	Limit	
			Avg. (dBm)	Avg. (dBm)	Avg. (dBm)	Avg. (dBm)	Avg. (dBm)	Avg. (dBm)		Avg. (dBm)	Pass/Fail
Tnom (25 °C)	Vnom (120V)	36	5180	3.37	3.79	3.21	3.43	20.17	21.00	Pass	
		40	5200	3.19	3.97	3.26	3.76	20.27	21.00	Pass	
		44	5220	3.58	3.91	3.57	3.88	20.45	21.00	Pass	
		48	5240	3.32	4.00	3.43	3.70	20.33	21.00	Pass	
Conducted power				EIRP							

Mode:	802.11ac(40MHz)	Data Rate:	MCS0NSS1	MIMO Mode(4TX+4RX)						
Test Conditions	Channel	Ant 3+5+6+7				Total Power		Limit		
		Frequency	Ant3	Ant5	Ant6	Ant7	Avg. (dBm) (Ant 3+5+6+7)	Avg. (dBm)	Pass/Fail	
		(MHz)	Reading Level	Reading Level	Reading Level	Reading Level				
Tnom (25 °C)	Vnom (120V)	38	5190	3.43	3.82	3.71	4.25	20.52	21.00	Pass
		46	5230	3.45	4.15	3.81	4.08	20.59	21.00	Pass
Mode:	802.11ac(80MHz)	Data Rate:	MCS0NSS1	MIMO Mode(4TX+4RX)						
Test Conditions	Channel	Ant 3+5+6+7				Total Power		Limit		
		Frequency	Ant3	Ant5	Ant6	Ant7	Avg. (dBm) (Ant 3+5+6+7)	Avg. (dBm)	Pass/Fail	
		(MHz)	Reading Level	Reading Level	Reading Level	Reading Level				
Tnom (25 °C)	Vnom (120V)	42	5210	3.68	4.22	3.92	4.07	20.69	21.00	Pass
Mode:	802.11ax(20MHz)	Data Rate:	HE0NSS1	MIMO Mode(4TX+4RX)						
Test Conditions	Channel	Ant 3+5+6+7				Total Power		Limit		
		Frequency	Ant3	Ant5	Ant6	Ant7	Avg. (dBm) (Ant 3+5+6+7)	Avg. (dBm)	Pass/Fail	
		(MHz)	Reading Level	Reading Level	Reading Level	Reading Level				
Tnom (25 °C)	Vnom (120V)	36	5180	3.39	3.78	3.21	3.50	20.19	21.00	Pass
		40	5200	3.16	3.98	3.20	3.71	20.24	21.00	Pass
		44	5220	3.45	3.83	3.49	3.99	20.41	21.00	Pass
		48	5240	3.27	3.91	3.28	3.78	20.28	21.00	Pass
Mode:	802.11ax(40MHz)	Data Rate:	HE0NSS1	MIMO Mode(4TX+4RX)						
Test Conditions	Channel	Ant 3+5+6+7				Total Power		Limit		
		Frequency	Ant3	Ant5	Ant6	Ant7	Avg. (dBm) (Ant 3+5+6+7)	Avg. (dBm)	Pass/Fail	
		(MHz)	Reading Level	Reading Level	Reading Level	Reading Level				
Tnom (25 °C)	Vnom (120V)	38	5190	3.48	3.83	3.74	4.22	20.54	21.00	Pass
		46	5230	3.34	4.21	3.80	4.20	20.61	21.00	Pass
Mode:	802.11ax(80MHz)	Data Rate:	HE0NSS1	MIMO Mode(4TX+4RX)						
Test Conditions	Channel	Ant 3+5+6+7				Total Power		Limit		
		Frequency	Ant3	Ant5	Ant6	Ant7	Avg. (dBm) (Ant 3+5+6+7)	Avg. (dBm)	Pass/Fail	
		(MHz)	Reading Level	Reading Level	Reading Level	Reading Level				
Tnom (25 °C)	Vnom (120V)	42	5210	3.61	4.16	3.92	4.21	20.69	21.00	Pass

ANT1  
Vertical

Frequency(MHz)	Peak Gain Above 30°C (dBi)
2400	5.30
2450	6.04
2500	5.99
5150	5.72
5350	6.15
5500	6.58
5725	6.42
5850	6.20

Horizontal

Frequency(MHz)	Peak Gain Above 30°C (dBi)
2400	-10.41
2450	-10.10
2500	-11.72
5150	-7.65
5350	-9.35
5500	-10.23
5725	-6.51
5850	-5.63

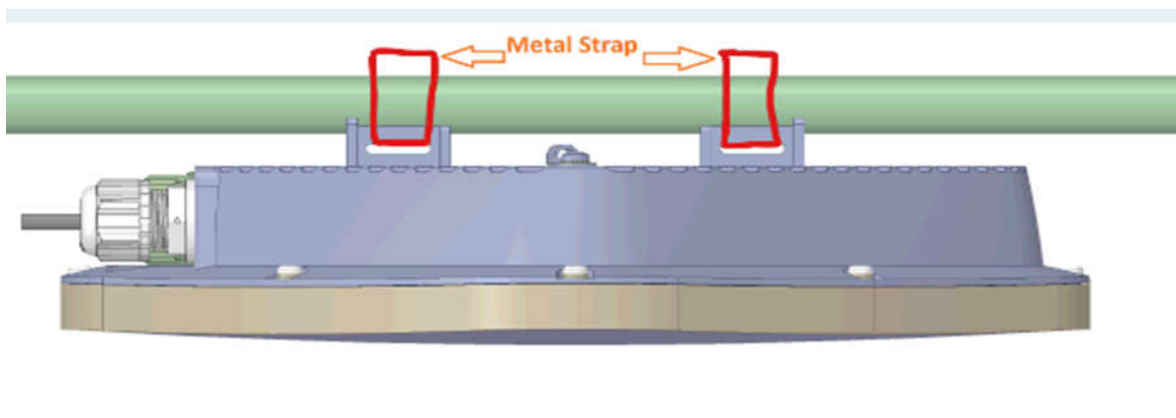
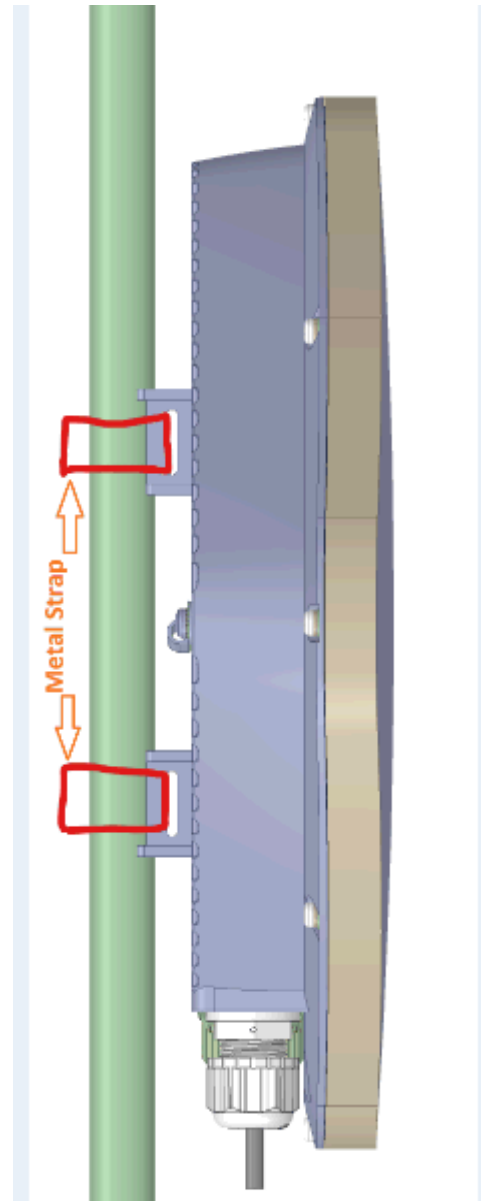

ANT2  
Vertical

Frequency(MHz)	Peak Gain Above 30°C (dBi)
2400	5.16
2450	6.58
2500	6.91
5150	5.46
5350	4.57
5500	4.44
5725	4.14
5850	4.74

Horizontal

Frequency(MHz)	Peak Gain Above 30°C (dBi)
2400	-7.45
2450	-10.03
2500	-10.69
5150	-8.08
5350	-7.99
5500	-7.74
5725	-7.75
5850	-9.46

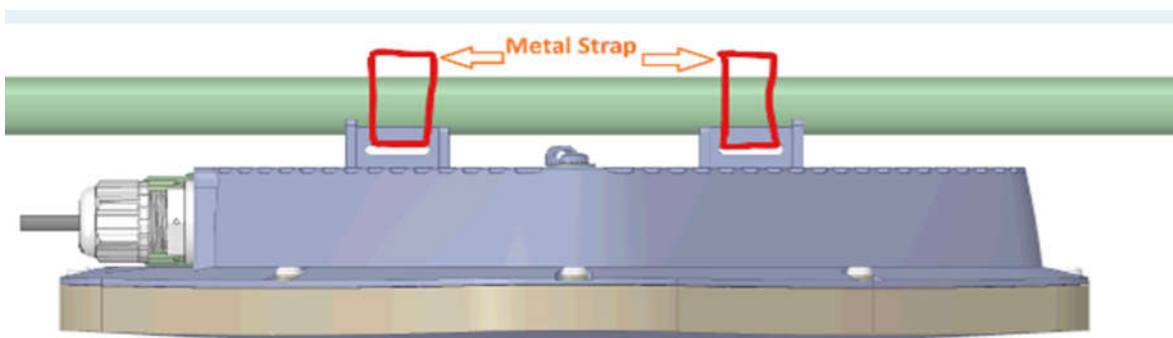
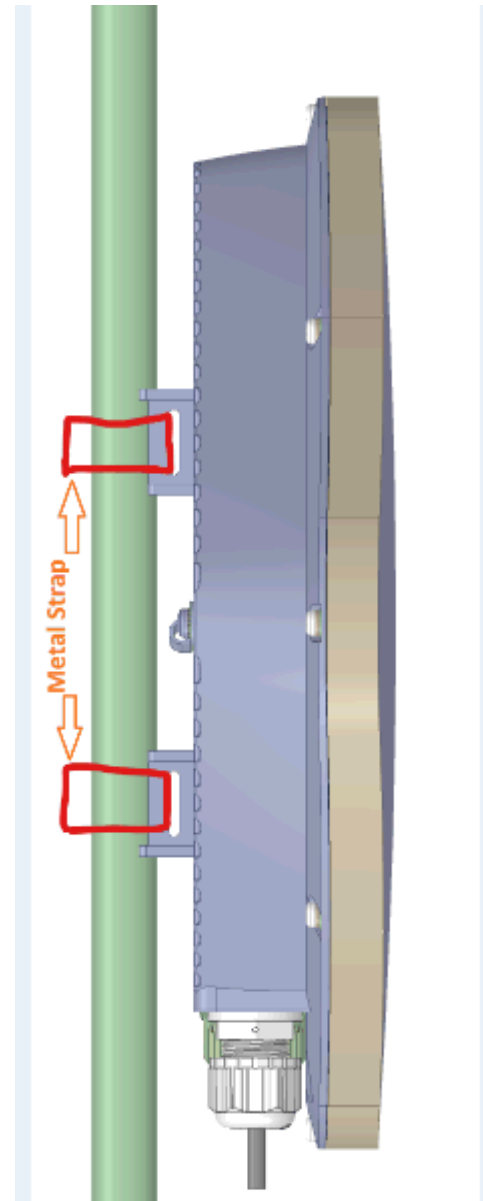

ANT3  
Vertical

Frequency(MHz)	Peak Gain Above 30°C (dBi)
2400	5.93
2450	6.21
2500	6.31
5150	3.36
5350	4.70
5500	4.49
5725	4.40
5850	3.77

Horizontal

Frequency(MHz)	Peak Gain Above 30°C (dBi)
2400	-8.55
2450	-7.92
2500	-7.27
5150	-8.80
5350	-8.18
5500	-4.33
5725	-4.74
5850	-4.46

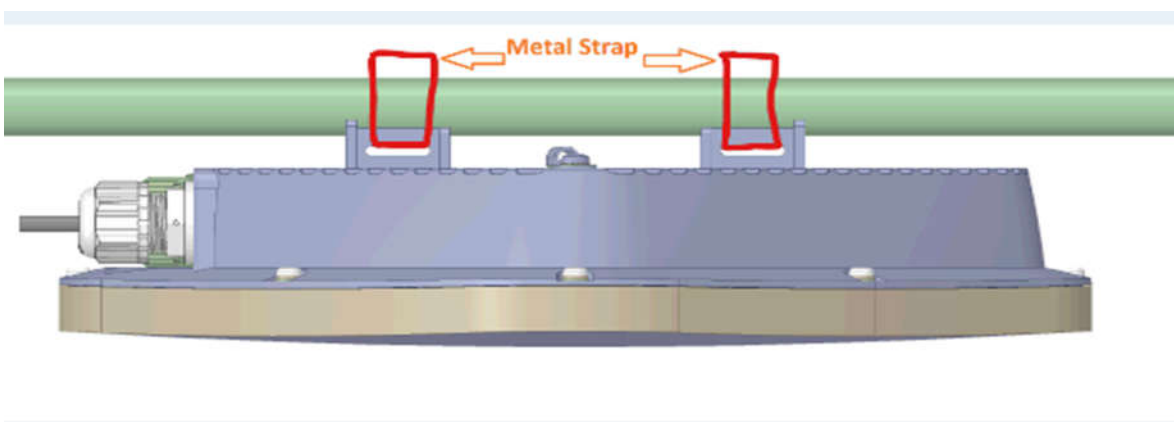
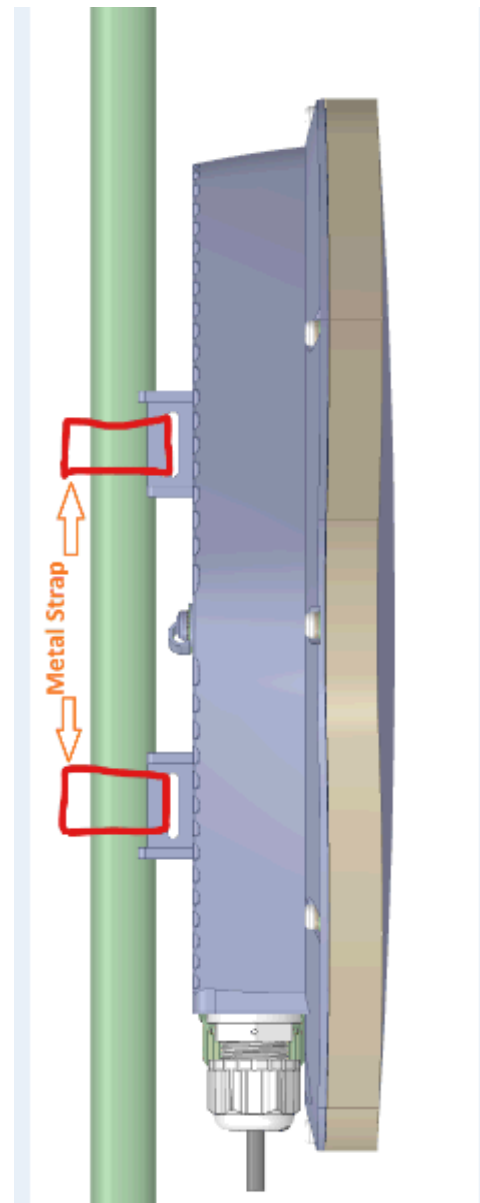

ANT4  
Vertical

Frequency(MHz)	Peak Gain Above 30°C (dBi)
2400	6.14
2450	5.58
2500	5.90
5150	4.31
5350	5.57
5500	5.69
5725	4.24
5850	3.47

Horizontal

Frequency(MHz)	Peak Gain Above 30°C (dBi)
2400	-9.00
2450	-9.28
2500	-9.64
5150	-8.82
5350	-8.99
5500	-6.47
5725	-6.84
5850	-6.73

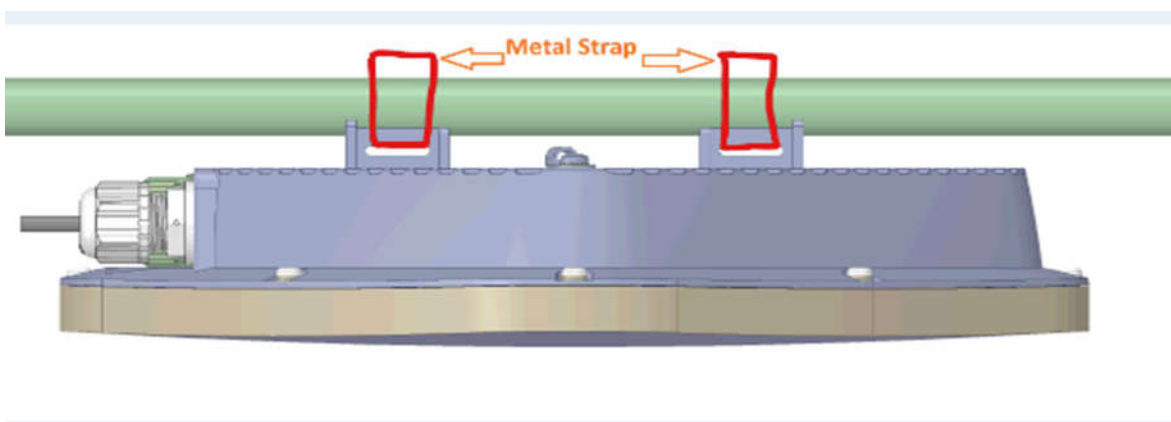
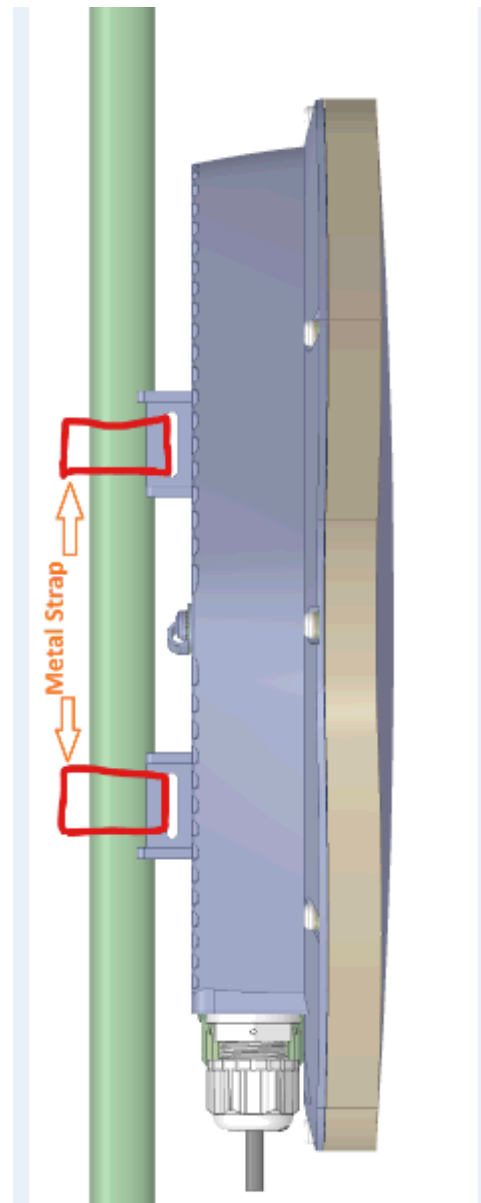



ANT5  
Vertical

Frequency(MHz)	Peak Gain Above 30°C (dBi)
5150	2.87
5350	2.65
5500	3.46
5725	3.45
5850	2.60

Horizontal

Frequency(MHz)	Peak Gain Above 30°C (dBi)
5150	-7.12
5350	-10.68
5500	-11.18
5725	-9.97
5850	-8.13

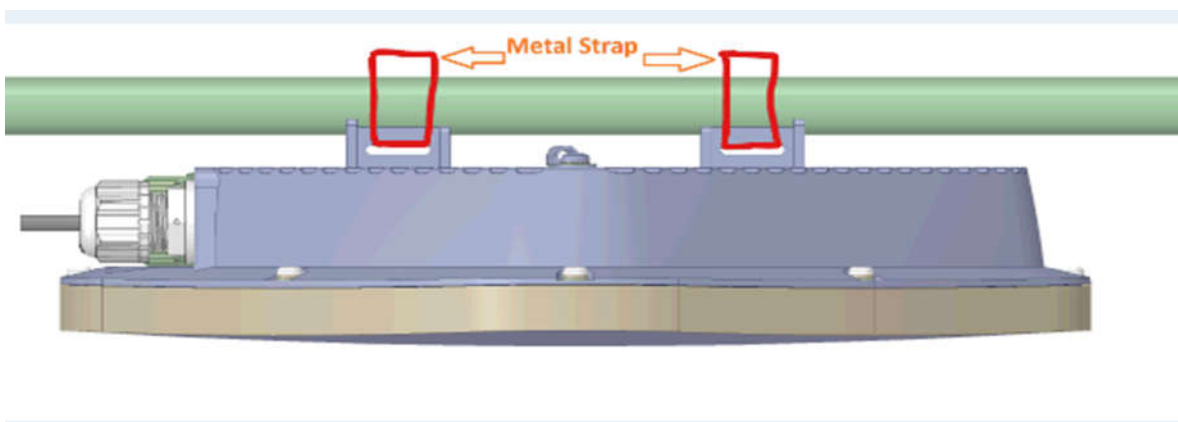
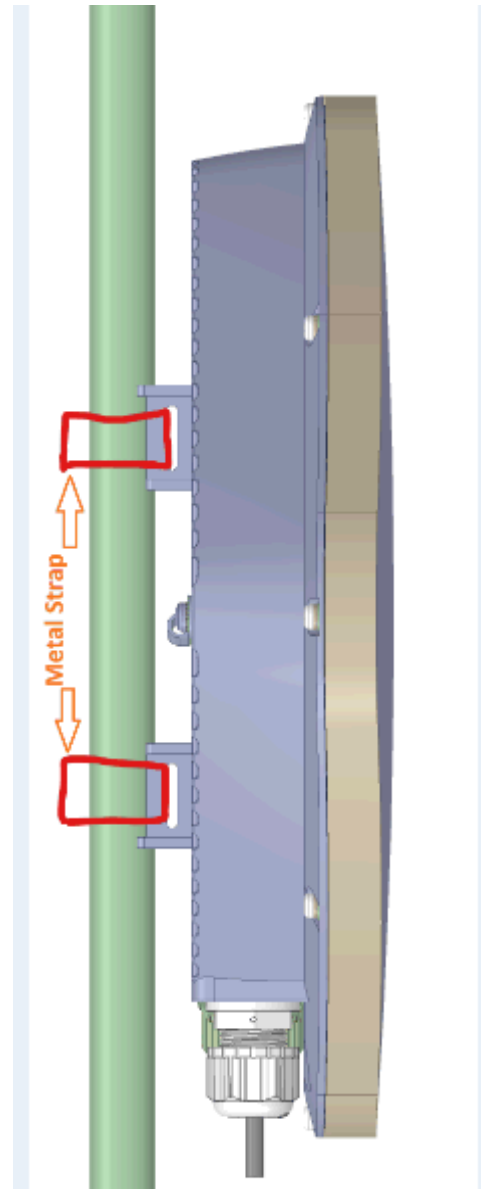

ANT6  
Vertical

Frequency(MHz)	Peak Gain Above 30°C (dBi)
5150	4.38
5350	4.83
5500	4.75
5725	3.98
5850	3.71

Horizontal

Frequency(MHz)	Peak Gain Above 30°C (dBi)
5150	-4.18
5350	-5.77
5500	-8.09
5725	-6.71
5850	-5.70

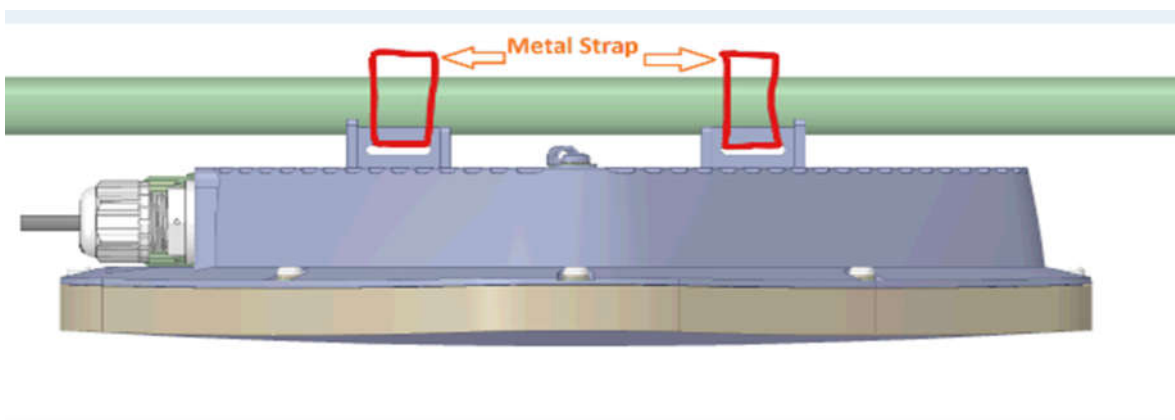
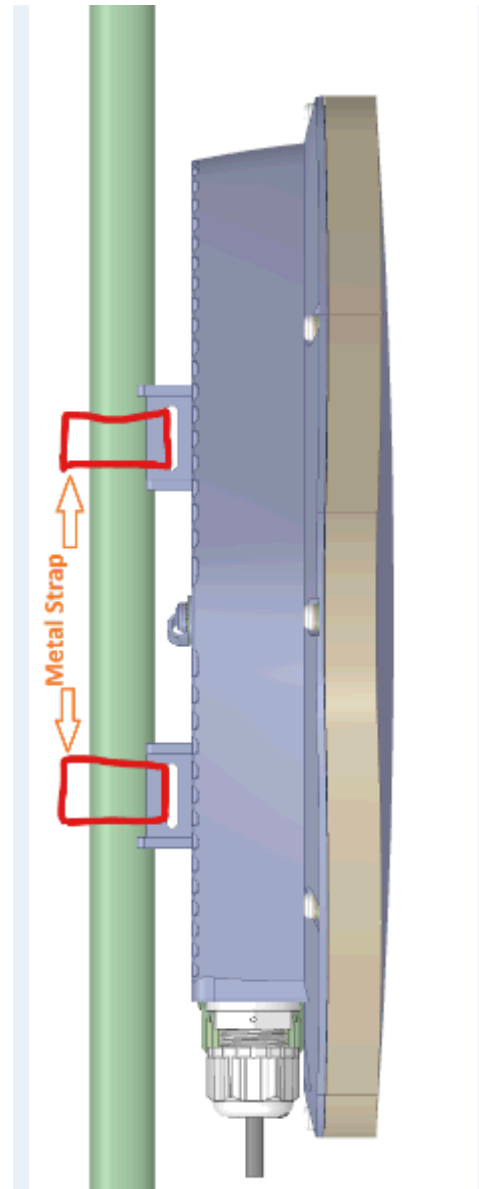

ANT7  
Vertical

Frequency(MHz)	Peak Gain Above 30°C (dBi)
5150	4.67
5350	5.28
5500	4.97
5725	5.60
5850	5.60

Horizontal

Frequency(MHz)	Peak Gain Above 30°C (dBi)
5150	-4.08
5350	-8.50
5500	-10.42
5725	-9.36
5850	-10.40

