



RADIO TEST REPORT

FCC ID : QXO-AP4000
Equipment : Access Point
Brand Name : Extreme Networks
Model Name : AP4000
Applicant : Extreme Networks, Inc.
6480 Via Del Oro, San Jose, CA 95119
Manufacturer : Extreme Networks, Inc.
6480 Via Del Oro, San Jose, CA 95119
Standard : 47 CFR FCC Part 15.247

The product was received on May 13, 2021, and testing was started from May 21, 2021 and completed on Oct. 25, 2021. We, Sporton International Inc. Hsinchu Laboratory, would like to declare that the tested sample has been evaluated in accordance with the procedures given in ANSI C63.10-2013 and shown compliance with the applicable technical standards.

The test results in this report apply exclusively to the tested model / sample. Without written approval of Sporton International Inc. Hsinchu Laboratory, the test report shall not be reproduced except in full.



Approved by: Sam Chen

Sporton International Inc. Hsinchu Laboratory
No.8, Ln. 724, Bo'ai St., Zhubei City, Hsinchu County 302010, Taiwan (R.O.C.)



Table of Contents

History of this test report.....3

Summary of Test Result.....4

1 General Description5

1.1 Information.....5

1.2 Applicable Standards11

1.3 Testing Location Information.....11

1.4 Measurement Uncertainty11

2 Test Configuration of EUT.....12

2.1 Test Channel Mode12

2.2 The Worst Case Measurement Configuration.....13

2.3 EUT Operation during Test15

2.4 Accessories15

2.5 Support Equipment.....16

2.6 Test Setup Diagram17

3 Transmitter Test Result20

3.1 AC Power-line Conducted Emissions20

3.2 DTS Bandwidth22

3.3 Maximum Conducted Output Power23

3.4 Power Spectral Density26

3.5 Emissions in Non-restricted Frequency Bands28

3.6 Emissions in Restricted Frequency Bands.....29

4 Test Equipment and Calibration Data33

Appendix A. Test Results of AC Power-line Conducted Emissions

Appendix B. Test Results of DTS Bandwidth

Appendix C. Test Results of Maximum Conducted Output Power

Appendix D. Test Results of Power Spectral Density

Appendix E. Test Results of Emissions in Non-restricted Frequency Bands

Appendix F. Test Results of Emissions in Restricted Frequency Bands

Appendix G. Test Photos

Photographs of EUT v01



Summary of Test Result

Report Clause	Ref Std. Clause	Test Items	Result (PASS/FAIL)	Remark
1.1.2	15.203	Antenna Requirement	PASS	-
3.1	15.207	AC Power-line Conducted Emissions	PASS	-
3.2	15.247(a)	DTS Bandwidth	PASS	-
3.3	15.247(b)	Maximum Conducted Output Power	PASS	-
3.4	15.247(e)	Power Spectral Density	PASS	-
3.5	15.247(d)	Emissions in Non-restricted Frequency Bands	PASS	-
3.6	15.247(d)	Emissions in Restricted Frequency Bands	PASS	-

Reference to Sporton Project No.: FR151220AD

Declaration of Conformity:

The test results with all measurement uncertainty excluded are presented in accordance with the regulation limits or requirements declared by manufacturers.

Comments and Explanations:

1. The test configuration, test mode and test software were written in this test report are declared by the manufacturer.
2. The declared of product specification for EUT presented in the report are provided by the manufacturer, and the manufacturer takes all the responsibilities for the accuracy of product specification.

Reviewed by: Sam Chen
Report Producer: Viola Huang



1 General Description

1.1 Information

1.1.1 RF General Information

Frequency Range (MHz)	Bluetooth Mode	Ch. Frequency (MHz)	Channel Number
2400-2483.5	LE	2402-2480	0-39 [40]

For Radio 4

Band	Mode	BWch (MHz)	Nant
2.4-2.4835GHz	BT-LE(1Mbps)	1	1
2.4-2.4835GHz	BT-LE(500Kb/s)	1	1
2.4-2.4835GHz	BT-LE(125Kb/s)	1	1
2.4-2.4835GHz	BT-LE(2Mbps)	2	1

Note:

- ◆ Bluetooth LE uses a GFSK modulation.
- ◆ BWch is the nominal channel bandwidth.



1.1.2 Antenna Information

Ant.	Radio	Model Name	Antenna Type	Connector	Gain (dBi)
1	1, 2	N/A	PIFA	I-PEX	Note 1
2	1, 2	N/A	PIFA	I-PEX	
3	3	N/A	PIFA	I-PEX	
4	3	N/A	PIFA	I-PEX	
5	3	N/A	PIFA	I-PEX	
6	3	N/A	PIFA	I-PEX	
7	4	N/A	PIFA	I-PEX	

Ant.	WLAN 2.4GHz Port	WLAN 5GHz UNII 1~3 Port	Scanning radio (WLAN 2.4GHz) Port	Scanning radio (5GHz UNII 1~3) Port	Scanning radio (6E UNII 5~8) Port	Bluetooth / IEEE802.15.4 Port
1	2	2	-	-	-	-
2	1	1	-	-	-	-
3	-	-	2	2	-	-
4	-	-	1	1	-	-
5	-	-	-	-	1	-
6	-	-	-	-	2	-
7	-	-	-	-	-	1

Note 1:

Ant.	Gain (dBi)			
	WLAN 2.4GHz	Scanning radio (WLAN 2.4GHz)	Bluetooth	IEEE802.15.4
1	4	-	-	-
2	3.61	-	-	-
3	-	5.20	-	-
4	-	5.32	-	-
5	-	-	-	-
6	-	-	-	-
7	-	-	5.26	5.26



Ant.	WLAN 5GHz UNII 1~3				Scanning radio (5GHz UNII 1~3)				Scanning radio (6E UNII 5~8)			
	Band 1	Band 2	Band 3	Band 4	Band 1	Band 2	Band 3	Band 4	Band 5	Band 6	Band 7	Band 8
1	5.14	5.14	4.23	4.43	-	-	-	-	-	-	-	-
2	4.53	4.53	3.49	3.08	-	-	-	-	-	-	-	-
3	-	-	-	-	5.91	5.91	5.39	5.80	-	-	-	-
4	-	-	-	-	5.11	5.11	5.11	5.62	-	-	-	-
5	-	-	-	-	-	-	-	-	4.34	4.56	4.56	4.50
6	-	-	-	-	-	-	-	-	4.88	5.25	5.25	5.05

Ant.	Radio	Directional Gain (dBi)									
		WLAN 2.4GHz		5GHz Band 1		5GHz Band 2		5GHz Band 3		5GHz Band 4	
		2T1S	2T2S	2T1S	2T2S	2T1S	2T2S	2T1S	2T2S	2T1S	2T2S
1	1, 2	4.7	1.87	3.77	1.20	3.36	1.37	3.85	1.42	2.96	1.05
2											

Note 2: The EUT has seven antennas.

Note 3: The above information was declared by manufacturer.

Note 4: Radio 1, 2: Maximum Directional Gain following KDB662911 D03.

Note 5: Radio 3: Maximum Directional Gain following KDB662911 D01.

For Radio 1

For 2.4GHz:

For IEEE 802.11b/g/n/VHT/ax mode (1TX, 2TX/2RX):

For 1TX

The EUT supports the antenna with TX diversity functions.

Both Port 1 and Port 2 support transmit and receive functions, but only one of them will be used at one time.

The Port 1 generated the worst case, so it was selected to test and record in the report.

For 2TX/2RX

Port 1 and Port 2 can be used as transmitting/receiving antenna.

Port 1 and Port 2 could transmit/receive simultaneously.



For Radio 2

For 5GHz UNII 1~3:

For IEEE 802.11a/n/ac/ax mode (1TX, 2TX/2RX):

For 1TX

The EUT supports the antenna with TX diversity functions.

Both Port 1 and Port 2 support transmit and receive functions, but only one of them will be used at one time.

The Port 1 generated the worst case, so it was selected to test and record in the report.

For 2TX/2RX

Port 1 and Port 2 can be used as transmitting/receiving antenna.

Port 1 and Port 2 could transmit/receive simultaneously.

For Scanning radio 3

For 2.4GHz:

For IEEE 802.11b/g/n/VHT/ax mode (2TX/2RX):

For 5GHz UNII 1~3:

For IEEE 802.11a/n/ac/ax mode (2TX/2RX):

Port 1 and Port 2 can be used as transmitting/receiving antenna.

Port 1 and Port 2 could transmit/receive simultaneously.

For 6E UNII 5~8 (1TX, 2TX/2RX):

For 1TX

The EUT supports the antenna with TX diversity functions.

Both Port 1 and Port 2 support transmit and receive functions, but only one of them will be used at one time.

The Port 2 generated the worst case, so it was selected to test and record in the report.

For 2TX/2RX

Port 1 and Port 2 can be used as transmitting/receiving antenna.

Port 1 and Port 2 could transmit/receive simultaneously.

For Radio 4

Bluetooth / IEEE802.15.4 (1TX/1RX):

Only Port 1 can be used as transmitting/receiving antenna.



1.1.3 Mode Test Duty Cycle

Mode	DC	DCF(dB)	T(s)	VBW(Hz) ≥ 1/T
BT-LE(1Mbps)	0.636	1.97	397.5u	3k
BT-LE(2Mbps)	0.34	4.69	212.5u	10k

Note:

- ◆ DC is Duty Cycle.
- ◆ DCF is Duty Cycle Factor.

1.1.4 EUT Operational Condition

EUT Power Type	From PoE			
Function	<input checked="" type="checkbox"/> Point-to-multipoint	<input type="checkbox"/> Point-to-point		
Test Software Version	accessMtool [version 3.2.1.0]			
Support Mode	<input checked="" type="checkbox"/> LE 1M PHY: 1 Mb/s			
	<input checked="" type="checkbox"/> LE Coded PHY (S=2): 500 Kb/s			
	<input checked="" type="checkbox"/> LE Coded PHY (S=8): 125 Kb/s			
	<input checked="" type="checkbox"/> LE 2M PHY: 2 Mb/s			

Note: The above information was declared by manufacturer.

1.1.5 Table for Radio function

Radio	WLAN 2.4GHz	5GHz UNII 1, 3	Scanning radio (WLAN 2.4GHz / 5GHz UNII 1, 3 / 6E (UNII 5~8))	Bluetooth / IEEE802.15.4
1	V (AP, Bridge, Mesh)	-	-	-
2	-	V AP for UNII 1, 3 Bridge, Mesh for UNII 1, 3	-	-
3	-	-	V (AP)	-
4	-	-	-	V

Note: The above information was declared by manufacturer.



1.1.6 Table for EUT support function

Function
AP
Bridge
Mesh

Note: For above table list, only AP mode was tested and recorded in this test.

Note: The above information was declared by manufacturer.



1.2 Applicable Standards

According to the specifications of the manufacturer, the EUT must comply with the requirements of the following standards:

- ♦ 47 CFR FCC Part 15.247
- ♦ ANSI C63.10-2013

The following reference test guidance is not within the scope of accreditation of TAF.

- ♦ FCC KDB 558074 D01 v05r02
- ♦ FCC KDB 414788 D01 v01r01

1.3 Testing Location Information

Testing Location Information	
Test Lab. : Sporton International Inc. Hsinchu Laboratory	
Hsinchu	ADD: No.8, Ln. 724, Bo'ai St., Zhubei City, Hsinchu County 302010, Taiwan (R.O.C.)
(TAF: 3787)	TEL: 886-3-656-9065 FAX: 886-3-656-9085
	Test site Designation No. TW3787 with FCC.
	Conformity Assessment Body Identifier (CABID) TW3787 with ISED.

Test Condition	Test Site No.	Test Engineer	Test Environment (°C / %)	Test Date
RF Conducted	TH02-CB	Paul Chen	23.4~24 / 55~60	May 22, 2021~Jun. 29, 2021
Radiated below 1GHz	03CH01-CB	Eddie Weng	25.4~27.1 / 60~65	Jun. 17, 2021, Oct. 25, 2021
Radiated above 1GHz	03CH01-CB	Kevin Huang	25.2~27.7 / 65~69	May 21, 2021~Jul. 14, 2021
AC Conduction	CO02-CB	Peter Wu	22~23 / 59~60	Jun. 22, 2021

1.4 Measurement Uncertainty

ISO/IEC 17025 requires that an estimate of the measurement uncertainties associated with the emissions test results be included in the report. The measurement uncertainties given below are based on a 95% confidence level (based on a coverage factor (k=2))

Test Items	Uncertainty	Remark
Conducted Emission (150kHz ~ 30MHz)	2.0 dB	Confidence levels of 95%
Radiated Emission (9kHz ~ 30MHz)	4.2 dB	Confidence levels of 95%
Radiated Emission (30MHz ~ 1,000MHz)	5.5 dB	Confidence levels of 95%
Radiated Emission (1GHz ~ 18GHz)	4.7 dB	Confidence levels of 95%
Radiated Emission (18GHz ~ 40GHz)	4.2 dB	Confidence levels of 95%
Conducted Emission	2.5 dB	Confidence levels of 95%
Output Power Measurement	1.3 dB	Confidence levels of 95%
Power Density Measurement	2.5 dB	Confidence levels of 95%
Bandwidth Measurement	0.9%	Confidence levels of 95%



2 Test Configuration of EUT

2.1 Test Channel Mode

Mode	Power Setting
BT-LE(1Mbps)	-
2402MHz	0E
2440MHz	0E
2480MHz	0E
BT-LE(2Mbps)	-
2402MHz	0E
2440MHz	0E
2480MHz	0E



2.2 The Worst Case Measurement Configuration

The Worst Case Mode for Following Conformance Tests	
Tests Item	AC power-line conducted emissions
Condition	AC power-line conducted measurement for line and neutral Test Voltage: 120Vac / 60Hz
Operating Mode	Normal Link
1	Normal Link (Radio 1 + Radio 2 + Radio 3 (2.4GHz)) + CTX (Radio 4 (Bluetooth))
2	Normal Link (Radio 1 + Radio 2 + Radio 3 (2.4GHz)) + CTX Radio 4 (IEEE802.15.4)
Mode 1 has been evaluated to be the worst case among Mode 1~2, thus measurement for Mode 3~4 will follow this same test mode.	
3	Normal Link (Radio 1 + Radio 2 + Radio 3 (5GHz UNII)) + CTX Radio 4 (Bluetooth)
4	Normal Link (Radio 1 + Radio 2 + Radio 3 (6E)) + CTX Radio 4 (Bluetooth)
For operating mode 4 is the worst case and it was record in this test report.	

The Worst Case Mode for Following Conformance Tests	
Tests Item	DTS Bandwidth Maximum Conducted Output Power Power Spectral Density Emissions in Non-restricted Frequency Bands
Test Condition	Conducted measurement at transmit chains



The Worst Case Mode for Following Conformance Tests	
Tests Item	Emissions in Restricted Frequency Bands
Test Condition	Radiated measurement If EUT consist of multiple antenna assembly (multiple antenna are used in EUT regardless of spatial multiplexing MIMO configuration), the radiated test should be performed with highest antenna gain of each antenna type.
Operating Mode < 1GHz	Normal Link for Radio 1 + Radio 2 + Radio 3 CTX for Radio 4
1	EUT in Z axis-Normal Link (Radio 1 + Radio 2 + Radio 3 (2.4GHz)) + CTX (Radio 4 (Bluetooth))
2	EUT in Z axis-Normal Link (Radio 1 + Radio 2 + Radio 3 (2.4GHz)) + CTX Radio 4 (IEEE802.15.4)
Mode 2 has been evaluated to be the worst case among Mode 1~2, thus measurement for Mode 3~4 will follow this same test mode.	
3	EUT in Z axis-Normal Link (Radio 1 + Radio 2 + Radio 3 (5GHz UNII)) + CTX Radio 4 (IEEE802.15.4)
4	EUT in Z axis-Normal Link (Radio 1 + Radio 2 + Radio 3 (6E)) + CTX Radio 4 (IEEE802.15.4)
Mode 2 has been evaluated to be the worst case among Mode 1~4, thus measurement for Mode 5 and Mode 6 will follow this same test mode.	
5	EUT in Y axis-Normal Link (Radio 1 + Radio 2 + Radio 3 (2.4GHz)) + CTX Radio 4 (IEEE802.15.4)
6	EUT in X axis-Normal Link (Radio 1 + Radio 2 + Radio 3 (2.4GHz)) + CTX Radio 4 (IEEE802.15.4)
For operating mode 2 is the worst case and it was record in this test report.	
Operating Mode > 1GHz	CTX
	1. The EUT was performed at X axis, Y axis and Z axis and the worst case was found at Y axis. So the measurement will follow this same test configuration. 2. Refer to note 1 for detail operating mode
1	Radio 4_EUT in Y axis



The Worst Case Mode for Following Conformance Tests	
Tests Item	Simultaneous Transmission Analysis - Co-location RF Exposure Evaluation
Operating Mode	
1	Radio 1_2.4GHz + Radio 2_5GHz + Scanning radio 3_2.4GHz + Radio 4_Bluetooth
2	Radio 1_2.4GHz + Radio 2_5GHz + Scanning radio 3_2.4GHz + Radio 4_802.15.4
3	Radio 1_2.4GHz + Radio 2_5GHz + Scanning radio 3_5GHz + Radio 4_Bluetooth
4	Radio 1_2.4GHz + Radio 2_5GHz + Scanning radio 3_5GHz + Radio 4_802.15.4
5	Radio 1_2.4GHz + Radio 2_5GHz + Scanning radio 3_6E + Radio 4_Bluetooth
6	Radio 1_2.4GHz + Radio 2_5GHz + Scanning radio 3_6E + Radio 4_802.15.4
Refer to Sporton Test Report No.: FA151220-03 for Co-location RF Exposure Evaluation.	

Note 1: The PoE is for measurement only, would not be marketed.

PoE information as below:

Power	Brand	Model
PoE	Microsemi	PD-9001-10GC/AC

2.3 EUT Operation during Test

For CTX Mode:

The EUT was programmed to be in continuously transmitting mode.

For Normal Link:

During the test, the EUT operation to normal function.

2.4 Accessories

Accessories
Cradle*1



2.5 Support Equipment

For AC Conduction:

Support Equipment				
No.	Equipment	Brand Name	Model Name	FCC ID
A	ETH0/POE+NB	DELL	E6430	N/A
B	ETH1 NB	DELL	E6430	N/A
C	2.4G NB	DELL	E6430	N/A
D	5G NB	DELL	E6430	N/A
E	6E clinet	Extreme Networks	AP4000U	N/A
F	PoE	Microsemi	PD-9001-10GC/AC	N/A
G	Flash disk3.0	Transcend	JetFlash-700	N/A

For Radiated (below 1GHz):

Support Equipment				
No.	Equipment	Brand Name	Model Name	FCC ID
A	PoE	Microsemi	PD-9001-10GC/AC	N/A
B	PC	DELL	OPTIPLEX 3010	N/A
C	Notebook	Apple	Mac Book	N/A
D	Notebook	Apple	Mac Book	N/A
E	Notebook	Apple	Mac Book	N/A
F	Flash disk3.0	Silicon Power	B06	N/A
G	Notebook	DELL	E4300	N/A

For Radiated (above 1GHz):

Support Equipment				
No.	Equipment	Brand Name	Model Name	FCC ID
A	Notebook	DELL	E4300	N/A
B	PoE	Microsemi	PD-9001-10GC/AC	N/A

For RF Conducted:

Support Equipment				
No.	Equipment	Brand Name	Model Name	FCC ID
A	Notebook	DELL	E4300	N/A
B	PoE	Microsemi	PD-9001-10GC/AC	N/A

2.6 Test Setup Diagram

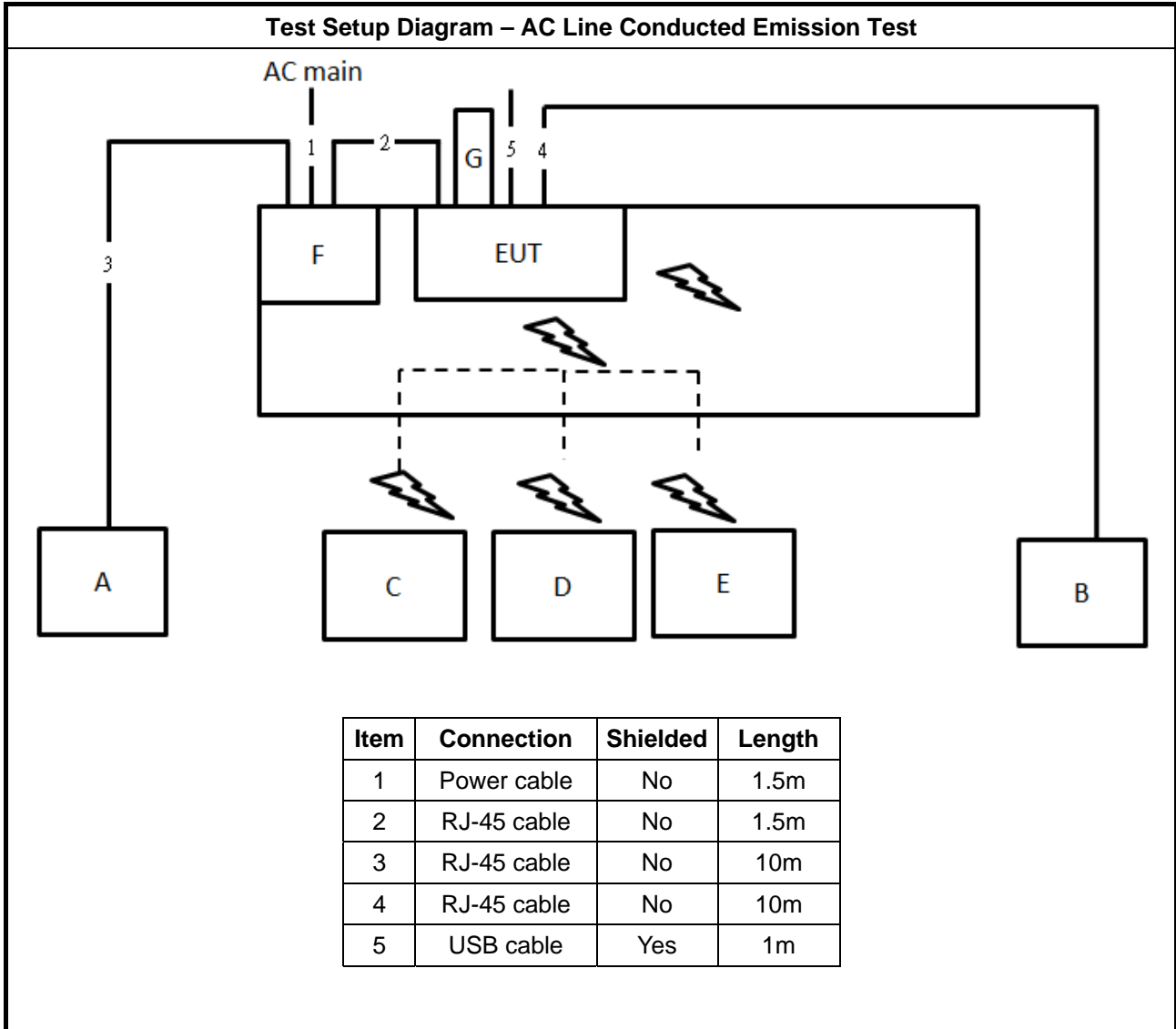

Test Setup Diagram - Radiated Test < 1GHz

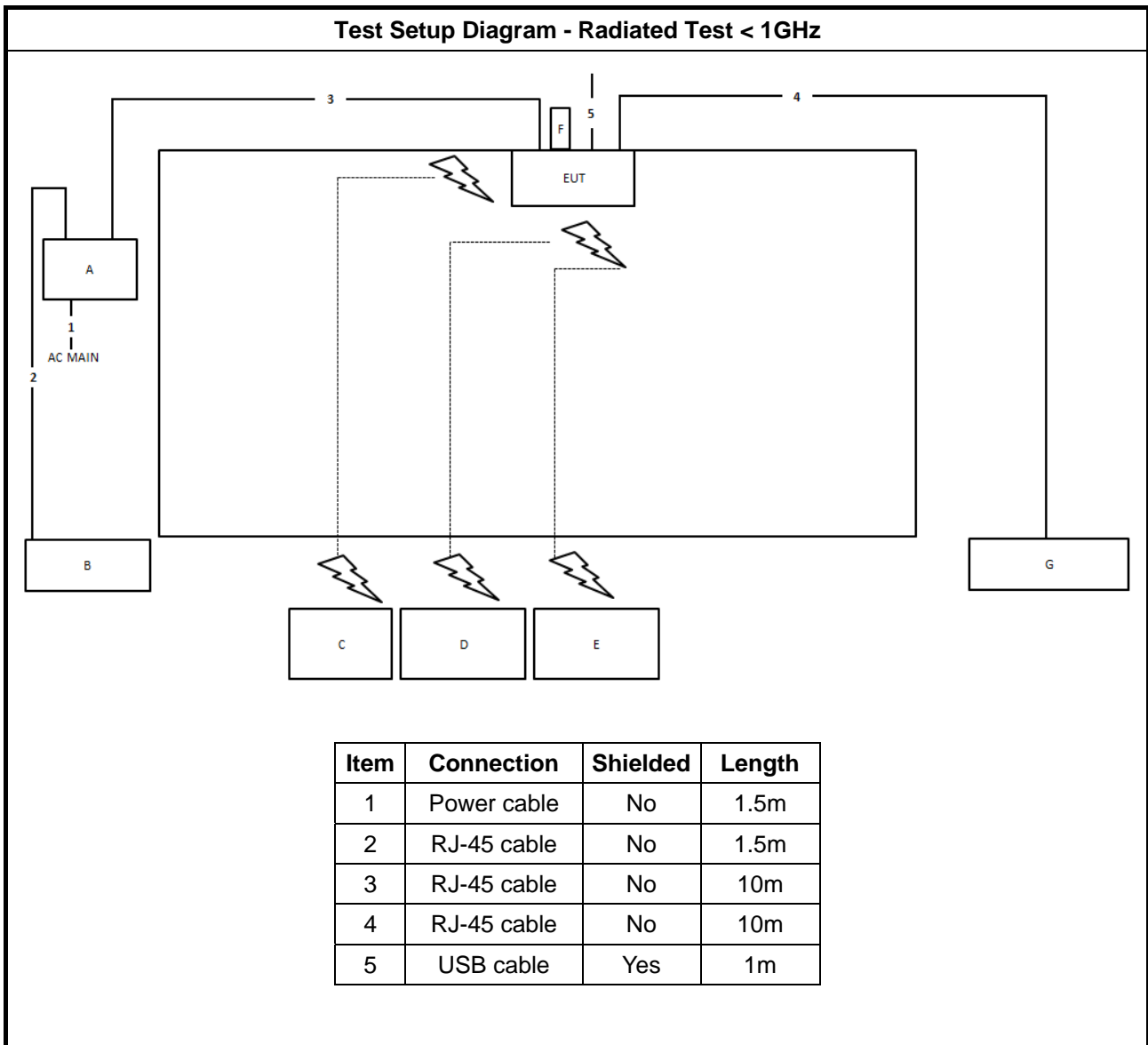

Item	Connection	Shielded	Length
1	Power cable	No	1.5m
2	RJ-45 cable	No	1.5m
3	RJ-45 cable	No	10m
4	RJ-45 cable	No	10m
5	USB cable	Yes	1m

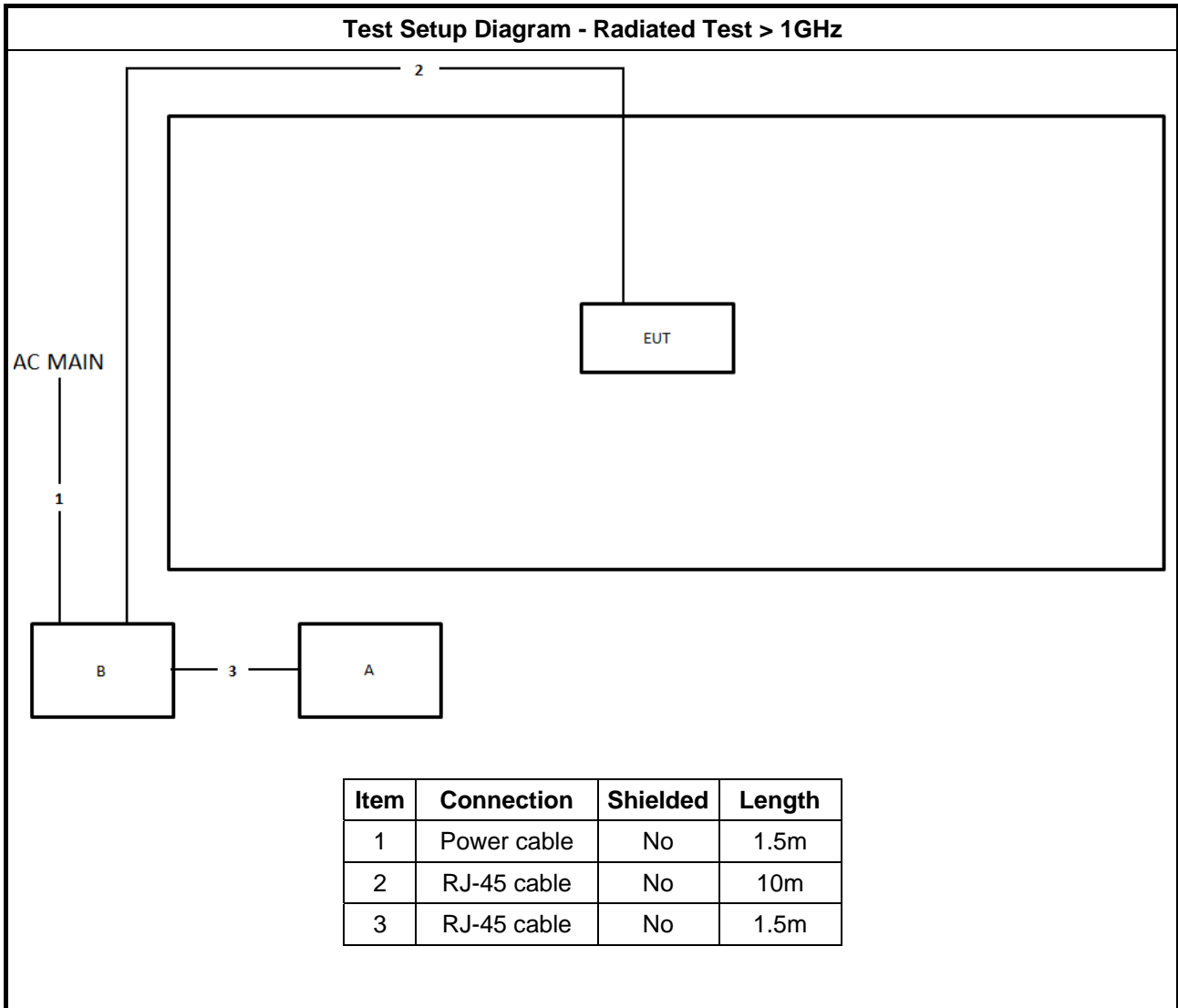



3 Transmitter Test Result

3.1 AC Power-line Conducted Emissions

3.1.1 AC Power-line Conducted Emissions Limit

AC Power-line Conducted Emissions Limit		
Frequency Emission (MHz)	Quasi-Peak	Average
0.15-0.5	66 - 56 *	56 - 46 *
0.5-5	56	46
5-30	60	50

Note 1: * Decreases with the logarithm of the frequency.

3.1.2 Measuring Instruments

Refer a test equipment and calibration data table in this test report.

3.1.3 Test Procedures

Test Method
▪ Refer as ANSI C63.10-2013, clause 6.2 for AC power-line conducted emissions.

3.1.4 Test Setup

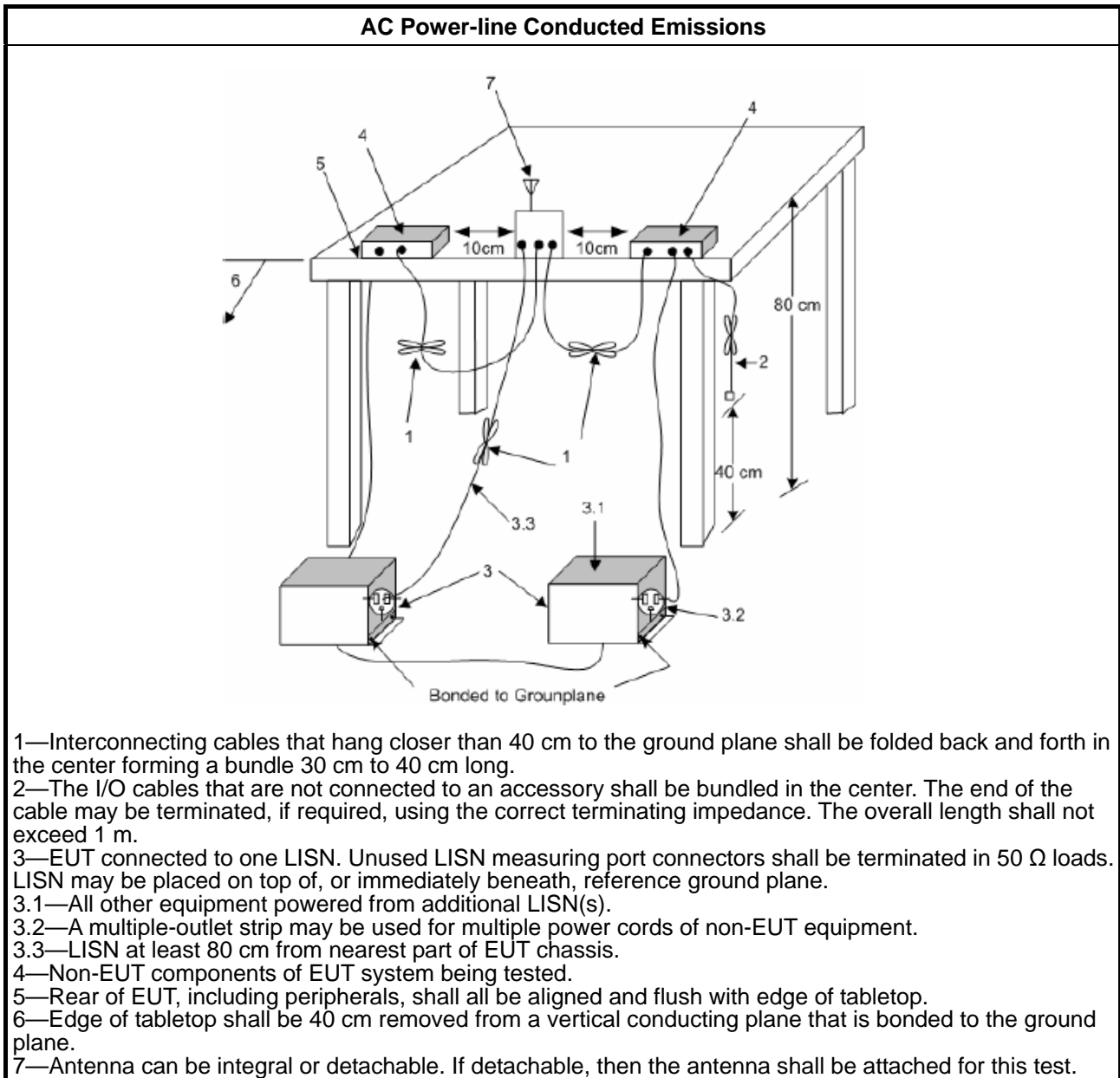

1.1.1. Measurement Results Calculation

The measured Level is calculated using:

- a. Corrected Reading: LISN Factor (LISN) + Attenuator (AT/AUX) + Cable Loss (CL) + Read Level (Raw) = Level
- b. Margin = -Limit + Level

3.1.5 Test Result of AC Power-line Conducted Emissions

Refer as Appendix A

3.2 DTS Bandwidth

3.2.1 6dB Bandwidth Limit

6dB Bandwidth Limit
Systems using digital modulation techniques:
<ul style="list-style-type: none"> ▪ 6 dB bandwidth \geq 500 kHz.

3.2.2 Measuring Instruments

Refer a test equipment and calibration data table in this test report.

3.2.3 Test Procedures

Test Method
<ul style="list-style-type: none"> ▪ For the emission bandwidth shall be measured using one of the options below:
<input checked="" type="checkbox"/> Refer as FCC KDB 558074, clause 8.2 & C63.10 clause 11.8.1 Option 1 for 6 dB bandwidth measurement.
<input type="checkbox"/> Refer as FCC KDB 558074, clause 8.2 & C63.10 clause 11.8.2 Option 2 for 6 dB bandwidth measurement.
<input type="checkbox"/> Refer as ANSI C63.10, clause 6.9.1 for occupied bandwidth testing.

3.2.4 Test Setup

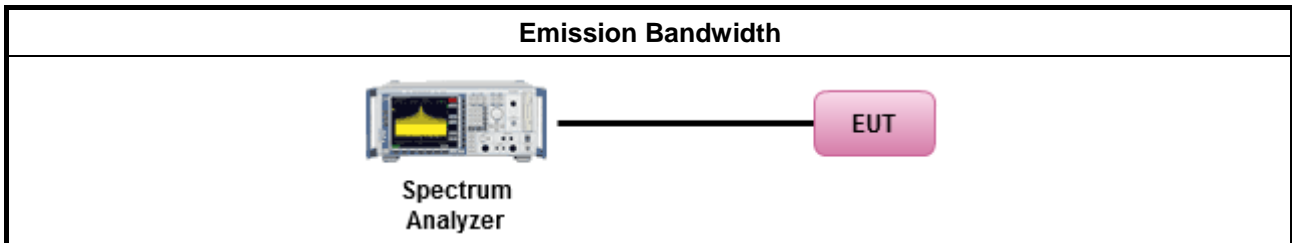

3.2.5 Test Result of Emission Bandwidth

Refer as Appendix B



3.3 Maximum Conducted Output Power

3.3.1 Maximum Conducted Output Power Limit

Maximum Conducted Output Power Limit	
	<ul style="list-style-type: none">▪ If $G_{TX} \leq 6$ dBi, then $P_{Out} \leq 30$ dBm (1 W)
	<ul style="list-style-type: none">▪ Point-to-multipoint systems (P2M): If $G_{TX} > 6$ dBi, then $P_{Out} = 30 - (G_{TX} - 6)$ dBm
	<ul style="list-style-type: none">▪ Point-to-point systems (P2P): If $G_{TX} > 6$ dBi, then $P_{Out} = 30 - (G_{TX} - 6)/3$ dBm
	<ul style="list-style-type: none">▪ Smart antenna system (SAS):
	<ul style="list-style-type: none">- Single beam: If $G_{TX} > 6$ dBi, then $P_{Out} = 30 - (G_{TX} - 6)/3$ dBm
	<ul style="list-style-type: none">- Overlap beam: If $G_{TX} > 6$ dBi, then $P_{Out} = 30 - (G_{TX} - 6)/3$ dBm
	<ul style="list-style-type: none">- Aggregate power on all beams: If $G_{TX} > 6$ dBi, then $P_{Out} = 30 - (G_{TX} - 6)/3 + 8$ dB dBm
P_{Out} = maximum peak conducted output power or maximum conducted output power in dBm, G_{TX} = the maximum transmitting antenna directional gain in dBi.	

3.3.2 Measuring Instruments

Refer a test equipment and calibration data table in this test report.



3.3.3 Test Procedures

Test Method	
<ul style="list-style-type: none"> ▪ Maximum Peak Conducted Output Power 	
	<input type="checkbox"/> Refer as FCC KDB 558074, clause 8.3.1.1 & C63.10 clause 11.9.1.1 (RBW ≥ EBW method).
	<input type="checkbox"/> Refer as FCC KDB 558074, clause 8.3.1.3 & C63.10 clause 11.9.1.3 (peak power meter).
<ul style="list-style-type: none"> ▪ Maximum Conducted Output Power 	
[duty cycle ≥ 98% or external video / power trigger]	
	<input type="checkbox"/> Refer as FCC KDB 558074, clause 8.3.2.2 & C63.10 clause 11.9.2.2.2 Method AVGSA-1.
	<input type="checkbox"/> Refer as FCC KDB 558074, clause 8.3.2.2 & C63.10 clause 11.9.2.2.3 Method AVGSA-1A. (alternative)
duty cycle < 98% and average over on/off periods with duty factor	
	<input type="checkbox"/> Refer as FCC KDB 558074, clause 8.3.2.2 & C63.10 clause 11.9.2.2.4 Method AVGSA-2.
	<input type="checkbox"/> Refer as FCC KDB 558074, clause 8.3.2.2 & C63.10 clause 11.9.2.2.5 Method AVGSA-2A (alternative)
	<input type="checkbox"/> Refer as FCC KDB 558074, clause 8.3.2.2 & C63.10 clause 11.9.2.2.6 Method AVGSA-3
	<input type="checkbox"/> Refer as FCC KDB 558074, clause 8.3.2.2 & C63.10 clause 11.9.2.2.7 Method AVGSA-3A (alternative)
Measurement using a power meter (PM)	
	<input type="checkbox"/> Refer as FCC KDB 558074, clause 8.3.2.3 & C63.10 clause 11.9.2.3.1 Method AVGPM (using an RF average power meter).
	<input checked="" type="checkbox"/> Refer as FCC KDB 558074, clause 8.3.2.3 & C63.10 clause 11.9.2.3.2 Method AVGPM-G (using an gate RF average power meter).
<ul style="list-style-type: none"> ▪ For conducted measurement. 	
	<ul style="list-style-type: none"> ▪ If the EUT supports multiple transmit chains using options given below: Refer as FCC KDB 662911, In-band power measurements. Using the measure-and-sum approach, measured all transmit ports individually. Sum the power (in linear power units e.g., mW) of all ports for each individual sample and save them.
	<ul style="list-style-type: none"> ▪ If multiple transmit chains, EIRP calculation could be following as methods: $P_{total} = P_1 + P_2 + \dots + P_n$ (calculated in linear unit [mW] and transfer to log unit [dBm]) $EIRP_{total} = P_{total} + DG$

3.3.4 Test Setup

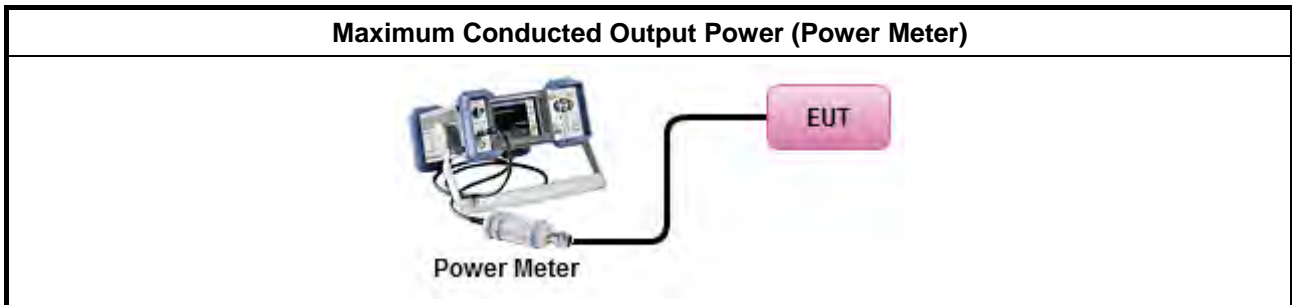

3.3.5 Test Result of Maximum Conducted Output Power

Refer as Appendix C



3.4 Power Spectral Density

3.4.1 Power Spectral Density Limit

Power Spectral Density Limit
<ul style="list-style-type: none"> Power Spectral Density (PSD) ≤ 8 dBm/3kHz

3.4.2 Measuring Instruments

Refer a test equipment and calibration data table in this test report.

3.4.3 Test Procedures

Test Method
<ul style="list-style-type: none"> Peak power spectral density procedures that the same method as used to determine the conducted output power. If maximum peak conducted output power was measured to demonstrate compliance to the output power limit, then the peak PSD procedure below (Method PKPSD) shall be used. If maximum conducted output power was measured to demonstrate compliance to the output power limit, then one of the average PSD procedures shall be used, as applicable based on the following criteria (the peak PSD procedure is also an acceptable option).
<input checked="" type="checkbox"/> Refer as FCC KDB 558074, clause 8.4 & C63.10 clause 11.10 Method Max. PSD. [duty cycle ≥ 98% or external video / power trigger]
<ul style="list-style-type: none"> For conducted measurement.
<ul style="list-style-type: none"> If The EUT supports multiple transmit chains using options given below: <ul style="list-style-type: none"> <input type="checkbox"/> Option 1: Measure and sum the spectra across the outputs. Refer as FCC KDB 662911, In-band power spectral density (PSD). Sample all transmit ports simultaneously using a spectrum analyzer for each transmit port. Where the trace bin-by-bin of each transmit port summing can be performed. (i.e., in the first spectral bin of output 1 is summed with that in the first spectral bin of output 2 and that from the first spectral bin of output 3, and so on up to the NTX output to obtain the value for the first frequency bin of the summed spectrum.). Add up the amplitude (power) values for the different transmit chains and use this as the new data trace. <input type="checkbox"/> Option 2: Measure and sum spectral maxima across the outputs. With this technique, spectra are measured at each output of the device at the required resolution bandwidth. The maximum value (peak) of each spectrum is determined. These maximum values are then summed mathematically in linear power units across the outputs. These operations shall be performed separately over frequency spans that have different out-of-band or spurious emission limits, <input type="checkbox"/> Option 3: Measure and add 10 log(N) dB, where N is the number of transmit chains. Refer as FCC KDB 662911, In-band power spectral density (PSD). Performed at each transmit chains and each transmit chains shall be compared with the limit have been reduced with 10 log(N). Or each transmit chains shall be add 10 log(N) to compared with the limit.

3.4.4 Test Setup

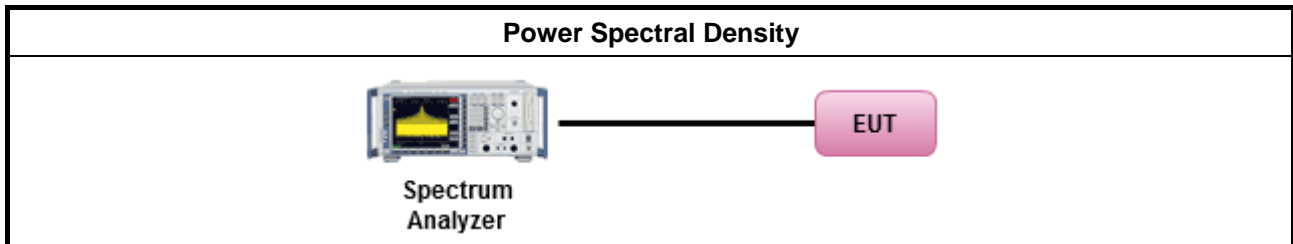

3.4.5 Test Result of Power Spectral Density

Refer as Appendix D

3.5 Emissions in Non-restricted Frequency Bands

3.5.1 Emissions in Non-restricted Frequency Bands Limit

Un-restricted Band Emissions Limit	
RF output power procedure	Limit (dBc)
Peak output power procedure	20
Average output power procedure	30

Note 1: If the peak output power procedure is used to measure the fundamental emission power to demonstrate compliance to requirements, then the peak conducted output power measured within any 100 kHz outside the authorized frequency band shall be attenuated by at least 20 dB relative to the maximum measured in-band peak PSD level.

Note 2: If the average output power procedure is used to measure the fundamental emission power to demonstrate compliance to requirements, then the power in any 100 kHz outside of the authorized frequency band shall be attenuated by at least 30 dB relative to the maximum measured in-band average PSD level.

3.5.2 Measuring Instruments

Refer a test equipment and calibration data table in this test report.

3.5.3 Test Procedures

Test Method
<ul style="list-style-type: none"> Refer as FCC KDB 558074, clause 8.5 for unwanted emissions into non-restricted bands.

3.5.4 Test Setup

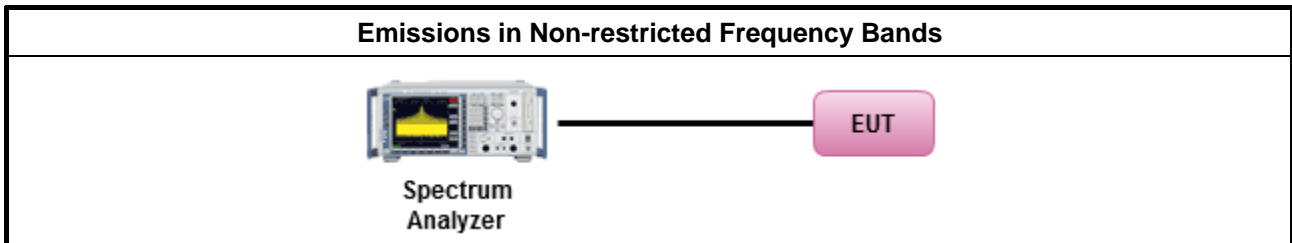

3.5.5 Test Result of Emissions in Non-restricted Frequency Bands

Refer as Appendix E



3.6 Emissions in Restricted Frequency Bands

3.6.1 Emissions in Restricted Frequency Bands Limit

Restricted Band Emissions Limit			
Frequency Range (MHz)	Field Strength (uV/m)	Field Strength (dBuV/m)	Measure Distance (m)
0.009~0.490	2400/F(kHz)	48.5 - 13.8	300
0.490~1.705	24000/F(kHz)	33.8 - 23	30
1.705~30.0	30	29	30
30~88	100	40	3
88~216	150	43.5	3
216~960	200	46	3
Above 960	500	54	3

Note 1: Test distance for frequencies at or above 30 MHz, measurements may be performed at a distance other than the limit distance provided they are not performed in the near field and the emissions to be measured can be detected by the measurement equipment. When performing measurements at a distance other than that specified, the results shall be extrapolated to the specified distance using an extrapolation factor of 20 dB/decade (inverse of linear distance for field-strength measurements, inverse of linear distance-squared for power-density measurements).

Note 2: Test distance for frequencies at below 30 MHz, measurements may be performed at a distance closer than the EUT limit distance; however, an attempt should be made to avoid making measurements in the near field. When performing measurements below 30 MHz at a closer distance than the limit distance, the results shall be extrapolated to the specified distance by either making measurements at a minimum of two or more distances on at least one radial to determine the proper extrapolation factor or by using the square of an inverse linear distance extrapolation factor (40 dB / decade). The test report shall specify the extrapolation method used to determine compliance of the EUT.

Note 3: Using the distance of 1m during the test for above 18 GHz, and the test value to correct for the distance factor at 3m.

3.6.2 Measuring Instruments

Refer a test equipment and calibration data table in this test report.



3.6.3 Test Procedures

Test Method	
<ul style="list-style-type: none"> ▪ The average emission levels shall be measured in [duty cycle \geq 98 or duty factor]. 	
<ul style="list-style-type: none"> ▪ Refer as ANSI C63.10, clause 6.10.3 band-edge testing shall be performed at the lowest frequency channel and highest frequency channel within the allowed operating band. 	
<ul style="list-style-type: none"> ▪ For the transmitter unwanted emissions shall be measured using following options below: 	
	<ul style="list-style-type: none"> ▪ Refer as FCC KDB 558074, clause 8.6 for unwanted emissions into restricted bands.
	<input type="checkbox"/> Refer as FCC KDB 558074, clause 8.6 & C63.10 clause 11.12.2.5.1(trace averaging for duty cycle \geq 98%).
	<input type="checkbox"/> Refer as FCC KDB 558074, clause 8.6 & C63.10 clause 11.12.2.5.2(trace averaging + duty factor).
	<input checked="" type="checkbox"/> Refer as FCC KDB 558074, clause 8.6 & C63.10 clause 11.12.2.5.3(Reduced VBW \geq 1/T).
	<input type="checkbox"/> Refer as ANSI C63.10, clause 11.12.2.5.3 (Reduced VBW). VBW \geq 1/T, where T is pulse time.
	<input type="checkbox"/> Refer as ANSI C63.10, clause 7.5 average value of pulsed emissions.
	<input checked="" type="checkbox"/> Refer as FCC KDB 558074, clause 8.6 & C63.10 clause 11.12.2.4 measurement procedure peak limit.
<ul style="list-style-type: none"> ▪ For the transmitter band-edge emissions shall be measured using following options below: 	
	<ul style="list-style-type: none"> ▪ Refer as FCC KDB 558074 clause 8.7 & c63.10 clause 11.13.1, When the performing peak or average radiated measurements, emissions within 2 MHz of the authorized band edge may be measured using the marker-delta method described below.
	<ul style="list-style-type: none"> ▪ Refer as FCC KDB 558074, clause 8.7 (ANSI C63.10, clause 6.10.6) for marker-delta method for band-edge measurements.
	<ul style="list-style-type: none"> ▪ Refer as FCC KDB 558074, clause 8.7 for narrower resolution bandwidth (100kHz) using the band power and summing the spectral levels (i.e., 1 MHz).
	<ul style="list-style-type: none"> ▪ For conducted unwanted emissions into restricted bands (absolute emission limits). Devices with multiple transmit chains using options given below: (1) Measure and sum the spectra across the outputs or (2) Measure and add 10 log(N) dB
	<ul style="list-style-type: none"> ▪ For FCC KDB 662911 The methodology described here may overestimate array gain, thereby resulting in apparent failures to satisfy the out-of-band limits even if the device is actually compliant. In such cases, compliance may be demonstrated by performing radiated tests around the frequencies at which the apparent failures occurred.

3.6.4 Test Setup

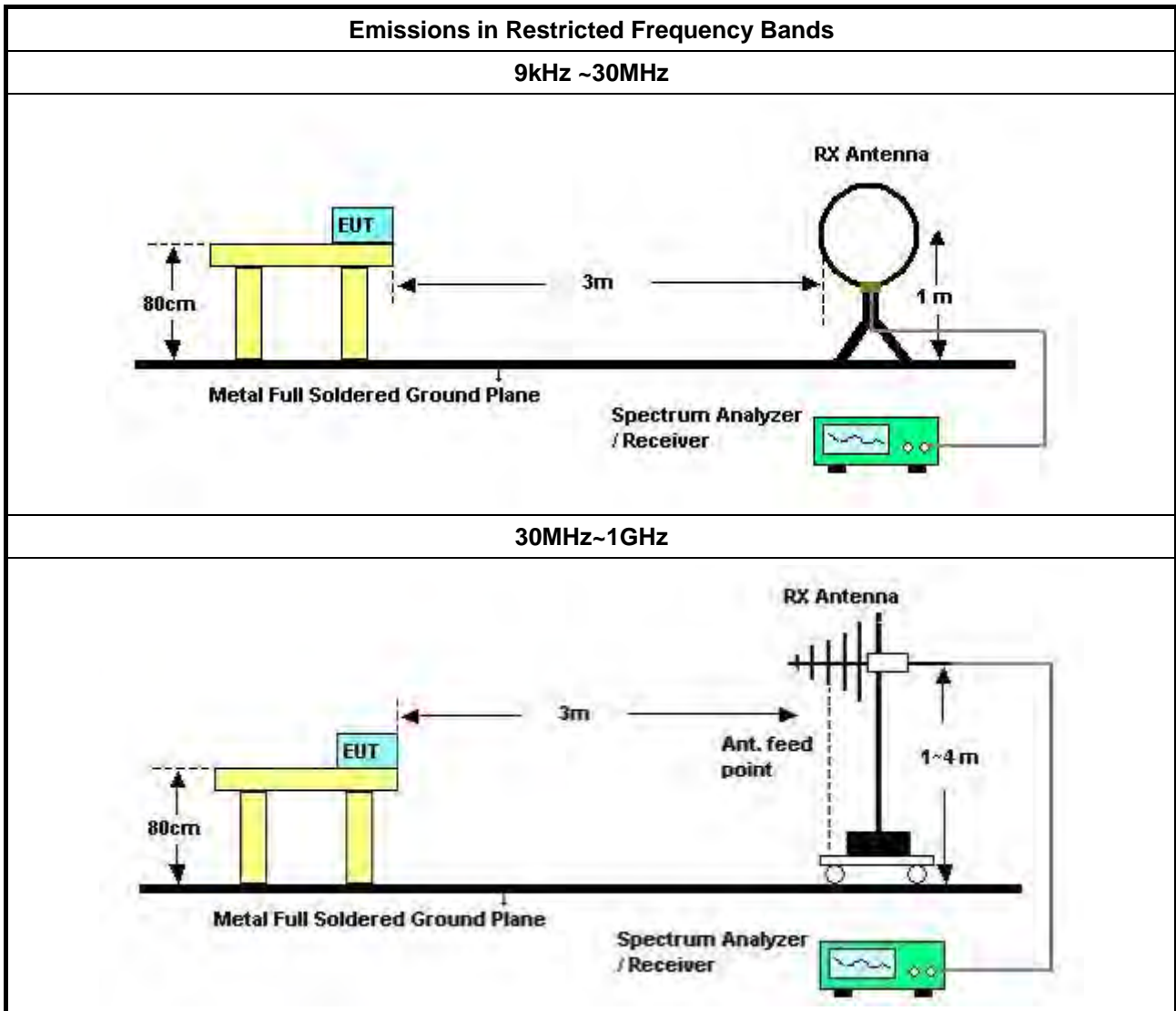



4 Test Equipment and Calibration Data

Instrument	Brand	Model No.	Serial No.	Characteristics	Calibration Date	Calibration Due Date	Remark
LISN	Schwarzbeck	NSLK 8127	8127650	9kHz ~ 30MHz	Dec. 04, 2020	Dec. 03, 2021	Conduction (CO02-CB)
LISN	Schwarzbeck	NSLK 8127	8127478	9kHz ~ 30MHz	Nov. 20, 2020	Nov. 19, 2021	Conduction (CO02-CB)
EMI Receiver	Agilent	N9038A	MY52260140	9kHz ~ 8.4GHz	May 05, 2021	May 04, 2022	Conduction (CO02-CB)
COND Cable	Woken	Cable	2	0.15MHz ~ 30MHz	Oct. 20, 2020	Oct. 19, 2021	Conduction (CO02-CB)
Software	SPORTON	SENSE	V5.10	-	N.C.R.	N.C.R.	Conduction (CO02-CB)
Pulse Limiter	Schwarzbeck	VTSD 9561F-N	00378	9kHz ~ 30MHz	Mar. 18, 2021	Mar. 17, 2022	Conduction (CO02-CB)
3m Semi Anechoic Chamber NSA	TDK	SAC-3M	03CH01-CB	30 MHz ~ 1 GHz	Jan. 26, 2021	Jan. 25, 2022	Radiation (03CH01-CB)
3m Semi Anechoic Chamber VSWR	TDK	SAC-3M	03CH01-CB	1GHz ~18GHz 3m	May 07, 2021	May 06, 2022	Radiation (03CH01-CB)
Loop Antenna	Teseq	HLA 6120	24155	9kHz - 30 MHz	Apr. 14, 2021	Apr. 13, 2022	Radiation (03CH01-CB)
BILOG ANTENNA with 6dB Attenuator	TESEQ & EMCI	CBL6112D N-6-06	37880 & AT-N0609	20MHz ~ 2GHz	Feb. 22, 2021	Feb. 21, 2022	Radiation (03CH01-CB)
Horn Antenna	ETS-LINDGR EN	3115	00075790	750MHz ~ 18GHz	Nov. 06, 2020	Nov. 05, 2021	Radiation (03CH01-CB)
Horn Antenna	Schwarzbeck	BBHA 9170	BBHA9170252	15GHz ~ 40GHz	Jul. 21, 2020	Jul. 20, 2021	Radiation (03CH01-CB)
Amplifier	EMCI	EMC330N	980332	20MHz ~ 3GHz	Jul. 03, 2020	Jul. 02, 2021	Radiation (03CH01-CB)
Amplifier	EMCI	EMC330N	980332	20MHz ~ 3GHz	Jul. 02, 2021	Jul. 01, 2022	Radiation (03CH01-CB)
Pre-Amplifier	Agilent	8449B	3008A02121	1GHz ~ 26.5GHz	May 20, 2021	May 19, 2022	Radiation (03CH01-CB)
Pre-Amplifier	MITEQ	TTA1840-35-H G	1864479	18GHz ~ 40GHz	Jul. 08, 2020	Jul. 07, 2021	Radiation (03CH01-CB)
Amplifier	-	-	TF-130N-R1	18GHz ~ 40GHz	Jun.15, 2021	Jun. 14, 2022	Radiation (03CH01-CB)
Spectrum Analyzer	R&S	FSP40	100056	9kHz ~ 40GHz	May 03, 2021	May 02, 2022	Radiation (03CH01-CB)
EMI Test Receiver	R&S	ESR7	102171	9kHz ~ 7GHz	Jul. 01, 2020	Jun. 30, 2021	Radiation (03CH01-CB)
EMI Test Receiver	R&S	ESCS	826547/017	9kHz ~ 2.75GHz	Jun. 21, 2021	Jun. 20, 2022	Radiation (03CH01-CB)
RF Cable-low	Woken	RG402	Low Cable-16+17	30 MHz ~ 1 GHz	Oct. 05, 2020	Oct. 04, 2021	Radiation (03CH01-CB)



Instrument	Brand	Model No.	Serial No.	Characteristics	Calibration Date	Calibration Due Date	Remark
RF Cable-low	Woken	RG402	Low Cable-16+17	30 MHz ~ 1 GHz	Oct. 04, 2021	Oct. 03, 2022	Radiation (03CH01-CB)
RF Cable-high	Woken	RG402	High Cable-16	1 GHz ~ 18 GHz	Oct. 05, 2020	Oct. 04, 2021	Radiation (03CH01-CB)
RF Cable-high	Woken	RG402	High Cable-16+17	1 GHz ~ 18 GHz	Oct. 05, 2020	Oct. 04, 2021	Radiation (03CH01-CB)
RF Cable-high	Woken	RG402	High Cable-40G#1	18GHz ~ 40 GHz	Jul. 16, 2020	Jul. 15, 2021	Radiation (03CH01-CB)
RF Cable-high	Woken	RG402	High Cable-40G#2	18GHz ~ 40 GHz	Jul. 16, 2020	Jul. 15, 2021	Radiation (03CH01-CB)
Test Software	SPORTON	SENSE	V5.10	-	N.C.R.	N.C.R.	Radiation (03CH01-CB)
Spectrum analyzer	R&S	FSV40	101027	9kHz~40GHz	Jul. 27, 2020	Jul. 26, 2021	Conduction (TH02-CB)
Power Sensor	Anritsu	MA2411B	1126203	300MHz~40GHz	Sep. 17, 2020	Sep. 16, 2021	Conduction (TH02-CB)
Power Meter	Anritsu	ML2495A	1210004	300MHz~40GHz	Sep. 17, 2020	Sep. 16, 2021	Conduction (TH02-CB)
RF Cable-high	Woken	RG402	High Cable-01	1 GHz – 18 GHz	Oct. 05, 2020	Oct. 04, 2021	Conduction (TH02-CB)
RF Cable-high	Woken	RG402	High Cable-02	1 GHz – 18 GHz	Oct. 05, 2020	Oct. 04, 2021	Conduction (TH02-CB)
RF Cable-high	Woken	RG402	High Cable-03	1 GHz – 18 GHz	Oct. 05, 2020	Oct. 04, 2021	Conduction (TH02-CB)
RF Cable-high	Woken	RG402	High Cable-04	1 GHz – 18 GHz	Oct. 05, 2020	Oct. 04, 2021	Conduction (TH02-CB)
RF Cable-high	Woken	RG402	High Cable-05	1 GHz – 18 GHz	Oct. 05, 2020	Oct. 04, 2021	Conduction (TH02-CB)
Test Software	SPORTON	SENSE	V5.10	-	N.C.R.	N.C.R.	Conduction (TH02-CB)

Note: Calibration Interval of instruments listed above is one year.

N.C.R. means Non-Calibration required.



Summary

Mode	Result	Type	Freq (Hz)	Level (dBuV)	Limit (dBuV)	Margin (dB)	Condition
Mode 4	Pass	AV	424.5k	37.99	47.36	-9.37	Line

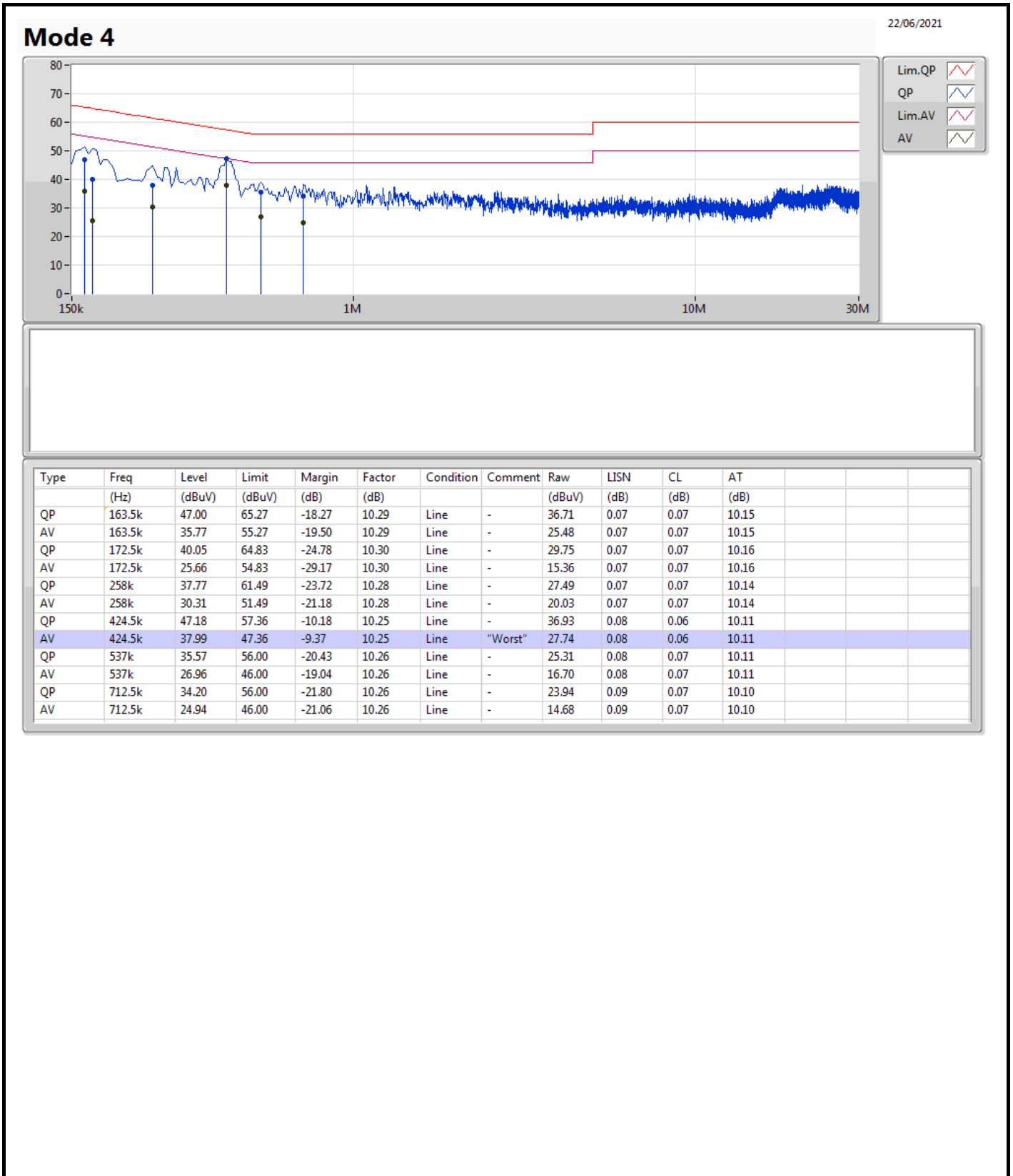

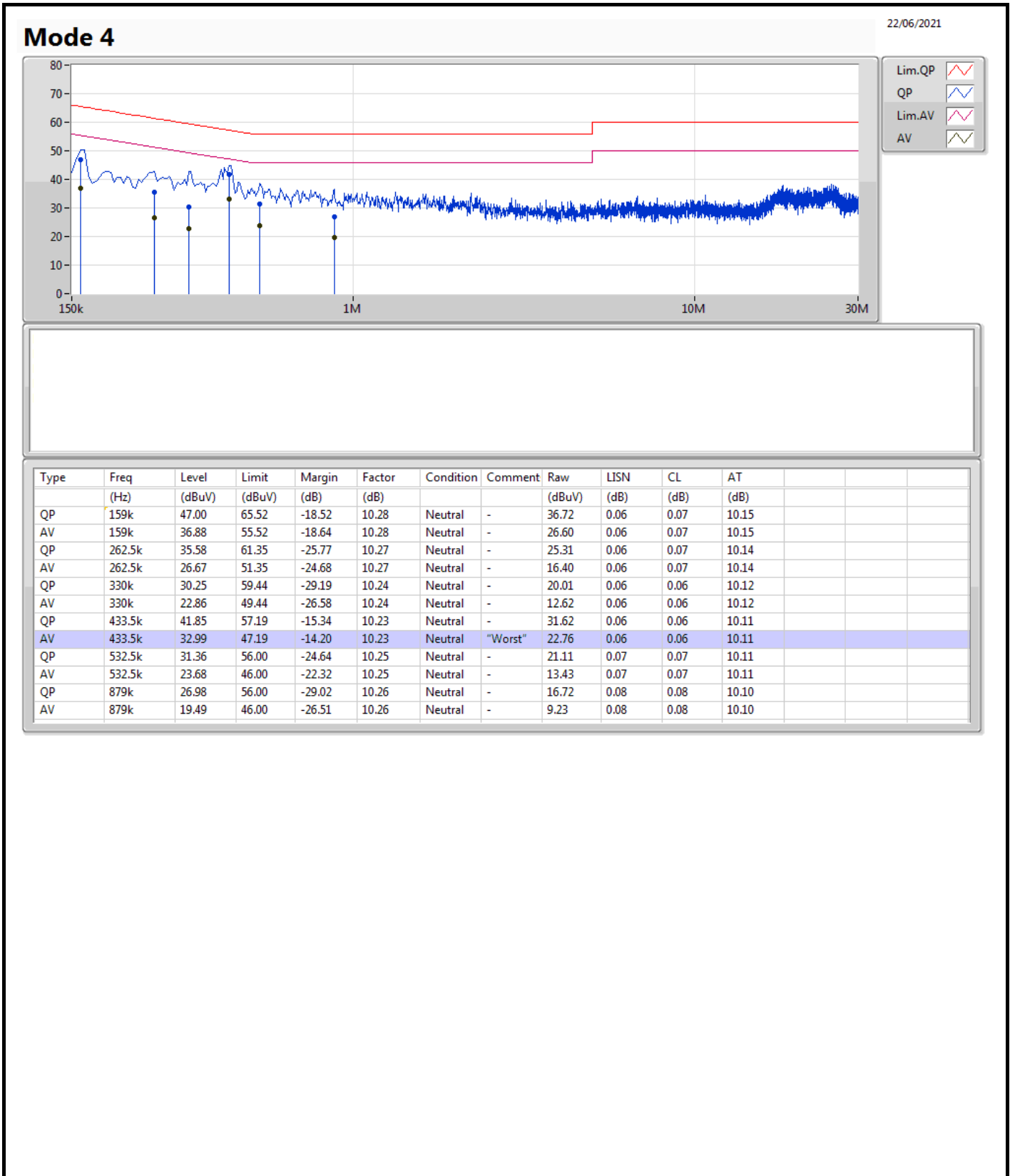

**For Radio 4
Summary**

Mode	Max-N dB (Hz)	Max-OBW (Hz)	ITU-Code	Min-N dB (Hz)	Min-OBW (Hz)
2.4-2.4835GHz	-	-	-	-	-
BT-LE(1Mbps)	677.5k	1.043M	1M04F1D	668.75k	1.036M
BT-LE(2Mbps)	1.168M	2.044M	2M04F1D	1.163M	2.041M

Max-N dB = Maximum 6dB down bandwidth; **Max-OBW** = Maximum 99% occupied bandwidth;

Min-N dB = Minimum 6dB down bandwidth; **Min-OBW** = Minimum 99% occupied bandwidth;

Result

Mode	Result	Limit (Hz)	Port 1-N dB (Hz)	Port 1-OBW (Hz)
BT-LE(1Mbps)	-	-	-	-
2402MHz	Pass	500k	668.75k	1.037M
2440MHz	Pass	500k	677.5k	1.036M
2480MHz	Pass	500k	668.75k	1.043M
BT-LE(2Mbps)	-	-	-	-
2402MHz	Pass	500k	1.168M	2.041M
2440MHz	Pass	500k	1.163M	2.041M
2480MHz	Pass	500k	1.165M	2.044M

Port X-N dB = Port X 6dB down bandwidth; **Port X-OBW** = Port X 99% occupied bandwidth;

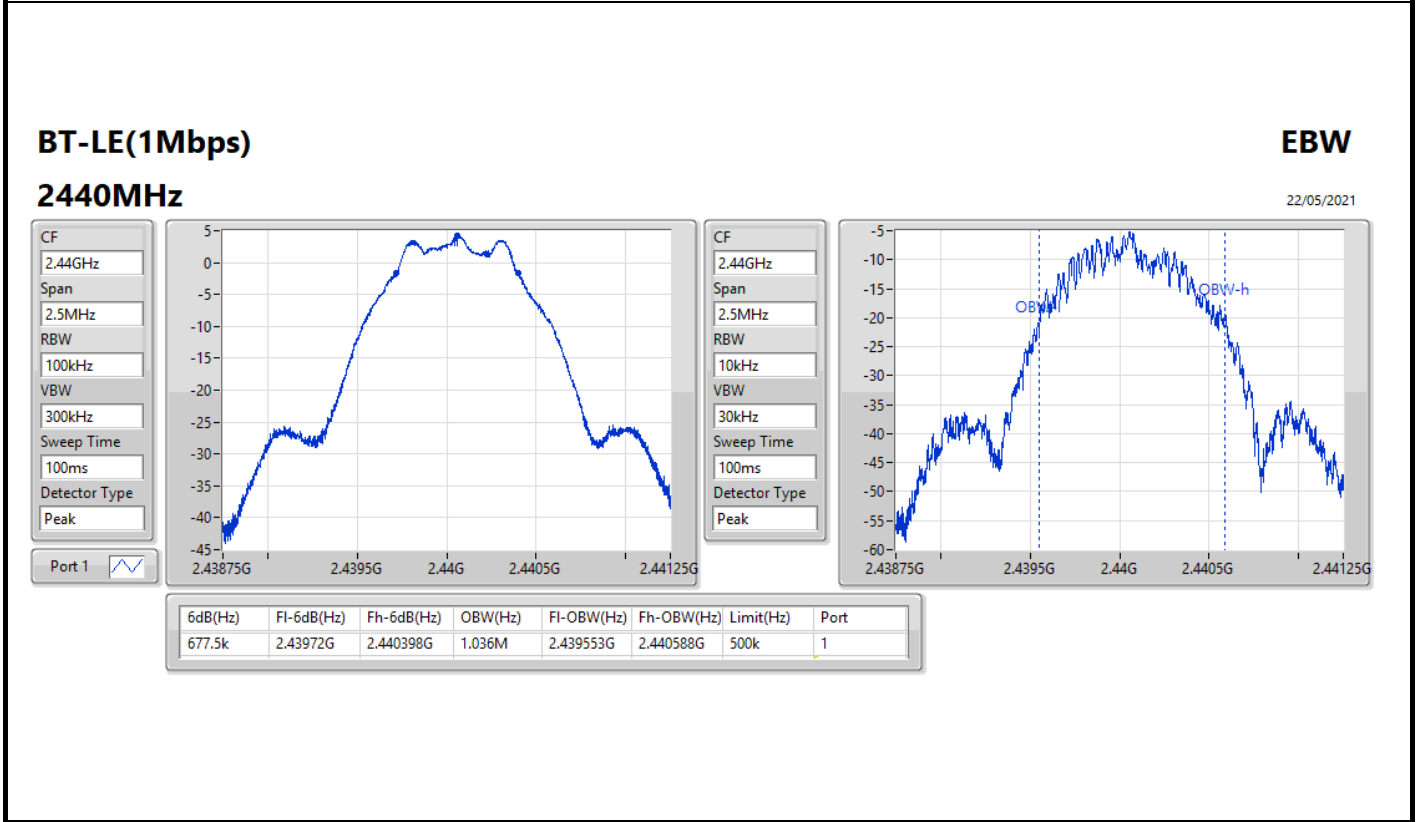
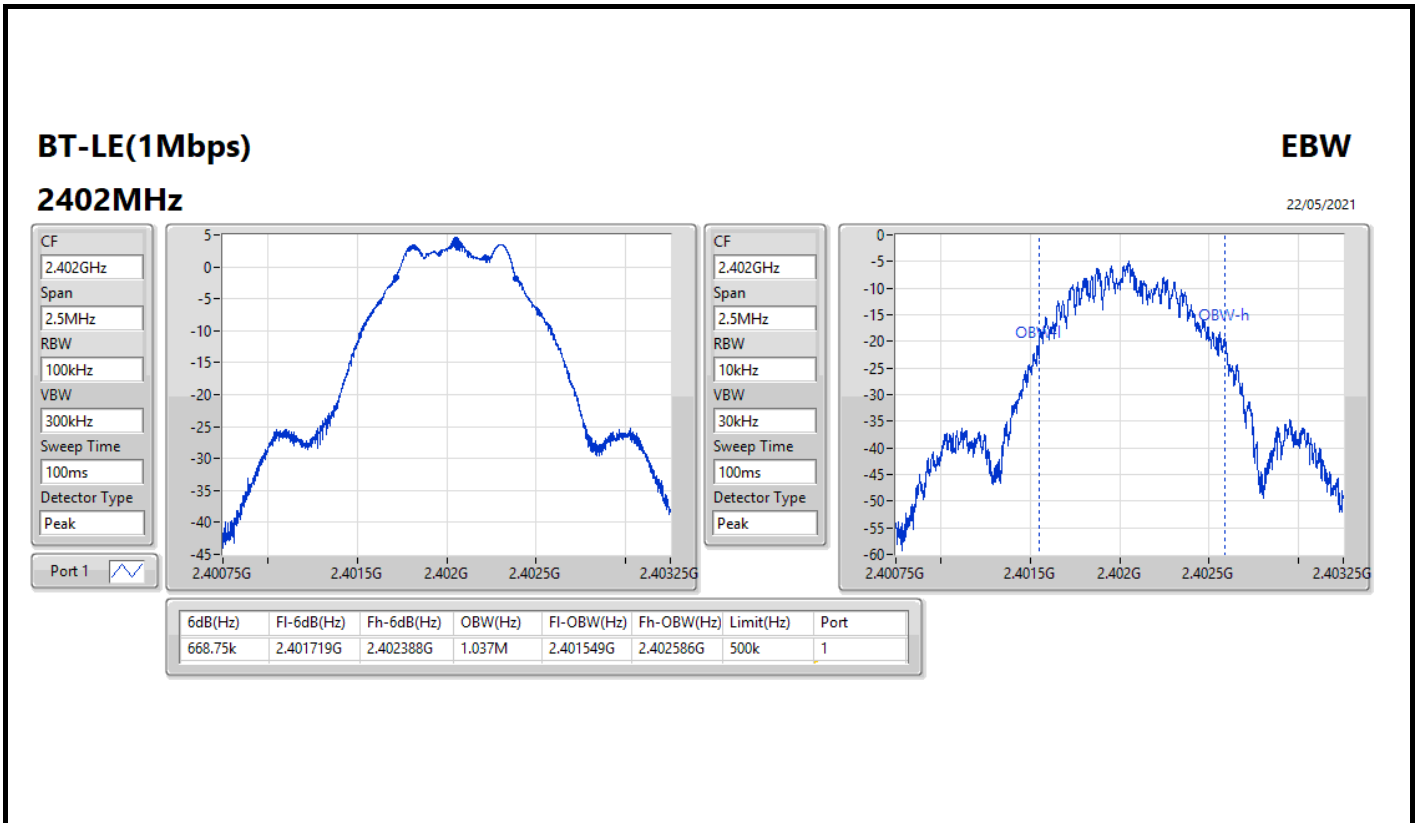

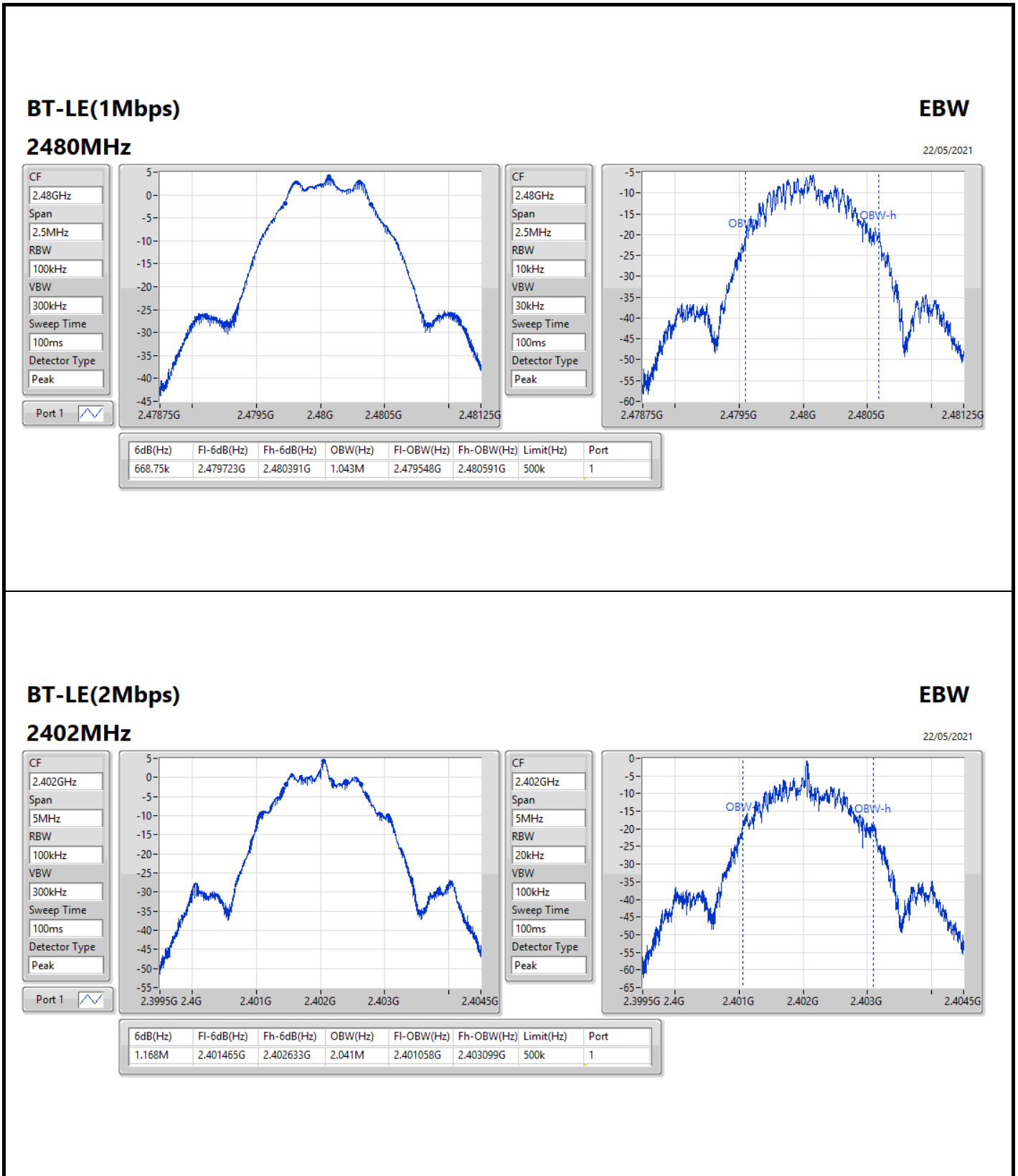

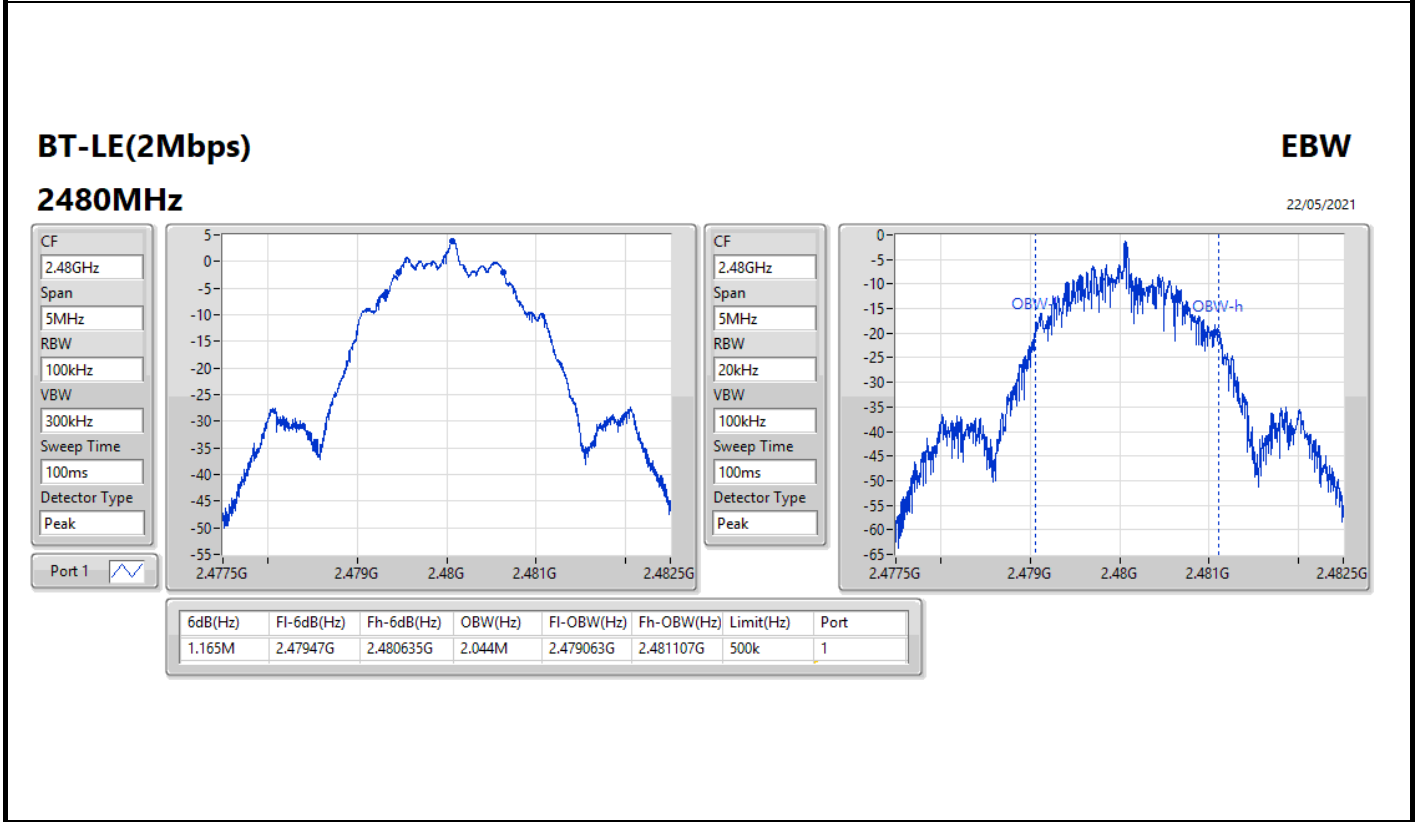
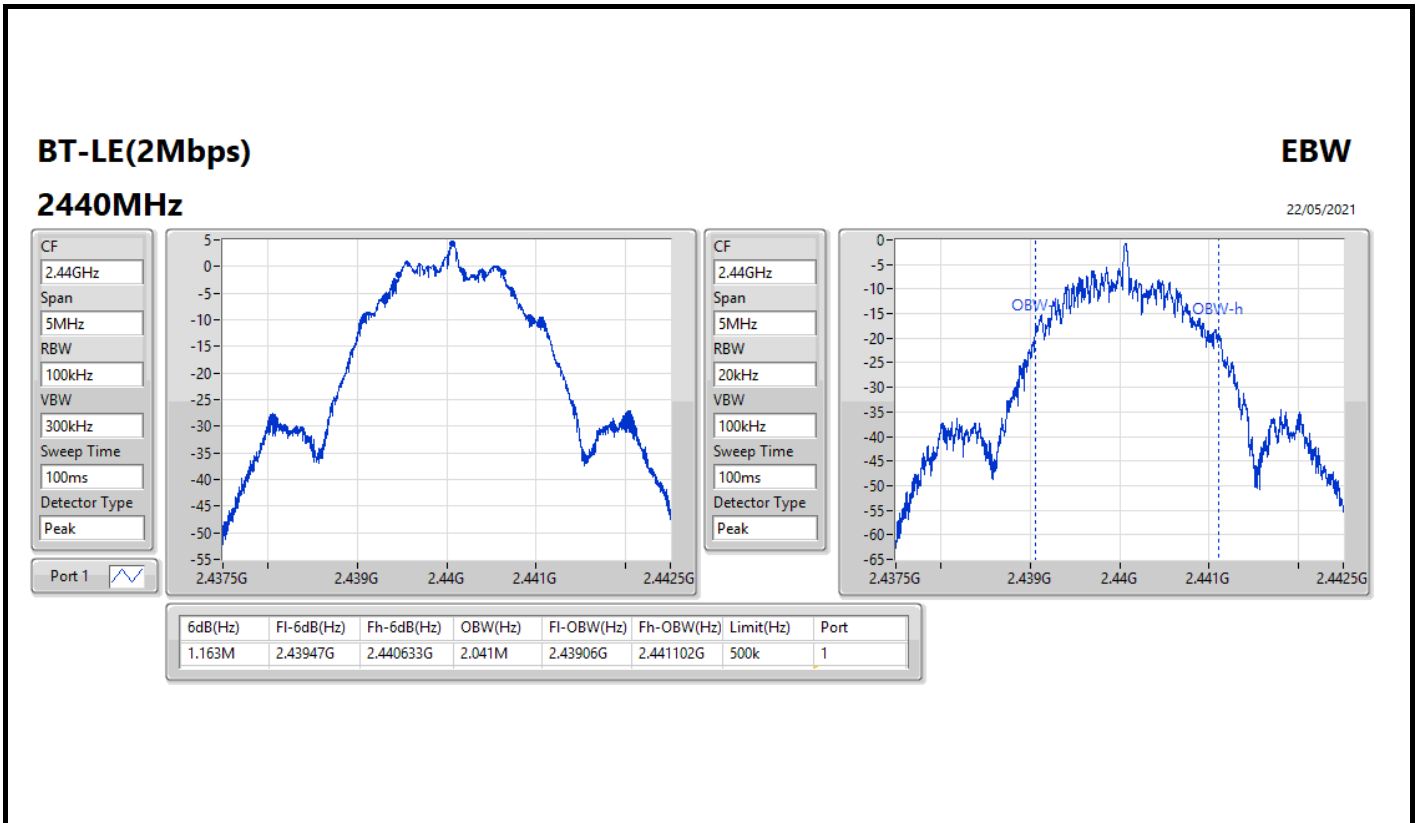



**For Radio 4
Summary**

Mode	Power (dBm)	Power (W)
2.4-2.4835GHz	-	-
BT-LE(1Mbps)	4.31	0.00270
BT-LE(2Mbps)	4.09	0.00256



Result

Mode	Result	Gain (dBi)	Power (dBm)	Power Limit (dBm)
BT-LE(1Mbps)	-	-	-	-
2402MHz	Pass	5.26	4.31	30.00
2440MHz	Pass	5.26	3.91	30.00
2480MHz	Pass	5.26	3.69	30.00
BT-LE(2Mbps)	-	-	-	-
2402MHz	Pass	5.26	4.09	30.00
2440MHz	Pass	5.26	3.70	30.00
2480MHz	Pass	5.26	3.47	30.00

DG = Directional Gain; Port X = Port X output power



**For Radio 4
Summary**

Mode	PD (dBm/RBW)
2.4-2.4835GHz	-
BT-LE(1Mbps)	-11.30
BT-LE(2Mbps)	-13.88

RBW=3 kHz.



Result

Mode	Result	Gain (dBi)	PD (dBm/RBW)	PD Limit (dBm/RBW)
BT-LE(1Mbps)	-	-	-	-
2402MHz	Pass	5.26	-11.30	8.00
2440MHz	Pass	5.26	-11.50	8.00
2480MHz	Pass	5.26	-12.34	8.00
BT-LE(2Mbps)	-	-	-	-
2402MHz	Pass	5.26	-13.88	8.00
2440MHz	Pass	5.26	-14.11	8.00
2480MHz	Pass	5.26	-14.40	8.00

DG = Directional Gain; RBW=3 kHz;

PD = trace bin-by-bin of each transmits port summing can be performed maximum power density; Port X = Port X power density;

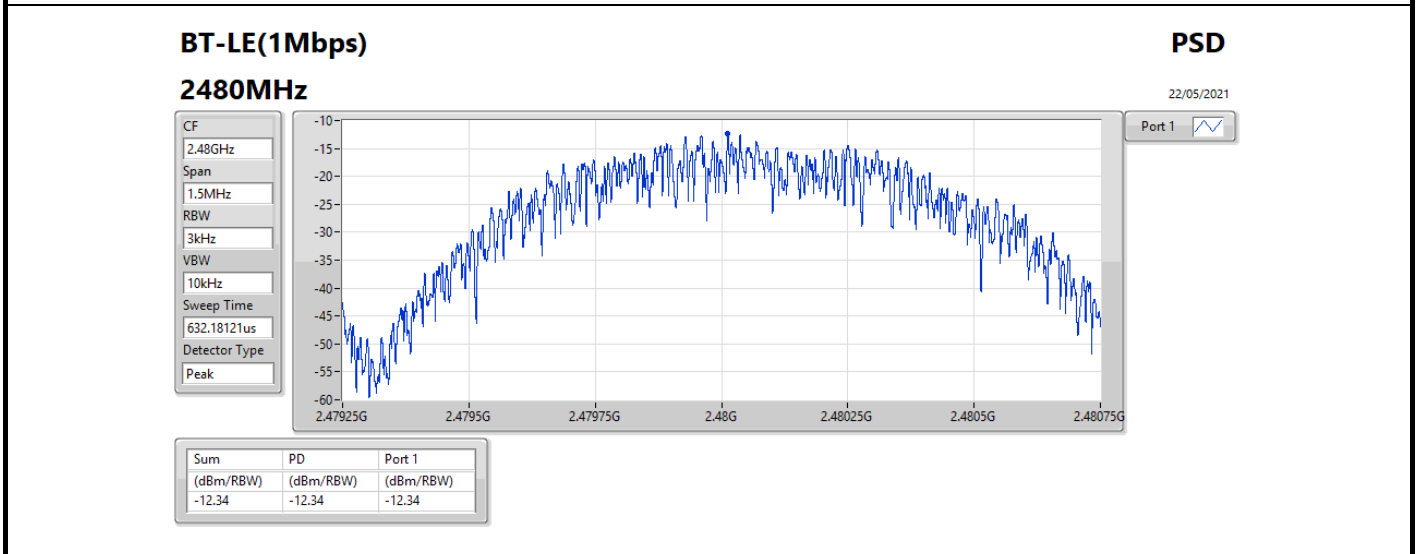
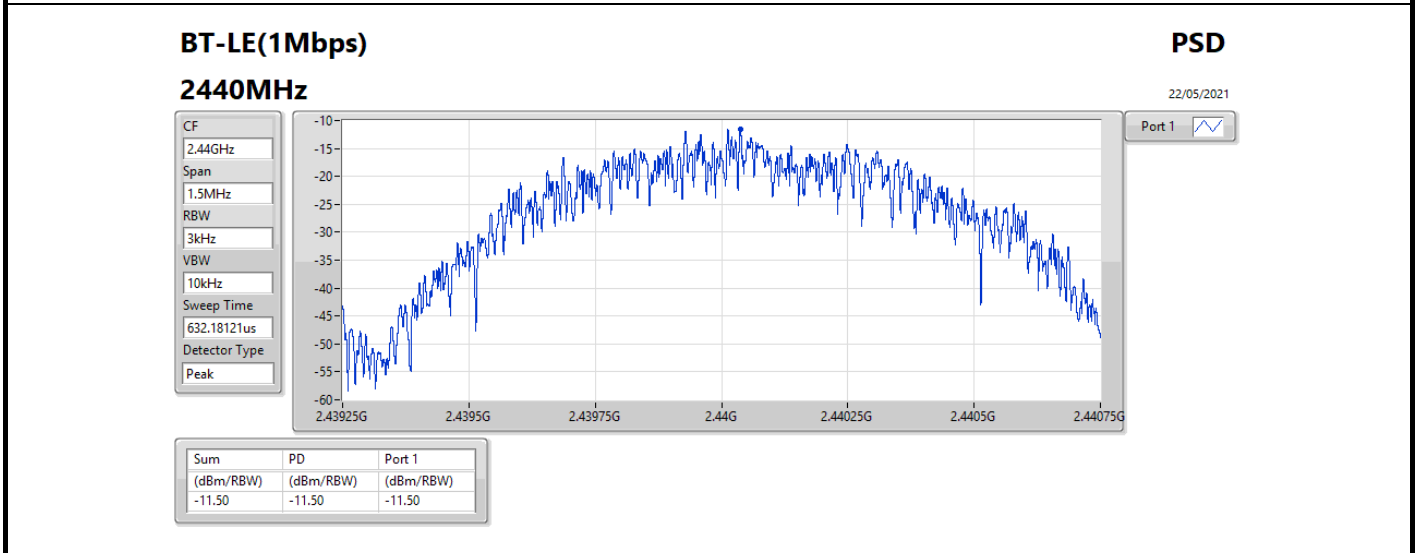
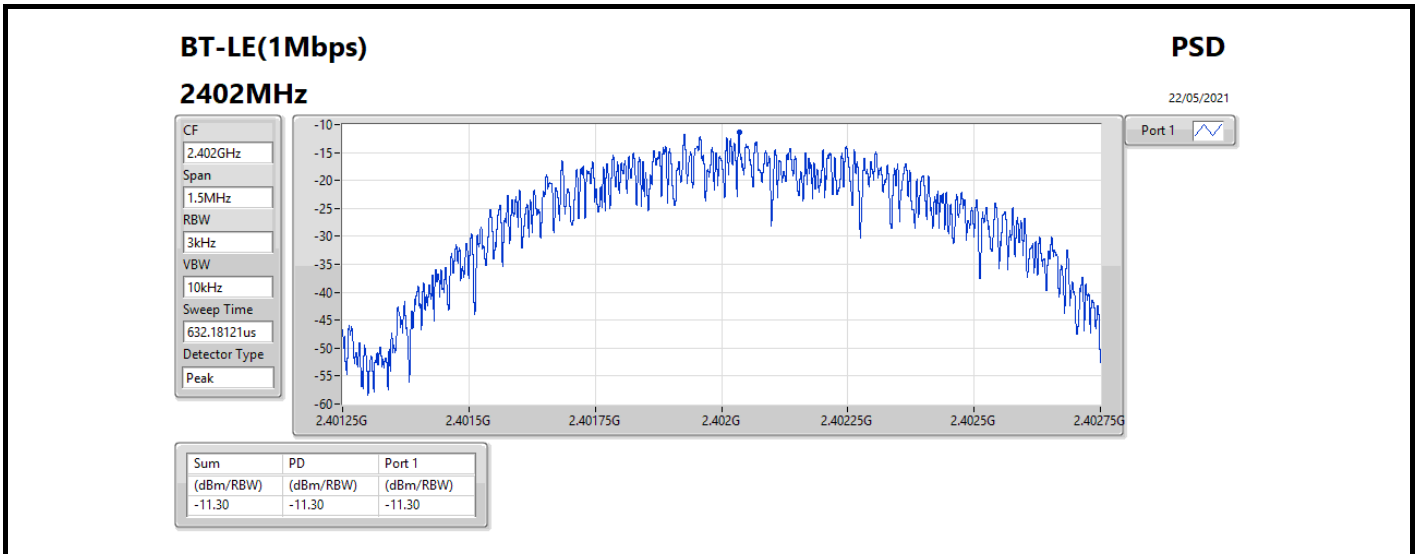

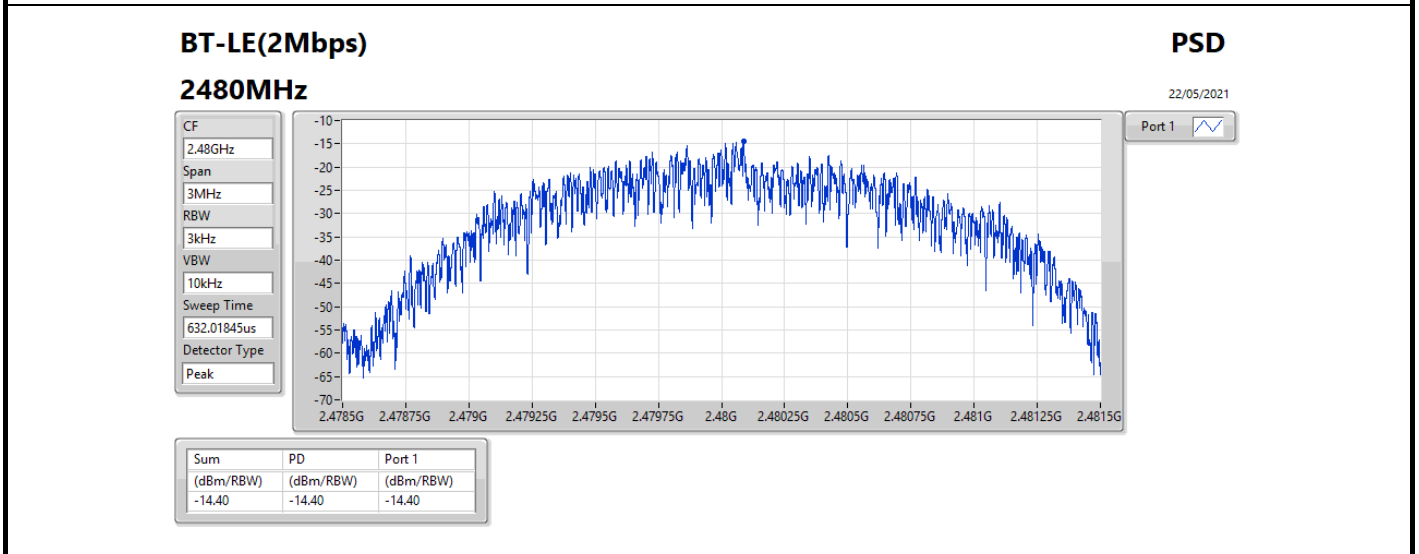
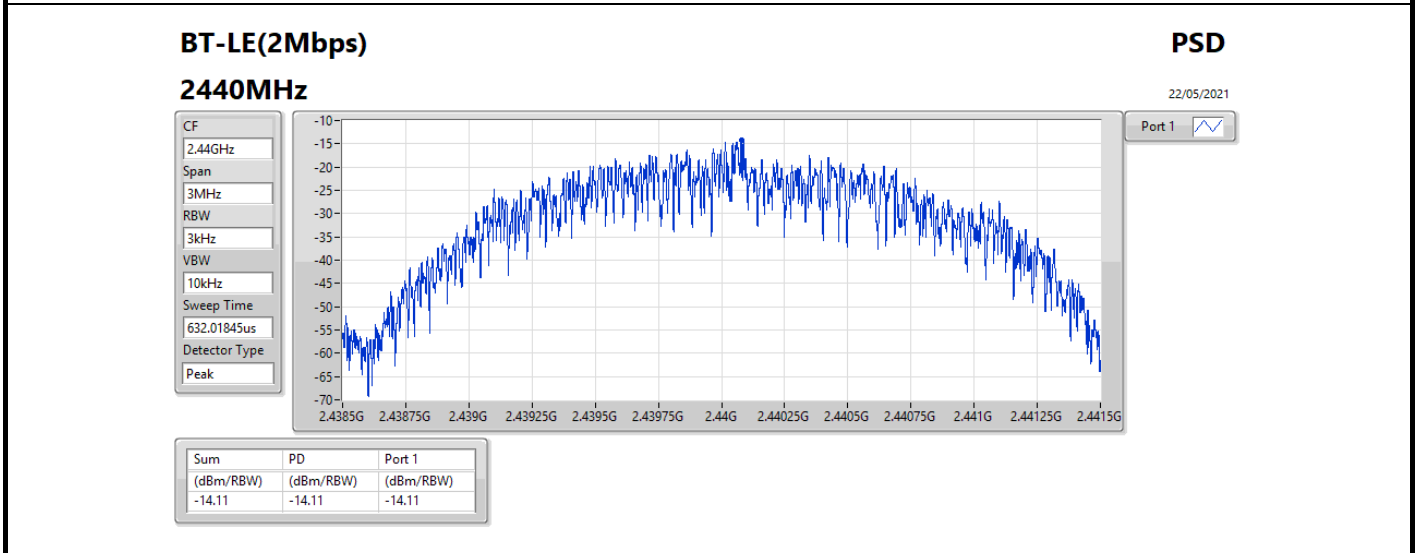
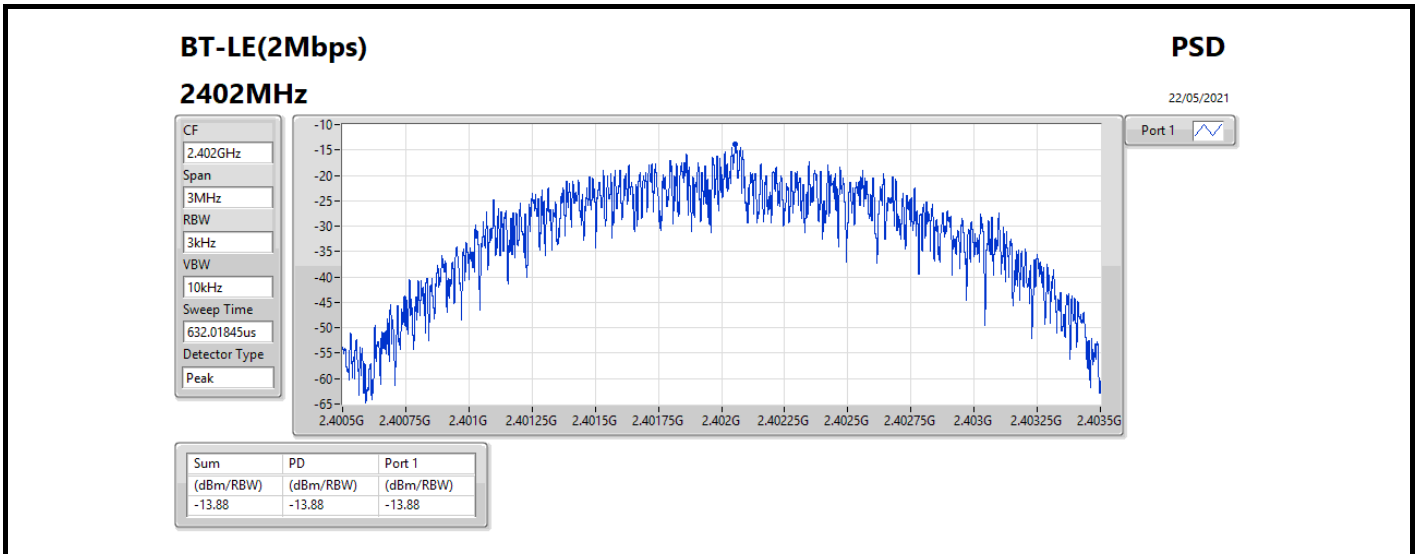



For Radio 4
Summary

Mode	Result	Ref (Hz)	Ref (dBm)	Limit (dBm)	Freq (Hz)	Level (dBm)	Freq (Hz)	Level (dBm)	Freq (Hz)	Level (dBm)	Freq (Hz)	Level (dBm)	Freq (Hz)	Level (dBm)	Port
2.4-2.4835GHz	-	-	-	-	-	-	-	-	-	-	-	-	-	-	-
BT-LE(1Mbps)	Pass	2.402G	4.03	-25.97	47.63M	-38.18	2.39836G	-47.54	2.4G	-46.62	2.49565G	-51.53	23.4618G	-44.12	1
BT-LE(2Mbps)	Pass	2.40205G	4.09	-25.91	47.92M	-37.23	2.4G	-29.74	2.4G	-28.59	2.50287G	-50.88	17.69426G	-43.82	1

Result

Mode	Result	Ref (Hz)	Ref (dBm)	Limit (dBm)	Freq (Hz)	Level (dBm)	Freq (Hz)	Level (dBm)	Freq (Hz)	Level (dBm)	Freq (Hz)	Level (dBm)	Freq (Hz)	Level (dBm)	Port
BT-LE(1Mbps)	-	-	-	-	-	-	-	-	-	-	-	-	-	-	-
2402MHz	Pass	2.402G	4.03	-25.97	47.63M	-38.18	2.39836G	-47.54	2.4G	-46.62	2.49565G	-51.53	23.4618G	-44.12	1
2440MHz	Pass	2.402G	4.03	-25.97	47.92M	-39.15	2.3983G	-52.31	2.4835G	-51.90	2.49174G	-51.18	23.48149G	-45.29	1
2480MHz	Pass	2.402G	4.03	-25.97	47.63M	-38.77	2.39243G	-51.49	2.4835G	-52.23	2.48364G	-49.93	24.88471G	-45.42	1
BT-LE(2Mbps)	-	-	-	-	-	-	-	-	-	-	-	-	-	-	-
2402MHz	Pass	2.40205G	4.09	-25.91	47.92M	-37.23	2.4G	-29.74	2.4G	-28.59	2.50287G	-50.88	17.69426G	-43.82	1
2440MHz	Pass	2.40205G	4.09	-25.91	47.63M	-38.93	2.39043G	-52.29	2.4835G	-52.71	2.48758G	-51.11	16.73816G	-44.47	1
2480MHz	Pass	2.40205G	4.09	-25.91	47.92M	-37.40	2.39407G	-51.95	2.4835G	-53.80	2.48407G	-49.75	24.86221G	-45.19	1

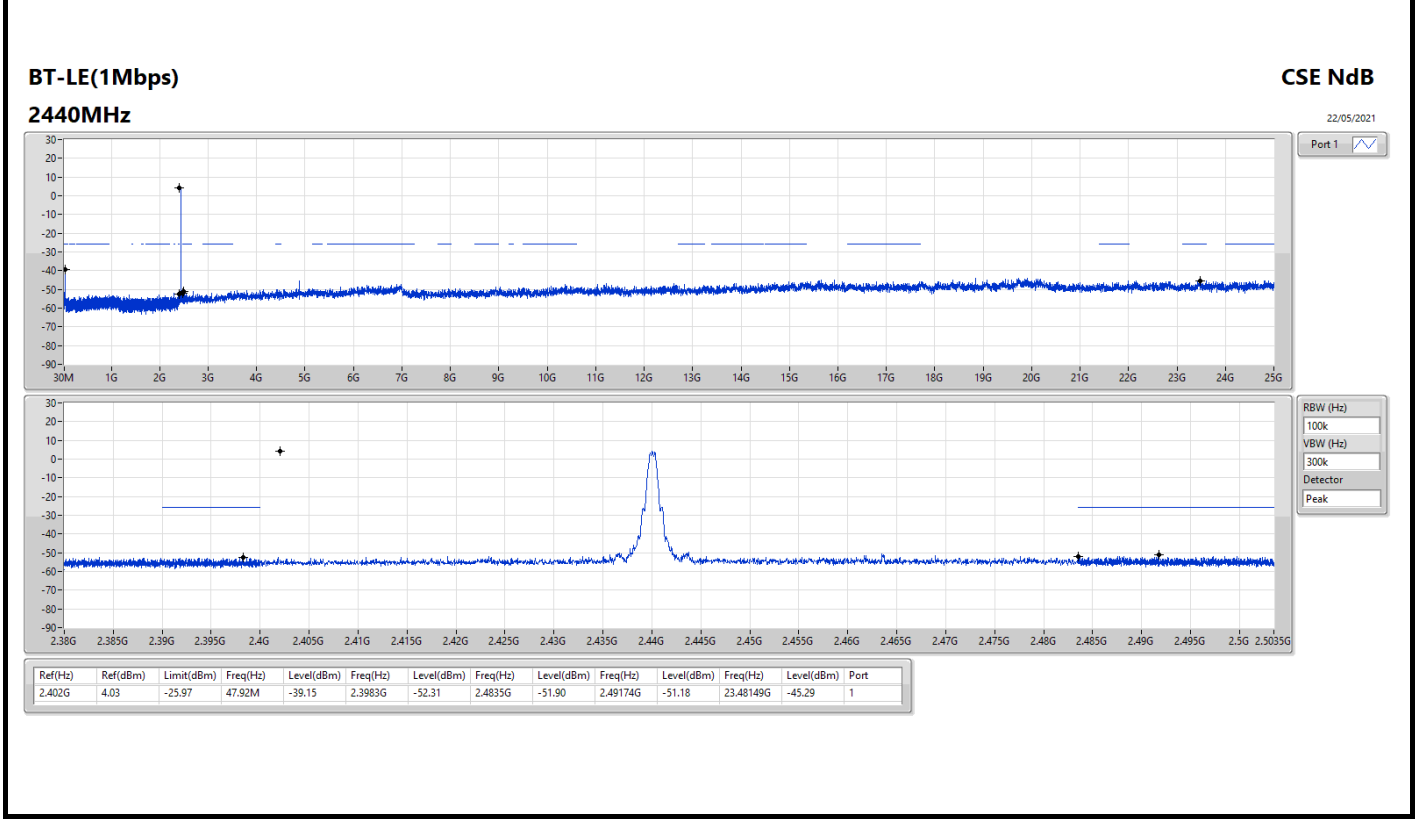
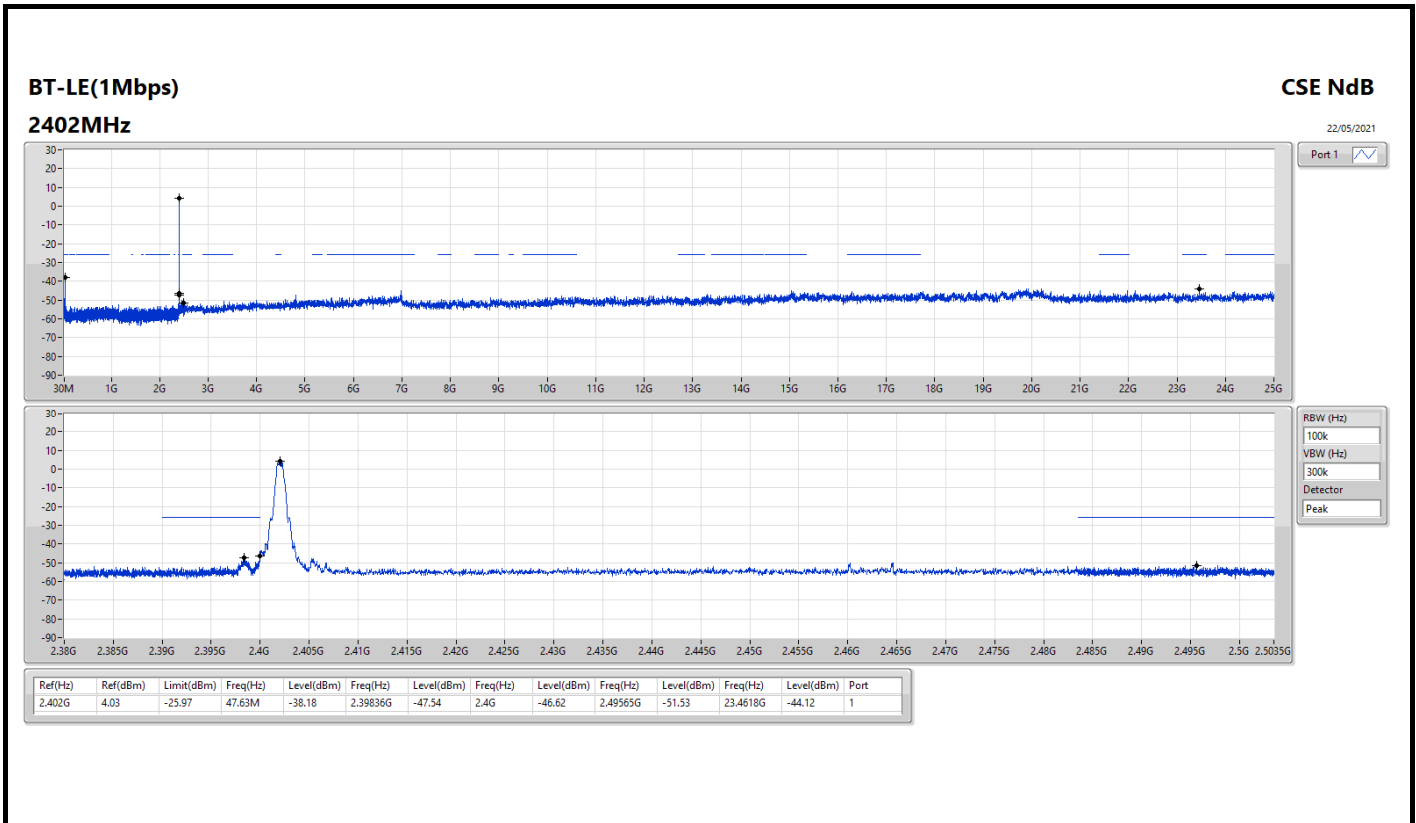

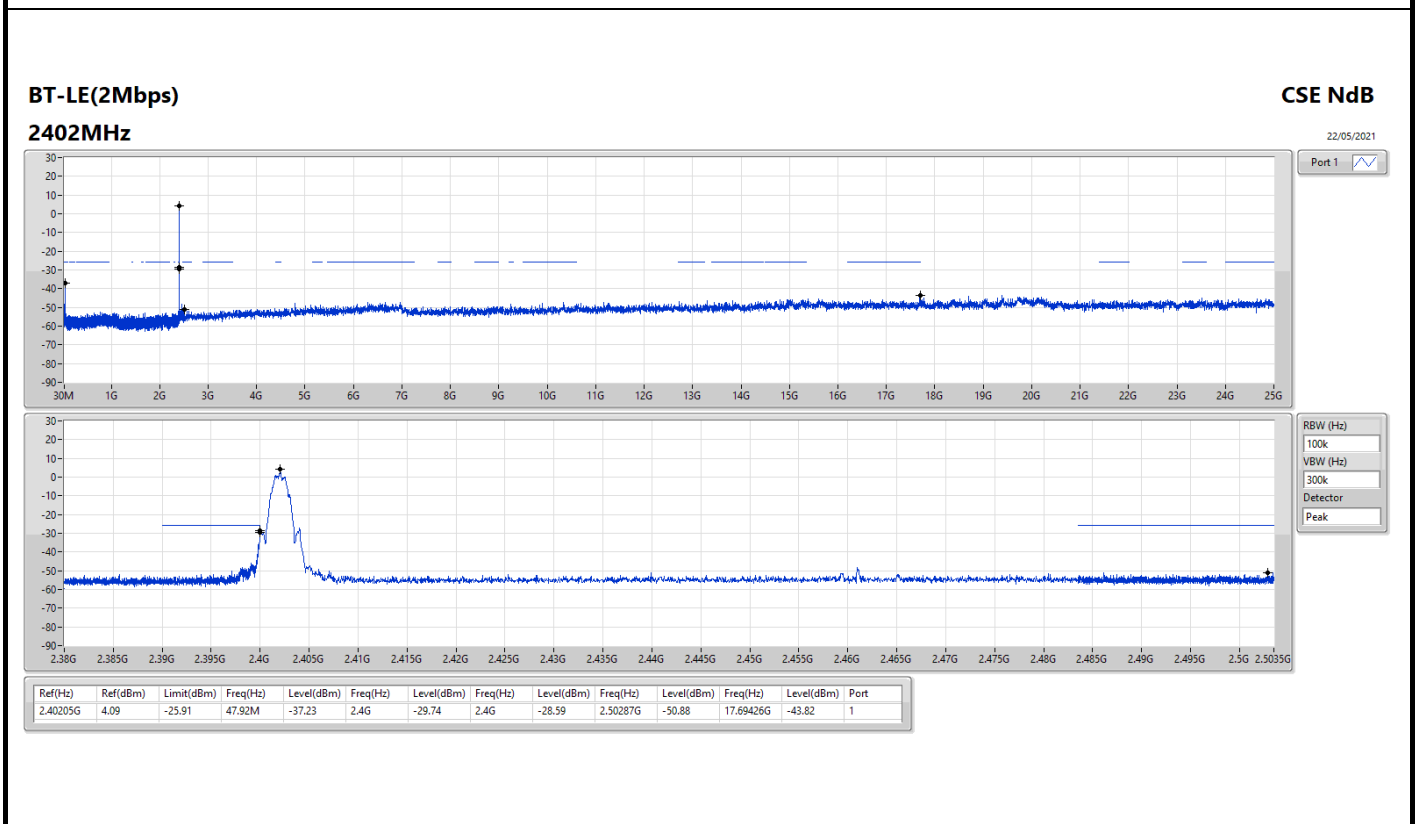
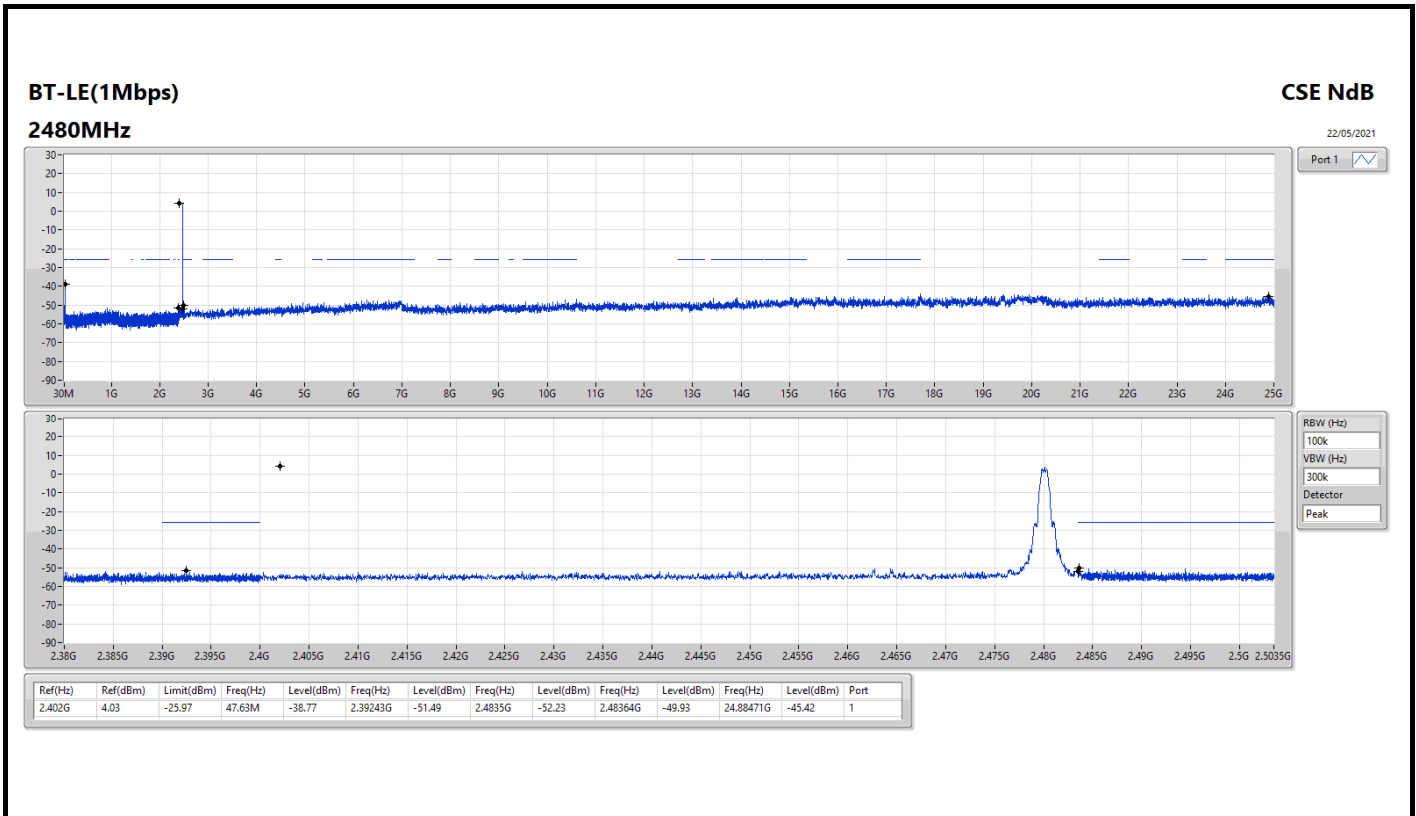

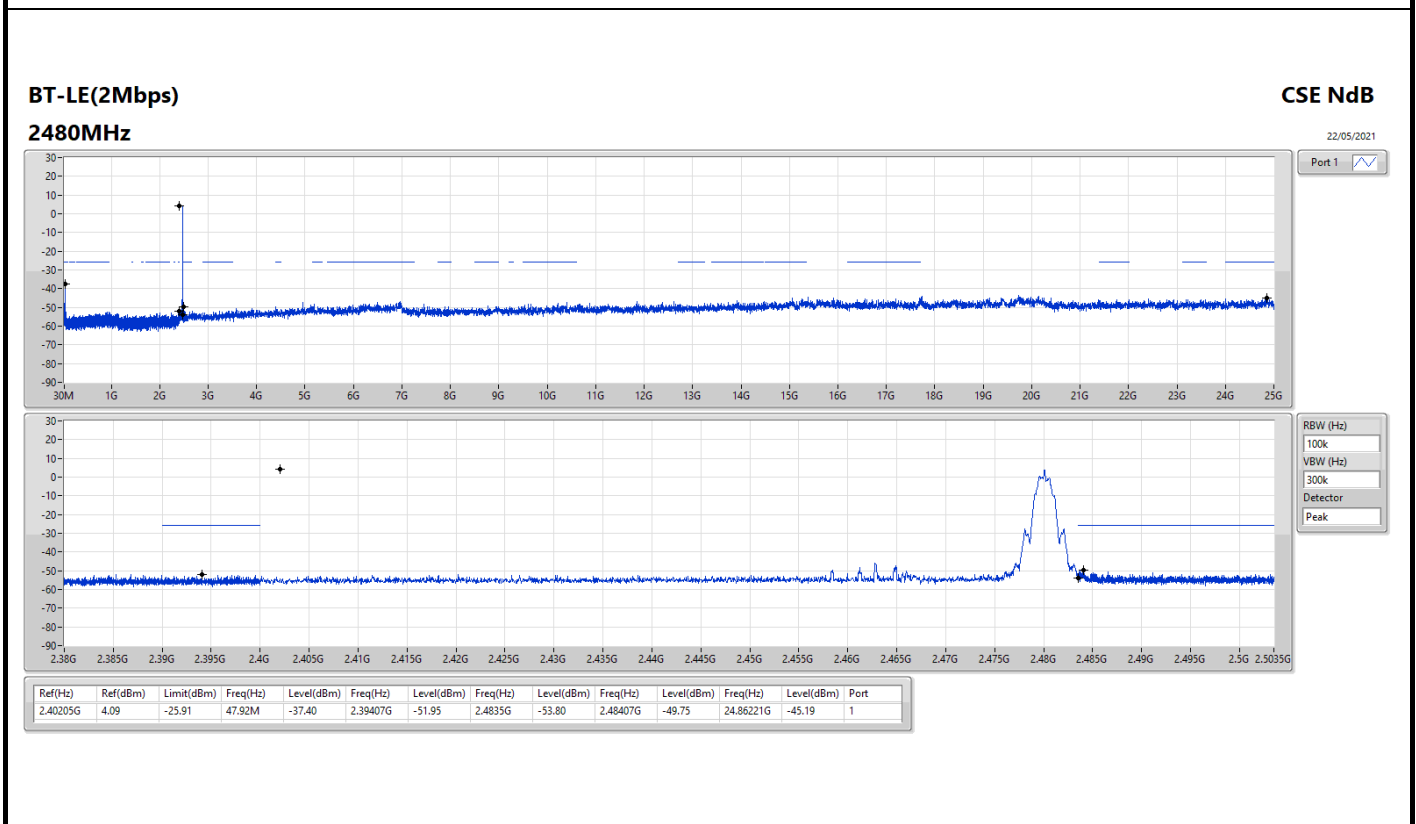
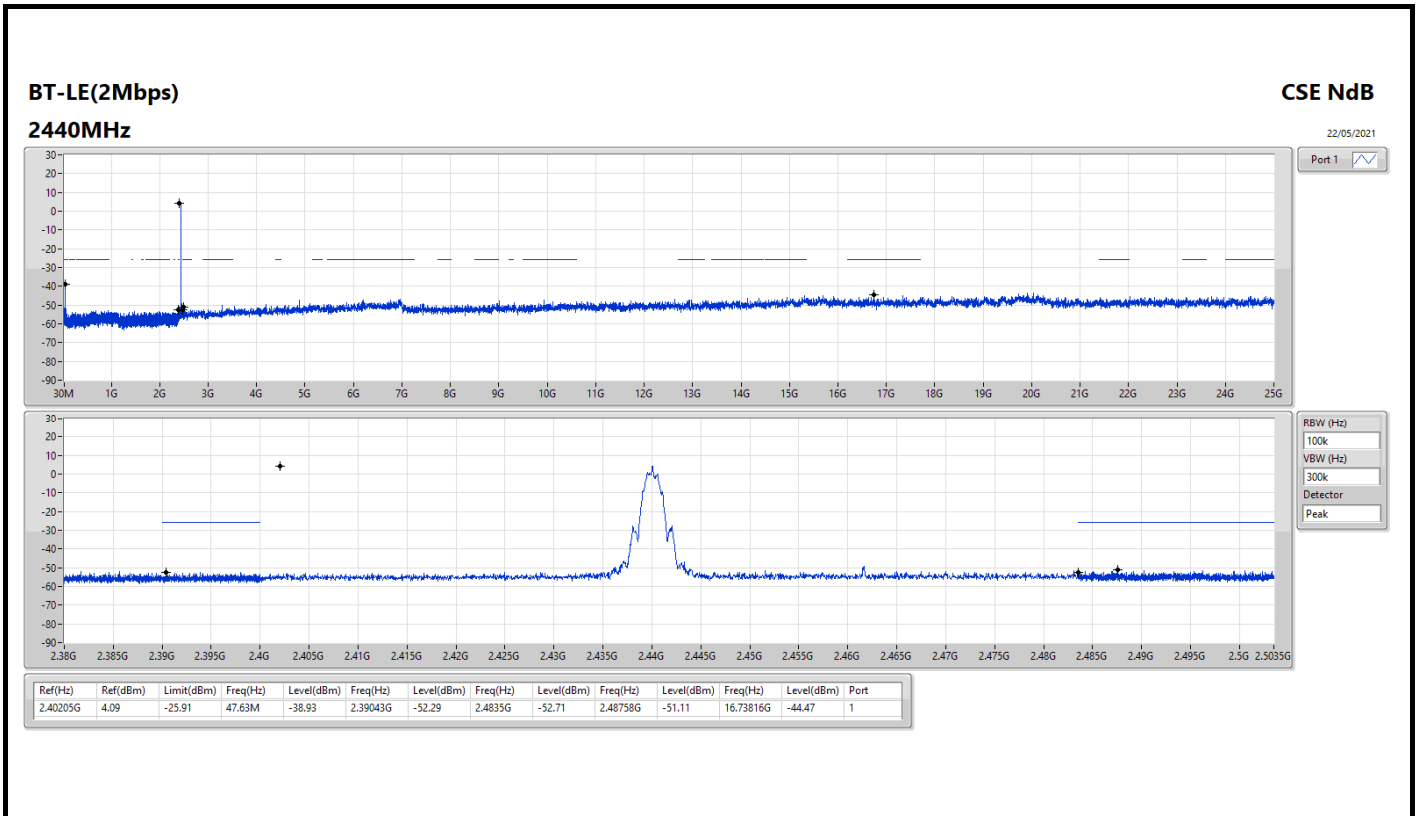



Summary

Mode	Result	Type	Freq (Hz)	Level (dBuV/m)	Limit (dBuV/m)	Margin (dB)	Condition
Mode 2	Pass	PK	33.88M	36.88	40.00	-3.12	Vertical

Mode 2

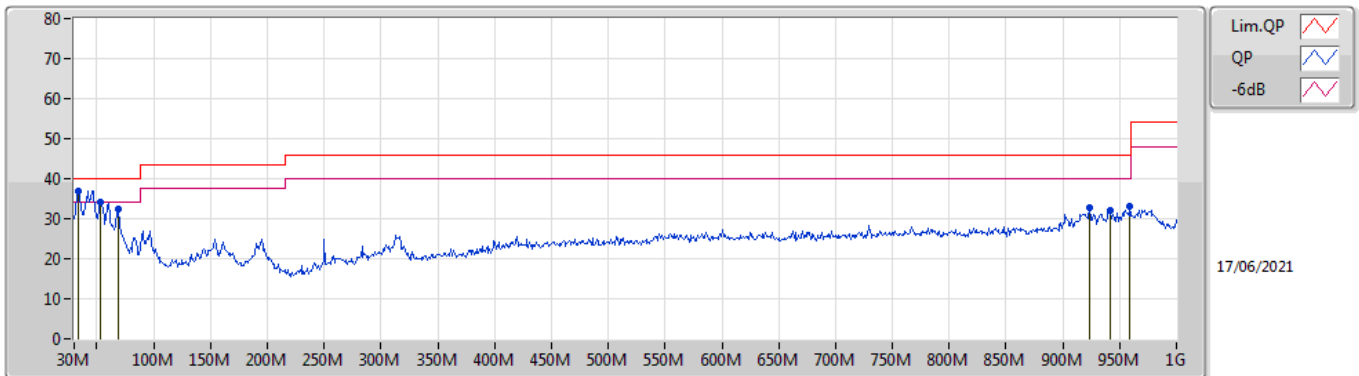

Type	Freq (Hz)	Level (dBuV/m)	Limit (dBuV/m)	Margin (dB)	Factor (dB/m)	Dist (m)	Condition	Azimuth (°)	Height (m)	Comment	Raw (dBuV/m)	AF (dB/m)	CL (dB)	PA (dB)
PK	33.88M	36.88	40.00	-3.12	-9.30	3	Vertical	218	1.00	"Worst"	46.18	21.56	0.58	31.44
PK	53.28M	34.25	40.00	-5.75	-18.87	3	Vertical	212	1.00	-	53.12	12.20	0.70	31.77
PK	68.8M	32.26	40.00	-7.74	-19.68	3	Vertical	334	1.25	-	51.94	11.36	0.78	31.82
PK	923.37M	32.74	46.00	-13.26	-4.42	3	Vertical	100	1.00	-	37.16	25.40	2.65	32.47
PK	941.8M	32.18	46.00	-13.82	-4.13	3	Vertical	100	1.00	-	36.31	25.64	2.68	32.45
PK	959.26M	33.00	46.00	-13.00	-3.87	3	Vertical	147	1.25	-	36.87	25.89	2.70	32.46

Mode 2

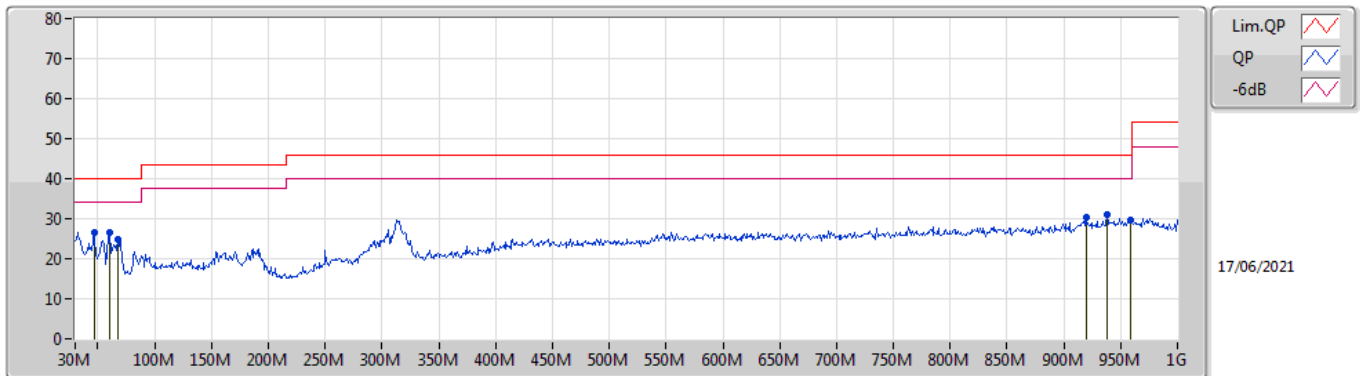

Type	Freq (Hz)	Level (dBuV/m)	Limit (dBuV/m)	Margin (dB)	Factor (dB/m)	Dist (m)	Condition	Azimuth (°)	Height (m)	Comment	Raw (dBuV/m)	AF (dB/m)	CL (dB)	PA (dB)
PK	46.49M	26.66	40.00	-13.34	-16.34	3	Horizontal	240	1.00	-	43.00	14.76	0.63	31.73
PK	60.07M	26.72	40.00	-13.28	-19.47	3	Horizontal	301	1.00	"Worst"	46.19	11.51	0.80	31.78
PK	67.83M	24.75	40.00	-15.25	-19.79	3	Horizontal	72	1.25	-	44.54	11.26	0.76	31.81
PK	919.49M	30.20	46.00	-15.80	-4.45	3	Horizontal	243	2.00	-	34.65	25.39	2.64	32.48
PK	937.92M	30.98	46.00	-15.02	-4.17	3	Horizontal	85	1.25	-	35.15	25.60	2.68	32.45
PK	958.29M	29.58	46.00	-16.42	-3.87	3	Horizontal	115	1.00	-	33.45	25.88	2.70	32.45



Summary

Mode	Result	Type	Freq (Hz)	Level (dBuV/m)	Limit (dBuV/m)	Margin (dB)	Dist (m)	Condition	Azimuth (°)	Height (m)	Comments
2.4-2.4835GHz	-	-	-	-	-	-	-	-	-	-	-
BT-LE(2Mbps)	Pass	AV	2.4835G	52.51	54.00	-1.49	3	Horizontal	323	1.53	-

BT-LE(1Mbps)

22/05/2021

2402MHz_TX

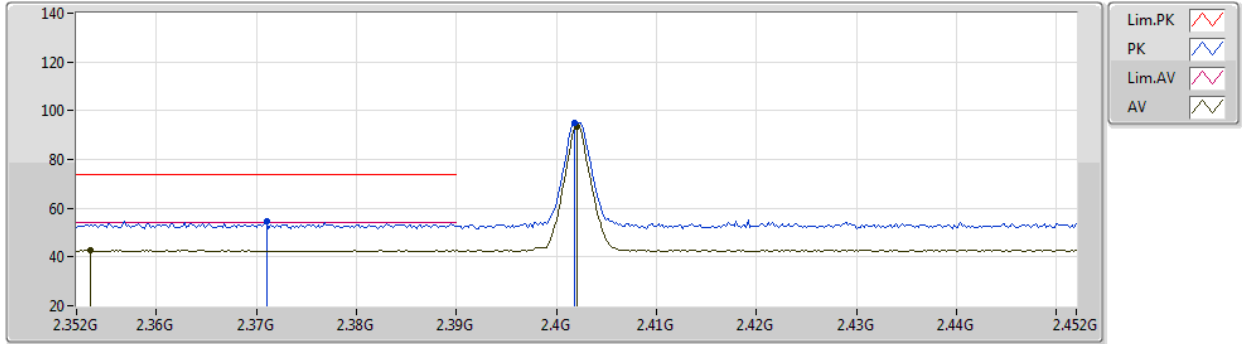

EUT Y_1TX
Setting OE
01-C-G-2

Type	Freq (Hz)	Level (dBuV/m)	Limit (dBuV/m)	Margin (dB)	Raw (dBuV)	Dist (m)	Condition	Azimuth (°)	Height (m)	Comment	AF (dB)	CL (dB)	PA (dB)
PK	2.371G	54.77	74.00	-19.23	25.26	3	Vertical	34	2.86	-	27.34	2.17	-
AV	2.3534G	42.84	54.00	-11.16	13.38	3	Vertical	34	2.86	-	27.31	2.15	-
PK	2.4018G	95.01	Inf	-Inf	65.41	3	Vertical	34	2.86	-	27.40	2.20	-
AV	2.402G	93.58	Inf	-Inf	63.98	3	Vertical	34	2.86	-	27.40	2.20	-

BT-LE(1Mbps)

22/05/2021

2402MHz_TX

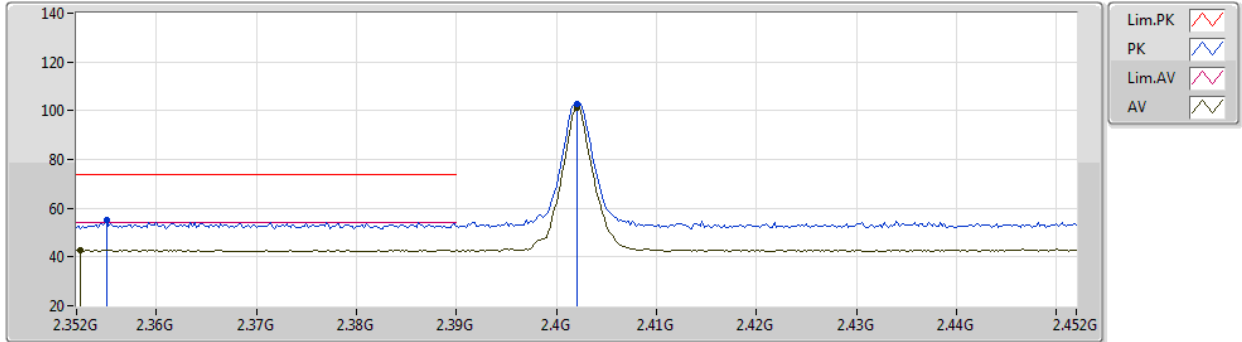

EUT Y_1TX
Setting OE
01-C-G-2

Type	Freq (Hz)	Level (dBuV/m)	Limit (dBuV/m)	Margin (dB)	Raw (dBuV)	Dist (m)	Condition	Azimuth (°)	Height (m)	Comment	AF (dB)	CL (dB)	PA (dB)
PK	2.355G	54.93	74.00	-19.07	25.46	3	Horizontal	318	2.24	-	27.31	2.16	-
AV	2.3524G	42.99	54.00	-11.01	13.54	3	Horizontal	318	2.24	-	27.30	2.15	-
PK	2.402G	102.52	Inf	-Inf	72.92	3	Horizontal	318	2.24	-	27.40	2.20	-
AV	2.402G	101.14	Inf	-Inf	71.54	3	Horizontal	318	2.24	-	27.40	2.20	-

BT-LE(1Mbps)

22/05/2021

2402MHz_TX

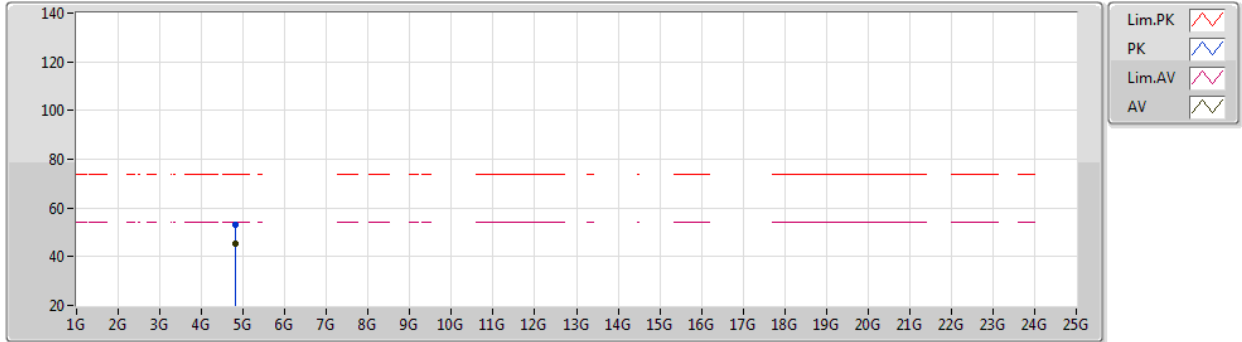

EUT_V_1TX
Setting 0E
01-C-G-2

Type	Freq (Hz)	Level (dBuV/m)	Limit (dBuV/m)	Margin (dB)	Raw (dBuV)	Dist (m)	Condition	Azimuth (°)	Height (m)	Comment	AF (dB)	CL (dB)	PA (dB)
PK	4.80362G	53.35	74.00	-20.65	49.22	3	Vertical	336	1.71	-	32.12	5.00	32.99
AV	4.80392G	45.12	54.00	-8.88	40.99	3	Vertical	336	1.71	-	32.12	5.00	32.99

BT-LE(1Mbps)

22/05/2021

2402MHz_TX

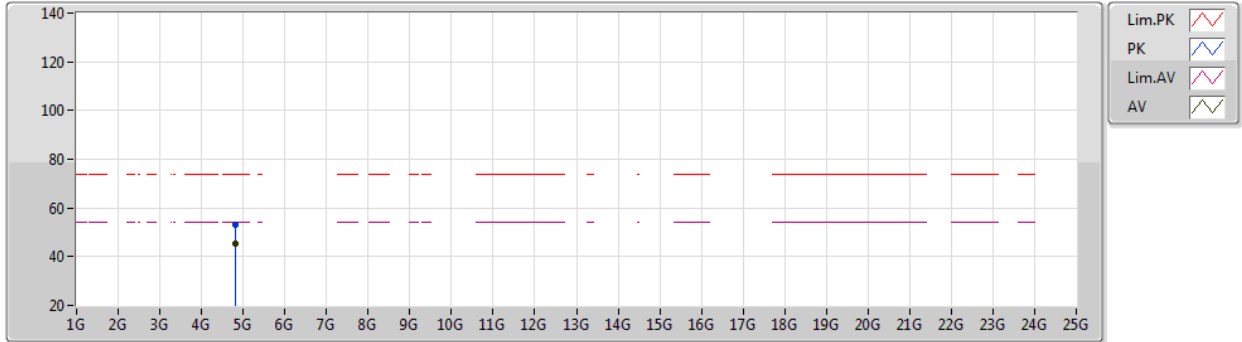

EUT V_1TX
Setting 0E
01-C-G-2

Type	Freq (Hz)	Level (dBuV/m)	Limit (dBuV/m)	Margin (dB)	Raw (dBuV)	Dist (m)	Condition	Azimuth (°)	Height (m)	Comment	AF (dB)	CL (dB)	PA (dB)
PK	4.80448G	53.35	74.00	-20.65	49.21	3	Horizontal	347	1.42	-	32.13	5.00	32.99
AV	4.80401G	45.41	54.00	-8.59	41.28	3	Horizontal	347	1.42	-	32.12	5.00	32.99

BT-LE(1Mbps)

22/05/2021

2440MHz_TX

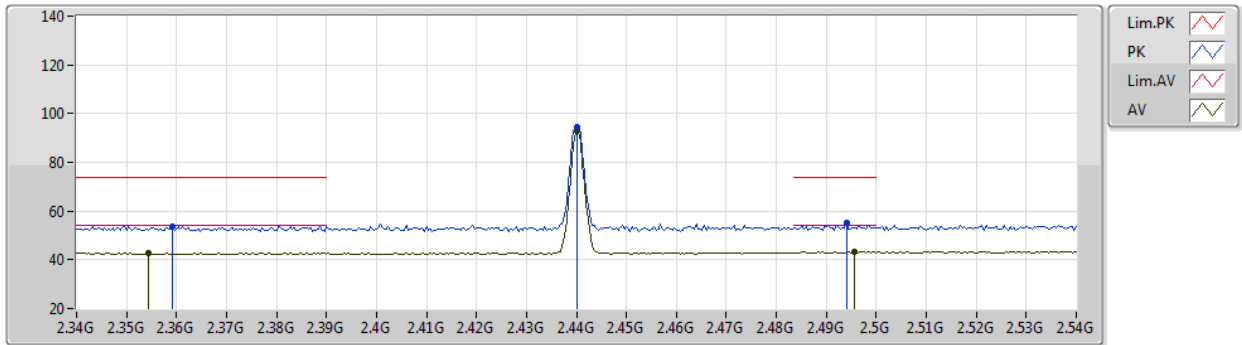

EUT Y_1TX
Setting OE
01-C-G-2

Type	Freq (Hz)	Level (dBuV/m)	Limit (dBuV/m)	Margin (dB)	Raw (dBuV)	Dist (m)	Condition	Azimuth (°)	Height (m)	Comment	AF (dB)	CL (dB)	PA (dB)
PK	2.3592G	53.79	74.00	-20.21	24.31	3	Vertical	30	3.00	-	27.32	2.16	-
AV	2.3544G	42.97	54.00	-11.03	13.51	3	Vertical	30	3.00	-	27.31	2.15	-
PK	2.44G	94.67	Inf	-Inf	64.95	3	Vertical	30	3.00	-	27.48	2.24	-
AV	2.44G	93.12	Inf	-Inf	63.40	3	Vertical	30	3.00	-	27.48	2.24	-
PK	2.494G	55.00	74.00	-19.00	24.95	3	Vertical	30	3.00	-	27.76	2.29	-
AV	2.4956G	43.33	54.00	-10.67	13.26	3	Vertical	30	3.00	-	27.77	2.30	-

BT-LE(1Mbps)

22/05/2021

2440MHz_TX

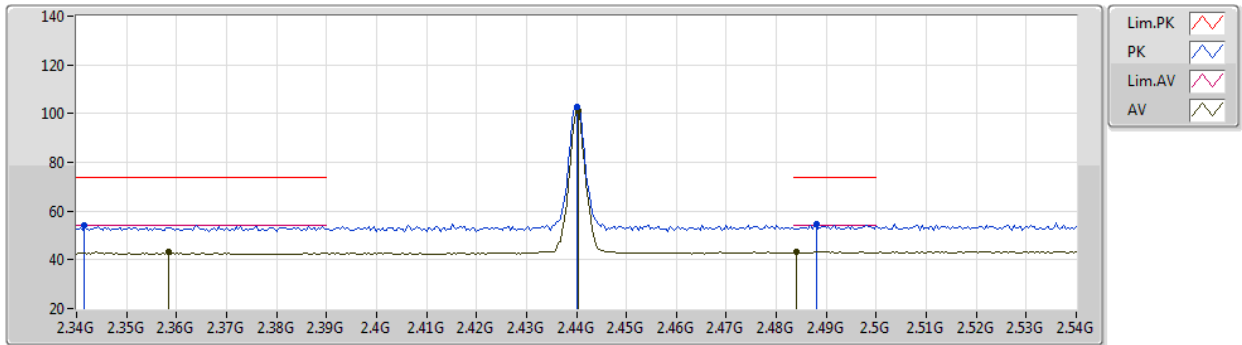

EUT Y_1TX
Setting OE
01-C-G-2

Type	Freq (Hz)	Level (dBuV/m)	Limit (dBuV/m)	Margin (dB)	Raw (dBuV)	Dist (m)	Condition	Azimuth (°)	Height (m)	Comment	AF (dB)	CL (dB)	PA (dB)
PK	2.3416G	54.15	74.00	-19.85	24.71	3	Horizontal	317	2.21	-	27.30	2.14	-
AV	2.3584G	43.20	54.00	-10.80	13.72	3	Horizontal	317	2.21	-	27.32	2.16	-
PK	2.44G	102.64	Inf	-Inf	72.92	3	Horizontal	317	2.21	-	27.48	2.24	-
AV	2.4404G	101.16	Inf	-Inf	71.44	3	Horizontal	317	2.21	-	27.48	2.24	-
PK	2.488G	54.54	74.00	-19.46	24.52	3	Horizontal	317	2.21	-	27.73	2.29	-
AV	2.484G	43.23	54.00	-10.77	13.25	3	Horizontal	317	2.21	-	27.70	2.28	-

BT-LE(1Mbps)

22/05/2021

2440MHz_TX

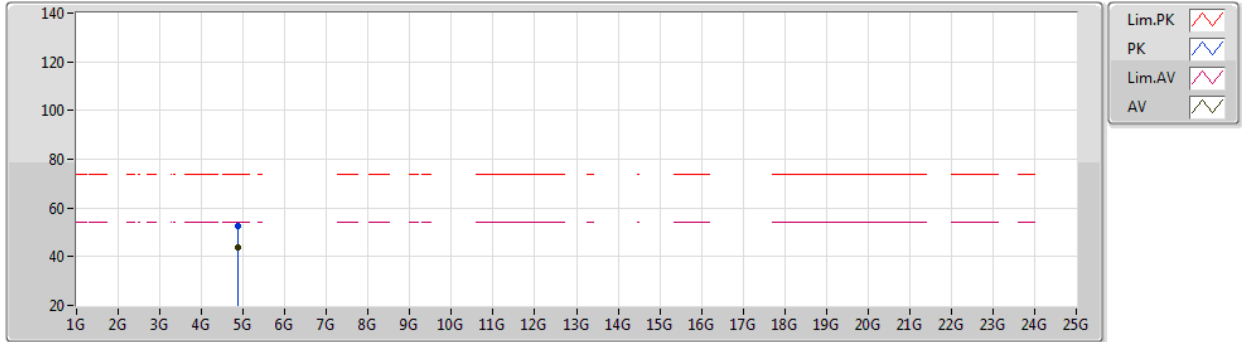

EUT_V_1TX
Setting 0E
01-C-G-2

Type	Freq (Hz)	Level (dBuV/m)	Limit (dBuV/m)	Margin (dB)	Raw (dBuV)	Dist (m)	Condition	Azimuth (°)	Height (m)	Comment	AF (dB)	CL (dB)	PA (dB)
PK	4.88068G	52.57	74.00	-21.43	48.05	3	Vertical	260	1.37	-	32.46	5.04	32.98
AV	4.88014G	43.92	54.00	-10.08	39.40	3	Vertical	260	1.37	-	32.46	5.04	32.98

BT-LE(1Mbps)

22/05/2021

2440MHz_TX

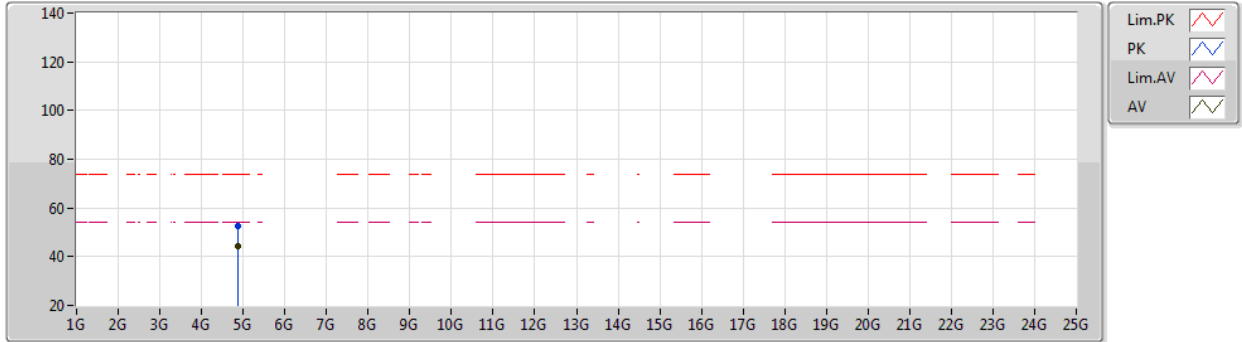

EUT_V_1TX
Setting 0E
01-C-G-2

Type	Freq (Hz)	Level (dBuV/m)	Limit (dBuV/m)	Margin (dB)	Raw (dBuV)	Dist (m)	Condition	Azimuth (°)	Height (m)	Comment	AF (dB)	CL (dB)	PA (dB)
PK	4.8807G	52.80	74.00	-21.20	48.28	3	Horizontal	349	1.52	-	32.46	5.04	32.98
AV	4.87994G	44.53	54.00	-9.47	40.01	3	Horizontal	349	1.52	-	32.46	5.04	32.98

BT-LE(1Mbps)

22/05/2021

2480MHz_TX

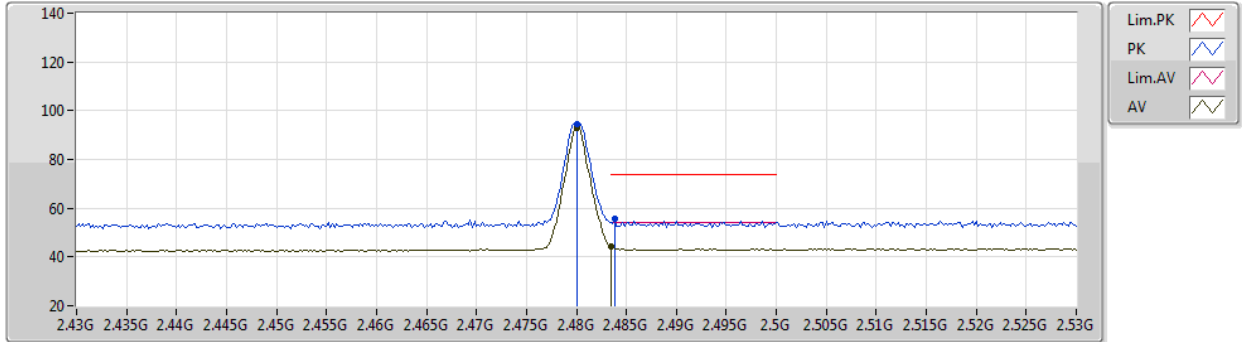

EUT Y_1TX
Setting OE
01-C-G-2

Type	Freq (Hz)	Level (dBuV/m)	Limit (dBuV/m)	Margin (dB)	Raw (dBuV)	Dist (m)	Condition	Azimuth (°)	Height (m)	Comment	AF (dB)	CL (dB)	PA (dB)
PK	2.48G	94.47	Inf	-Inf	64.51	3	Vertical	35	2.97	-	27.68	2.28	-
AV	2.48G	93.02	Inf	-Inf	63.06	3	Vertical	35	2.97	-	27.68	2.28	-
PK	2.4838G	55.47	74.00	-18.53	25.49	3	Vertical	35	2.97	-	27.70	2.28	-
AV	2.4835G	44.45	54.00	-9.55	14.47	3	Vertical	35	2.97	-	27.70	2.28	-

BT-LE(1Mbps)

22/05/2021

2480MHz_TX

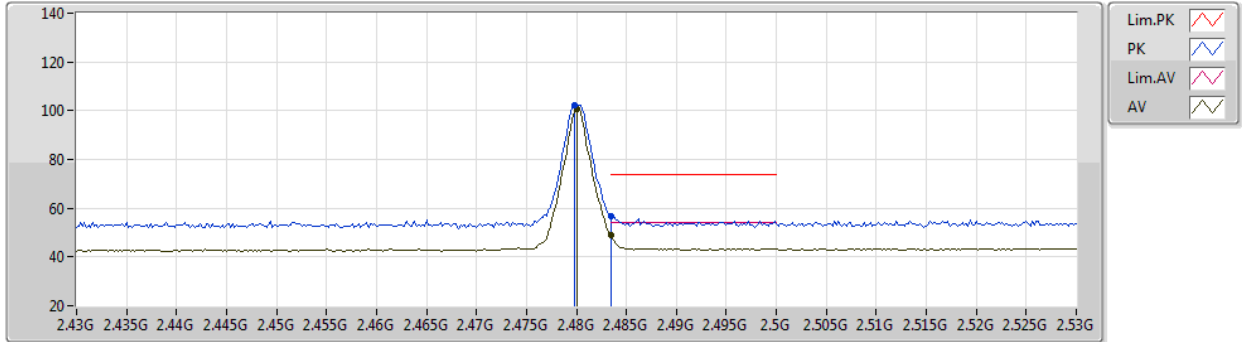

EUT Y_1TX
Setting OE
01-C-G-2

Type	Freq (Hz)	Level (dBuV/m)	Limit (dBuV/m)	Margin (dB)	Raw (dBuV)	Dist (m)	Condition	Azimuth (°)	Height (m)	Comment	AF (dB)	CL (dB)	PA (dB)
PK	2.4798G	102.11	Inf	-Inf	72.15	3	Horizontal	325	1.80	-	27.68	2.28	-
AV	2.48G	100.50	Inf	-Inf	70.54	3	Horizontal	325	1.80	-	27.68	2.28	-
PK	2.4835G	56.76	74.00	-17.24	26.78	3	Horizontal	325	1.80	-	27.70	2.28	-
AV	2.4835G	48.94	54.00	-5.06	18.96	3	Horizontal	325	1.80	-	27.70	2.28	-

BT-LE(1Mbps)

22/05/2021

2480MHz_TX

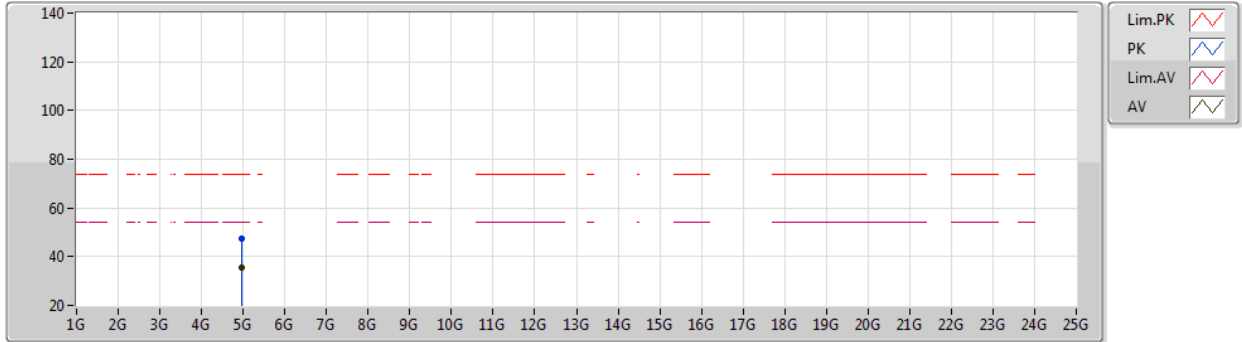

EUT_V_1TX
Setting 0E
01-C-G-2

Type	Freq (Hz)	Level (dBuV/m)	Limit (dBuV/m)	Margin (dB)	Raw (dBuV)	Dist (m)	Condition	Azimuth (°)	Height (m)	Comment	AF (dB)	CL (dB)	PA (dB)
PK	4.95766G	47.27	74.00	-26.73	42.38	3	Vertical	132	2.29	-	32.78	5.08	32.97
AV	4.96014G	35.72	54.00	-18.28	30.83	3	Vertical	132	2.29	-	32.78	5.08	32.97

BT-LE(1Mbps)

22/05/2021

2480MHz_TX

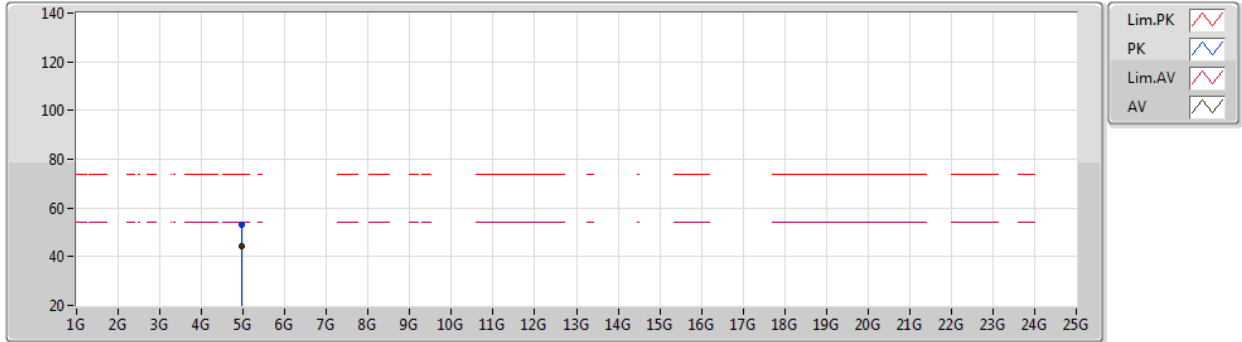

EUT_V_1TX
Setting 0E
01-C-G-2

Type	Freq (Hz)	Level (dBuV/m)	Limit (dBuV/m)	Margin (dB)	Raw (dBuV)	Dist (m)	Condition	Azimuth (°)	Height (m)	Comment	AF (dB)	CL (dB)	PA (dB)
PK	4.96011G	53.25	74.00	-20.75	48.36	3	Horizontal	348	1.47	-	32.78	5.08	32.97
AV	4.96004G	44.52	54.00	-9.48	39.63	3	Horizontal	348	1.47	-	32.78	5.08	32.97

BT-LE(2Mbps)

22/05/2021

2402MHz_TX

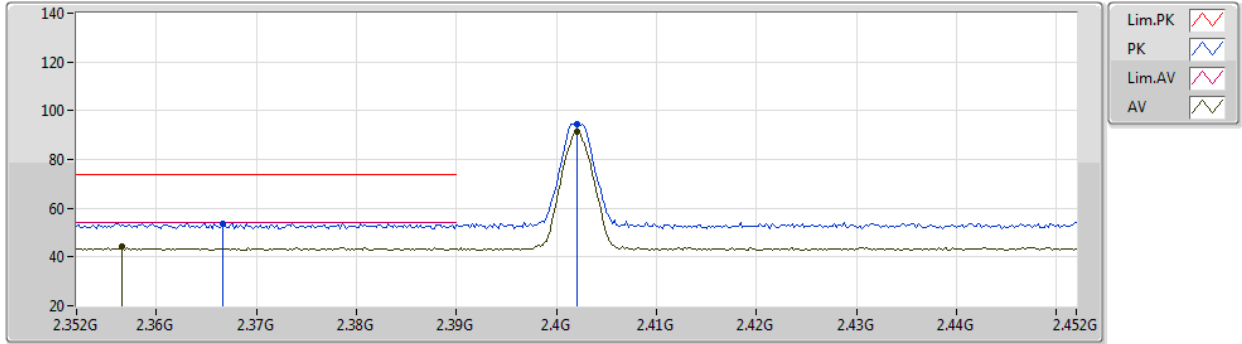

EUT Y_1TX
Setting OE
01-C-G-2

Type	Freq (Hz)	Level (dBuV/m)	Limit (dBuV/m)	Margin (dB)	Raw (dBuV)	Dist (m)	Condition	Azimuth (°)	Height (m)	Comment	AF (dB)	CL (dB)	PA (dB)
PK	2.3666G	53.85	74.00	-20.15	24.35	3	Vertical	38	2.89	-	27.33	2.17	-
AV	2.3566G	44.23	54.00	-9.77	14.76	3	Vertical	38	2.89	-	27.31	2.16	-
PK	2.402G	94.44	Inf	-Inf	64.84	3	Vertical	38	2.89	-	27.40	2.20	-
AV	2.402G	91.44	Inf	-Inf	61.84	3	Vertical	38	2.89	-	27.40	2.20	-

BT-LE(2Mbps)

22/05/2021

2402MHz_TX

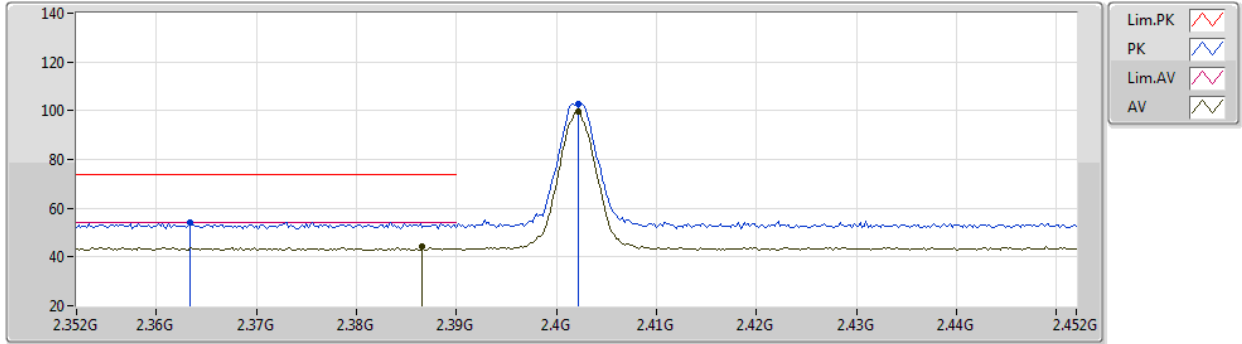

EUT Y_1TX
Setting OE
01-C-G-2

Type	Freq (Hz)	Level (dBuV/m)	Limit (dBuV/m)	Margin (dB)	Raw (dBuV)	Dist (m)	Condition	Azimuth (°)	Height (m)	Comment	AF (dB)	CL (dB)	PA (dB)
PK	2.3634G	54.30	74.00	-19.70	24.81	3	Horizontal	327	2.25	-	27.33	2.16	-
AV	2.3866G	44.08	54.00	-9.92	14.52	3	Horizontal	327	2.25	-	27.37	2.19	-
PK	2.4022G	102.61	Inf	-Inf	73.01	3	Horizontal	327	2.25	-	27.40	2.20	-
AV	2.4022G	99.59	Inf	-Inf	69.99	3	Horizontal	327	2.25	-	27.40	2.20	-

BT-LE(2Mbps)

22/05/2021

2402MHz_TX

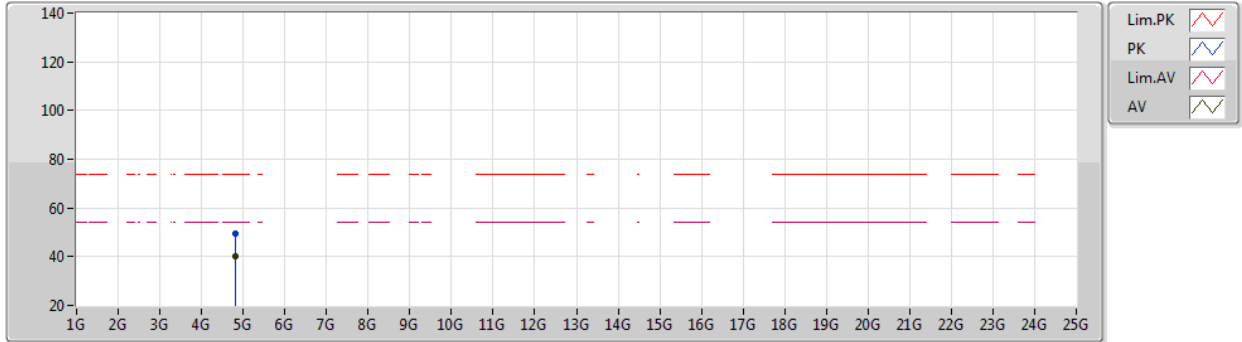

EUT_V_1TX
Setting 0E
01-C-G-2

Type	Freq (Hz)	Level (dBuV/m)	Limit (dBuV/m)	Margin (dB)	Raw (dBuV)	Dist (m)	Condition	Azimuth (°)	Height (m)	Comment	AF (dB)	CL (dB)	PA (dB)
PK	4.8042G	49.35	74.00	-24.65	45.21	3	Vertical	255	2.91	-	32.13	5.00	32.99
AV	4.80434G	40.30	54.00	-13.70	36.16	3	Vertical	255	2.91	-	32.13	5.00	32.99

BT-LE(2Mbps)

22/05/2021

2402MHz_TX

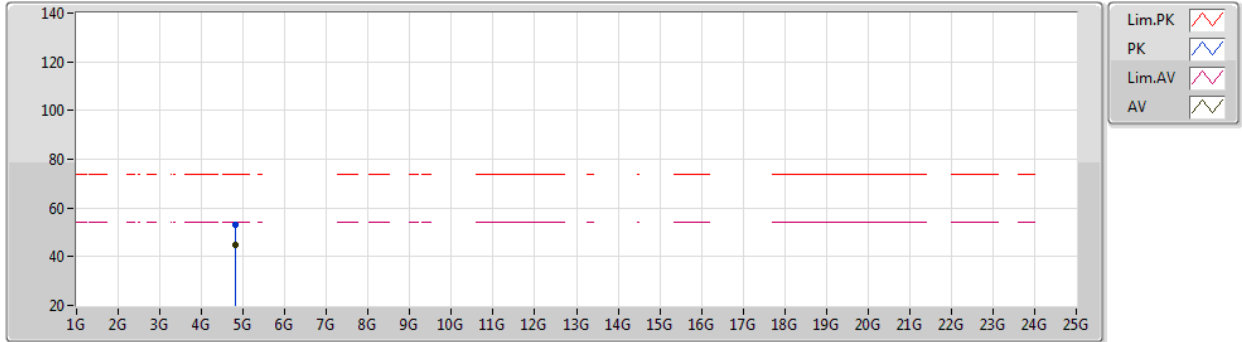

EUT_V_1TX
Setting 0E
01-C-G-2

Type	Freq (Hz)	Level (dBuV/m)	Limit (dBuV/m)	Margin (dB)	Raw (dBuV)	Dist (m)	Condition	Azimuth (°)	Height (m)	Comment	AF (dB)	CL (dB)	PA (dB)
PK	4.80317G	52.94	74.00	-21.06	48.81	3	Horizontal	353	1.45	-	32.12	5.00	32.99
AV	4.80307G	44.95	54.00	-9.05	40.82	3	Horizontal	353	1.45	-	32.12	5.00	32.99

BT-LE(2Mbps)

22/05/2021

2440MHz_TX

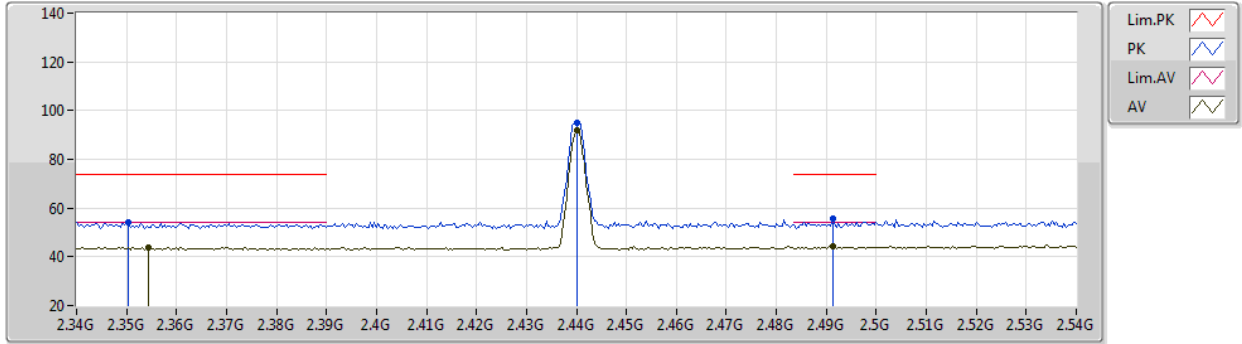

EUT Y_1TX
Setting OE
01-C-G-2

Type	Freq (Hz)	Level (dBuV/m)	Limit (dBuV/m)	Margin (dB)	Raw (dBuV)	Dist (m)	Condition	Azimuth (°)	Height (m)	Comment	AF (dB)	CL (dB)	PA (dB)
PK	2.3504G	54.37	74.00	-19.63	24.92	3	Vertical	35	3.00	-	27.30	2.15	-
AV	2.3544G	43.92	54.00	-10.08	14.46	3	Vertical	35	3.00	-	27.31	2.15	-
PK	2.44G	94.82	Inf	-Inf	65.10	3	Vertical	35	3.00	-	27.48	2.24	-
AV	2.44G	91.78	Inf	-Inf	62.06	3	Vertical	35	3.00	-	27.48	2.24	-
PK	2.4912G	55.46	74.00	-18.54	25.42	3	Vertical	35	3.00	-	27.75	2.29	-
AV	2.4912G	44.10	54.00	-9.90	14.06	3	Vertical	35	3.00	-	27.75	2.29	-

BT-LE(2Mbps)

22/05/2021

2440MHz_TX

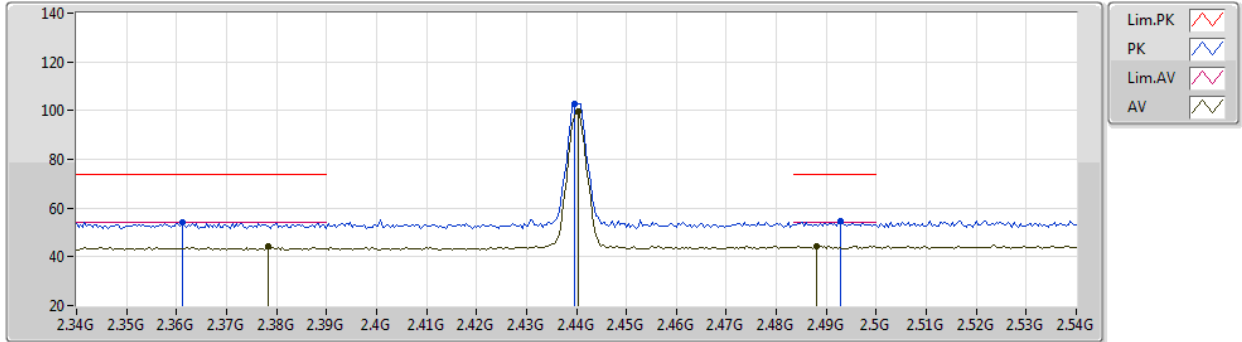

EUT Y_1TX
Setting OE
01-C-G-2

Type	Freq (Hz)	Level (dBuV/m)	Limit (dBuV/m)	Margin (dB)	Raw (dBuV)	Dist (m)	Condition	Azimuth (°)	Height (m)	Comment	AF (dB)	CL (dB)	PA (dB)
PK	2.3612G	54.02	74.00	-19.98	24.54	3	Horizontal	323	2.22	-	27.32	2.16	-
AV	2.3784G	44.35	54.00	-9.65	14.81	3	Horizontal	323	2.22	-	27.36	2.18	-
PK	2.4396G	102.69	Inf	-Inf	72.97	3	Horizontal	323	2.22	-	27.48	2.24	-
AV	2.4404G	99.69	Inf	-Inf	69.97	3	Horizontal	323	2.22	-	27.48	2.24	-
PK	2.4928G	54.48	74.00	-19.52	24.43	3	Horizontal	323	2.22	-	27.76	2.29	-
AV	2.488G	44.36	54.00	-9.64	14.34	3	Horizontal	323	2.22	-	27.73	2.29	-

BT-LE(2Mbps)

22/05/2021

2440MHz_TX

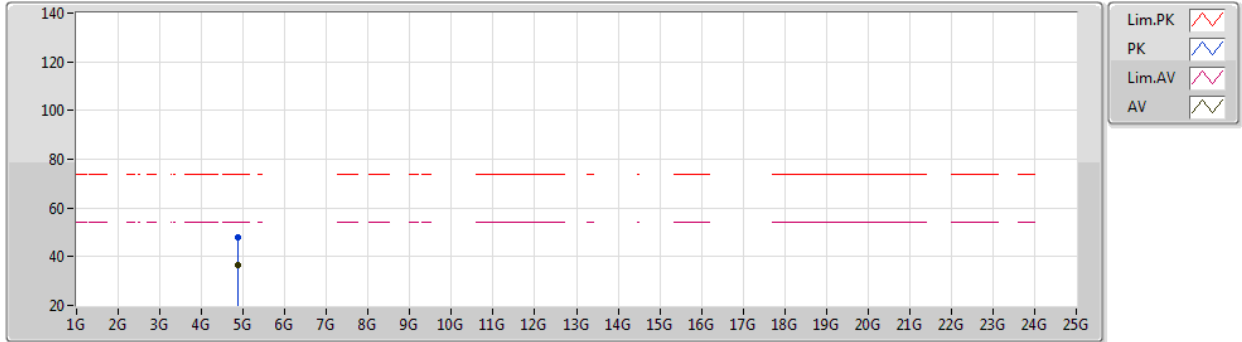

EUT_V_1TX
Setting 0E
01-C-G-2

Type	Freq (Hz)	Level (dBuV/m)	Limit (dBuV/m)	Margin (dB)	Raw (dBuV)	Dist (m)	Condition	Azimuth (°)	Height (m)	Comment	AF (dB)	CL (dB)	PA (dB)
PK	4.87842G	47.73	74.00	-26.27	43.21	3	Vertical	351	2.22	-	32.46	5.04	32.98
AV	4.87969G	36.41	54.00	-17.59	31.89	3	Vertical	351	2.22	-	32.46	5.04	32.98

BT-LE(2Mbps)

22/05/2021

2440MHz_TX

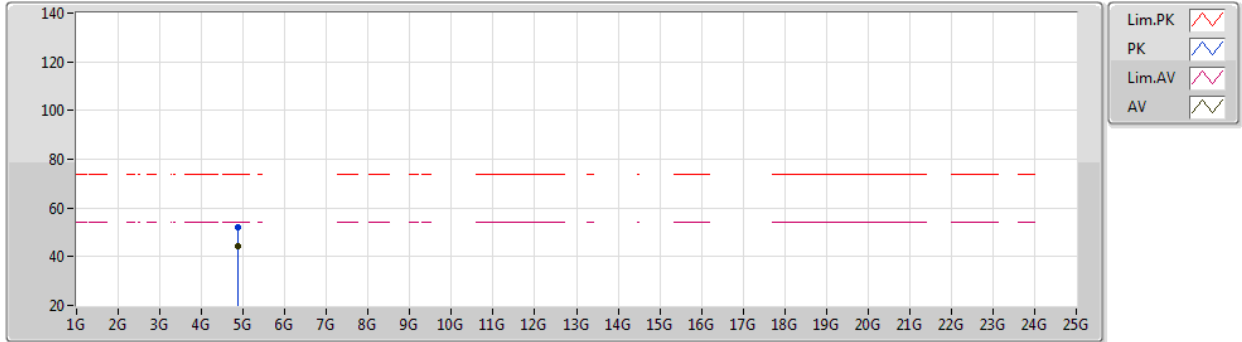

EUT_V_1TX
Setting 0E
01-C-G-2

Type	Freq (Hz)	Level (dBuV/m)	Limit (dBuV/m)	Margin (dB)	Raw (dBuV)	Dist (m)	Condition	Azimuth (°)	Height (m)	Comment	AF (dB)	CL (dB)	PA (dB)
PK	4.88011G	52.27	74.00	-21.73	47.75	3	Horizontal	347	1.51	-	32.46	5.04	32.98
AV	4.8791G	44.29	54.00	-9.71	39.77	3	Horizontal	347	1.51	-	32.46	5.04	32.98

BT-LE(2Mbps)

22/05/2021

2480MHz_TX

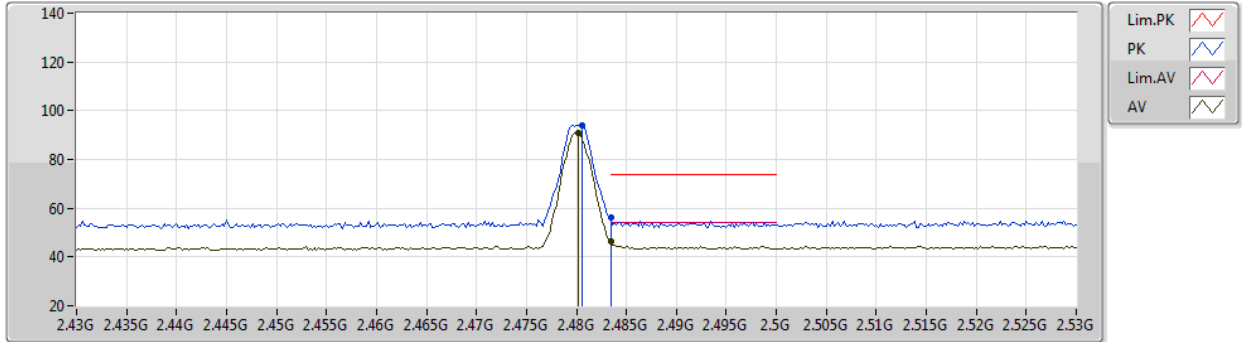

EUT Y_1TX
Setting OE
01-C-G-2

Type	Freq (Hz)	Level (dBuV/m)	Limit (dBuV/m)	Margin (dB)	Raw (dBuV)	Dist (m)	Condition	Azimuth (°)	Height (m)	Comment	AF (dB)	CL (dB)	PA (dB)
PK	2.4806G	93.95	Inf	-Inf	63.99	3	Vertical	18	1.57	-	27.68	2.28	-
AV	2.4802G	91.11	Inf	-Inf	61.15	3	Vertical	18	1.57	-	27.68	2.28	-
PK	2.4835G	56.36	74.00	-17.64	26.38	3	Vertical	18	1.57	-	27.70	2.28	-
AV	2.4835G	46.54	54.00	-7.46	16.56	3	Vertical	18	1.57	-	27.70	2.28	-

BT-LE(2Mbps)

22/05/2021

2480MHz_TX

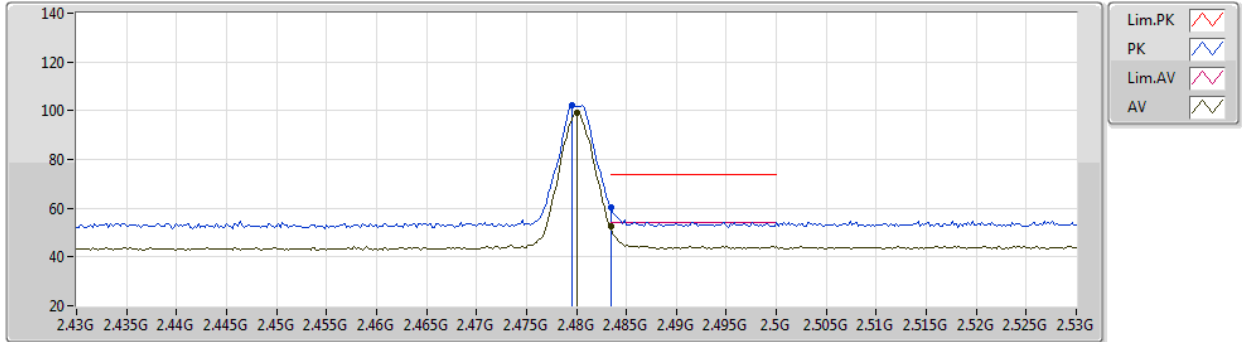

EUT Y_1TX
Setting OE
01-C-G-2

Type	Freq (Hz)	Level (dBuV/m)	Limit (dBuV/m)	Margin (dB)	Raw (dBuV)	Dist (m)	Condition	Azimuth (°)	Height (m)	Comment	AF (dB)	CL (dB)	PA (dB)
PK	2.4796G	102.02	Inf	-Inf	72.06	3	Horizontal	323	1.53	-	27.68	2.28	-
AV	2.48G	99.14	Inf	-Inf	69.18	3	Horizontal	323	1.53	-	27.68	2.28	-
PK	2.4835G	60.24	74.00	-13.76	30.26	3	Horizontal	323	1.53	-	27.70	2.28	-
AV	2.4835G	52.51	54.00	-1.49	22.53	3	Horizontal	323	1.53	-	27.70	2.28	-

BT-LE(2Mbps)

22/05/2021

2480MHz_TX

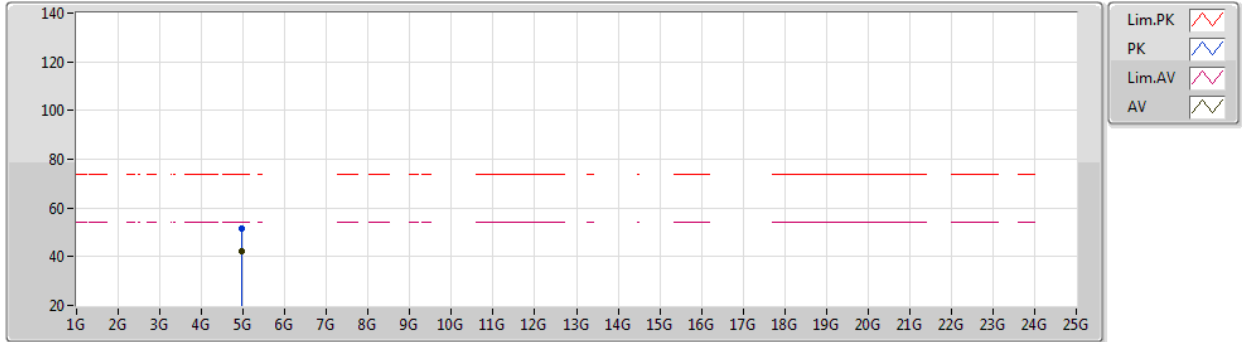

EUT_V_1TX
Setting 0E
01-C-G-2

Type	Freq (Hz)	Level (dBuV/m)	Limit (dBuV/m)	Margin (dB)	Raw (dBuV)	Dist (m)	Condition	Azimuth (°)	Height (m)	Comment	AF (dB)	CL (dB)	PA (dB)
PK	4.95929G	51.54	74.00	-22.46	46.65	3	Vertical	322	3.00	-	32.78	5.08	32.97
AV	4.96016G	42.43	54.00	-11.57	37.54	3	Vertical	322	3.00	-	32.78	5.08	32.97

BT-LE(2Mbps)

22/05/2021

2480MHz_TX

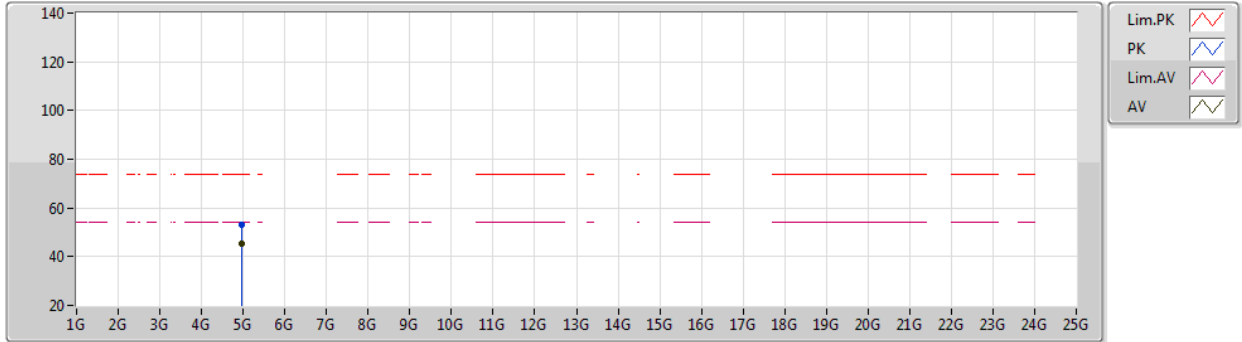

EUT_V_1TX
Setting 0E
01-C-G-2

Type	Freq (Hz)	Level (dBuV/m)	Limit (dBuV/m)	Margin (dB)	Raw (dBuV)	Dist (m)	Condition	Azimuth (°)	Height (m)	Comment	AF (dB)	CL (dB)	PA (dB)
PK	4.96104G	53.04	74.00	-20.96	48.15	3	Horizontal	350	1.29	-	32.78	5.08	32.97
AV	4.96018G	45.41	54.00	-8.59	40.52	3	Horizontal	350	1.29	-	32.78	5.08	32.97