



FCC TEST REPORT (15.247)

REPORT NO.: RF940804H03
MODEL NO.: RBT-4102
RECEIVED: Aug. 03, 2005
TESTED: Aug. 25 to Sep.30, 2005
ISSUED: Oct. 07, 2005

APPLICANT: Enterasys Networks, Inc.
ADDRESS: 50 Minuteman Road Andover, MA 01810

ISSUED BY: Advance Data Technology Corporation

TEST LOCATION: No. 81-1, Lu Liao Keng, 9 Ling, Wu Lung
Tsuen, Chiung Lin Hsiang, Hsin Chu Hsien,
Taiwan, R.O.C.

This test report consists of 124 pages in total. It may be duplicated completely for legal use with the approval of the applicant. It should not be reproduced except in full, without the written approval of our laboratory. The client should not use it to claim product endorsement by CNLA, A2LA or any government agencies. The test results in the report only apply to the tested sample. The test results in this report are traceable to the national or international standards.



0536

ILAC MRA



No. 2177-01



Table of Contents

1.	CERTIFICATION.....	5
2.	SUMMARY OF TEST RESULTS.....	6
3.	GENERAL INFORMATION	8
3.1	GENERAL DESCRIPTION OF EUT.....	8
3.2	DESCRIPTION OF TEST MODES.....	12
3.2.1	TEST MODE APPLICABILITY AND TESTED CHANNEL DETAIL:.....	13
3.3	GENERAL DESCRIPTION OF APPLIED STANDARDS	15
3.4	DESCRIPTION OF SUPPORT UNITS.....	16
3.5	CONFIGURATION OF SYSTEM UNDER TEST	17
4.	TEST TYPES AND RESULTS (802.11b & g, 2400 ~ 2483.5MHz Band)	19
4.1	CONDUCTED EMISSION MEASUREMENT	19
4.1.1	LIMITS OF CONDUCTED EMISSION MEASUREMENT	19
4.1.2	TEST INSTRUMENTS.....	19
4.1.3	TEST PROCEDURES	20
4.1.4	DEVIATION FROM TEST STANDARD	20
4.1.5	TEST SETUP.....	21
4.1.6	EUT OPERATING CONDITIONS.....	21
4.1.7	TEST RESULTS	22
4.2	RADIATED EMISSION MEASUREMENT	26
4.2.1	LIMITS OF RADIATED EMISSION MEASUREMENT	26
4.2.2	TEST INSTRUMENTS.....	27
4.2.3	TEST PROCEDURES	28
4.2.4	DEVIATION FROM TEST STANDARD	28
4.2.5	TEST SETUP.....	29
4.2.6	EUT OPERATING CONDITIONS.....	29
4.2.7	TEST RESULTS	30
4.3	6dB BANDWIDTH MEASUREMENT	38
4.3.1	LIMITS OF 6dB BANDWIDTH MEASUREMENT	38
4.3.2	TEST INSTRUMENTS.....	38
4.3.3	TEST PROCEDURE.....	39
4.3.4	DEVIATION FROM TEST STANDARD	39
4.3.5	TEST SETUP.....	39
4.3.6	EUT OPERATING CONDITIONS.....	39
4.3.7	TEST RESULTS	40
4.4	MAXIMUM PEAK OUTPUT POWER.....	46
4.4.1	LIMITS OF MAXIMUM PEAK OUTPUT POWER MEASUREMENT	46
4.4.2	INSTRUMENTS.....	46
4.4.3	TEST PROCEDURES	47
4.4.4	DEVIATION FROM TEST STANDARD	47



4.4.5	TEST SETUP.....	47
4.4.6	EUT OPERATING CONDITIONS.....	47
4.4.7	TEST RESULTS	48
4.5	POWER SPECTRAL DENSITY MEASUREMENT	50
4.5.1	LIMITS OF POWER SPECTRAL DENSITY MEASUREMENT.....	50
4.5.2	TEST INSTRUMENTS.....	50
4.5.3	TEST PROCEDURE.....	51
4.5.4	DEVIATION FROM TEST STANDARD	51
4.5.5	TEST SETUP.....	51
4.5.6	EUT OPERATING CONDITION.....	51
4.5.7	TEST RESULTS	52
4.6	BAND EDGES MEASUREMENT.....	58
4.6.1	LIMITS OF BAND EDGES MEASUREMENT.....	58
4.6.2	TEST INSTRUMENTS.....	58
4.6.3	TEST PROCEDURE.....	58
4.6.4	EUT OPERATING CONDITION.....	58
4.6.5	TEST RESULTS – DSSS.....	59
4.6.6	TEST RESULTS – OFDM.....	63
4.7	ANTENNA REQUIREMENT.....	67
4.7.1	STANDARD APPLICABLE.....	67
4.7.2	ANTENNA CONNECTED CONSTRUCTION.....	67
5.	TEST TYPES AND RESULTS (802.11a, 5725~5850MHz Band).....	68
5.1	CONDUCTED EMISSION MEASUREMENT.....	68
5.1.1	LIMITS OF CONDUCTED EMISSION MEASUREMENT.....	68
5.1.2	TEST INSTRUMENTS.....	68
5.1.3	TEST PROCEDURES	69
5.1.4	DEVIATION FROM TEST STANDARD	69
5.1.5	TEST SETUP.....	70
5.1.6	EUT OPERATING CONDITIONS.....	70
5.1.7	TEST RESULTS	71
5.2	Radiated Emission Measurement	75
5.2.1	LIMITS OF RADIATED EMISSION MEASUREMENT.....	75
5.2.2	TEST INSTRUMENTS.....	76
5.2.3	TEST PROCEDURES	77
5.2.4	DEVIATION FROM TEST STANDARD	77
5.2.5	TEST SETUP.....	78
5.2.6	EUT OPERATING CONDITIONS.....	78
5.2.7	TEST RESULTS (ANTENNA 1)	79
5.2.8	TEST RESULTS (ANTENNA 2)	84
5.2.9	TEST RESULTS (ANTENNA 3)	89
5.3	6dB BANDWIDTH MEASUREMENT	94
5.3.1	LIMITS OF 6dB BANDWIDTH MEASUREMENT	94



5.3.2	TEST INSTRUMENTS	94
5.3.3	TEST PROCEDURE	95
5.3.4	DEVIATION FROM TEST STANDARD	95
5.3.5	TEST SETUP	95
5.3.6	EUT OPERATING CONDITIONS	95
5.3.7	TEST RESULTS	96
5.4	MAXIMUM PEAK OUTPUT POWER	99
5.4.1	LIMITS OF MAXIMUM PEAK OUTPUT POWER MEASUREMENT	99
5.4.2	INSTRUMENTS	99
5.4.3	TEST PROCEDURES	100
5.4.4	DEVIATION FROM TEST STANDARD	100
5.4.5	TEST SETUP	100
5.4.6	EUT OPERATING CONDITIONS	100
5.4.7	TEST RESULTS	101
5.5	POWER SPECTRAL DENSITY MEASUREMENT	102
5.5.1	LIMITS OF POWER SPECTRAL DENSITY MEASUREMENT	102
5.5.2	TEST INSTRUMENTS	102
5.5.3	TEST PROCEDURE	103
5.5.4	DEVIATION FROM TEST STANDARD	103
5.5.5	TEST SETUP	103
5.5.6	EUT OPERATING CONDITION	103
5.5.7	TEST RESULTS	104
5.6	BAND EDGES MEASUREMENT	107
5.6.1	LIMITS OF BAND EDGES MEASUREMENT	107
5.6.2	TEST INSTRUMENTS	107
5.6.3	TEST PROCEDURE	108
5.6.4	DEVIATION FROM TEST STANDARD	108
5.6.5	EUT OPERATING CONDITION	108
5.6.6	TEST RESULTS	109
5.7	ANTENNA REQUIREMENT	112
5.7.1	STANDARD APPLICABLE	112
5.7.2	ANTENNA CONNECTED CONSTRUCTION	112
6.	PHOTOGRAPHS OF THE TEST CONFIGURATION	113
7.	INFORMATION ON THE TESTING LABORATORIES	123
	APPENDIX-A	A-1



1. CERTIFICATION

PRODUCT: Multi-Channel Access Point
BRAND NAME: Enterasys
MODEL NO.: RBT-4102
TEST SAMPLE: ENGINEERING SAMPLE
TESTED: Aug. 25 to Sep.30, 2005
APPLICANT: Enterasys Networks, Inc.
STANDARDS: FCC Part 15, Subpart C (Section 15.247),
ANSI C63.4-2003

The above equipment (Model: RBT-4102) has been tested by **Advance Data Technology Corporation**, and found compliance with the requirement of the above standards. The test record, data evaluation & Equipment Under Test (EUT) configurations represented herein are true and accurate accounts of the measurements of the sample's EMC characteristics under the conditions specified in this report.

PREPARED BY : Midoli Peng , **DATE:** Oct. 07, 2005
(Midoli Peng)

TECHNICAL ACCEPTANCE : Hank Chung , **DATE:** Oct. 07, 2005
Responsible for RF (Hank Chung)

APPROVED BY : May Chen , **DATE:** Oct. 07, 2005
(May Chen, Deputy Manager)

2. SUMMARY OF TEST RESULTS

The EUT has been tested according to the following specifications:

For 802.11b & g, 2412~2462MHz Band

APPLIED STANDARD: FCC Part 15, Subpart C (Section 15.247)			
Standard Section	Test Type and Limit	Result	Remark
15.207	AC Power Conducted Emission	PASS	Meet the requirement of limit. Minimum passing margin is -4.47dB at 0.271MHz
15.247(a)(2)	Spectrum Bandwidth of a Direct Sequence Spread Spectrum System Limit: min. 500kHz	PASS	Meet the requirement of limit.
15.247(b)	Maximum Peak Output Power Limit: max. 30dBm	PASS	Meet the requirement of limit.
15.247(d)	Radiated Emissions Limit: Table 15.209	PASS	Meet the requirement of limit. Minimum passing margin is -0.7dB at 2387.0MHz
15.247(e)	Power Spectral Density Limit: max. 8dBm	PASS	Meet the requirement of limit.
15.247(d)	Band Edge Measurement Limit: 20dB less than the peak value of fundamental frequency	PASS	Meet the requirement of limit.

For 802.11a, 5725~5850MHz Band

APPLIED STANDARD: FCC Part 15, Subpart C (Section 15.247)			
Standard Section	Test Type and Limit	Result	Remark
15.207	AC Power Conducted Emission	PASS	Meet the requirement of limit. Minimum passing margin is -4.83dB at 0.272MHz
15.247(a)(2)	Spectrum Bandwidth of a Direct Sequence Spread Spectrum System Limit: min. 500kHz	PASS	Meet the requirement of limit.
15.247(b)	Maximum Peak Output Power Limit: max. 30dBm	PASS	Meet the requirement of limit.
15.247(d)	Radiated Emissions Limit: Table 15.209	PASS	Meet the requirement of limit. Minimum passing margin is -1.0dB at 1650MHz
15.247(e)	Power Spectral Density Limit: max. 8dBm	PASS	Meet the requirement of limit.
15.247(d)	Band Edge Measurement Limit: 20dB less than the peak value of fundamental frequency	PASS	Meet the requirement of limit.

NOTE:

1. The EUT was operating in 2.412 ~ 2.462GHz, 5.150 ~ 5.350GHz and 5.725 ~ 5.850GHz frequencies band. This report was recorded the RF parameters including 2.412 ~ 2.462GHz and 5.725 ~ 5.850GHz. For the 5.150 ~ 5.350GHz RF parameters was recorded in another test report.



3. GENERAL INFORMATION

3.1 GENERAL DESCRIPTION OF EUT

EUT	Multi-Channel Access Point
MODEL NO.	RBT-4102
POWER SUPPLY	DC 48V from power adapter or POE (Power over Ethernet)
MODULATION TYPE	CCK, DQPSK, DBPSK for DSSS 64QAM, 16QAM, QPSK, BPSK for OFDM
MODULATION TECHNOLOGY	DSSS, OFDM
TRANSFER RATE	802.11b: 11/5.5/2/1Mbps 802.11g: 54/48/36/24/18/12/9/6Mbps 802.11a: 54/48/36/24/18/12/9/6Mbps
FREQUENCY RANGE	802.11b & 802.11g: 2412 ~ 2462MHz 802.11a: 5.15 ~ 5.35GHz and 5.725 ~ 5.850GHz
NUMBER OF CHANNEL	802.11b & 802.11g: 11 802.11a: 13
CHANNEL SPACING	802.11b & 802.11g: 5MHz 802.11a: 20MHz for Normal mode
OUTPUT POWER	Please see note 4 (on next three page)
DATA CABLE	NA
ANTENNA TYPE	Please see note 3 (on next two page)
I/O PORTS	Console Port x1, LAN Port x1
ASSOCIATED DEVICES	NA

NOTE:

1. The EUT operates in both the 5GHz and 2.4GHz Bands and compatibility with 802.11a and 802.11b, 802.11g technology.



2. The EUT was operated with the following power adapter or POE:

ADAPTER	
BRAND:	PHIHONG
MODEL:	PSA 18U-480C
INPUT:	AC 100~240V, 0.5A, 50~60Hz
OUTPUT:	DC 48V, 0.38A , 1.5m/ nonshield/ with one core

POE (for test only)	
BRAND:	3Com
MODEL:	PW130
INPUT:	AC100-250V, 0.5A, 50/60Hz
OUTPUT:	DC 48V, 0.42A

3. The EUT must be supplied with a antenna as following table could be chosen:

For 802.11b/g(2400 ~ 2483.5MHz)

Item	SPEC No.	Model No.	Product Description	Antenna Gain	Remark	Connector
1	NA	RBT4K-AG-IA	2.4-4.9/5.8 GHz, 8ft of cable RPSMA Indoor Antenna.	2dBi	Omni	RPSMA

For 802.11a (5725 ~ 5850MHz band)

Item	SPEC No.	Model No.	Product Description	Antenna Gain	Remark	Connector
1	NA	RBT4K-AG-IA	2.4-4.9/5.8 GHz, 8ft of cable RPSMA Indoor Antenna.	4dBi	Omni	RPSMA
2	8910605	RBTES-AH-P23M	5.8GHz GHz Directional Antenna Assy Outdoor Antenna..	23 dBi	Point to point Directional	Reverse N
3	8910606	RBTES-AH-M10M	5.8GHz GHz Omni Antenna Assy Outdoor Antenna.	10 dBi	Omni	Reverse N

For 802.11a (5150 ~ 5350MHz band)

Item	SPEC No.	Model No.	Product Description	Antenna Gain	Remark	Connector
1	NA	RBT4K-AG-IA	2.4-4.9/5.8 GHz, 8ft of cable RPSMA Indoor Antenna.	4dBi	Omni	RPSMA

Note: The above antennas which with Reverse N connector will tested with a Pig Tail Cable (Model No.: RBT4K-AG-PT20F, SMA female RP - N female RP)



4. Peak output power (Unit : dBm) :

For 802.11b/g(2400 ~ 2483.5MHz)

Item	SPEC No.	Model No.	Maximum Peak output power (Unit : dBm)
1	NA	RBT4K-AG-IA	25

For 802.11a (5725 ~ 5850MHz band)

Item	SPEC No.	Model No.	Maximum Peak output power (Unit : dBm)
1	NA	RBT4K-AG-IA	23.63
2	8910605	RBTES-AH-P23M	23.63
3	8910606	RBTES-AH-M10M	23.63

For 802.11a (5150 ~ 5350MHz band)

Item	SPEC No.	Model No.	Maximum Peak output power (Unit : dBm)	
			Operating Frequency (5150~5250MHz)	Operating Frequency (5250~5350MHz)
1	NA	RBT4K-AG-IA	16.62	23.07

5. The above EUT information was declared by the manufacturer and for more detailed features description, please refer to the manufacturer's specifications or User's Manual.



3.2 DESCRIPTION OF TEST MODES

Operated in 2400 ~ 2483.5MHz band:

For 802.11b/g: Eleven channels are provided to this EUT.

Channel	Frequency	Channel	Frequency
1	2412 MHz	7	2442 MHz
2	2417 MHz	8	2447 MHz
3	2422 MHz	9	2452 MHz
4	2427 MHz	10	2457 MHz
5	2432 MHz	11	2462 MHz
6	2437 MHz		

Operated in 5725 ~ 5850MHz band:

For 802.11a (5725 ~ 5850MHz band): Five channels are provided to this EUT.

Channel	Frequency
1	5745 MHz
2	5765 MHz
3	5785 MHz
4	5805 MHz
5	5825 MHz



3.2.1 TEST MODE APPLICABILITY AND TESTED CHANNEL DETAIL:

EUT configure mode	Applicable to				Description
	PLC	RE<1G	RE≥1G	APCM	
-	X	X	X	X	NA

Where PLC: Power Line Conducted Emission RE<1G RE: Radiated Emission below 1GHz
 RE≥1G: Radiated Emission above 1GHz APCM: Antenna Port Conducted Measurement

Power Line Conducted Emission Test:

- Pre-Scan has been conducted to determine the worst-case mode from all possible combinations between available modulations, data rates and antenna ports (if EUT with antenna diversity architecture).
- Following channel(s) was (were) selected for the final test as listed below.

Mode	Available Channel	Tested Channel	Modulation Technology	Modulation Type	Data Rate (Mbps)
802.11g	1 to 11	11	OFDM	BPSK	6
802.11a	1 to 5	5	OFDM	BPSK	6

Radiated Emission Test (Below 1 GHz):

- Pre-Scan has been conducted to determine the worst-case mode from all possible combinations between available modulations, data rates and antenna ports (if EUT with antenna diversity architecture).
- Following channel(s) was (were) selected for the final test as listed below.

Mode	Available Channel	Tested Channel	Modulation Technology	Modulation Type	Data Rate (Mbps)
802.11g	1 to 11	11	OFDM	BPSK	6
802.11a	1 to 5	5	OFDM	BPSK	6

Radiated Emission Test (Above 1 GHz):

- Pre-Scan has been conducted to determine the worst-case mode from all possible combinations between available modulations, data rates and antenna ports (if EUT with antenna diversity architecture).
- Following channel(s) was (were) selected for the final test as listed below.

Mode	Available Channel	Tested Channel	Modulation Technology	Modulation Type	Data Rate (Mbps)
802.11b	1 to 11	1, 6, 11	DSSS	CCK	11
802.11g	1 to 11	1, 6, 11	OFDM	BPSK	6
802.11a	1 to 5	1, 3, 5	OFDM	BPSK	6



Bandedge Measurement:

- Pre-Scan has been conducted to determine the worst-case mode from all possible combinations between available modulations, data rates and antenna ports (if EUT with antenna diversity architecture).
- Following channel(s) was (were) selected for the final test as listed below.

Mode	Available Channel	Tested Channel	Modulation Technology	Modulation Type	Data Rate (Mbps)
802.11b	1 to 11	1, 11	DSSS	CCK	11
802.11g	1 to 11	1, 11	OFDM	BPSK	6
802.11a	1 to 5	1, 5	OFDM	BPSK	6

Antenna Port Conducted Measurement:

- Pre-Scan has been conducted to determine the worst-case mode from all possible combinations between available modulations, data rates and antenna ports (if EUT with antenna diversity architecture).
- Following channel(s) was (were) selected for the final test as listed below.

Mode	Available Channel	Tested Channel	Modulation Technology	Modulation Type	Data Rate (Mbps)
802.11b	1 to 11	1, 6, 11	DSSS	CCK	11
802.11g	1 to 11	1, 6, 11	OFDM	BPSK	6
802.11a	1 to 5	1, 3, 5	OFDM	BPSK	6



3.3 GENERAL DESCRIPTION OF APPLIED STANDARDS

The EUT is a Multi-Channel Access Point. According to the specifications of the manufacturer, it must comply with the requirements of the following standards:

FCC Part 15, Subpart C. (15.247)

ANSI C63.4-2003

All test items have been performed and recorded as per the above standards.

NOTE: The EUT is also considered as a kind of computer peripheral, because the connection to computer is necessary for typical use. It has been verified to comply with the requirements of FCC Part 15, Subpart B, Class B (DoC). The test report has been issued separately.



3.4 DESCRIPTION OF SUPPORT UNITS

The EUT has been tested as an independent unit together with other necessary accessories or support units. The following support units or accessories were used to form a representative test configuration during the tests.

NO.	PRODUCT	BRAND	MODEL NO.	SERIAL NO.	FCC ID
1	NOTEBOOK COMPUTER	Dell	PP01L	TW-09c748- 12800-165-3171	DoC

NO.	SIGNAL CABLE DESCRIPTION OF THE ABOVE SUPPORT UNITS
1	NA

NOTE: All power cords of the above support units are non shielded (1.8m).

3.5 CONFIGURATION OF SYSTEM UNDER TEST

With adapter test mode :

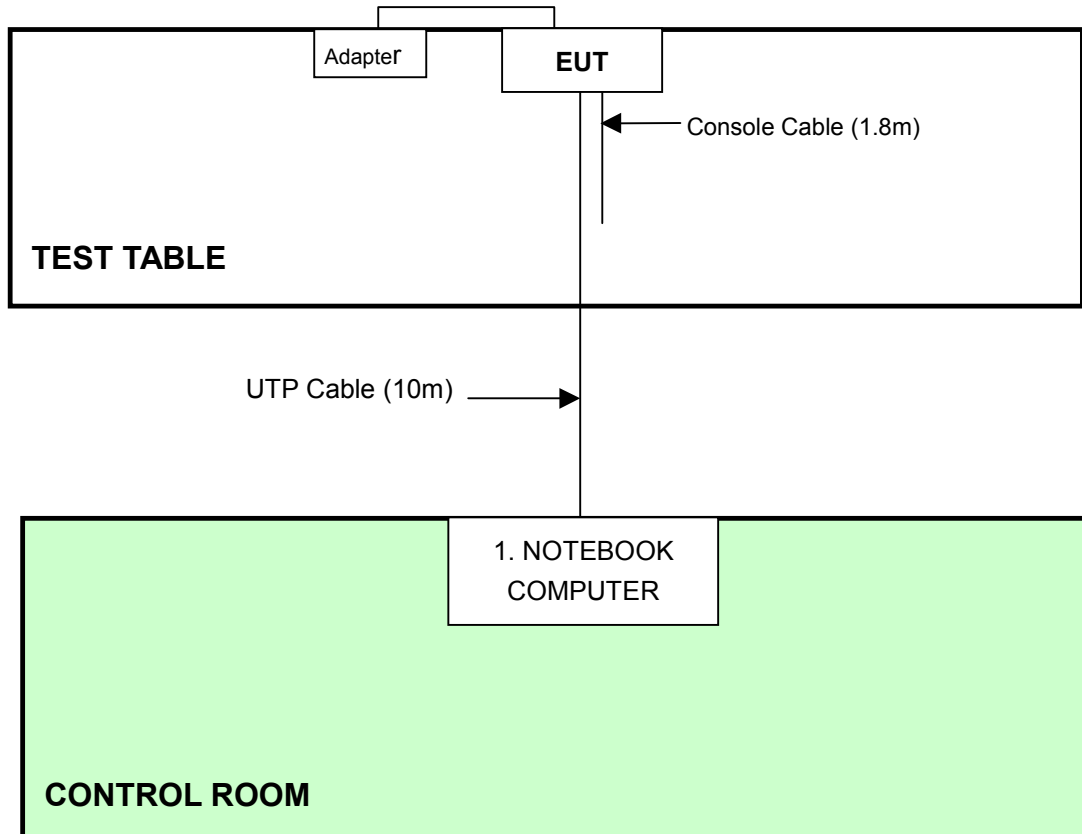

- NOTE:**
1. Support unit 1 was kept in the control room during the test.
 2. Please refer to the photos of test configuration in Item 6 also.

With POE test mode :

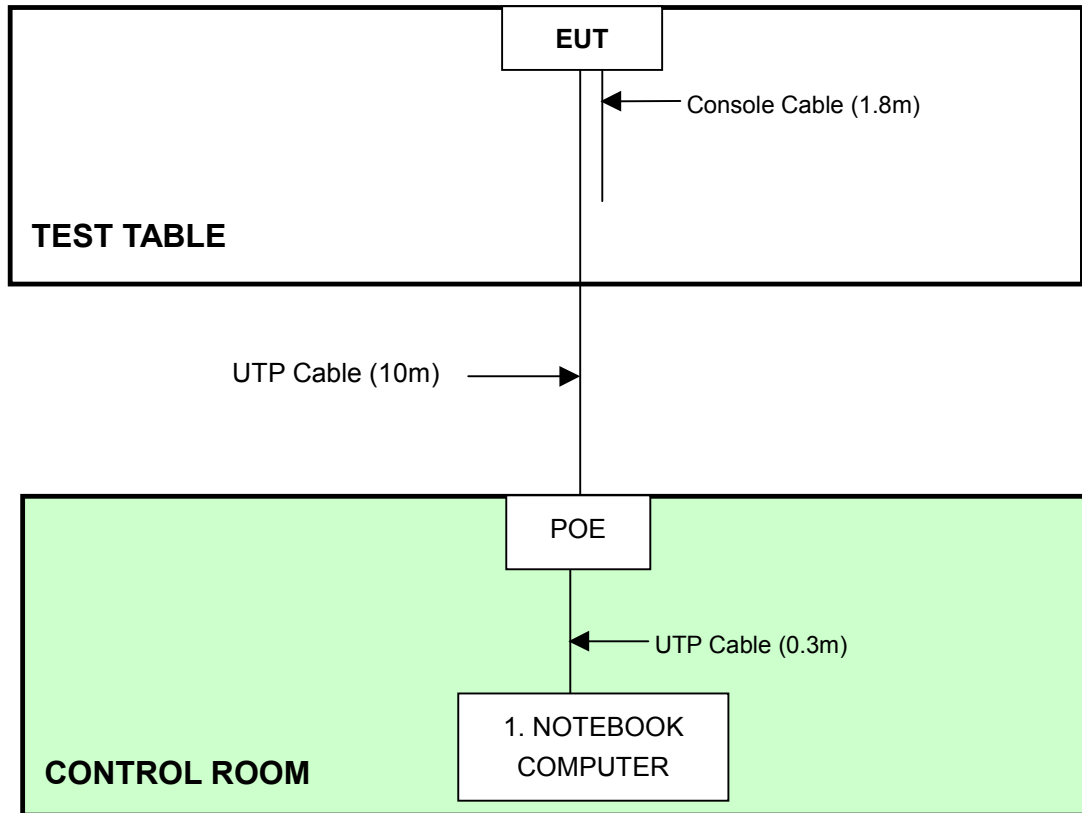

- NOTE:** 1. Support unit 1 was kept in the control room during the test.
2. Please refer to the photos of test configuration in Item 6 also.



4. TEST TYPES AND RESULTS (802.11b & g, 2400 ~ 2483.5MHZ BAND)

4.1 CONDUCTED EMISSION MEASUREMENT

4.1.1 LIMITS OF CONDUCTED EMISSION MEASUREMENT

FREQUENCY OF EMISSION (MHz)	CONDUCTED LIMIT (dB μ V)	
	Quasi-peak	Average
0.15-0.5	66 to 56	56 to 46
0.5-5	56	46
5-30	60	50

- NOTE:**
1. The lower limit shall apply at the transition frequencies.
 2. The limit decreases in line with the logarithm of the frequency in the range of 0.15 to 0.50 MHz.
 3. All emanations from a class A/B digital device or system, including any network of conductors and apparatus connected thereto, shall not exceed the level of field strengths specified above.

4.1.2 TEST INSTRUMENTS

DESCRIPTION & MANUFACTURER	MODEL NO.	SERIAL NO.	CALIBRATED UNTIL
ROHDE & SCHWARZ Test Receiver	ESCS 30	847124/029	Dec. 07, 2005
ROHDE & SCHWARZ LISN (for EUT)	ESHS-Z5	848773/004	Nov. 08, 2005
KYORITSU LISN (for peripheral)	KNW-407	8/1395/12	Jul. 19, 2006
RF Cable (JETBAO)	RG233/U	Cable_CA_01	Jul. 19, 2006
Terminator(for KYORITSU)	50	3	Oct. 12, 2005
Software	Cond-V2e	NA	NA

NOTE:

1. The calibration interval of the above test instruments is 12 months and the calibrations are traceable to NML/ROC and NIST/USA.
2. The test was performed in ADT Shielded Room No. A.
3. The VCCI Con A Registration No. is C-817.
4. The measurement uncertainty is 2.53 dB, which is calculated as per the document CISPR 16-4



4.1.3 TEST PROCEDURES

- a. The EUT was placed 0.4 meters from the conducting wall of the shielded room with EUT being connected to the power mains through a line impedance stabilization network (LISN). Other support units were connected to the power mains through another LISN. The two LISNs provide 50 ohm/ 50uH of coupling impedance for the measuring instrument.
- b. Both lines of the power mains connected to the EUT were checked for maximum conducted interference.
- c. The frequency range from 150kHz to 30MHz was searched. Emission levels under (Limit - 20dB) were not recorded.

4.1.4 DEVIATION FROM TEST STANDARD

No deviation

4.1.5 TEST SETUP

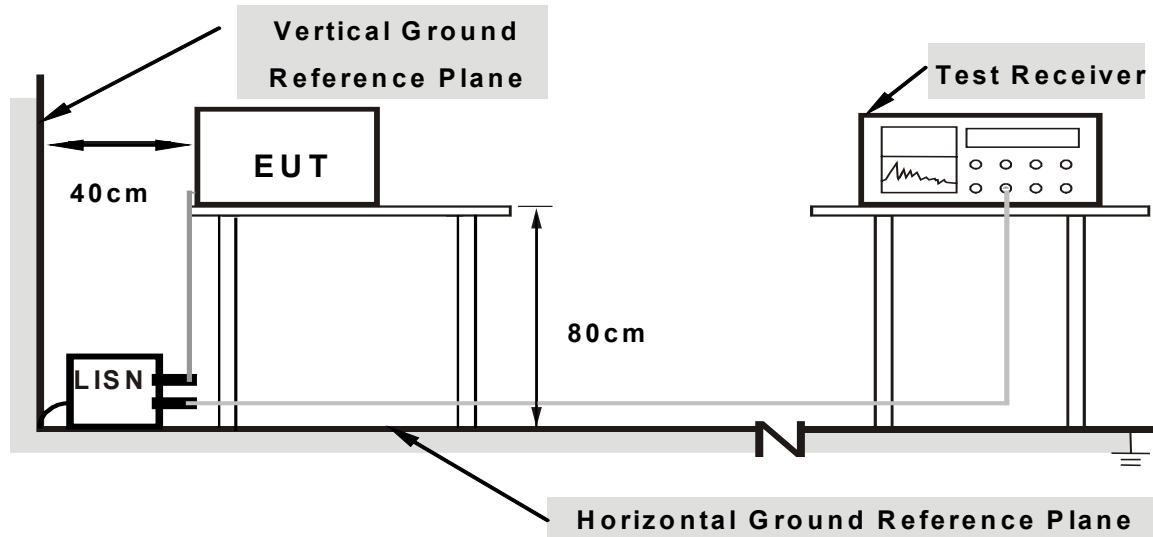

Note: 1. Support units were connected to second LISN.

2. Both of LISNs (AMN) are 80 cm from EUT and at least 80 from other units and other metal planes

For the actual test configuration, please refer to the related item – Photographs of the Test Configuration.

4.1.6 EUT OPERATING CONDITIONS

- a. Placed the EUT on the testing table.
- b. Prepared other computer systems to act as a communication partner and placed them outside of testing area.
- c. The communication partner run test program “ART 48B5” to enable EUT under transmission/receiving condition continuously at specific channel frequency via UTP cable and wireless.



4.1.7 TEST RESULTS

Conducted Worst-Case Data(Adapter Mode)

EUT	Multi-Channel Access Point	MODEL	RBT-4102
TEST MODE	With Adapter	6dB BANDWIDTH	9 kHz
MODULATION TYPE	BPSK	TRANSFER RATE	6Mbps
INPUT POWER (SYSTEM)	120Vac, 60 Hz	PHASE	Line (L)
ENVIRONMENTAL CONDITIONS	26deg. C, 63%RH, 961hPa	TESTED BY	Phoenix Huang

No	Freq. [MHz]	Corr. Factor (dB)	Reading Value		Emission Level		Limit		Margin	
			[dB (uV)]		[dB (uV)]		[dB (uV)]		(dB)	
			Q.P.	AV.	Q.P.	AV.	Q.P.	AV.	Q.P.	AV.
1	0.271	0.16	51.05	46.46	51.21	46.62	61.08	51.08	-9.88	-4.47
2	0.417	0.17	48.01	41.64	48.18	41.81	57.51	47.51	-9.33	-5.70
3	0.543	0.18	46.59	38.78	46.77	38.96	56.00	46.00	-9.23	-7.04
4	0.696	0.18	45.89	36.81	46.07	36.99	56.00	46.00	-9.93	-9.01
5	1.629	0.23	42.14	-	42.37	-	56.00	46.00	-13.63	-
6	4.426	0.47	41.63	-	42.10	-	56.00	46.00	-13.90	-
7	4.922	0.50	41.87	-	42.37	-	56.00	46.00	-13.63	-

- REMARKS:**
1. Q.P. and AV. are abbreviations of quasi-peak and average individually.
 2. "-": The Quasi-peak reading value also meets average limit and measurement with the average detector is unnecessary.
 3. The emission levels of other frequencies were very low against the limit.
 4. Margin value = Emission level - Limit value
 5. Correction factor = Insertion loss + Cable loss
 6. Emission Level = Correction Factor + Reading Value.

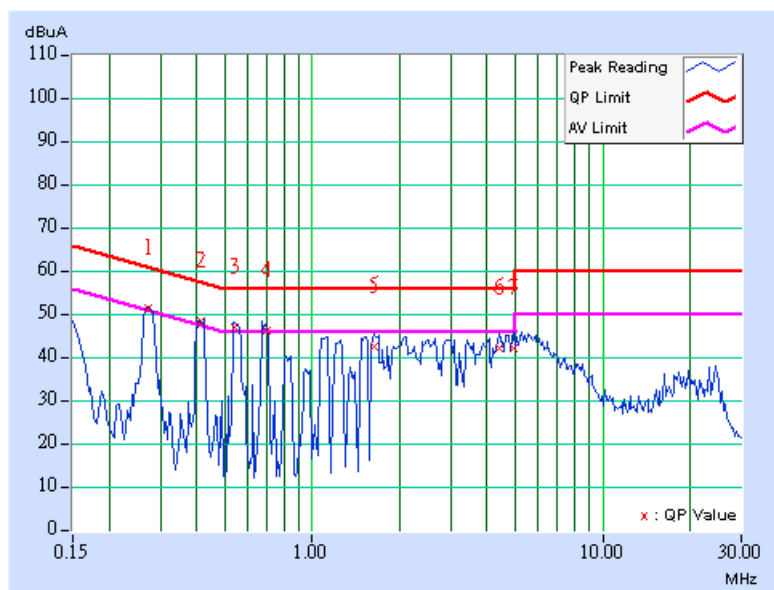



EUT	Multi-Channel Access Point	MODEL	RBT-4102
TEST MODE	With Adapter	6dB BANDWIDTH	9 kHz
MODULATION TYPE	BPSK	TRANSFER RATE	6Mbps
INPUT POWER (SYSTEM)	120Vac, 60 Hz	PHASE	Neutral (N)
ENVIRONMENTAL CONDITIONS	26deg. C, 63%RH, 961hPa	TESTED BY	Phoenix Huang

No	Freq. [MHz]	Corr. Factor (dB)	Reading Value		Emission Level		Limit		Margin	
			[dB (uV)]		[dB (uV)]		[dB (uV)]		(dB)	
			Q.P.	AV.	Q.P.	AV.	Q.P.	AV.	Q.P.	AV.
1	0.271	0.16	51.17	45.25	51.33	45.41	61.09	51.09	-9.76	-5.68
2	0.412	0.17	47.31	-	47.48	-	57.61	47.61	-10.13	-
3	0.541	0.18	46.83	38.61	47.01	38.79	56.00	46.00	-8.99	-7.21
4	0.680	0.18	45.41	-	45.59	-	56.00	46.00	-10.41	-
5	1.653	0.23	41.22	-	41.45	-	56.00	46.00	-14.55	-
6	3.660	0.42	41.12	-	41.54	-	56.00	46.00	-14.46	-
7	4.816	0.48	41.70	-	42.18	-	56.00	46.00	-13.82	-

- REMARKS:**
1. Q.P. and AV. are abbreviations of quasi-peak and average individually.
 2. "-": The Quasi-peak reading value also meets average limit and measurement with the average detector is unnecessary.
 3. The emission levels of other frequencies were very low against the limit.
 4. Margin value = Emission level - Limit value
 5. Correction factor = Insertion loss + Cable loss
 6. Emission Level = Correction Factor + Reading Value.

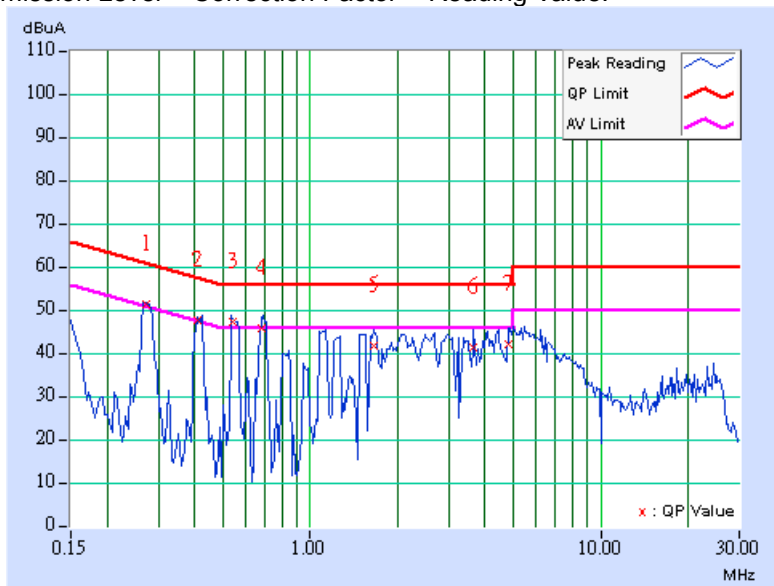



Conducted Worst-Case Data(Adapter Mode)

EUT	Multi-Channel Access Point	MODEL	RBT-4102
TEST MODE	With POE	6dB BANDWIDTH	9 kHz
MODULATION TYPE	BPSK	TRANSFER RATE	6Mbps
INPUT POWER (SYSTEM)	120Vac, 60 Hz	PHASE	Line (L)
ENVIRONMENTAL CONDITIONS	26deg. C, 63%RH, 96hPa	TESTED BY	Phoenix Huang

No	Freq. [MHz]	Corr. Factor (dB)	Reading Value [dB (uV)]		Emission Level [dB (uV)]		Limit [dB (uV)]		Margin (dB)	
			Q.P.	AV.	Q.P.	AV.	Q.P.	AV.	Q.P.	AV.
			1	0.397	0.17	38.52	-	38.69	-	57.91
2	0.464	0.17	36.12	-	36.29	-	56.62	46.62	-20.33	-
3	0.995	0.20	38.17	-	38.37	-	56.00	46.00	-17.63	-
4	1.197	0.21	39.25	-	39.46	-	56.00	46.00	-16.54	-
5	2.252	0.28	37.52	-	37.80	-	56.00	46.00	-18.20	-
6	17.694	1.17	45.86	-	47.03	-	60.00	50.00	-12.97	-

- REMARKS:**
1. Q.P. and AV. are abbreviations of quasi-peak and average individually.
 2. "-": The Quasi-peak reading value also meets average limit and measurement with the average detector is unnecessary.
 3. The emission levels of other frequencies were very low against the limit.
 4. Margin value = Emission level - Limit value
 5. Correction factor = Insertion loss + Cable loss
 6. Emission Level = Correction Factor + Reading Value.

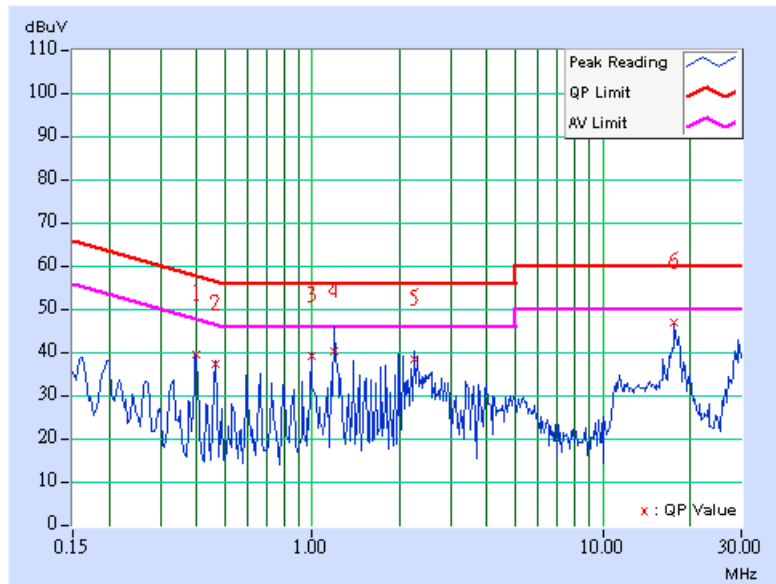



EUT	Multi-Channel Access Point	MODEL	RBT-4102
TEST MODE	With POE	6dB BANDWIDTH	9 kHz
MODULATION TYPE	BPSK	TRANSFER RATE	6Mbps
INPUT POWER (SYSTEM)	120Vac, 60 Hz	PHASE	Neutral (N)
ENVIRONMENTAL CONDITIONS	26deg. C, 63%RH, 96hPa	TESTED BY	Phoenix Huang

No	Freq. [MHz]	Corr. Factor (dB)	Reading Value [dB (uV)]		Emission Level [dB (uV)]		Limit [dB (uV)]		Margin (dB)	
			Q.P.	AV.	Q.P.	AV.	Q.P.	AV.	Q.P.	AV.
			1	0.398	0.17	39.93	-	40.10	-	57.90
2	0.464	0.17	35.36	-	35.53	-	56.62	46.62	-21.09	-
3	0.664	0.18	35.45	-	35.63	-	56.00	46.00	-20.37	-
4	1.194	0.21	41.00	-	41.21	-	56.00	46.00	-14.79	-
5	1.395	0.22	35.56	-	35.78	-	56.00	46.00	-20.22	-
6	1.987	0.25	37.22	-	37.47	-	56.00	46.00	-18.53	-
7	17.693	1.02	46.56	-	47.58	-	60.00	50.00	-12.42	-

- REMARKS:**
1. Q.P. and AV. are abbreviations of quasi-peak and average individually.
 2. "-": The Quasi-peak reading value also meets average limit and measurement with the average detector is unnecessary.
 3. The emission levels of other frequencies were very low against the limit.
 4. Margin value = Emission level - Limit value
 5. Correction factor = Insertion loss + Cable loss
 6. Emission Level = Correction Factor + Reading Value.

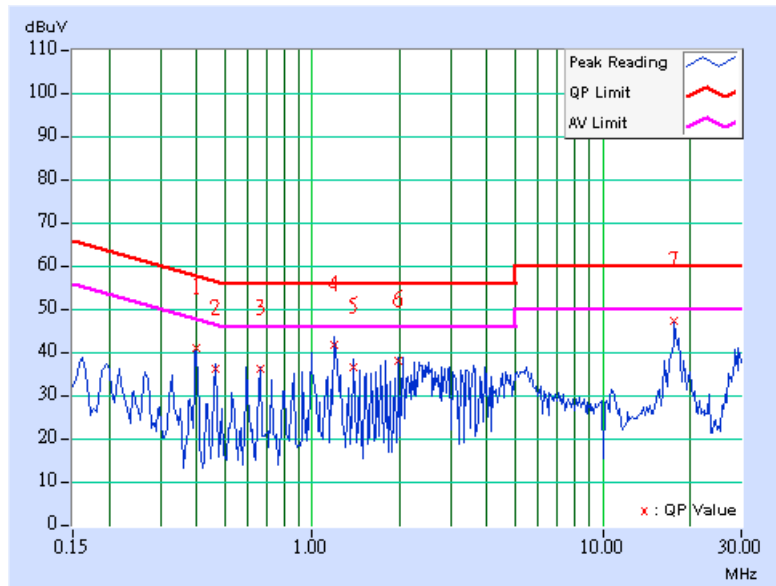



4.2 RADIATED EMISSION MEASUREMENT

4.2.1 LIMITS OF RADIATED EMISSION MEASUREMENT

Emissions radiated outside of the specified bands, shall be according to the general radiated limits in 15.209 as following:

Frequencies (MHz)	Field strength (microvolts/meter)	Measurement distance (meters)
0.009-0.490	2400/F(kHz)	300
0.490-1.705	24000/F(kHz)	30
1.705-30.0	30	30
30-88	100	3
88-216	150	3
216-960	200	3
Above 960	500	3

NOTE:

1. The lower limit shall apply at the transition frequencies.
2. Emission level (dBuV/m) = 20 log Emission level (uV/m).
3. As shown in 15.35(b), for frequencies above 1000MHz, the field strength limits are based on average detector, however, the peak field strength of any emission shall not exceed the maximum permitted average limits, specified above by more than 20dB under any condition of modulation.



4.2.2 TEST INSTRUMENTS

DESCRIPTION & MANUFACTURER	MODEL NO.	SERIAL NO.	CALIBRATED UNTIL
ADVANTEST Spectrum Analyzer	R3271A	85060311	July 07, 2006
HP Pre_Amplifier	8449B	3008A01922	Oct. 13, 2005
ROHDE & SCHWARZ Test Receiver	ESCS30	100287	Dec. 08, 2005
CHASE Broadband Antenna	VULB9168	138	Dec. 21, 2005
Schwarzbeck Horn_Antenna	BBHA9120	D124	Dec. 11, 2005
Schwarzbeck Horn_Antenna	BBHA 9170	BBHA9170153	Jan. 30, 2006
SCHWARZBECK Biconical Antenna	VHBA9123	459	Jun. 26, 2006
SCHWARZBECK Periodic Antenna	UPA6108	1148	Jun. 26, 2006
RF Switches (ARNITSU)	CS-201	1565157	NA
RF CABLE (Chaintek) 1GHz-20GHz	SF102	22054-2	Nov. 15. 2005
RF Cable(RICHTEC)	9913-30M	STCCAB-30M- 1GHz-021	Jul. 16, 2006
Software	ADT_Radiated_V 5.14	NA	NA
CHANCE MOST Antenna Tower	AT-100	0203	NA
CHANCE MOST Turn Table	TT-100	0203	NA

- Note: 1. The calibration interval of the above test instruments is 12 months (36 months for Tunable Periodic Antenna) and the calibrations are traceable to NML/ROC and NIST/USA.
2. The horn antenna and HP preamplifier (model: 8449B) are used only for the measurement of emission frequency above 1GHz if tested.
3. The test was performed in ADT Open Site No. C.
4. The FCC Site Registration No. is 656396.
5. The VCCI Site Registration No. is R-1626.
6. The CANADA Site Registration No. is IC 4824-3.
7. The following table is for the measurement uncertainty, which is calculated as per the document CISPR 16-4.

Measurement	Value
Radiated emissions (30MHz-1GHz)	2.98 dB
Radiated emissions (1GHz ~18GHz)	2.21 dB
Radiated emissions (18GHz ~20GHz)	1.88 dB



4.2.3 TEST PROCEDURES

- a. The EUT was placed on the top of a rotating table 0.8 meters above the ground at a 3 meter semi- anechoic. The table was rotated 360 degrees to determine the position of the highest radiation.
- b. The EUT was set 3 meters away from the interference-receiving antenna, which was mounted on the top of a variable-height antenna tower.
- c. The antenna is a broadband antenna, and its height is varied from one meter to four meters above the ground to determine the maximum value of the field strength. Both horizontal and vertical polarizations of the antenna are set to make the measurement.
- d. For each suspected emission, the EUT was arranged to its worst case and then the antenna was tuned to heights from 1 meter to 4 meters and the rotatable table was turned from 0 degrees to 360 degrees to find the maximum reading.
- e. The test-receiver system was set to Peak Detect Function and Specified Bandwidth with Maximum Hold Mode.
- f. If the emission level of the EUT in peak mode was 10 dB lower than the limit specified, then testing could be stopped and the peak values of the EUT would be reported. Otherwise the emissions that did not have 10 dB margin would be re-tested one by one using the quasi-peak method or average method as specified and then reported in Data sheet peak mode and QP mode.

NOTE:

1. The resolution bandwidth and video bandwidth of test receiver/spectrum analyzer is 120kHz for Quasi-peak detection at frequency below 1GHz.
2. The resolution bandwidth and video bandwidth of test receiver/spectrum analyzer is 1 MHz for Peak detection (PK) at frequency above 1GHz.
3. The resolution bandwidth of test receiver/spectrum analyzer is 1 MHz and the video bandwidth is 10 Hz for Average detection (AV) at frequency above 1GHz.

4.2.4 DEVIATION FROM TEST STANDARD

No deviation

4.2.5 TEST SETUP

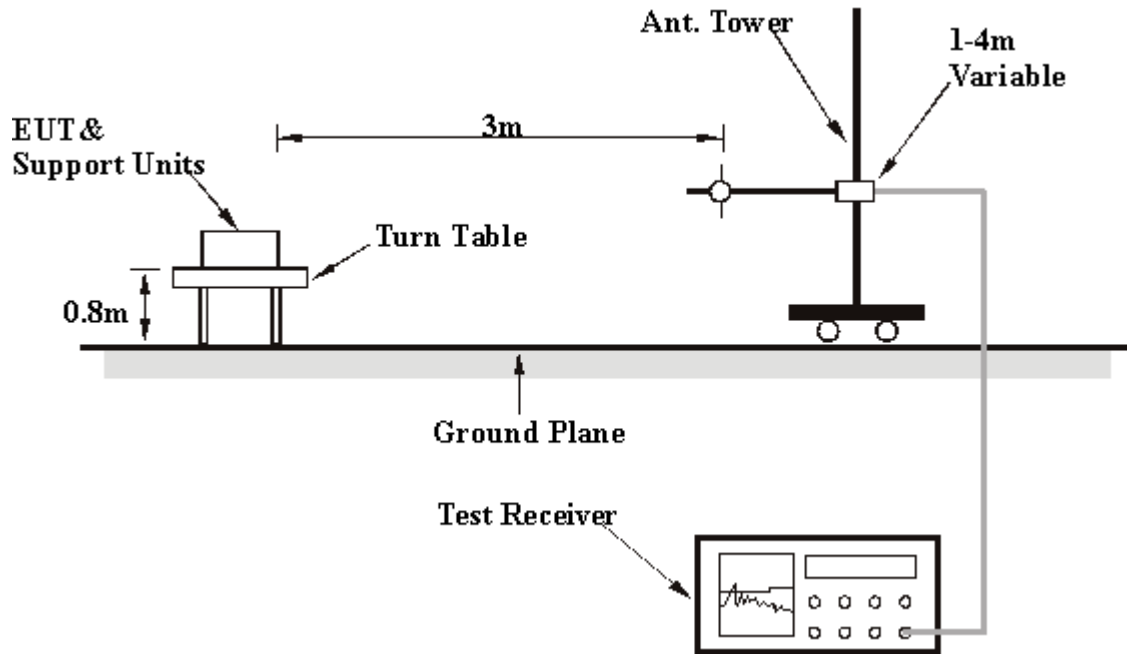

For the actual test configuration, please refer to the related item – Photographs of the Test Configuration.

4.2.6 EUT OPERATING CONDITIONS

Same as 4.1.6



4.2.7 TEST RESULTS

Below 1GHz Worst-Case Data (Adapter Mode)

EUT	Multi-Channel Access Point	MODEL	RBT-4102
TEST MODE	With Adapter	FREQUENCY RANGE	Below 1000MHz
MODULATION TYPE	BPSK	TRANSFER RATE	6Mbps
INPUT POWER (SYSTEM)	120Vac, 60 Hz	DETECTOR FUNCTION	Quasi-Peak
ENVIRONMENTAL CONDITIONS	28deg. C, 55%RH, 961hPa	TESTED BY	Wen Yu

ANTENNA POLARITY & TEST DISTANCE: HORIZONTAL AT 3 M

No.	Freq. (MHz)	Emission Level (dBuV/m)	Limit (dBuV/m)	Margin (dB)	Antenna Height (m)	Table Angle (Degree)	Raw Value (dBuV)	Correction Factor (dB/m)
1	125.00	16.20 QP	43.50	-27.30	1.67 H	108	4.30	11.90
2	150.00	20.10 QP	43.50	-23.40	1.60 H	26	6.70	13.40
3	200.00	23.40 QP	43.50	-20.10	1.58 H	1	12.20	11.20
4	250.00	22.80 QP	46.00	-23.20	1.56 H	77	9.50	13.30
5	375.00	24.60 QP	46.00	-21.40	1.41 H	96	7.00	17.60
6	400.00	26.90 QP	46.00	-19.10	1.33 H	158	8.50	18.40
7	500.00	31.10 QP	46.00	-14.90	1.25 H	45	10.20	20.90
8	625.00	25.60 QP	46.00	-20.40	1.38 H	316	1.80	23.80
9	825.00	29.90 QP	46.00	-16.10	1.12 H	138	2.90	27.00
10	990.00	34.80 QP	54.00	-19.20	1.00 H	126	5.90	28.90

ANTENNA POLARITY & TEST DISTANCE: VERTICAL AT 3 M

No.	Freq. (MHz)	Emission Level (dBuV/m)	Limit (dBuV/m)	Margin (dB)	Antenna Height (m)	Table Angle (Degree)	Raw Value (dBuV)	Correction Factor (dB/m)
1	125.00	23.80 QP	43.50	-19.70	1.00 V	159	11.90	11.90
2	150.00	27.70 QP	43.50	-15.80	1.00 V	168	14.30	13.40
3	200.00	30.00 QP	43.50	-13.50	1.00 V	168	18.80	11.20
4	250.00	25.50 QP	46.00	-20.50	1.00 V	38	12.20	13.30
5	375.00	25.90 QP	46.00	-20.10	1.00 V	266	8.30	17.60
6	400.00	26.80 QP	46.00	-19.20	1.00 V	315	8.40	18.40
7	500.00	31.20 QP	46.00	-14.80	1.02 V	177	10.30	20.90
8	625.00	27.60 QP	46.00	-18.40	1.07 V	189	3.80	23.80
9	825.00	29.80 QP	46.00	-16.20	1.12 V	205	2.80	27.00
10	990.00	39.10 QP	54.00	-14.90	1.26 V	319	10.20	28.90

- REMARKS:**
1. Emission level(dBuV/m)=Raw Value(dBuV) + Correction Factor(dB/m)
 2. Correction Factor(dB/m) = Antenna Factor (dB/m) + Cable Factor (dB)
 3. The other emission levels were very low against the limit.
 4. Margin value = Emission level – Limit value

Below 1GHz Worst-Case Data(Adapter Mode)

EUT	Multi-Channel Access Point	MODEL	RBT-4102
TEST MODE	With POE	FREQUENCY RANGE	Below 1000MHz
MODULATION TYPE	BPSK	TRANSFER RATE	6Mbps
INPUT POWER (SYSTEM)	120Vac, 60 Hz	DETECTOR FUNCTION	Quasi-Peak
ENVIRONMENTAL CONDITIONS	28deg. C, 55%RH, 961hPa	TESTED BY	Wen Yu

ANTENNA POLARITY & TEST DISTANCE: HORIZONTAL AT 3 M

No.	Freq. (MHz)	Emission Level (dBuV/m)	Limit (dBuV/m)	Margin (dB)	Antenna Height (m)	Table Angle (Degree)	Raw Value (dBuV)	Correction Factor (dB/m)
1	125.00	15.50 QP	43.50	-28.00	1.65 H	157	3.60	11.90
2	150.00	20.90 QP	43.50	-22.60	1.60 H	166	7.50	13.40
3	200.00	23.80 QP	43.50	-19.70	1.58 H	205	12.60	11.20
4	250.00	23.50 QP	46.00	-22.50	1.51 H	311	10.20	13.30
5	375.00	25.10 QP	46.00	-20.90	1.43 H	39	7.50	17.60
6	400.00	25.60 QP	46.00	-20.40	1.38 H	48	7.20	18.40
7	500.00	30.10 QP	46.00	-15.90	1.36 H	76	9.20	20.90
8	625.00	26.80 QP	46.00	-19.20	1.25 H	139	3.00	23.80
9	825.00	30.40 QP	46.00	-15.60	1.15 H	38	3.40	27.00
10	990.00	35.20 QP	54.00	-18.80	1.00 H	256	6.30	28.90

ANTENNA POLARITY & TEST DISTANCE: VERTICAL AT 3 M

No.	Freq. (MHz)	Emission Level (dBuV/m)	Limit (dBuV/m)	Margin (dB)	Antenna Height (m)	Table Angle (Degree)	Raw Value (dBuV)	Correction Factor (dB/m)
1	125.00	24.40 QP	43.50	-19.10	1.00 V	39	12.50	11.90
2	150.00	23.60 QP	43.50	-19.90	1.00 V	217	10.20	13.40
3	200.00	33.80 QP	43.50	-9.70	1.00 V	159	22.60	11.20
4	250.00	25.50 QP	46.00	-20.50	1.00 V	166	12.20	13.30
5	375.00	24.80 QP	46.00	-21.20	1.00 V	317	7.20	17.60
6	400.00	25.60 QP	46.00	-20.40	1.00 V	125	7.20	18.40
7	500.00	28.90 QP	46.00	-17.10	1.05 V	198	8.00	20.90
8	625.00	28.90 QP	46.00	-17.10	1.08 V	225	5.10	23.80
9	825.00	32.10 QP	46.00	-13.90	1.10 V	203	5.10	27.00
10	990.00	36.50 QP	54.00	-17.50	1.22 V	175	7.60	28.90

- REMARKS:**
1. Emission level(dBuV/m)=Raw Value(dBuV) + Correction Factor(dB/m)
 2. Correction Factor(dB/m) = Antenna Factor (dB/m) + Cable Factor (dB)
 3. The other emission levels were very low against the limit.
 4. Margin value = Emission level – Limit value

**802.11b DSSS modulation**

EUT	Multi-Channel Access Point	MODEL	RBT-4102
CHANNEL	Channel 1	FREQUENCY RANGE	1 ~ 25GHz
MODULATION TYPE	CCK	TRANSFER RATE	11Mbps
INPUT POWER (SYSTEM)	120Vac, 60 Hz	DETECTOR FUNCTION	Peak(PK) Average (AV)
ENVIRONMENTAL CONDITIONS	22deg. C, 75%RH, 961hPa	TESTED BY	Eric Lee

ANTENNA POLARITY & TEST DISTANCE: HORIZONTAL AT 3 M

No.	Freq. (MHz)	Emission Level (dBuV/m)	Limit (dBuV/m)	Margin (dB)	Antenna Height (m)	Table Angle (Degree)	Raw Value (dBuV)	Correction Factor (dB/m)
1	2387.00	49.10 PK	74.00	-24.90	1.11 H	102	18.70	30.40
1	2387.00	42.50 AV	54.00	-11.50	1.11 H	102	12.10	30.40
2	2390.00	47.10 PK	74.00	-26.90	1.09 H	22	16.70	30.40
2	2390.00	40.10 AV	54.00	-13.90	1.09 H	22	9.70	30.40
3	*2412.00	105.80 PK			1.23 H	65	75.30	30.50
3	*2412.00	98.70 AV			1.23 H	65	68.20	30.50
4	2688.00	35.80 PK	74.00	-38.20	1.23 H	65	4.50	31.30
4	2688.00	27.00 AV	54.00	-27.00	1.23 H	65	-4.20	31.30
5	4824.00	48.80 PK	74.00	-25.20	1.28 H	74	12.60	36.20
5	4824.00	36.80 AV	54.00	-17.20	1.28 H	74	0.50	36.20
6	7236.00	46.20 PK	74.00	-27.80	1.52 H	63	4.60	41.70
6	7236.00	36.50 AV	54.00	-17.50	1.52 H	63	-5.20	41.70

ANTENNA POLARITY & TEST DISTANCE: VERTICAL AT 3 M

No.	Freq. (MHz)	Emission Level (dBuV/m)	Limit (dBuV/m)	Margin (dB)	Antenna Height (m)	Table Angle (Degree)	Raw Value (dBuV)	Correction Factor (dB/m)
1	2387.00	60.10 PK	74.00	-13.90	1.11 V	223	29.70	30.40
1	2387.00	53.30 AV	54.00	-0.70	1.11 V	223	22.90	30.40
2	2390.00	58.10 PK	74.00	-15.90	1.02 V	33	27.70	30.40
2	2390.00	51.00 AV	54.00	-3.00	1.02 V	33	20.50	30.40
3	*2412.00	116.80 PK			1.40 V	47	86.30	30.50
3	*2412.00	109.50 AV			1.40 V	47	79.00	30.50
4	2688.00	42.00 PK	74.00	-32.00	1.20 V	115	10.70	31.30
4	2688.00	32.90 AV	54.00	-21.10	1.20 V	115	1.60	31.30
5	4824.00	50.20 PK	74.00	-23.80	1.23 V	65	14.00	36.20
5	4824.00	39.40 AV	54.00	-14.60	1.23 V	65	3.20	36.20
6	7236.00	48.40 PK	74.00	-25.60	1.23 V	65	6.80	41.70
6	7236.00	37.50 AV	54.00	-16.50	1.23 V	65	-4.20	41.70

- REMARKS:**
1. Emission level(dBuV/m)=Raw Value(dBuV) + Correction Factor(dB/m)
 2. Correction Factor(dB/m) = Antenna Factor (dB/m) + Cable Factor (dB)
 3. The other emission levels were very low against the limit.
 4. Margin value = Emission level – Limit value.
 5. The limit value is defined as per 15.247
 6. “ * ” : Fundamental frequency



EUT	Multi-Channel Access Point	MODEL	RBT-4102
CHANNEL	Channel 6	FREQUENCY RANGE	1 ~ 25GHz
MODULATION TYPE	CCK	TRANSFER RATE	11Mbps
INPUT POWER (SYSTEM)	120Vac, 60 Hz	DETECTOR FUNCTION	Peak(PK) Average (AV)
ENVIRONMENTAL CONDITIONS	22deg. C, 75%RH, 961hPa	TESTED BY	Eric Lee

ANTENNA POLARITY & TEST DISTANCE: HORIZONTAL AT 3 M

No.	Freq. (MHz)	Emission Level (dBuV/m)	Limit (dBuV/m)	Margin (dB)	Antenna Height (m)	Table Angle (Degree)	Raw Value (dBuV)	Correction Factor (dB/m)
1	*2437.00	108.30 PK			1.20 H	24	77.60	30.70
1	*2437.00	101.20 AV			1.20 H	24	70.50	30.70
2	2688.00	36.70 PK	74.00	-37.30	1.11 H	25	5.40	31.30
2	2688.00	28.00 AV	54.00	-26.00	1.11 H	25	-3.20	31.30
3	4874.00	50.40 PK	74.00	-23.60	1.02 H	7	14.00	36.50
3	4874.00	38.30 AV	54.00	-15.70	1.02 H	7	1.90	36.50
4	7311.00	48.30 PK	74.00	-25.70	1.53 H	62	6.60	41.80
4	7311.00	37.70 AV	54.00	-16.30	1.53 H	62	-4.10	41.80

ANTENNA POLARITY & TEST DISTANCE: VERTICAL AT 3 M

No.	Freq. (MHz)	Emission Level (dBuV/m)	Limit (dBuV/m)	Margin (dB)	Antenna Height (m)	Table Angle (Degree)	Raw Value (dBuV)	Correction Factor (dB/m)
1	*2437.00	120.00 PK			1.40 V	48	89.30	30.70
1	*2437.00	111.10 AV			1.40 V	48	80.40	30.70
2	2688.00	42.50 PK	74.00	-31.50	1.30 V	32	11.20	31.30
2	2688.00	33.80 AV	54.00	-20.20	1.30 V	32	2.50	31.30
3	4874.00	52.60 PK	74.00	-21.40	1.29 V	39	16.10	36.50
3	4874.00	41.70 AV	54.00	-12.30	1.29 V	39	5.20	36.50
4	7311.00	51.30 PK	74.00	-22.70	1.11 V	24	9.60	41.80
4	7311.00	39.70 AV	54.00	-14.30	1.11 V	24	-2.10	41.80

- REMARKS:**
1. Emission level(dBuV/m)=Raw Value(dBuV) + Correction Factor(dB/m)
 2. Correction Factor(dB/m) = Antenna Factor (dB/m) + Cable Factor (dB)
 3. The other emission levels were very low against the limit.
 4. Margin value = Emission level – Limit value.
 5. The limit value is defined as per 15.247
 6. “ * “ : Fundamental frequency



EUT	Multi-Channel Access Point	MODEL	RBT-4102
CHANNEL	Channel 11	FREQUENCY RANGE	1 ~ 25GHz
MODULATION TYPE	CCK	TRANSFER RATE	11Mbps
INPUT POWER (SYSTEM)	120Vac, 60 Hz	DETECTOR FUNCTION	Peak(PK) Average (AV)
ENVIRONMENTAL CONDITIONS	22deg. C, 75%RH, 961hPa	TESTED BY	Eric Lee

ANTENNA POLARITY & TEST DISTANCE: HORIZONTAL AT 3 M

No.	Freq. (MHz)	Emission Level (dBuV/m)	Limit (dBuV/m)	Margin (dB)	Antenna Height (m)	Table Angle (Degree)	Raw Value (dBuV)	Correction Factor (dB/m)
1	*2462.00	103.90 PK			1.45 H	24	73.10	30.80
1	*2462.00	97.30 AV			1.45 H	24	66.50	30.80
2	2483.50	50.80 PK	74.00	-23.20	1.00 H	1	19.80	31.00
2	2483.50	41.80 AV	54.00	-12.20	1.00 H	1	10.80	31.00
3	2487.00	49.60 PK	74.00	-24.40	1.02 H	9	18.70	30.90
3	2487.00	41.00 AV	54.00	-13.00	1.02 H	9	10.10	30.90
4	2688.00	34.90 PK	74.00	-39.10	1.23 H	65	3.60	31.30
4	2688.00	27.00 AV	54.00	-27.00	1.23 H	65	-4.20	31.30
5	4924.00	47.60 PK	74.00	-26.40	1.53 H	66	10.90	36.70
5	4924.00	36.80 AV	54.00	-17.20	1.53 H	66	0.10	36.70
6	7386.00	47.90 PK	74.00	-26.10	1.54 H	24	6.00	41.80
6	7386.00	37.20 AV	54.00	-16.80	1.54 H	24	-4.70	41.80

ANTENNA POLARITY & TEST DISTANCE: VERTICAL AT 3 M

No.	Freq. (MHz)	Emission Level (dBuV/m)	Limit (dBuV/m)	Margin (dB)	Antenna Height (m)	Table Angle (Degree)	Raw Value (dBuV)	Correction Factor (dB/m)
1	*2462.00	114.90 PK			1.39 V	54	84.10	30.80
1	*2462.00	108.50 AV			1.39 V	54	77.70	30.80
2	2483.50	61.80 PK	74.00	-12.20	1.21 V	4	30.80	31.00
2	2483.50	53.00 AV	54.00	-1.00	1.21 V	4	22.00	31.00
3	2487.00	60.00 PK	74.00	-14.00	1.40 V	20	29.10	30.90
3	2487.00	52.20 AV	54.00	-1.80	1.40 V	20	21.30	30.90
4	2688.00	39.80 PK	74.00	-34.20	1.23 V	54	8.50	31.30
4	2688.00	32.30 AV	54.00	-21.70	1.23 V	54	1.00	31.30
5	4924.00	49.60 PK	74.00	-24.40	1.10 V	21	12.90	36.70
5	4924.00	38.20 AV	54.00	-15.80	1.10 V	21	1.50	36.70
6	7386.00	46.90 PK	74.00	-27.10	1.65 V	24	5.00	41.80
6	7386.00	37.90 AV	54.00	-16.10	1.65 V	24	-3.90	41.80

- REMARKS:**
1. Emission level(dBuV/m)=Raw Value(dBuV) + Correction Factor(dB/m)
 2. Correction Factor(dB/m) = Antenna Factor (dB/m) + Cable Factor (dB)
 3. The other emission levels were very low against the limit.
 4. Margin value = Emission level – Limit value.
 5. The limit value is defined as per 15.247
 6. “ * “ : Fundamental frequency

802.11g OFDM modulation

EUT	Multi-Channel Access Point	MODEL	RBT-4102
CHANNEL	Channel 1	FREQUENCY RANGE	1 ~ 25GHz
MODULATION TYPE	BPSK	TRANSFER RATE	6Mbps
INPUT POWER (SYSTEM)	120Vac, 60 Hz	DETECTOR FUNCTION	Peak(PK) Average (AV)
ENVIRONMENTAL CONDITIONS	22deg. C, 75%RH, 961hPa	TESTED BY	Eric Lee

ANTENNA POLARITY & TEST DISTANCE: HORIZONTAL AT 3 M

No.	Freq. (MHz)	Emission Level (dBuV/m)	Limit (dBuV/m)	Margin (dB)	Antenna Height (m)	Table Angle (Degree)	Raw Value (dBuV)	Correction Factor (dB/m)
1	2390.00	54.10 PK	74.00	-19.90	1.11 H	24	23.70	30.40
1	2390.00	42.70 AV	54.00	-11.30	1.11 H	24	12.30	30.40
2	*2412.00	102.40 PK			1.54 H	47	71.90	30.50
2	*2412.00	93.40 AV			1.54 H	47	62.90	30.50
3	2688.00	34.80 PK	74.00	-39.20	1.52 H	32	3.50	31.30
3	2688.00	26.00 AV	54.00	-28.00	1.52 H	32	-5.20	31.30
4	4824.00	43.20 PK	74.00	-30.80	1.42 H	55	7.00	36.20
4	4824.00	31.30 AV	54.00	-22.70	1.42 H	55	-4.90	36.20
5	7236.00	46.50 PK	74.00	-27.50	1.54 H	24	4.80	41.70
5	7236.00	37.50 AV	54.00	-16.50	1.54 H	24	-4.20	41.70

ANTENNA POLARITY & TEST DISTANCE: VERTICAL AT 3 M

No.	Freq. (MHz)	Emission Level (dBuV/m)	Limit (dBuV/m)	Margin (dB)	Antenna Height (m)	Table Angle (Degree)	Raw Value (dBuV)	Correction Factor (dB/m)
1	2390.00	65.40 PK	74.00	-8.60	1.29 V	44	35.00	30.40
1	2390.00	53.00 AV	54.00	-1.00	1.29 V	44	22.60	30.40
2	*2412.00	113.70 PK			1.40 V	59	83.20	30.50
2	*2412.00	103.90 AV			1.40 V	59	73.40	30.50
3	2688.00	39.00 PK	74.00	-35.00	1.20 V	24	7.70	31.30
3	2688.00	31.30 AV	54.00	-22.70	1.20 V	24	0.10	31.30
4	4824.00	49.20 PK	74.00	-24.80	1.11 V	47	13.00	36.20
4	4824.00	36.40 AV	54.00	-17.60	1.11 V	47	0.20	36.20
5	7236.00	50.40 PK	74.00	-23.60	1.50 V	87	8.80	41.70
5	7236.00	40.50 AV	54.00	-13.50	1.50 V	87	-1.20	41.70

- REMARKS:**
1. Emission level(dBuV/m)=Raw Value(dBuV) + Correction Factor(dB/m)
 2. Correction Factor(dB/m) = Antenna Factor (dB/m) + Cable Factor (dB)
 3. The other emission levels were very low against the limit.
 4. Margin value = Emission level – Limit value.
 5. The limit value is defined as per 15.247
 6. " * " : Fundamental frequency



EUT	Multi-Channel Access Point	MODEL	RBT-4102
CHANNEL	Channel 6	FREQUENCY RANGE	1 ~ 25GHz
MODULATION TYPE	BPSK	TRANSFER RATE	6Mbps
INPUT POWER (SYSTEM)	120Vac, 60 Hz	DETECTOR FUNCTION	Peak(PK) Average (AV)
ENVIRONMENTAL CONDITIONS	22deg. C, 75%RH, 961hPa	TESTED BY	Eric Lee

ANTENNA POLARITY & TEST DISTANCE: HORIZONTAL AT 3 M								
No.	Freq. (MHz)	Emission Level (dBuV/m)	Limit (dBuV/m)	Margin (dB)	Antenna Height (m)	Table Angle (Degree)	Raw Value (dBuV)	Correction Factor (dB/m)
1	*2437.00	105.90 PK			1.40 H	21	75.20	30.70
1	*2437.00	96.00 AV			1.40 H	21	65.30	30.70
2	2688.00	37.50 PK	74.00	-36.50	1.54 H	24	6.20	31.30
2	2688.00	27.00 AV	54.00	-27.00	1.54 H	24	-4.20	31.30
3	4874.00	43.30 PK	74.00	-30.70	1.77 H	45	6.90	36.50
3	4874.00	32.60 AV	54.00	-21.40	1.77 H	45	-3.90	36.50
4	7311.00	48.40 PK	74.00	-25.60	1.60 H	32	6.70	41.80
4	7311.00	36.70 AV	54.00	-17.30	1.60 H	32	-5.10	41.80

ANTENNA POLARITY & TEST DISTANCE: VERTICAL AT 3 M								
No.	Freq. (MHz)	Emission Level (dBuV/m)	Limit (dBuV/m)	Margin (dB)	Antenna Height (m)	Table Angle (Degree)	Raw Value (dBuV)	Correction Factor (dB/m)
1	*2437.00	116.00 PK			1.40 V	54	85.30	30.70
1	*2437.00	106.40 AV			1.40 V	54	75.70	30.70
2	2688.00	42.70 PK	74.00	-31.30	1.16 V	14	11.40	31.30
2	2688.00	34.70 AV	54.00	-19.30	1.16 V	14	3.40	31.30
3	4874.00	53.20 PK	74.00	-20.80	1.06 V	31	16.80	36.50
3	4874.00	39.70 AV	54.00	-14.30	1.06 V	31	3.30	36.50
4	7311.00	54.50 PK	74.00	-19.50	1.20 V	332	12.80	41.80
4	7311.00	43.40 AV	54.00	-10.60	1.20 V	332	1.70	41.80

- REMARKS:**
1. Emission level(dBuV/m)=Raw Value(dBuV) + Correction Factor(dB/m)
 2. Correction Factor(dB/m) = Antenna Factor (dB/m) + Cable Factor (dB)
 3. The other emission levels were very low against the limit.
 4. Margin value = Emission level – Limit value.
 5. The limit value is defined as per 15.247
 6. “ * “ : Fundamental frequency



EUT	Multi-Channel Access Point	MODEL	RBT-4102
CHANNEL	Channel 11	FREQUENCY RANGE	1 ~ 25GHz
MODULATION TYPE	BPSK	TRANSFER RATE	6Mbps
INPUT POWER (SYSTEM)	120Vac, 60 Hz	DETECTOR FUNCTION	Peak(PK) Average (AV)
ENVIRONMENTAL CONDITIONS	22deg. C, 75%RH, 961hPa	TESTED BY	Eric Lee

ANTENNA POLARITY & TEST DISTANCE: HORIZONTAL AT 3 M

No.	Freq. (MHz)	Emission Level (dBuV/m)	Limit (dBuV/m)	Margin (dB)	Antenna Height (m)	Table Angle (Degree)	Raw Value (dBuV)	Correction Factor (dB/m)
1	*2462.00	98.70 PK			1.40 H	24	67.90	30.80
1	*2462.00	90.40 AV			1.40 H	24	59.50	30.80
2	2483.50	55.60 PK	74.00	-18.40	1.25 H	85	24.70	31.00
2	2483.50	43.10 AV	54.00	-10.90	1.25 H	85	12.10	31.00
3	2688.00	37.00 PK	74.00	-37.00	1.25 H	24	5.70	31.30
3	2688.00	26.00 AV	54.00	-28.00	1.25 H	24	-5.20	31.30
4	4924.00	43.70 PK	74.00	-30.30	1.42 H	54	7.00	36.70
4	4924.00	32.10 AV	54.00	-21.90	1.42 H	54	-4.50	36.70
5	7386.00	47.20 PK	74.00	-26.80	1.41 H	14	5.30	41.80
5	7386.00	37.20 AV	54.00	-16.80	1.41 H	14	-4.70	41.80

ANTENNA POLARITY & TEST DISTANCE: VERTICAL AT 3 M

No.	Freq. (MHz)	Emission Level (dBuV/m)	Limit (dBuV/m)	Margin (dB)	Antenna Height (m)	Table Angle (Degree)	Raw Value (dBuV)	Correction Factor (dB/m)
1	*2462.00	109.70 PK			1.41 V	53	78.90	30.80
1	*2462.00	100.30 AV			1.41 V	53	69.50	30.80
2	2483.50	66.60 PK	74.00	-7.40	1.11 V	2	35.70	31.00
2	2483.50	53.00 AV	54.00	-1.00	1.11 V	2	22.00	31.00
3	2688.00	37.00 PK	74.00	-37.00	1.24 V	14	5.70	31.30
3	2688.00	27.00 AV	54.00	-27.00	1.24 V	14	-4.20	31.30
4	4924.00	45.80 PK	74.00	-28.20	1.32 V	65	9.10	36.70
4	4924.00	34.10 AV	54.00	-19.90	1.32 V	65	-2.60	36.70
5	7386.00	45.70 PK	74.00	-28.30	1.54 V	24	3.80	41.80
5	7386.00	37.90 AV	54.00	-16.10	1.54 V	24	-3.90	41.80

- REMARKS:**
1. Emission level(dBuV/m)=Raw Value(dBuV) + Correction Factor(dB/m)
 2. Correction Factor(dB/m) = Antenna Factor (dB/m) + Cable Factor (dB)
 3. The other emission levels were very low against the limit.
 4. Margin value = Emission level – Limit value.
 5. The limit value is defined as per 15.247
 6. “ * “ : Fundamental frequency



4.3 6dB BANDWIDTH MEASUREMENT

4.3.1 LIMITS OF 6dB BANDWIDTH MEASUREMENT

The minimum of 6dB Bandwidth Measurement is 0.5 MHz.

4.3.2 TEST INSTRUMENTS

Description & Manufacturer	Model No.	Serial No.	Calibrated Until
R&S SPECTRUM ANALYZER	FSP40	100036	Nov. 23, 2005

NOTE:

- 1.The measurement uncertainty is less than +/- 2.6dB, which is calculated as per the NAMAS document NIS81.
- 2.The calibration interval of the above test instruments is 12 months and the calibrations are traceable to NML/ROC and NIST/USA.

4.3.3 TEST PROCEDURE

The transmitter output was connected to the spectrum analyzer through an attenuator. The bandwidth of the fundamental frequency was measured by spectrum analyzer with 100kHz RBW and 100kHz VBW. The 6dB bandwidth is defined as the total spectrum the power of which is higher than peak power minus 6dB.

4.3.4 DEVIATION FROM TEST STANDARD

No deviation

4.3.5 TEST SETUP



4.3.6 EUT OPERATING CONDITIONS

The software provided by client to enable the EUT under transmission condition continuously at lowest, middle and highest channel frequencies individually.



4.3.7 TEST RESULTS

802.11b DSSS modulation

EUT	Multi-Channel Access Point	MODEL	RBT-4102
MODULATION TYPE	CCK	TRANSFER RATE	11Mbps
INPUT POWER (SYSTEM)	120Vac, 60 Hz	ENVIRONMENTAL CONDITIONS	25deg. C, 60%RH, 961hPa
TESTED BY	Eric Lee		

CHANNEL	CHANNEL FREQUENCY (MHz)	6dB BANDWIDTH (MHz)	MINIMUM LIMIT (MHz)	PASS/FAIL
1	2412	10.71	0.5	PASS
6	2437	11.97	0.5	PASS
11	2462	11.69	0.5	PASS



CH1

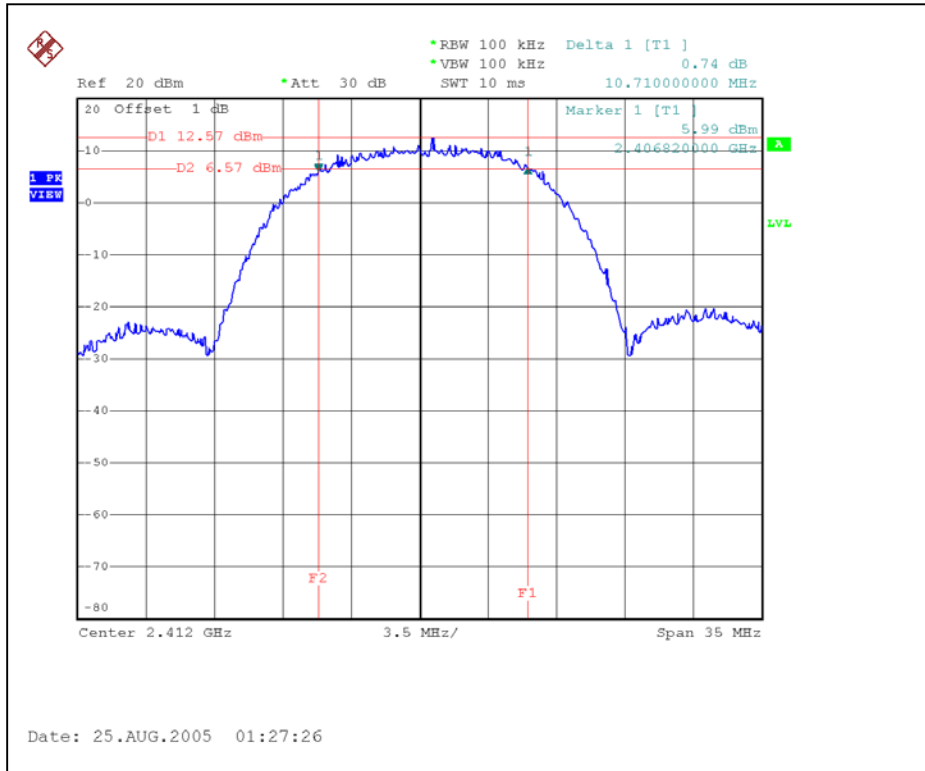

CH6

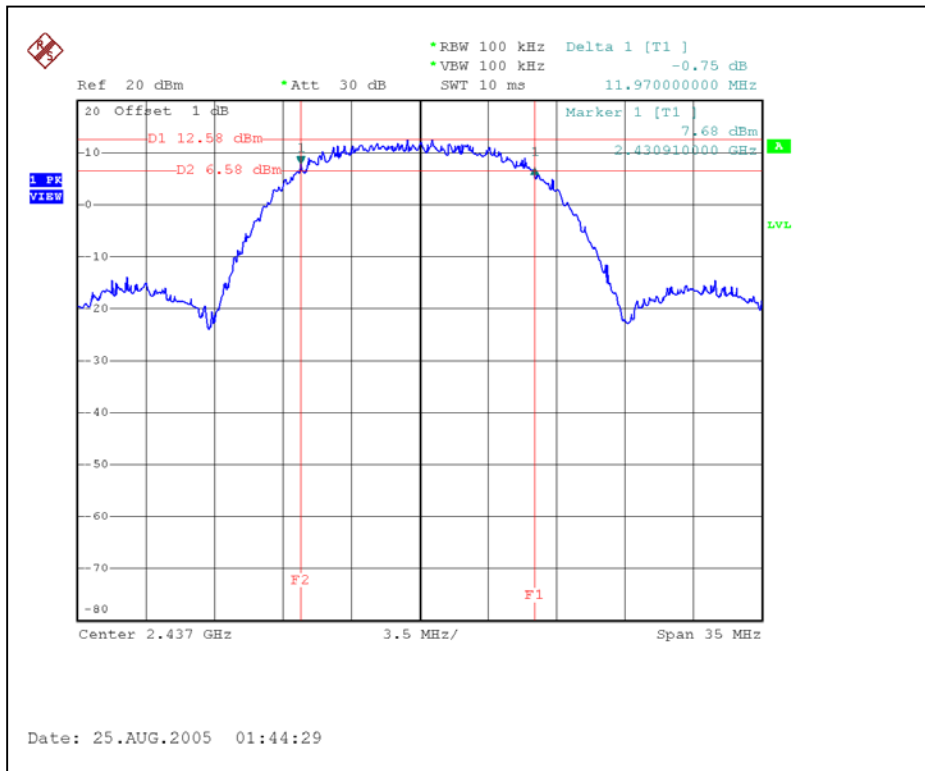



CH11

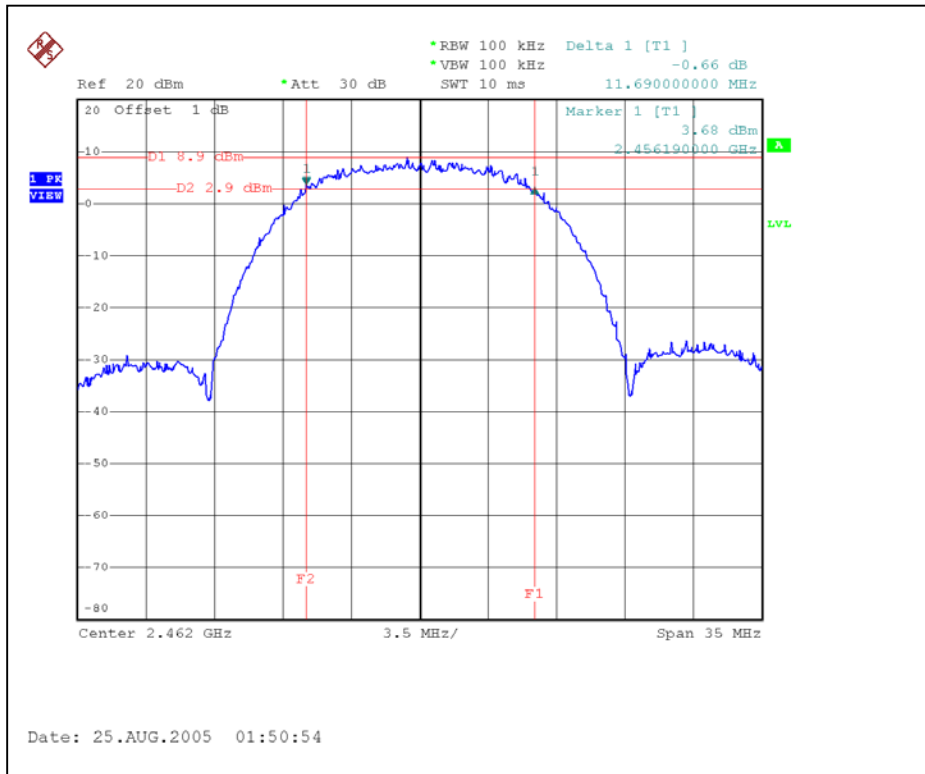



802.11g OFDM modulation

EUT	Multi-Channel Access Point	MODEL	RBT-4102
MODULATION TYPE	BPSK	TRANSFER RATE	6Mbps
INPUT POWER (SYSTEM)	120Vac, 60 Hz	ENVIRONMENTAL CONDITIONS	25deg. C, 60%RH, 961hPa
TESTED BY	Eric Lee		

CHANNEL	CHANNEL FREQUENCY (MHz)	6dB BANDWIDTH (MHz)	MINIMUM LIMIT (MHz)	PASS/FAIL
1	2412	16.17	0.5	PASS
6	2437	16.45	0.5	PASS
11	2462	16.45	0.5	PASS



CH1

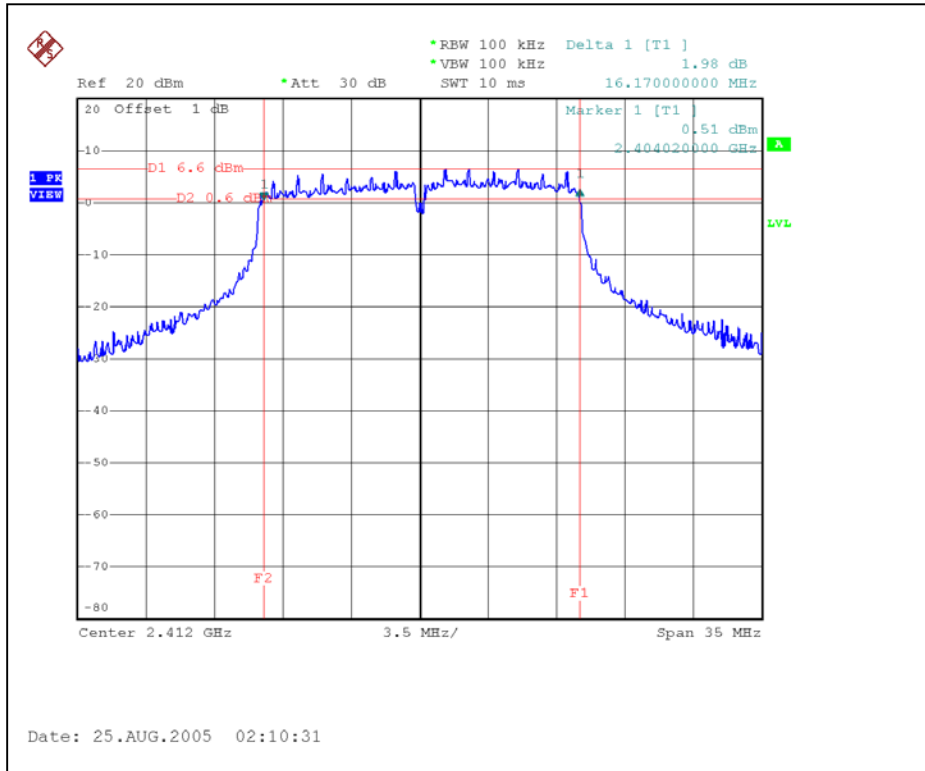

CH6

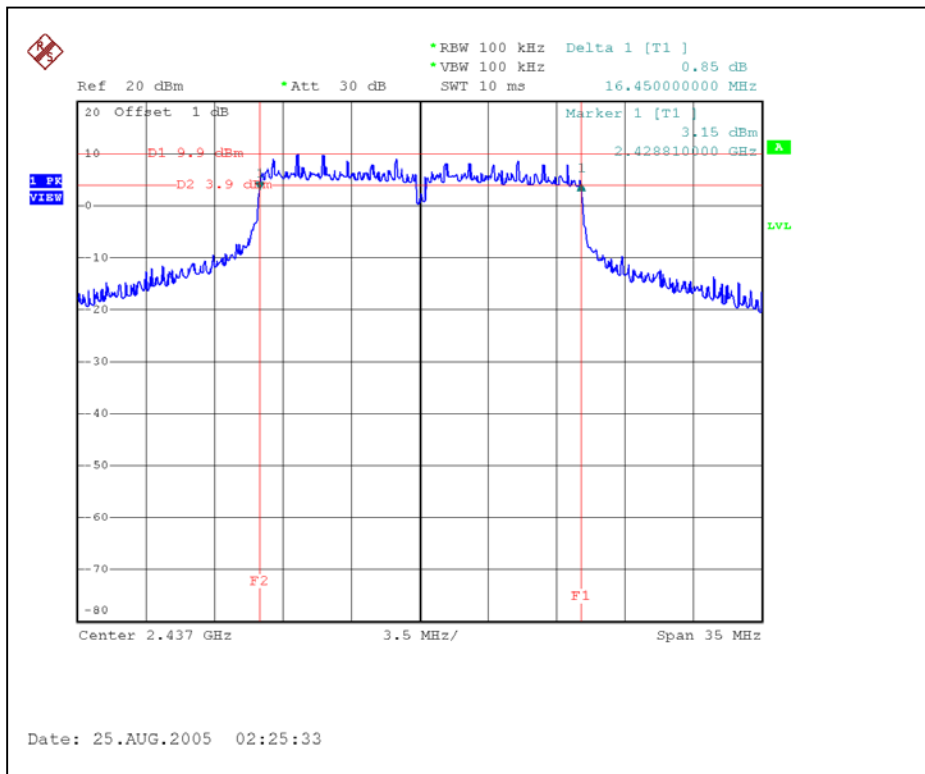



CH11

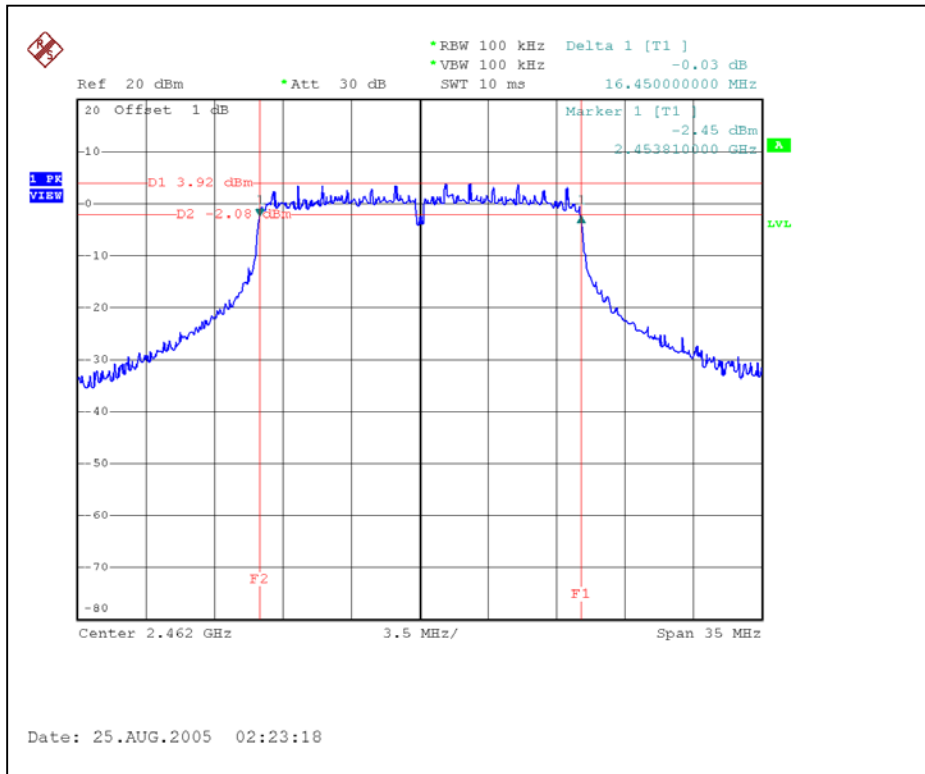

4.4 MAXIMUM PEAK OUTPUT POWER

4.4.1 LIMITS OF MAXIMUM PEAK OUTPUT POWER MEASUREMENT

The Maximum Peak Output Power Measurement is 30dBm.

4.4.2 INSTRUMENTS

Description & Manufacturer	Model No.	Serial No.	Calibrated Until
R&S SPECTRUM ANALYZER	FSP40	100036	Nov. 23, 2005
Agilent SIGNAL GENERATOR	E8257C	MY43320668	Dec. 07, 2005
TEKTRONIX OSCILLOSCOPE	TDS380	B016335	Jun. 22, 2006
NARDA DETECTOR	4503A	FSCM99899	NA

NOTE:

The calibration interval of the above test instruments is 12 months and the calibrations are traceable to NML/ROC and NIST/USA.

4.4.3 TEST PROCEDURES

1. A detector was used on the output port of the EUT. An oscilloscope was used to read the response of the detector.
2. Replaced the EUT by the signal generator. The center frequency of the S.G was adjusted to the center frequency of the measured channel.
3. Adjusted the power to have the same reading on oscilloscope. Record the power level.

4.4.4 DEVIATION FROM TEST STANDARD

No deviation

4.4.5 TEST SETUP



4.4.6 EUT OPERATING CONDITIONS

Same as Item 4.3.6



4.4.7 TEST RESULTS

802.11b DSSS modulation

EUT	Multi-Channel Access Point	MODEL	RBT-4102
MODULATION TYPE	CCK	TRANSFER RATE	11Mbps
INPUT POWER (SYSTEM)	120Vac, 60Hz	ENVIRONMENTAL CONDITIONS	25deg. C, 60%RH, 961hPa
TESTED BY	Eric Lee		

CHANNEL	CHANNEL FREQUENCY (MHz)	PEAK POWER OUTPUT (dBm)	PEAK POWER LIMIT (dBm)	PASS/FAIL
1	2412	23.60	30	PASS
6	2437	25.00	30	PASS
11	2462	21.22	30	PASS

**802.11g OFDM modulation**

EUT	Multi-Channel Access Point	MODEL	RBT-4102
MODULATION TYPE	BPSK	TRANSFER RATE	6Mbps
INPUT POWER (SYSTEM)	120Vac, 60Hz	ENVIRONMENTAL CONDITIONS	25deg. C, 60%RH, 961hPa
TESTED BY	Eric Lee		

CHANNEL	CHANNEL FREQUENCY (MHz)	PEAK POWER OUTPUT (dBm)	PEAK POWER LIMIT (dBm)	PASS/FAIL
1	2412	22.10	30	PASS
6	2437	24.90	30	PASS
11	2462	18.75	30	PASS



4.5 POWER SPECTRAL DENSITY MEASUREMENT

4.5.1 LIMITS OF POWER SPECTRAL DENSITY MEASUREMENT

The Maximum of Power Spectral Density Measurement is 8dBm.

4.5.2 TEST INSTRUMENTS

Description & Manufacturer	Model No.	Serial No.	Calibrated Until
R&S SPECTRUM ANALYZER	FSP40	100036	Nov. 23, 2005

NOTE:

- 1.The measurement uncertainty is less than +/- 2.6dB, which is calculated as per the NAMAS document NIS81.
- 2.The calibration interval of the above test instruments is 12 months and the calibrations are traceable to NML/ROC and NIST/USA.

4.5.3 TEST PROCEDURE

The transmitter output was connected to the spectrum analyzer through an attenuator, the bandwidth of the fundamental frequency was measured with the spectrum analyzer using 3kHz RBW and 30kHz VBW, set sweep time = span/3kHz. The power spectral density was measured and recorded. The sweep time is allowed to be longer than span/3kHz for a full response of the mixer in the spectrum analyzer.

4.5.4 DEVIATION FROM TEST STANDARD

No deviation

4.5.5 TEST SETUP

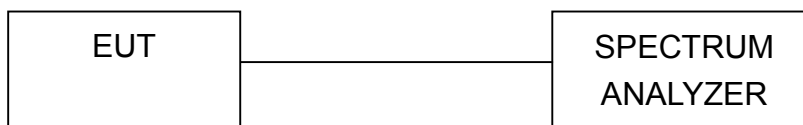

4.5.6 EUT OPERATING CONDITION

Same as Item 4.3.6



4.5.7 TEST RESULTS

802.11b DSSS modulation

EUT	Multi-Channel Access Point	MODEL	RBT-4102
MODULATION TYPE	CCK	TRANSFER RATE	11Mbps
INPUT POWER (SYSTEM)	120Vac, 60Hz	ENVIRONMENTAL CONDITIONS	25deg.C, 60%RH, 961hPa
TESTED BY	Eric Lee		

CHANNEL NUMBER	CHANNEL FREQUENCY (MHz)	RF POWER LEVEL IN 3 KHz BW (dBm)	MAXIMUM LIMIT (dBm)	PASS/FAIL
1	2412	0.28	8	PASS
6	2437	1.26	8	PASS
11	2462	-0.49	8	PASS



CH1

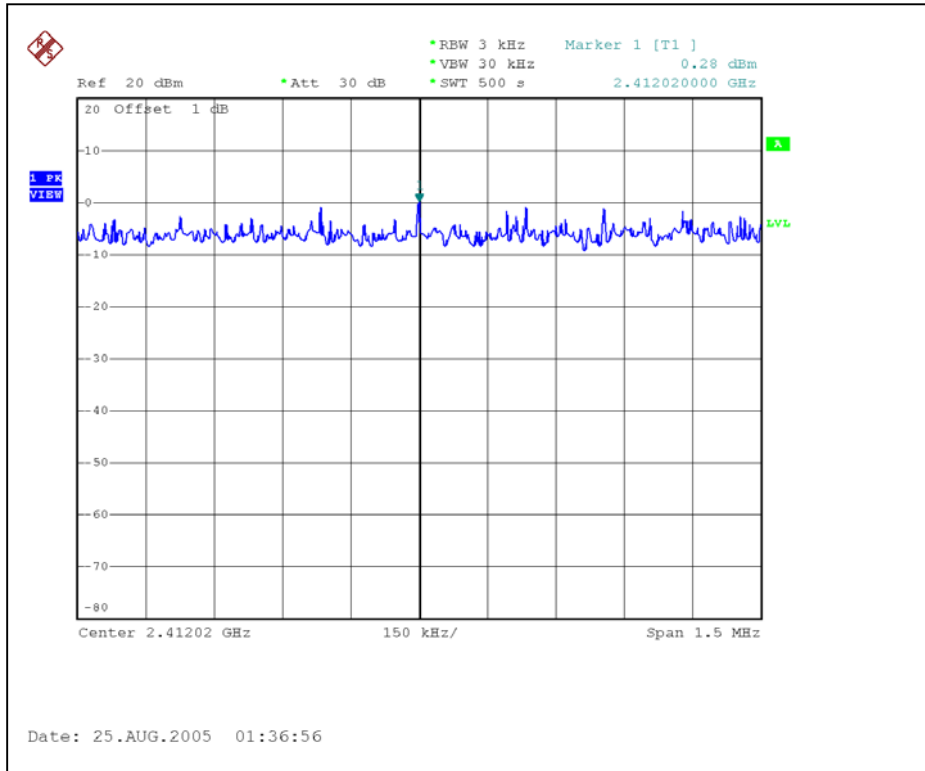

CH6

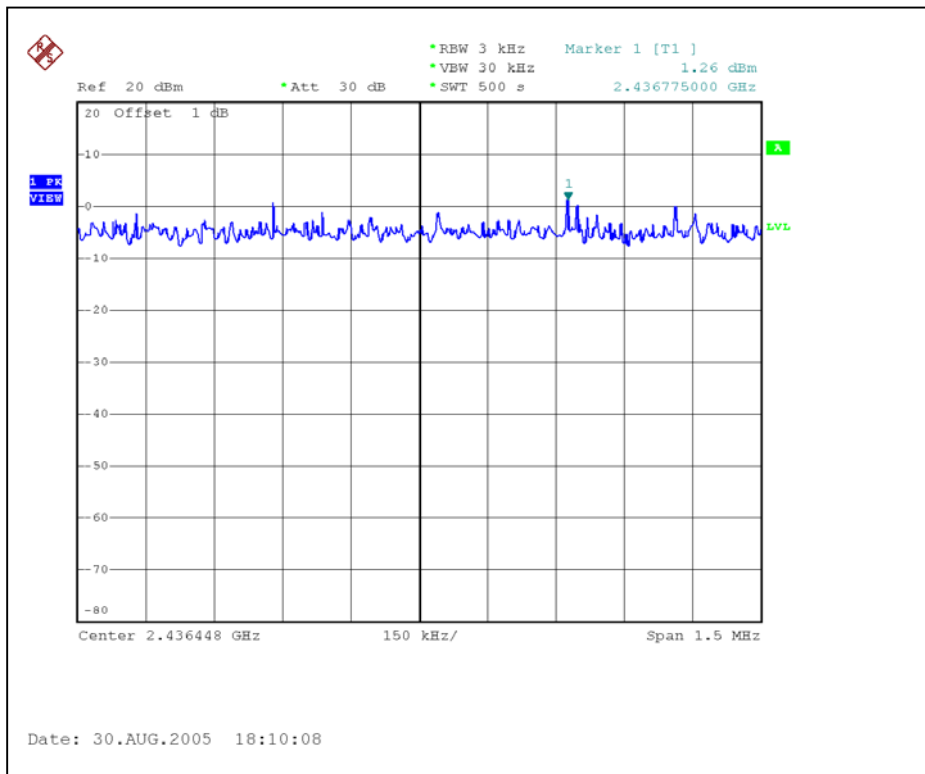



CH11

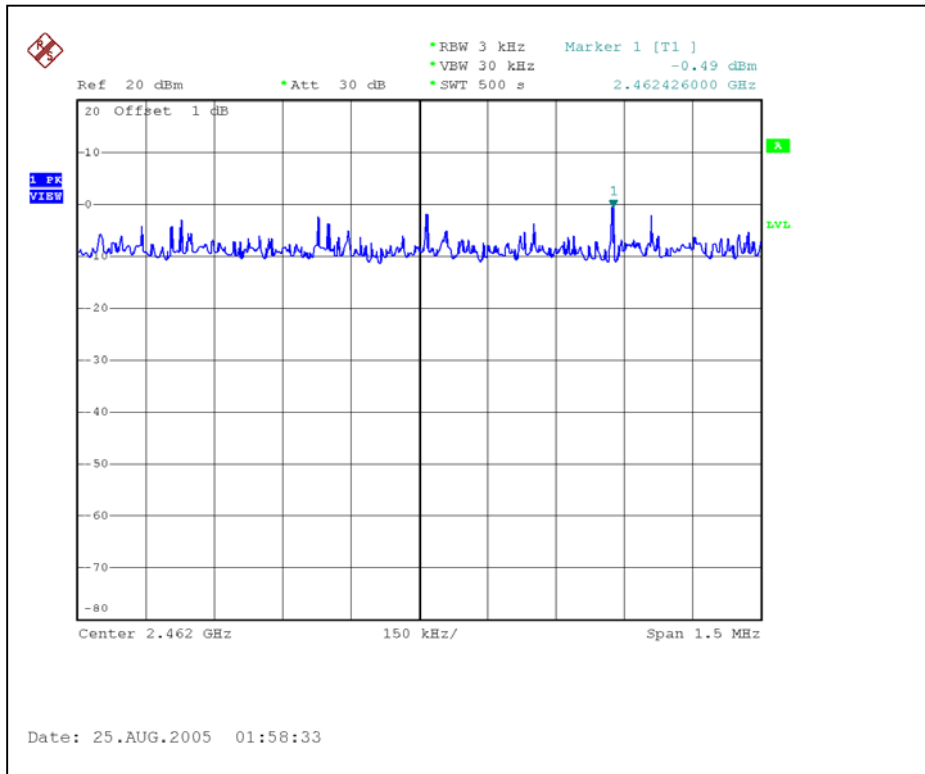



802.11g OFDM modulation

EUT	Multi-Channel Access Point	MODEL	RBT-4102
MODULATION TYPE	BPSK	TRANSFER RATE	6Mbps
INPUT POWER (SYSTEM)	120Vac, 60Hz	ENVIRONMENTAL CONDITIONS	25deg.C, 60%RH, 961hPa
TESTED BY	Eric Lee		

CHANNEL NUMBER	CHANNEL FREQUENCY (MHz)	RF POWER LEVEL IN 3 KHz BW (dBm)	MAXIMUM LIMIT (dBm)	PASS/FAIL
1	2412	-5.68	8	PASS
6	2437	-3.74	8	PASS
11	2462	-7.82	8	PASS



CH1

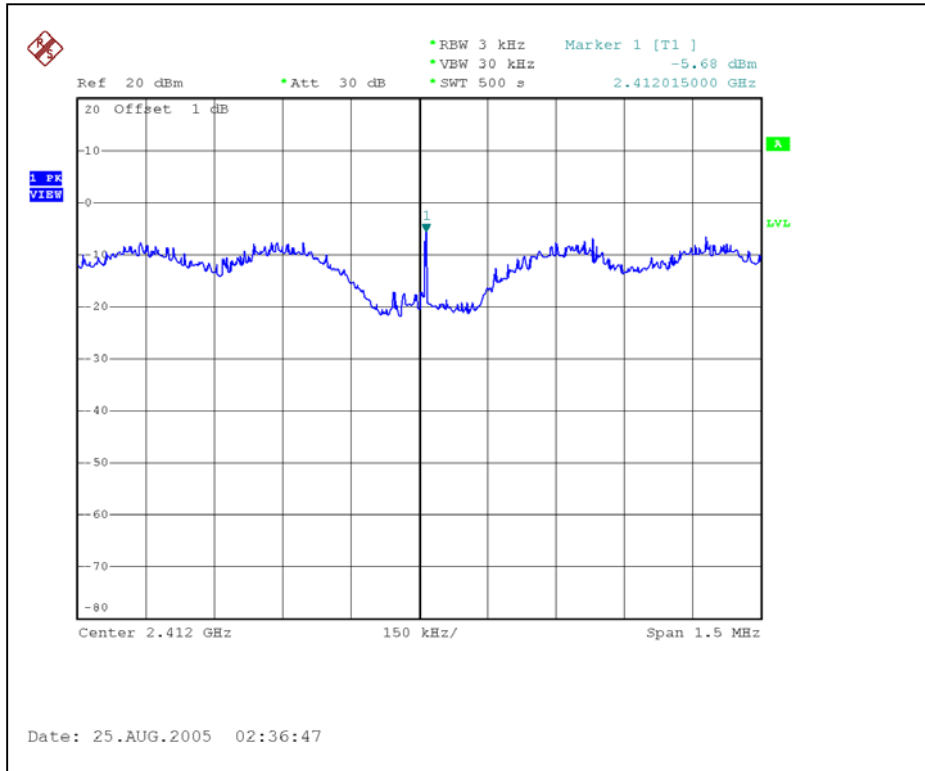

CH6

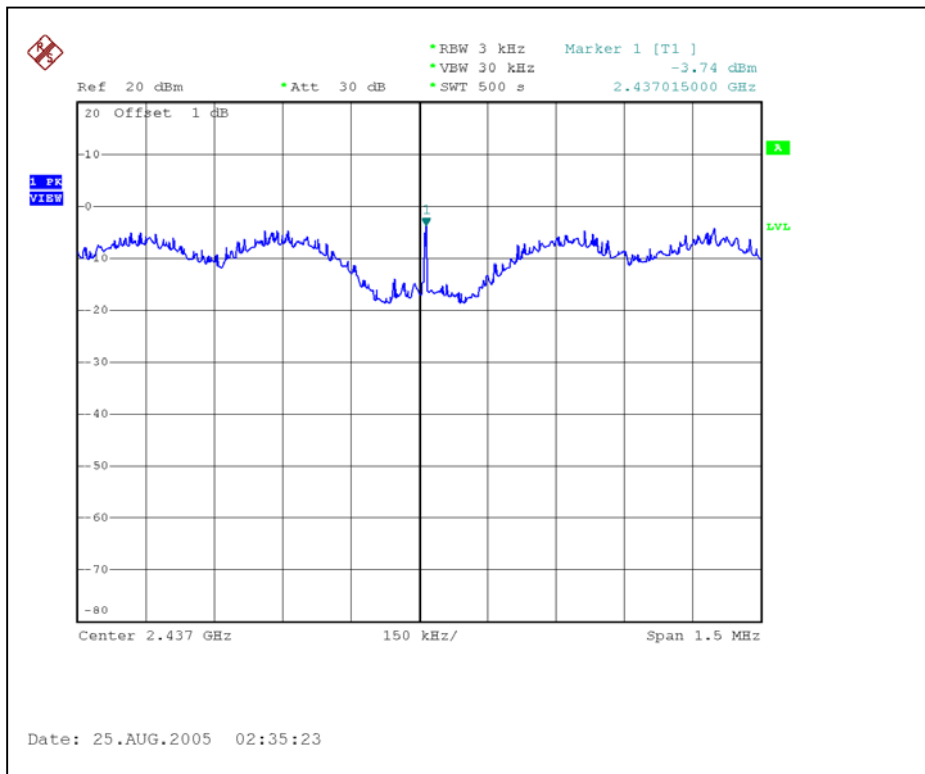



CH11

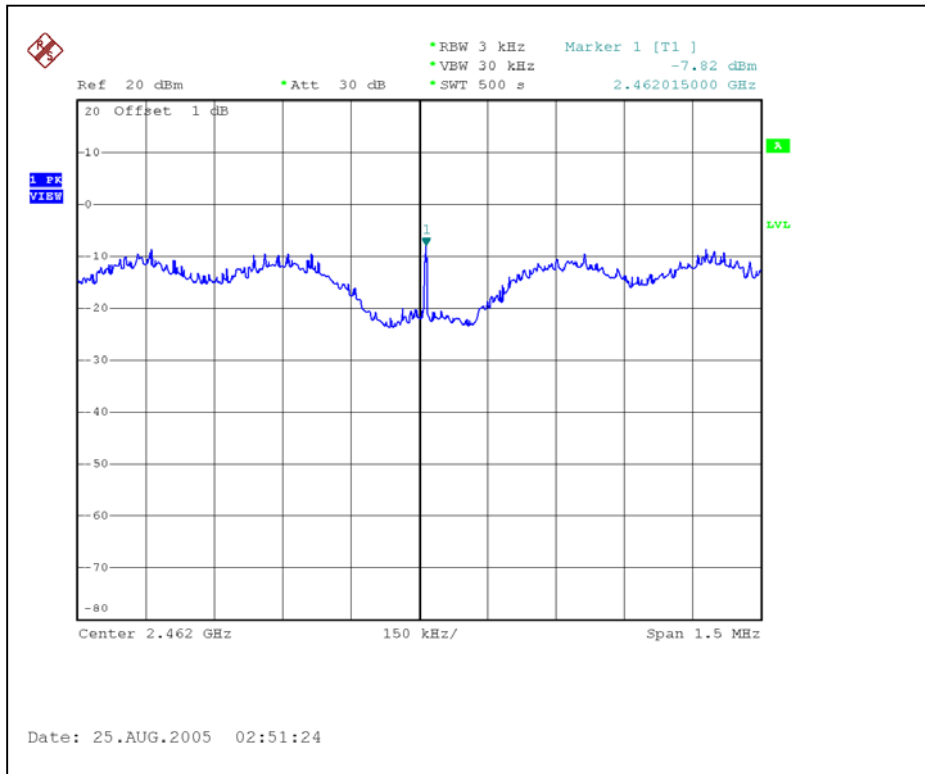



4.6 BAND EDGES MEASUREMENT

4.6.1 LIMITS OF BAND EDGES MEASUREMENT

Below -20dB of the highest emission level of operating band (in 1MHz Resolution Bandwidth).

4.6.2 TEST INSTRUMENTS

Description & Manufacturer	Model No.	Serial No.	Calibrated Until
R&S SPECTRUM ANALYZER	FSP40	100036	Nov. 23, 2005

NOTE:

- 1.The measurement uncertainty is less than $\pm 2.6\text{dB}$, which is calculated as per the NAMAS document NIS81.
- 2.The calibration interval of the above test instruments is 12 months and the calibrations are traceable to NML/ROC and NIST/USA.

4.6.3 TEST PROCEDURE

The transmitter output was connected to the spectrum analyzer via a low lose cable. Set RBW spectrum analyzer to 1 MHz and set VBW spectrum analyzer to 10 Hz with suitable frequency span including 1 MHz bandwidth from band edge. The band edges was measured and recorded.

The spectrum plots (Peak RBW=VBW=100kHz ; Average RBW=1MHz, VBW=10Hz) are attached on the following pages.

4.6.4 EUT OPERATING CONDITION

Same as Item 4.3.5



4.6.5 TEST RESULTS – DSSS

The spectrum plots are attached on the following page. D1 line indicates the highest level, D2 line indicates the 20dB offset below D1. It shows compliance with the requirement in part 15.247(C).

Note - The delta method is only used up to 2 MHz away from the restricted bandage, The radiated emissions which located in other restricted frequency band, the result, please refer to 4.2.

NOTE (Peak):

The band edge emission plot of DSSS technique on the following first page show 58.77dB delta between carrier maximum power and local maximum emission in restrict band (2.3900GHz). The emission of carrier strength list in the test result of channel 1 at the item 4.2 is 116.8dBuV/m, so the maximum field strength in restrict band is $116.8-58.77=58.03$ dBuV/m which is under 74 dBuV/m limit.

The band edge emission plot of DSSS technique on the following first page shows 53.14dB delta between carrier maximum power and local maximum emission in restrict band (2.4835GHz). The emission of carrier strength list in the test result of channel 11 at the item 4.2 is 114.9dBuV/m, so the maximum field strength in restrict band is $114.9-53.14=61.76$ dBuV/m which is under 74 dBuV/m limit.

NOTE (Average):

The band edge emission plot of DSSS technique on the following second page shows 58.55dB delta between carrier maximum power and local maximum emission in restrict band (2.3900GHz). The emission of carrier strength list in the test result of channel 1 at the item 4.2 is 109.5dBuV/m, so the maximum field strength in restrict band is $109.5-58.55=50.95$ dBuV/m which is under 54 dBuV/m limit.

The band edge emission plot of DSSS technique on the following second page shows 55.54dB delta between carrier maximum power and local maximum emission in restrict band (2.4835GHz). The emission of carrier strength list in the test result of channel 11 at the item 4.2 is 108.5dBuV/m, so the maximum field strength in restrict band is $108.5-55.54=52.96$ dBuV/m which is under 54 dBuV/m limit.

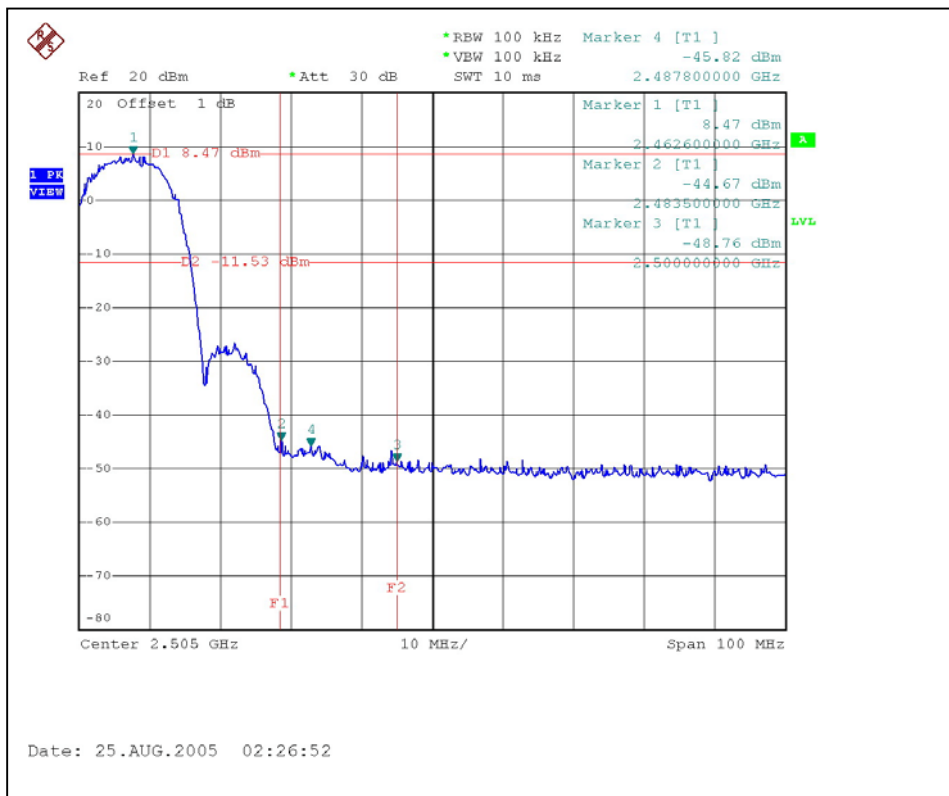
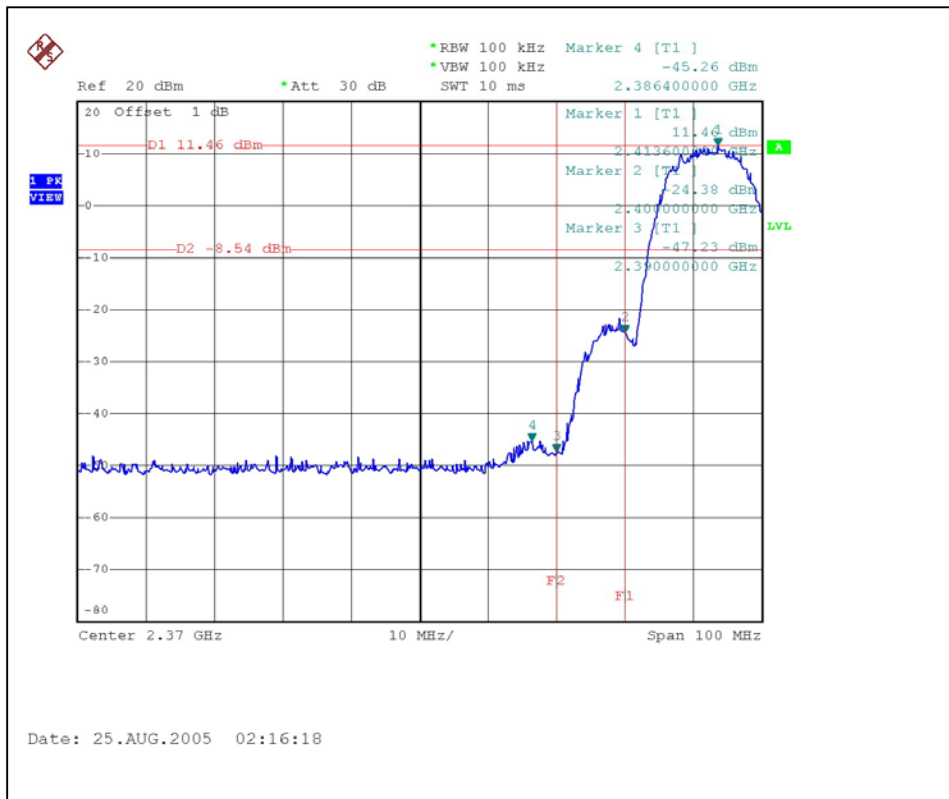

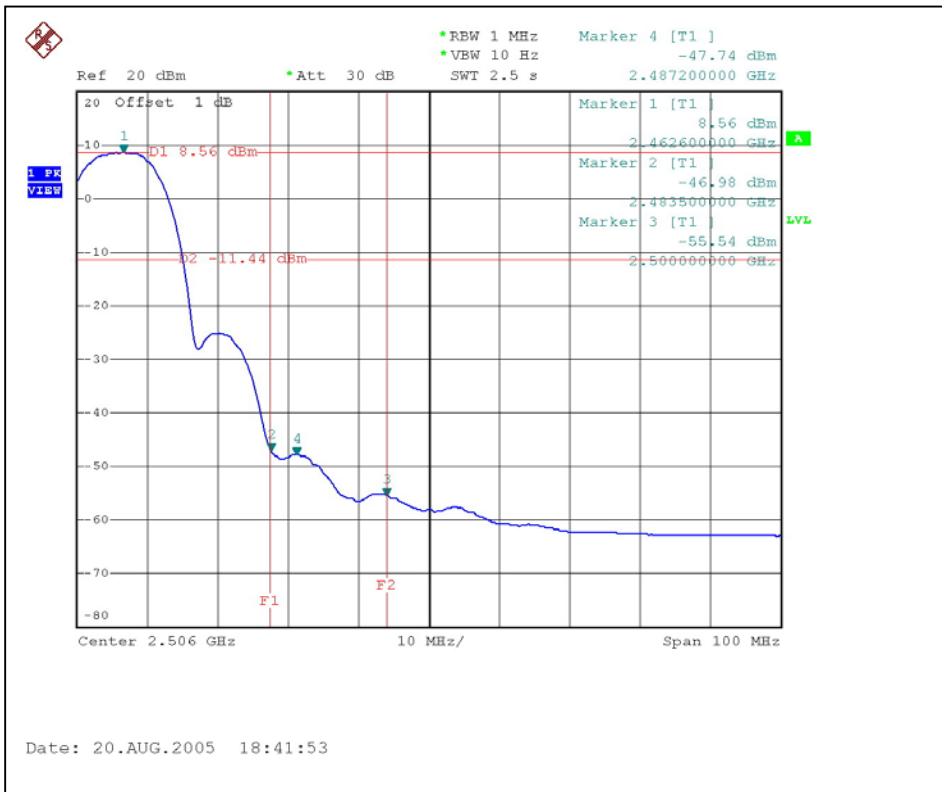
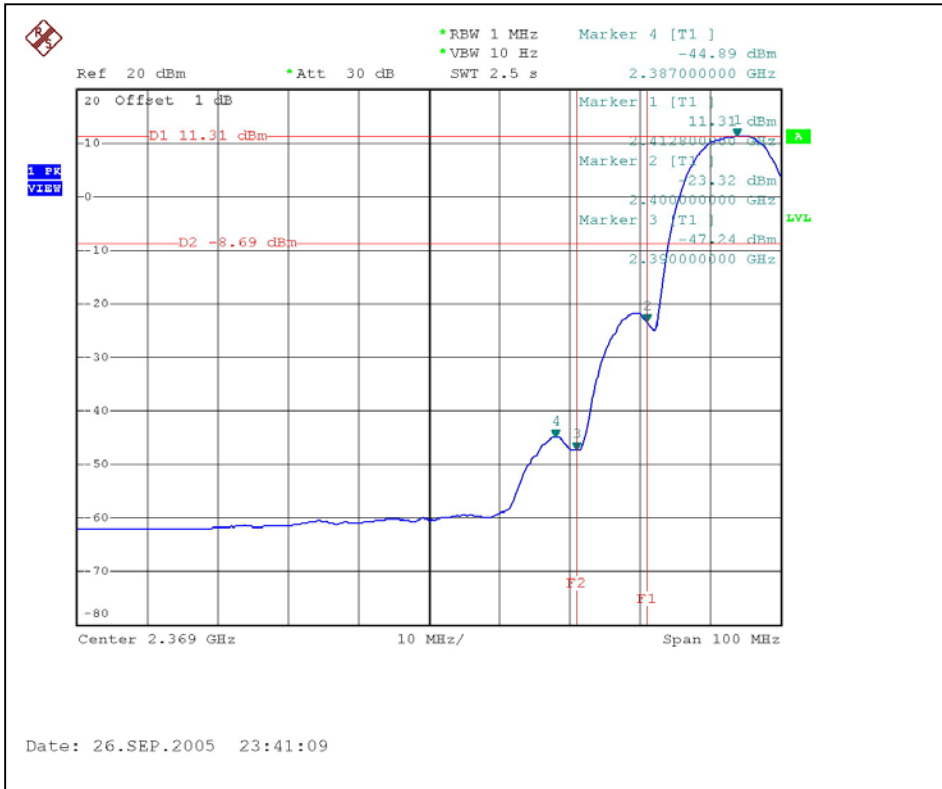

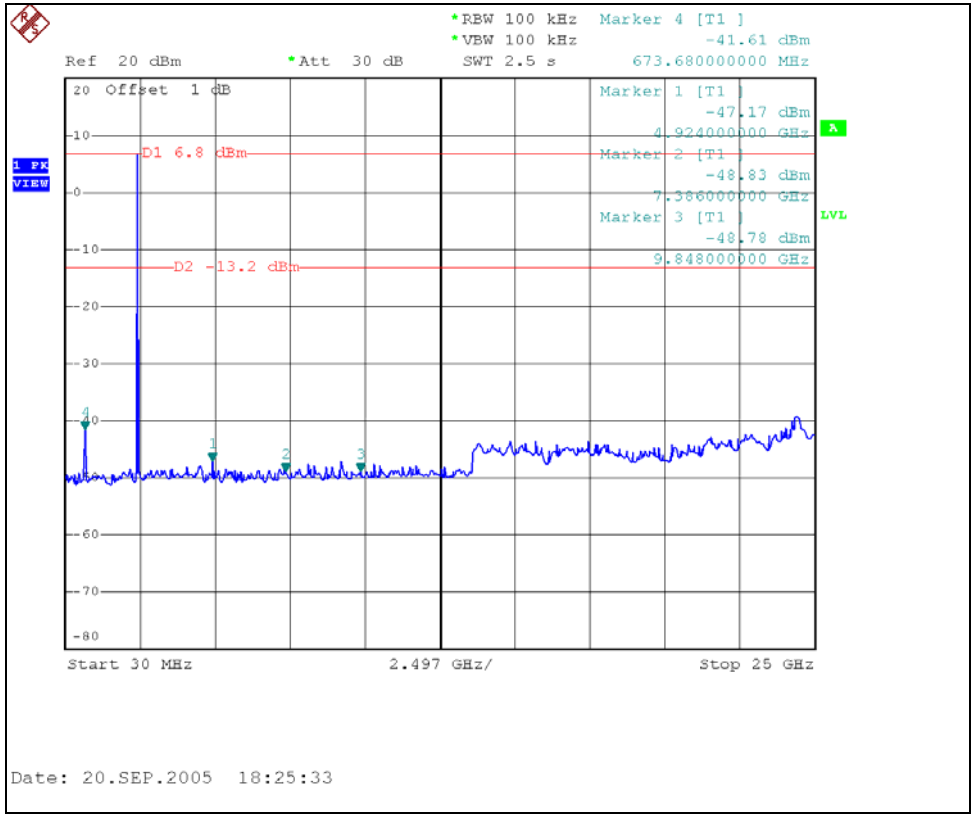
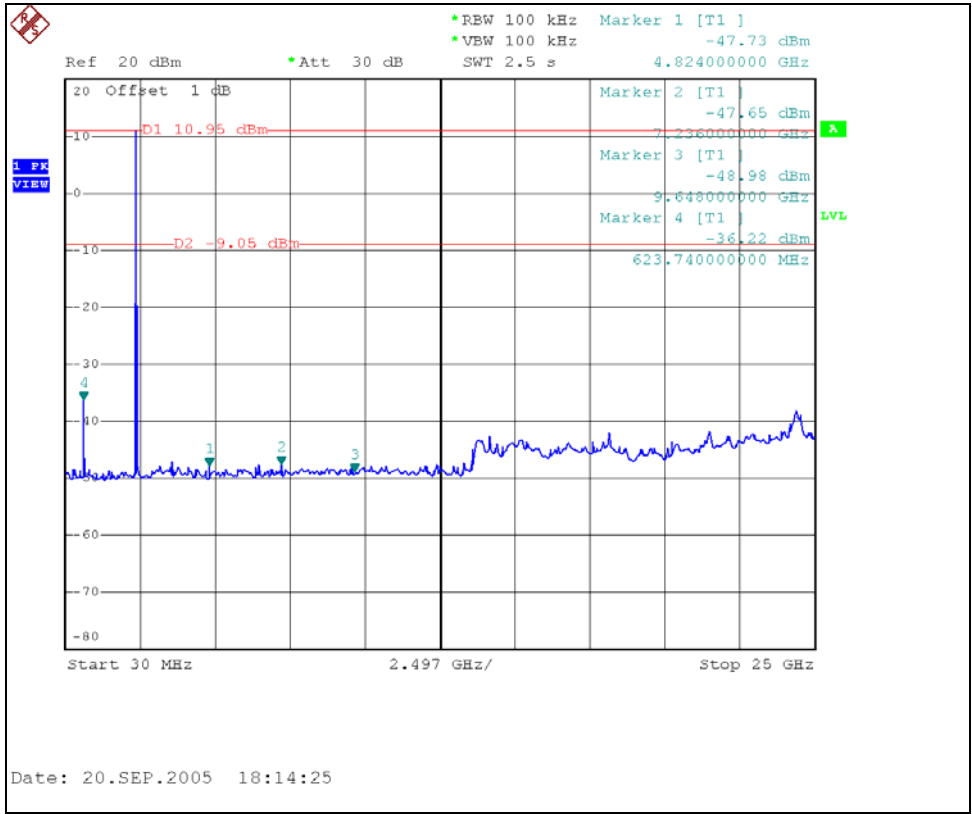



4.6.6 TEST RESULTS – OFDM

The spectrum plots are attached on the following page. D1 line indicates the highest level, D2 line indicates the 20dB offset below D1. It shows compliance with the requirement in part 15.247(C).

Note - The delta method is only used up to 2 MHz away from the restricted bandage, The radiated emissions which located in other restricted frequency band, the result, please refer to 4.2.

NOTE (Peak) :

The band edge emission plot of OFDM technique on the following first page show 48.32dB delta between carrier maximum power and local maximum emission in restrict band (2.3900GHz). The emission of carrier strength list in the test result of channel 1 at the item 4.2 is 113.7dBuV/m, so the maximum field strength in restrict band is $113.7-48.32=65.38$ dBuV/m which is under 74 dBuV/m limit.

The band edge emission plot of OFDM technique on the following first page shows 43.06dB delta between carrier maximum power and local maximum emission in restrict band (2.4835GHz). The emission of carrier strength list in the test result of channel 11 at the item 4.2 is 109.7dBuV/m, so the maximum field strength in restrict band is $109.7-43.06=66.64$ dBuV/m which is under 74 dBuV/m limit.

NOTE (Average):

The band edge emission plot of OFDM technique on the following second page shows 51.06dB delta between carrier maximum power and local maximum emission in restrict band (2.3900GHz). The emission of carrier strength list in the test result of channel 1 at the item 4.2 is 103.9dBuV/m, so the maximum field strength in restrict band is $103.9-51.06=52.84$ dBuV/m which is under 54 dBuV/m limit.

The band edge emission plot of OFDM technique on the following second page shows 47.35dB delta between carrier maximum power and local maximum emission in restrict band (2.4835GHz). The emission of carrier strength list in the test result of channel 11 at the item 4.2 is 100.3dBuV/m, so the maximum field strength in restrict band is $100.3-47.35=52.95$ dBuV/m which is under 54 dBuV/m limit.

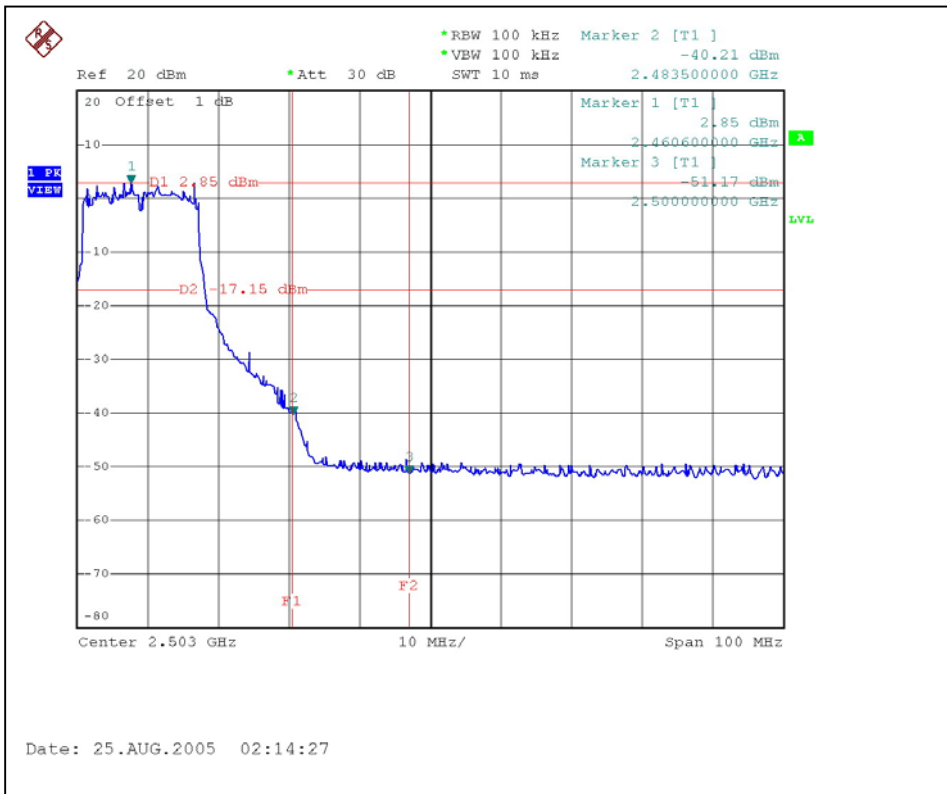
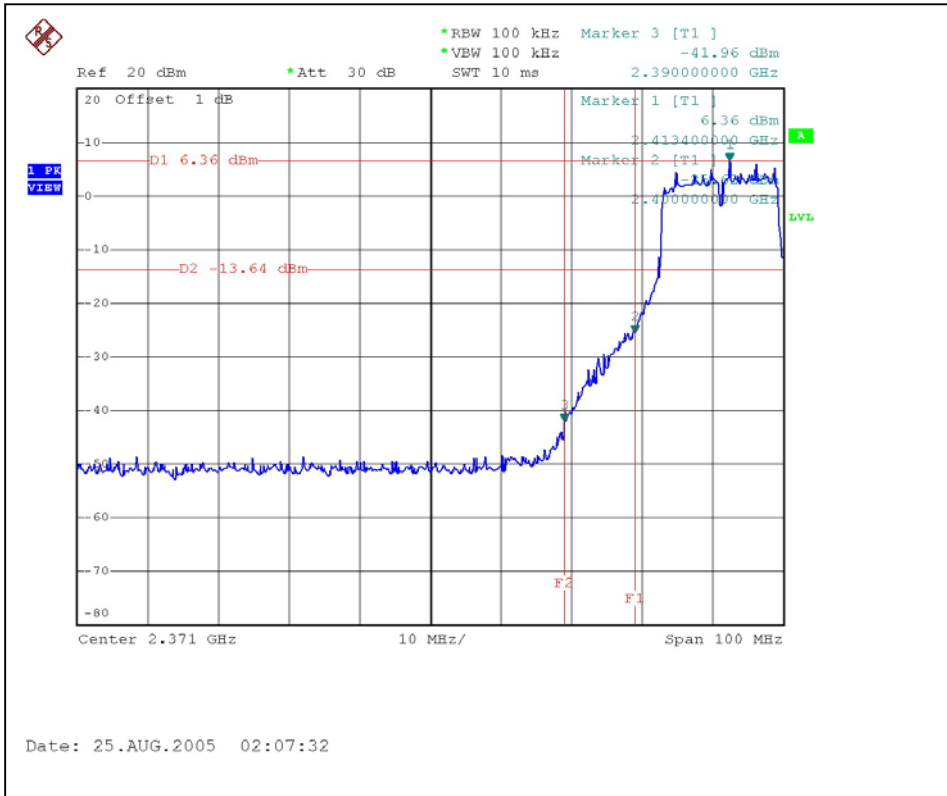

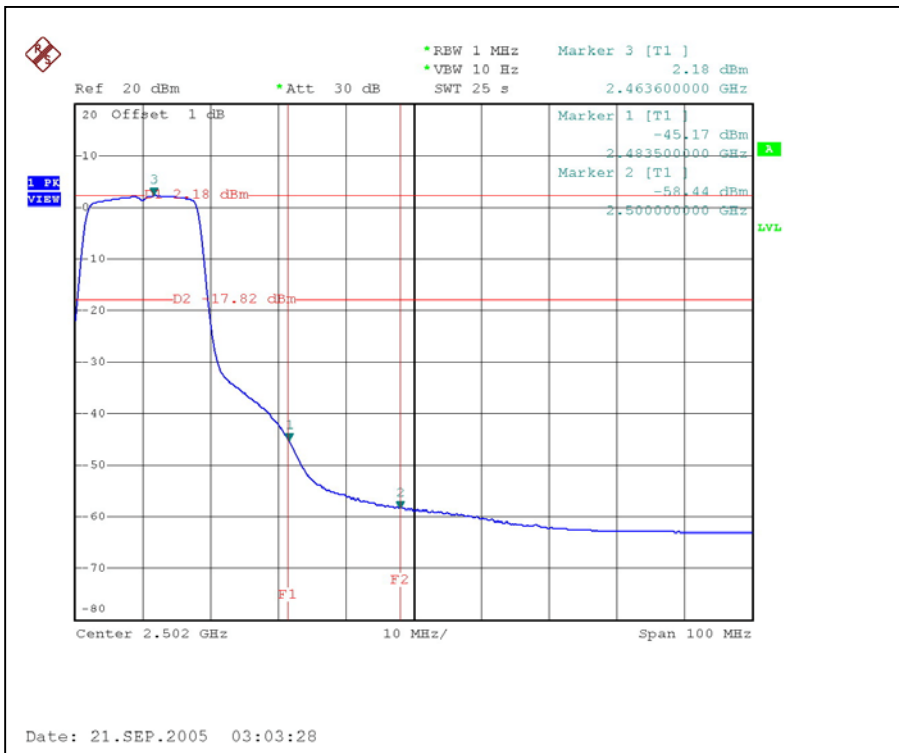
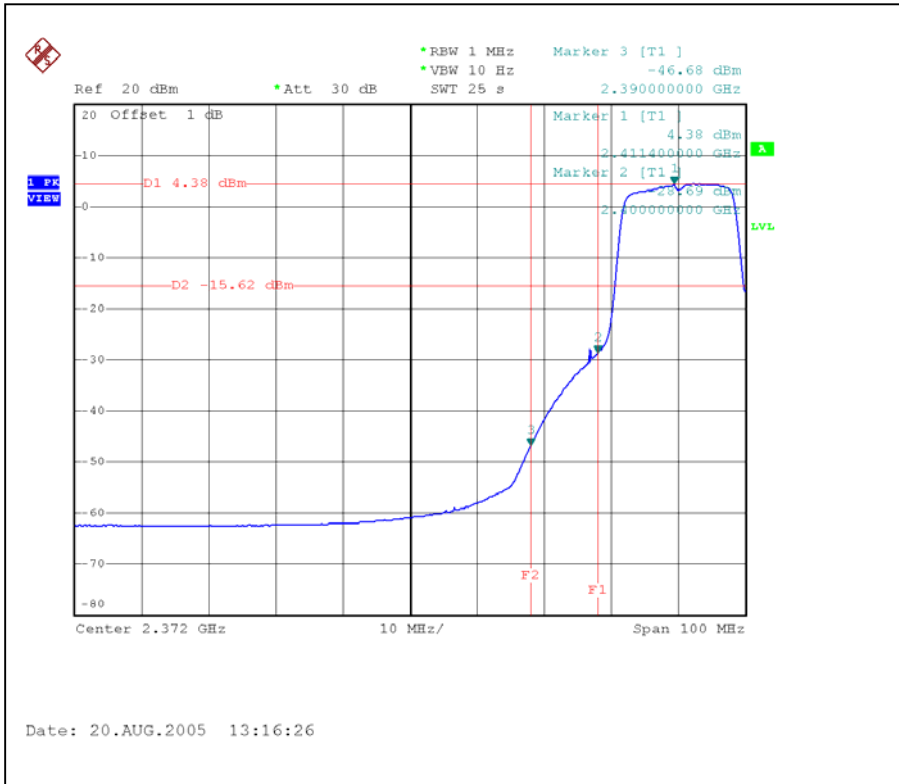

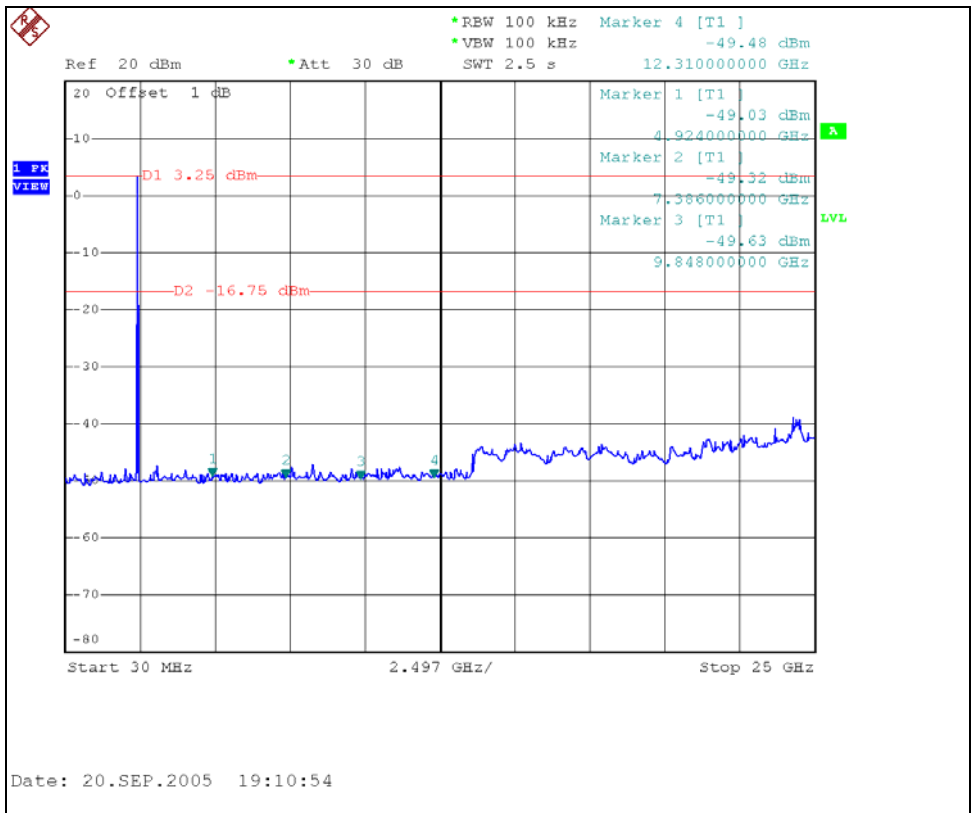
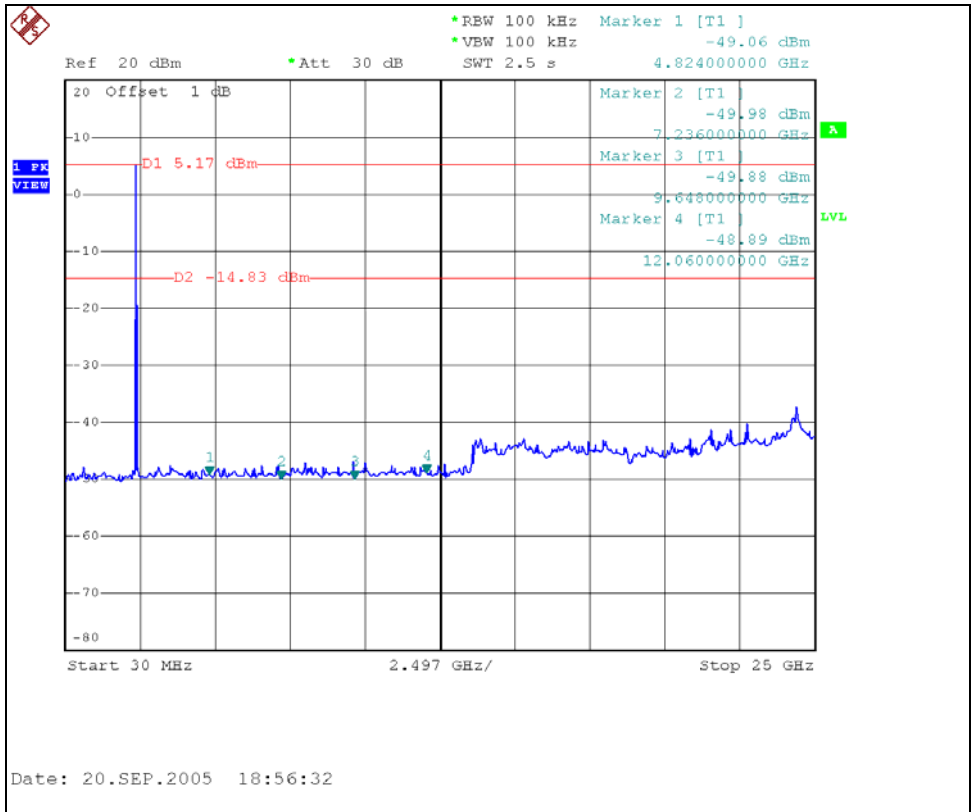



4.7 ANTENNA REQUIREMENT

4.7.1 STANDARD APPLICABLE

For intentional device, according to FCC 47 CFR Section 15.203, an intentional radiator shall be designed to ensure that no antenna other than that furnished by the responsible party shall be used with the device. And according to FCC 47 CFR Section 15.247 (b), if transmitting antennas of directional gain greater than 6dBi are used, the power shall be reduced by the amount in dB that the directional gain of the antenna exceeds 6dBi.

4.7.2 ANTENNA CONNECTED CONSTRUCTION

The antennas used in this product are as following:

Item	SPEC No.	Model No.	Product Description	Antenna Gain	Remark	Connector
1	NA	RBT4K-AG-IA	2.4-4.9/5.8 GHz, 8ft of cable RPSMA Indoor Antenna.	2dBi	Omni	RPSMA



5. TEST TYPES AND RESULTS (802.11a, 5725~5850MHz Band)

5.1 CONDUCTED EMISSION MEASUREMENT

5.1.1 LIMITS OF CONDUCTED EMISSION MEASUREMENT

FREQUENCY OF EMISSION (MHz)	CONDUCTED LIMIT (dB μ V)	
	Quasi-peak	Average
0.15-0.5	66 to 56	56 to 46
0.5-5	56	46
5-30	60	50

- NOTE:**
1. The lower limit shall apply at the transition frequencies.
 2. The limit decreases in line with the logarithm of the frequency in the range of 0.15 to 0.50 MHz.
 3. All emanations from a class A/B digital device or system, including any network of conductors and apparatus connected thereto, shall not exceed the level of field strengths specified above.

5.1.2 TEST INSTRUMENTS

DESCRIPTION & MANUFACTURER	MODEL NO.	SERIAL NO.	CALIBRATED UNTIL
ROHDE & SCHWARZ Test Receiver	ESCS 30	847124/029	Dec. 07, 2005
ROHDE & SCHWARZ LISN (for EUT)	ESHS-Z5	848773/004	Nov. 08, 2005
KYORITSU LISN (for peripheral)	KNW-407	8/1395/12	Jul. 19, 2006
RF Cable (JETBAO)	RG233/U	Cable_CA_01	Jul. 19, 2006
Terminator(for KYORITSU)	50	3	Oct. 12, 2005
Software	Cond-V2e	NA	NA

NOTE:

1. The calibration interval of the above test instruments is 12 months and the calibrations are traceable to NML/ROC and NIST/USA.
2. The test was performed in ADT Shielded Room No. A.
3. The VCCI Con A Registration No. is C-817.
4. The measurement uncertainty is 2.53 dB, which is calculated as per the document CISPR 16-4



5.1.3 TEST PROCEDURES

- a. The EUT was placed 0.4 meters from the conducting wall of the shielded room with EUT being connected to the power mains through a line impedance stabilization network (LISN). Other support units were connected to the power mains through another LISN. The two LISNs provide 50 ohm/ 50uH of coupling impedance for the measuring instrument.
- b. Both lines of the power mains connected to the EUT were checked for maximum conducted interference.
- c. The frequency range from 150kHz to 30MHz was searched. Emission levels under (Limit – 20dB) were not recorded.

5.1.4 DEVIATION FROM TEST STANDARD

No deviation

5.1.5 TEST SETUP

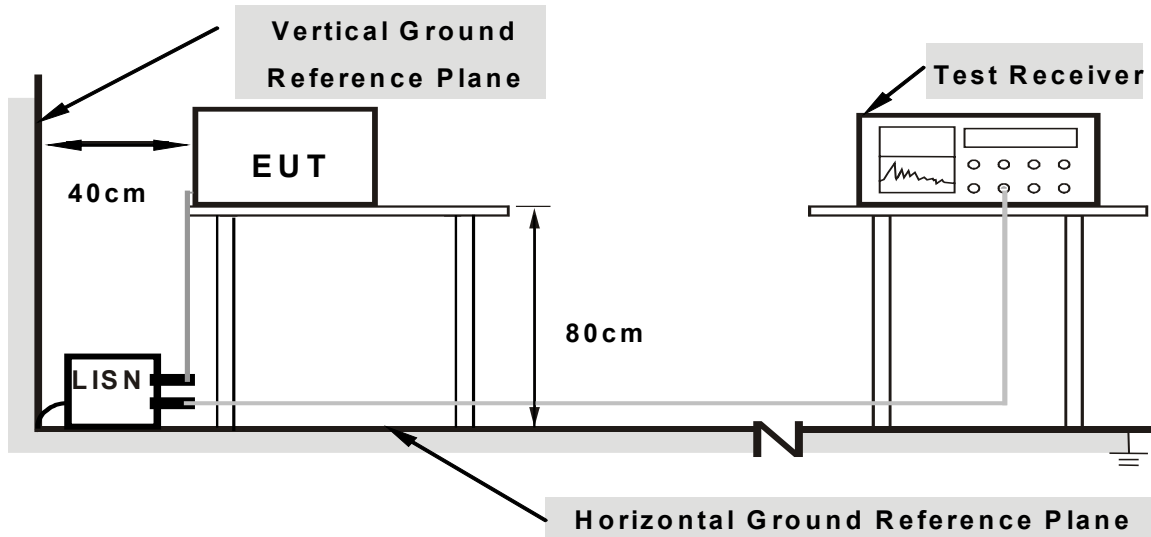

Note: 1. Support units were connected to second LISN.

2. Both of LISNs (AMN) are 80 cm from EUT and at least 80 from other units and other metal planes

For the actual test configuration, please refer to the related item – Photographs of the Test Configuration.

5.1.6 EUT OPERATING CONDITIONS

- a. Placed the EUT on the testing table.
- b. Prepared another computer system to act as a communication partner and placed it outside of testing area.
- c. The communication partner run test program “ART 48B5” to enable EUT under transmission/receiving condition continuously at specific channel frequency via UTP cable.



5.1.7 TEST RESULTS

Conducted Worst-Case Data

EUT	Multi-Channel Access Point	MODEL	RBT-4102
TEST MODE	With Adapter	6dB BANDWIDTH	9 kHz
MODULATION TYPE	BPSK	TRANSFER RATE	6Mbps
INPUT POWER (SYSTEM)	120Vac, 60 Hz	PHASE	Line (L)
ENVIRONMENTAL CONDITIONS	26deg. C, 63%RH, 961hPa	TESTED BY	Phoenix Huang

No	Freq. [MHz]	Corr. Factor (dB)	Reading Value		Emission Level		Limit		Margin	
			[dB (uV)]		[dB (uV)]		[dB (uV)]		(dB)	
			Q.P.	AV.	Q.P.	AV.	Q.P.	AV.	Q.P.	AV.
1	0.272	0.16	50.92	46.06	51.08	46.22	61.05	51.05	-9.97	-4.83
2	0.416	0.17	47.95	41.92	48.12	42.09	57.53	47.53	-9.41	-5.44
3	0.541	0.18	46.69	38.78	46.87	38.96	56.00	46.00	-9.13	-7.04
4	0.702	0.19	46.24	36.70	46.43	36.89	56.00	46.00	-9.57	-9.11
5	1.642	0.23	42.24	-	42.47	-	56.00	46.00	-13.53	-
6	4.465	0.47	42.30	-	42.77	-	56.00	46.00	-13.23	-

- REMARKS:**
1. Q.P. and AV. are abbreviations of quasi-peak and average individually.
 2. "-": The Quasi-peak reading value also meets average limit and measurement with the average detector is unnecessary.
 3. The emission levels of other frequencies were very low against the limit.
 4. Margin value = Emission level - Limit value
 5. Correction factor = Insertion loss + Cable loss
 6. Emission Level = Correction Factor + Reading Value.

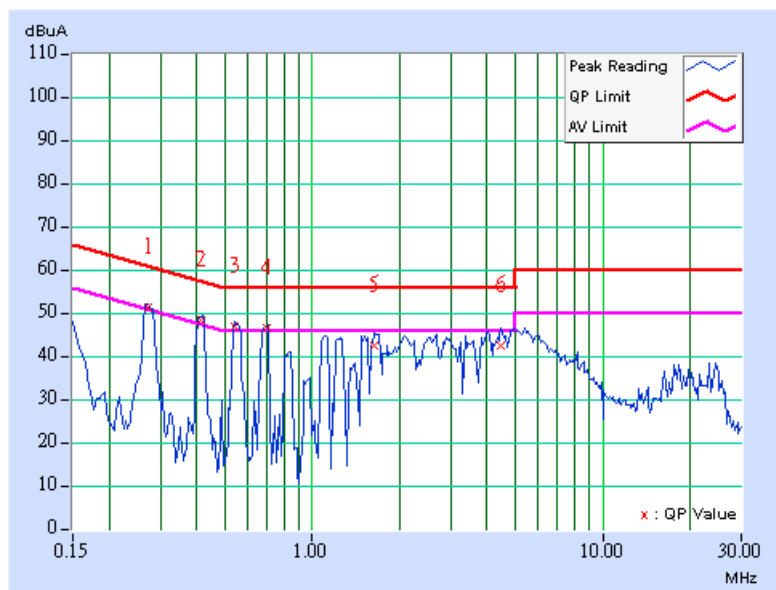



EUT	Multi-Channel Access Point	MODEL	RBT-4102
TEST MODE	With Adapter	6dB BANDWIDTH	9 kHz
MODULATION TYPE	BPSK	TRANSFER RATE	6Mbps
INPUT POWER (SYSTEM)	120Vac, 60 Hz	PHASE	Neutral (N)
ENVIRONMENTAL CONDITIONS	26deg. C, 63%RH, 961hPa	TESTED BY	Phoenix Huang

No	Freq. [MHz]	Corr. Factor (dB)	Reading Value [dB (uV)]		Emission Level [dB (uV)]		Limit [dB (uV)]		Margin (dB)	
			Q.P.	AV.	Q.P.	AV.	Q.P.	AV.	Q.P.	AV.
			1	0.271	0.16	50.89	-	51.05	-	61.09
2	0.418	0.17	47.26	-	47.43	-	57.48	47.48	-10.05	-
3	0.546	0.18	46.61	38.09	46.79	38.27	56.00	46.00	-9.21	-7.73
4	0.675	0.18	44.99	-	45.17	-	56.00	46.00	-10.83	-
5	4.023	0.45	41.90	-	42.35	-	56.00	46.00	-13.65	-
6	4.670	0.47	43.70	-	44.17	-	56.00	46.00	-11.83	-

- REMARKS:**
1. Q.P. and AV. are abbreviations of quasi-peak and average individually.
 2. "-": The Quasi-peak reading value also meets average limit and measurement with the average detector is unnecessary.
 3. The emission levels of other frequencies were very low against the limit.
 4. Margin value = Emission level - Limit value
 5. Correction factor = Insertion loss + Cable loss
 6. Emission Level = Correction Factor + Reading Value.

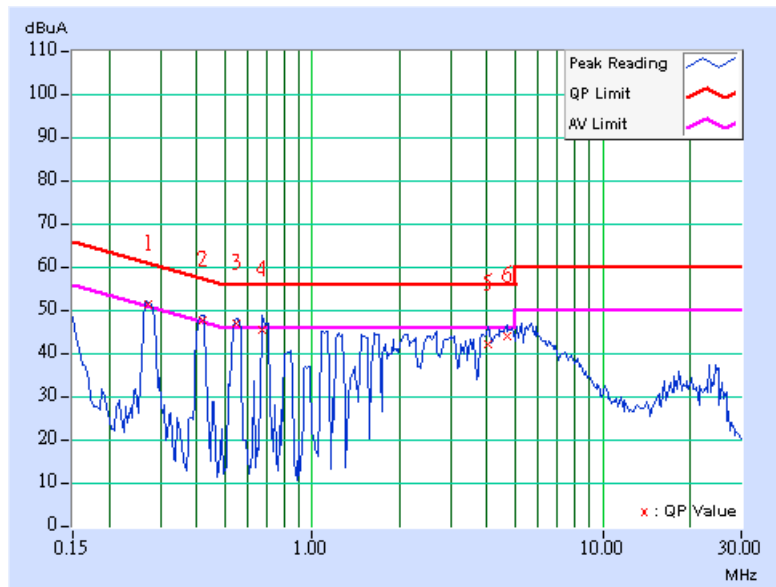



EUT	Multi-Channel Access Point	MODEL	RBT-4102
TEST MODE	With POE	6dB BANDWIDTH	9 kHz
MODULATION TYPE	BPSK	TRANSFER RATE	6Mbps
INPUT POWER (SYSTEM)	120Vac, 60 Hz	PHASE	Line (L)
ENVIRONMENTAL CONDITIONS	26deg. C, 63%RH, 961hPa	TESTED BY	Phoenix Huang

No	Freq. [MHz]	Corr. Factor (dB)	Reading Value		Emission Level		Limit		Margin	
			[dB (uV)]		[dB (uV)]		[dB (uV)]		(dB)	
			Q.P.	AV.	Q.P.	AV.	Q.P.	AV.	Q.P.	AV.
1	0.399	0.17	38.79	-	38.96	-	57.88	47.88	-18.92	-
2	0.998	0.20	37.69	-	37.89	-	56.00	46.00	-18.11	-
3	1.195	0.21	40.68	-	40.89	-	56.00	46.00	-15.11	-
4	2.056	0.26	37.49	-	37.75	-	56.00	46.00	-18.25	-
5	2.252	0.28	38.42	-	38.70	-	56.00	46.00	-17.30	-
6	17.694	1.17	46.44	-	47.61	-	60.00	50.00	-12.39	-

- REMARKS:**
1. Q.P. and AV. are abbreviations of quasi-peak and average individually.
 2. "-": The Quasi-peak reading value also meets average limit and measurement with the average detector is unnecessary.
 3. The emission levels of other frequencies were very low against the limit.
 4. Margin value = Emission level - Limit value
 5. Correction factor = Insertion loss + Cable loss
 6. Emission Level = Correction Factor + Reading Value.

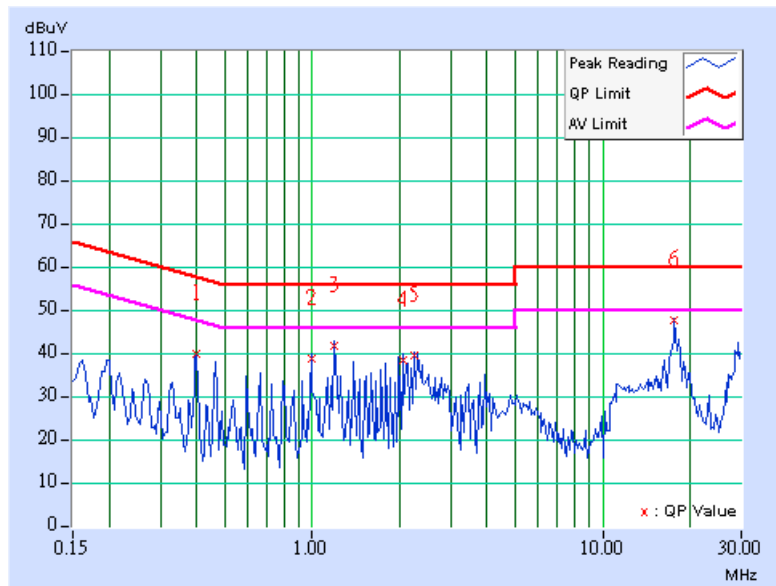



EUT	Multi-Channel Access Point	MODEL	RBT-4102
TEST MODE	With POE	6dB BANDWIDTH	9 kHz
MODULATION TYPE	BPSK	TRANSFER RATE	6Mbps
INPUT POWER (SYSTEM)	120Vac, 60 Hz	PHASE	Neutral (N)
ENVIRONMENTAL CONDITIONS	26deg. C, 63%RH, 961hPa	TESTED BY	Phoenix Huang

No	Freq. [MHz]	Corr. Factor (dB)	Reading Value		Emission Level		Limit		Margin	
			[dB (uV)]		[dB (uV)]		[dB (uV)]		(dB)	
			Q.P.	AV.	Q.P.	AV.	Q.P.	AV.	Q.P.	AV.
1	0.399	0.17	39.79	-	39.96	-	57.88	47.88	-17.92	-
2	0.598	0.18	34.50	-	34.68	-	56.00	46.00	-21.32	-
3	1.196	0.21	40.51	-	40.72	-	56.00	46.00	-15.28	-
4	1.989	0.25	36.92	-	37.17	-	56.00	46.00	-18.83	-
5	4.773	0.48	35.30	-	35.78	-	56.00	46.00	-20.22	-
6	17.695	1.02	45.81	-	46.83	-	60.00	50.00	-13.17	-

- REMARKS:**
1. Q.P. and AV. are abbreviations of quasi-peak and average individually.
 2. "-": The Quasi-peak reading value also meets average limit and measurement with the average detector is unnecessary.
 3. The emission levels of other frequencies were very low against the limit.
 4. Margin value = Emission level - Limit value
 5. Correction factor = Insertion loss + Cable loss
 6. Emission Level = Correction Factor + Reading Value.

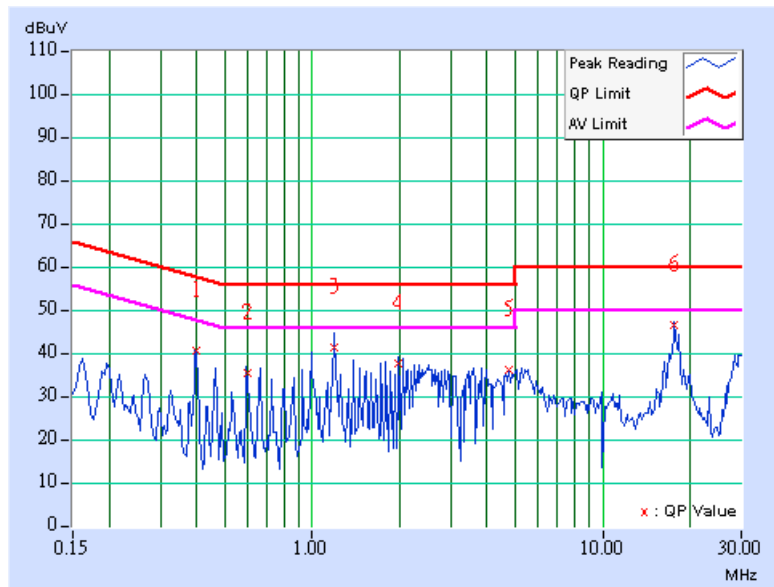



5.2 RADIATED EMISSION MEASUREMENT

5.2.1 LIMITS OF RADIATED EMISSION MEASUREMENT

Emissions radiated outside of the specified bands, shall be according to the general radiated limits in 15.209 as following:

Frequencies (MHz)	Field strength (microvolts/meter)	Measurement distance (meters)
0.009-0.490	2400/F(kHz)	300
0.490-1.705	24000/F(kHz)	30
1.705-30.0	30	30
30-88	100	3
88-216	150	3
216-960	200	3
Above 960	500	3

NOTE:

1. The lower limit shall apply at the transition frequencies.
2. Emission level (dBuV/m) = 20 log Emission level (uV/m).
3. As shown in 15.35(b), for frequencies above 1000MHz, the field strength limits are based on average detector, however, the peak field strength of any emission shall not exceed the maximum permitted average limits, specified above by more than 20dB under any condition of modulation.



5.2.2 TEST INSTRUMENTS

DESCRIPTION & MANUFACTURER	MODEL NO.	SERIAL NO.	CALIBRATED UNTIL
ADVANTEST Spectrum Analyzer	R3271A	85060311	July 07, 2006
HP Pre_Amplifier	8449B	3008A01922	Oct. 13, 2005
ROHDE & SCHWARZ Test Receiver	ESCS30	100287	Dec. 08, 2005
CHASE Broadband Antenna	VULB9168	138	Dec. 21, 2005
Schwarzbeck Horn_Antenna	BBHA9120	D124	Dec. 11, 2005
Schwarzbeck Horn_Antenna	BBHA 9170	BBHA9170153	Jan. 30, 2006
SCHWARZBECK Biconical Antenna	VHBA9123	459	Jun. 26, 2006
SCHWARZBECK Periodic Antenna	UPA6108	1148	Jun. 26, 2006
RF Switches (ARNITSU)	CS-201	1565157	NA
RF CABLE (Chaintek) 1GHz-20GHz	SF102	22054-2	Nov. 15. 2005
RF Cable(RICHTEC)	9913-30M	STCCAB-30M- 1GHz-021	Jul. 16, 2006
Software	ADT_Radiated_V 5.14	NA	NA
CHANCE MOST Antenna Tower	AT-100	0203	NA
CHANCE MOST Turn Table	TT-100	0203	NA

- Note: 1. The calibration interval of the above test instruments is 12 months (36 months for Tunable Periodic Antenna) and the calibrations are traceable to NML/ROC and NIST/USA.
2. The horn antenna and HP preamplifier (model: 8449B) are used only for the measurement of emission frequency above 1GHz if tested.
3. The test was performed in ADT Open Site No. C.
4. The FCC Site Registration No. is 656396.
5. The VCCI Site Registration No. is R-1626.
6. The CANADA Site Registration No. is IC 4824-3.
7. The following table is for the measurement uncertainty, which is calculated as per the document CISPR 16-4.

Measurement	Value
Radiated emissions (30MHz-1GHz)	2.98 dB
Radiated emissions (1GHz ~18GHz)	2.21 dB
Radiated emissions (18GHz ~20GHz)	1.88 dB



5.2.3 TEST PROCEDURES

- a. The EUT was placed on the top of a rotating table 0.8 meters above the ground at a 3 meter semi-anechoic chamber. The table was rotated 360 degrees to determine the position of the highest radiation.
- b. The EUT was set 3 meters away from the interference-receiving antenna, which was mounted on the top of a variable-height antenna tower.
- c. The antenna is a broadband antenna, and its height is varied from one meter to four meters above the ground to determine the maximum value of the field strength. Both horizontal and vertical polarizations of the antenna are set to make the measurement.
- d. For each suspected emission, the EUT was arranged to its worst case and then the antenna was tuned to heights from 1 meter to 4 meters and the rotatable table was turned from 0 degrees to 360 degrees to find the maximum reading.
- e. The test-receiver system was set to Peak Detect Function and Specified Bandwidth with Maximum Hold Mode.
- f. If the emission level of the EUT in peak mode was 10dB lower than the limit specified, then testing could be stopped and the peak values of the EUT would be reported. Otherwise the emissions that did not have 10dB margin would be re-tested one by one using peak, quasi-peak or average method as specified and then reported in a data sheet.

NOTE:

1. The resolution bandwidth and video bandwidth of test receiver/spectrum analyzer is 120kHz for Peak detection (PK) and Quasi-peak detection (QP) at frequency below 1GHz.
2. The resolution bandwidth and video bandwidth of test receiver/spectrum analyzer is 1 MHz for Peak detection at frequency above 1GHz.
3. The resolution bandwidth of test receiver/spectrum analyzer is 1 MHz and the video bandwidth is 10 Hz for Average detection (AV) at frequency above 1GHz.

5.2.4 DEVIATION FROM TEST STANDARD

No deviation

5.2.5 TEST SETUP

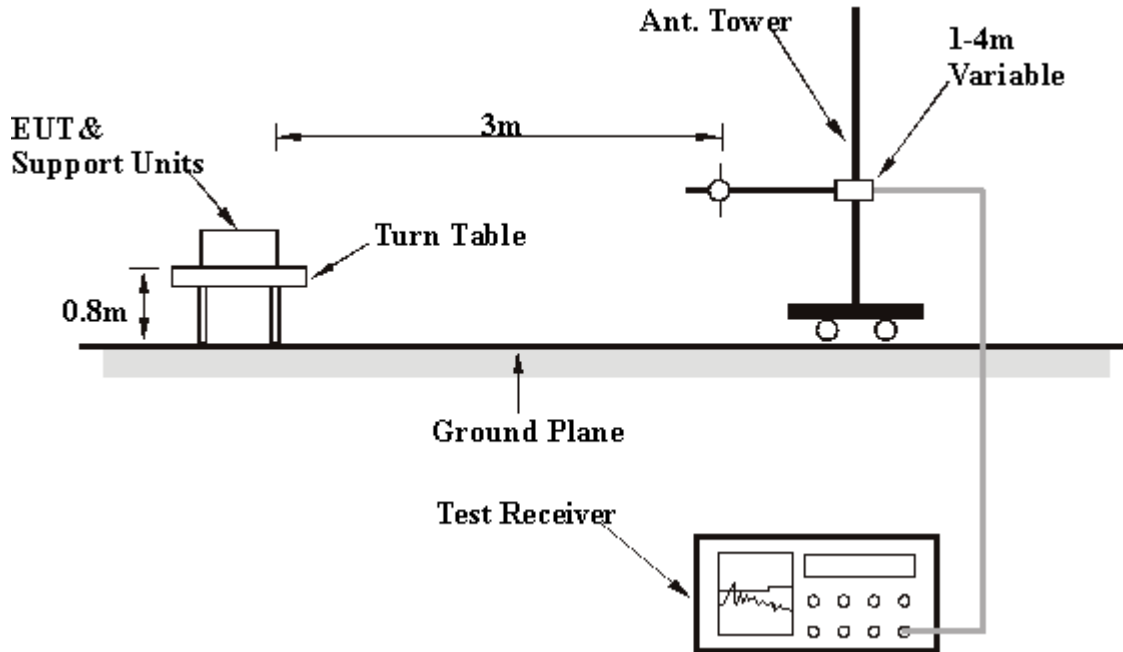

For the actual test configuration, please refer to the related item – Photographs of the Test Configuration.

5.2.6 EUT OPERATING CONDITIONS

Same as 4.1.6



5.2.7 TEST RESULTS (ANTENNA 1)

Below 1GHz Worst-Case Data

EUT	Multi-Channel Access Point	MODEL	RBT-4102
TEST MODE	With Adapter	FREQUENCY RANGE	Below 1000MHz
MODULATION TYPE	BPSK	TRANSFER RATE	6Mbps
INPUT POWER (SYSTEM)	120Vac, 60 Hz	DETECTOR FUNCTION	Quasi-Peak
ENVIRONMENTAL CONDITIONS	28deg. C, 55%RH, 961hPa	TESTED BY	Wen Yu

ANTENNA POLARITY & TEST DISTANCE: HORIZONTAL AT 3 M

No.	Freq. (MHz)	Emission Level (dBuV/m)	Limit (dBuV/m)	Margin (dB)	Antenna Height (m)	Table Angle (Degree)	Raw Value (dBuV)	Correction Factor (dB/m)
1	125.00	16.10 QP	43.50	-27.40	1.62 H	12	4.20	11.90
2	150.00	20.50 QP	43.50	-23.00	1.59 H	133	7.10	13.40
3	200.00	23.40 QP	43.50	-20.10	1.52 H	162	12.20	11.20
4	250.00	22.90 QP	46.00	-23.10	1.47 H	217	9.60	13.30
5	375.00	24.80 QP	46.00	-21.20	1.42 H	109	7.20	17.60
6	400.00	26.90 QP	46.00	-19.10	1.39 H	128	8.50	18.40
7	500.00	31.10 QP	46.00	-14.90	1.31 H	256	10.20	20.90
8	625.00	25.50 QP	46.00	-20.50	1.26 H	318	1.70	23.80
9	825.00	30.10 QP	46.00	-15.90	1.12 H	336	3.10	27.00
10	990.00	34.90 QP	54.00	-19.10	1.00 H	29	6.00	28.90

ANTENNA POLARITY & TEST DISTANCE: VERTICAL AT 3 M

No.	Freq. (MHz)	Emission Level (dBuV/m)	Limit (dBuV/m)	Margin (dB)	Antenna Height (m)	Table Angle (Degree)	Raw Value (dBuV)	Correction Factor (dB/m)
1	125.00	23.70 QP	43.50	-19.80	1.00 V	37	11.80	11.90
2	150.00	27.60 QP	43.50	-15.90	1.00 V	225	14.20	13.40
3	200.00	29.90 QP	43.50	-13.60	1.00 V	310	18.70	11.20
4	250.00	25.70 QP	46.00	-20.30	1.00 V	205	12.40	13.30
5	375.00	25.90 QP	46.00	-20.10	1.00 V	283	8.30	17.60
6	400.00	26.70 QP	46.00	-19.30	1.00 V	215	8.30	18.40
7	500.00	31.10 QP	46.00	-14.90	1.04 V	339	10.20	20.90
8	625.00	27.80 QP	46.00	-18.20	1.05 V	45	4.00	23.80
9	825.00	29.60 QP	46.00	-16.40	1.07 V	48	2.60	27.00
10	990.00	38.80 QP	54.00	-15.20	1.16 V	312	9.90	28.90

- REMARKS:**
1. Emission level(dBuV/m)=Raw Value(dBuV) + Correction Factor(dB/m)
 2. Correction Factor(dB/m) = Antenna Factor (dB/m) + Cable Factor (dB)
 3. The other emission levels were very low against the limit.
 4. Margin value = Emission level – Limit value



Below 1GHz Worst-Case Data

EUT	Multi-Channel Access Point	MODEL	RBT-4102
TEST MODE	With POE	FREQUENCY RANGE	Below 1000MHz
MODULATION TYPE	BPSK	TRANSFER RATE	6Mbps
INPUT POWER (SYSTEM)	120Vac, 60 Hz	DETECTOR FUNCTION	Quasi-Peak
ENVIRONMENTAL CONDITIONS	28deg. C, 55%RH, 961hPa	TESTED BY	Wen Yu

ANTENNA POLARITY & TEST DISTANCE: HORIZONTAL AT 3 M

No.	Freq. (MHz)	Emission Level (dBuV/m)	Limit (dBuV/m)	Margin (dB)	Antenna Height (m)	Table Angle (Degree)	Raw Value (dBuV)	Correction Factor (dB/m)
1	125.00	15.70 QP	43.50	-27.80	1.66 H	0	3.80	11.90
2	150.00	21.10 QP	43.50	-22.40	1.60 H	315	7.70	13.40
3	200.00	23.70 QP	43.50	-19.80	1.58 H	38	12.50	11.20
4	250.00	23.80 QP	46.00	-22.20	1.49 H	107	10.50	13.30
5	375.00	25.10 QP	46.00	-20.90	1.40 H	92	7.50	17.60
6	400.00	25.60 QP	46.00	-20.40	1.32 H	156	7.20	18.40
7	500.00	30.10 QP	46.00	-15.90	1.27 H	229	9.20	20.90
8	625.00	26.80 QP	46.00	-19.20	1.21 H	207	3.00	23.80
9	825.00	30.70 QP	46.00	-15.30	1.12 H	133	3.70	27.00
10	990.00	35.40 QP	54.00	-18.60	1.00 H	128	6.50	28.90

ANTENNA POLARITY & TEST DISTANCE: VERTICAL AT 3 M

No.	Freq. (MHz)	Emission Level (dBuV/m)	Limit (dBuV/m)	Margin (dB)	Antenna Height (m)	Table Angle (Degree)	Raw Value (dBuV)	Correction Factor (dB/m)
1	125.00	24.40 QP	43.50	-19.10	1.10 V	15	12.50	11.90
2	150.00	23.60 QP	43.50	-19.90	1.00 V	28	10.20	13.40
3	200.00	33.90 QP	43.50	-9.60	1.00 V	33	22.70	11.20
4	250.00	25.80 QP	46.00	-20.20	1.00 V	145	12.50	13.30
5	375.00	24.30 QP	46.00	-21.70	1.00 V	197	6.70	17.60
6	400.00	25.60 QP	46.00	-20.40	1.00 V	283	7.20	18.40
7	500.00	28.90 QP	46.00	-17.10	1.03 V	165	8.00	20.90
8	625.00	29.10 QP	46.00	-16.90	1.06 V	290	5.30	23.80
9	825.00	32.20 QP	46.00	-13.80	1.10 V	217	5.20	27.00
10	990.00	36.70 QP	54.00	-17.30	1.17 V	115	7.80	28.90

- REMARKS:**
1. Emission level(dBuV/m)=Raw Value(dBuV) + Correction Factor(dB/m)
 2. Correction Factor(dB/m) = Antenna Factor (dB/m) + Cable Factor (dB)
 3. The other emission levels were very low against the limit.
 4. Margin value = Emission level – Limit value



802.11a OFDM modulation

EUT	Multi-Channel Access Point	MODEL	RBT-4102
CHANNEL	Channel 1	FREQUENCY RANGE	1 ~ 40 GHz
MODULATION TYPE	BPSK	TRANSFER RATE	6Mbps
INPUT POWER (SYSTEM)	120Vac, 60 Hz	DETECTOR FUNCTION	Peak(PK) Average (AV)
ENVIRONMENTAL CONDITIONS	27deg. C, 70%RH, 961hPa	TESTED BY	Wen Yu

ANTENNA POLARITY & TEST DISTANCE: HORIZONTAL AT 3 M

No.	Freq. (MHz)	Emission Level (dBuV/m)	Limit (dBuV/m)	Margin (dB)	Antenna Height (m)	Table Angle (Degree)	Raw Value (dBuV)	Correction Factor (dB/m)
1	#3899.00	45.00 PK	74.00	-29.00	1.26 H	126	11.40	33.70
1	#3899.00	32.00 AV	54.00	-22.00	1.26 H	126	-1.60	33.70
2	#4798.00	45.60 PK	74.00	-28.40	1.32 H	125	9.50	36.10
2	#4798.00	32.50 AV	54.00	-21.50	1.32 H	125	-3.60	36.10
3	*5745.00	122.00 PK			1.00 H	270	84.40	37.60
3	*5745.00	111.50 AV			1.00 H	270	73.90	37.60
4	#11490.00	60.50 PK	74.00	-13.50	1.00 H	195	9.20	51.30
4	#11490.00	48.00 AV	54.00	-6.00	1.00 H	195	-3.30	51.30

ANTENNA POLARITY & TEST DISTANCE: VERTICAL AT 3 M

No.	Freq. (MHz)	Emission Level (dBuV/m)	Limit (dBuV/m)	Margin (dB)	Antenna Height (m)	Table Angle (Degree)	Raw Value (dBuV)	Correction Factor (dB/m)
1	#3899.00	43.80 PK	74.00	-30.20	1.30 V	12	10.20	33.70
1	#3899.00	31.00 AV	54.00	-23.00	1.30 V	12	-2.60	33.70
2	#4798.00	44.00 PK	74.00	-30.00	1.60 V	311	7.90	36.10
2	#4798.00	31.80 AV	54.00	-22.20	1.60 V	311	-4.30	36.10
3	*5745.00	110.30 PK			1.42 V	265	72.70	37.60
3	*5745.00	99.90 AV			1.42 V	265	62.30	37.60
4	#11490.00	62.70 PK	74.00	-11.30	1.64 V	85	11.40	51.30
4	#11490.00	49.20 AV	54.00	-4.80	1.64 V	85	-2.10	51.30

- NOTE:**
1. Emission level(dBuV/m)=Raw Value(dBuV) + Correction Factor(dB/m)
 2. Correction Factor(dB/m) = Antenna Factor (dB/m) + Cable Factor (dB)
 3. The other emission levels were very low against the limit.
 4. Margin value = Emission level – Limit value
 5. "*" : Fundamental frequency
 6. "#"The radiated frequency falling in the restricted band.
 7. The limit value is defined as per 15.247



EUT	Multi-Channel Access Point	MODEL	RBT-4102
CHANNEL	Channel 3	FREQUENCY RANGE	1 ~ 40 GHz
MODULATION TYPE	BPSK	TRANSFER RATE	6Mbps
INPUT POWER (SYSTEM)	120Vac, 60 Hz	DETECTOR FUNCTION	Peak(PK) Average (AV)
ENVIRONMENTAL CONDITIONS	27deg. C, 70%RH, 961hPa	TESTED BY	Wen Yu

ANTENNA POLARITY & TEST DISTANCE: HORIZONTAL AT 3 M

No.	Freq. (MHz)	Emission Level (dBuV/m)	Limit (dBuV/m)	Margin (dB)	Antenna Height (m)	Table Angle (Degree)	Raw Value (dBuV)	Correction Factor (dB/m)
1	#3948.00	45.20 PK	74.00	-28.80	1.28 H	122	11.50	33.80
1	#3948.00	31.70 AV	54.00	-22.30	1.28 H	122	-2.00	33.80
2	#4847.00	45.90 PK	74.00	-28.10	1.31 H	130	9.50	36.30
2	#4847.00	32.70 AV	54.00	-21.30	1.31 H	130	-3.70	36.30
3	*5785.00	121.40 PK			1.01 H	277	83.80	37.60
3	*5785.00	111.00 AV			1.01 H	277	73.40	37.60
4	#11570.00	62.60 PK	74.00	-11.40	1.04 H	195	11.50	51.10
4	#11570.00	49.60 AV	54.00	-4.40	1.04 H	195	-1.50	51.10

ANTENNA POLARITY & TEST DISTANCE: VERTICAL AT 3 M

No.	Freq. (MHz)	Emission Level (dBuV/m)	Limit (dBuV/m)	Margin (dB)	Antenna Height (m)	Table Angle (Degree)	Raw Value (dBuV)	Correction Factor (dB/m)
1	#3948.00	44.10 PK	74.00	-29.90	1.35 V	13	10.40	33.80
1	#3948.00	31.20 AV	54.00	-22.80	1.35 V	13	-2.50	33.80
2	#4847.00	44.50 PK	74.00	-29.50	1.61 V	320	8.10	36.30
2	#4847.00	32.20 AV	54.00	-21.80	1.61 V	320	-4.20	36.30
3	*5785.00	109.50 PK			1.41 V	280	71.90	37.60
3	*5785.00	98.90 AV			1.41 V	280	61.30	37.60
4	#11570.00	65.70 PK	74.00	-8.30	1.46 V	86	14.60	51.10
4	#11570.00	51.50 AV	54.00	-2.50	1.46 V	86	0.40	51.10

- NOTE:**
1. Emission level(dBuV/m)=Raw Value(dBuV) + Correction Factor(dB/m)
 2. Correction Factor(dB/m) = Antenna Factor (dB/m) + Cable Factor (dB)
 3. The other emission levels were very low against the limit.
 4. Margin value = Emission level – Limit value
 5. “*” : Fundamental frequency
 6. “#”The radiated frequency falling in the restricted band.
 7. The limit value is defined as per 15.247



EUT	Multi-Channel Access Point	MODEL	RBT-4102
CHANNEL	Channel 5	FREQUENCY RANGE	1 ~ 40 GHz
MODULATION TYPE	BPSK	TRANSFER RATE	6Mbps
INPUT POWER (SYSTEM)	120Vac, 60 Hz	DETECTOR FUNCTION	Peak(PK) Average (AV)
ENVIRONMENTAL CONDITIONS	27deg. C, 70%RH, 961hPa	TESTED BY	Wen Yu

ANTENNA POLARITY & TEST DISTANCE: HORIZONTAL AT 3 M

No.	Freq. (MHz)	Emission Level (dBuV/m)	Limit (dBuV/m)	Margin (dB)	Antenna Height (m)	Table Angle (Degree)	Raw Value (dBuV)	Correction Factor (dB/m)
1	#3988.00	45.00 PK	74.00	-29.00	1.22 H	127	11.20	33.80
1	#3988.00	32.20 AV	54.00	-21.80	1.22 H	127	-1.60	33.80
2	#4878.00	45.90 PK	74.00	-28.10	1.30 H	141	9.40	36.50
2	#4878.00	32.70 AV	54.00	-21.30	1.30 H	141	-3.80	36.50
3	*5825.00	121.10 PK			1.00 H	27	83.40	37.70
3	*5825.00	110.60 AV			1.00 H	27	72.90	37.70
4	#11650.00	65.00 PK	74.00	-9.00	1.00 H	195	14.20	50.80
4	#11650.00	50.90 AV	54.00	-3.10	1.00 H	195	0.10	50.80

ANTENNA POLARITY & TEST DISTANCE: VERTICAL AT 3 M

No.	Freq. (MHz)	Emission Level (dBuV/m)	Limit (dBuV/m)	Margin (dB)	Antenna Height (m)	Table Angle (Degree)	Raw Value (dBuV)	Correction Factor (dB/m)
1	#3988.00	44.50 PK	74.00	-29.50	1.33 V	16	10.70	33.80
1	#3988.00	31.50 AV	54.00	-22.50	1.33 V	16	-2.30	33.80
2	#4878.00	44.80 PK	74.00	-29.20	1.59 V	315	8.30	36.50
2	#4878.00	32.40 AV	54.00	-21.60	1.59 V	315	-4.10	36.50
3	*5825.00	109.20 PK			1.41 V	276	71.50	37.70
3	*5825.00	98.90 AV			1.41 V	276	61.20	37.70
4	#11650.00	67.00 PK	74.00	-7.00	1.45 V	85	16.20	50.80
4	#11650.00	53.00 AV	54.00	-1.00	1.45 V	85	2.20	50.80

- NOTE:**
1. Emission level(dBuV/m)=Raw Value(dBuV) + Correction Factor(dB/m)
 2. Correction Factor(dB/m) = Antenna Factor (dB/m) + Cable Factor (dB)
 3. The other emission levels were very low against the limit.
 4. Margin value = Emission level – Limit value
 5. "*" : Fundamental frequency
 6. "#"The radiated frequency falling in the restricted band.
 7. The limit value is defined as per 15.247

5.2.8 TEST RESULTS (ANTENNA 2)

Below 1GHz Worst-Case Data

EUT	Multi-Channel Access Point	MODEL	RBT-4102
TEST MODE	With Adapter	FREQUENCY RANGE	Below 1000MHz
MODULATION TYPE	BPSK	TRANSFER RATE	6Mbps
INPUT POWER (SYSTEM)	120Vac, 60 Hz	DETECTOR FUNCTION	Quasi-Peak
ENVIRONMENTAL CONDITIONS	28deg. C, 55%RH, 961hPa	TESTED BY	Wen Yu

ANTENNA POLARITY & TEST DISTANCE: HORIZONTAL AT 3 M

No.	Freq. (MHz)	Emission Level (dBuV/m)	Limit (dBuV/m)	Margin (dB)	Antenna Height (m)	Table Angle (Degree)	Raw Value (dBuV)	Correction Factor (dB/m)
1	125.00	15.70 QP	43.50	-27.80	1.77 H	149	3.80	11.90
2	150.00	19.80 QP	43.50	-23.70	1.65 H	256	6.40	13.40
3	200.00	23.40 QP	43.50	-20.10	1.66 H	108	12.20	11.20
4	250.00	22.70 QP	46.00	-23.30	1.34 H	227	9.40	13.30
5	375.00	24.40 QP	46.00	-21.60	1.58 H	1	6.80	17.60
6	400.00	26.80 QP	46.00	-19.20	1.22 H	19	8.40	18.40
7	500.00	31.10 QP	46.00	-14.90	1.17 H	20	10.20	20.90
8	625.00	25.70 QP	46.00	-20.30	1.15 H	28	1.90	23.80
9	825.00	29.80 QP	46.00	-16.20	1.03 H	225	2.80	27.00
10	990.00	34.50 QP	54.00	-19.50	1.00 H	216	5.60	28.90

ANTENNA POLARITY & TEST DISTANCE: VERTICAL AT 3 M

No.	Freq. (MHz)	Emission Level (dBuV/m)	Limit (dBuV/m)	Margin (dB)	Antenna Height (m)	Table Angle (Degree)	Raw Value (dBuV)	Correction Factor (dB/m)
1	125.00	23.10 QP	43.50	-20.40	1.00 V	317	11.20	11.90
2	150.00	27.50 QP	43.50	-16.00	1.00 V	128	14.10	13.40
3	200.00	29.70 QP	43.50	-13.80	1.00 V	336	18.50	11.20
4	250.00	25.80 QP	46.00	-20.20	1.00 V	45	12.50	13.30
5	375.00	25.80 QP	46.00	-20.20	1.00 V	146	8.20	17.60
6	400.00	26.50 QP	46.00	-19.50	1.00 V	215	8.10	18.40
7	500.00	31.20 QP	46.00	-14.80	1.03 V	223	10.30	20.90
8	625.00	27.90 QP	46.00	-18.10	1.09 V	209	4.10	23.80
9	825.00	29.50 QP	46.00	-16.50	1.23 V	158	2.50	27.00
10	990.00	38.70 QP	54.00	-15.30	1.43 V	317	9.80	28.90

- REMARKS:**
1. Emission level(dBuV/m)=Raw Value(dBuV) + Correction Factor(dB/m)
 2. Correction Factor(dB/m) = Antenna Factor (dB/m) + Cable Factor (dB)
 3. The other emission levels were very low against the limit.
 4. Margin value = Emission level – Limit value



Below 1GHz Worst-Case Data

EUT	Multi-Channel Access Point	MODEL	RBT-4102
TEST MODE	With POE	FREQUENCY RANGE	Below 1000MHz
MODULATION TYPE	BPSK	TRANSFER RATE	6Mbps
INPUT POWER (SYSTEM)	120Vac, 60 Hz	DETECTOR FUNCTION	Quasi-Peak
ENVIRONMENTAL CONDITIONS	28deg. C, 55%RH, 961hPa	TESTED BY	Wen Yu

ANTENNA POLARITY & TEST DISTANCE: HORIZONTAL AT 3 M

No.	Freq. (MHz)	Emission Level (dBuV/m)	Limit (dBuV/m)	Margin (dB)	Antenna Height (m)	Table Angle (Degree)	Raw Value (dBuV)	Correction Factor (dB/m)
1	125.00	15.70 QP	43.50	-27.80	1.67 H	168	3.80	11.90
2	150.00	20.20 QP	43.50	-23.30	1.56 H	196	6.80	13.40
3	200.00	23.90 QP	43.50	-19.60	1.58 H	128	12.70	11.20
4	250.00	23.20 QP	46.00	-22.80	1.47 H	144	9.90	13.30
5	375.00	24.90 QP	46.00	-21.10	1.31 H	39	7.30	17.60
6	400.00	25.80 QP	46.00	-20.20	1.25 H	42	7.40	18.40
7	500.00	29.20 QP	46.00	-16.80	1.18 H	358	8.30	20.90
8	625.00	26.70 QP	46.00	-19.30	1.09 H	335	2.90	23.80
9	825.00	30.60 QP	46.00	-15.40	1.01 H	320	3.60	27.00
10	990.00	35.50 QP	54.00	-18.50	1.00 H	317	6.60	28.90

ANTENNA POLARITY & TEST DISTANCE: VERTICAL AT 3 M

No.	Freq. (MHz)	Emission Level (dBuV/m)	Limit (dBuV/m)	Margin (dB)	Antenna Height (m)	Table Angle (Degree)	Raw Value (dBuV)	Correction Factor (dB/m)
1	125.00	24.60 QP	43.50	-18.90	1.00 V	126	12.70	11.90
2	150.00	23.20 QP	43.50	-20.30	1.00 V	122	9.80	13.40
3	200.00	33.80 QP	43.50	-9.70	1.00 V	167	22.60	11.20
4	250.00	25.20 QP	46.00	-20.80	1.00 V	158	11.90	13.30
5	375.00	24.10 QP	46.00	-21.90	1.01 V	211	6.50	17.60
6	400.00	25.20 QP	46.00	-20.80	1.03 V	236	6.80	18.40
7	500.00	28.30 QP	46.00	-17.70	1.04 V	256	7.40	20.90
8	625.00	28.70 QP	46.00	-17.30	1.12 V	217	4.90	23.80
9	825.00	32.10 QP	46.00	-13.90	1.31 V	156	5.10	27.00
10	990.00	36.60 QP	54.00	-17.40	1.49 V	336	7.70	28.90

- REMARKS:**
1. Emission level(dBuV/m)=Raw Value(dBuV) + Correction Factor(dB/m)
 2. Correction Factor(dB/m) = Antenna Factor (dB/m) + Cable Factor (dB)
 3. The other emission levels were very low against the limit.
 4. Margin value = Emission level – Limit value

**802.11a OFDM modulation**

EUT	Multi-Channel Access Point	MODEL	RBT-4102
CHANNEL	Channel 1	FREQUENCY RANGE	1 ~ 40 GHz
MODULATION TYPE	BPSK	TRANSFER RATE	6Mbps
INPUT POWER (SYSTEM)	120Vac, 60 Hz	DETECTOR FUNCTION	Peak(PK) Average (AV)
ENVIRONMENTAL CONDITIONS	27deg. C, 64%RH, 961hPa	TESTED BY	Rex Huang

ANTENNA POLARITY & TEST DISTANCE: HORIZONTAL AT 3 M

No.	Freq. (MHz)	Emission Level (dBuV/m)	Limit (dBuV/m)	Margin (dB)	Antenna Height (m)	Table Angle (Degree)	Raw Value (dBuV)	Correction Factor (dB/m)
1	#3899.00	38.60 PK	74.00	-35.40	1.10 H	242	5.50	33.10
1	#3899.00	29.10 AV	54.00	-24.90	1.10 H	242	-4.00	33.10
2	#4798.00	43.20 PK	74.00	-30.80	1.45 H	7	8.20	35.00
2	#4798.00	30.90 AV	54.00	-23.10	1.45 H	7	-4.10	35.00
3	*5745.00	107.80 PK			1.00 H	358	71.40	36.40
3	*5745.00	97.70 AV			1.00 H	358	61.30	36.40
4	#11490.00	62.80 PK	74.00	-11.20	1.12 H	6	11.70	51.10
4	#11490.00	48.50 AV	54.00	-5.50	1.12 H	6	-2.60	51.10

ANTENNA POLARITY & TEST DISTANCE: VERTICAL AT 3 M

No.	Freq. (MHz)	Emission Level (dBuV/m)	Limit (dBuV/m)	Margin (dB)	Antenna Height (m)	Table Angle (Degree)	Raw Value (dBuV)	Correction Factor (dB/m)
1	#3899.00	49.80 PK	74.00	-24.20	1.05 V	23	16.70	33.10
1	#3899.00	39.80 AV	54.00	-14.20	1.05 V	23	6.70	33.10
2	#4798.00	50.90 PK	74.00	-23.10	1.08 V	13	15.90	35.00
2	#4798.00	41.40 AV	54.00	-12.60	1.08 V	13	6.40	35.00
3	*5745.00	131.70 PK			1.00 V	360	95.30	36.40
3	*5745.00	121.10 AV			1.00 V	360	84.70	36.40
4	#11490.00	63.20 PK	74.00	-10.80	1.35 V	15	12.10	51.10
4	#11490.00	48.00 AV	54.00	-6.00	1.35 V	15	-3.10	51.10

- NOTE:**
1. Emission level(dBuV/m)=Raw Value(dBuV) + Correction Factor(dB/m)
 2. Correction Factor(dB/m) = Antenna Factor (dB/m) + Cable Factor (dB)
 3. The other emission levels were very low against the limit.
 4. Margin value = Emission level – Limit value
 5. "*" : Fundamental frequency
 6. "#"The radiated frequency falling in the restricted band.
 7. The limit value is defined as per 15.247



EUT	Multi-Channel Access Point	MODEL	RBT-4102
CHANNEL	Channel 3	FREQUENCY RANGE	1 ~ 40 GHz
MODULATION TYPE	BPSK	TRANSFER RATE	6Mbps
INPUT POWER (SYSTEM)	120Vac, 60 Hz	DETECTOR FUNCTION	Peak(PK) Average (AV)
ENVIRONMENTAL CONDITIONS	27deg. C, 64%RH, 961hPa	TESTED BY	Rex Huang

ANTENNA POLARITY & TEST DISTANCE: HORIZONTAL AT 3 M

No.	Freq. (MHz)	Emission Level (dBuV/m)	Limit (dBuV/m)	Margin (dB)	Antenna Height (m)	Table Angle (Degree)	Raw Value (dBuV)	Correction Factor (dB/m)
1	#3899.00	38.50 PK	74.00	-35.50	1.39 H	11	5.40	33.10
1	#3899.00	28.80 AV	54.00	-25.20	1.39 H	11	-4.30	33.10
2	#4847.00	41.40 PK	74.00	-32.60	1.04 H	29	6.20	35.20
2	#4847.00	31.90 AV	54.00	-22.10	1.04 H	29	-3.30	35.20
3	*5785.00	110.60 PK			1.00 H	358	74.10	36.50
3	*5785.00	98.20 AV			1.00 H	358	61.70	36.50
4	#11570.00	62.30 PK	74.00	-11.70	1.14 H	5	11.40	50.90
4	#11570.00	48.10 AV	54.00	-5.90	1.14 H	5	-2.80	50.90

ANTENNA POLARITY & TEST DISTANCE: VERTICAL AT 3 M

No.	Freq. (MHz)	Emission Level (dBuV/m)	Limit (dBuV/m)	Margin (dB)	Antenna Height (m)	Table Angle (Degree)	Raw Value (dBuV)	Correction Factor (dB/m)
1	#3899.00	50.60 PK	74.00	-23.40	1.12 V	3	17.50	33.10
1	#3899.00	38.70 AV	54.00	-15.30	1.12 V	3	5.60	33.10
2	#4847.00	52.40 PK	74.00	-21.60	1.19 V	2	17.20	35.20
2	#4847.00	41.80 AV	54.00	-12.20	1.19 V	2	6.60	35.20
3	*5785.00	131.30 PK			1.00 V	2	94.80	36.50
3	*5785.00	121.40 AV			1.00 V	2	84.90	36.50
4	#11570.00	62.90 PK	74.00	-11.10	1.38 V	357	12.00	50.90
4	#11570.00	48.70 AV	54.00	-5.30	1.38 V	357	-2.20	50.90

- NOTE:**
1. Emission level(dBuV/m)=Raw Value(dBuV) + Correction Factor(dB/m)
 2. Correction Factor(dB/m) = Antenna Factor (dB/m) + Cable Factor (dB)
 3. The other emission levels were very low against the limit.
 4. Margin value = Emission level – Limit value
 5. "*" : Fundamental frequency
 6. "#"The radiated frequency falling in the restricted band.
 7. The limit value is defined as per 15.247



EUT	Multi-Channel Access Point	MODEL	RBT-4102
CHANNEL	Channel 5	FREQUENCY RANGE	1 ~ 40 GHz
MODULATION TYPE	BPSK	TRANSFER RATE	6Mbps
INPUT POWER (SYSTEM)	120Vac, 60 Hz	DETECTOR FUNCTION	Peak(PK) Average (AV)
ENVIRONMENTAL CONDITIONS	27deg. C, 64%RH, 961hPa	TESTED BY	Rex Huang

ANTENNA POLARITY & TEST DISTANCE: HORIZONTAL AT 3 M

No.	Freq. (MHz)	Emission Level (dBuV/m)	Limit (dBuV/m)	Margin (dB)	Antenna Height (m)	Table Angle (Degree)	Raw Value (dBuV)	Correction Factor (dB/m)
1	#3899.00	50.40 PK	74.00	-23.60	1.55 H	23	17.30	33.10
1	#3899.00	39.20 AV	54.00	-14.80	1.55 H	23	6.10	33.10
2	#4878.00	41.30 PK	74.00	-32.70	1.29 H	25	6.00	35.30
2	#4878.00	30.70 AV	54.00	-23.30	1.29 H	25	-4.60	35.30
3	*5825.00	108.80 PK			1.00 H	359	72.20	36.60
3	*5825.00	98.70 AV			1.00 H	359	62.10	36.60
4	#11650.00	62.10 PK	74.00	-11.90	1.08 H	8	11.50	50.60
4	#11650.00	48.40 AV	54.00	-5.60	1.08 H	8	-2.20	50.60

ANTENNA POLARITY & TEST DISTANCE: VERTICAL AT 3 M

No.	Freq. (MHz)	Emission Level (dBuV/m)	Limit (dBuV/m)	Margin (dB)	Antenna Height (m)	Table Angle (Degree)	Raw Value (dBuV)	Correction Factor (dB/m)
1	#3899.00	38.90 PK	74.00	-35.10	1.05 V	23	5.80	33.10
1	#3899.00	29.00 AV	54.00	-25.00	1.05 V	23	-4.10	33.10
2	#4878.00	53.40 PK	74.00	-20.60	1.05 V	23	18.10	35.30
2	#4878.00	43.30 AV	54.00	-10.70	1.05 V	23	8.00	35.30
3	*5825.00	131.30 PK			1.00 V	1	94.70	36.60
3	*5825.00	121.20 AV			1.00 V	1	84.60	36.60
4	#11650.00	62.40 PK	74.00	-11.60	1.16 V	359	11.80	50.60
4	#11650.00	48.70 AV	54.00	-5.30	1.16 V	359	-1.90	50.60

- NOTE:**
1. Emission level(dBuV/m)=Raw Value(dBuV) + Correction Factor(dB/m)
 2. Correction Factor(dB/m) = Antenna Factor (dB/m) + Cable Factor (dB)
 3. The other emission levels were very low against the limit.
 4. Margin value = Emission level – Limit value
 5. "*" : Fundamental frequency
 6. "#"The radiated frequency falling in the restricted band.
 7. The limit value is defined as per 15.247

5.2.9 TEST RESULTS (ANTENNA 3)

Below 1GHz Worst-Case Data

EUT	Multi-Channel Access Point	MODEL	RBT-4102
TEST MODE	With Adapter	FREQUENCY RANGE	Below 1000MHz
MODULATION TYPE	BPSK	TRANSFER RATE	6Mbps
INPUT POWER (SYSTEM)	120Vac, 60 Hz	DETECTOR FUNCTION	Quasi-Peak
ENVIRONMENTAL CONDITIONS	28deg. C, 55%RH, 961hPa	TESTED BY	Wen Yu

ANTENNA POLARITY & TEST DISTANCE: HORIZONTAL AT 3 M

No.	Freq. (MHz)	Emission Level (dBuV/m)	Limit (dBuV/m)	Margin (dB)	Antenna Height (m)	Table Angle (Degree)	Raw Value (dBuV)	Correction Factor (dB/m)
1	125.00	16.80 QP	43.50	-26.70	1.25 H	111	4.90	11.90
2	150.01	19.90 QP	43.50	-23.60	1.58 H	255	6.50	13.40
3	199.99	24.50 QP	43.50	-19.00	1.11 H	261	13.30	11.20
4	250.00	23.10 QP	46.00	-22.90	1.14 H	38	9.80	13.30
5	375.00	24.90 QP	46.00	-21.10	1.39 H	155	7.30	17.60
6	400.00	25.30 QP	46.00	-20.70	1.07 H	283	6.90	18.40
7	500.00	28.60 QP	46.00	-17.40	1.22 H	357	7.70	20.90
8	625.00	26.70 QP	46.00	-19.30	1.33 H	297	2.90	23.80
9	825.00	30.50 QP	46.00	-15.50	1.22 H	166	3.50	27.00
10	990.00	35.60 QP	54.00	-18.40	1.05 H	347	6.70	28.90

ANTENNA POLARITY & TEST DISTANCE: VERTICAL AT 3 M

No.	Freq. (MHz)	Emission Level (dBuV/m)	Limit (dBuV/m)	Margin (dB)	Antenna Height (m)	Table Angle (Degree)	Raw Value (dBuV)	Correction Factor (dB/m)
1	125.00	25.30 QP	43.50	-18.20	1.00 V	112	13.40	11.90
2	150.01	23.50 QP	43.50	-20.00	1.00 V	51	10.10	13.40
3	199.99	34.50 QP	43.50	-9.00	1.00 V	25	23.30	11.20
4	250.00	26.20 QP	46.00	-19.80	1.00 V	238	12.90	13.30
5	375.00	23.30 QP	46.00	-22.70	1.10 V	55	5.70	17.60
6	400.00	25.60 QP	46.00	-20.40	1.00 V	2	7.20	18.40
7	500.00	29.70 QP	46.00	-16.30	1.03 V	255	8.80	20.90
8	625.00	28.90 QP	46.00	-17.10	1.00 V	338	5.10	23.80
9	825.00	32.50 QP	46.00	-13.50	1.32 V	316	5.50	27.00
10	990.00	36.80 QP	54.00	-17.20	1.36 V	278	7.90	28.90

- REMARKS:**
1. Emission level(dBuV/m)=Raw Value(dBuV) + Correction Factor(dB/m)
 2. Correction Factor(dB/m) = Antenna Factor (dB/m) + Cable Factor (dB)
 3. The other emission levels were very low against the limit.
 4. Margin value = Emission level – Limit value



Below 1GHz Worst-Case Data

EUT	Multi-Channel Access Point	MODEL	RBT-4102
TEST MODE	With POE	FREQUENCY RANGE	Below 1000MHz
MODULATION TYPE	BPSK	TRANSFER RATE	6Mbps
INPUT POWER (SYSTEM)	120Vac, 60 Hz	DETECTOR FUNCTION	Quasi-Peak
ENVIRONMENTAL CONDITIONS	28deg. C, 55%RH, 961hPa	TESTED BY	Wen Yu

ANTENNA POLARITY & TEST DISTANCE: HORIZONTAL AT 3 M

No.	Freq. (MHz)	Emission Level (dBuV/m)	Limit (dBuV/m)	Margin (dB)	Antenna Height (m)	Table Angle (Degree)	Raw Value (dBuV)	Correction Factor (dB/m)
1	125.00	16.80 QP	43.50	-26.70	1.25 H	111	4.90	11.90
2	150.01	19.90 QP	43.50	-23.60	1.58 H	255	6.50	13.40
3	199.99	24.50 QP	43.50	-19.00	1.11 H	261	13.30	11.20
4	250.00	23.10 QP	46.00	-22.90	1.14 H	38	9.80	13.30
5	375.00	24.90 QP	46.00	-21.10	1.39 H	155	7.30	17.60
6	400.00	25.30 QP	46.00	-20.70	1.07 H	283	6.90	18.40
7	500.00	28.60 QP	46.00	-17.40	1.22 H	357	7.70	20.90
8	625.00	26.70 QP	46.00	-19.30	1.33 H	297	2.90	23.80
9	825.00	30.50 QP	46.00	-15.50	1.22 H	166	3.50	27.00
10	990.00	35.60 QP	54.00	-18.40	1.05 H	347	6.70	28.90

ANTENNA POLARITY & TEST DISTANCE: VERTICAL AT 3 M

No.	Freq. (MHz)	Emission Level (dBuV/m)	Limit (dBuV/m)	Margin (dB)	Antenna Height (m)	Table Angle (Degree)	Raw Value (dBuV)	Correction Factor (dB/m)
1	125.00	25.30 QP	43.50	-18.20	1.00 V	112	13.40	11.90
2	150.01	23.50 QP	43.50	-20.00	1.00 V	51	10.10	13.40
3	199.99	34.50 QP	43.50	-9.00	1.00 V	25	23.30	11.20
4	250.00	26.20 QP	46.00	-19.80	1.00 V	238	12.90	13.30
5	375.00	23.30 QP	46.00	-22.70	1.10 V	55	5.70	17.60
6	400.00	25.60 QP	46.00	-20.40	1.00 V	2	7.20	18.40
7	500.00	29.70 QP	46.00	-16.30	1.03 V	255	8.80	20.90
8	625.00	28.90 QP	46.00	-17.10	1.00 V	338	5.10	23.80
9	825.00	32.50 QP	46.00	-13.50	1.32 V	316	5.50	27.00
10	990.00	36.80 QP	54.00	-17.20	1.36 V	278	7.90	28.90

- REMARKS:**
1. Emission level(dBuV/m)=Raw Value(dBuV) + Correction Factor(dB/m)
 2. Correction Factor(dB/m) = Antenna Factor (dB/m) + Cable Factor (dB)
 3. The other emission levels were very low against the limit.
 4. Margin value = Emission level – Limit value

**802.11a OFDM modulation**

EUT	Multi-Channel Access Point	MODEL	RBT-4102
CHANNEL	Channel 1	FREQUENCY RANGE	1 ~ 40 GHz
MODULATION TYPE	BPSK	TRANSFER RATE	6Mbps
INPUT POWER (SYSTEM)	120Vac, 60 Hz	DETECTOR FUNCTION	Peak(PK) Average (AV)
ENVIRONMENTAL CONDITIONS	22deg. C, 75%RH, 961hPa	TESTED BY	Eric Lee

ANTENNA POLARITY & TEST DISTANCE: HORIZONTAL AT 3 M

No.	Freq. (MHz)	Emission Level (dBuV/m)	Limit (dBuV/m)	Margin (dB)	Antenna Height (m)	Table Angle (Degree)	Raw Value (dBuV)	Correction Factor (dB/m)
1	#3899.00	40.70 PK	74.00	-33.30	1.01 H	47	7.00	33.70
1	#3899.00	29.50 AV	54.00	-24.50	1.01 H	47	-4.20	33.70
2	#4798.00	42.70 PK	74.00	-31.30	1.08 H	2	6.60	36.10
2	#4798.00	31.40 AV	54.00	-22.60	1.08 H	2	-4.80	36.10
3	*5745.00	105.70 PK			1.30 H	333	68.10	37.60
3	*5745.00	96.00 AV			1.30 H	333	58.40	37.60
4	#11490.00	62.60 PK	74.00	-11.40	1.53 H	62	11.20	51.30
4	#11490.00	49.70 AV	54.00	-4.30	1.53 H	62	-1.70	51.30

ANTENNA POLARITY & TEST DISTANCE: VERTICAL AT 3 M

No.	Freq. (MHz)	Emission Level (dBuV/m)	Limit (dBuV/m)	Margin (dB)	Antenna Height (m)	Table Angle (Degree)	Raw Value (dBuV)	Correction Factor (dB/m)
1	#3899.00	48.00 PK	74.00	-26.00	1.01 V	112	14.30	33.70
1	#3899.00	37.90 AV	54.00	-16.10	1.01 V	112	4.20	33.70
2	#4798.00	52.30 PK	74.00	-21.70	1.20 V	120	16.20	36.10
2	#4798.00	41.50 AV	54.00	-12.50	1.20 V	120	5.40	36.10
3	*5745.00	123.60 PK			1.06 V	6	86.10	37.60
3	*5745.00	113.90 AV			1.06 V	6	76.30	37.60
4	#11490.00	64.50 PK	74.00	-9.50	1.01 V	230	13.10	51.30
4	#11490.00	50.50 AV	54.00	-3.50	1.01 V	230	-0.90	51.30

- NOTE:**
1. Emission level(dBuV/m)=Raw Value(dBuV) + Correction Factor(dB/m)
 2. Correction Factor(dB/m) = Antenna Factor (dB/m) + Cable Factor (dB)
 3. The other emission levels were very low against the limit.
 4. Margin value = Emission level – Limit value
 5. "*" : Fundamental frequency
 6. "#"The radiated frequency falling in the restricted band.
 7. The limit value is defined as per 15.247



EUT	Multi-Channel Access Point	MODEL	RBT-4102
CHANNEL	Channel 3	FREQUENCY RANGE	1 ~ 40 GHz
MODULATION TYPE	BPSK	TRANSFER RATE	6Mbps
INPUT POWER (SYSTEM)	120Vac, 60 Hz	DETECTOR FUNCTION	Peak(PK) Average (AV)
ENVIRONMENTAL CONDITIONS	22deg. C, 75%RH, 961hPa	TESTED BY	Eric Lee

ANTENNA POLARITY & TEST DISTANCE: HORIZONTAL AT 3 M								
No.	Freq. (MHz)	Emission Level (dBuV/m)	Limit (dBuV/m)	Margin (dB)	Antenna Height (m)	Table Angle (Degree)	Raw Value (dBuV)	Correction Factor (dB/m)
1	#3948.00	40.30 PK	74.00	-33.70	1.20 H	14	6.50	33.80
1	#3948.00	30.90 AV	54.00	-23.10	1.20 H	14	-2.80	33.80
2	#4847.00	42.90 PK	74.00	-31.10	1.20 H	32	6.60	36.30
2	#4847.00	31.50 AV	54.00	-22.50	1.20 H	32	-4.80	36.30
3	*5785.00	105.50 PK			1.30 H	320	67.90	37.60
3	*5785.00	95.70 AV			1.30 H	320	58.10	37.60
4	#11570.00	59.30 PK	74.00	-14.70	1.40 H	10	8.20	51.10
4	#11570.00	46.50 AV	54.00	-7.50	1.40 H	10	-4.60	51.10

ANTENNA POLARITY & TEST DISTANCE: VERTICAL AT 3 M								
No.	Freq. (MHz)	Emission Level (dBuV/m)	Limit (dBuV/m)	Margin (dB)	Antenna Height (m)	Table Angle (Degree)	Raw Value (dBuV)	Correction Factor (dB/m)
1	#3948.00	48.60 PK	74.00	-25.40	1.23 V	65	14.80	33.80
1	#3948.00	38.80 AV	54.00	-15.20	1.23 V	65	5.10	33.80
2	#4847.00	52.60 PK	74.00	-21.40	1.00 V	24	16.30	36.30
2	#4847.00	41.50 AV	54.00	-12.50	1.00 V	24	5.20	36.30
3	*5785.00	123.70 PK			1.07 V	22	86.10	37.60
3	*5785.00	113.90 AV			1.07 V	22	76.30	37.60
4	#11570.00	64.30 PK	74.00	-9.70	1.11 V	24	13.20	51.10
4	#11570.00	50.90 AV	54.00	-3.10	1.11 V	24	-0.20	51.10

- NOTE:**
1. Emission level(dBuV/m)=Raw Value(dBuV) + Correction Factor(dB/m)
 2. Correction Factor(dB/m) = Antenna Factor (dB/m) + Cable Factor (dB)
 3. The other emission levels were very low against the limit.
 4. Margin value = Emission level – Limit value
 5. "*" : Fundamental frequency
 6. "#The radiated frequency falling in the restricted band.
 7. The limit value is defined as per 15.247



EUT	Multi-Channel Access Point	MODEL	RBT-4102
CHANNEL	Channel 5	FREQUENCY RANGE	1 ~ 40 GHz
MODULATION TYPE	BPSK	TRANSFER RATE	6Mbps
INPUT POWER (SYSTEM)	120Vac, 60 Hz	DETECTOR FUNCTION	Peak(PK) Average (AV)
ENVIRONMENTAL CONDITIONS	22deg. C, 75%RH, 961hPa	TESTED BY	Eric Lee

ANTENNA POLARITY & TEST DISTANCE: HORIZONTAL AT 3 M								
No.	Freq. (MHz)	Emission Level (dBuV/m)	Limit (dBuV/m)	Margin (dB)	Antenna Height (m)	Table Angle (Degree)	Raw Value (dBuV)	Correction Factor (dB/m)
1	#3988.00	39.90 PK	74.00	-34.10	1.54 H	24	6.10	33.80
1	#3988.00	29.90 AV	54.00	-24.10	1.54 H	24	-3.90	33.80
2	#4878.00	41.30 PK	74.00	-32.70	1.02 H	32	4.80	36.50
2	#4878.00	31.60 AV	54.00	-22.40	1.02 H	32	-4.90	36.50
3	*5825.00	105.40 PK			1.26 H	331	67.70	37.70
3	*5825.00	95.70 AV			1.26 H	331	57.90	37.70
4	#10650.00	52.50 PK	74.00	-21.50	1.01 H	7	6.20	46.40
4	#10650.00	41.50 AV	54.00	-12.50	1.01 H	7	-4.80	46.40

ANTENNA POLARITY & TEST DISTANCE: VERTICAL AT 3 M								
No.	Freq. (MHz)	Emission Level (dBuV/m)	Limit (dBuV/m)	Margin (dB)	Antenna Height (m)	Table Angle (Degree)	Raw Value (dBuV)	Correction Factor (dB/m)
1	#3988.00	48.80 PK	74.00	-25.20	1.00 V	113	15.00	33.80
1	#3988.00	39.00 AV	54.00	-15.00	1.00 V	113	5.20	33.80
2	#4878.00	52.50 PK	74.00	-21.50	1.34 V	20	16.00	36.50
2	#4878.00	42.30 AV	54.00	-11.70	1.34 V	20	5.80	36.50
3	*5825.00	124.00 PK			1.08 V	38	86.30	37.70
3	*5825.00	113.90 AV			1.08 V	38	76.20	37.70
4	#11650.00	63.00 PK	74.00	-11.00	1.00 V	328	12.20	50.80
4	#11650.00	50.30 AV	54.00	-3.70	1.00 V	328	-0.50	50.80

- NOTE:**
1. Emission level(dBuV/m)=Raw Value(dBuV) + Correction Factor(dB/m)
 2. Correction Factor(dB/m) = Antenna Factor (dB/m) + Cable Factor (dB)
 3. The other emission levels were very low against the limit.
 4. Margin value = Emission level – Limit value
 5. "*" : Fundamental frequency
 6. "#"The radiated frequency falling in the restricted band.
 7. The limit value is defined as per 15.247



5.3 6dB BANDWIDTH MEASUREMENT

5.3.1 LIMITS OF 6dB BANDWIDTH MEASUREMENT

The minimum of 6dB Bandwidth Measurement is 0.5 MHz.

5.3.2 TEST INSTRUMENTS

Description & Manufacturer	Model No.	Serial No.	Calibrated Until
R&S SPECTRUM ANALYZER	FSP40	100036	Nov. 23, 2005

NOTE:

- 1.The measurement uncertainty is less than +/- 2.6dB, which is calculated as per the NAMAS document NIS81.
- 2.The calibration interval of the above test instruments is 12 months and the calibrations are traceable to NML/ROC and NIST/USA.

5.3.3 TEST PROCEDURE

The transmitter output was connected to the spectrum analyzer through an attenuator. The bandwidth of the fundamental frequency was measured by spectrum analyzer with 100kHz RBW and 100kHz VBW. The 6dB bandwidth is defined as the total spectrum the power of which is higher than peak power minus 6dB.

5.3.4 DEVIATION FROM TEST STANDARD

No deviation

5.3.5 TEST SETUP

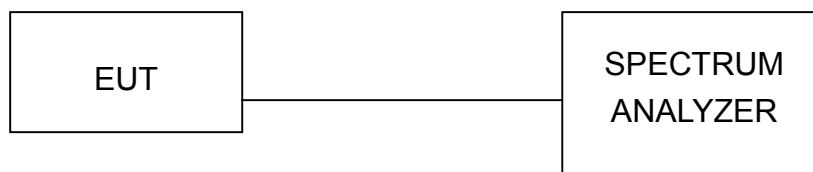

5.3.6 EUT OPERATING CONDITIONS

The software provided by client to enable the EUT under transmission condition continuously at lowest, middle and highest channel frequencies individually.



5.3.7 TEST RESULTS

802.11a OFDM modulation

EUT	Multi-Channel Access Point	MODEL	RBT-4102
MODULATION TYPE	BPSK	TRANSFER RATE	6Mbps
INPUT POWER (SYSTEM)	120Vac, 60 Hz	ENVIRONMENTAL CONDITIONS	25deg. C, 65%RH, 961hPa
TESTED BY	Rex Huang		

CHANNEL	CHANNEL FREQUENCY (MHz)	6dB BANDWIDTH (MHz)	MINIMUM LIMIT (MHz)	PASS/FAIL
1	5745	16.47	0.5	PASS
3	5785	16.47	0.5	PASS
5	5825	16.47	0.5	PASS



CH1

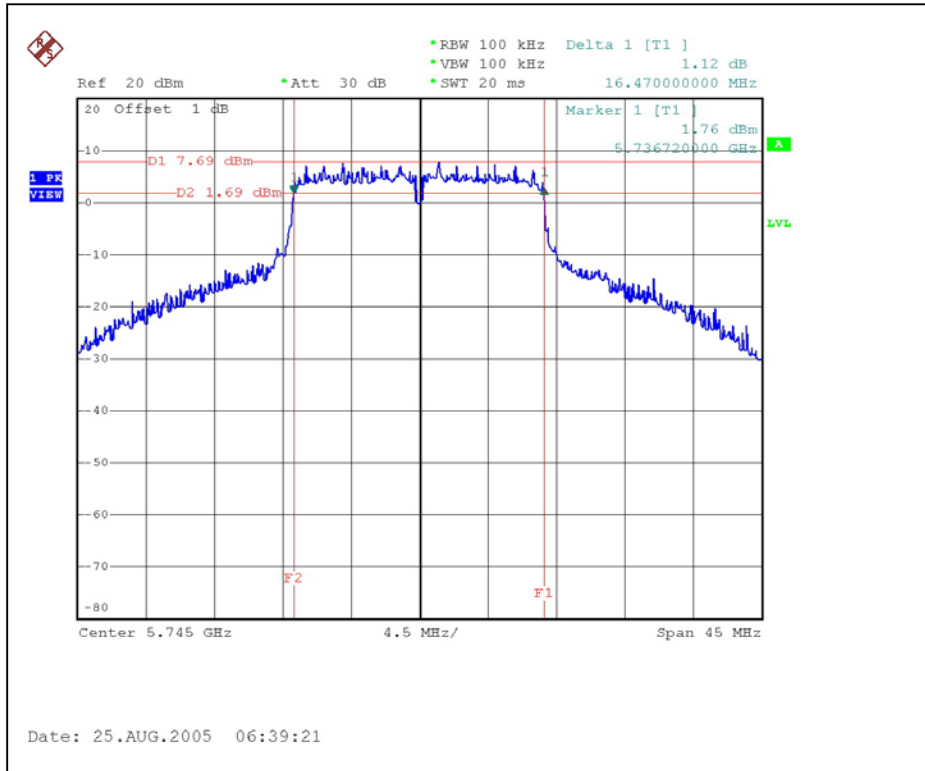

CH3

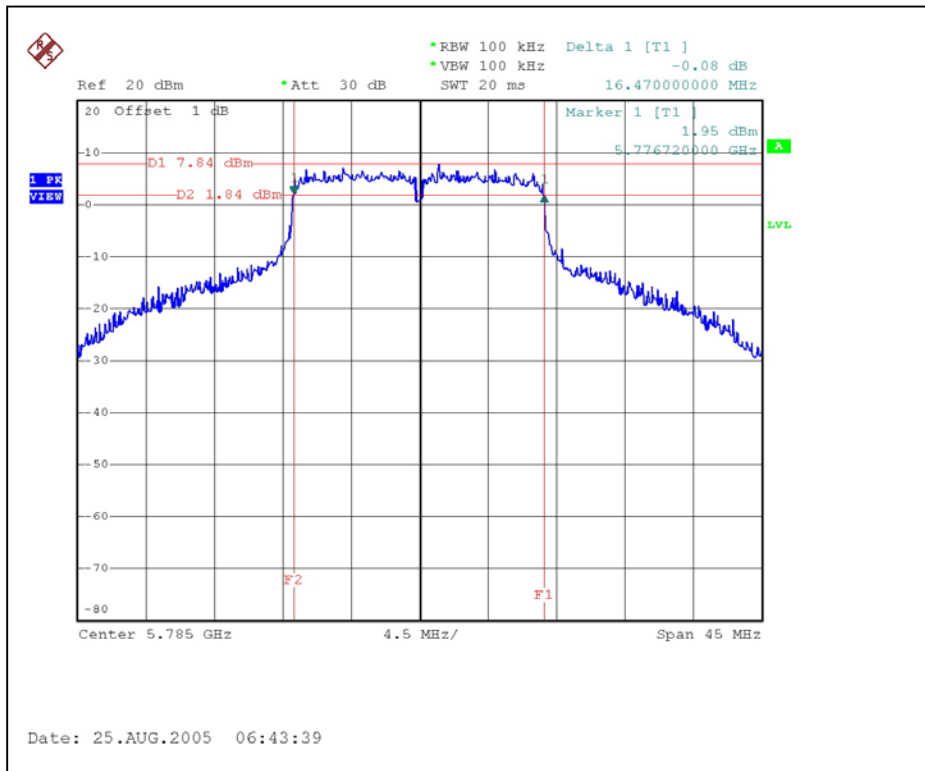



CH5

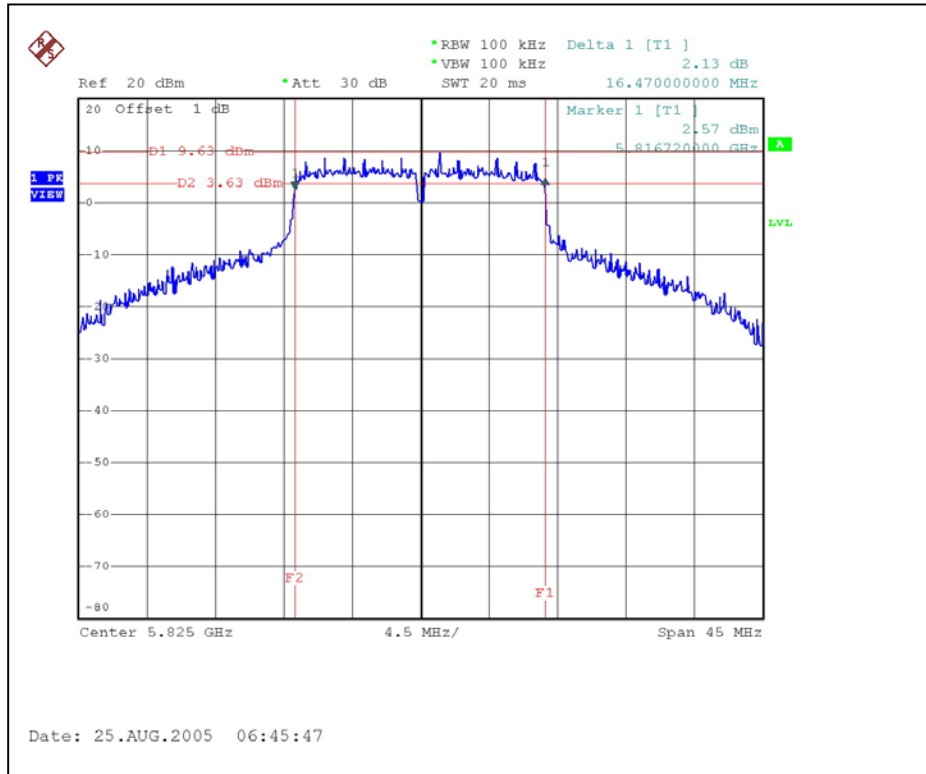



5.4 MAXIMUM PEAK OUTPUT POWER

5.4.1 LIMITS OF MAXIMUM PEAK OUTPUT POWER MEASUREMENT

The Maximum Peak Output Power Measurement is 30dBm.

5.4.2 INSTRUMENTS

Description & Manufacturer	Model No.	Serial No.	Calibrated Until
R&S SPECTRUM ANALYZER	FSP40	100036	Nov. 23, 2005
Agilent SIGNAL GENERATOR	E8257C	MY43320668	Dec. 07, 2005
TEKTRONIX OSCILLOSCOPE	TDS380	B016335	Jun. 22, 2006
NARDA DETECTOR	4503A	FSCM99899	NA

NOTE:

The calibration interval of the above test instruments is 12 months and the calibrations are traceable to NML/ROC and NIST/USA.



5.4.3 TEST PROCEDURES

1. A detector was used on the output port of the EUT. An oscilloscope was used to read the response of the detector.
2. Replaced the EUT by the signal generator. The center frequency of the S.G was adjusted to the center frequency of the measured channel.
3. Adjusted the power to have the same reading on oscilloscope. Record the power level.

5.4.4 DEVIATION FROM TEST STANDARD

No deviation

5.4.5 TEST SETUP



5.4.6 EUT OPERATING CONDITIONS

Same as Item 4.3.6

5.4.7 TEST RESULTS

802.11a OFDM modulation

EUT	Multi-Channel Access Point	MODEL	RBT-4102
MODULATION TYPE	BPSK	TRANSFER RATE	6Mbps
INPUT POWER (SYSTEM)	120Vac, 60 Hz	ENVIRONMENTAL CONDITIONS	27deg. C, 53%RH, 961hPa
TESTED BY	Eric Lee		

Antenna 1 (Gain : 4 dBi)

CHANNEL	CHANNEL FREQUENCY (MHz)	PEAK POWER OUTPUT (dBm)	PEAK POWER LIMIT (dBm)	PASS/FAIL
1	5745	23.25	30	PASS
3	5785	23.49	30	PASS
5	5825	23.63	30	PASS

Antenna 2 (Gain : 23 dBi)

CHANNEL	CHANNEL FREQUENCY (MHz)	PEAK POWER OUTPUT (dBm)	PEAK POWER LIMIT (dBm)	PASS/FAIL
1	5745	23.25	30	PASS
3	5785	23.49	30	PASS
5	5825	23.63	30	PASS

Antenna 3 (Gain : 10.0 dBi)

CHANNEL	CHANNEL FREQUENCY (MHz)	PEAK POWER OUTPUT (dBm)	PEAK POWER LIMIT (dBm)	PASS/FAIL
1	5745	23.25	26	PASS
3	5785	23.49	26	PASS
5	5825	23.63	26	PASS



5.5 POWER SPECTRAL DENSITY MEASUREMENT

5.5.1 LIMITS OF POWER SPECTRAL DENSITY MEASUREMENT

The Maximum of Power Spectral Density Measurement is 8dBm.

5.5.2 TEST INSTRUMENTS

Description & Manufacturer	Model No.	Serial No.	Calibrated Until
R&S SPECTRUM ANALYZER	FSP40	100036	Nov. 23, 2005

NOTE:

- 1.The measurement uncertainty is less than +/- 2.6dB, which is calculated as per the NAMAS document NIS81.
- 2.The calibration interval of the above test instruments is 12 months and the calibrations are traceable to NML/ROC and NIST/USA.

5.5.3 TEST PROCEDURE

The transmitter output was connected to the spectrum analyzer through an attenuator, the bandwidth of the fundamental frequency was measured with the spectrum analyzer using 3 kHz RBW and 30 kHz VBW, set sweep time = span/3 kHz. The power spectral density was measured and recorded.

The sweep time is allowed to be longer than span/3 kHz for a full response of the mixer in the spectrum analyzer.

5.5.4 DEVIATION FROM TEST STANDARD

No deviation

5.5.5 TEST SETUP

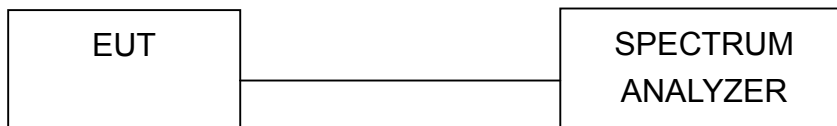

5.5.6 EUT OPERATING CONDITION

Same as Item 4.3.6



5.5.7 TEST RESULTS

802.11a OFDM modulation

EUT	Multi-Channel Access Point	MODEL	RBT-4102
MODULATION TYPE	BPSK	TRANSFER RATE	6Mbps
INPUT POWER (SYSTEM)	120Vac, 60 Hz	ENVIRONMENTAL CONDITIONS	25deg. C, 65%RH, 961hPa
TESTED BY	Eric Lee		

CHANNEL	CHANNEL FREQUENCY (MHz)	RF POWER LEVEL IN 3 kHz BW (dBm)	MAXIMUM LIMIT (dBm)	PASS/FAIL
1	5745	-4.99	8	PASS
3	5785	-4.63	8	PASS
5	5825	-4.45	8	PASS



CH1

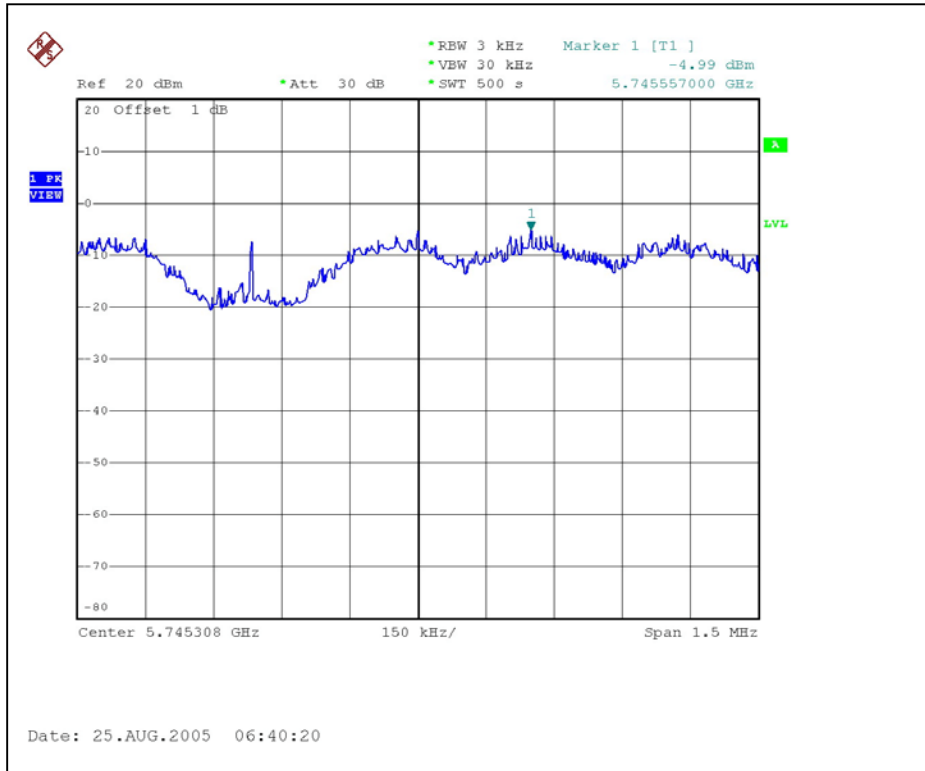

CH3

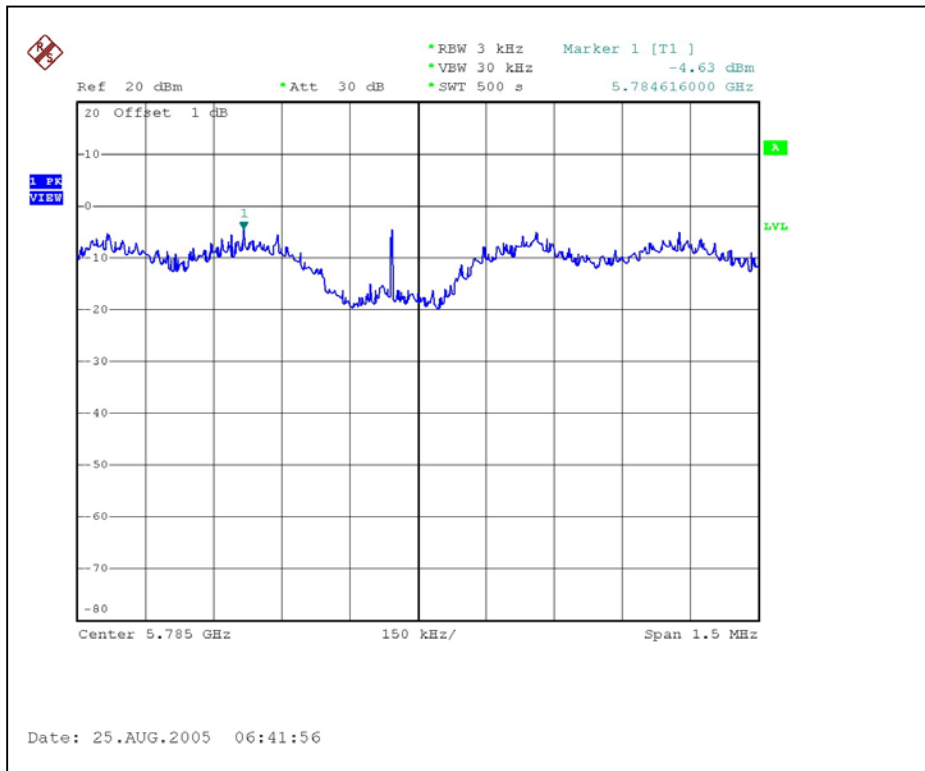



CH5

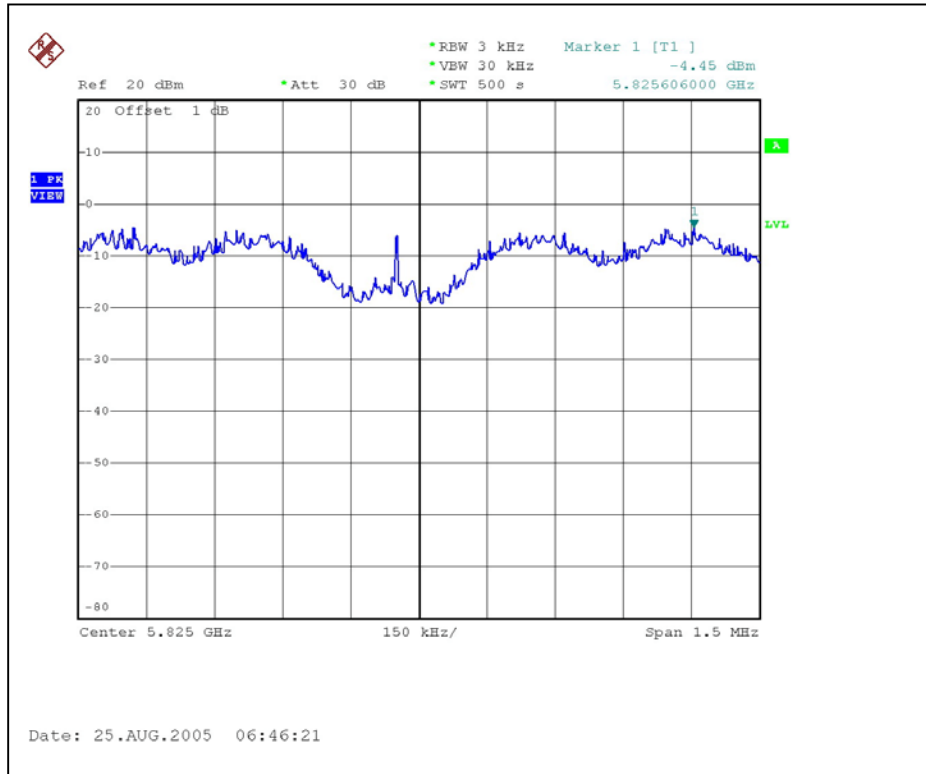



5.6 BAND EDGES MEASUREMENT

5.6.1 LIMITS OF BAND EDGES MEASUREMENT

Below -20dB of the highest emission level of operating band (in 100kHz Resolution Bandwidth).

5.6.2 TEST INSTRUMENTS

Description & Manufacturer	Model No.	Serial No.	Calibrated Until
R&S SPECTRUM ANALYZER	FSP40	100036	Nov. 23, 2005

NOTE:

- 1.The measurement uncertainty is less than $\pm 2.6\text{dB}$, which is calculated as per the NAMAS document NIS81.
- 2.The calibration interval of the above test instruments is 12 months and the calibrations are traceable to NML/ROC and NIST/USA.



5.6.3 TEST PROCEDURE

The transmitter output was connected to the spectrum analyzer via a low loss cable. Set both RBW and VBW of spectrum analyzer to 100 kHz with suitable frequency span including 100 MHz bandwidth from band edge. The band edges was measured and recorded.

5.6.4 DEVIATION FROM TEST STANDARD

No deviation

5.6.5 EUT OPERATING CONDITION

Same as Item 4.3.6



5.6.6 TEST RESULTS

The spectrum plots are attached on the following pages. D2 line indicates the highest level, D1 line indicates the 20dB offset below D2. It shows compliance with the requirement in part 15.247(d).



802.11a OFDM modulation

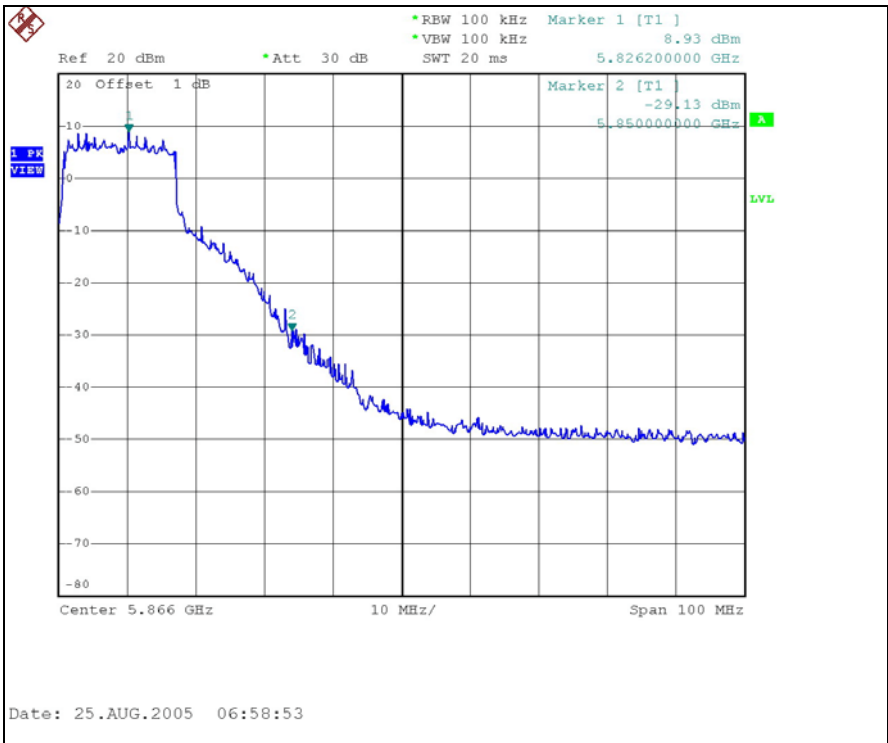
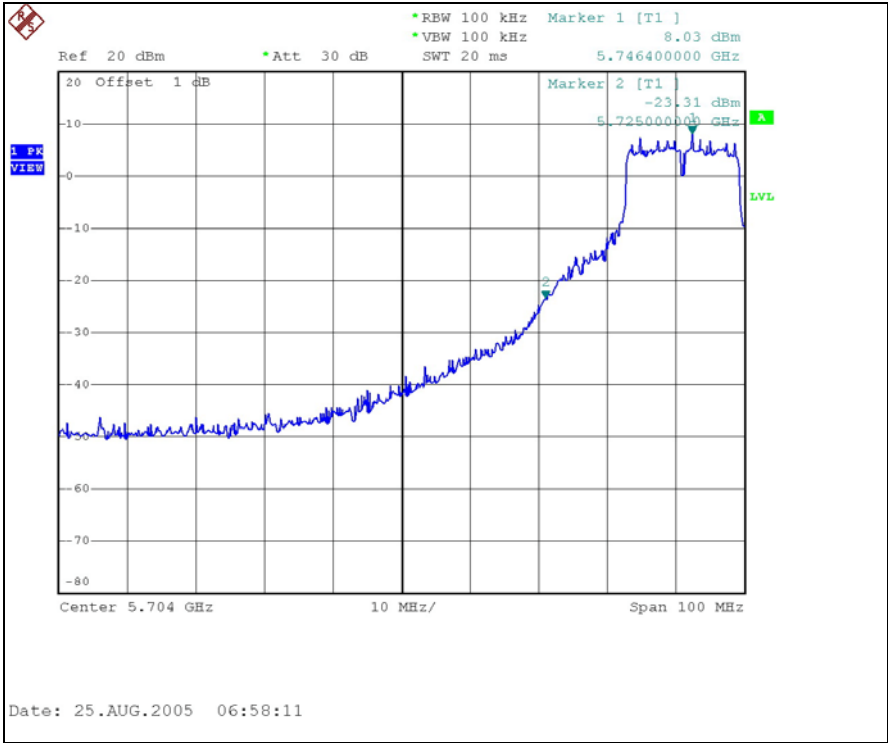

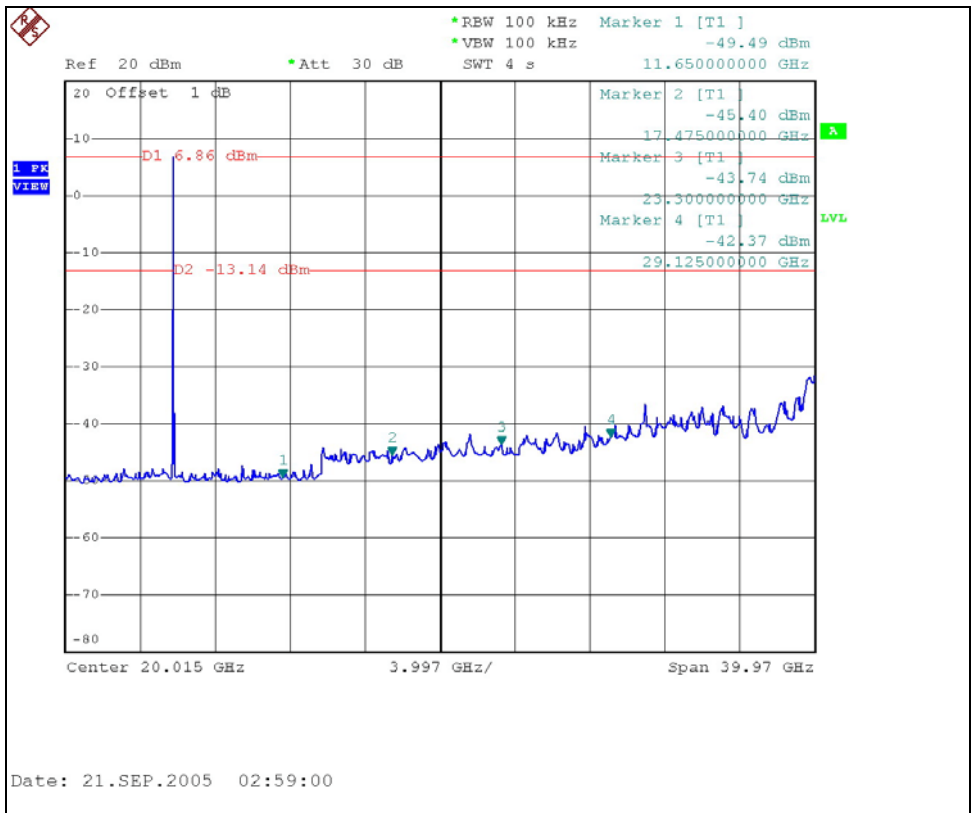
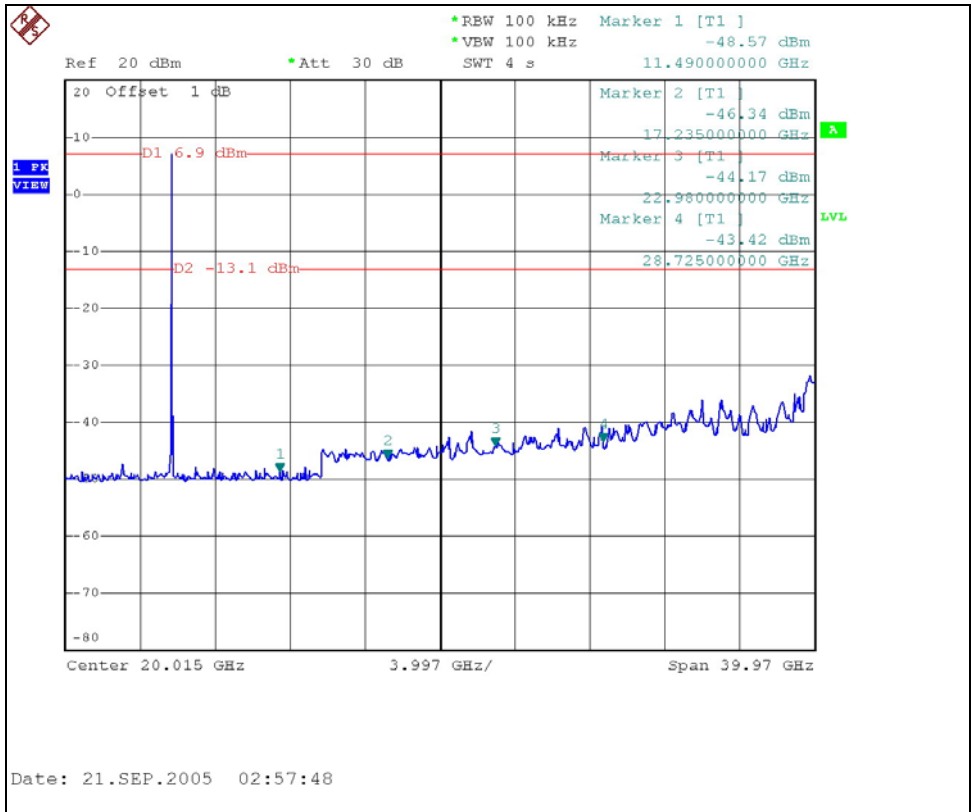

5.7 ANTENNA REQUIREMENT

5.7.1 STANDARD APPLICABLE

For intentional device, according to FCC 47 CFR Section 15.203, an intentional radiator shall be designed to ensure that no antenna other than that furnished by the responsible party shall be used with the device.

And according to FCC 47 CFR Section 15.247(a), if transmitting antennas of directional gain greater than 6dBi are used, the power shall be reduced by the amount in dB that the directional gain of the antenna exceeds 6dBi.

5.7.2 ANTENNA CONNECTED CONSTRUCTION

The antennas used in this product are as following:

Item	SPEC No.	Model No.	Product Description	Antenna Gain	Remark	Connector
1	NA	RBT4K-AG-IA	2.4-4.9/5.8 GHz, 8ft of cable RPSMA Indoor Antenna.	4dBi	Omni	RPSMA
2	8910605	RBTES-AH-P23M	5.8GHz GHz Directional Antenna Assy Outdoor Antenna..	23 dBi	Point to point Directional	Reverse N
3	8910606	RBTES-AH-M10M	5.8GHz GHz Omni Antenna Assy Outdoor Antenna.	10 dBi	Omni	Reverse N

6. PHOTOGRAPHS OF THE TEST CONFIGURATION

CONDUCTED EMISSION TEST (For 11a / WITH ADAPTER)



CONDUCTED EMISSION TEST (For 11a / WITH POE)



CONDUCTED EMISSION TEST (For 11bg / WITH ADAPTER)



CONDUCTED EMISSION TEST (For 11bg / WITH POE)



RADIATED EMISSION TEST (Antenna: RBT4K-AG-IA + Adapter)



RADIATED EMISSION TEST (Antenna: RBT4K-AG-IA + POE)



RADIATED EMISSION TEST (Antenna: RBTES-AH-P23M + Adapter)



RADIATED EMISSION TEST (Antenna: RBTES-AH-P23M + POE)



RADIATED EMISSION TEST (Antenna: RBTES-AH-M10M + Adapter)



RADIATED EMISSION TEST (Antenna: RBTES-AH-M10M + POE)





7. INFORMATION ON THE TESTING LABORATORIES

We, ADT Corp., were founded in 1988 to provide our best service in EMC, Radio, Telecom and Safety consultation. Our laboratories are accredited and approved by the following approval agencies according to ISO/IEC 17025.

USA	FCC, NVLAP, UL, A2LA
Germany	TUV Rheinland
Japan	VCCI
Norway	NEMKO
Canada	INDUSTRY CANADA , CSA
R.O.C.	CNLA, BSMI, DGT
Netherlands	Telefication
Singapore	PSB , GOST-ASIA(MOU)
Russia	CERTIS(MOU)

Copies of accreditation certificates of our laboratories obtained from approval agencies can be downloaded from our web site:

www.adt.com.tw/index.5/phtml. If you have any comments, please feel free to contact us at the following:

Linko EMC/RF Lab:

Tel: 886-2-26052180

Fax: 886-2-26052943

Hsin Chu EMC/RF Lab:

Tel: 886-3-5935343

Fax: 886-3-5935342

Hwa Ya EMC/RF/Safety Telecom Lab:

Tel: 886-3-3183232

Fax: 886-3-3185050

Web Site: www.adt.com.tw

The address and road map of all our labs can be found in our web site also



APPENDIX-A

MODIFICATIONS RECORDERS FOR ENGINEERING CHANGES TO THE EUT BY THE LAB

No any modifications are made to the EUT by the lab during the test.