

**COMPLIANCE WORLDWIDE INC.
TEST REPORT 288-12R2**

In Accordance with the Requirements of
**FCC PART 15.247, SUBPART C
INDUSTRY CANADA RSS 210, ISSUE 8
Class II Permissive Change**

**Low Power License-Exempt Radio Communication Devices
Intentional Radiators**

Issued to

**Enterasys Networks, Inc.
50 Minuteman Road
Andover, MA 01810
978-659-2800**

for the

**HiPath Wireless Outdoor Access Point
Model: WS-AP3660 with WS-AO-DX13025 Panel Antenna**

**FCC ID: QXO-OAP36B
IC: 4138A-OAP36B**

**Original Report Issued on June 26, 2012
Revision R2 Issued on June 29, 2012**

Tested by

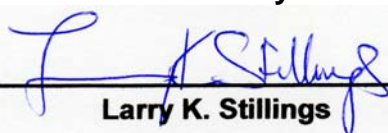

Larry K. Stillings

Reviewed By



Brian F. Breault

This test report shall not be reproduced, except in full, without written permission from Compliance Worldwide, Inc.

Table of Contents

1. Scope	3
2 .Product Details	3
2.1 Manufacturer	3
2.3 Serial Number.....	3
2.4 Description.....	3
2.5 Power Source	3
2.6 EMC Modifications.....	3
3. Product Configuration	3
3.1 Operational Characteristics & Software	3
3.2 EUT Hardware.....	4
3.3 EUT Connected Hardware	4
3.4 EUT Cables/Transducers	4
3.5 Support Equipment.....	4
3.6 Block Diagram	5
4. Measurements Parameters	6
4.1 Measurement Equipment Used to Perform Test.....	6
4.2 Measurement & Equipment Setup	6
4.3 Measurement Procedure	6
4.4 Measurement Uncertainty	7
5. Choice of Equipment for Test Suits.....	8
5.1 Choice of Model.....	8
5.2 Presentation	8
5.3 Choice of Operating Frequencies.....	8
5.4 Modes of Operation	8
6. Measurement Summary.....	9
7. Measurement Data.....	10
7.1 Antenna Requirement	10
7.2 Minimum 6 dB Bandwidth.....	11
7.3 99% Bandwidth.....	23
7.4 Maximum Peak Conducted Output Power	35
7.5 Operation with directional antenna gains greater than 6 dBi	48
7.6 Transmitter Spurious Radiated Emissions	49
7.7 Band Edge Measurements.....	57
7.8 Power Spectral Density	70
7.9 Conducted Emissions.....	82
7.10 Public Exposure to Radio Frequency Energy Levels.....	84
8. Test Setup Photographs	91
9. Test Site Description.....	97

1. Scope

This test report certifies that the Enterasys Networks WS-AP3660 with WS-AO-DX13025 Panel Antenna, as tested, meets the FCC Part 15, Subpart C and Industry Canada RSS 210, Issue 8 requirements. The scope of this test report is limited to the test sample provided by the client, only in as much as that sample represents other production units. If any significant changes are made to the unit, the changes shall be evaluated and a retest may be required. Revision R1 updates all the data to reflect 12.5 dBi antenna gain instead of 13 dBi as initially indicated by the manufacturer. The data on pages 36, 43, 70, 77 & 84-90 has been updated to reflect this. Revision R2 updates the test procedure in section 7.4 on page 35.

2. Product Details

- 2.1. Manufacturer:** Enterasys Networks
- 2.2. Model Number:** WS-AP3660
- 2.3. Serial Number:** 10490067235A0000
- 2.4. Description:** The WS-AP3660 is an outdoor access point consisting of two 3x3 MIMO 802.11b/g/a/n radios operating in the 2400 to 2483.5 MHz and 5725 to 5850 MHz bands. A PCTEL WS-AO-DX13025 Panel antenna with 12.5 dBi of gain and 25 degree beam width was connected to the EUT.
- 2.5. Power Source:** DC -12 volts via External Power Supply or Power over Ethernet
- 2.6. EMC Modifications:** None

3. Product Configuration

3.1. Operational Characteristics & Software

Operating Instructions for Test

Connect the console port and Ethernet ports between the EUT and laptop and POE injector if needed.

Power up the WS-AP3660 and the support laptop. Allow the EUT to warm up and achieve stable temperature.

Using the console port login to the WS-AP3660 and configure the Ethernet port to be on the same set of ethernet addresses ending in (.50) on the EUT and on the laptop (.20).

Ping the laptop via the console port to verify that the EUT can communicate to one another over the Ethernet connection.

Start the ArtScript on the EUT.

Startup the ART tool via the Ethernet connection on the laptop.

With the ART tool operating,

- Load the EEPROM Calibration data into the radio.

- Toggle the mode (either 2.4 GHz or 5 GHz) radio operation.

- Select Continuous transmit for the mode of operation.

- Increase or Decrease the channels via frequency.

- Change the output power of the radio as necessary.

- Change the data rate of the radio to determine the highest level of emissions (802.11b/g/a/n)

- Change the radio into HT40 mode as required.

3. Product Configuration

3.2. EUT Hardware

Manufacturer	Model/Part # / Options	Serial Number	Input Voltage	Frq (Hz)	Description/Function
Enterasys Networks	WS-AP3660	10490067235A0000	12	DC	Outdoor 2.4/5.8 GHz Access Point

3.3. EUT CONNECTED Hardware

Manufacturer	Model	Description	Serial Number
PCTEL	WS-AO-DX13025	3x3 MIMO Antenna 12.5 dBi Gain, 25 Degree Beam width	05042012
Enterasys Networks	WS-PS3660-MR	12 VDC 3.3 AMP External Power Supply	10510053235A

3.4. EUT Cables/Transducers

Manufacturer	Model/Part #	Length (m)	Shield Y/N	Description/Function
PCTEL	N Coaxial Cables	0.5	Y	3 Cables from Radio 1 to Antenna, 3 Cables from Radio 2 to Antenna
ANY	RJ45 Cable	10	N	RJ45 to DB9 Console Port Cable
ANY	RJ45 Cable	10	N	RJ45 Ethernet Cable

3.5. Support Equipment

Manufacturer	Model/Part # Options	Input Voltage	Input Freq	Description/Function
DELL	Latitude D620 Laptop	120	60	Support Laptop for Controlling EUT
PowerDsine	3001G	120	60	POE Injector for operating the EUT via the Ethernet Supply

3. Product Configuration (continued)

3.6. Block Diagram

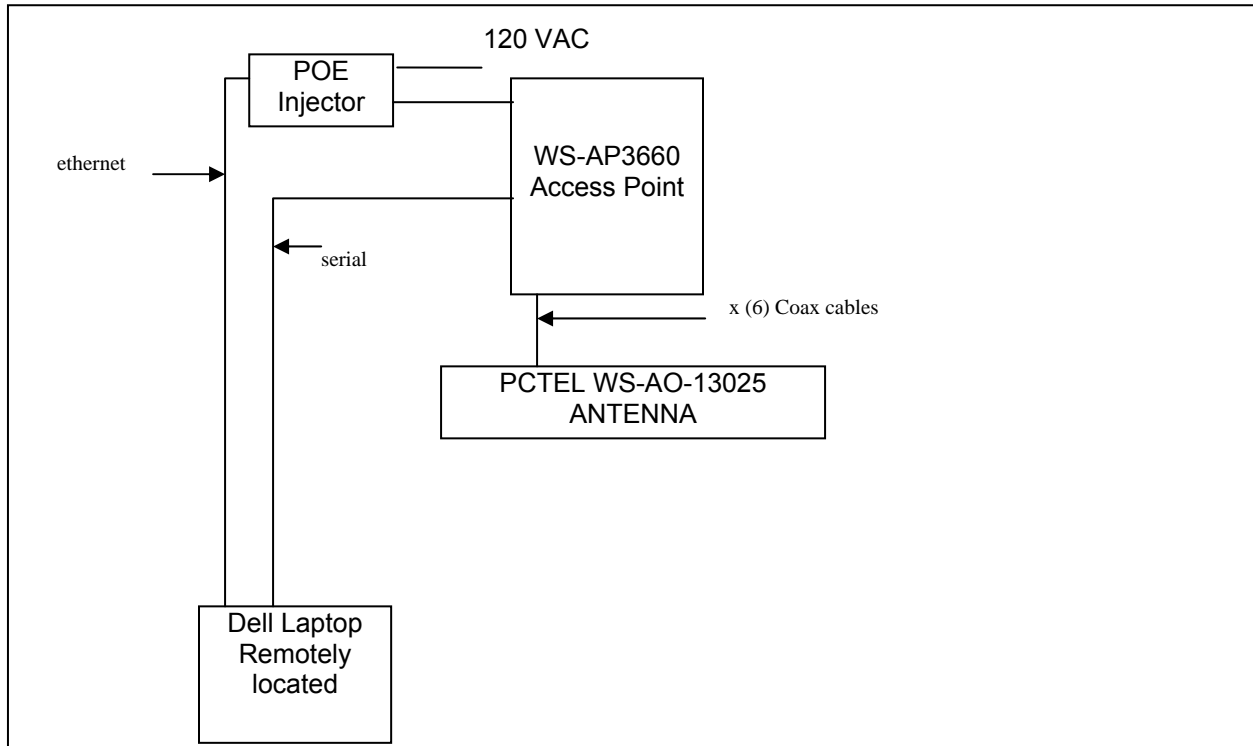

4. Measurements Parameters

4.1. Measurement Equipment Used to Perform Tests

Device	Manufacturer	Model No.	Serial No.	Cal Due
Spectrum Analyzer	Agilent	E4407B	MY45104493	12/22/2012
Spectrum Analyzer	Rohde & Schwarz	FSV40	100899	5/26/2012
Microwave Preamp	Hewlett Packard	8449B	3008A01323	12/1/2012
Bilog Antenna	Com-Power	AC-220	25509	8/30/2012
Horn Antenna	Electro-Metrics	EM-6961	6337	10/19/2012
Horn Antenna	Com-Power	AH-826	081051	6/30/2012
Horn Antenna	Com-Power	AH-840	03075	7/20/2012
Loop Antenna	EMCO	6502	2197	7/21/2012
2.4 GHz BP Filter	Micro-Tronics	BRM50702	14	8/11/2012
6.4 GHz HP Filter	Micro-Tronics	HPM50112	14R	2/28/2013
Digital Barometer	Control Company	4195	ID236	1/4/2013

4.2. Measurement & Equipment Setup

Test Dates:	June 22 nd to 26 th , 2012
Test Engineer:	Larry Stillings
Normal Site Temperature (15 - 35°C):	21.7
Relative Humidity (20 -75%RH):	33%
Frequency Range:	150 kHz to 40 GHz
Measurement Distance:	3 Meters
EMI Receiver IF Bandwidth:	9 kHz – 150 kHz to 30 MHz 120 kHz– 30 MHz to 1 GHz 1 MHz – Above 1 GHz
EMI Receiver Avg Bandwidth:	30 kHz – 150 kHz to 30 MHz 300 kHz– 30 MHz to 1 GHz 3 MHz – Above 1 GHz
Detector Function:	Peak, QP - 150 kHz to 1 GHz Peak, Avg- Above 1 GHz Unless otherwise specified.

4.3. Measurement Procedures

Test measurements were made in accordance FCC Part 15.247, IC RSS-210 Annex II: Operation within the bands 902 - 928 MHz, 2400 - 2483.5 MHz, 5725 - 5850 MHz, and 24.0 - 24.25 GHz.

The test procedures detailed in the Federal Communications Commission Office of Engineering and Technology Guidance for Performing Measurements on Digital Transmission Systems (DTS) Operating Under 15.247 (FCC OET Publication Number 558074), dated 1/18/2012, were used to generate the data in this test report.

4. Measurements Parameters

4.3. Measurement Procedure (continued)

The test methods used to generate the data in this test report is in accordance with ANSI C63.4: 2009, American National Standard for Methods of Measurement of Radio-Noise Emissions from Low-Voltage Electrical and Electronic Equipment in the Range of 9 kHz to 40 GHz.

4.4. Measurement Uncertainty

The following uncertainties are expressed for an expansion/coverage factor of K=2.

RF Frequency	$\pm 1 \times 10^{-8}$
Radiated Emission of Transmitter	± 4.55 dB
Radiated Emission of Receiver	± 4.55 dB
Temperature	$\pm 0.91^{\circ}$ C
Humidity	$\pm 5\%$

5. Choice of Equipment for Test Suits

5.1 Choice of Model

This test report is based on the test samples supplied by the manufacturer and are reported by the manufacturer to be equivalent to the production units.

5.2 Presentation

This test sample was tested complete with all required ancillary equipment. Refer to Section 3 of this report for product equipment configuration.

5.3 Choice of Operating Frequencies

The WS-AP3660, as tested, operates on 11 channels, from channels 1 to 11 in the 2.4 GHz band and 7 Channels 149 to 165 in the 5.8 GHz band.

In accordance with ANSI C63.4-2009, section 13.2.1, the choice of operating frequencies selected for the testing detailed in this report are outlined in the following table:

Channel	Frequency (MHz)	802.11b,g & HT20	HT40
1	2412	Tested	Not Tested
2	2417	Not Tested	Not Tested
3	2422	Not Tested	Tested
4	2427	Not Tested	Not Tested
5	2432	Not Tested	Not Tested
6	2437	Tested	Tested
7	2442	Not Tested	Not Tested
8	2447	Not Tested	Not Tested
9	2452	Not Tested	Tested
10	2457	Not Tested	Not Tested
11	2462	Tested	Not Tested

Channel	Frequency (MHz)	802.11a & HT20	HT40
149	5745	Tested	Not Tested
151	5755	Not Tested	Tested
153	5765	Not Tested	Not Tested
157	5785	Tested	Not Tested
159	5795	Not Tested	Tested
161	5805	Not Tested	Not Tested
165	5825	Tested	Not Tested

5.4 Modes of Operation

The WS-AP3660 was found to produce the worst case emissions in 802.11b mode using 1 MB Long PN9 data, 802.11g mode using 6 MB PN9 data, 802.11a mode using 6 MB PN9 data, 802.11n HT20 mode using 6.5 MB MCS0 data and in 802.11n HT40 mode using 13.5 MB MCS0 data.

6. Measurement Summary

Test Requirement	FCC Rule Reference	IC Rule Reference	Test Report Section	Result
Antenna Requirement	15.203	RSS-GEN 7.1.2	7.1	Compliant
Minimum 6 dB Bandwidth	15.247 (a) (2)	RSS-210 A8.2	7.2	Compliant
99% Bandwidth	N/A	RSS-GEN 4.6.1	7.3	Compliant
Maximum Peak Conducted Output Power	15.247 (b) (1)	RSS-210 A8.4 (4)	7.4	Compliant
Operation with directional antenna gains greater than 6 dBi	15.247 (b) (4)	RSS-GEN 7.1.2	7.5	Compliant
Spurious Radiated Emissions	15.247 (d)	RSS-GEN 4.9	7.6	Compliant
Spurious Radiated Emissions (> GHz) - Harmonic Measurements	15.247 (d)	RSS-210 A8.9	7.6	Compliant
Lower and Upper Band Edge	15.247 (d)	RSS-210 A8.5	7.7	Compliant
Power Spectral Density	15.247(e)		7.8	Compliant
Conducted Emissions	15.207	RSS-GEN	7.9	Compliant
Public Exposure to Radio Frequency Energy Levels	1.1307 (b) (1)	RSS-GEN 5.5 RSS-102	7.10	Compliant

7. Measurement Data

7.1. Antenna Requirement (15.203, RSS GEN 7.1.2)

Requirement: An intentional radiator shall be designed to ensure that no antenna other than that furnished by the responsible party shall be used with the device. The use of a permanently attached antenna or of an antenna that uses a unique coupling to the intentional radiator shall be considered sufficient to comply with the provisions of this Section.

Conclusion: The WS-AP3660 uses reverse polarity N type antenna connectors and is professionally installed.

7. Measurement Data

7.2. Minimum 6 dB Bandwidth

Requirement: (15.247 (a) (2), RSS 210 A8.2(a))

Systems using digital modulation techniques may operate in the 902 - 928 MHz, 2400 - 2483.5 MHz, and 5725 - 5850 MHz bands. The minimum 6 dB bandwidth shall be at least 500 kHz.

Procedure: This test was performed in accordance with the procedure detailed in FCC OET publication number 558074, Section 5.1, clause 5.1.1: Alternate EBW Measurement Procedure.

Conclusion: The device under test meets the minimum 500 kHz 6 dB bandwidth requirement.

Measurement Results for 2400 to 2483.5 MHz Band

802.11g Mode Channel	Frequency (MHz)	-6 dB Bandwidth (kHz)	Minimum -6 dB Bandwidth (kHz)	Result
Low	2412	10550	>500	Compliant
Middle	2437	10550	>500	Compliant
High	2462	10450	>500	Compliant

802.11b Mode Channel	Frequency (MHz)	-6 dB Bandwidth (kHz)	Minimum -6 dB Bandwidth (kHz)	Result
Low	2412	16550	>500	Compliant
Middle	2437	16450	>500	Compliant
High	2462	16450	>500	Compliant

HT20 Mode Channel	Frequency (MHz)	-6 dB Bandwidth (kHz)	Minimum -6 dB Bandwidth (kHz)	Result
Low	2412	17850	>500	Compliant
Middle	2437	17800	>500	Compliant
High	2462	17800	>500	Compliant

HT40 Mode Channel	Frequency (MHz)	-6 dB Bandwidth (kHz)	Minimum -6 dB Bandwidth (kHz)	Result
Low	2422	36600	>500	Compliant
Middle	2437	36300	>500	Compliant
High	2452	36400	>500	Compliant

7. Measurement Data

7.2. Minimum 6 dB Bandwidth (15.247 (a) (2)) (continued)

6.2.1. Low Channel – 1 – 802.11b

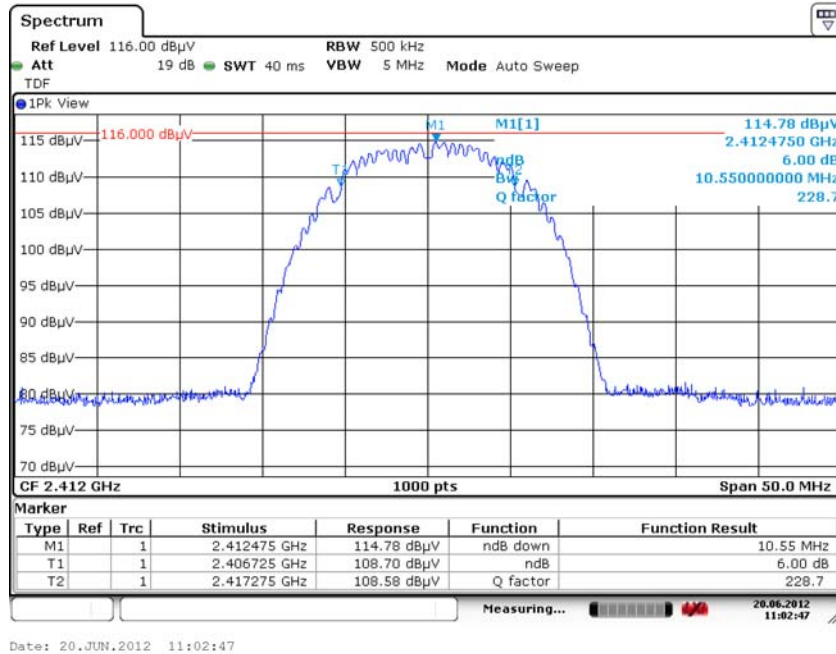

6.2.2. Mid Channel – 6 – 802.11b

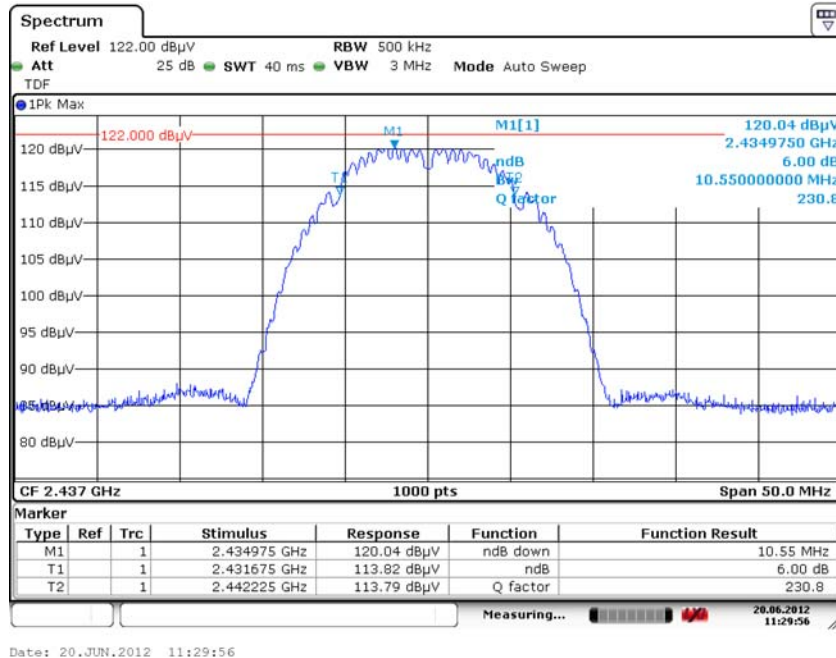

7. Measurement Data (continued)

7.2. Minimum 6 dB Bandwidth (15.247 (a) (2)) (continued)

6.2.3. High Channel – 11 – 802.11b

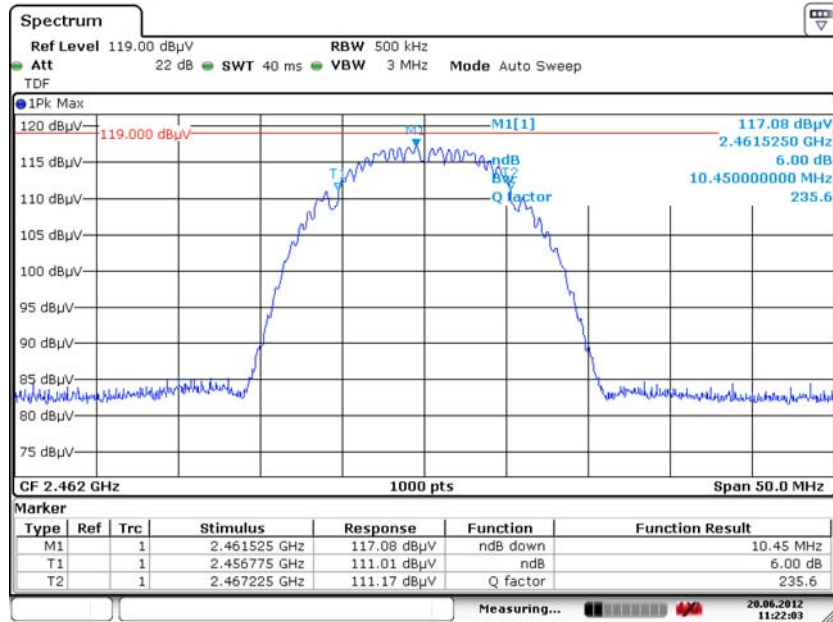

6.2.4. Low Channel – 1 – 802.11g

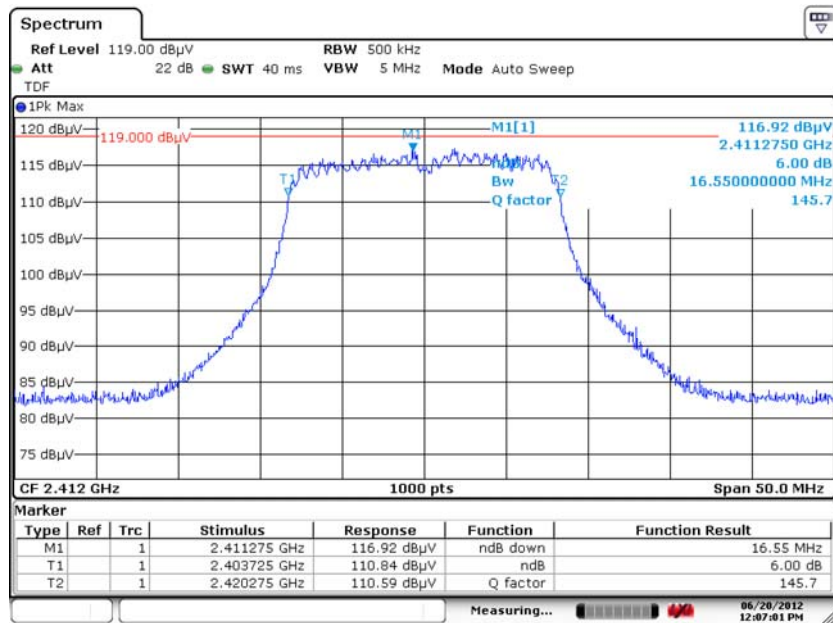

7. Measurement Data (continued)

7.2. Minimum 6 dB Bandwidth (15.247 (a) (2)) (continued)

6.2.5. Mid Channel – 6 – 802.11g

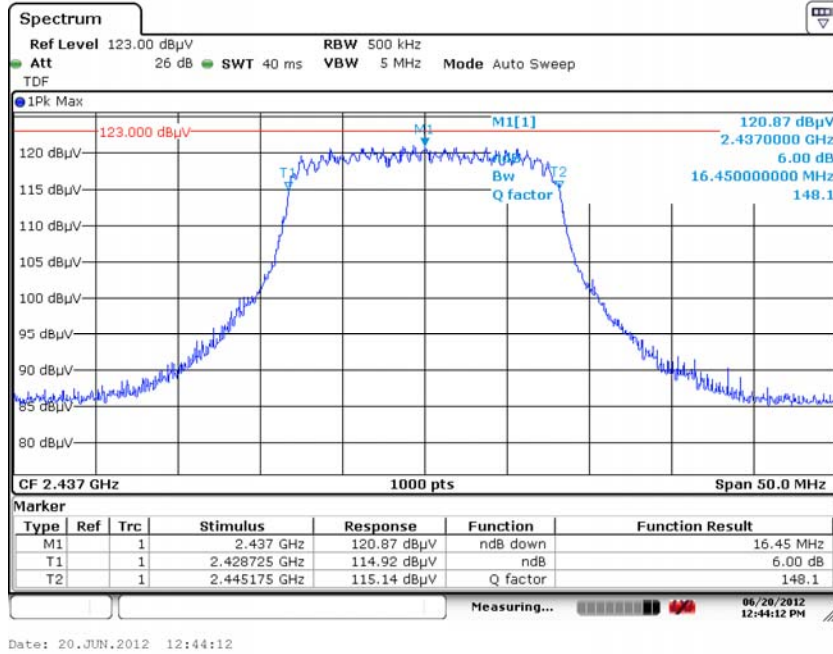

6.2.6. High Channel – 11 – 802.11g

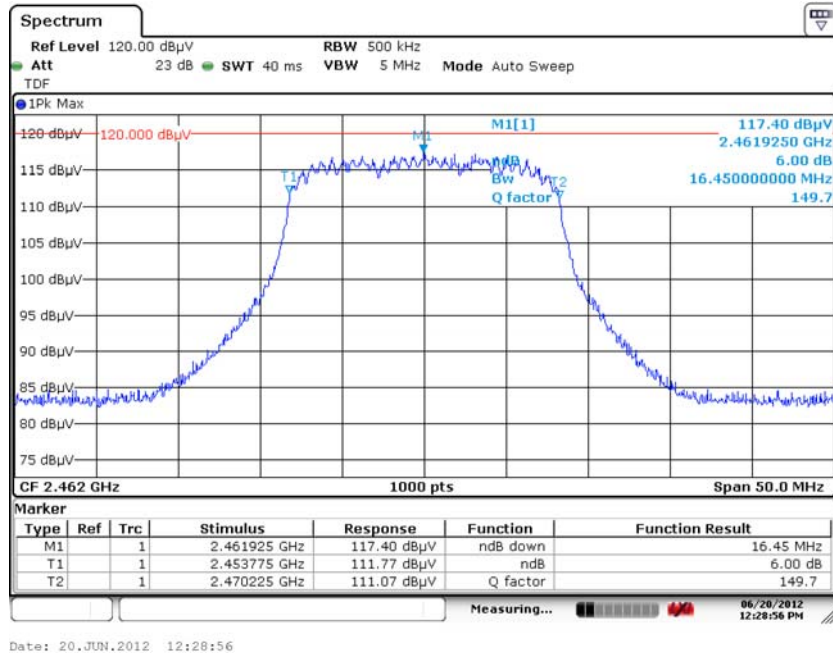

7. Measurement Data (continued)

7.2. Minimum 6 dB Bandwidth (15.247 (a) (2)) (continued)

6.2.7. Low Channel – 1 – 802.11n HT20

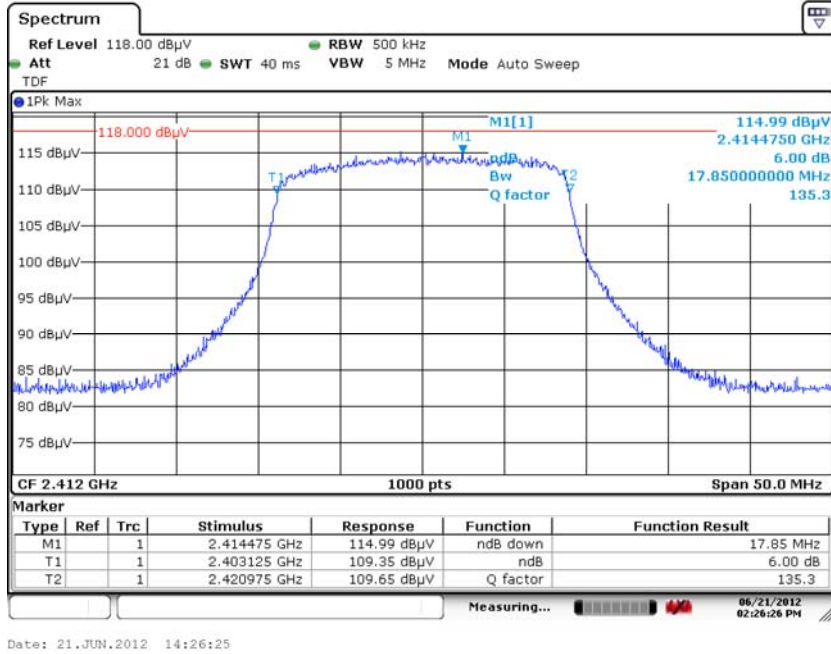

6.2.8. Mid Channel – 6 – 802.11n HT20

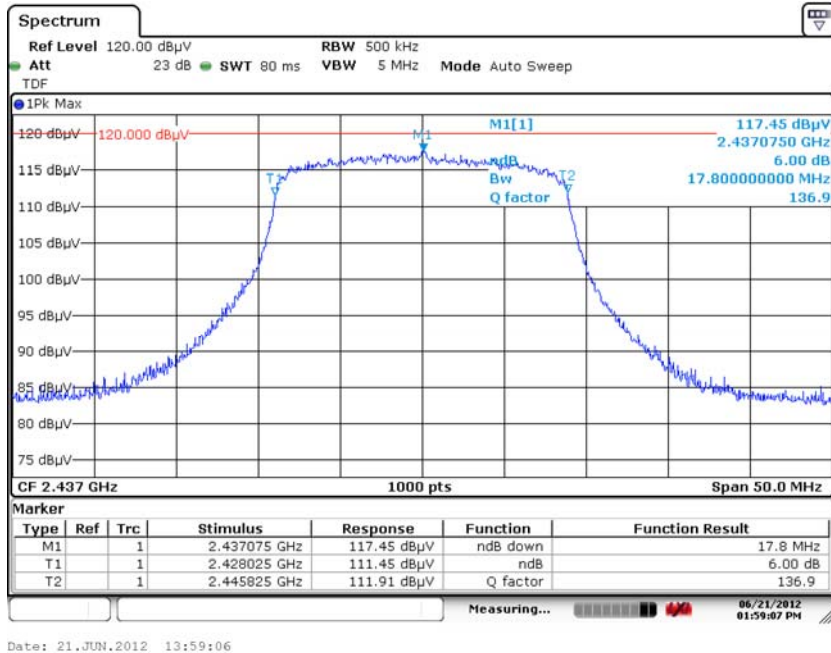

7. Measurement Data (continued)

7.2. Minimum 6 dB Bandwidth (15.247 (a) (2)) (continued)

6.2.9. High Channel – 11 – 802.11n HT20

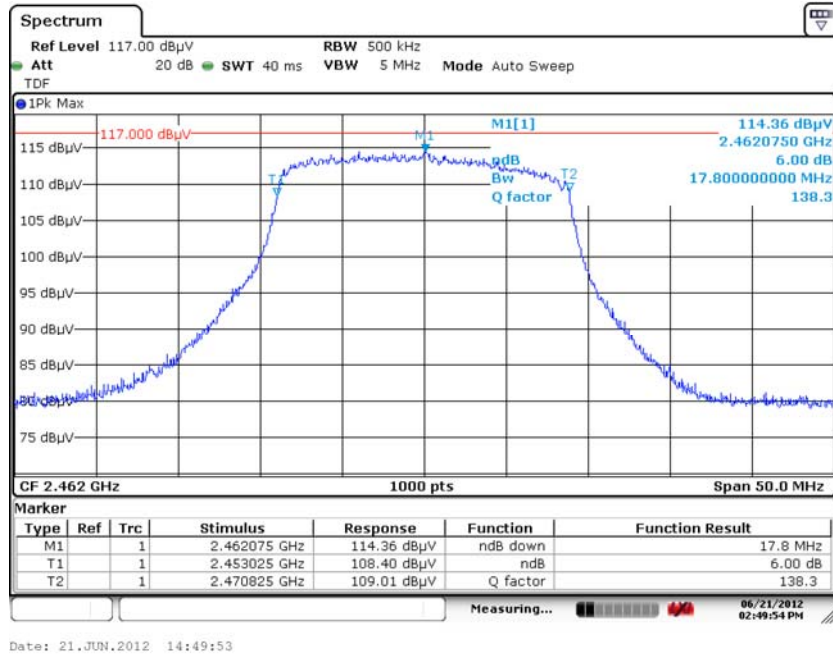

6.2.10. Low Channel – 3 – 802.11n HT40

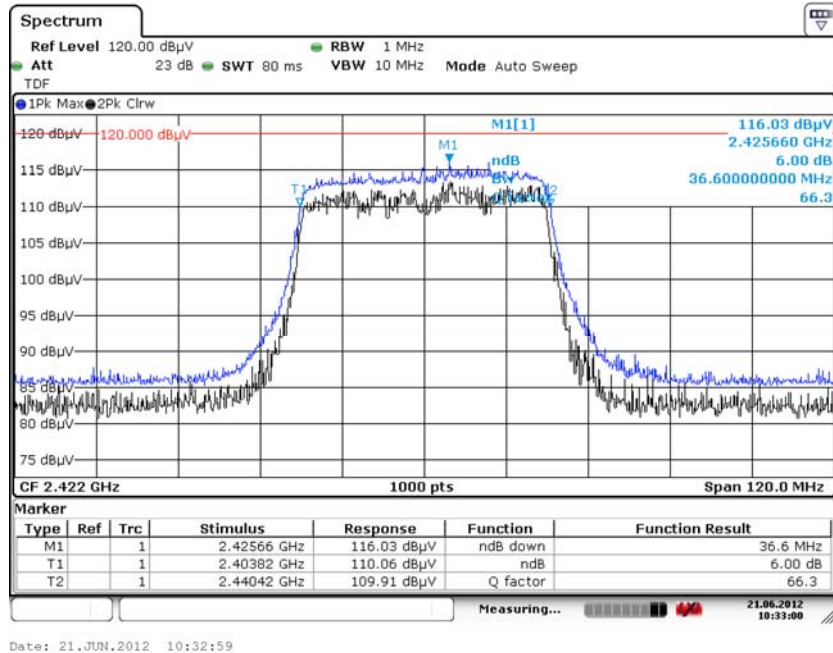

7. Measurement Data (continued)

7.2. Minimum 6 dB Bandwidth (15.247 (a) (2)) (continued)

6.2.11. Mid Channel – 6 – 802.11n HT40

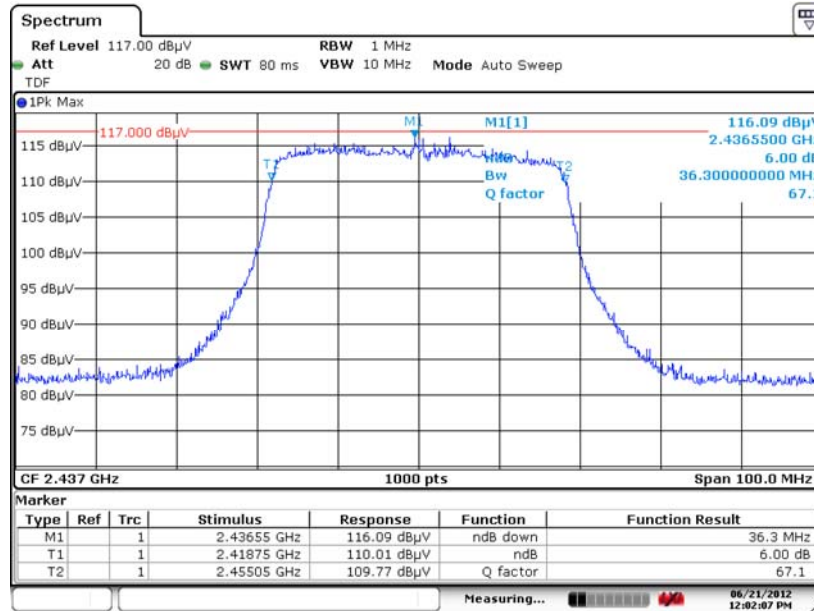

6.2.12. High Channel – 9 – 802.11n HT40

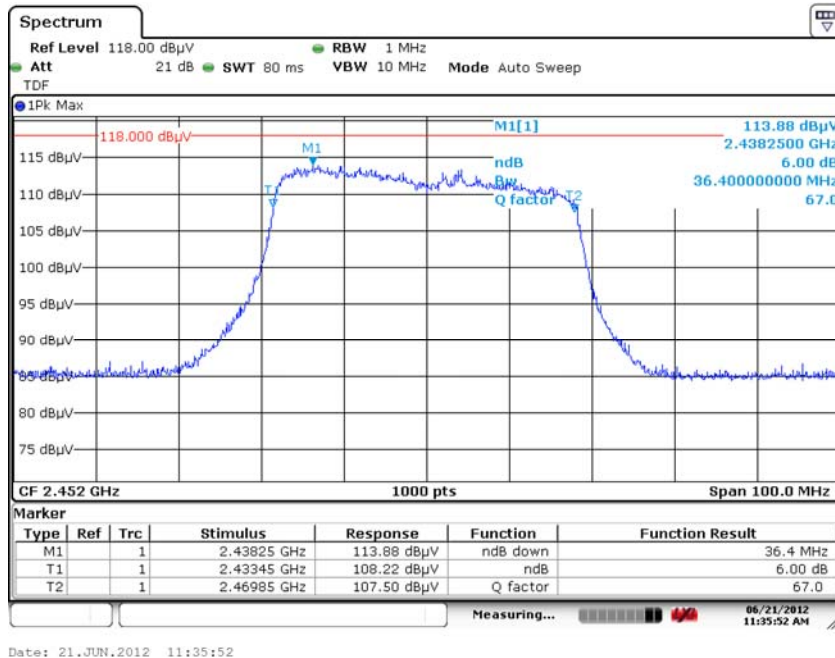

7. Measurement Data

7.2. Minimum 6 dB Bandwidth (cont)

Requirement: (15.247 (a) (2), RSS 210 A8.2(a))

Systems using digital modulation techniques may operate in the 902 - 928 MHz, 2400 - 2483.5 MHz, and 5725 - 5850 MHz bands. The minimum 6 dB bandwidth shall be at least 500 kHz.

Procedure: This test was performed in accordance with the procedure detailed in FCC OET publication number 558074, Section 5.1, clause 5.1.1: Alternate EBW Measurement Procedure.

Conclusion: The device under test meets the minimum 500 kHz 6 dB bandwidth requirement.

Measurement Results for 5725 to 5850 MHz Band

802.11a Mode Channel	Frequency (MHz)	-6 dB Bandwidth (kHz)	Minimum -6 dB Bandwidth (kHz)	Result
Low	5745	16450	>500	Compliant
Middle	5785	16200	>500	Compliant
High	5825	16600	>500	Compliant

HT20 Mode Channel	Frequency (MHz)	-6 dB Bandwidth (kHz)	Minimum -6 dB Bandwidth (kHz)	Result
Low	5745	17850	>500	Compliant
Middle	5785	17900	>500	Compliant
High	5825	17850	>500	Compliant

HT40 Mode Channel	Frequency (MHz)	-6 dB Bandwidth (kHz)	Minimum -6 dB Bandwidth (kHz)	Result
Low	5745	36000	>500	Compliant
High	5795	37100	>500	Compliant

7. Measurement Data

7.2. Minimum 6 dB Bandwidth (15.247 (a) (2)) (continued)

6.2.13. Low Channel – 149 – 802.11a

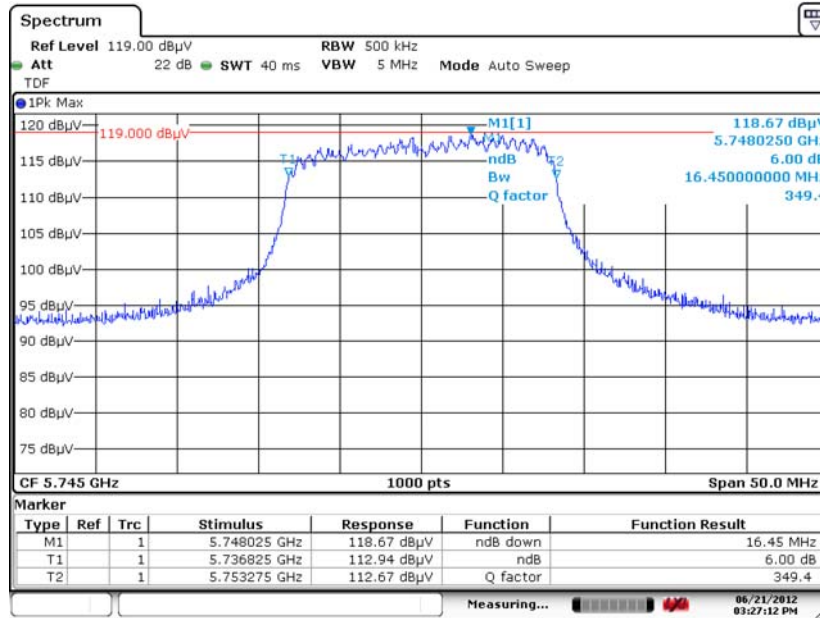

6.2.14. Mid Channel – 153 – 802.11a

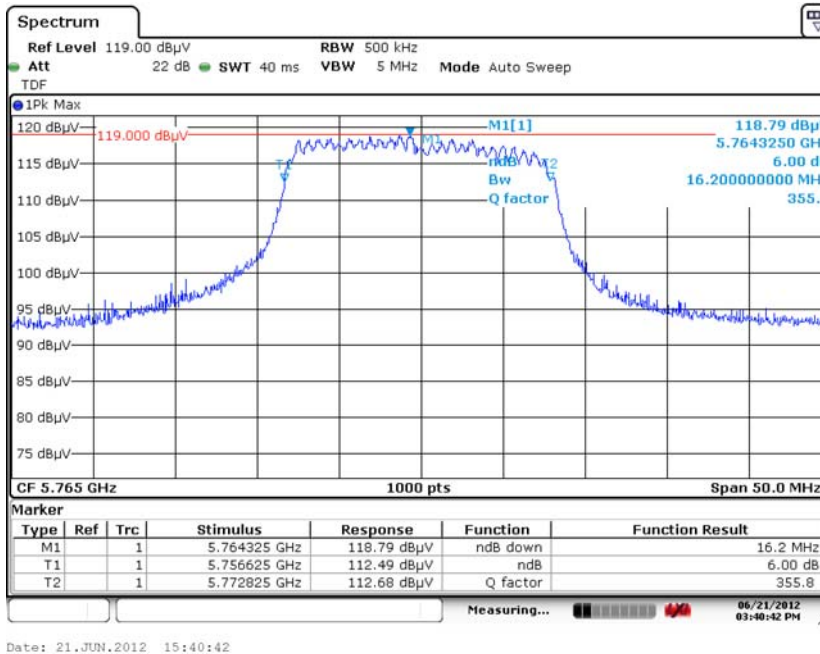

7. Measurement Data (continued)

7.2. Minimum 6 dB Bandwidth (15.247 (a) (2)) (continued)

6.2.15. High Channel – 165 – 802.11a

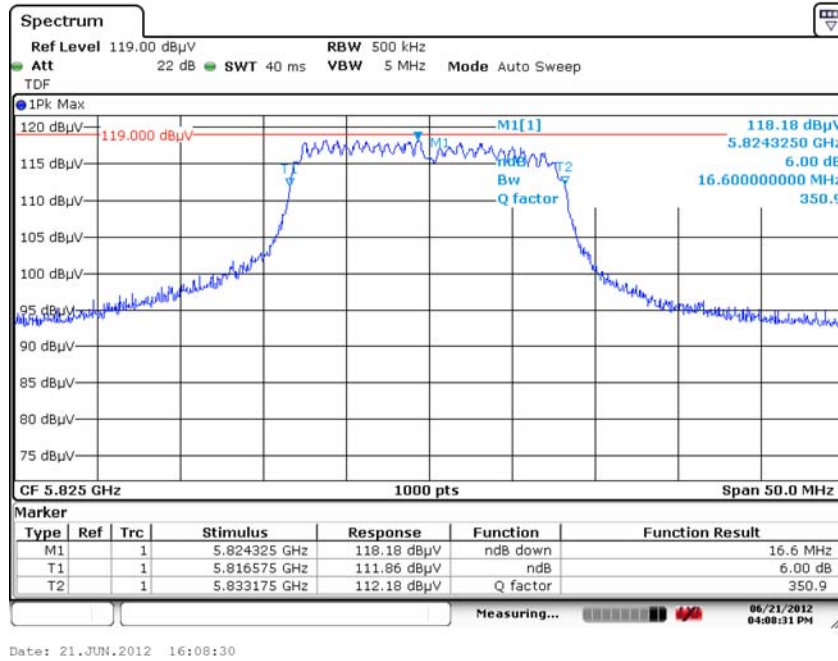

6.2.16. Low Channel – 149 – 802.11n HT20

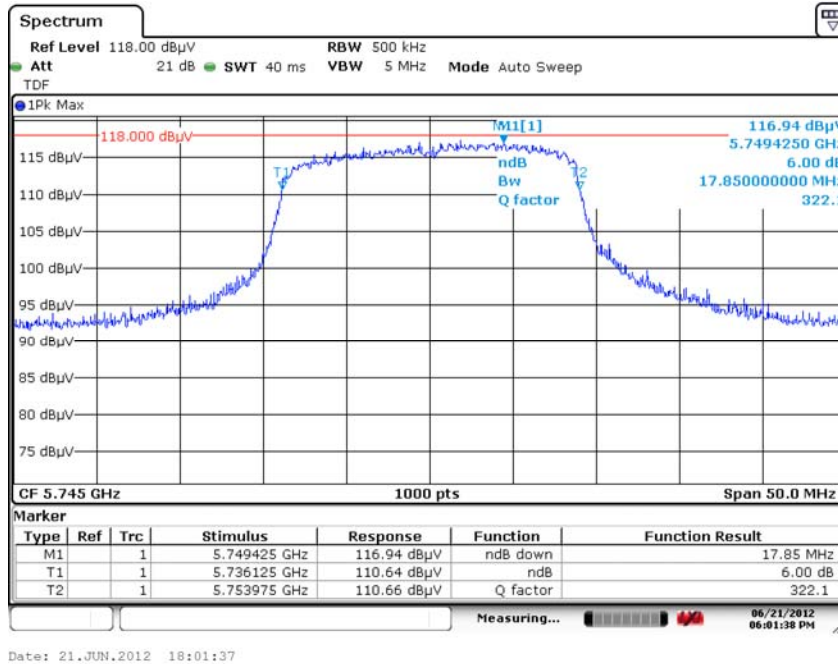

7. Measurement Data (continued)

7.2. Minimum 6 dB Bandwidth (15.247 (a) (2)) (continued)

6.2.17. Mid Channel – 157 – 802.11n HT20

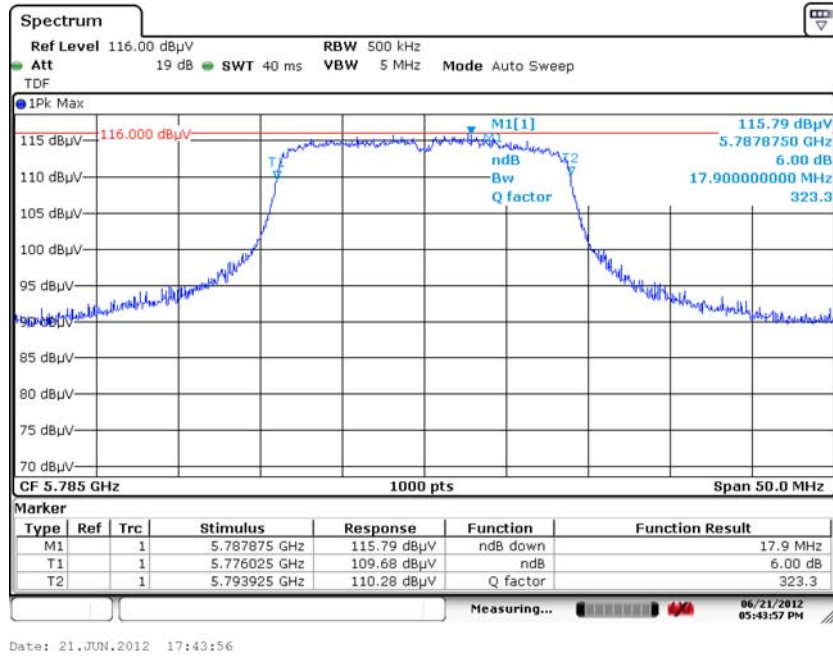

6.2.18. High Channel – 165 – 802.11n HT20

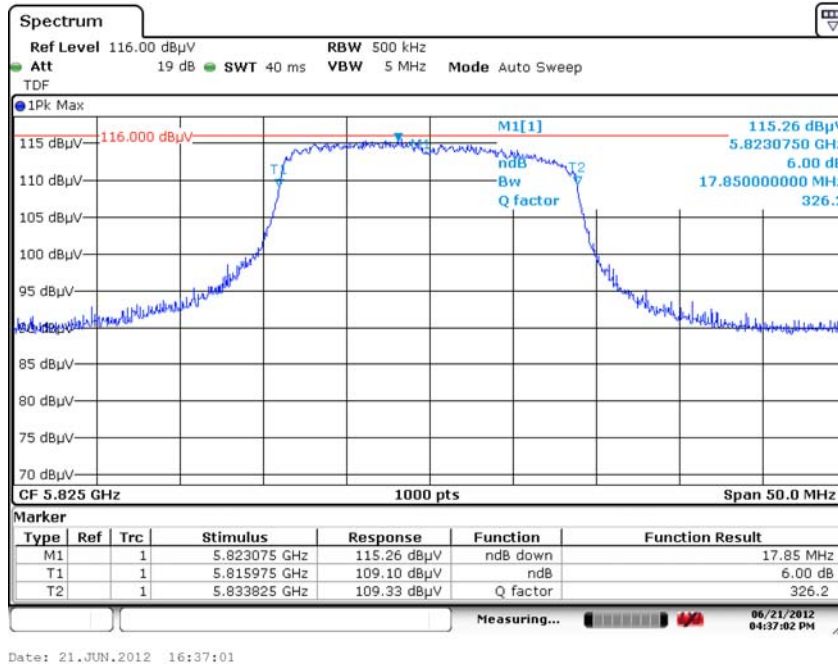

7. Measurement Data (continued)

7.2. Minimum 6 dB Bandwidth (15.247 (a) (2)) (continued)

6.2.19. Low Channel – 151 – 802.11n HT40

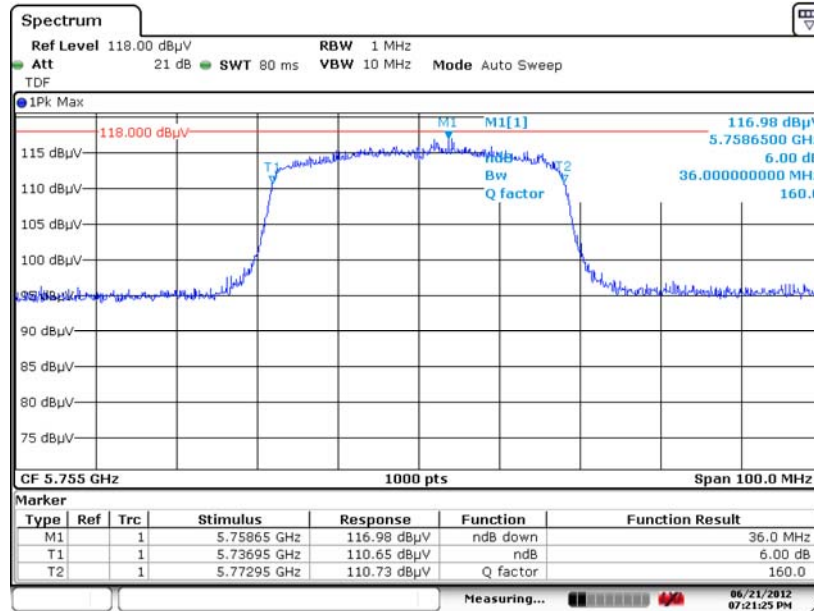

Date: 21.JUN.2012 19:21:24

6.2.20. High Channel – 159 – 802.11n HT40

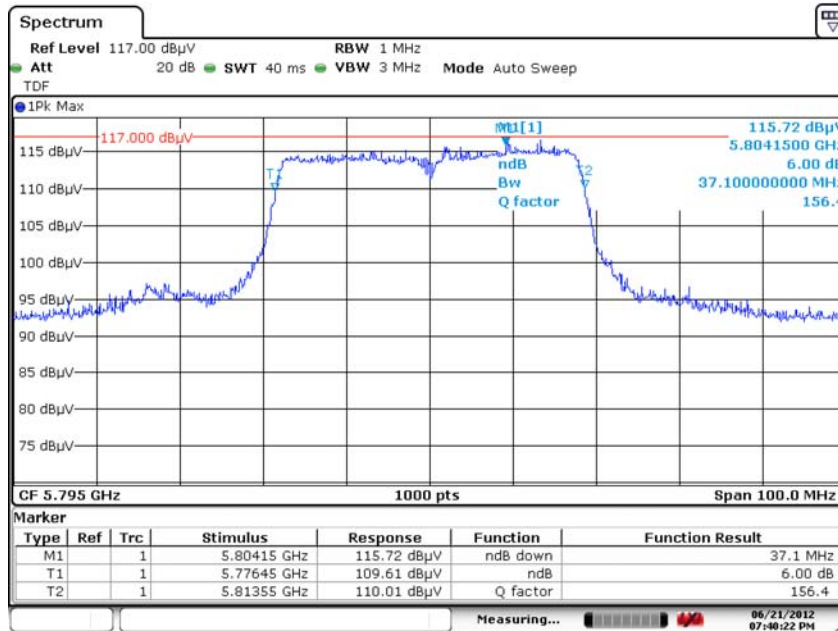

Date: 21.JUN.2012 19:40:21

7. Measurement Data (continued)

7.3. 99% Bandwidth (RSS 210)

Requirement: When an occupied bandwidth value is not specified in the applicable RSS, the transmitted signal bandwidth to be reported is to be its 99% emission bandwidth, as calculated or measured. The resolution bandwidth shall be set to as close to 1% of the selected span as is possible without being below 1%. The video bandwidth shall be set to 3 times the resolution bandwidth.

Procedure: This test was performed utilizing the automated 99% bandwidth function of the spectrum analyzer.

Conclusion: The device under test meets the required 99% bandwidth.

Measured results in 2400 to 2483.5 MHz Band

802.11b Mode Channel	Channel Frequency (MHz)	99% Power Bandwidth (MHz)
Low	2412	15.640
Middle	2437	15.750
High	2462	15.650

802.11g Mode Channel	Channel Frequency (MHz)	99% Power Bandwidth (MHz)
Low	2412	17.450
Middle	2437	17.400
High	2462	17.300

HT20 Mode Channel	Channel Frequency (MHz)	99% Power Bandwidth (MHz)
Low	2412	19.050
Middle	2437	18.850
High	2462	18.950

HT40 Mode Channel	Channel Frequency (MHz)	99% Power Bandwidth (MHz)
Low	2422	39.840
Middle	2437	37.900
High	2452	38.000

7. Measurement Data (continued)

7.3. 99% Bandwidth (RSS 210) (continued)

7.3.1. Low Channel – 1 – 802.11b

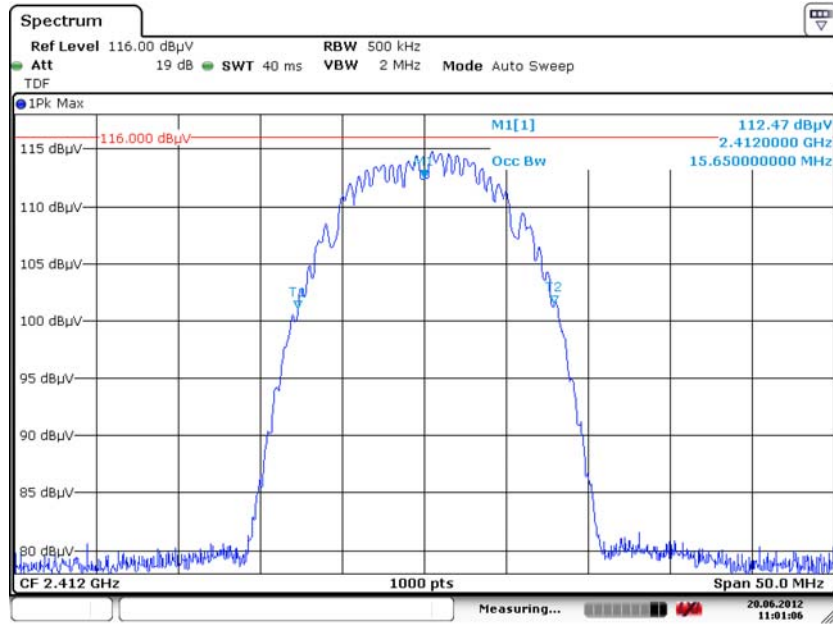

Date: 20.JUN.2012 11:01:06

7.3.2. Mid Channel – 6 – 802.11b

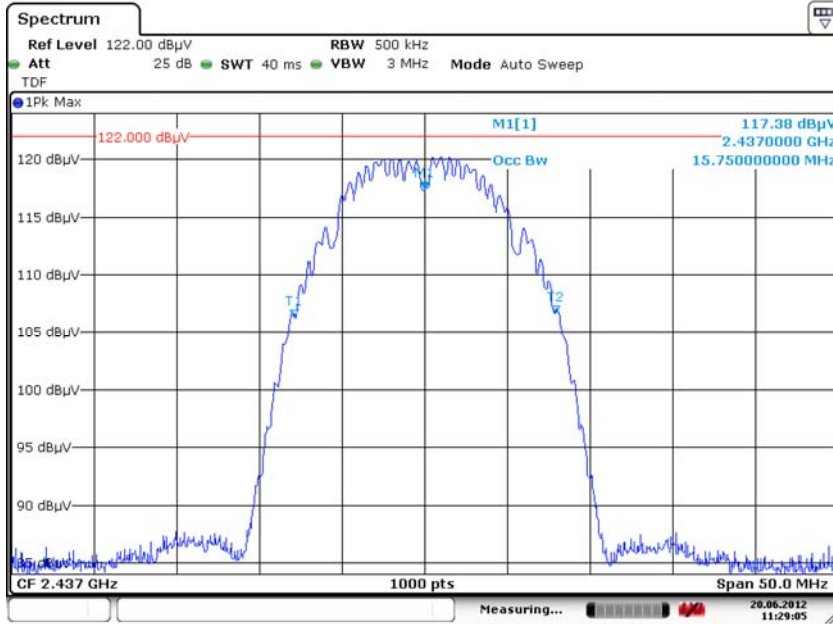

Date: 20.JUN.2012 11:29:05

7. Measurement Data (continued)

7.3. 99% Bandwidth (RSS 210) (continued)

7.3.3. High Channel – 11 – 802.11b

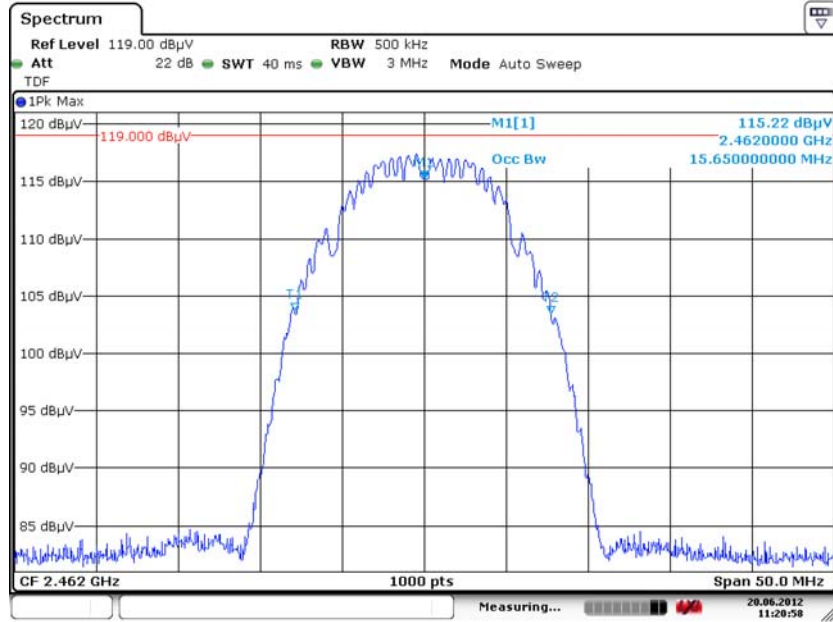

Date: 20 JUN.2012 11:20:57

7.3.4. Low Channel – 1 – 802.11g

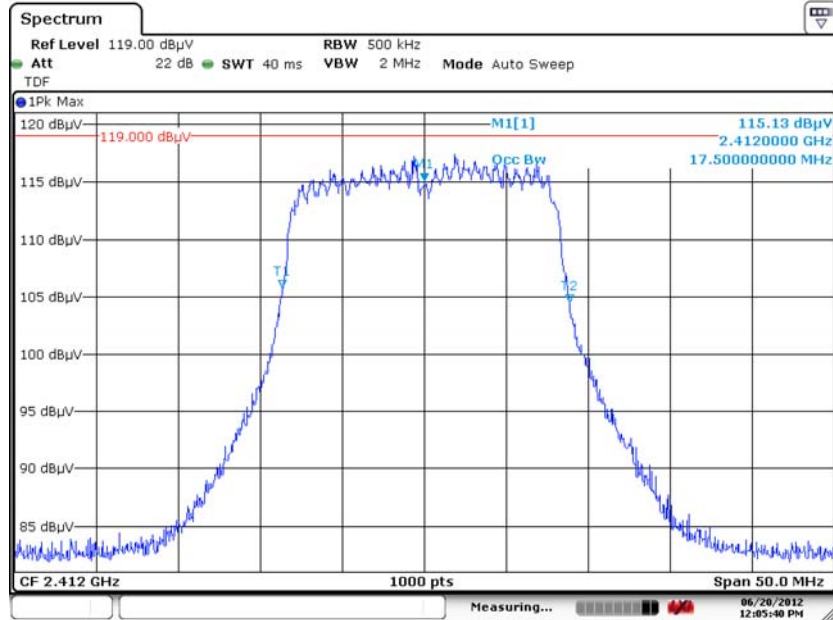

Date: 20 JUN.2012 12:05:40

7. Measurement Data (continued)

7.3. 99% Bandwidth (RSS 210) (continued)

7.3.5. Mid Channel – 6 – 802.11g

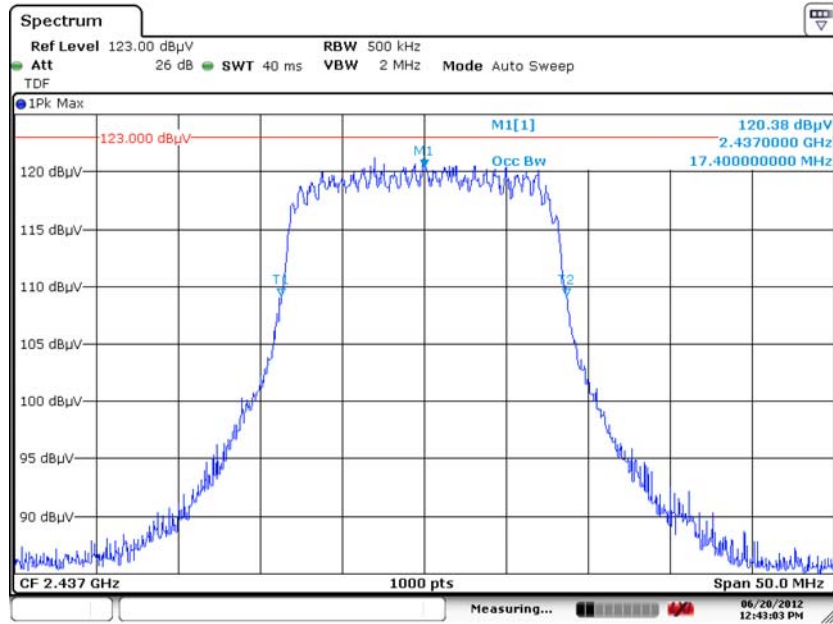

Date: 20 JUN.2012 12:43:02

7.3.6. High Channel – 11 – 802.11g

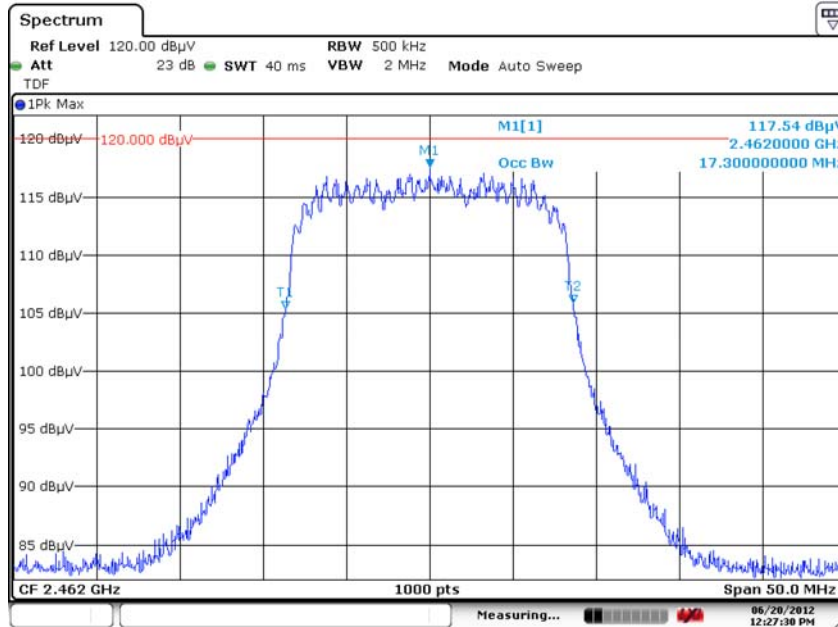

Date: 20 JUN.2012 12:27:29

7. Measurement Data (continued)

7.3. 99% Bandwidth (RSS 210) (continued)

7.3.7. Low Channel – 1 – 802.11n HT20

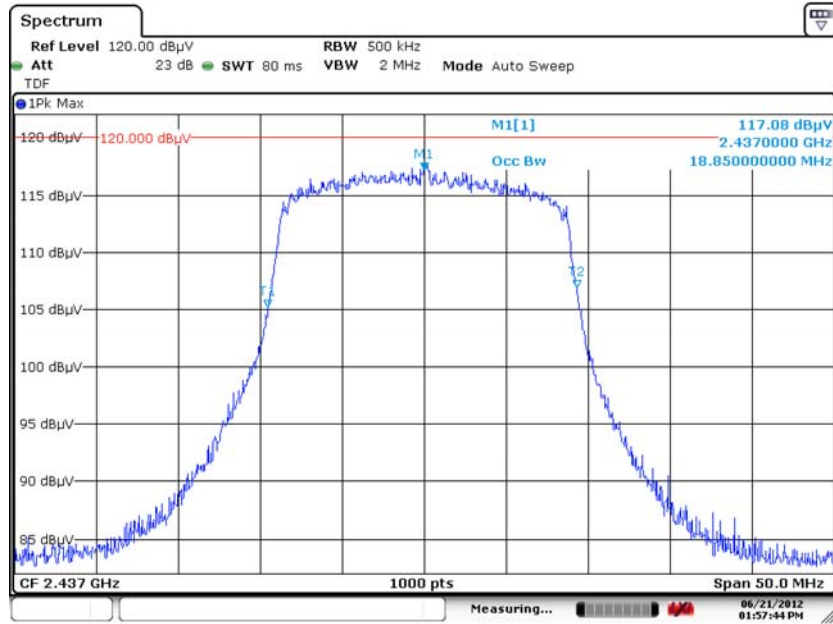

Date: 21 JUN.2012 13:57:44

7.3.8. Mid Channel – 6 – 802.11n HT20

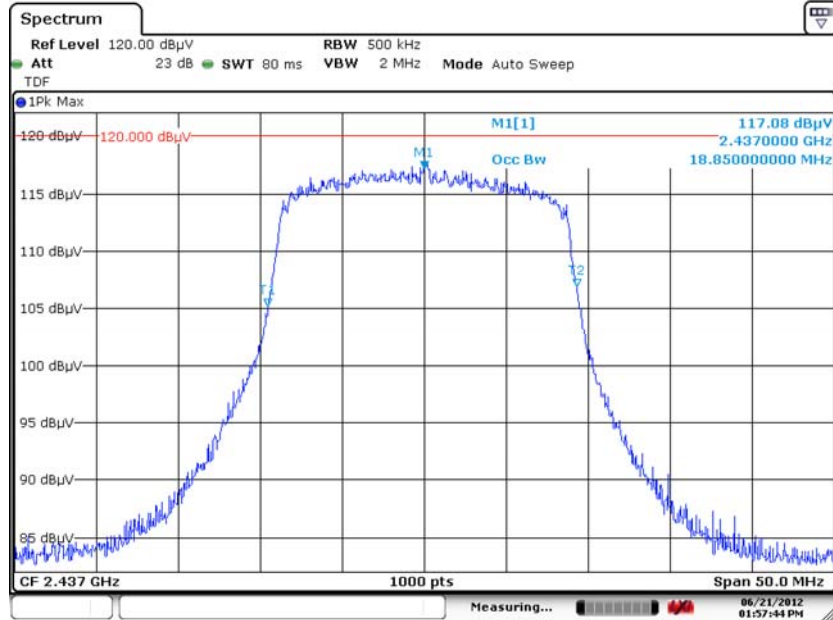

Date: 21 JUN.2012 13:57:44

7. Measurement Data (continued)

7.3. 99% Bandwidth (RSS 210) (continued)

7.3.9. High Channel – 11 – 802.11n HT20

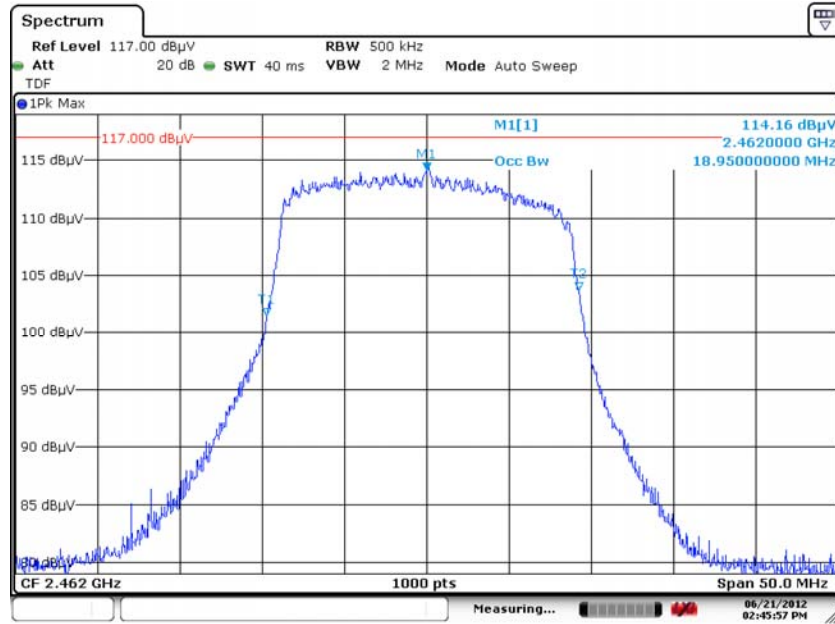

Date: 21.JUN.2012 14:45:56

7.3.10. Low Channel – 3 – 802.11n HT40

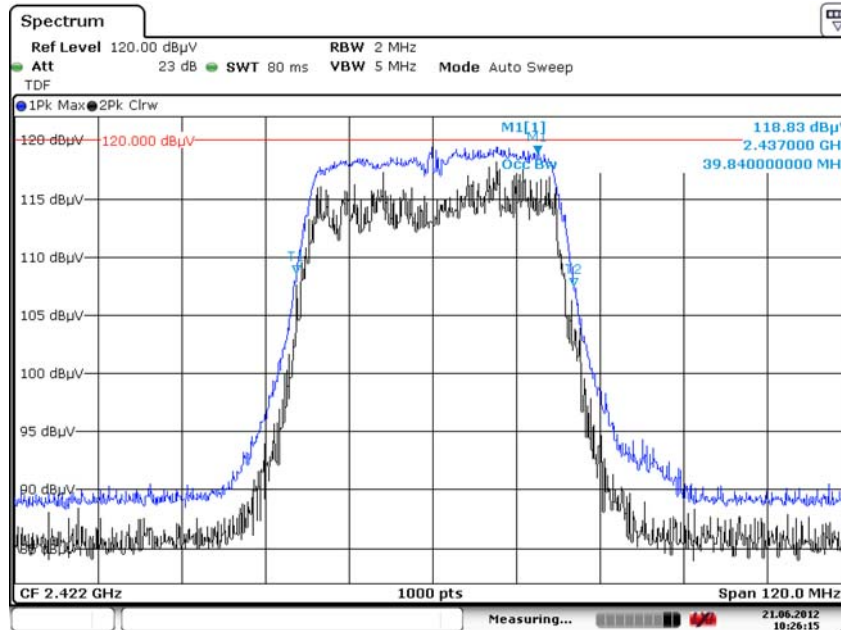

Date: 21.JUN.2012 10:26:15

7. Measurement Data (continued)

7.3. 99% Bandwidth (RSS 210) (continued)

7.3.11. Mid Channel – 6 – 802.11n HT40

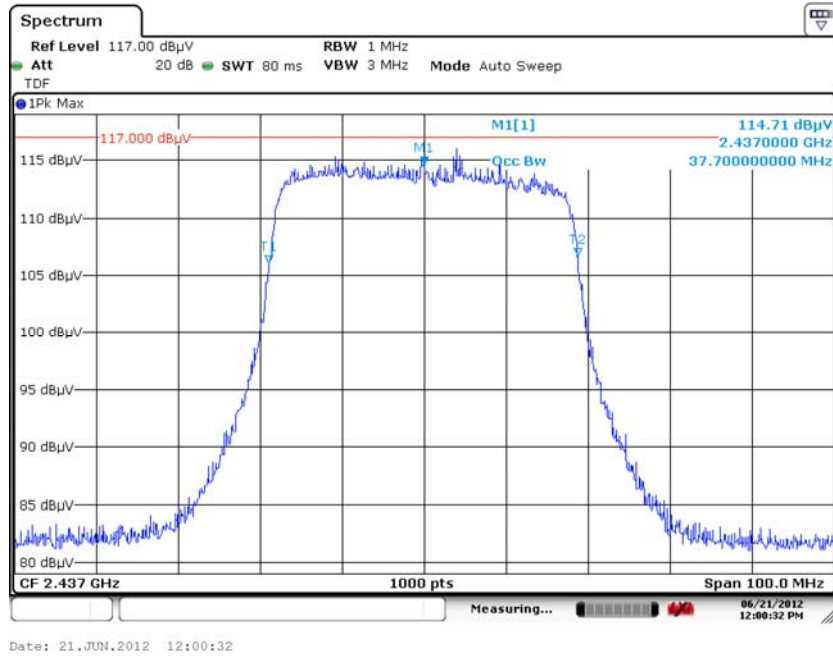

7.3.12. High Channel – 11 – 802.11n HT40

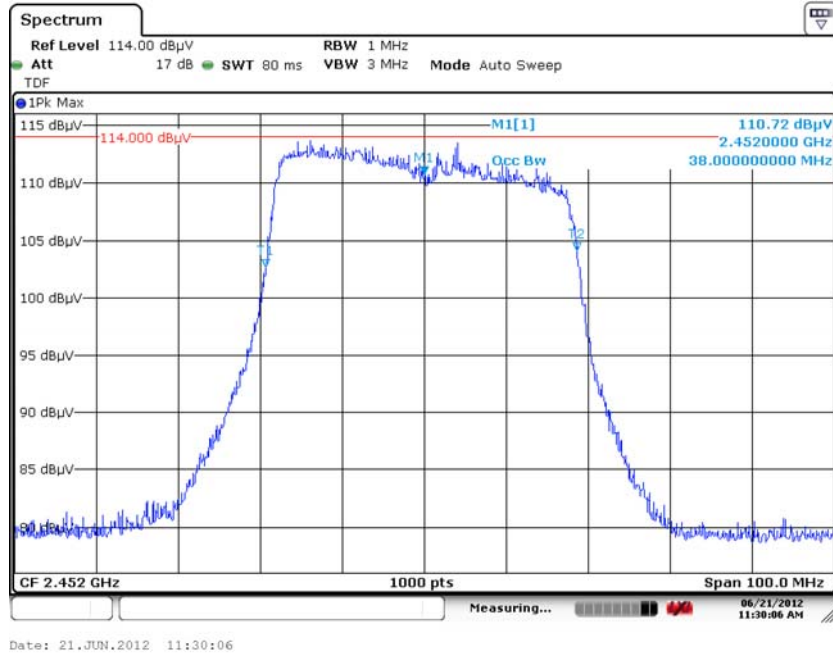

7. Measurement Data (continued)

7.3. 99% Bandwidth (RSS 210) (cont)

Requirement: When an occupied bandwidth value is not specified in the applicable RSS, the transmitted signal bandwidth to be reported is to be its 99% emission bandwidth, as calculated or measured. The resolution bandwidth shall be set to as close to 1% of the selected span as is possible without being below 1%. The video bandwidth shall be set to 3 times the resolution bandwidth.

Procedure: This test was performed utilizing the automated 99% bandwidth function of the spectrum analyzer.

Conclusion: The device under test meets the required 99% bandwidth.

Measured results in 5725 to 5850 MHz Band

802.11a Mode Channel	Channel Frequency (MHz)	99% Power Bandwidth (MHz)
Low	5745	23.900
Middle	5785	22.650
High	5825	25.500

HT20 Mode Channel	Channel Frequency (MHz)	99% Power Bandwidth (MHz)
Low	5745	25.700
Middle	5785	23.550
High	5825	22.400

HT40 Mode Channel	Channel Frequency (MHz)	99% Power Bandwidth (MHz)
Low	5755	45.600
High	5795	49.000

7. Measurement Data (continued)

7.3. 99% Bandwidth (RSS 210) (continued)

7.3.13. Low Channel – 149 – 802.11a

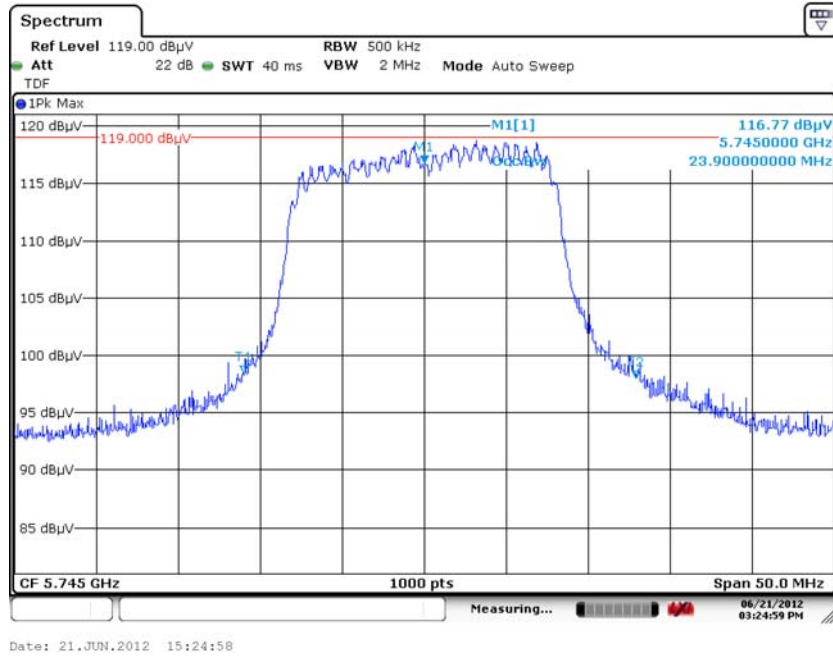

7.3.14. Mid Channel – 153 – 802.11a

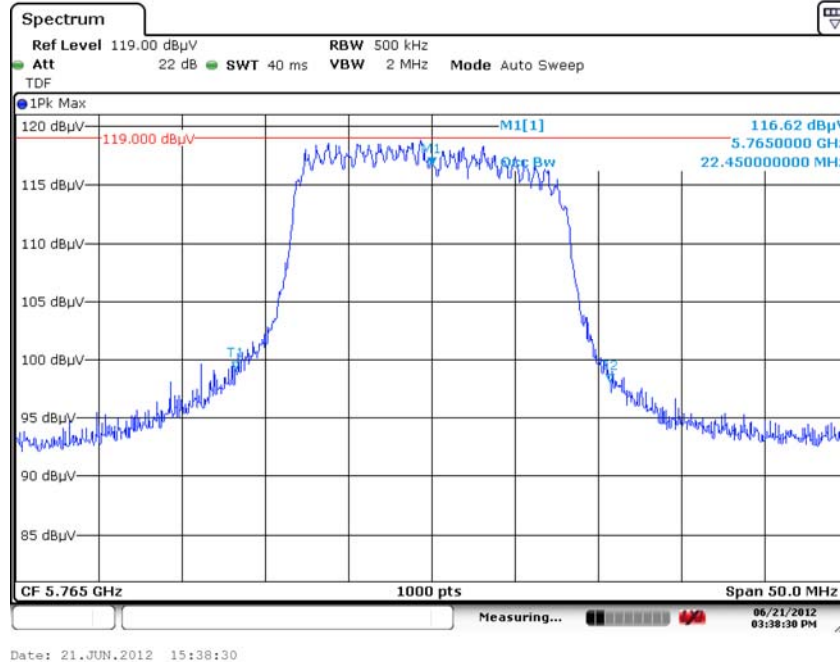

7. Measurement Data (continued)

7.3. 99% Bandwidth (RSS 210) (continued)

7.3.15. High Channel – 165 – 802.11a

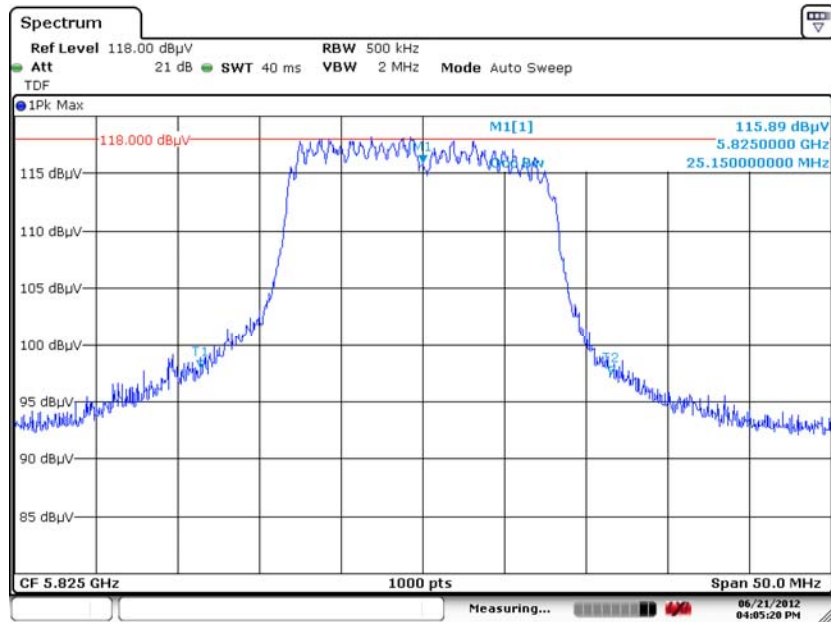

Date: 21.JUN.2012 16:05:19

7.3.16. Low Channel – 149 – 802.11n HT20

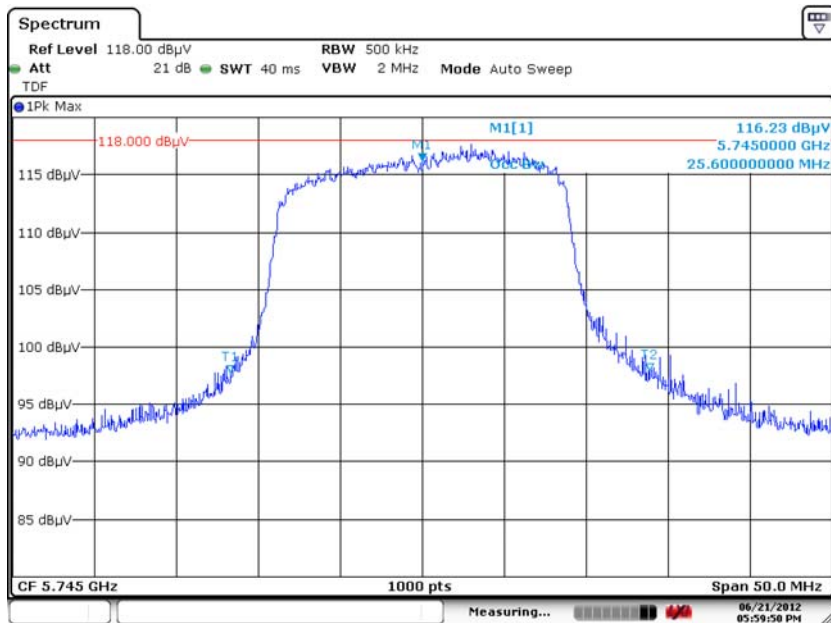

Date: 21.JUN.2012 17:59:49

7. Measurement Data (continued)

7.3. 99% Bandwidth (RSS 210) (continued)

7.3.17. Mid Channel – 157 – 802.11n HT20

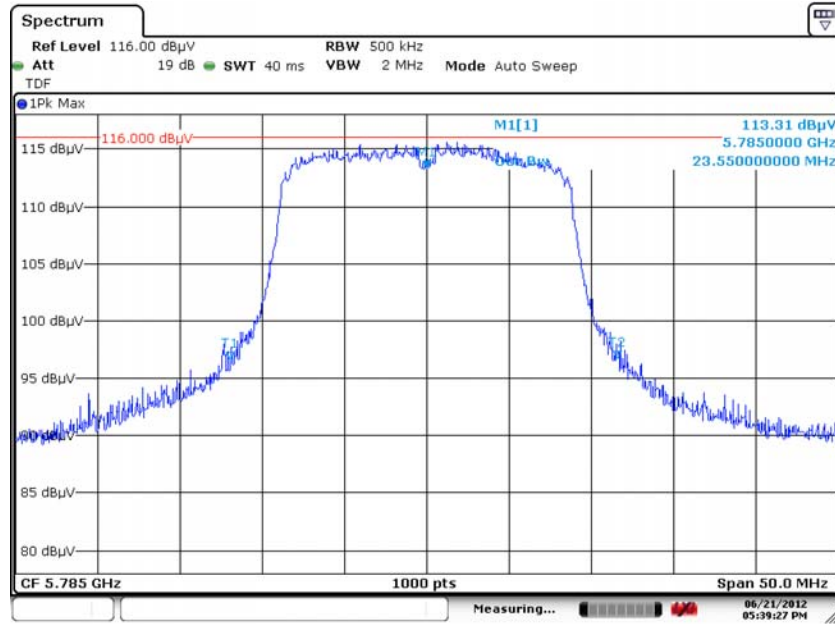

Date: 21.JUN.2012 17:39:26

7.3.18. High Channel – 165 – 802.11n HT20

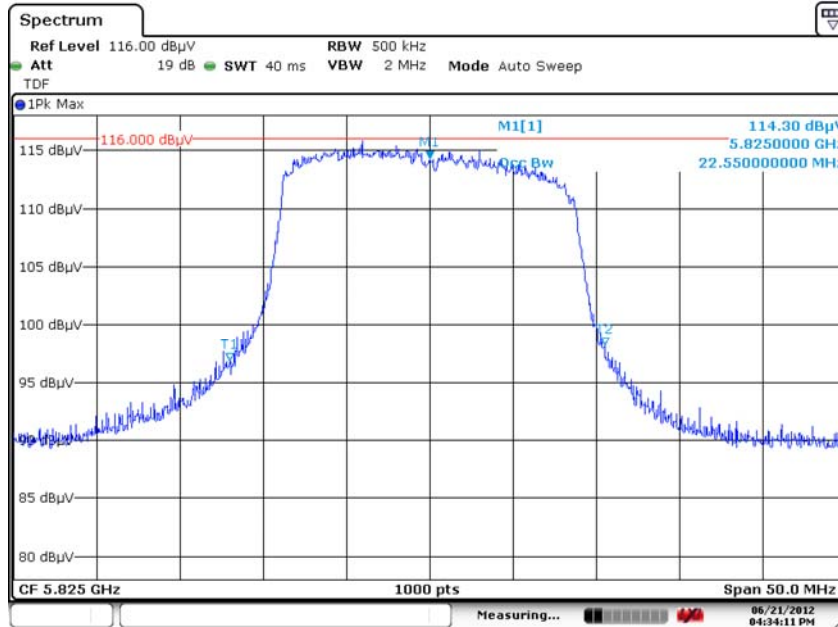

Date: 21.JUN.2012 16:34:10

7. Measurement Data (continued)

7.3. 99% Bandwidth (RSS 210) (continued)

7.3.19. Low Channel – 151 – 802.11n HT40

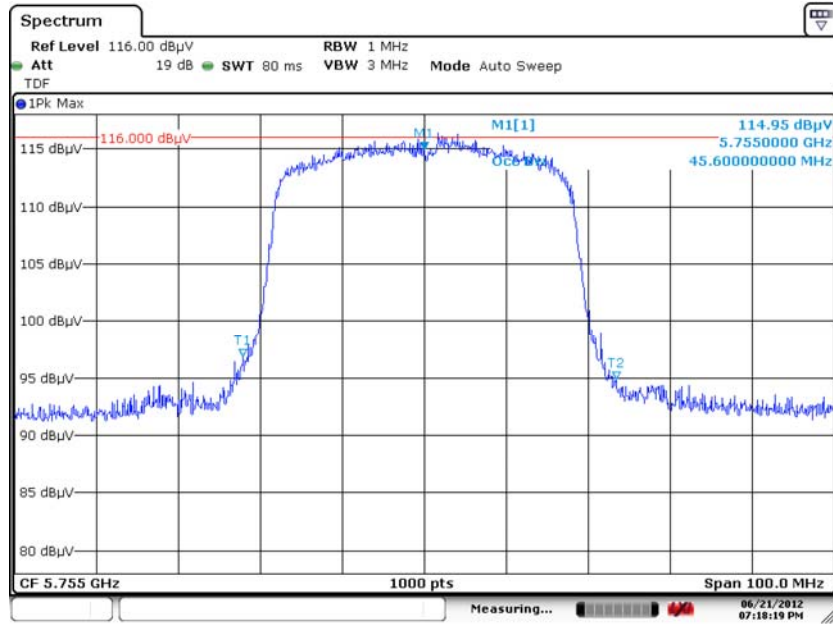

Date: 21.JUN.2012 19:18:18

7.3.20. High Channel – 159 – 802.11n HT40

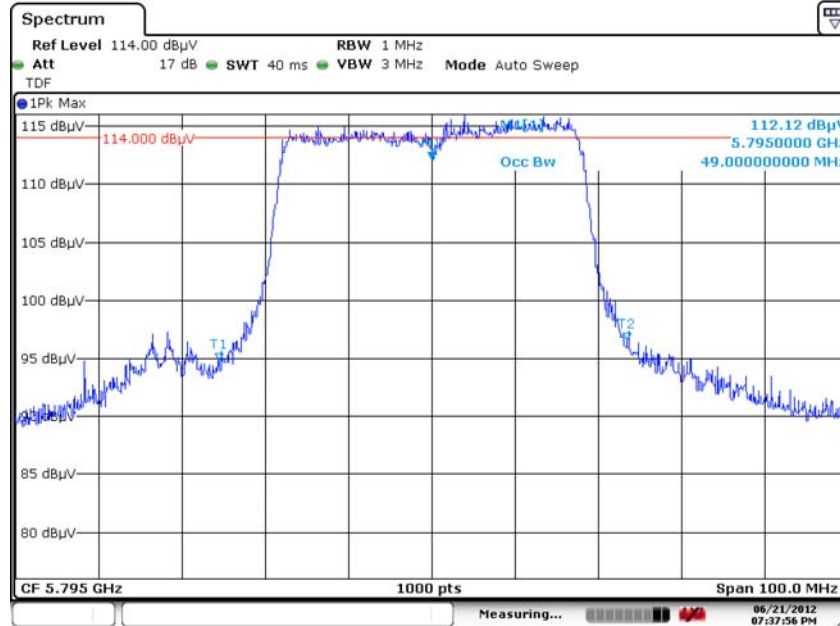

Date: 21.JUN.2012 19:37:56

7. Measurement Data (continued)

7.4. Maximum Peak Conducted Output Power

Requirement: (15.247 (b) (3))

The maximum peak conducted output power of the intentional radiator shall not exceed the following: For systems using digital modulation in the 902–928 MHz, 2400–2483.5 MHz, and 5725–5850 MHz bands: 1 Watt.

Procedure: This test was performed in accordance with the procedure detailed in FCC OET publication number 558074 D-1v-1 (2012), Section 5.2, clause 5.2.1.2: Measurement Procedure PK2.

Measurements were made in the worse case radiated mode / receive antenna polarity. FCC OET publication number 412172 formula for converting radiated field strength to EIRP was used.

Using the Rohde & Schwarz FSV40 band power function the integrated peak power was measured. The band power function span is determined by using the 6 dB Emission Bandwidth (EBW) measured in Section 7.2 of this report.

Since a field strength measurement is being performed, 107 is added to the dBm band power function measurement to convert the value back to field strength value. The field strength value then is used along with the gain of the antenna to determine the conducted output power of the transmitter.

The output power was determined from the measured field strength using the following equation:

$$P = \frac{(E \times d)^2}{(30 \times G)}$$

- P = the power in Watts (power has been converted to milliwatts in the table).
- E = the measured maximum field in V/m.
- G = the numeric gain of the transmitting antenna over an isotropic radiator.
- d = the distance in meters of the field strength measurement.

Conclusion: The device under test meets the required maximum peak conducted output power level of 1 Watt.

7. Measurement Data (continued)

7.4. Maximum Peak Conducted Output Power

7.4.1 Measurement Results for 2400 to 2483.5 MHz Band

802.11b Mode Channel	Frequency	Peak Integrated Field Strength	Distance	Antenna Gain ¹		Measured Peak Output Power	Output Power Limit	Result
	(MHz)	(dBµV/m)	(d)	(dBi)	(numeric)	(mW)	(mW)	
Low	2412	126.46	3.0	12.50	17.783	74.67	630.96	Compliant
Middle	2437	131.94	3.0	12.50	17.783	263.71	630.96	Compliant
High	2462	128.80	3.0	12.50	17.783	127.97	630.96	Compliant

802.11g Mode Channel	Frequency	Peak Integrated Field Strength	Distance	Antenna Gain ¹		Measured Peak Output Power	Output Power Limit	Result
	(MHz)	(dBµV/m)	(d)	(dBi)	(numeric)	(mW)	(mW)	
Low	2412	131.16	3.0	12.50	17.783	220.35	630.96	Compliant
Middle	2437	134.81	3.0	12.50	17.783	510.65	630.96	Compliant
High	2462	130.93	3.0	12.50	17.783	208.99	630.96	Compliant

802.11n HT20 Mode Channel	Frequency	Peak Integrated Field Strength	Distance	Antenna Gain ¹		Measured Peak Output Power	Output Power Limit	Result
	(MHz)	(dBµV/m)	(d)	(dBi)	(numeric)	(mW)	(mW)	
Low	2412	129.00	3.0	12.50	17.783	134.01	630.96	Compliant
Middle	2437	131.75	3.0	12.50	17.783	252.42	630.96	Compliant
High	2462	128.26	3.0	12.50	17.783	113.01	630.96	Compliant

802.11n HT40 Mode Channel	Frequency	Peak Integrated Field Strength	Distance	Antenna Gain ¹		Measured Peak Output Power	Output Power Limit	Result
	(MHz)	(dBµV/m)	(d)	(dBi)	(numeric)	(mW)	(mW)	
Low	2422	126.10	3.0	12.50	17.783	68.73	630.96	Compliant
Middle	2437	128.93	3.0	12.50	17.783	131.86	630.96	Compliant
High	2452	126.63	3.0	12.50	17.783	77.65	630.96	Compliant

¹ The Integrated Peak field strength was derived from the spectrum analyzer band power measurement function result and converted to dBµV/m by adding 107. Reference the following screen captures.

² Reference section 7.2 for the 6 dB emissions bandwidth.

7. Measurement Data (continued)

7.4. Maximum Peak Conducted Output Power (15.247 (b) (1)) (continued)

7.4.2. Low Channel – 1 – 802.11b

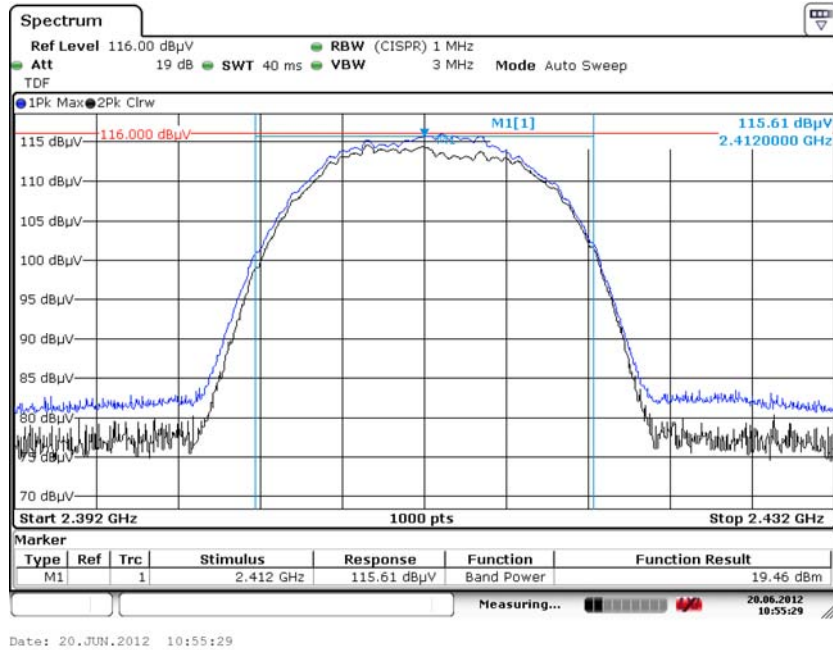

7.4.3. Middle Channel – 6 – 802.11b

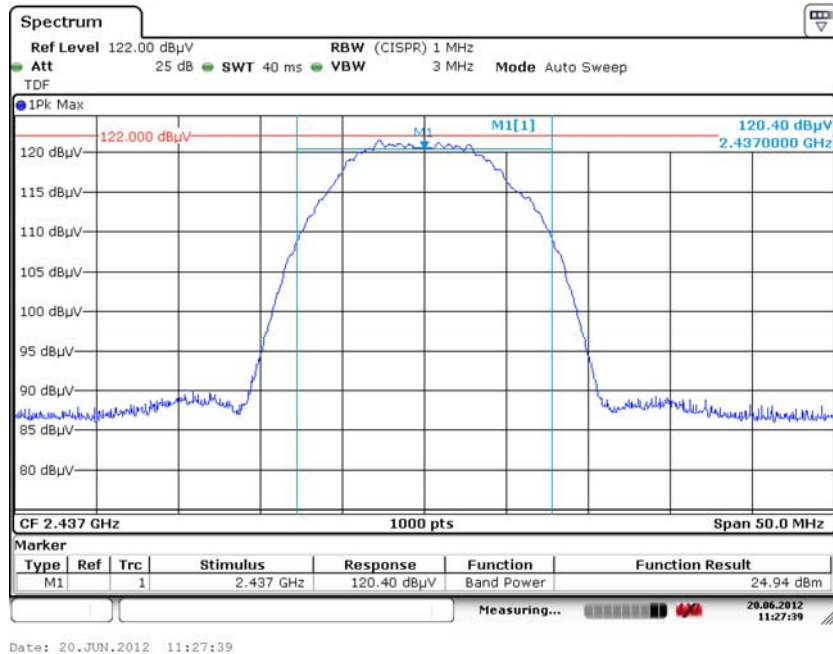

7. Measurement Data (continued)

7.4. Maximum Peak Conducted Output Power (15.247 (b) (1))

7.4.4. High Channel – 11 – 802.11b

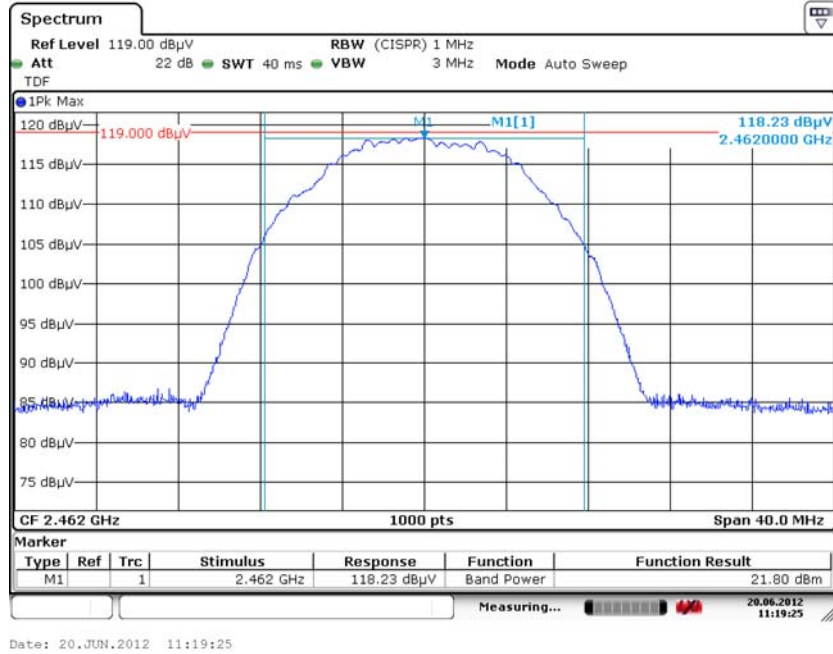

7.4.5. Low Channel – 1 – 802.11g

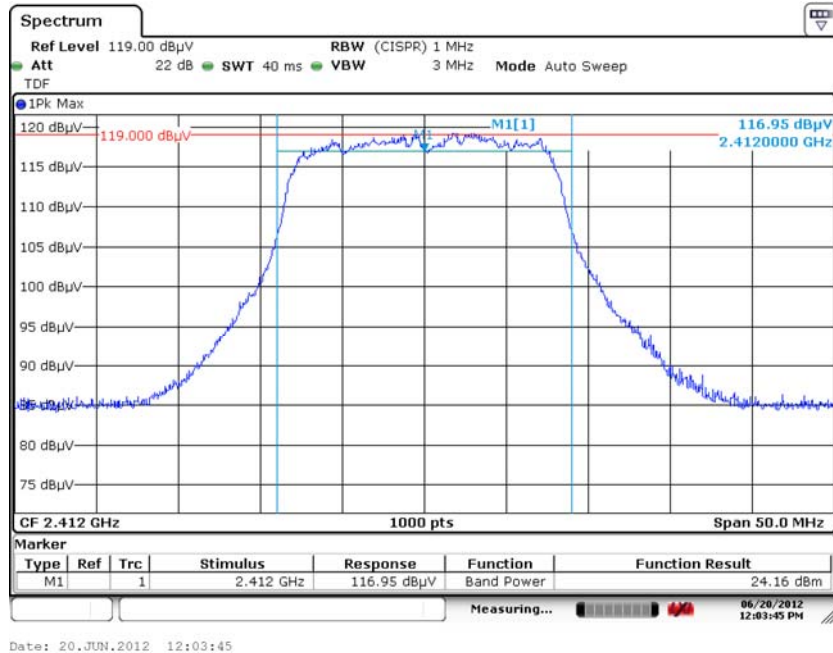

7. Measurement Data (continued)

7.4. Maximum Peak Conducted Output Power (15.247 (b) (1))

7.4.6. Mid Channel – 6 – 802.11g

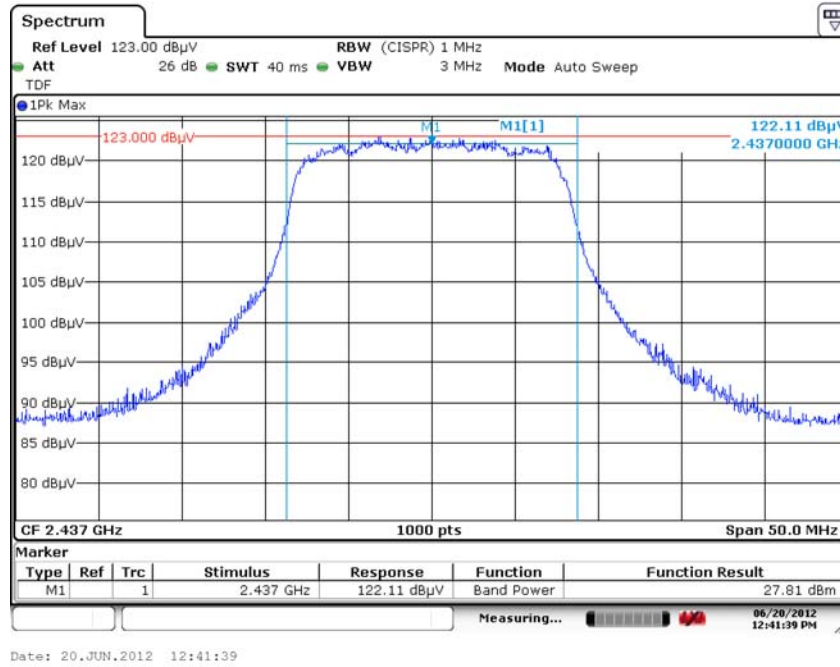

7.4.7. High Channel – 11 – 802.11g

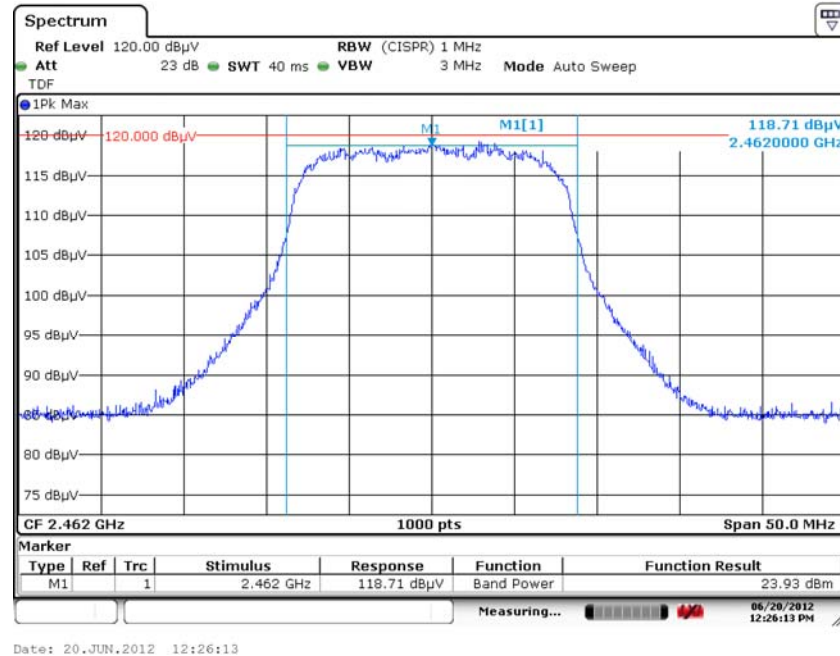

7. Measurement Data (continued)

7.4. Maximum Peak Conducted Output Power (15.247 (b) (1)) (continued)

7.4.8. Low Channel – 1 – 802.11n HT20

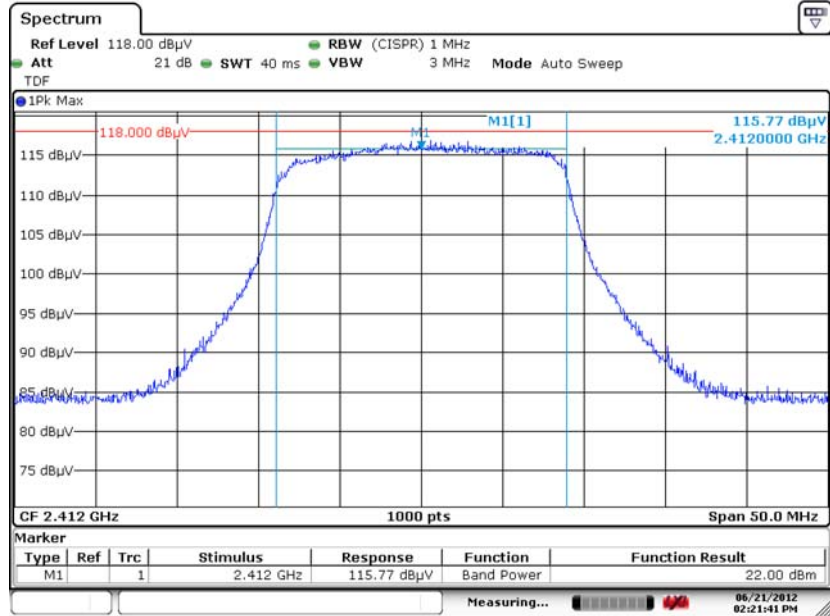

Date: 21.JUN.2012 14:21:41

7.4.9. Middle Channel – 6 – 802.11n HT20

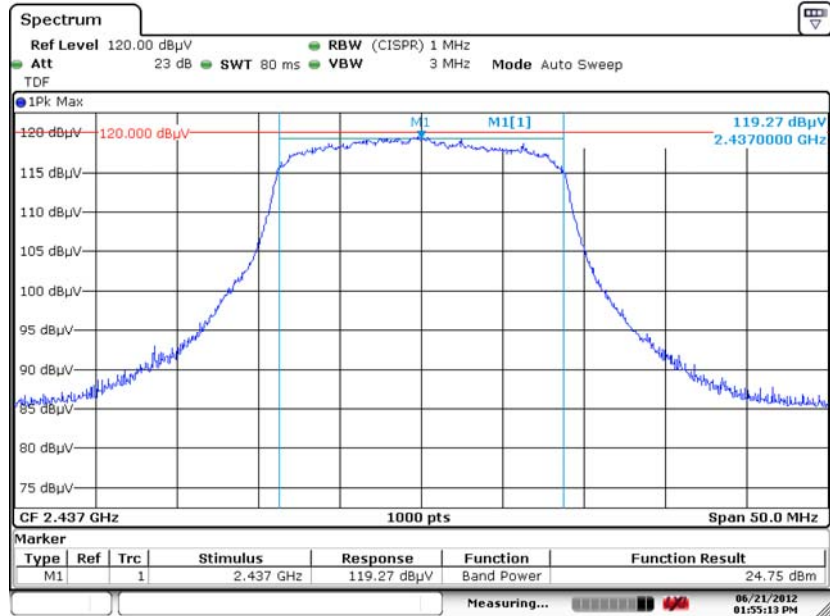

Date: 21.JUN.2012 13:55:13

7. Measurement Data (continued)

7.4. Maximum Peak Conducted Output Power (15.247 (b) (1))

7.4.10. High Channel – 11 – 802.11n HT20

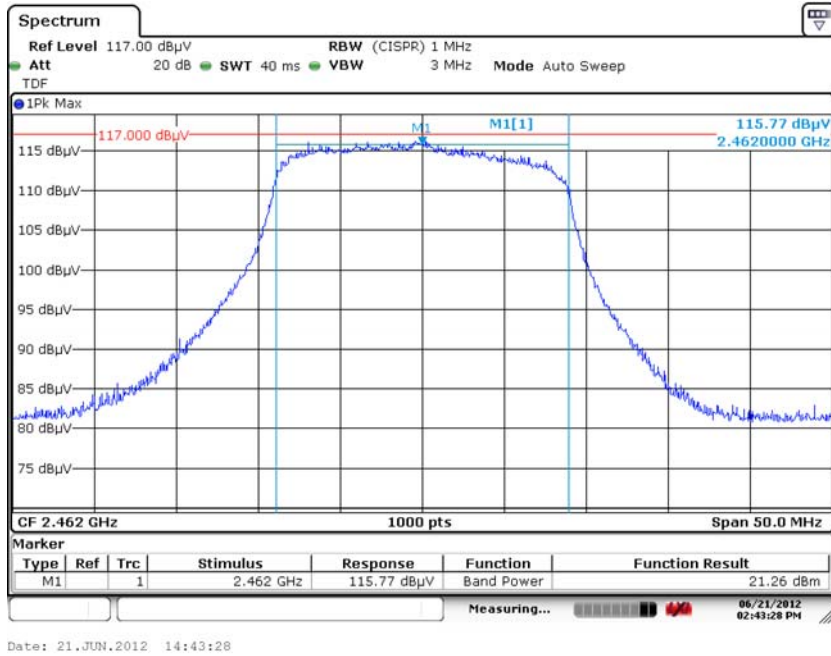

7.4.11. Low Channel – 3 – 802.11n HT40

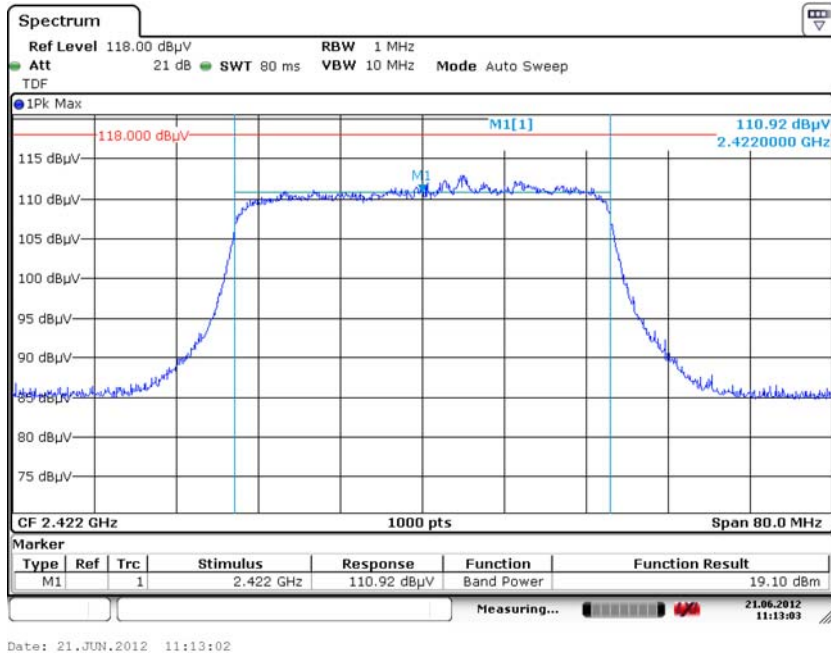

7. Measurement Data (continued)

7.4. Maximum Peak Conducted Output Power (15.247 (b) (1))

7.4.12. Mid Channel – 6 – 802.11n HT40

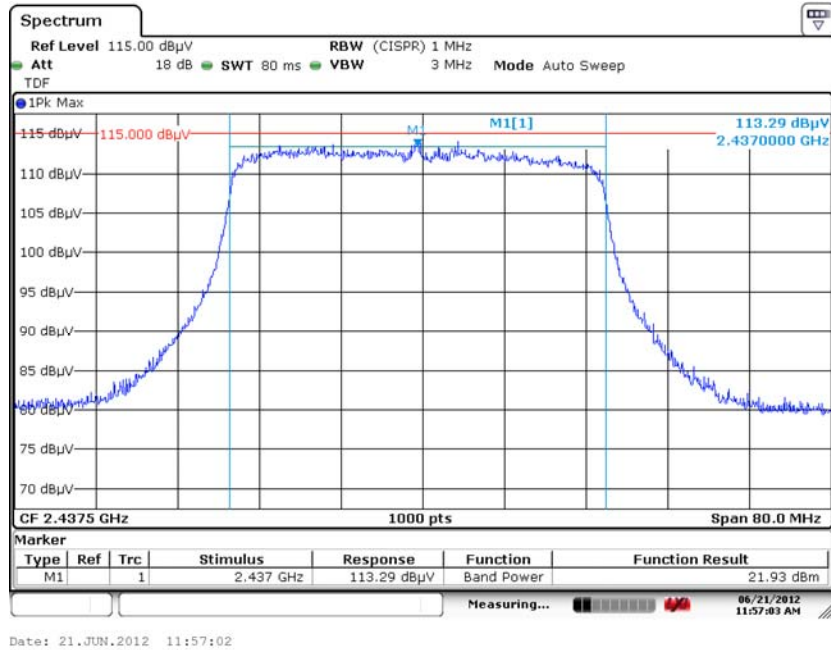

7.4.13. High Channel – 9 – 802.11n HT40

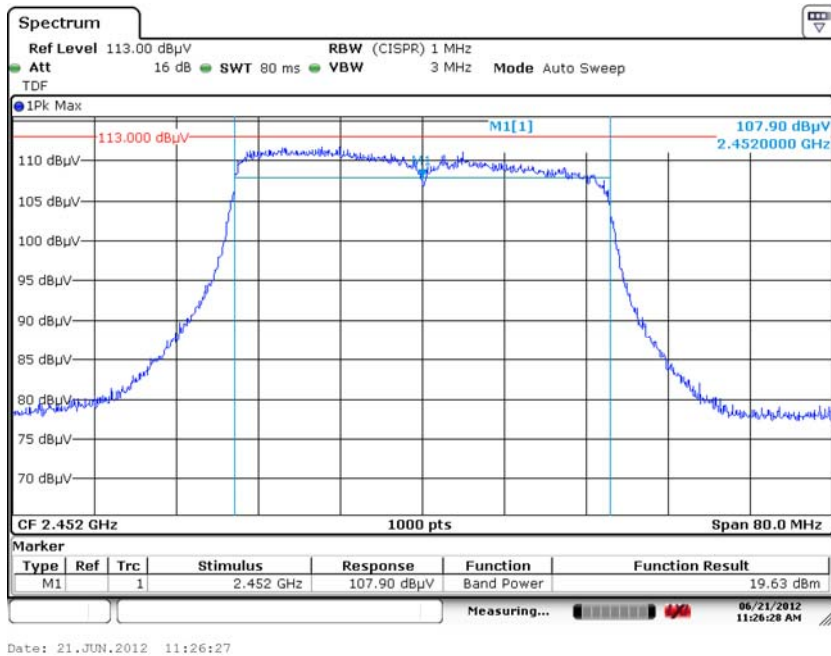

7. Measurement Data (continued)

7.4. Maximum Peak Conducted Output Power

7.4.14 Measurement Results for 5725 to 5850 MHz Band

802.11a Mode Channel	Frequency	Peak Integrated Field Strength	Distance	Antenna Gain ¹		Measured Peak Output Power	Output Power Limit	Result
	(MHz)	(dB μ V/m)	(d)	(dBi)	(numeric)	(mW)	(mW)	
Low	5745	132.51	3.0	12.50	17.783	300.69	1000.0	Compliant
Middle	5785	132.50	3.0	12.50	17.783	300.00	1000.0	Compliant
High	5825	132.13	3.0	12.50	17.783	275.50	1000.0	Compliant

802.11n HT20 Mode Channel	Frequency	Peak Integrated Field Strength	Distance	Antenna Gain ¹		Measured Peak Output Power	Output Power Limit	Result
	(MHz)	(dB μ V/m)	(d)	(dBi)	(numeric)	(mW)	(mW)	
Low	5745	131.12	3.0	12.50	17.783	218.33	1000.0	Compliant
Middle	5785	130.13	3.0	12.50	17.783	173.83	1000.0	Compliant
High	5825	129.58	3.0	12.50	17.783	153.15	1000.0	Compliant

802.11n HT40 Mode Channel	Frequency	Peak Integrated Field Strength	Distance	Antenna Gain ¹		Measured Peak Output Power	Output Power Limit	Result
	(MHz)	(dB μ V/m)	(d)	(dBi)	(numeric)	(mW)	(mW)	
Low	5755	129.78	3.0	12.50	17.783	160.37	1000.0	Compliant
High	5795	129.51	3.0	12.50	17.783	150.70	1000.0	Compliant

¹ The Integrated Peak field strength was derived from the spectrum analyzer band power measurement function result and converted to dB μ V/m by adding 107. Reference the following screen captures.

² Reference section 7.2 for the 6 dB emissions bandwidth.

7. Measurement Data (continued)

7.4. Maximum Peak Conducted Output Power (15.247 (b) (1)) (continued)

7.4.15. Low Channel – 149 – 802.11a

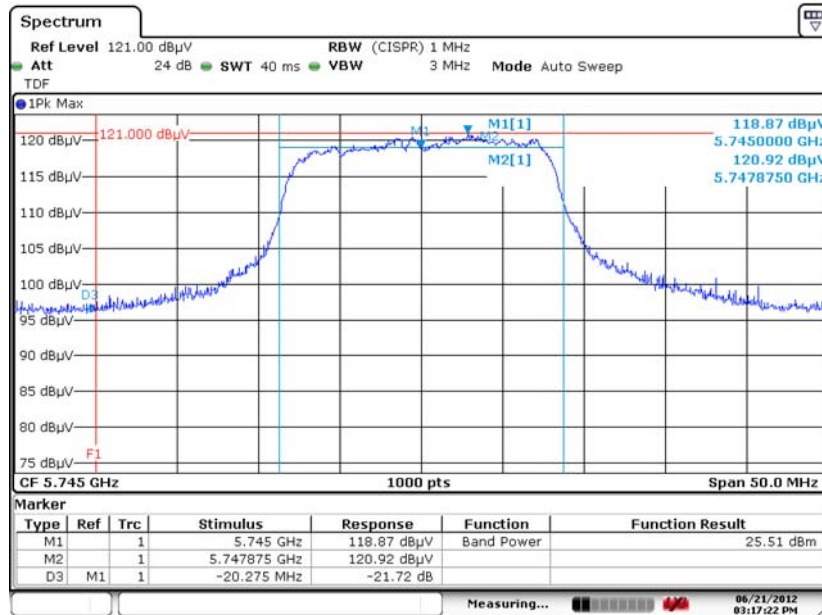

Date: 21.JUN.2012 15:17:21

7.4.16. Middle Channel – 153 – 802.11a

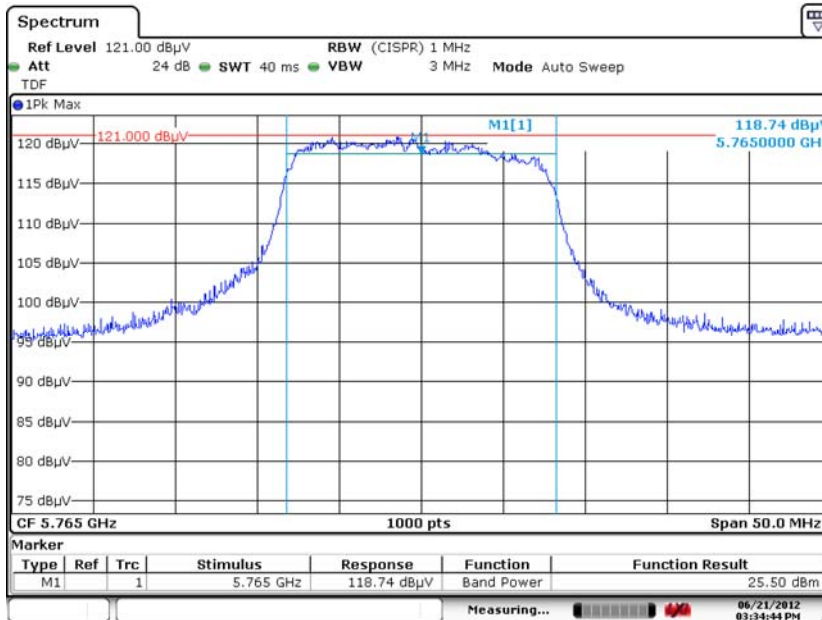

Date: 21.JUN.2012 15:34:44

7. Measurement Data (continued)

7.4. Maximum Peak Conducted Output Power (15.247 (b) (1))

7.4.17. High Channel – 165 – 802.11a

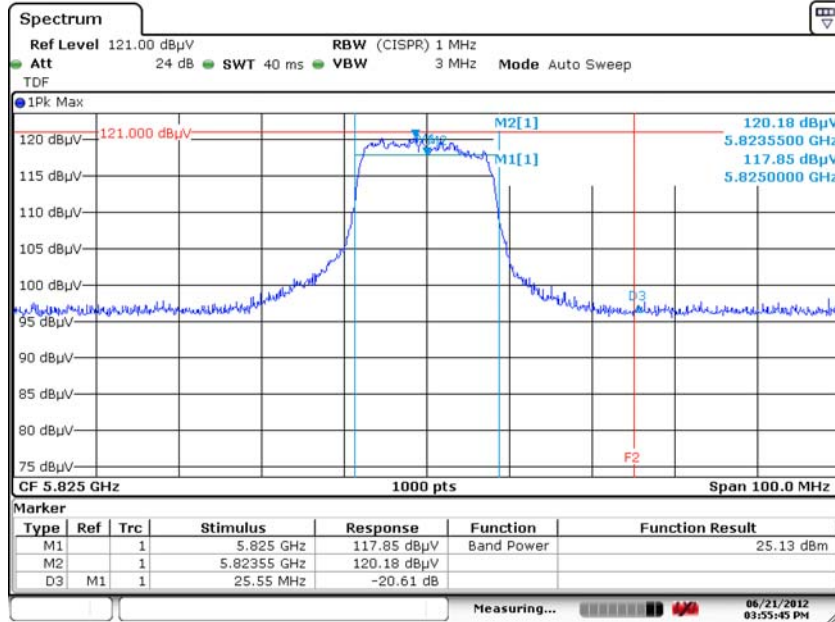

7.4.18. Low Channel – 149 – 802.11n HT20

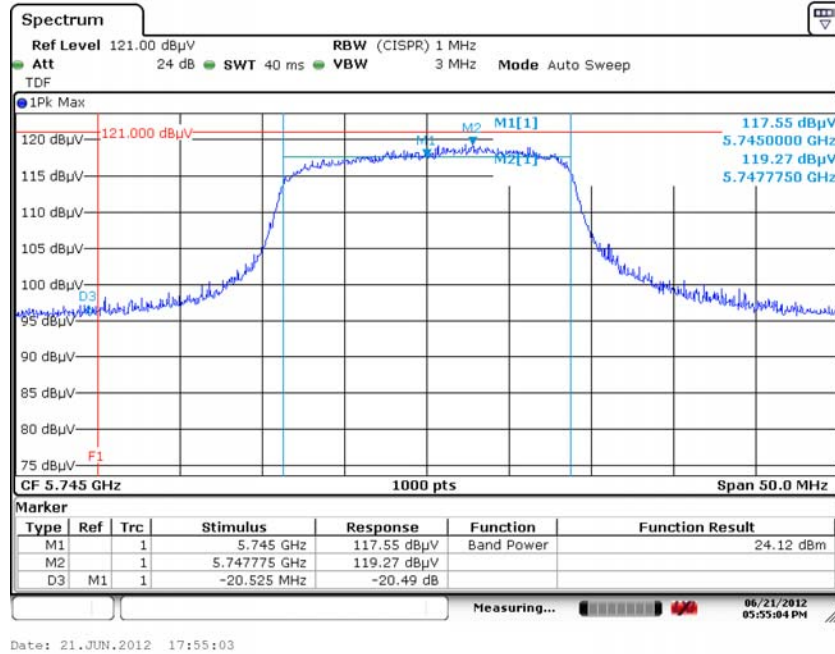

7. Measurement Data (continued)

7.4. Maximum Peak Conducted Output Power (15.247 (b) (1))

7.4.19. Mid Channel – 157 – 802.11n HT20

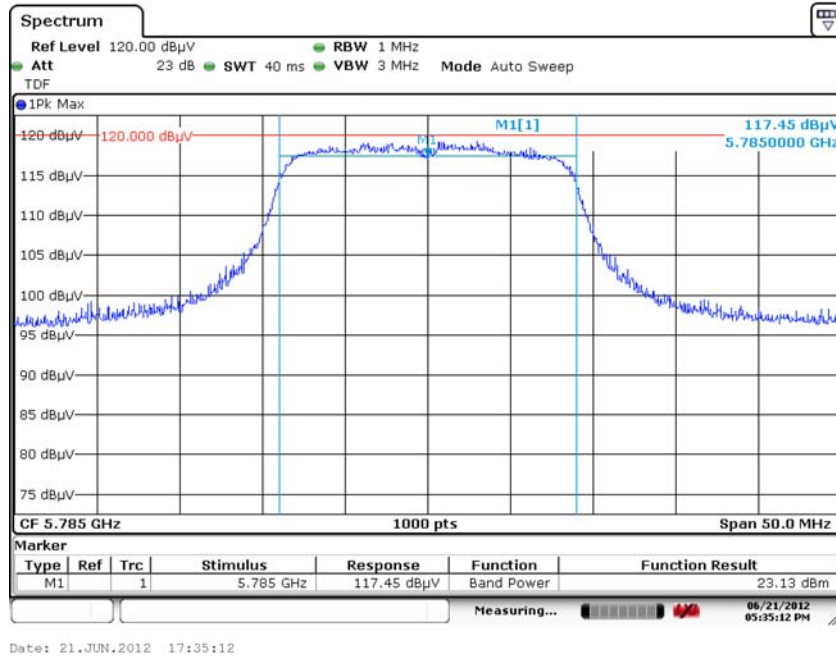

7.4.20. High Channel – 165 – 802.11n HT20

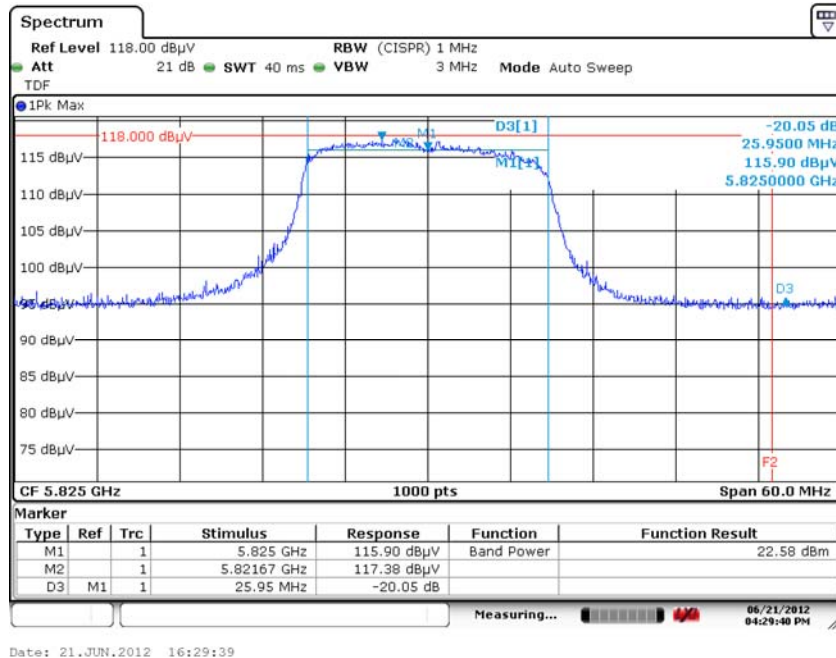

7. Measurement Data (continued)

7.4. Maximum Peak Conducted Output Power (15.247 (b) (1)) (continued)

7.4.21. Low Channel – 151 – 802.11n HT40

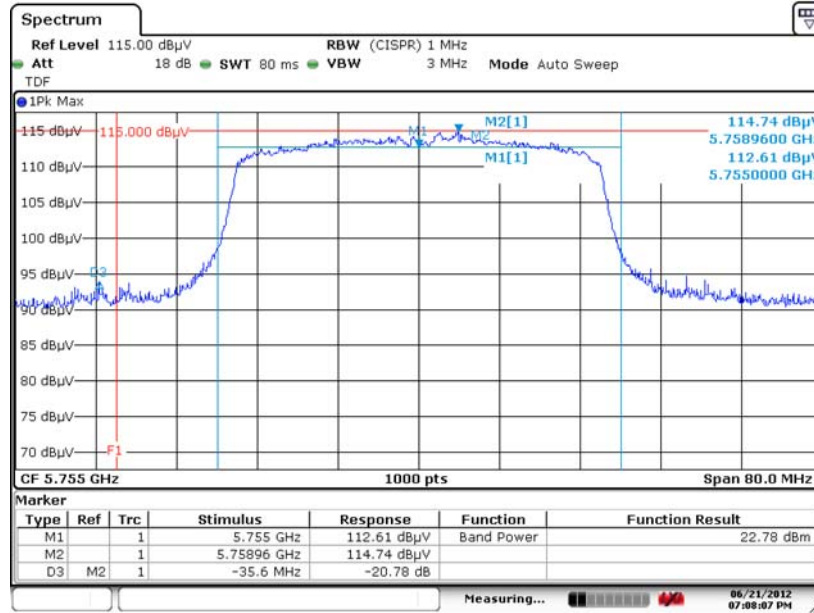

7.4.22. High Channel – 159 – 802.11n HT40

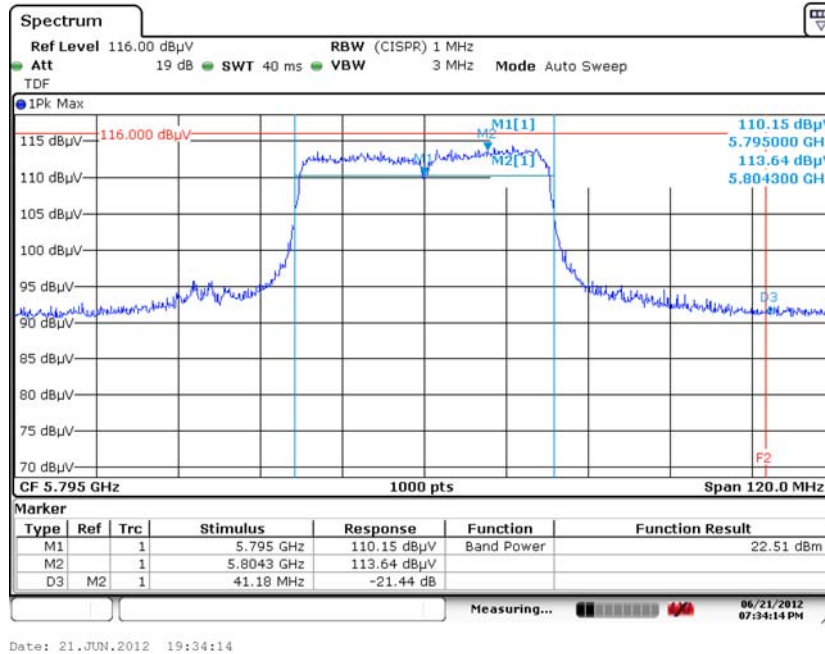

7. Measurement Data (continued)**7.5. Operation with directional antenna gains greater than 6 dBi (15.247 (b)(4))**

Requirement: If transmitting antennas of directional gain greater than 6 dBi are used, the conducted output power from the intentional radiator shall be reduced below the stated values in paragraphs (b)(1), (b)(2), and (b)(3) of FCC Part 15.247, as appropriate, by the amount in dB that the directional gain of the antenna exceeds 6 dBi.

Systems operating in the 2400 – 2483.5 MHz band that are used exclusively for fixed, point-to-point operations may employ transmitting antennas with directional gain greater than 6 dBi provided the maximum peak output power of the intentional radiator is reduced by 1 dB for every 3 dB that the directional gain of the antenna exceeds 6 dBi.

Systems operating in the 5725 – 5850 MHz band that are used exclusively for fixed, point-to-point operations may employ transmitting antennas with directional gain greater than 6 dBi without any corresponding reduction in transmitter peak output power.

Procedure: FCC KDB 557074 Section 4.0 provides the formulas for calculating the reduction of power.

$$P_{out} = 30 - \text{Floor} | (G_{tx} - 6 / 3) |$$

DUT Status: The EUT is using an external panel antenna with 12.5 dBi of gain and 25 degree beam width. Therefore the conducted power out of the EUT is limited to 28 dBm or 630.96 mW when used in combination with this antenna for point to point operation in the 2400 to 2483.5 MHz band.

Conclusion: The EUTs conducted output power is compliant with this section as shown in Section 7.4 of this test report.

7. Measurement Data (continued)

7.6. Transmitter Spurious Radiated Emissions (150 kHz to 40 GHz)

Requirement: (15.209) The Emissions from an intentional radiator shall not exceed the field strength levels specified in the following table:

Frequency Range (MHz)	Distance (Meters)	Limit (dBµV/m) ¹
0.009 to 0.490	3	128.5 to 93.8
0.490 to 1.705	3	73.8 to 63.0
1.705 to 30	3	69.5
30 to 88	3	40.0
88 to 216	3	43.5
216 to 960	3	46.0
>960	3	54.0

¹Measurements in the 9 to 90 kHz, 110 to 490 kHz and above 1000 MHz ranges employ an average detector. Otherwise a quasi-peak detector is used.

Procedure: This test was performed in accordance with the procedure detailed in FCC OET publication number 558074, Section 5.4: Maximum Unwanted Emissions Levels and FCC 47CFRPart 15.209: Radiated Emission Limits; General Requirements.

Test measurements were made in accordance with ANSI C63.4-2009, Standard Methods of Measurement of Radio Noise Emissions from Low-Voltage Electrical and Electronics Equipment in the Range of 9 kHz to 40 GHz.

Conclusion: The Emissions from the DUT did not exceed the field strength levels specified in the above table.

7. Measurement Data (continued)

7.6. Transmitter Spurious Radiated Emissions (150 kHz to 40 GHz)

7.6.1. Spurious Radiated Emissions (150 kHz – 30 MHz) Test Results

7.6.1.1. Measurement Results – Parallel Antenna

16:22:17 JUN 20, 2012
 Chamber, FCC 15.209 Radiated Emissions Prescan
 ACTV DET: PEAK
 MEAS DET: PEAK
 MKR 1.82 MHz
 52.91 dB μ V

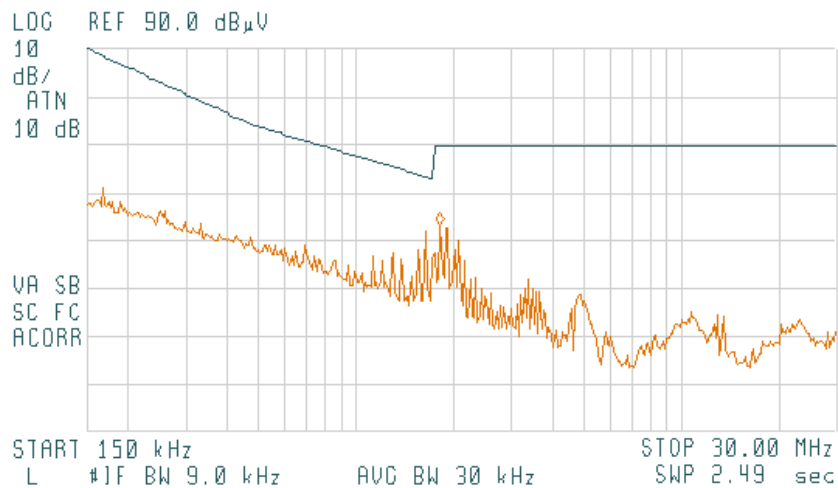

7. Measurement Data (continued)

7.6. Transmitter Spurious Radiated Emissions (150 kHz to 40 GHz)

7.6.1. Spurious Radiated Emissions (150 kHz – 30 MHz) Test Results

7.6.1.2. Measurement Results – Perpendicular Antenna

16:17:09 JUN 20, 2012
 Chamber, FCC 15.209 Radiated Emissions Prescan
 ACTV DET: PEAK
 MEAS DET: PEAK
 MKR 3.47 MHz
 51.93 dB μ V

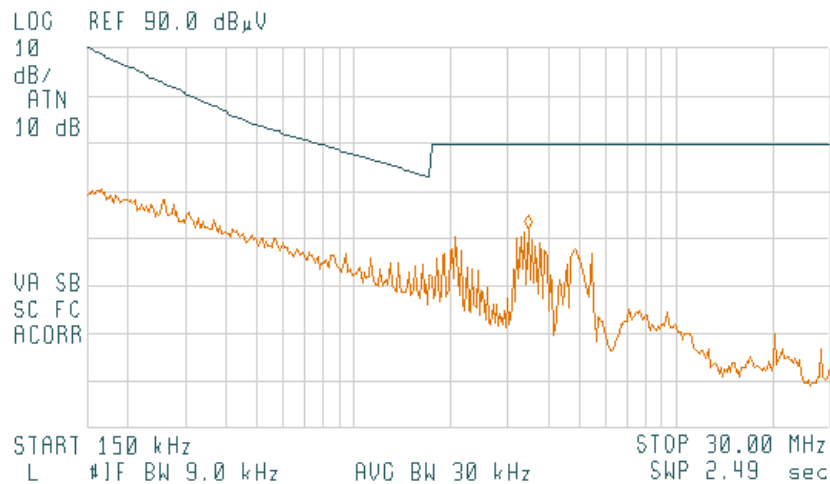

7. Measurement Data (continued)

7.6. Transmitter Spurious Radiated Emissions (150 kHz to 40 GHz)

7.6.2. Spurious Radiated Emissions (30 MHz – 1 GHz) Test Results

7.6.2.1 Horizontal Polarity

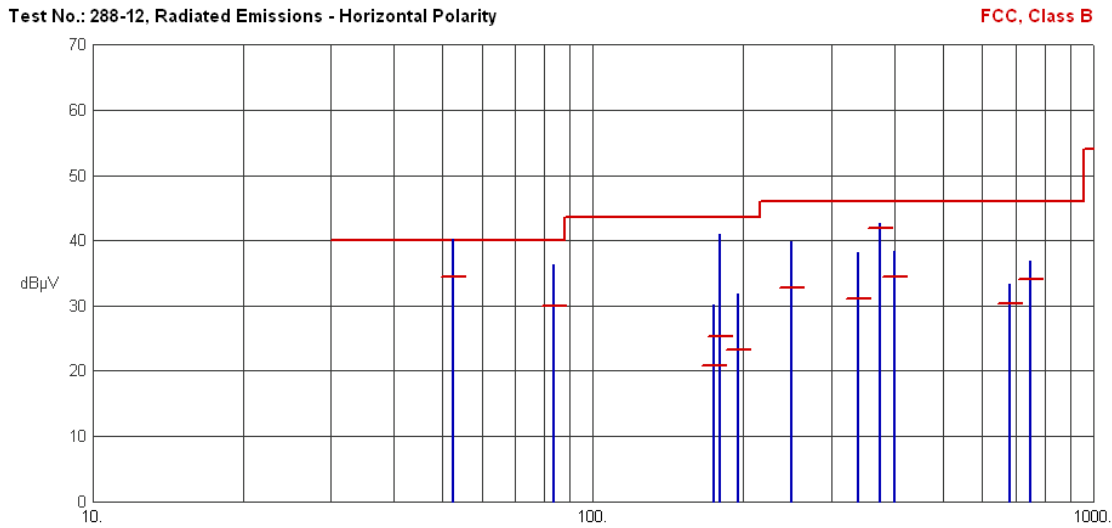

Frequency (MHz)	Pk Amp (dBµV/m)	QP Amp (dBµV/m)	QP Limit (dBµV/m)	Margin (dB)	Ant Ht (cm)	Table (Deg)	Comments
52.4760	40.23	34.37	40.00	-5.63	N/A	N/A	
83.7004	36.25	29.87	40.00	-10.13	N/A	N/A	
174.1807	30.17	20.86	43.50	-22.64	N/A	N/A	
179.3274	40.91	25.37	43.50	-18.13	N/A	N/A	
195.3928	31.89	23.24	43.50	-20.26	N/A	N/A	
249.9789	39.80	32.82	46.00	-13.18	N/A	N/A	
340.0195	38.09	31.10	46.00	-14.90	N/A	N/A	
374.9729	42.67	41.84	46.00	-4.16	N/A	N/A	
400.0111	38.30	34.42	46.00	-11.58	N/A	N/A	
679.9765	33.30	30.24	46.00	-15.76	N/A	N/A	
749.9830	36.82	34.03	46.00	-11.97	N/A	N/A	

7. Measurement Data (continued)

7.6. Transmitter Spurious Radiated Emissions (150 kHz to 40 GHz)

7.6.2. Spurious Radiated Emissions (30 MHz – 1 GHz) Test Results

7.6.2.1 Vertical Polarity

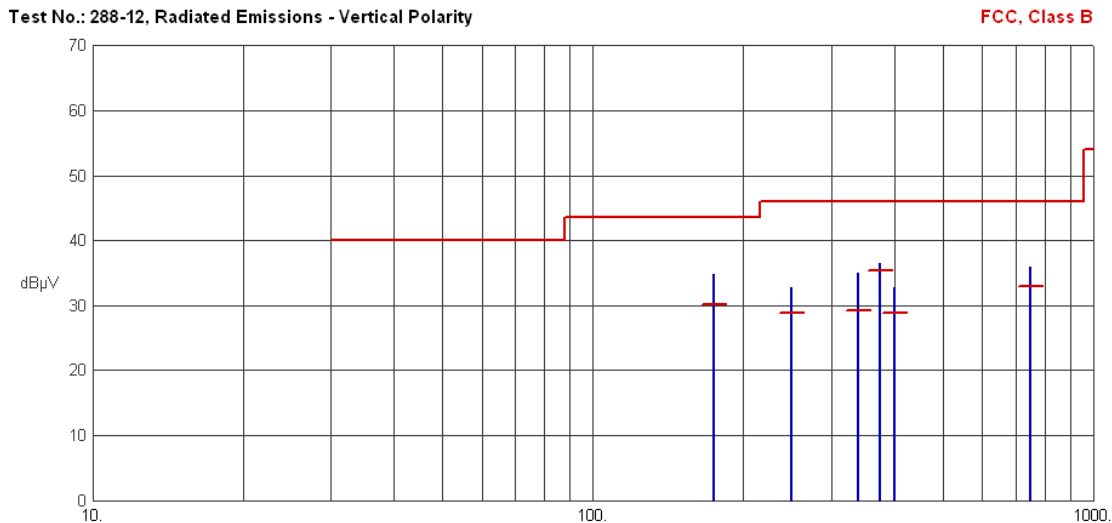

Frequency (MHz)	Pk Amp (dBµV/m)	QP Amp (dBµV/m)	QP Limit (dBµV/m)	Margin (dB)	Ant Ht (cm)	Table (Deg)	Comments
174.0900	34.72	30.12	43.50	-13.38	N/A	N/A	
249.9852	32.75	28.77	46.00	-17.23	N/A	N/A	
340.0037	34.95	29.26	46.00	-16.74	N/A	N/A	
374.9848	36.52	35.32	46.00	-10.68	N/A	N/A	
400.0044	32.68	28.87	46.00	-17.13	N/A	N/A	
749.9860	35.98	32.96	46.00	-13.04	N/A	N/A	

7.6.3. Spurious Radiated Emissions (Above 1 GHz) Test Results

There were measurable no transmitter spurious emissions other than the harmonic emissions tabled in sections 7.6.4.

7. Measurement Data (continued)

7.6. Transmitter Spurious Radiated Emissions (150 kHz to 40 GHz)

7.6.4. Transmitter Spurious Radiated Emissions (Harmonic Meas.) Test Results

Note: Measurement of Harmonics that fall into the restricted bands.

802.11b Freq. (MHz)	Field Strength (dBµV/m)		Limit (dBµV/m)		Margin (dBµV/m)		Antenna Polarity (H/V)	Result
	Peak	Average	Peak	Average	Peak	Average		
4824.000	59.30	46.53	74.00	54.00	-14.70	-7.47	H	Compliant
4874.000	60.87	53.10	74.00	54.00	-13.13	-0.90	H	Compliant
4924.000	60.25	47.35	74.00	54.00	-13.75	-6.65	H	Compliant
7236.000	54.15	40.23	74.00	54.00	-19.85	-13.77	V	Compliant
7311.000	58.37	48.48	74.00	54.00	-15.63	-5.52	H	Compliant
7386.000	54.10	40.51	74.00	54.00	-19.90	-13.49	H	Compliant
12060.000	60.06	46.73	74.00	54.00	-13.94	-7.27	V	Compliant
12185.000	59.80	46.54	74.00	54.00	-14.20	-7.46	V	Compliant
12310.000	59.34	46.65	74.00	54.00	-14.66	-7.35	H	Compliant
14472.000	56.73	43.69	74.00	54.00	-17.27	-10.31	V	Compliant
19296.000	53.45	42.68	74.00	54.00	-20.55	-11.32	H	Compliant
19496.000	54.22	43.28	74.00	54.00	-19.78	-10.72	V	Compliant
19696.000	52.73	42.39	74.00	54.00	-21.27	-11.61	V	Compliant
22158.000	52.81	41.58	74.00	54.00	-21.19	-12.42	V	Compliant

802.11g Freq. (MHz)	Field Strength (dBµV/m)		Limit (dBµV/m)		Margin (dBµV/m)		Antenna Polarity (H/V)	Result
	Peak	Average	Peak	Average	Peak	Average		
4824.000	58.25	45.05	74.00	54.00	-15.75	-8.95	H	Compliant
4874.000	59.23	45.53	74.00	54.00	-14.77	-8.47	H	Compliant
4924.000	60.27	46.62	74.00	54.00	-13.73	-7.38	H	Compliant
7236.000	52.89	40.12	74.00	54.00	-21.11	-13.88	V	Compliant
7311.000	53.25	40.80	74.00	54.00	-20.75	-13.20	V	Compliant
7386.000	55.59	40.60	74.00	54.00	-18.41	-13.40	V	Compliant
12060.000	59.47	46.70	74.00	54.00	-14.53	-7.30	V	Compliant
12185.000	59.44	46.79	74.00	54.00	-14.56	-7.21	V	Compliant
12310.000	60.58	46.62	74.00	54.00	-13.42	-7.38	H	Compliant
14472.000	56.22	43.89	74.00	54.00	-17.78	-10.11	V	Compliant
19296.000	53.45	42.68	74.00	54.00	-20.55	-11.32	H	Compliant
19496.000	54.22	43.28	74.00	54.00	-19.78	-10.72	V	Compliant
19696.000	52.73	42.39	74.00	54.00	-21.27	-11.61	V	Compliant
22158.000	52.81	41.58	74.00	54.00	-21.19	-12.42	V	Compliant

¹ All correction factors are stored in the spectrum analyzer and applied to this column entry. Measurements at 14.472 GHz were made at 1 meter. All other measurements were made at 3 meters.

7. Measurement Data (continued)

7.6. Transmitter Spurious Radiated Emissions (150 kHz to 40 GHz)

7.6.4. Transmitter Spurious Radiated Emissions (Harmonic Meas.) Test Results

Note: Measurement of Harmonics that fall into the restricted bands.

HT20 Freq. (MHz)	Field Strength (dBµV/m)		Limit (dBµV/m)		Margin (dBµV/m)		Antenna Polarity (H/V)	Result
	Peak	Average	Peak	Average	Peak	Average		
4824.000	57.09	44.95	74.00	54.00	-16.91	-9.05	V	Compliant
4874.000	57.48	45.15	74.00	54.00	-16.52	-8.85	V	Compliant
4924.000	58.30	45.74	74.00	54.00	-15.70	-8.26	V	Compliant
7236.000	52.83	40.19	74.00	54.00	-21.17	-13.81	V	Compliant
7311.000	59.20	43.47	74.00	54.00	-14.80	-10.53	H	Compliant
7386.000	53.02	40.41	74.00	54.00	-20.98	-13.59	V	Compliant
12060.000	59.60	46.74	74.00	54.00	-14.40	-7.26	H	Compliant
12185.000	58.67	46.67	74.00	54.00	-15.33	-7.33	V	Compliant
12310.000	58.49	46.52	74.00	54.00	-15.51	-7.48	V	Compliant
14472.000	56.00	43.87	74.00	54.00	-18.00	-10.13	V	Compliant
19296.000	53.45	42.68	74.00	54.00	-20.55	-11.32	H	Compliant
19496.000	54.22	43.28	74.00	54.00	-19.78	-10.72	V	Compliant
19696.000	52.73	42.39	74.00	54.00	-21.27	-11.61	V	Compliant
22158.000	52.81	41.58	74.00	54.00	-21.19	-12.42	V	Compliant

HT40 Freq. (MHz)	Field Strength (dBµV/m)		Limit (dBµV/m)		Margin (dBµV/m)		Antenna Polarity (H/V)	Result
	Peak	Average	Peak	Average	Peak	Average		
4844.000	57.46	45.00	74.00	54.00	-16.54	-9.00	V	Compliant
4874.000	57.60	45.15	74.00	54.00	-16.40	-8.85	V	Compliant
4904.000	57.28	45.54	74.00	54.00	-16.72	-8.46	V	Compliant
7266.000	52.24	40.14	74.00	54.00	-21.76	-13.86	H	Compliant
7311.000	52.54	40.64	74.00	54.00	-21.46	-13.36	H	Compliant
7356.000	52.68	40.61	74.00	54.00	-21.32	-13.39	V	Compliant
12110.000	58.75	46.90	74.00	54.00	-15.25	-7.10	V	Compliant
12185.000	58.74	46.67	74.00	54.00	-15.26	-7.33	V	Compliant
12260.000	59.28	46.61	74.00	54.00	-14.72	-7.39	V	Compliant
19376.000	53.45	42.68	74.00	54.00	-20.55	-11.32	H	Compliant
19496.000	54.22	43.28	74.00	54.00	-19.78	-10.72	V	Compliant
19616.000	52.73	42.39	74.00	54.00	-21.27	-11.61	V	Compliant
22068.000	52.81	41.58	74.00	54.00	-21.19	-12.42	V	Compliant

¹ All correction factors are stored in the spectrum analyzer and applied to this column entry. Measurements at 14.472 GHz were made at 1 meter. All other measurements were made at 3 meters.

7. Measurement Data (continued)

7.6. Transmitter Spurious Radiated Emissions (150 kHz to 40 GHz)

7.6.4. Transmitter Spurious Radiated Emissions (Harmonic Meas.) Test Results

Note: Measurement of Harmonics that fall into the restricted bands.

802.11a Freq. (MHz)	Field Strength (dBµV/m)		Limit (dBµV/m)		Margin (dBµV/m)		Antenna Polarity (H/V)	Result
	Peak	Average	Peak	Average	Peak	Average		
11490.00	60.77	46.56	74.00	54.00	-13.23	-7.44	H	Compliant
11570.00	58.10	45.98	74.00	54.00	-15.90	-8.02	V	Compliant
11650.00	58.53	46.17	74.00	54.00	-15.47	-7.83	V	Compliant
22980.00	61.81	48.22	74.00	54.00	-12.19	-5.78	V	Compliant

HT20 Freq. (MHz)	Field Strength (dBµV/m)		Limit (dBµV/m)		Margin (dBµV/m)		Antenna Polarity (H/V)	Result
	Peak	Average	Peak	Average	Peak	Average		
11490.000	57.82	46.29	74.00	54.00	-16.18	-7.71	H	Compliant
11570.000	58.20	45.92	74.00	54.00	-15.80	-8.08	V	Compliant
11650.000	58.61	46.13	74.00	54.00	-15.39	-7.87	H	Compliant
22980.000	60.25	48.23	74.00	54.00	-13.75	-5.77	H	Compliant

HT40 Freq. (MHz)	Field Strength (dBµV/m)		Limit (dBµV/m)		Margin (dBµV/m)		Antenna Polarity (H/V)	Result
	Peak	Average	Peak	Average	Peak	Average		
11510.000	58.05	45.82	74.00	54.00	-15.95	-8.18	H	Compliant
11590.000	59.18	46.00	74.00	54.00	-14.82	-8.00	H	Compliant
23020.000	59.18	45.85	74.00	54.00	-14.82	-8.15	V	Compliant

¹ All correction factors are stored in the spectrum analyzer and applied to this column entry. All measurements were made at 3 meters.

7. Measurement Data (continued)

7.7. Band Edge Measurements

Requirement: In any 100 kHz bandwidth outside the frequency band in which the spread spectrum or digitally modulated intentional radiator is operating, the radio frequency power that is produced by the intentional radiator shall be at least 20 dB below that in the 100 kHz bandwidth within the band that contains the highest level of the desired power, based on either an RF conducted or a radiated measurement, provided the transmitter demonstrates compliance with the peak conducted power limits. If the transmitter complies with the conducted power limits based on the use of RMS averaging over a time interval, as permitted under paragraph (b)(3) of this section, the attenuation required under this paragraph shall be 30 dB instead of 20 dB. Attenuation below the general limits specified in Section 15.209(a) is not required. In addition, radiated emissions which fall in the restricted bands, as defined in Section 15.205(a), must also comply with the radiated emission limits specified in Section 15.209(a) (see Section 15.205(c)).

Procedure: For the lower band edge, this test was performed in accordance with the procedure detailed in FCC OET publication number 558074, Section 5.4: Maximum Unwanted Emissions Levels. and FCC 47CFR Part 15.209: Radiated Emission Limits; General Requirements.

For the upper band edge, this test was performed in accordance with the procedure detailed in FCC OET publication number 558074, Section 5.4.2.2.2: Unwanted Emissions in Restricted Bands for Frequencies > 1000 MHz. and FCC 47CFR Part 15.209: Radiated Emission Limits; General Requirements.

Test measurements were made in accordance with ANSI C63.4-2009, Standard Methods of Measurement of Radio Noise Emissions from Low-Voltage Electrical and Electronics Equipment in the Range of 9 kHz to 40 GHz.

Conclusion: The Emissions from the DUT did not exceed the field strength levels specified in the above table.

7. Measurement Data (continued)

7.7. Band Edge Measurements (continued)

7.7.1. Measurement Results – Restricted Band 2310 to 2390 MHz

Mode of Operation CH1	Freq. (MHz)	Field Strength (dB μ V/m)		Limit (dB μ V/m)		Margin (dB μ V/m)		Result
		Peak	Average	Peak	Average	Peak	Average	
802.11b	2386.545	64.60	51.68	74	54	-9.40	-2.32	Compliant

7.7.2. Measurement Plot – Restricted Band 2310 to 2390 MHz

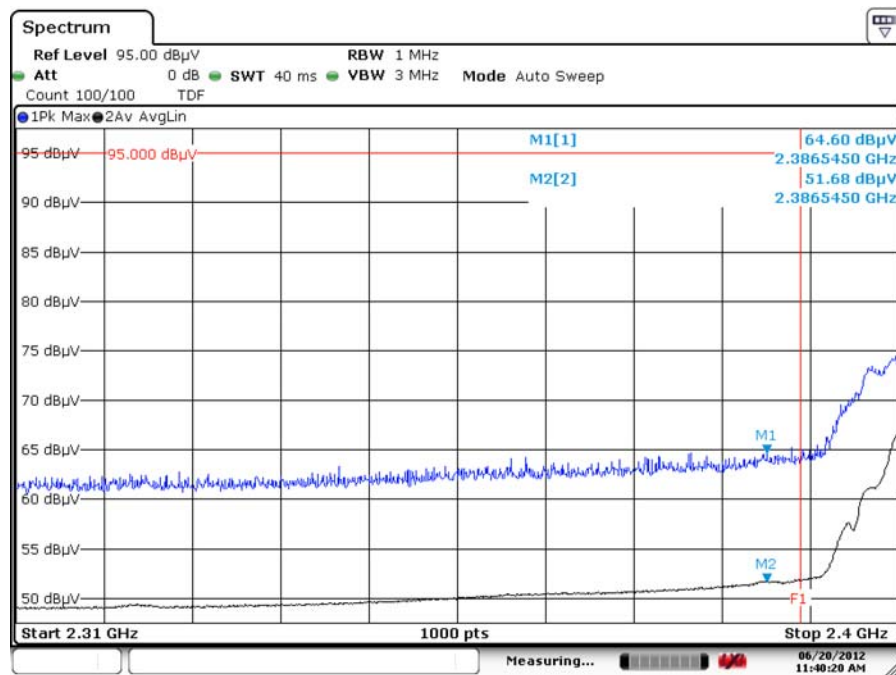

7. Measurement Data (continued)

7.7. Band Edge Measurements (continued)

7.7.3. Measurement Results – Upper Band Edge / Restricted Band

Mode of Operation CH11	Freq. (MHz)	Field Strength (dBµV/m)		Limit (dBµV/m)		Margin (dBµV/m)		Result
		Peak	Average	Peak	Average	Peak	Average	
802.11b	2484.565	63.91	53.75	74	54	-10.09	-0.25	Compliant

7.7.4. Measurement Plot – Upper Band Edge / Restricted Band

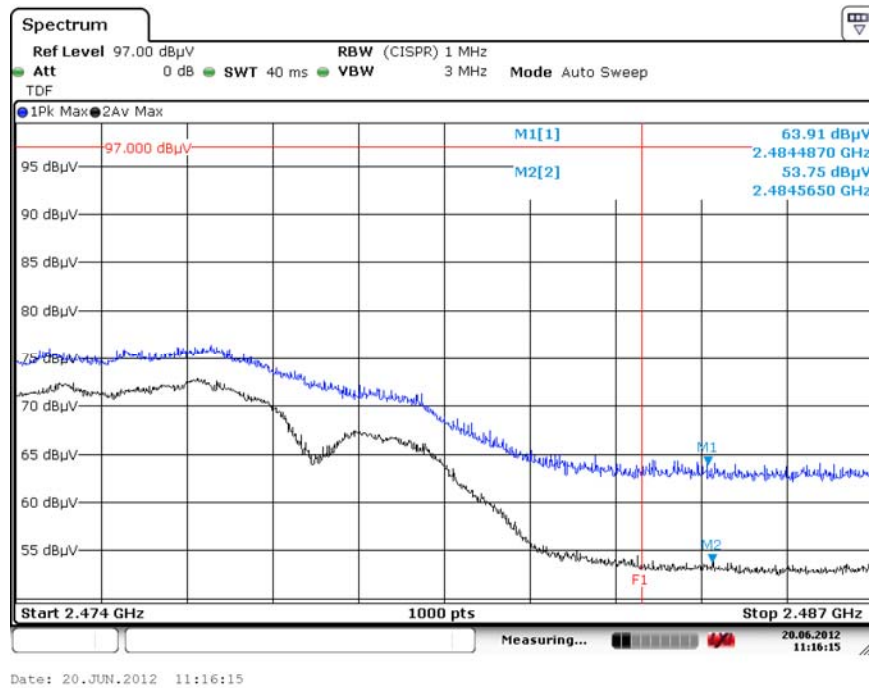

7. Measurement Data (continued)

7.7. Band Edge Measurements (continued)

7.7.5. Measurement Results – Restricted Band 2310 to 2390 MHz

Mode of Operation CH1	Freq. (MHz)	Field Strength (dBµV/m)		Limit (dBµV/m)		Margin (dBµV/m)		Result
		Peak	Average	Peak	Average	Peak	Average	
802.11g	2388.975	68.88	53.42	74	54	-5.12	-0.58	Compliant

7.7.6. Measurement Plot – Restricted Band 2310 to 2390 MHz

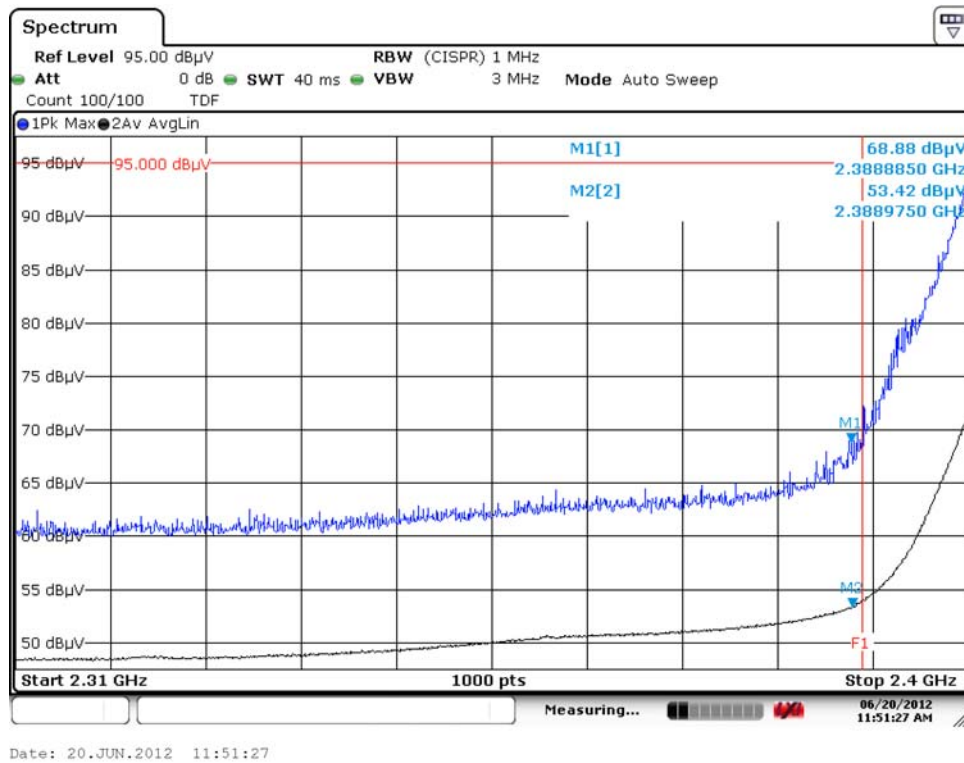

7. Measurement Data (continued)

7.7. Band Edge Measurements (continued)

7.7.7. Measurement Results – Upper Band Edge / Restricted Band

Mode of Operation CH11	Freq. (MHz)	Field Strength (dBµV/m)		Limit (dBµV/m)		Margin (dBµV/m)		Result
		Peak	Average	Peak	Average	Peak	Average	
802.11g	2483.648	70.87	53.73	74	54	-3.13	-0.27	Compliant

7.7.8. Measurement Plot – Upper Band Edge / Restricted Band

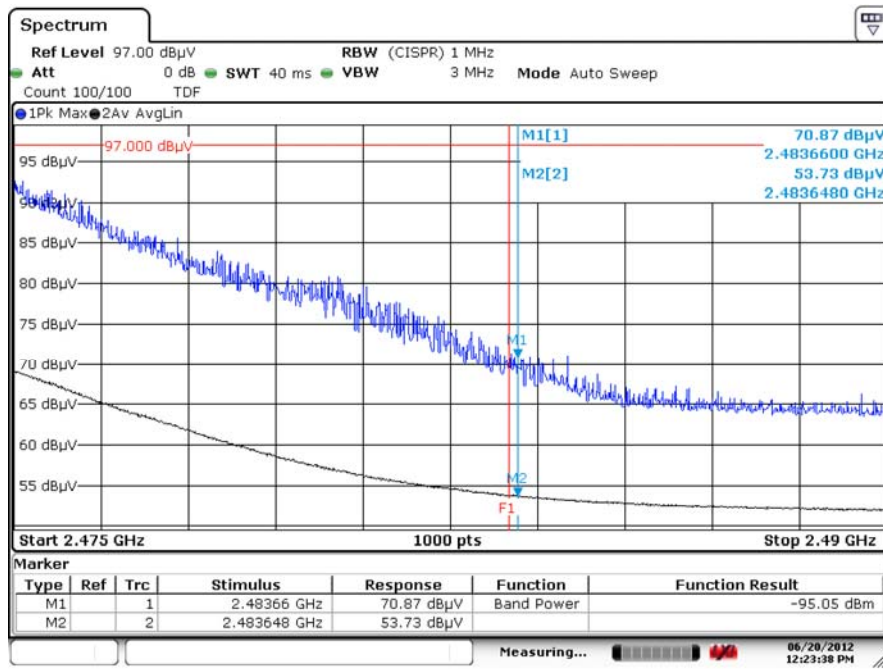

Date: 20.JUN.2012 12:23:37

7. Measurement Data (continued)

7.7. Band Edge Measurements (continued)

7.7.9. Measurement Results – Upper & Lower Band Edges / Restricted Band

Mode of Operation CH6	Freq. (MHz)	Field Strength (dBµV/m)		Limit (dBµV/m)		Margin (dBµV/m)		Result
		Peak	Average	Peak	Average	Peak	Average	
802.11g	2386.950	66.85	53.57	74	54	-7.15	-0.43	Compliant

Mode of Operation CH6	Freq. (MHz)	Field Strength (dBµV/m)		Limit (dBµV/m)		Margin (dBµV/m)		Result
		Peak	Average	Peak	Average	Peak	Average	
802.11g	2484.250	64.77	51.81	74	54	-9.23	-2.19	Compliant

7.7.10. Measurement Plot – Upper & Lower Band Edges / Restricted Band

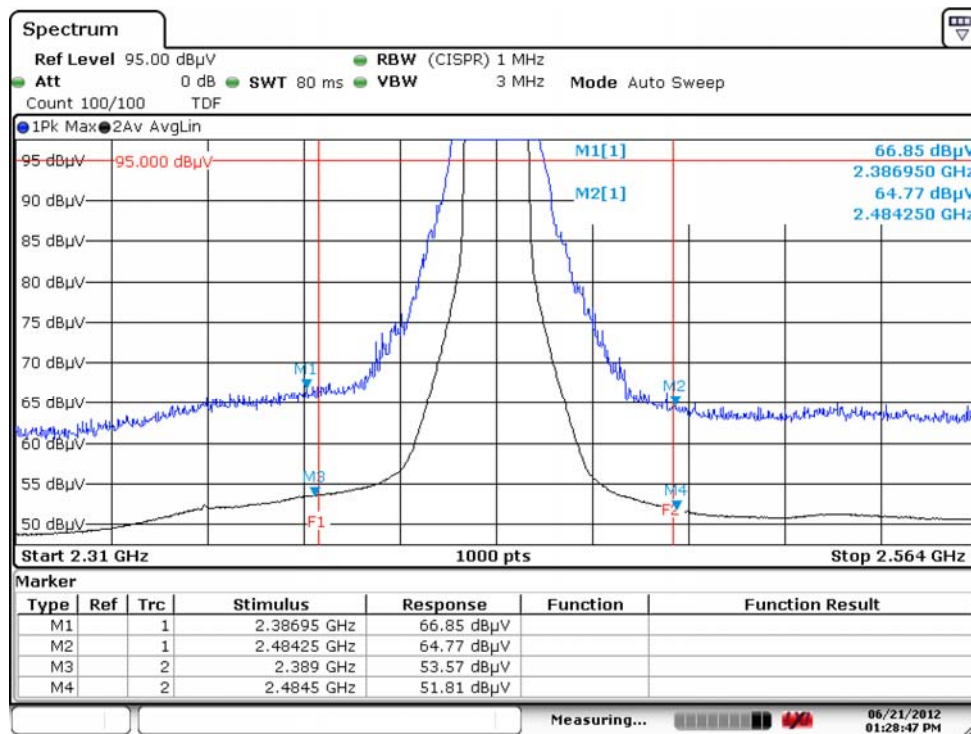

Date: 21.JUN.2012 13:28:46

7. Measurement Data (continued)

7.7. Band Edge Measurements (continued)

7.7.11. Measurement Results – Restricted Band 2310 to 2390 MHz

Mode of Operation CH1	Freq. (MHz)	Field Strength (dB μ V/m)		Limit (dB μ V/m)		Margin (dB μ V/m)		Result
		Peak	Average	Peak	Average	Peak	Average	
HT20	2386.635	70.97	53.73	74	54	-3.03	-0.27	Compliant

7.7.12. Measurement Plot – Restricted Band 2310 to 2390 MHz

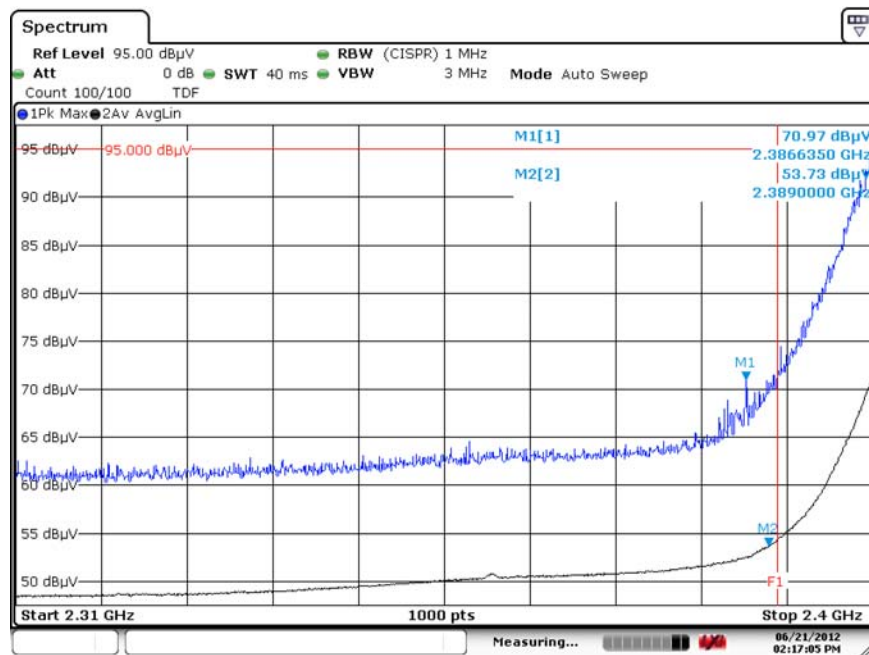

Date: 21.JUN.2012 14:17:04

7. Measurement Data (continued)

7.7. Band Edge Measurements (continued)

7.7.13. Measurement Results – Upper Band Edge / Restricted Band

Mode of Operation CH11	Freq. (MHz)	Field Strength (dBµV/m)		Limit (dBµV/m)		Margin (dBµV/m)		Result
		Peak	Average	Peak	Average	Peak	Average	
HT20	2484.186	72.17	52.77	74	54	-1.83	-1.23	Compliant

7.7.14. Measurement Plot – Upper Band Edge / Restricted Band

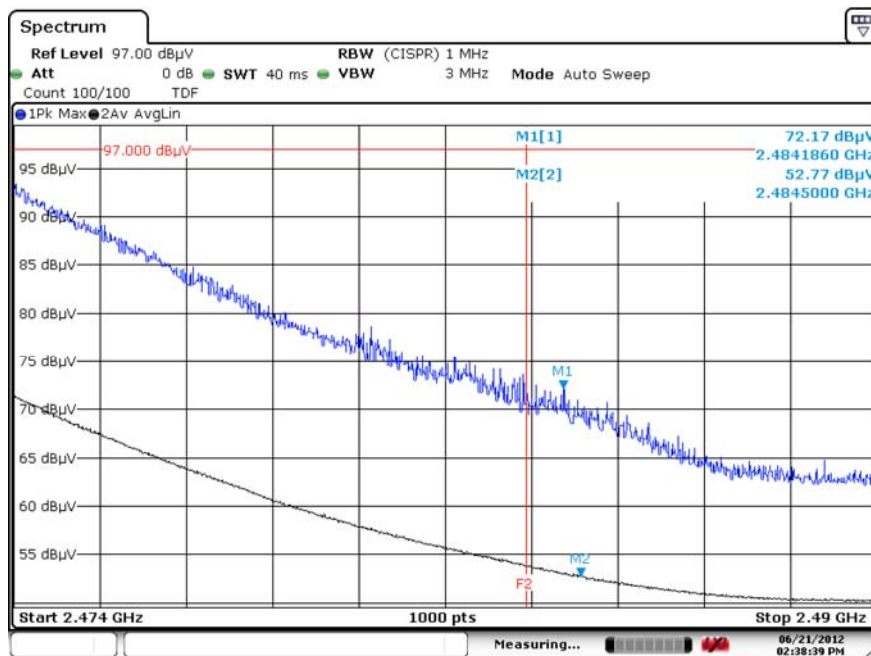

Date: 21.JUN.2012 14:38:39

7. Measurement Data (continued)

7.7. Band Edge Measurements (continued)

7.7.15. Measurement Results – Upper & Lower Band Edges / Restricted Band

Mode of Operation CH6	Freq. (MHz)	Field Strength (dBµV/m)		Limit (dBµV/m)		Margin (dBµV/m)		Result
		Peak	Average	Peak	Average	Peak	Average	
HT20	2384.920	67.48	53.53	74	54	-6.52	-0.47	Compliant

Mode of Operation CH6	Freq. (MHz)	Field Strength (dBµV/m)		Limit (dBµV/m)		Margin (dBµV/m)		Result
		Peak	Average	Peak	Average	Peak	Average	
HT20	2484.250	65.31	51.91	74	54	-8.69	-2.09	Compliant

7.7.16. Measurement Plot – Upper & Lower Band Edges / Restricted Band

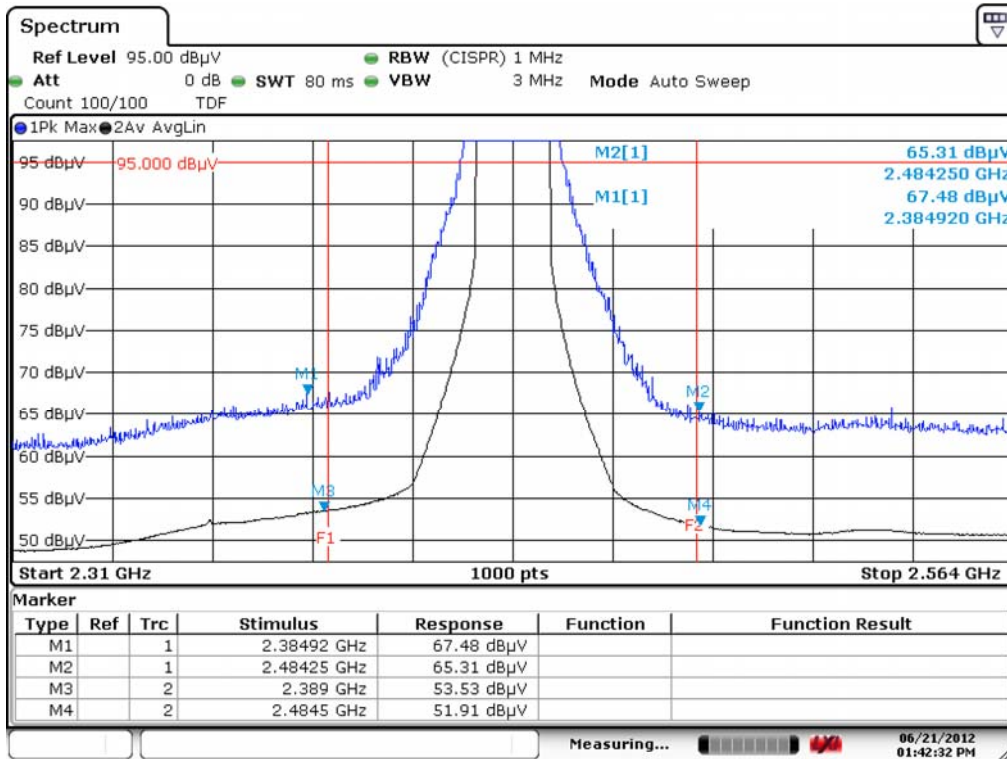

Date: 21.JUN.2012 13:42:31

7. Measurement Data (continued)

7.7. Band Edge Measurements (continued)

7.7.17. Measurement Results – Restricted Band 2310 to 2390 MHz

Mode of Operation CH3	Freq. (MHz)	Field Strength (dBµV/m)		Limit (dBµV/m)		Margin (dBµV/m)		Result
		Peak	Average	Peak	Average	Peak	Average	
HT40	2387.985	69.64	53.56	74	54	-4.36	-0.44	Compliant

7.7.18. Measurement Plot – Restricted Band 2310 to 2390 MHz

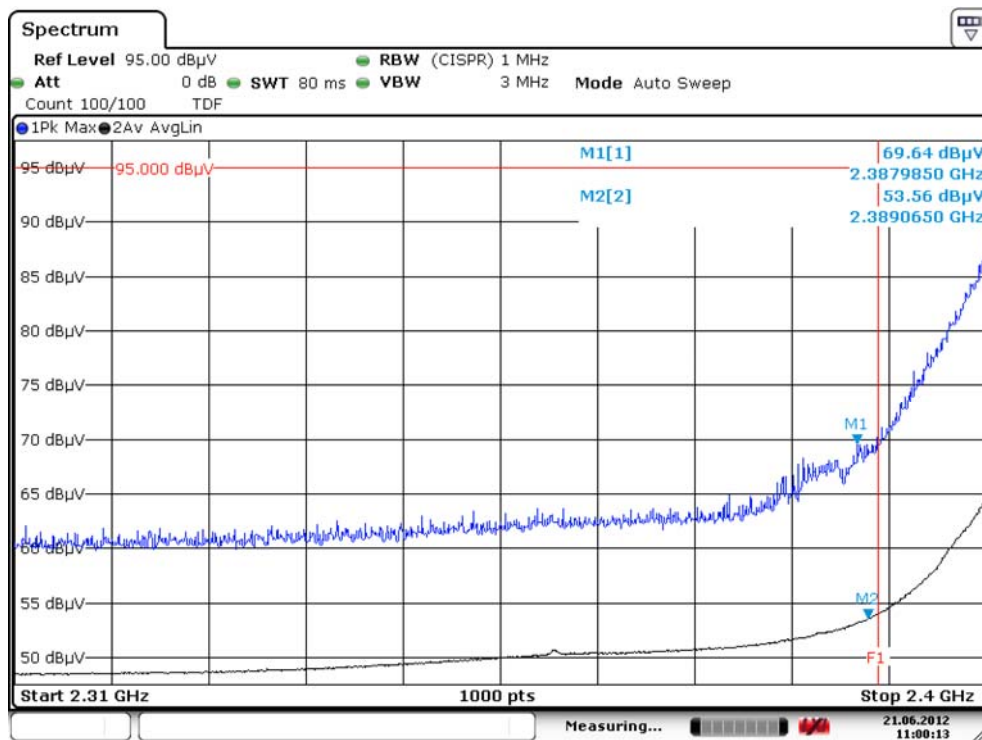

Date: 21.JUN.2012 11:00:13

7. Measurement Data (continued)

7.7. Band Edge Measurements (continued)

7.7.19. Measurement Results – Upper Band Edge / Restricted Band

Mode of Operation CH9	Freq. (MHz)	Field Strength (dBµV/m)		Limit (dBµV/m)		Margin (dBµV/m)		Result
		Peak	Average	Peak	Average	Peak	Average	
HT40	2484.675	69.91	53.35	74	54	-4.09	-0.65	Compliant

7.7.20. Measurement Plot – Upper Band Edge / Restricted Band

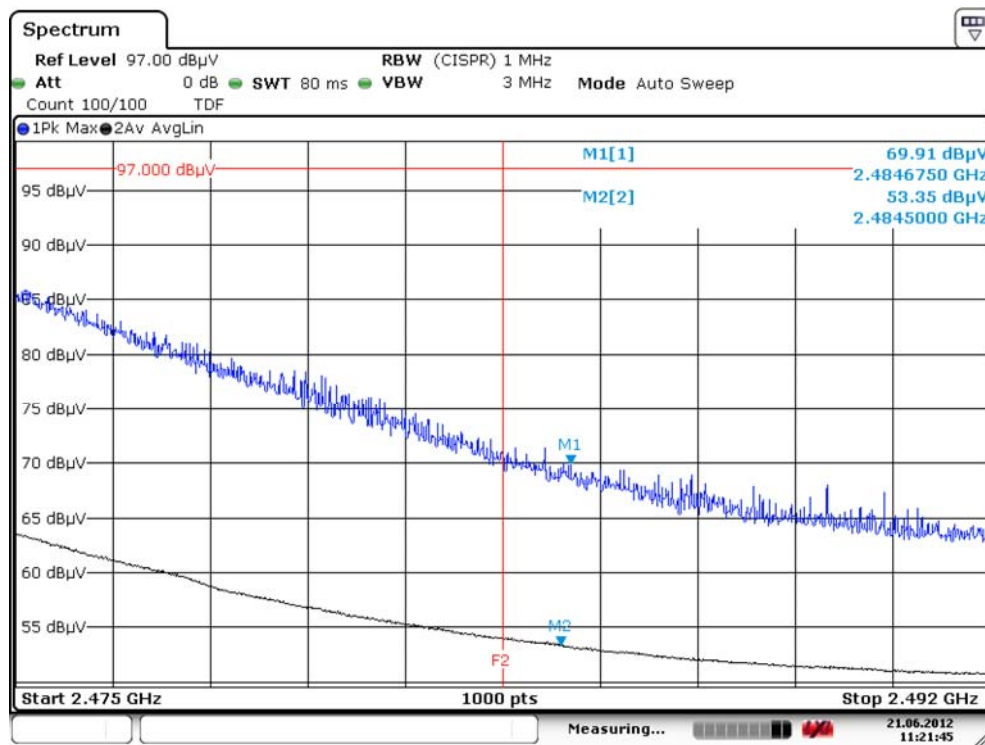

Date: 21.JUN.2012 11:21:45

7. Measurement Data (continued)

7.7. Band Edge Measurements (continued)

7.7.21. Measurement Results – Upper & Lower Band Edges / Restricted Band

Mode of Operation CH6	Freq. (MHz)	Field Strength (dBµV/m)		Limit (dBµV/m)		Margin (dBµV/m)		Result
		Peak	Average	Peak	Average	Peak	Average	
HT40	2386.950	68.94	53.21	74	54	-5.06	-0.79	Compliant

Mode of Operation CH6	Freq. (MHz)	Field Strength (dBµV/m)		Limit (dBµV/m)		Margin (dBµV/m)		Result
		Peak	Average	Peak	Average	Peak	Average	
HT40	2485.500	67.90	51.29	74	54	-6.10	-2.71	Compliant

7.7.22. Measurement Plot – Upper & Lower Band Edges / Restricted Band

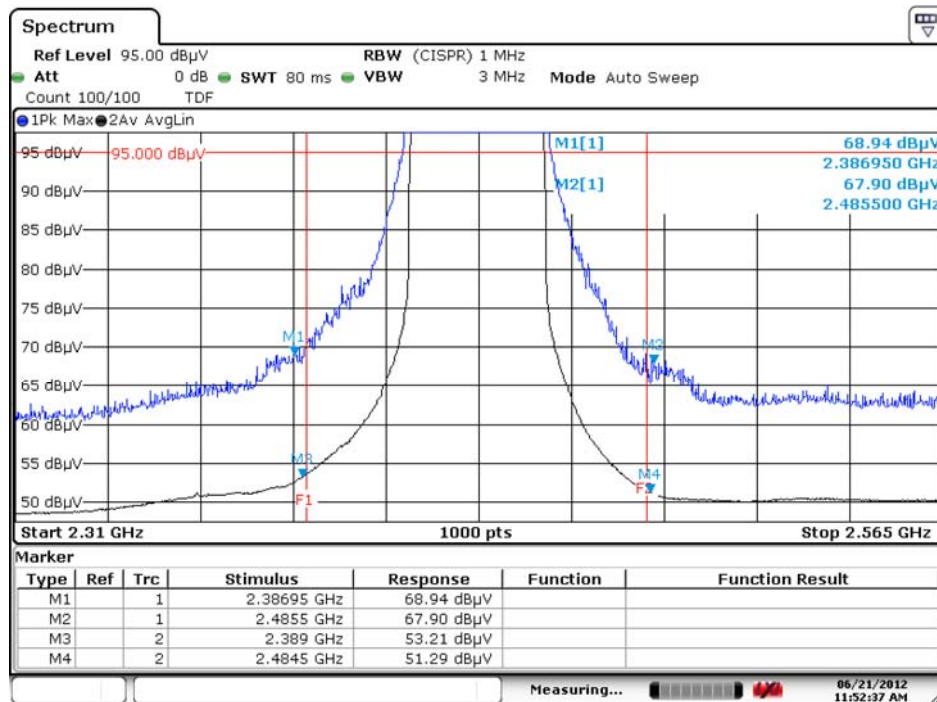

Date: 21.JUN.2012 11:52:36

7. Measurement Data (continued)**7.8. Power Spectral Density (15.247(e))**

Requirement: For digitally modulated systems, the power spectral density conducted from the intentional radiator to the antenna shall not be greater than 8 dBm in any 3 kHz band during any time interval of continuous transmission. This power spectral density shall be determined in accordance with the provisions of paragraph (b) of this section. The same method of determining the conducted output power shall be used to determine the power spectral density.

Procedure: FCC OET publication number 558074, Section 5.3: Maximum Power Spectral Density Level in the Fundamental Emission, clause 5.3.1: Measurement Procedure PKPSD.

Conclusion: The DUT passed the required power spectral density limit at the tested frequencies.

7. Measurement Data (continued)

7.8. Power Spectral Density (15.247(e)) (continued)

7.8.1. Measurement Results in 2400 to 2483.5 MHz band

802.11b Mode Channel	Channel Frequency (GHz)	Measured Frequency (GHz)	PSD Value Radiated (dBµV/m)	Power Spectral Density (dBm)	Add RBW Correction Factor ¹ (-15.2 dB)	Limit (dBm)	Result
Low	2412	2.4144900	113.64	5.911	-9.289	8	Compliant
Middle	2437	2.4354940	119.66	11.931	-3.269	8	Compliant
High	2462	2.4614900	116.18	8.451	-6.749	8	Compliant

802.11g Mode Channel	Channel Frequency (GHz)	Measured Frequency (GHz)	PSD Value Radiated (dBµV/m)	Power Spectral Density (dBm)	Add RBW Correction Factor ¹ (-15.2 dB)	Limit (dBm)	Result
Low	2412	2.4169900	110.92	3.191	-12.009	8	Compliant
Middle	2437	2.4382500	115.88	8.151	-7.049	8	Compliant
High	2462	2.4607300	111.40	3.671	-11.529	8	Compliant

802.11n HT20 Mode Channel	Channel Frequency (GHz)	Measured Frequency (GHz)	PSD Value Radiated (dBµV/m)	Power Spectral Density (dBm)	Add RBW Correction Factor ¹ (-15.2 dB)	Limit (dBm)	Result
Low	2412	2.4144900	109.82	2.091	-13.109	8	Compliant
Middle	2437	2.4319900	111.74	4.011	-11.189	8	Compliant
High	2462	2.4569900	108.83	1.101	-14.099	8	Compliant

802.11n HT40 Mode Channel	Channel Frequency (GHz)	Measured Frequency (GHz)	PSD Value Radiated (dBµV/m)	Power Spectral Density (dBm)	Add RBW Correction Factor ¹ (-15.2 dB)	Limit (dBm)	Result
Low	2422	2.4345000	102.65	-5.079	-20.279	8	Compliant
Middle	2437	2.4369800	107.56	-0.169	-15.369	8	Compliant
High	2452	2.4345000	104.59	-3.139	-18.339	8	Compliant

¹ RBW Correction factor = 10log (3 kHz/100 kHz) = -15.2 dB

The power spectral density was measured radiated at 3 meters and converted to dBm based upon the formula.

$$P = \frac{(E \times d)^2}{(30 \times G)}$$

7. Measurement Data (continued)

7.8. Power Spectral Density (15.247(e)) (continued)

7.8.2. Low Channel – 1 – 802.11b

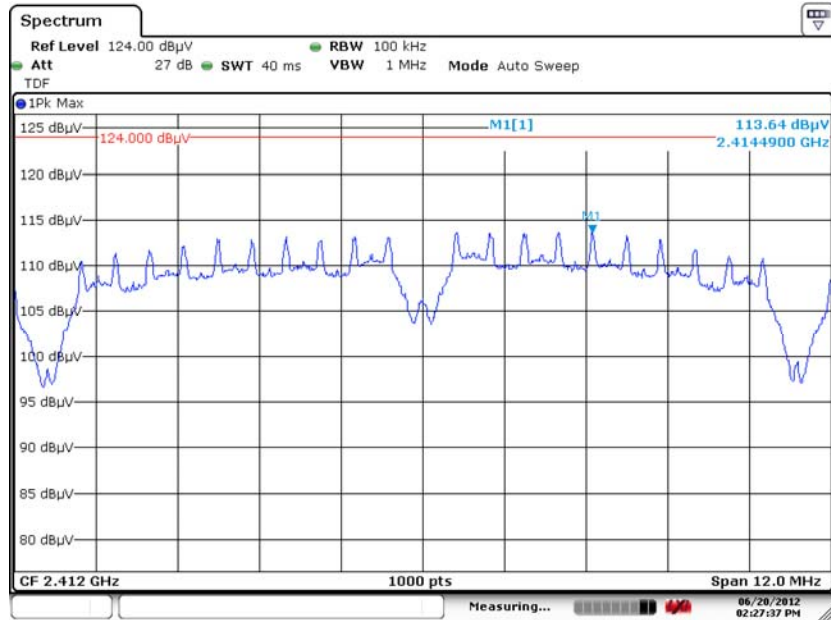

Date: 20.JUN.2012 14:27:37

7.8.3. Middle Channel – 6 – 802.11b

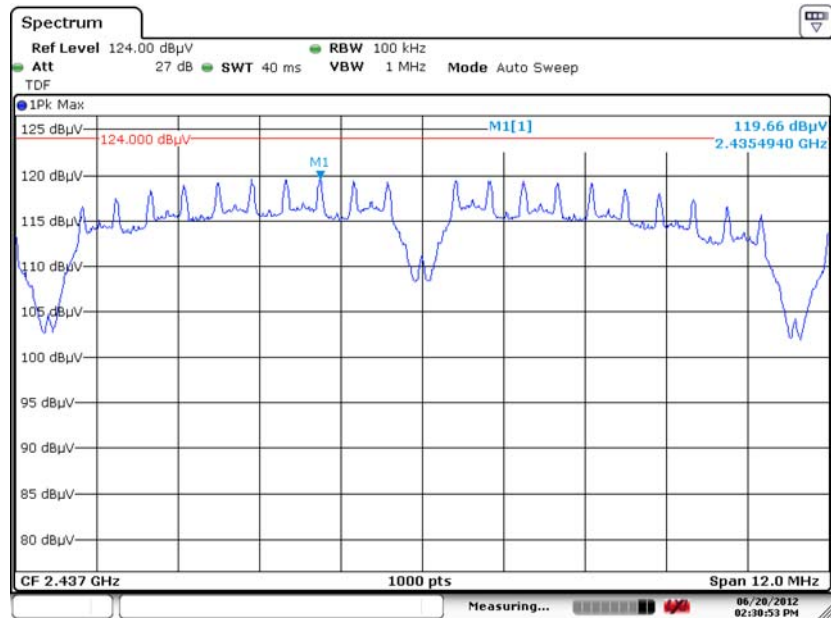

Date: 20.JUN.2012 14:30:52

7. Measurement Data (continued)

7.8. Power Spectral Density (15.247(e)) (continued)

7.8.4. High Channel – 11 – 802.11b

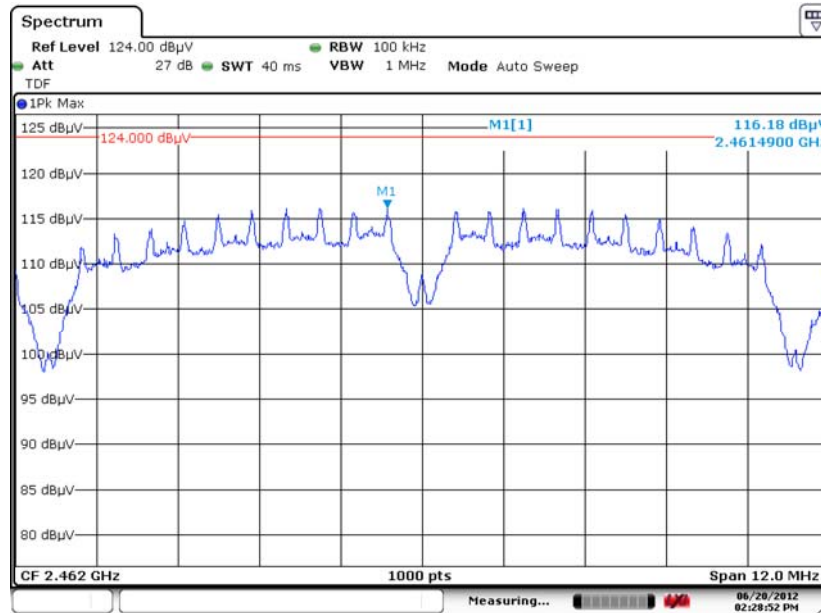

7.8.5. Low Channel – 1 – 802.11g

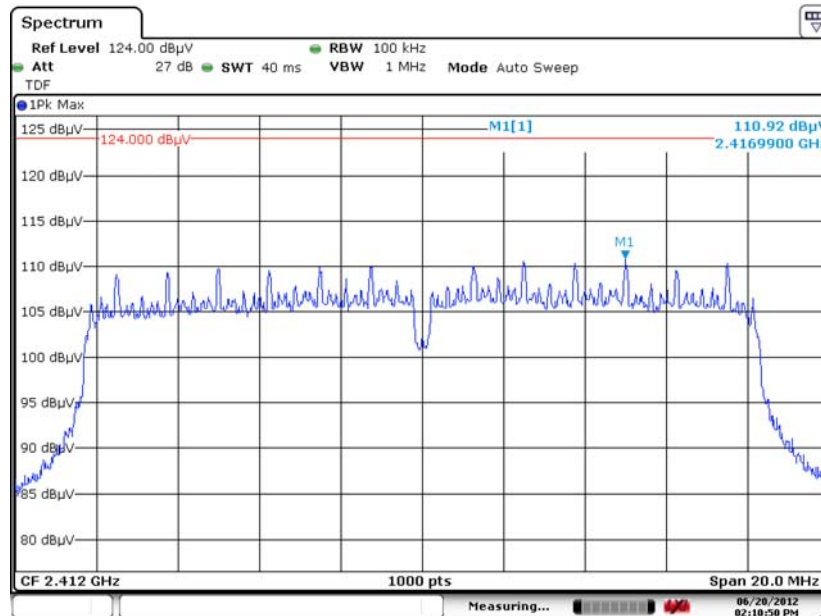

7. Measurement Data (continued)

7.8. Power Spectral Density (15.247(e)) (continued)

7.8.6. Mid Channel – 6 – 802.11g

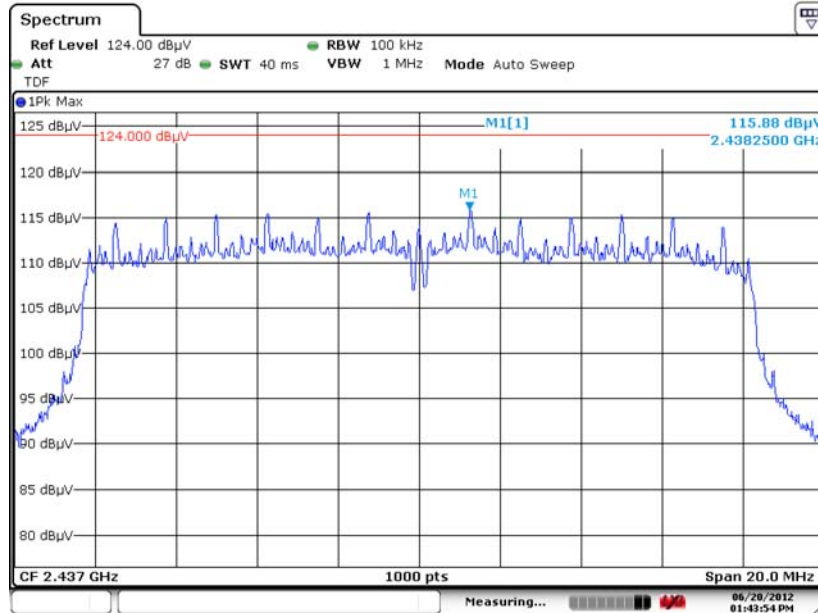

7.8.7. High Channel – 11 – 802.11g

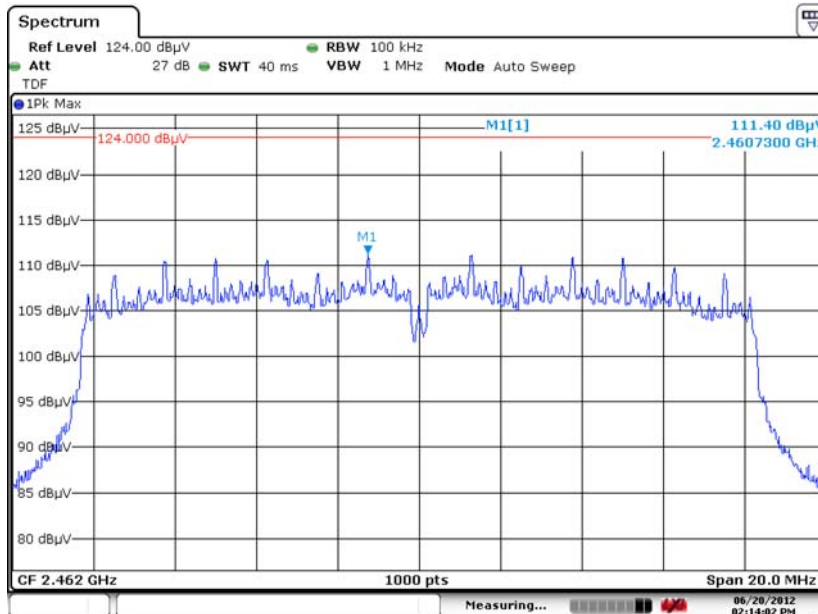

7. Measurement Data (continued)

7.8. Power Spectral Density (15.247(e))

7.8.8. Low Channel – 1 – 802.11n HT20

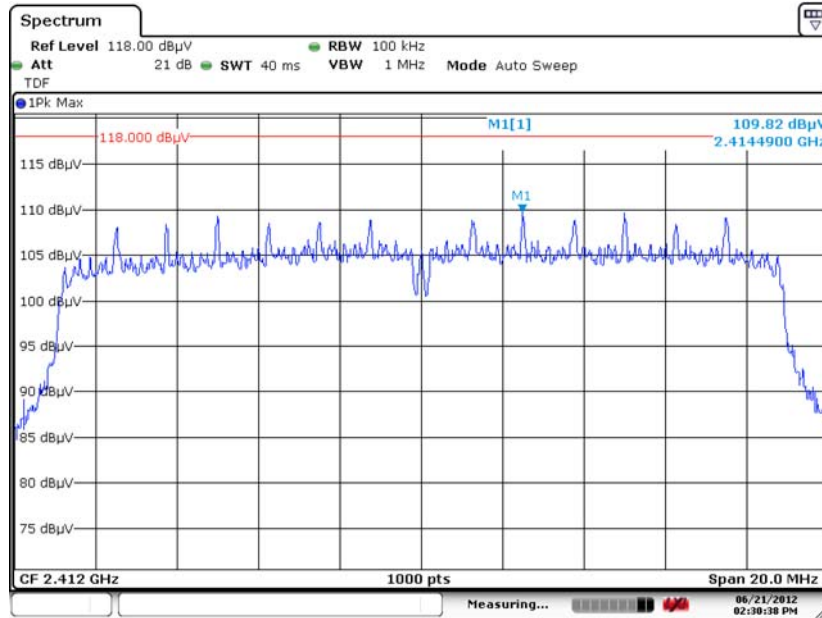

Date: 21.JUN.2012 14:30:38

7.8.9. Middle Channel – 6 – 802.11n HT20

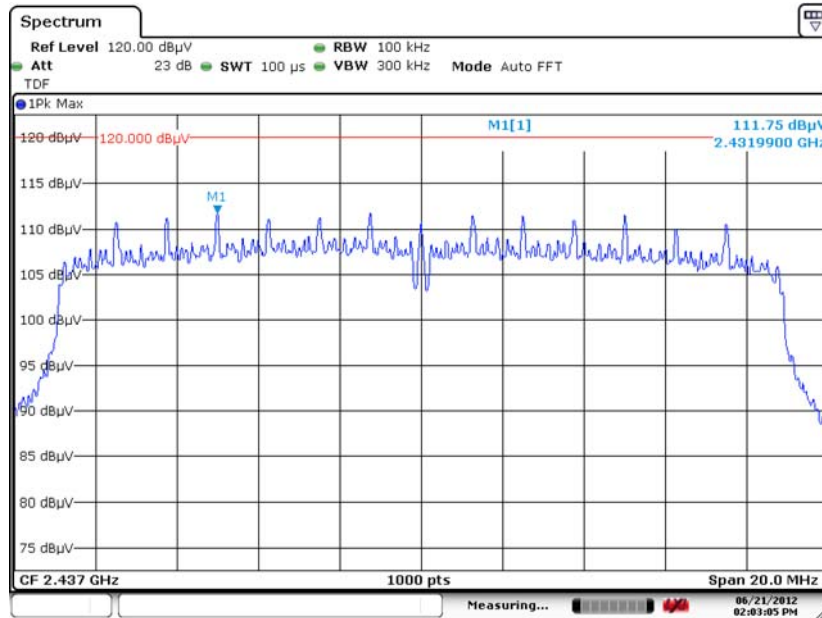

Date: 21.JUN.2012 14:03:04

7. Measurement Data (continued)

7.8. Power Spectral Density (15.247(e)) (continued)

7.8.10. High Channel – 11 – 802.11n HT20

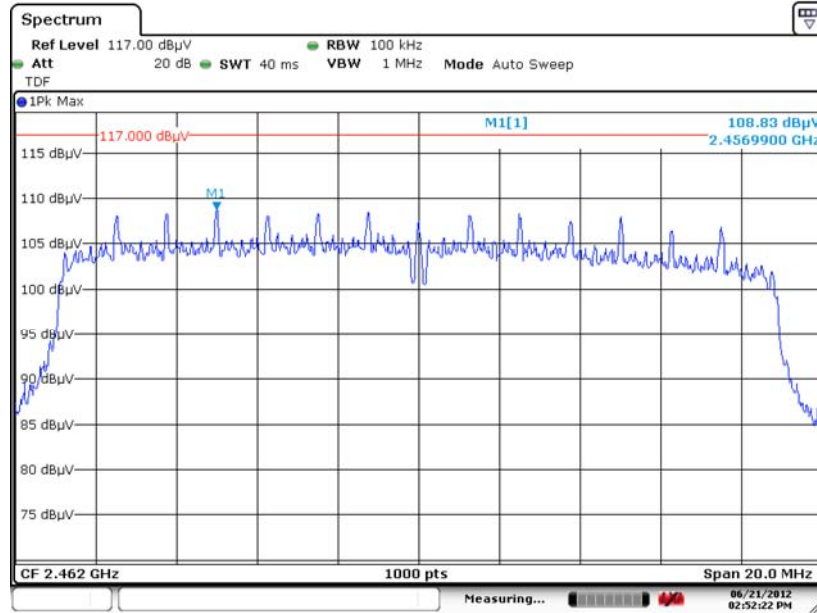

Date: 21.JUN.2012 14:52:22

7.8.11. Low Channel – 3 – 802.11n HT40

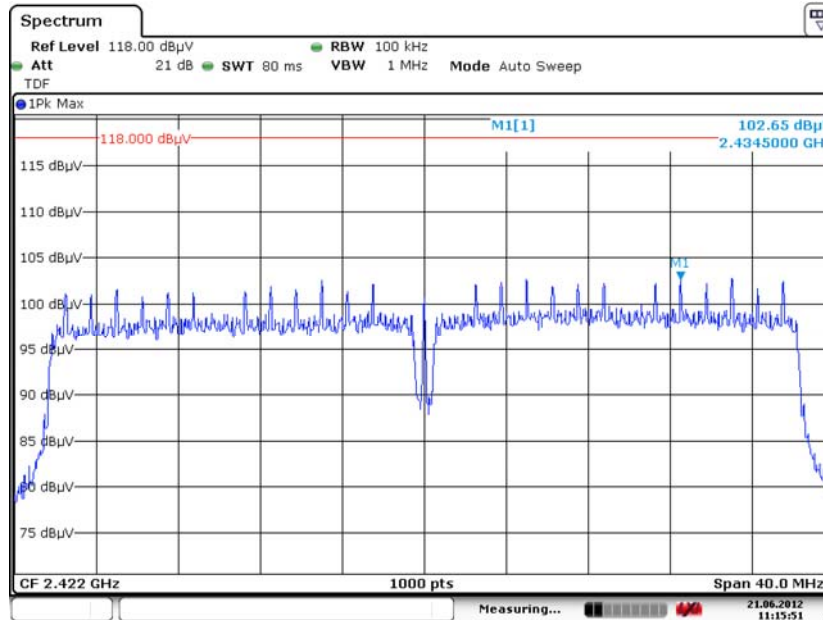

Date: 21.JUN.2012 11:15:50

7. Measurement Data (continued)

7.8. Power Spectral Density (15.247(e)) (continued)

7.8.12. Mid Channel – 6 – 802.11n HT40

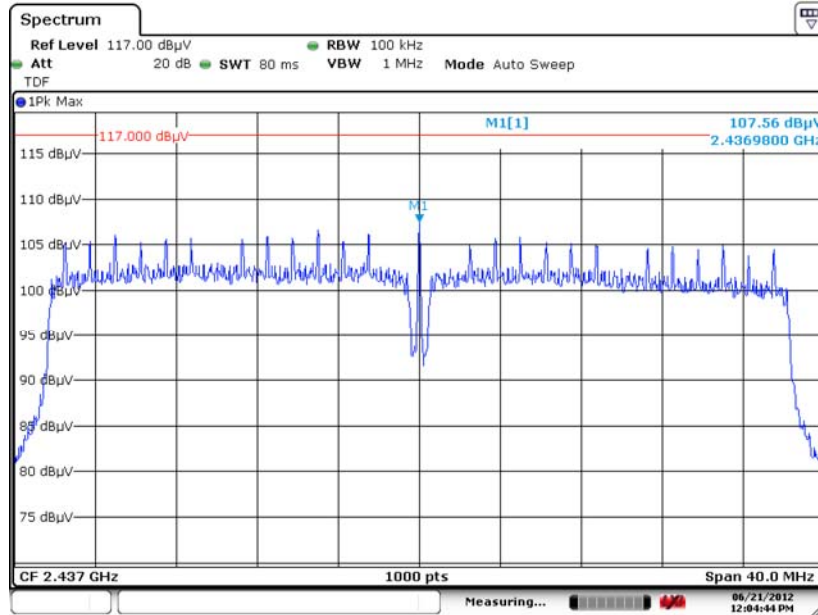

Date: 21.JUN.2012 12:04:43

7.8.13. High Channel – 9 – 802.11n HT40



Date: 21.JUN.2012 11:37:06

7. Measurement Data (continued)

7.8. Power Spectral Density (15.247(e))

7.8.14. Measurement Results in 5725 to 5850 MHz band

802.11a Mode Channel	Channel Frequency (GHz)	Measured Frequency (GHz)	PSD Value Radiated (dBµV/m)	Power Spectral Density (dBm)	Add RBW Correction Factor ¹ (-15.2 dB)	Limit (dBm)	Result
Low	5745	5.7499500	112.64	4.911	-10.289	8	Compliant
Middle	5765	5.7599500	112.27	4.541	-10.659	8	Compliant
High	5825	5.8199700	112.07	4.341	-10.859	8	Compliant

802.11n HT20 Channel	Channel Frequency (GHz)	Measured Frequency (GHz)	PSD Value Radiated (dBµV/m)	Power Spectral Density (dBm)	Add RBW Correction Factor ¹ (-15.2 dB)	Limit (dBm)	Result
Low	5745	5.7499700	112.77	5.041	-10.159	8	Compliant
Middle	5785	5.7899700	110.60	5.651	-9.549	8	Compliant
High	5825	5.8187100	110.32	2.591	-12.609	8	Compliant

802.11n HT40 Channel	Channel Frequency (GHz)	Measured Frequency (GHz)	PSD Value Radiated (dBµV/m)	Power Spectral Density (dBm)	Add RBW Correction Factor ¹ (-15.2 dB)	Limit (dBm)	Result
Low	5755	5.7499400	107.39	-0.339	-15.539	8	Compliant
High	5795	5.8099800	107.62	-0.109	-15.309	8	Compliant

¹ RBW Correction factor = 10log (3 kHz/100 kHz) = -15.2 dB

The power spectral density was measured radiated at 3 meters and converted to dBm based upon the formula.

$$P = \frac{(E \times d)^2}{(30 \times G)}$$

7. Measurement Data (continued)

7.8. Power Spectral Density (15.247(e)) (continued)

7.8.15. Low Channel – 149 – 802.11a

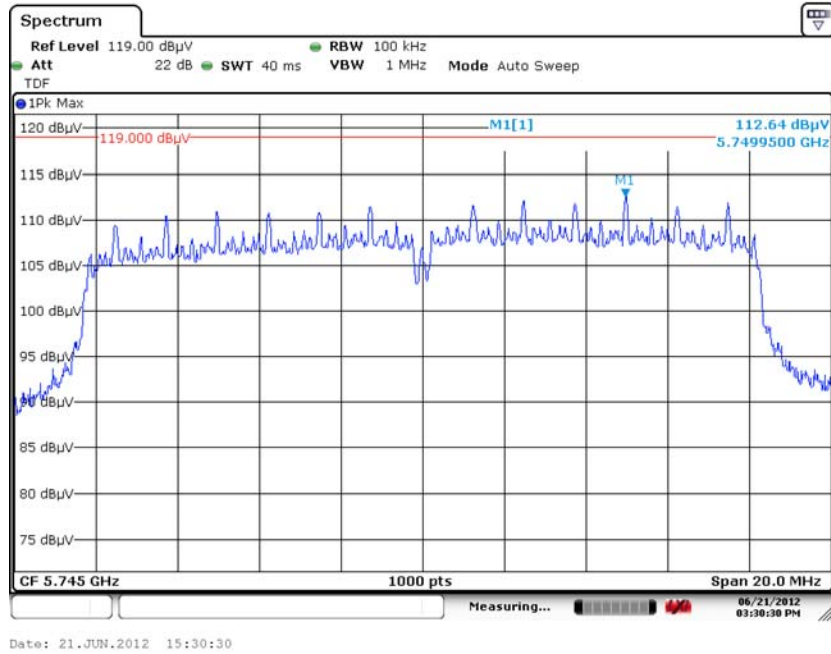

7.8.16. Middle Channel – 153 – 802.11a

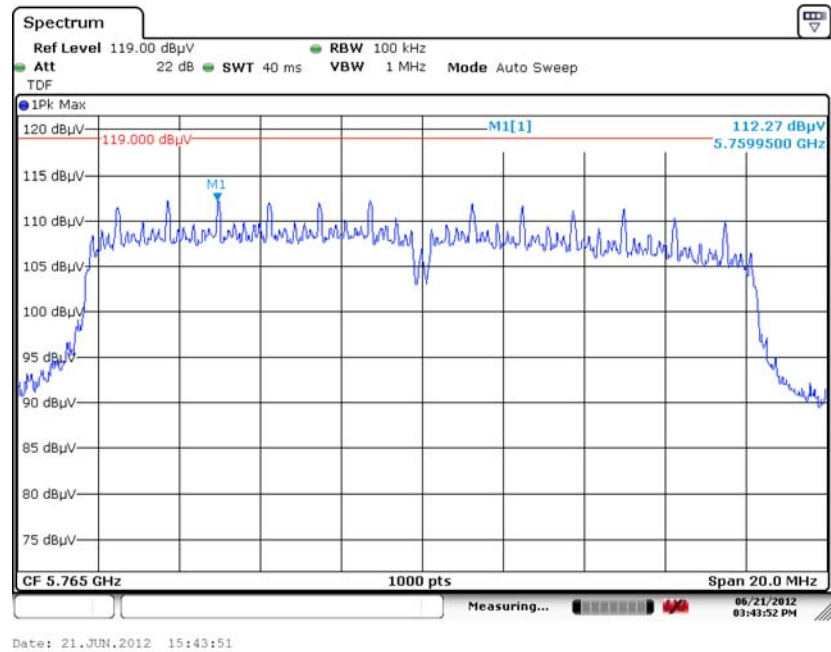

Test Number: 288-12R2

Issue Date: 06/29/2012

7. Measurement Data (continued)

7.8. Power Spectral Density (15.247(e)) (continued)

7.8.17. High Channel – 165 – 802.11a

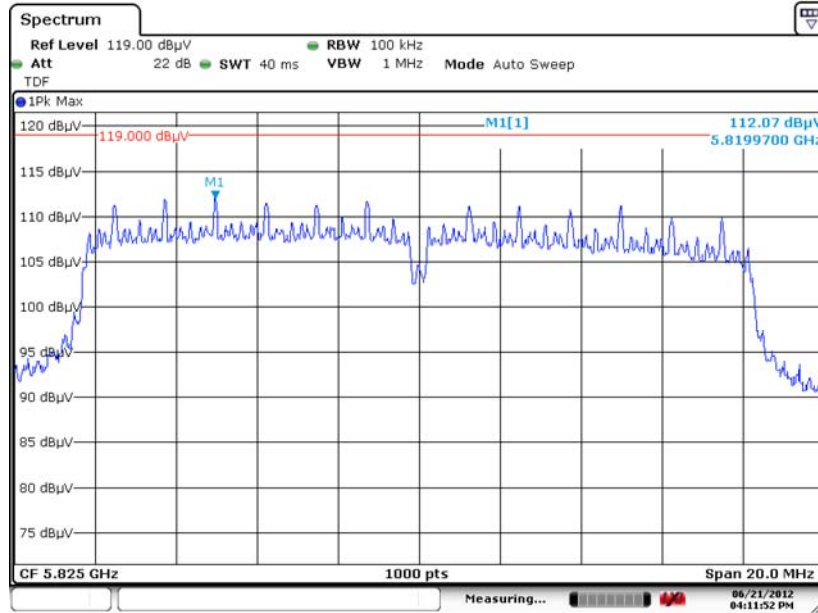

Date: 21.JUN.2012 16:11:51

7.8.18. Low Channel – 149 – 802.11n HT20

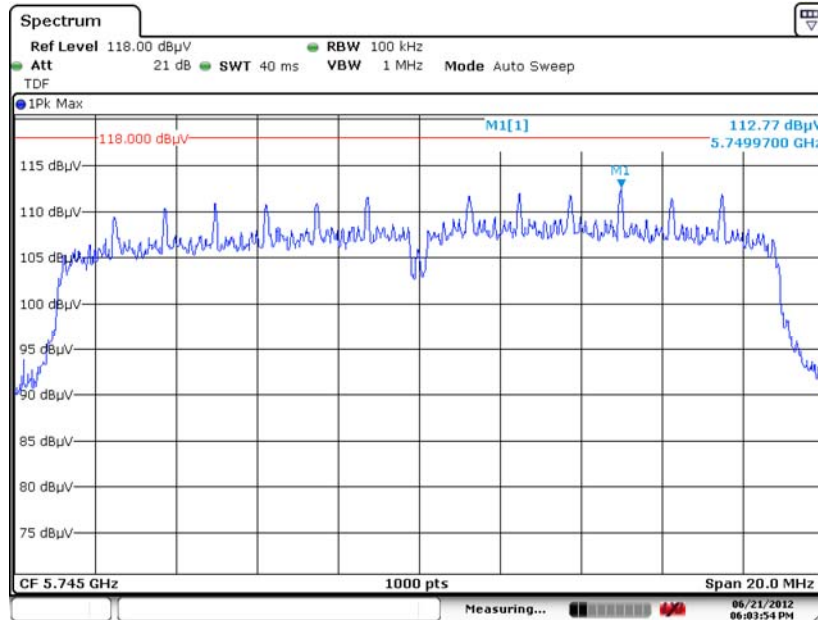

Date: 21.JUN.2012 18:03:53

7. Measurement Data (continued)

7.8. Power Spectral Density (15.247(e)) (continued)

7.8.19. Mid Channel – 157 – 802.11n HT20

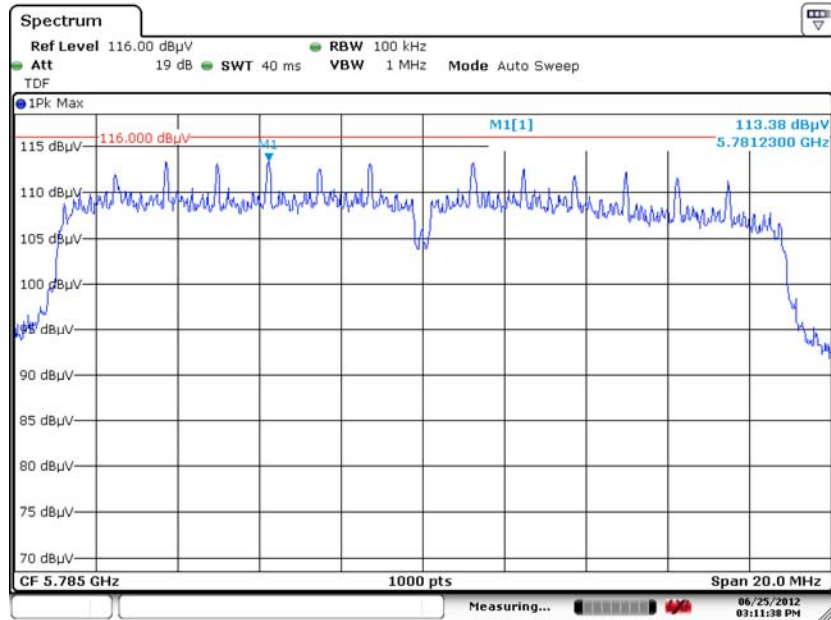

Date: 25.JUN.2012 15:11:38

7.8.20. High Channel – 165 – 802.11n HT20

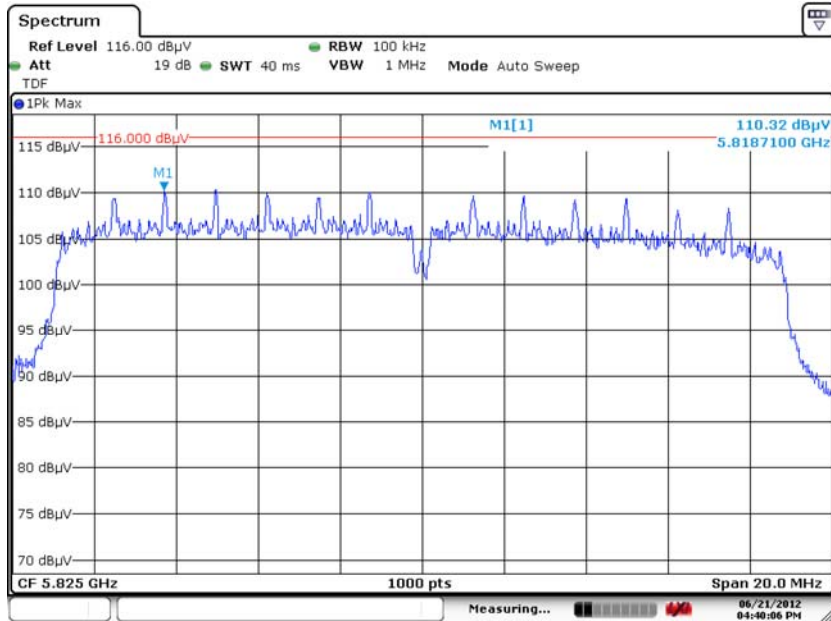

Date: 21.JUN.2012 16:40:05

7. Measurement Data (continued)

7.8. Power Spectral Density (15.247(e))

7.8.21. Low Channel – 151 – 802.11n HT40

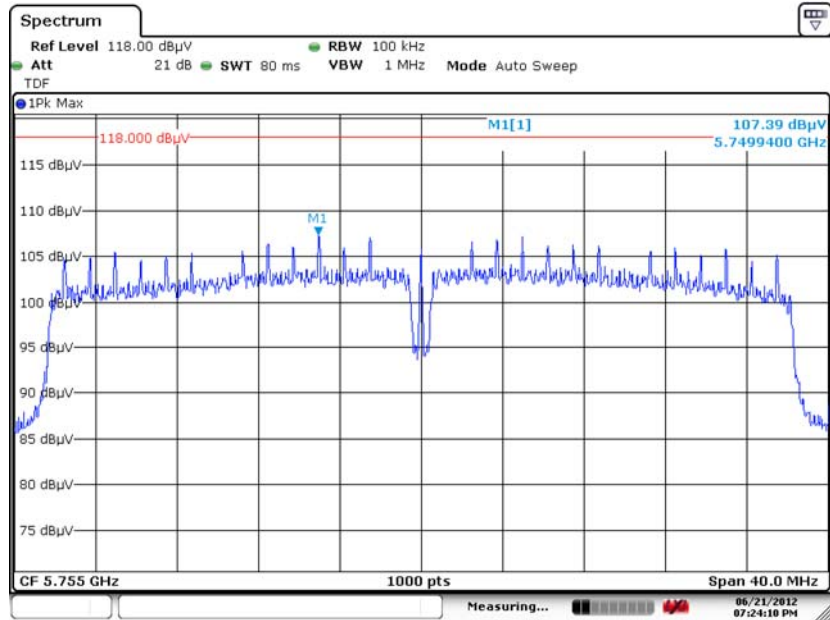

Date: 21.JUN.2012 19:24:09

7.8.22. High Channel – 159 – 802.11n HT40

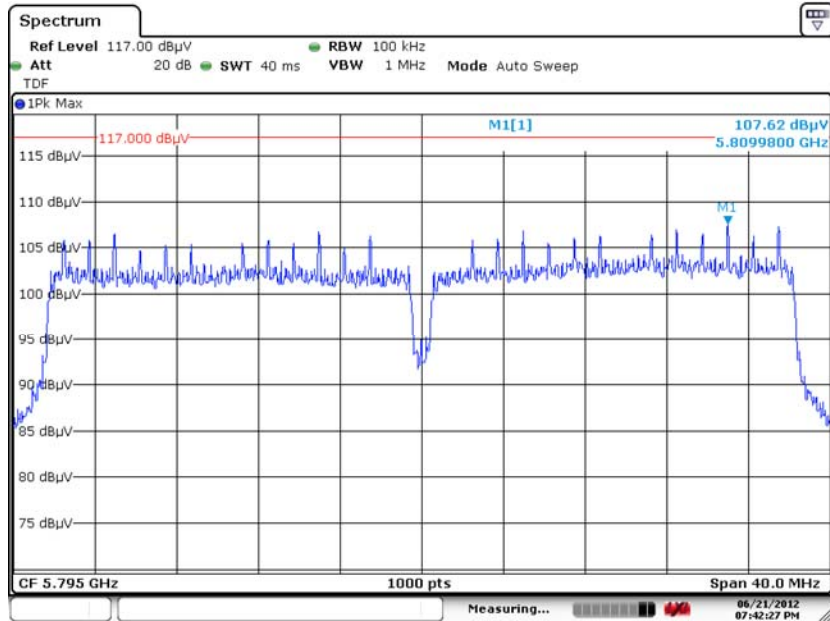

Date: 21.JUN.2012 19:42:26

7. Measurement Data (continued)

7.9. Conducted Emissions

7.9.1. 120 Volts, 60 Hz Phase

Test No.: 288-12, 120 Volts, 60 Hz Phase

FCC, Class B

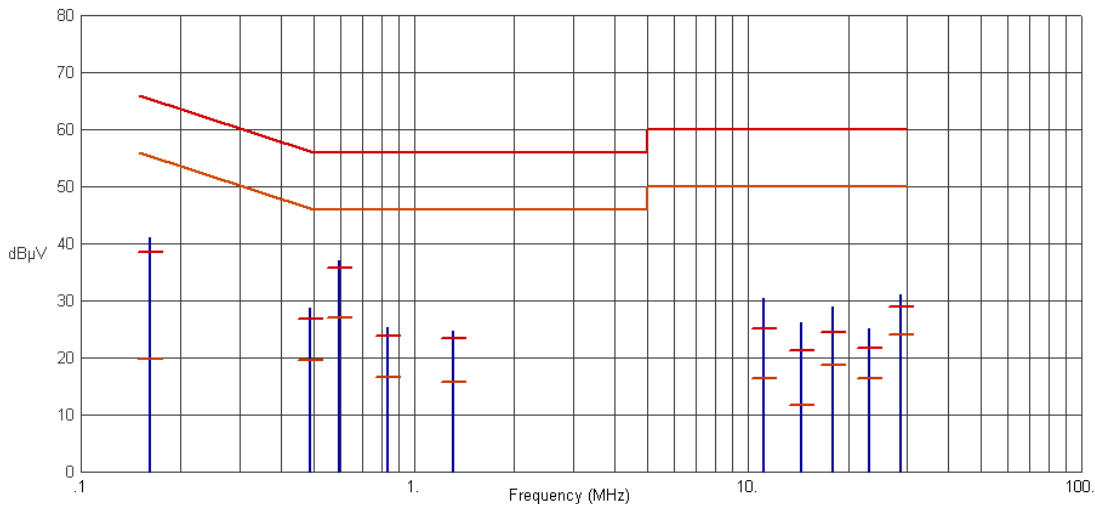

Frequency (MHz)	Pk Amp (dBµV)	QP Amp (dBµV)	QP Limit (dBµV)	QP Margin (dB)	Avg Amp (dBµV)	Avg Limit (dBµV)	Avg Margin (dB)	Comments
.1616	41.13	38.52	65.38	-26.86	19.73	55.38	-35.65	
.4871	28.69	26.66	56.22	-29.56	19.54	46.22	-26.68	
.5961	36.99	35.76	56.00	-20.24	26.89	46.00	-19.11	
.8354	25.26	23.87	56.00	-32.13	16.53	46.00	-29.47	
1.3067	24.67	23.28	56.00	-32.72	15.74	46.00	-30.26	
11.2169	30.48	25.01	60.00	-34.99	16.33	50.00	-33.67	
14.4453	26.09	21.12	60.00	-38.88	11.64	50.00	-38.36	
17.9401	28.79	24.48	60.00	-35.52	18.56	50.00	-31.44	
23.1283	25.02	21.58	60.00	-38.42	16.39	50.00	-33.61	
28.6856	31.00	28.95	60.00	-31.05	23.96	50.00	-26.04	

7. Measurement Data (continued)

7.9. Conducted Emissions

7.9.2. 120 Volts, 60 Hz Neutral

Test No.: 288-12, 120 Volts, 60 Hz Neutral

FCC, Class B

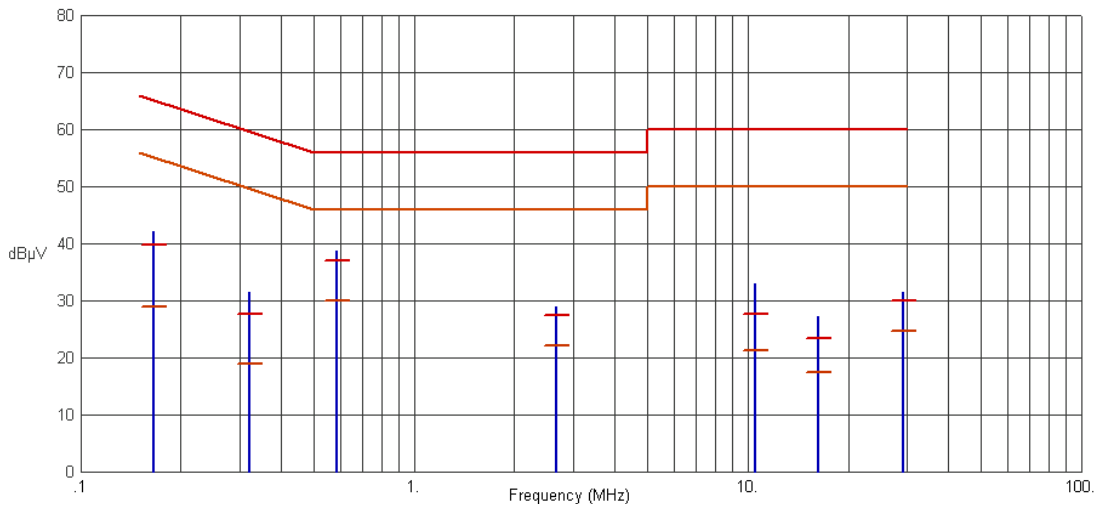

Frequency (MHz)	Pk Amp (dBµV)	QP Amp (dBµV)	QP Limit (dBµV)	QP Margin (dB)	Avg Amp (dBµV)	Avg Limit (dBµV)	Avg Margin (dB)	Comments
.1656	42.03	39.87	65.18	-25.31	28.99	55.18	-26.19	
.3204	31.51	27.68	59.70	-32.02	18.92	49.70	-30.78	
.5858	38.66	36.95	56.00	-19.05	30.03	46.00	-15.97	
2.6776	28.82	27.31	56.00	-28.69	22.13	46.00	-23.87	
10.5366	32.86	27.72	60.00	-32.28	21.32	50.00	-28.68	
16.2296	27.21	23.34	60.00	-36.66	17.40	50.00	-32.60	
29.2365	31.51	29.88	60.00	-30.12	24.66	50.00	-25.34	

7. Measurement Data (continued)

**7.10. Public Exposure to Radio Frequency Energy Levels (15.247(i) (1.1307 (b)(1))
RSS-GEN 5.5, RSS 102**

Requirement: (15.247(i))

Systems operating under the provisions of this section shall be operated in a manner that ensures that the public is not exposed to radio frequency energy levels in excess of the Commission's guidelines. Devices are subject to the radio frequency radiation exposure requirements specified in 47CFR 1.1307(b), FCC 47 CFR 2.1091 and 47 CFR 2.1093, as appropriate. All equipment shall be considered to operate in a "general population/uncontrolled" environment.

Procedure: The power density is calculated from the peak field strength and device antenna gain:

$$PD = \frac{OP + AG}{(4 \times \pi \times d^2)}$$

PD Power Density	mW/cm ²
OP DUT Output Power	dBm
AG DUT Antenna Gain	dBi
d MPE Distance	cm

Conclusion: The device under test is meets radio frequency radiation exposure requirements specified in 47CFR 1.1307(b), § 2.1091 and § 2.1093.

Power Calculated from Peak Field Strength

802.11b Mode Channel	Frequency	Peak Field Strength	Distance	Antenna Gain ¹	Measured Output Power
	(MHz)	(dBµV/m)	(m)	(dBi)	(mW)
Low	2412	126.46	3.0	12.5	74.67
Mid	2437	131.94	3.0	12.5	263.71
High	2462	128.80	3.0	12.5	127.97

802.11g Mode Channel	Frequency	Peak Field Strength	Distance	Antenna Gain ¹	Measured Output Power
	(MHz)	(dBµV/m)	(m)	(dBi)	(mW)
Low	2412	131.16	3.0	12.5	220.35
Mid	2437	134.81	3.0	12.5	510.65
High	2462	130.93	3.0	12.5	208.99

7. Measurement Data (continued)

**7.10. Public Exposure to Radio Frequency Energy Levels (15.247(i) (1.1307 (b)(1))
RSS-GEN 5.5, RSS 102 (continued)**

HT20 Mode Channel	Frequency	Peak Field Strength	Distance	Antenna Gain ¹	Measured Output Power
	(MHz)	(dB μ V/m)	(m)	(dBi)	(mW)
Low	2412	129.00	3.0	12.5	134.01
Mid	2437	131.75	3.0	12.5	252.42
High	2462	128.26	3.0	12.5	113.01

HT40 Mode Channel	Frequency	Peak Field Strength	Distance	Antenna Gain ¹	Measured Output Power
	(MHz)	(dB μ V/m)	(m)	(dBi)	(mW)
Low	2422	126.10	3.0	12.5	68.73
Mid	2437	128.93	3.0	12.5	131.86
High	2452	126.63	3.0	12.5	77.65

¹ Antenna gain value provided by the manufacturer.

² Reference Section 7.4 of this test report for the formula used to convert field strength to power.

7. Measurement Data (continued)

7.10. Public Exposure to Radio Frequency Energy Levels (15.247(i) (1.1307 (b)(1))
RSS-GEN 5.5, RSS 102 (continued)

802.11b Mode Channel Frequency	MPE Distance (cm)	DUT Output Power (dBm)	DUT Antenna Gain (dBi)	Power Density		Limit (mW/cm ²)	Result
				(mW/cm ²)	(W/m ²)		
	(1)	(2)	(3)	(4)		(5)	
2412	20.0	18.73	12.5	0.2641505	2.6415048	1	Compliant
2437	20.0	24.21	12.5	0.9329350	9.3293503	1	Compliant
2462	20.0	21.07	12.5	0.4527426	4.5274264	1	Compliant

802.11g Mode Channel Frequency	MPE Distance (cm)	DUT Output Power (dBm)	DUT Antenna Gain (dBi)	Power Density		Limit (mW/cm ²)	Result
				(mW/cm ²)	(W/m ²)		
	(1)	(2)	(3)	(4)		(5)	
2412	20.0	23.43	12.5	0.7795633	7.7956333	1	Compliant
2437	27.0	27.08	12.5	0.9912515	9.9125151	1	Compliant
2462	20.0	23.20	12.5	0.7393523	7.3935225	1	Compliant

HT20 Mode Channel Frequency	MPE Distance (cm)	DUT Output Power (dBm)	DUT Antenna Gain (dBi)	Power Density		Limit (mW/cm ²)	Result
				(mW/cm ²)	(W/m ²)		
	(1)	(2)	(3)	(4)		(5)	
2412	20.0	21.27	12.5	0.4740797	4.7407974	1	Compliant
2437	20.0	24.02	12.5	0.8929999	8.9299988	1	Compliant
2462	20.0	20.53	12.5	0.3998079	3.9980793	1	Compliant

HT40 Mode Channel Frequency	MPE Distance (cm)	DUT Output Power (dBm)	DUT Antenna Gain (dBi)	Power Density		Limit (mW/cm ²)	Result
				(mW/cm ²)	(W/m ²)		
	(1)	(2)	(3)	(4)		(5)	
2422	20.0	18.37	12.5	0.2431372	2.4313719	1	Compliant
2437	20.0	21.20	12.5	0.4664997	4.6649973	1	Compliant
2452	20.0	18.90	12.5	0.2746954	2.7469541	1	Compliant

- Reference CFR 2.1093(b): For purposes of this section, a portable device is defined as a transmitting device designed to be used so that the radiating structure(s) of the device is/are within 20 centimeters of the body of the user.
- Section 7.4 of this test report.
 - Data supplied by the client. Antenna specification data of worst case antenna used by the DUT.
 - Power density is calculated from field strength measurement and antenna gain.
 - Reference CFR 1.1310, Table 1: Limits for Maximum Permissible Exposure (MPE), Section (B): Limits for General Population/Uncontrolled Exposure.

7. Measurement Data (continued)

**7.10. Public Exposure to Radio Frequency Energy Levels (15.247(i) (1.1307 (b)(1))
RSS-GEN 5.5, RSS 102**

Requirement: (15.247(i))

Systems operating under the provisions of this section shall be operated in a manner that ensures that the public is not exposed to radio frequency energy levels in excess of the Commission’s guidelines. Devices are subject to the radio frequency radiation exposure requirements specified in 47CFR 1.1307(b), FCC 47 CFR 2.1091 and 47 CFR 2.1093, as appropriate. All equipment shall be considered to operate in a “general population/uncontrolled” environment.

Procedure: The power density is calculated from the peak field strength and device antenna gain:

$$PD = \frac{OP + AG}{(4 \times \pi \times d^2)}$$

PD Power Density	mW/cm ²
OP DUT Output Power	dBm
AG DUT Antenna Gain	dBi
d MPE Distance	cm

Conclusion: The device under test is meets radio frequency radiation exposure requirements specified in 47CFR 1.1307(b), § 2.1091 and § 2.1093.

Power Calculated from Peak Field Strength

802.11a Mode Channel	Frequency	Peak Field Strength	Distance	Antenna Gain ¹	Measured Output Power
	(MHz)	(dBµV/m)	(m)	(dBi)	(mW)
Low	5745	132.51	3.0	12.5	300.69
Mid	5785	132.50	3.0	12.5	300.00
High	5825	132.13	3.0	12.5	275.50

HT20 Mode Channel	Frequency	Peak Field Strength	Distance	Antenna Gain ¹	Measured Output Power
	(MHz)	(dBµV/m)	(m)	(dBi)	(mW)
Low	5745	131.12	3.0	12.5	218.33
Mid	5785	130.13	3.0	12.5	173.83
High	5825	129.58	3.0	12.5	153.15

7. Measurement Data (continued)

**7.10. Public Exposure to Radio Frequency Energy Levels (15.247(i) (1.1307 (b)(1))
RSS-GEN 5.5, RSS 102 (continued)**

HT40 Mode Channel	Frequency	Peak Field Strength	Distance	Antenna Gain ¹	Measured Output Power
	(MHz)	(dB μ V/m)	(m)	(dBi)	(mW)
Low	5755	129.78	3.0	12.5	160.37
High	5795	129.51	3.0	12.5	150.70

¹ Antenna gain value provided by the manufacturer.

² Reference Section 7.4 of this test report for the formula used to convert field strength to power.

7. Measurement Data (continued)

**7.10. Public Exposure to Radio Frequency Energy Levels (15.247(i) (1.1307 (b)(1))
RSS-GEN 5.5, RSS 102 (continued)**

802.11a Mode Channel Frequency	MPE Distance (cm)	DUT Output Power (dBm)	DUT Antenna Gain (dBi)	Power Density		Limit (mW/cm2)	Result
				(mW/cm2)	(W/m2)		
	(1)	(2)	(3)	(4)		(5)	
5745	21.0	24.78	12.5	0.9648789	9.6487888	1	Compliant
5785	21.0	24.77	12.5	0.9626597	9.6265972	1	Compliant
5825	20.0	24.40	12.5	0.9746561	9.7465609	1	Compliant

HT20 Mode Channel Frequency	MPE Distance (cm)	DUT Output Power (dBm)	DUT Antenna Gain (dBi)	Power Density		Limit (mW/cm2)	Result
				(mW/cm2)	(W/m2)		
	(1)	(2)	(3)	(4)		(5)	
5745	20.0	23.39	12.5	0.7724162	7.7241625	1	Compliant
5785	20.0	22.40	12.5	0.6149664	6.1496642	1	Compliant
5825	20.0	21.85	12.5	0.5418155	5.4181547	1	Compliant

HT40 Mode Channel Frequency	MPE Distance (cm)	DUT Output Power (dBm)	DUT Antenna Gain (dBi)	Power Density		Limit (mW/cm2)	Result
				(mW/cm2)	(W/m2)		
	(1)	(2)	(3)	(4)		(5)	
5745	20.0	22.05	12.5	0.5673504	5.6735044	1	Compliant
5795	20.0	21.78	12.5	0.5331524	5.3315244	1	Compliant

- Reference CFR 2.1093(b): For purposes of this section, a portable device is defined as a transmitting device designed to be used so that the radiating structure(s) of the device is/are within 20 centimeters of the body of the installer. All other mobile and unlicensed transmitting devices are categorically excluded from routine environmental evaluation for RF exposure prior to equipment authorization or use, except as specified in §§ 1.1307(c) and 1.1307(d) of this chapter.
- Section 7.4 of this test report.
 - Data supplied by the client. Antenna specification data of worst case antenna used by the DUT.
 - Power density is calculated from field strength measurement and antenna gain.
 - Reference CFR 1.1310, Table 1: Limits for Maximum Permissible Exposure (MPE), Section (B): Limits for General Population/Uncontrolled Exposure.

7. Measurement Data (continued)

**7.10. Public Exposure to Radio Frequency Energy Levels (15.247(i) (1.1307 (b)(1))
RSS-GEN 5.5, RSS 102 (continued)**

Co-location of Radio Operation. Worse case from 2.4 GHz and 5.8 GHz Modes of operation.

Radio	MPE Distance (cm)	DUT Output Power (dBm)	DUT Antenna Gain (dBi)	Power Density (mW/cm ²)	Power Density (W/m ²)	Limit (mW/cm ²)	Result
	(1)	(2)	(3)	(4)	(4)	(5)	
802.11g	38.0	27.08	12.5	0.5002913	5.0029129	1.00	Compliant
802.11a	30.0	24.78	12.5	0.4726587	4.7265867	1.00	Compliant
SUM	38.0	N/A	N/A	0.9729500	9.7294996	1.00	Compliant

Note: For outdoor installations, installers must be instructed to be at least 38 cm away from the high gain antenna when the device is in operation.

A minimum separation of 38 cm from the antenna is required when both radios are in operation in the 2.4 and 5.8 GHz bands.

8. Test Setup Photographs

8.1. Radiated Emissions Front:



8. Test Setup Photographs

8.2. Radiated Emissions Rear below 30 MHz:



8. Test Setup Photographs

8.3. Radiated Emissions Rear 30 MHz to 1 GHz



8. Test Setup Photographs

8.4. Radiated Emissions Rear Above 1 GHz



8. Test Setup Photographs

8.5. Conducted Emissions Front

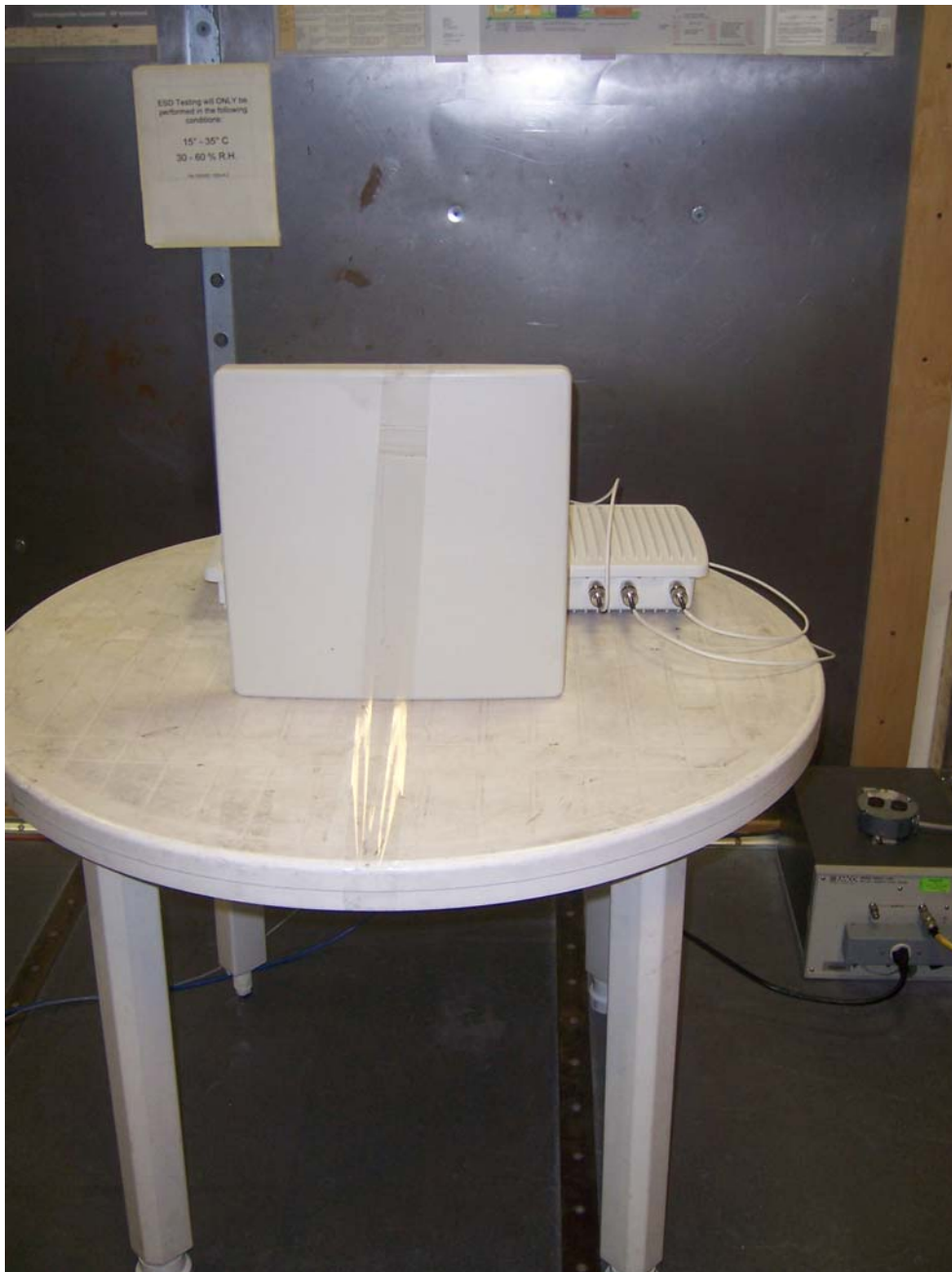

8. Test Setup Photographs

8.6. Conducted Emissions Rear



9. Test Site Description

Compliance Worldwide is located at 357 Main Street in Sandown, New Hampshire. The test sites at Compliance Worldwide are used for conducted and radiated emissions testing in accordance with Federal Communications Commission (FCC) and Industry Canada standards. A description of the test sites is on file with the FCC (registration number **96392**) and Industry Canada (file number **IC 3023A-1**).

The radiated emissions test site is a 3 and 10 meter enclosed open area test site (OATS). Personnel, support equipment and test equipment are located in the basement beneath the OATS ground plane.

The conducted emissions site is part of a 16' x 20' x 12' ferrite tile chamber and uses one of the walls for the vertical ground plane required by EN 55022.

Both sites are designed to test products or systems 1.5 meter W x 1.5 meter L x 2.0 meter H, floor standing or table top.