



FCC RADIO TEST REPORT

FCC ID : QXO-AP510I
Equipment : 802.11ax Access Point
Brand Name : Extreme Networks
Model Name : AP560i
Applicant : Extreme Networks, Inc.
6480 Via Del Oro, San Jose, CA 95119
Manufacturer : Extreme Networks, Inc.
6480 Via Del Oro, San Jose, CA 95119
Standard : 47 CFR FCC Part 15.247

The product was received on Feb. 15, 2019, and testing was started from Feb. 19, 2019 and completed on Mar. 13, 2019. We, SPORTON INTERNATIONAL INC. EMC & Wireless Communications Laboratory, would like to declare that the tested sample has been evaluated in accordance with the procedures given in ANSI C63.10-2013 and shown compliance with the applicable technical standards.

The report must not be used by the client to claim product certification, approval, or endorsement by TAF or any agency of government.

The test results in this variant report apply exclusively to the tested model / sample. Without written approval of SPORTON INTERNATIONAL INC. EMC & Wireless Communications Laboratory, the test report shall not be reproduced except in full.



Approved by: Sam Chen

SPORTON INTERNATIONAL INC. EMC & Wireless Communications Laboratory
No. 52, Huaya 1st Rd., Guishan Dist., Taoyuan City, Taiwan (R.O.C.)



Table of Contents

History of this test report.....3

Summary of Test Result.....4

1 General Description5

1.1 Information.....5

1.2 Testing Applied Standards9

1.3 Testing Location Information.....9

1.4 Measurement Uncertainty9

2 Test Configuration of EUT10

2.1 Test Channel Mode10

2.2 The Worst Case Measurement Configuration.....10

2.3 EUT Operation during Test12

2.4 Accessories12

2.5 Support Equipment.....13

2.6 Test Setup Diagram14

3 Transmitter Test Result17

3.1 AC Power-line Conducted Emissions17

3.2 Emissions in Restricted Frequency Bands.....19

4 Test Equipment and Calibration Data23

Appendix A. Test Results of AC Power-line Conducted Emissions

Appendix B. Test Results of Emissions in Restricted Frequency Bands

Appendix C. Test Photos

Photographs of EUT v01



Summary of Test Result

Report Clause	Ref Std. Clause	Test Items	Result (PASS/FAIL)	Remark
1.1.2	15.203	Antenna Requirement	PASS	-
3.1	15.207	AC Power-line Conducted Emissions	PASS	-
3.2	15.247(d)	Emissions in Restricted Frequency Bands	PASS	-

Declaration of Conformity:

The test results with all measurement uncertainty excluded are presented in accordance with the regulation limits or requirements declared by manufacturers.

Comments and Explanations:

1. The test configuration, test mode and test software were written in this test report are declared by the manufacturer.
2. The declared of product specification for EUT presented in the report are provided by the manufacturer, and the manufacturer takes all the responsibilities for the accuracy of product specification.

Reviewed by: **Cliff Chang**
Report Producer: **Wendy Pan**



1 General Description

1.1 Information

1.1.1 RF General Information

Frequency Range (MHz)	Bluetooth Mode	Ch. Frequency (MHz)	Channel Number
2400-2483.5	LE	2402-2480	0-39 [40]

Band	Mode	BWch (MHz)	Nant
2.4-2.4835GHz	BT-LE(1Mbps)	1.0	1TX

Note:

- ♦ Bluetooth LE uses a GFSK modulation for DSSS.
- ♦ BWch is the nominal channel bandwidth.
- ♦ Nss-Min is the minimum number of spatial streams.
- ♦ Nant is the number of outputs. e.g., 2(2, 3) means have 2 outputs for port 2 and port 3. 2 means have 2 outputs for port 1 and port 2.



1.1.2 Antenna Information

Ant.	Port			Brand	Model Name	Antenna Type	Connector	Radio	Antenna Gain(dBi)
	1TX	2TX	4TX						
1	1	1	1	WNC	Starlord 510i	PIFA	I-PEX	R1-5GHz	Note 1
2	-	2	2	WNC	Starlord 510i	PIFA	I-PEX	R1-5GHz	Note 1
3	-	-	3	WNC	Starlord 510i	PIFA	I-PEX	R1-5GHz	Note 1
4	-	-	4	WNC	Starlord 510i	PIFA	I-PEX	R1-5GHz	Note 1
5	R2-1	R2-1	R1-4 R2-1	WNC	Starlord 510i	PIFA	I-PEX	R1-2.4GHz R2-5GHz	Note 1
6	-	R2-2	R1-3 R2-2	WNC	Starlord 510i	PIFA	I-PEX	R1-2.4GHz R2-5GHz	Note 1
7	-	R1-2	R1-2 R2-3	WNC	Starlord 510i	PIFA	I-PEX	R1-2.4GHz R2-5GHz	Note 1
8	R1-1	R1-1	R1-1 R2-4	WNC	Starlord 510i	PIFA	I-PEX	R1-2.4GHz R2-5GHz	Note 1
9	1	-	-	WNC	Starlord 510i	PIFA	I-PEX	R3	Note 1

Note1:

Ant.	Antenna Gain(dBi)			
	WLAN 2.4GHz	WLAN 5GHz	Bluetooth	Thread
1	-	5.89	-	-
2	-	5.36	-	-
3	-	5.67	-	-
4	-	5.36	-	-
5	3.48	4.57	-	-
6	3.80	4.40	-	-
7	3.84	4.98	-	-
8	3.90	5.18	-	-
9	-	-	4.40	4.40

Note2: The above information was declared by manufacturer.

Note3:

For 2.4GHz function:

For IEEE 802.11b/g/n/ax mode (1TX, 2TX, 4TX/4RX):

For 1TX

Only Port 1 can be use as transmitting antenna.

For 2TX

Port 1 and Port 2 can be use as transmitting antenna.

Port 1 and Port 2 could transmit simultaneously.

For 4TX

Port 1, Port 2, Port 3 and Port 4 can be use as transmitting antenna.

Port 1, Port 2, Port 3 and Port 4 could transmit simultaneously.

For 4RX

Port 1, Port 2, Port 3 and Port 4 can be used as receiving antennas.

Port 1, Port 2, Port 3 and Port 4 could receive simultaneously.



For 5GHz function:

For IEEE 802.11a/n/ac/ax mode (1TX, 2TX, 4TX/4RX):

For 1TX

Only Port 1 can be use as transmitting antenna.

For 2TX

Port 1 and Port 2 can be use as transmitting antenna.

Port 1 and Port 2 could transmit simultaneously.

For 4TX

Port 1, Port 2, Port 3 and Port 4 can be use as transmitting antenna.

Port 1, Port 2, Port 3 and Port 4 could transmit simultaneously.

For 4RX

Port 1, Port 2, Port 3 and Port 4 can be used as receiving antennas.

Port 1, Port 2, Port 3 and Port 4 could receive simultaneously.

For Bluetooth and Thread mode (1TX/1RX):

Only Port 1 can be use as transmitting/receiving antenna.

1.1.3 EUT Operational Condition

EUT Power Type	From PoE	
Function	<input checked="" type="checkbox"/> Point-to-multipoint	<input type="checkbox"/> Point-to-point
Test Software Version	Telnet	
Support Mode	<input checked="" type="checkbox"/>	LE 1M PHY: 1 Mb/s
	<input type="checkbox"/>	LE Coded PHY (S=2): 500 Kb/s
	<input type="checkbox"/>	LE Coded PHY (S=8): 125 Kb/s
	<input type="checkbox"/>	LE 2M PHY: 2 Mb/s

Note: The above information was declared by manufacturer.



1.1.4 Table for Class II Change

This product is an extension of original one reported under Sporton project number: FR8O1739-01AA

Below is the table for the change of the product with respect to the original one.

Modifications	Performance Checking
Adding a model name: AP560i Based on above modification. 1. Adding the outdoor function. 2. Changing the EUT case. 3. Removing USB Port. 4. Power Supply: From PoE only.	1. AC power-line conducted emissions 2. Emissions in Restricted Frequency Bands Note: For Emissions in Restricted Frequency Bands above 1GHz: After evaluating, the test mode was based on test mode of original maximum output power to retest. Please refer to test result for detail test mode.

1.1.5 Table for Multiple Listing

The EUT has three radios, the information as following table:

Radio	Function		
	WLAN 2.4GHz	WLAN 5GHz	Bluetooth/Thread
1	V	V	-
2	-	V	-
3	-	-	V

1.1.6 Table for EUT support function

Function	Support Type	Support Band
AP	Master	WLAN 2.4GHz/Bluetooth/Thread/WLAN 5GHz Band 1~4
Client	Slave without Radar Detection (Sensor Mode)	WLAN 2.4GHz/Bluetooth/Thread/WLAN 5GHz Band 1+4
Bridge	Master	WLAN 2.4GHz/Bluetooth/Thread/WLAN 5GHz Band 1+4
Mesh	Master	WLAN 2.4GHz/Bluetooth/Thread/WLAN 5GHz Band 1+4

Note: The above information was declared by manufacturer.



1.2 Testing Applied Standards

According to the specifications of the manufacturer, the EUT must comply with the requirements of the following standards:

- ♦ 47 CFR FCC Part 15
- ♦ ANSI C63.10-2013
- ♦ FCC KDB 558074 D01 v05

1.3 Testing Location Information

Testing Location		
<input type="checkbox"/>	HWA YA	ADD : No. 52, Huaya 1st Rd., Guishan Dist., Taoyuan City, Taiwan (R.O.C.) TEL : 886-3-327-3456 FAX : 886-3-327-0973
<input checked="" type="checkbox"/>	JHUBEI	ADD : No.8, Lane 724, Bo-ai St., Jhubei City, HsinChu County 302, Taiwan, R.O.C. TEL : 886-3-656-9065 FAX : 886-3-656-9085

Test Condition	Test Site No.	Test Engineer	Test Environment	Test Date
Radiated (Below 1GHz)	03CH01-CB	KJ Chang	22~25°C / 54~61%	Feb. 19, 2019 ~ Feb. 20, 2019
Radiated (Above 1GHz)	03CH01-CB	Stim Sung	22~25°C / 51~66%	Feb. 20, 2019 ~ Mar. 13, 2019
AC Conduction	CO02-CB	Peter Wu	23.6~23.8°C / 61~62.3%	Feb. 22, 2019

Test site Designation No. TW0006 with FCC.
Test site registered number IC 4086B with Industry Canada.

1.4 Measurement Uncertainty

ISO/IEC 17025 requires that an estimate of the measurement uncertainties associated with the emissions test results be included in the report. The measurement uncertainties given below are based on a 95% confidence level (based on a coverage factor (k=2))

Test Items	Uncertainty	Remark
Conducted Emission (150kHz ~ 30MHz)	2.0 dB	Confidence levels of 95%
Radiated Emission (30MHz ~ 1,000MHz)	3.6 dB	Confidence levels of 95%
Radiated Emission (1GHz ~ 18GHz)	3.7 dB	Confidence levels of 95%
Radiated Emission (18GHz ~ 40GHz)	3.5 dB	Confidence levels of 95%



2 Test Configuration of EUT

2.1 Test Channel Mode

For Radiated Emission:

Mode	PowerSetting
BT-LE(1Mbps)	-
2440MHz	Default

2.2 The Worst Case Measurement Configuration

The Worst Case Mode for Following Conformance Tests									
Tests Item	AC power-line conducted emissions								
Condition	AC power-line conducted measurement for line and neutral								
Operating Mode	Normal Link								
	Radio 1 with 2.4GHz function	Radio 1 with 5GHz function	Radio 2 with 5GHz function	Radio 3 with Bluetooth	Radio 3 with Thread	EUT GE1	EUT GE2	PoE connect with EUT GE1	PoE connect with EUT GE2
1	●	-	●	●	-	●	●	●	-
2	-	●	●	●	-	●	●	●	-
3	●	-	●	-	●	●	●	●	-
4	-	●	●	-	●	●	●	●	-
Mode 3 has been evaluated to be the worst case among Mode 1~4, thus measurement for Mode 5 will follow this same test mode.									
5	●	-	●	-	●	●	●	-	●
Mode 3 generated the worst test result, so it was recorded in this report.									



The Worst Case Mode for Following Conformance Tests											
Tests Item	Emissions in Restricted Frequency Bands										
Test Condition	Radiated measurement If EUT consist of multiple antenna assembly (multiple antenna are used in EUT regardless of spatial multiplexing MIMO configuration), the radiated test should be performed with highest antenna gain of each antenna type.										
Operating Mode < 1GHz	Normal Link										
	EUT at Z-axis	EUT at Y-axis	Radio 1 with 2.4GHz function	Radio 1 with 5GHz function	Radio 2 with 5GHz function	Radio 3 with Bluetooth	Radio 3 with Thread	EUT GE1	EUT GE2	PoE connect with EUT GE1	PoE connect with EUT GE2
1	●	-	●	-	●	●	-	●	●	●	-
2	-	●	●	-	●	●	-	●	●	●	-
Mode 1 has been evaluated to be the worst case between Mode 1~2, thus measurement for Mode 3 ~ 5 will follow this same test mode.											
3	●	-	-	●	●	●	-	●	●	●	-
4	●	-	●	-	●	-	●	●	●	●	-
5	●	-	-	●	●	-	●	●	●	●	-
Mode 4 has been evaluated to be the worst case among Mode 1~5, thus measurement for Mode 6 will follow this same test mode.											
6	●	-	●	-	●	-	●	●	●	-	●
Mode 6 generated the worst test result, so it was recorded in this report.											
Operating Mode > 1GHz	CTX										
The EUT was performed at Y axis and Z axis position and the worst case was found at Y axis. So the measurement will follow this same test configuration.											
1	EUT in Y axis										



The Worst Case Mode for Following Conformance Tests	
Tests Item	Simultaneous Transmission Analysis - Co-location RF Exposure Evaluation
Operating Mode	
1	WLAN 2.4GHz (Radio 1) + WLAN 5GHz (Radio 2) + Bluetooth (Radio 3)
2	WLAN 5GHz (Radio 1) + WLAN 5GHz (Radio 2) + Bluetooth (Radio 3)
3	WLAN 2.4GHz (Radio 1) + WLAN 5GHz (Radio 2) + Thread (Radio 3)
4	WLAN 5GHz (Radio 1) + WLAN 5GHz (Radio 2) + Thread (Radio 3)

Refer to Sporton Test Report No.: FA8O1739-07 for Co-location RF Exposure Evaluation.

Note: 1.The PoE is for measurement only, would not be marketed.

PoE information as below:

Power	Brand	Model
PoE	Microsemi	PD-9001GR/AT/AC

2.3 EUT Operation during Test

For Normal Link:

During the test, the EUT operation to normal function.

For CTX Mode:

The EUT was programmed to be in continuously transmitting mode.

2.4 Accessories

N/A



2.5 Support Equipment

For AC power-line conducted emissions test:

Support Equipment				
No.	Equipment	Brand Name	Model Name	FCC ID
A	PoE	Microsemi	PD-9001GR/AT/AC	N/A
B	GE1 PC	DELL	T3400	N/A
C	GE2 NB	DELL	E6430	N/A
D	WLAN2.4G NB	DELL	E6430	N/A
E	WLAN5G NB	DELL	E6430	N/A
F	802.11ax Access Point (Device)	Extreme Networks	AP505i	QXO-AP505I
G	Device NB	DELL	E6430	N/A

For Radiated Below 1GHz test:

Support Equipment				
No.	Equipment	Brand Name	Model Name	FCC ID
A	GE1 PC	ASUS	N/A	N/A
B	GE2 NB	DELL	E4300	N/A
C	WLAN2.4G NB	DELL	E4300	N/A
D	WLAN5G NB	DELL	E4300	N/A
E	802.11ax Access Point (Device)	Extreme Networks	AP505i	QXO-AP505I
F	Device NB	DELL	E4300	N/A
G	PoE	Microsemi	PD-9001GR/AT/AC	N/A

For Radiated Above 1GHz test:

Support Equipment				
No.	Equipment	Brand Name	Model Name	FCC ID
A	Notebook	DELL	E4300	N/A
E	PoE	Microsemi	PD-9001GR/AT/AC	N/A

2.6 Test Setup Diagram

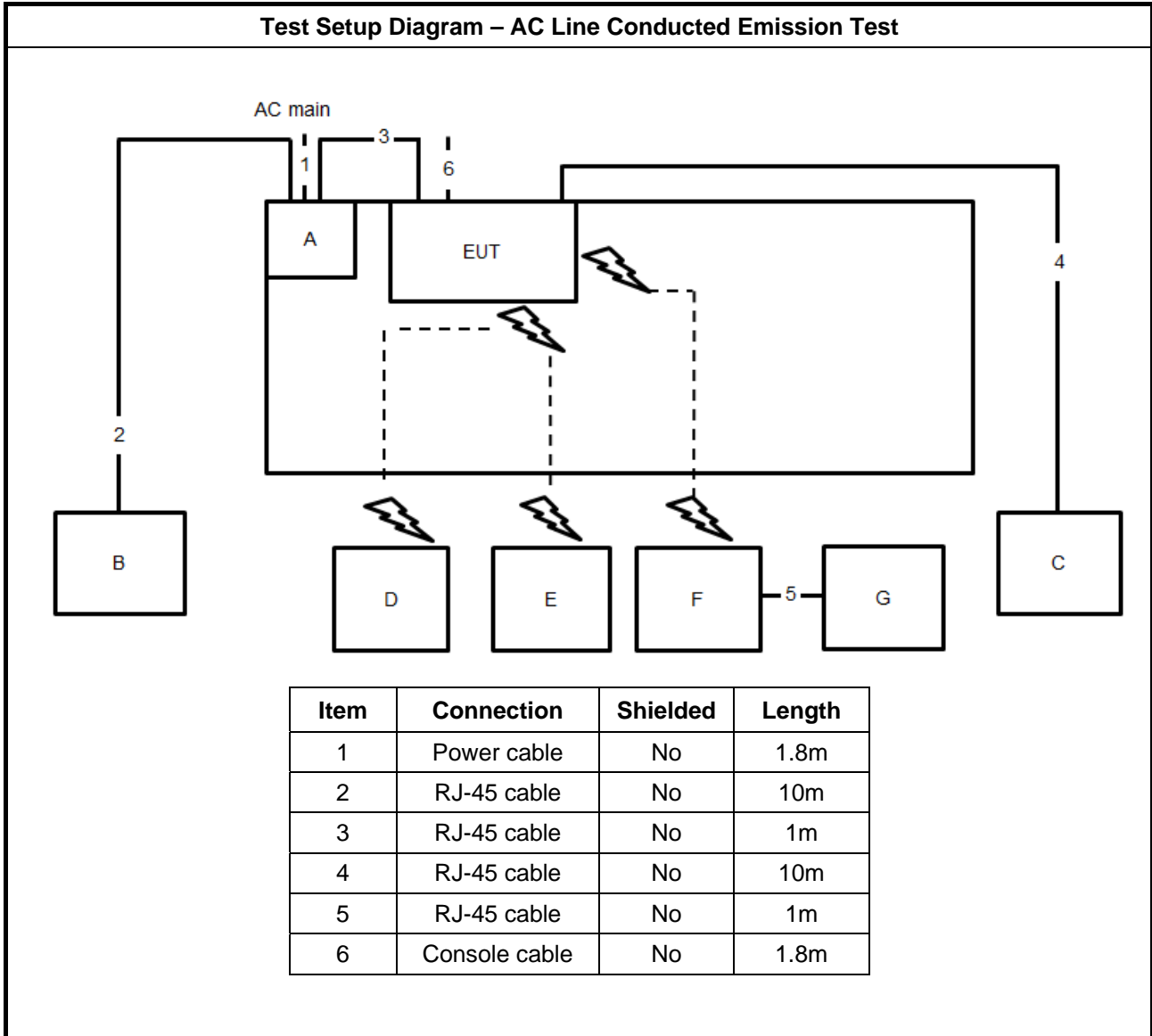



Test Setup Diagram - Radiated Test < 1GHz

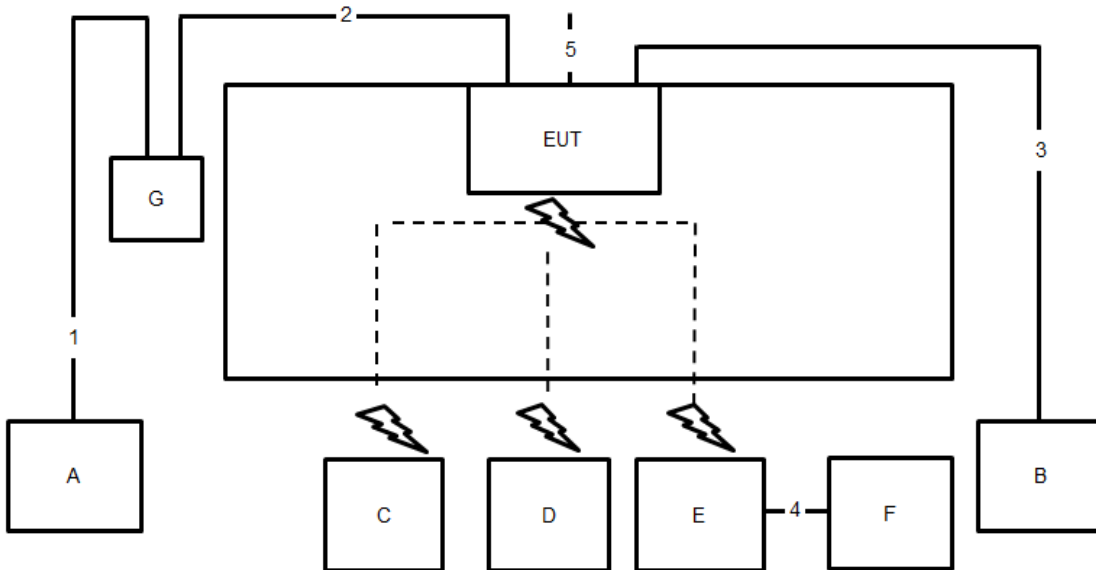

Item	Connection	Shielded	Length
1	RJ-45 cable	No	1.5m
2	RJ-45 cable	No	10m
3	RJ-45 cable	No	10m
4	RJ-45 cable	No	10m
5	Console cable	No	1.5m



Test Setup Diagram - Radiated Test > 1GHz

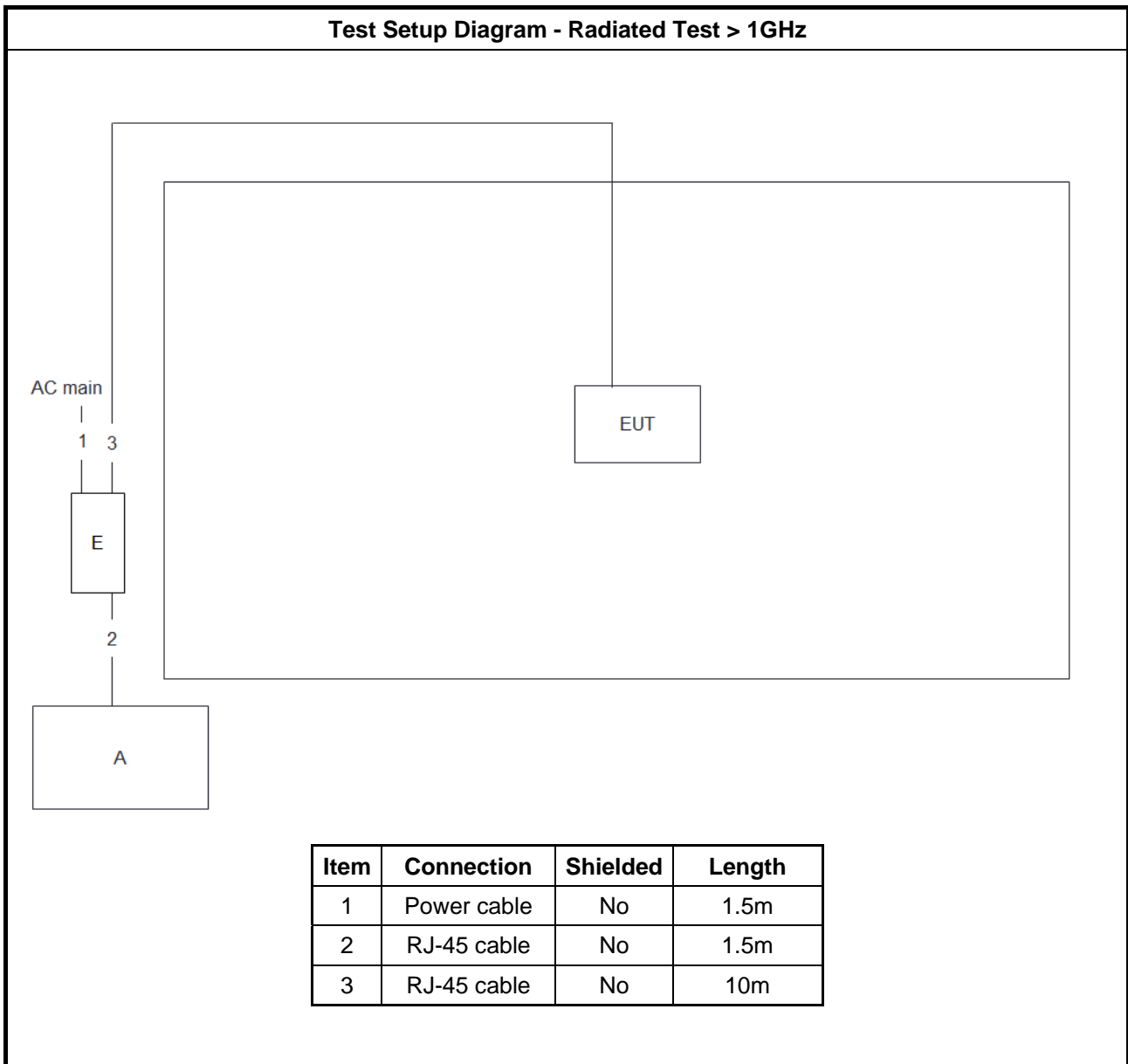

Item	Connection	Shielded	Length
1	Power cable	No	1.5m
2	RJ-45 cable	No	1.5m
3	RJ-45 cable	No	10m



3 Transmitter Test Result

3.1 AC Power-line Conducted Emissions

3.1.1 AC Power-line Conducted Emissions Limit

AC Power-line Conducted Emissions Limit		
Frequency Emission (MHz)	Quasi-Peak	Average
0.15-0.5	66 - 56 *	56 - 46 *
0.5-5	56	46
5-30	60	50

Note 1: * Decreases with the logarithm of the frequency.

3.1.2 Measuring Instruments

Refer a test equipment and calibration data table in this test report.

3.1.3 Test Procedures

Test Method
▪ Refer as ANSI C63.10-2013, clause 6.2 for AC power-line conducted emissions.

3.1.4 Test Setup

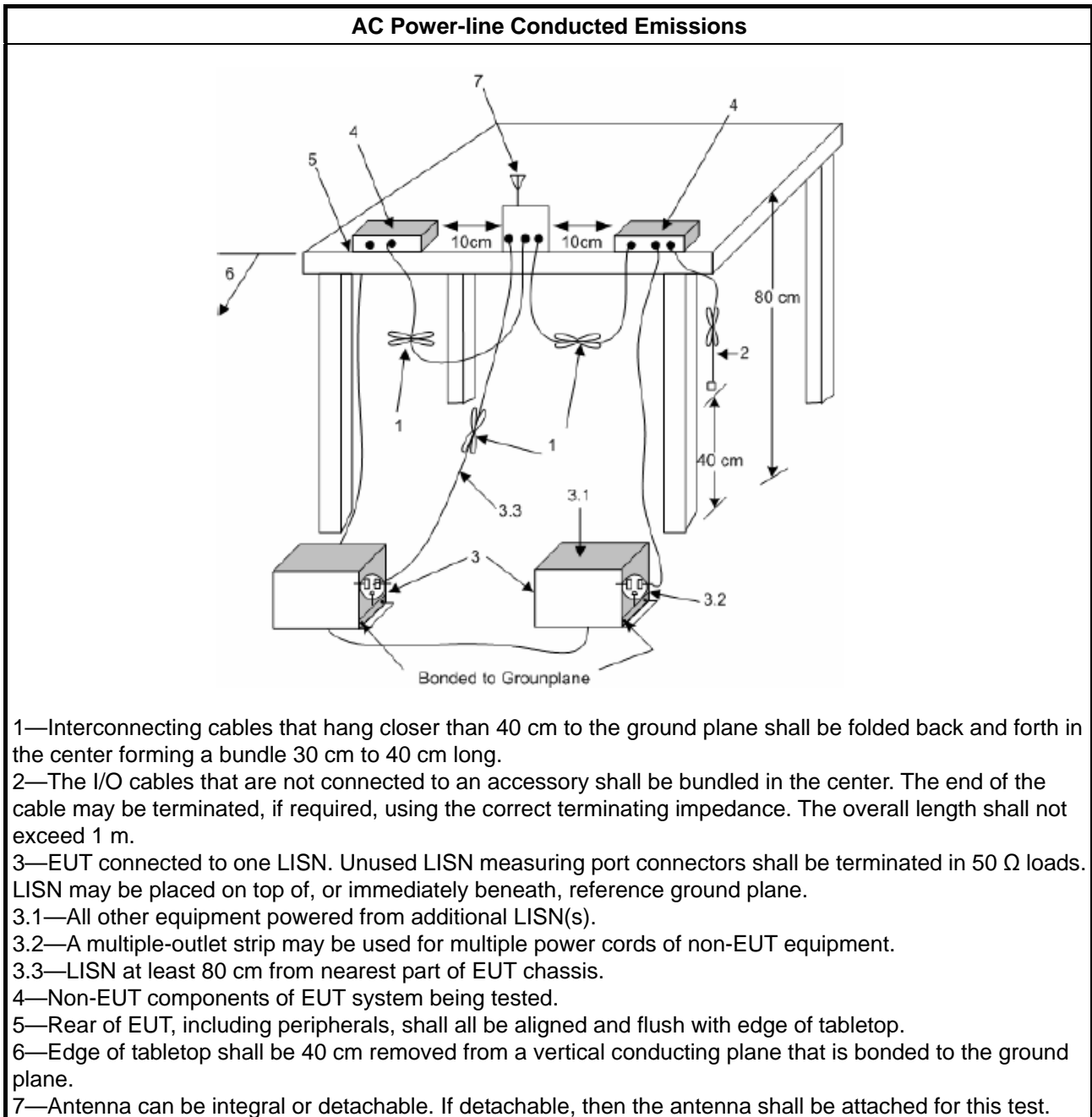

3.1.5 Test Result of AC Power-line Conducted Emissions

Refer as Appendix A



3.2 Emissions in Restricted Frequency Bands

3.2.1 Emissions in Restricted Frequency Bands Limit

Restricted Band Emissions Limit			
Frequency Range (MHz)	Field Strength (uV/m)	Field Strength (dBuV/m)	Measure Distance (m)
0.009~0.490	2400/F(kHz)	48.5 - 13.8	300
0.490~1.705	24000/F(kHz)	33.8 - 23	30
1.705~30.0	30	29	30
30~88	100	40	3
88~216	150	43.5	3
216~960	200	46	3
Above 960	500	54	3

Note 1: Test distance for frequencies at or above 30 MHz, measurements may be performed at a distance other than the limit distance provided they are not performed in the near field and the emissions to be measured can be detected by the measurement equipment. When performing measurements at a distance other than that specified, the results shall be extrapolated to the specified distance using an extrapolation factor of 20 dB/decade (inverse of linear distance for field-strength measurements, inverse of linear distance-squared for power-density measurements).

Note 2: Test distance for frequencies at below 30 MHz, measurements may be performed at a distance closer than the EUT limit distance; however, an attempt should be made to avoid making measurements in the near field. When performing measurements below 30 MHz at a closer distance than the limit distance, the results shall be extrapolated to the specified distance by either making measurements at a minimum of two or more distances on at least one radial to determine the proper extrapolation factor or by using the square of an inverse linear distance extrapolation factor (40 dB / decade). The test report shall specify the extrapolation method used to determine compliance of the EUT.

Note 3: Using the distance of 1m during the test for above 18 GHz, and the test value to correct for the distance factor at 3m.

3.2.2 Measuring Instruments

Refer a test equipment and calibration data table in this test report.



3.2.3 Test Procedures

Test Method	
<ul style="list-style-type: none"> The average emission levels shall be measured in [duty cycle \geq 98 or duty factor]. 	
<ul style="list-style-type: none"> Refer as ANSI C63.10, clause 6.10.3 band-edge testing shall be performed at the lowest frequency channel and highest frequency channel within the allowed operating band. 	
<ul style="list-style-type: none"> For the transmitter unwanted emissions shall be measured using following options below: <ul style="list-style-type: none"> Refer as FCC KDB 558074, clause 8.6 for unwanted emissions into restricted bands. <ul style="list-style-type: none"> <input type="checkbox"/> Refer as FCC KDB 558074, clause 8.6 & C63.10 clause 11.12.2.5.1(trace averaging for duty cycle \geq98%). <input type="checkbox"/> Refer as FCC KDB 558074, clause 8.6 & C63.10 clause 11.12.2.5.2(trace averaging + duty factor). <input checked="" type="checkbox"/> Refer as FCC KDB 558074, clause 8.6 & C63.10 clause 11.12.2.5.3(Reduced VBW\geq1/T). <input type="checkbox"/> Refer as ANSI C63.10, clause 11.12.2.5.3 (Reduced VBW). VBW \geq 1/T, where T is pulse time. <input type="checkbox"/> Refer as ANSI C63.10, clause 7.5 average value of pulsed emissions. <input checked="" type="checkbox"/> Refer as FCC KDB 558074, clause 8.6 & C63.10 clause 11.12.2.4 measurement procedure peak limit. 	
<ul style="list-style-type: none"> For the transmitter band-edge emissions shall be measured using following options below: <ul style="list-style-type: none"> Refer as FCC KDB 558074 clause 8.7 & c63.10 clause 11.13.1, When the performing peak or average radiated measurements, emissions within 2 MHz of the authorized band edge may be measured using the marker-delta method described below. Refer as FCC KDB 558074, clause 8.7 (ANSI C63.10, clause 6.10.6) for marker-delta method for band-edge measurements. Refer as FCC KDB 558074, clause 8.7 for narrower resolution bandwidth (100kHz) using the band power and summing the spectral levels (i.e., 1 MHz). 	
<ul style="list-style-type: none"> For conducted unwanted emissions into restricted bands (absolute emission limits). Devices with multiple transmit chains using options given below: <ol style="list-style-type: none"> Measure and sum the spectra across the outputs or Measure and add 10 log(N) dB For FCC KDB 662911 The methodology described here may overestimate array gain, thereby resulting in apparent failures to satisfy the out-of-band limits even if the device is actually compliant. In such cases, compliance may be demonstrated by performing radiated tests around the frequencies at which the apparent failures occurred. 	

3.2.4 Test Setup

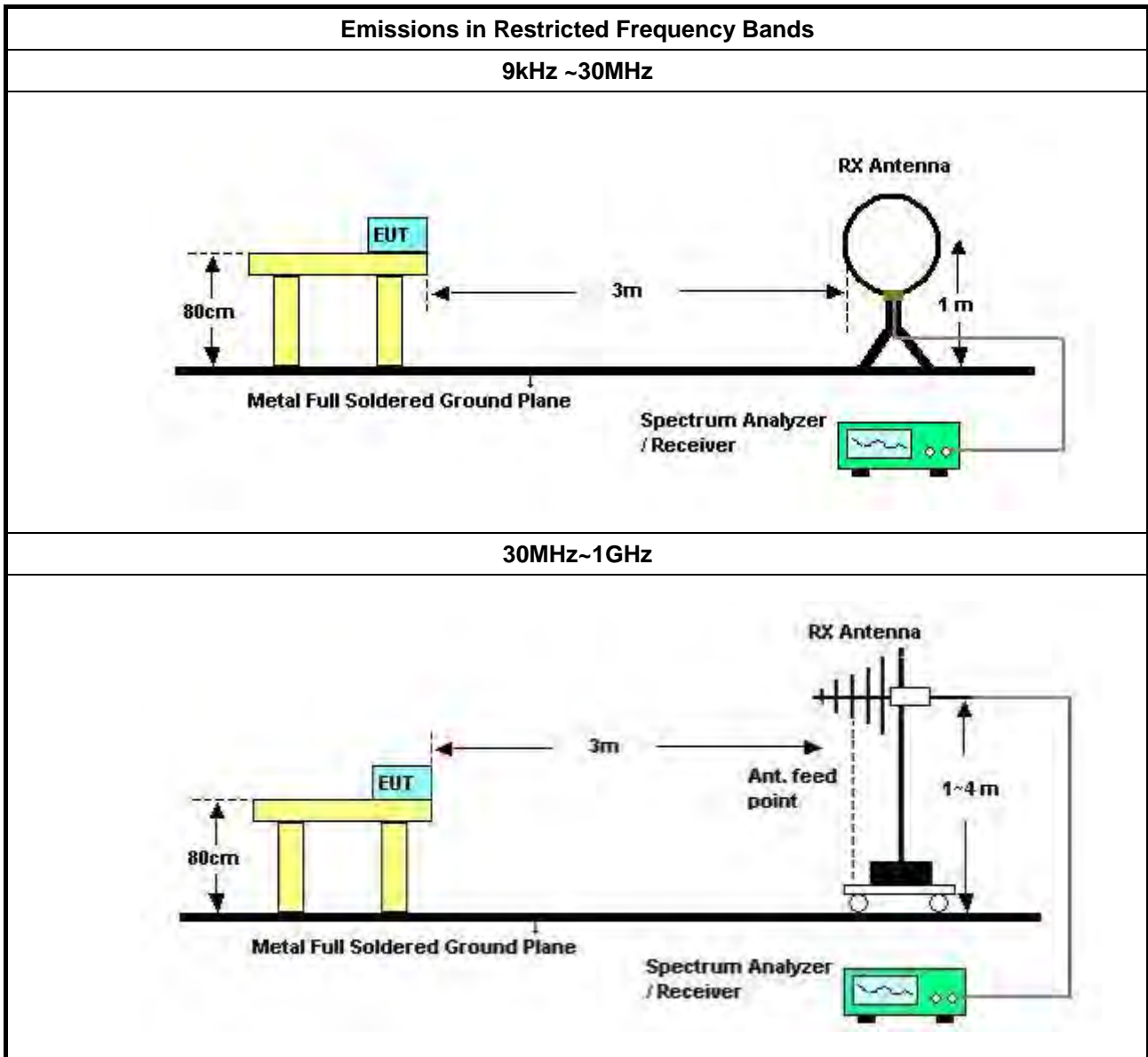

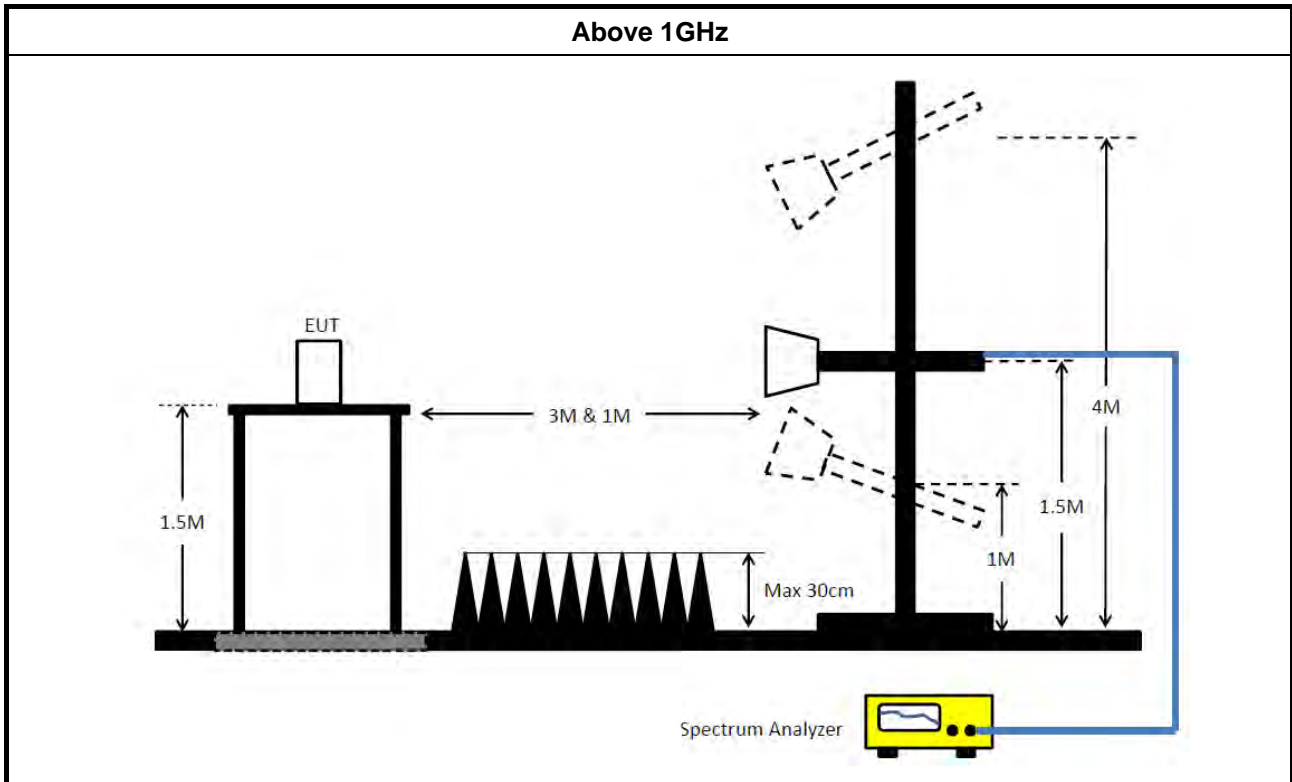

3.2.5 Emissions in Restricted Frequency Bands (Below 30MHz)

All amplitude of spurious emissions that are attenuated by more than 20 dB below the permissible value has no need to be reported.

The radiated emissions were investigated from 9 kHz or the lowest frequency generated within the device, up to the 10 harmonic or 40 GHz, whichever is appropriate.

3.2.6 Test Result of Emissions in Restricted Frequency Bands

Refer as Appendix B



4 Test Equipment and Calibration Data

Instrument	Manufacturer	Model No.	Serial No.	Characteristics	Calibration Date	Calibration Due Date	Remark
LISN	Schwarzbeck	NSLK 8127	8127650	9kHz ~ 30MHz	Nov. 21, 2018	Nov. 20, 2019	Conduction (CO02-CB)
LISN	Schwarzbeck	NSLK 8127	8127478	9kHz ~ 30MHz	Nov. 05, 2018	Nov. 04, 2019	Conduction (CO02-CB)
EMI Receiver	Agilent	N9038A	MY52260140	9kHz ~ 8.4GHz	Jan. 16, 2019	Jan. 15, 2020	Conduction (CO02-CB)
COND Cable	Woken	Cable	2	0.15MHz ~ 30MHz	Nov. 06, 2018	Nov. 05, 2019	Conduction (CO02-CB)
Software	Audix	E3	6.120210n	-	N.C.R.	N.C.R.	Conduction (CO02-CB)
BILOG ANTENNA with 6dB Attenuator	TESEQ & EMCI	CBL6112D & N-6-06	37880 & AT-N0609	20MHz ~ 2GHz	Aug. 27, 2018	Aug. 26, 2019	Radiation (03CH01-CB)
Loop Antenna	Teseq	HLA 6120	24155	9kHz - 30 MHz	Mar. 16, 2018	Mar. 15, 2019	Radiation (03CH01-CB)
Pre-Amplifier	EMCI	EMC330N	980332	20MHz ~ 3GHz	May 02, 2018	May 01, 2019	Radiation (03CH01-CB)
Horn Antenna	EMCO	3115	00075790	750MHz ~ 18GHz	Nov. 13, 2018	Nov. 12, 2019	Radiation (03CH01-CB)
Horn Antenna	Schwarzbeck	BBHA 9170	BBHA9170252	15GHz ~ 40GHz	Jun. 28, 2018	Jun. 27, 2019	Radiation (03CH01-CB)
Pre-Amplifier	Agilent	8449B	3008A02310	1GHz ~ 26.5GHz	Jan. 08, 2019	Jan. 07, 2020	Radiation (03CH01-CB)
Pre-Amplifier	MITEQ	TTA1840-35-H G	1864479	18GHz ~ 40GHz	Jul. 04, 2018	Jul. 03, 2019	Radiation (03CH01-CB)
Spectrum Analyzer	R&S	FSP40	100056	9kHz ~ 40GHz	Jan. 31, 2019	Jan. 30, 2020	Radiation (03CH01-CB)
EMI Test Receiver	R&S	ESCS	100359	9kHz ~ 2.75GHz	Jul. 03, 2018	Jul. 02, 2019	Radiation (03CH01-CB)
RF Cable-low	Woken	Low Cable-16+17	N/A	30 MHz ~ 1 GHz	Oct. 08, 2018	Oct. 07, 2019	Radiation (03CH01-CB)
RF Cable-high	Woken	High Cable-16	N/A	1 GHz ~ 18 GHz	Oct. 08, 2018	Oct. 07, 2019	Radiation (03CH01-CB)
RF Cable-high	Woken	High Cable-16+17	N/A	1 GHz ~ 18 GHz	Oct. 08, 2018	Oct. 07, 2019	Radiation (03CH01-CB)
RF Cable-high	Woken	High Cable-40G#1	N/A	18GHz ~ 40 GHz	Jul. 27, 2018	Jul. 26, 2019	Radiation (03CH01-CB)
RF Cable-high	Woken	High Cable-40G#2	N/A	18GHz ~ 40 GHz	Jul. 27, 2018	Jul. 26, 2019	Radiation (03CH01-CB)

Note: Calibration Interval of instruments listed above is one year.

N.C.R. means Non-Calibration required.



AC Power Port Conducted Emission Result

Appendix A

Test Mode	Mode 3	Frequency Range	0.15 MHz to 30 MHz
------------------	--------	------------------------	--------------------

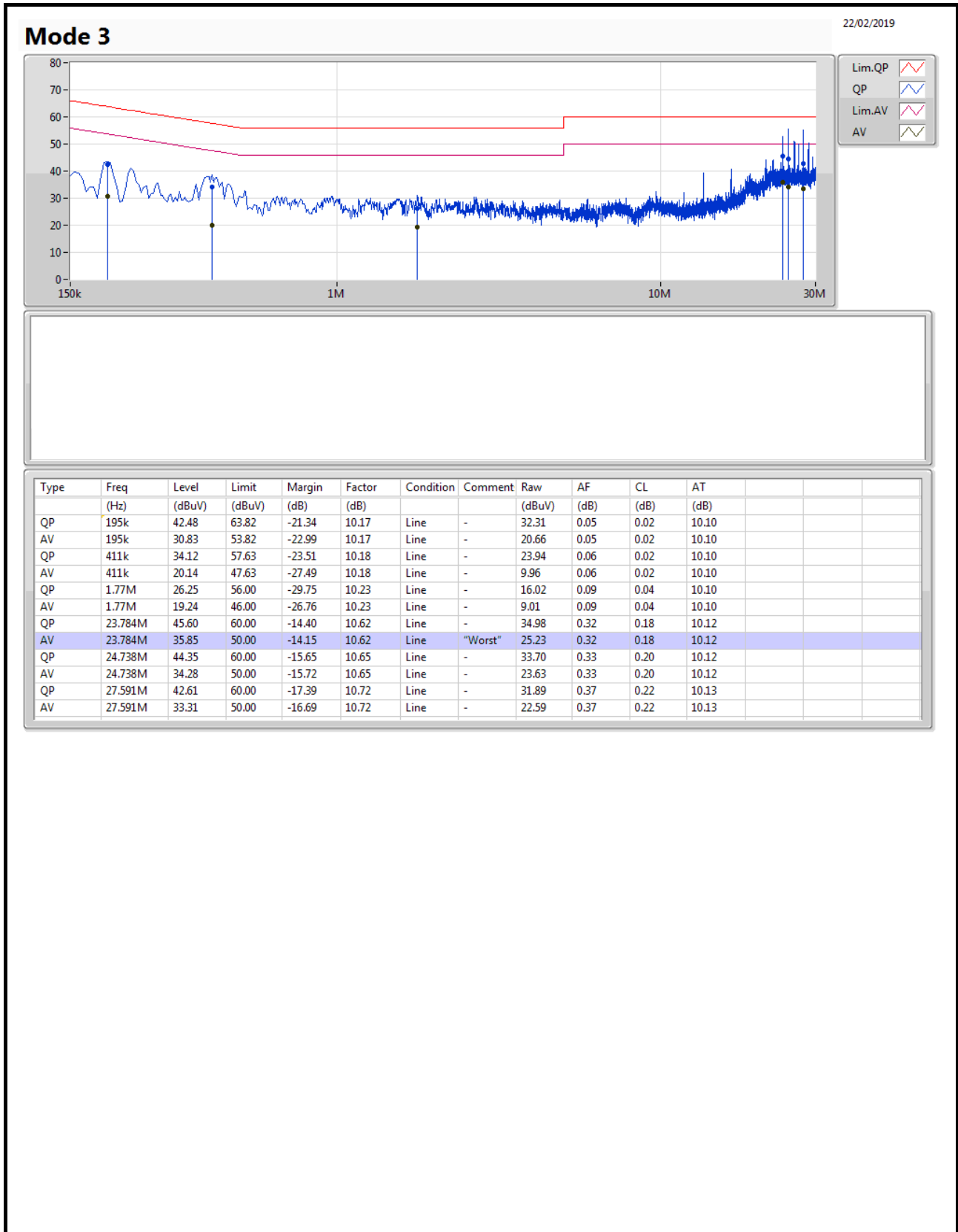

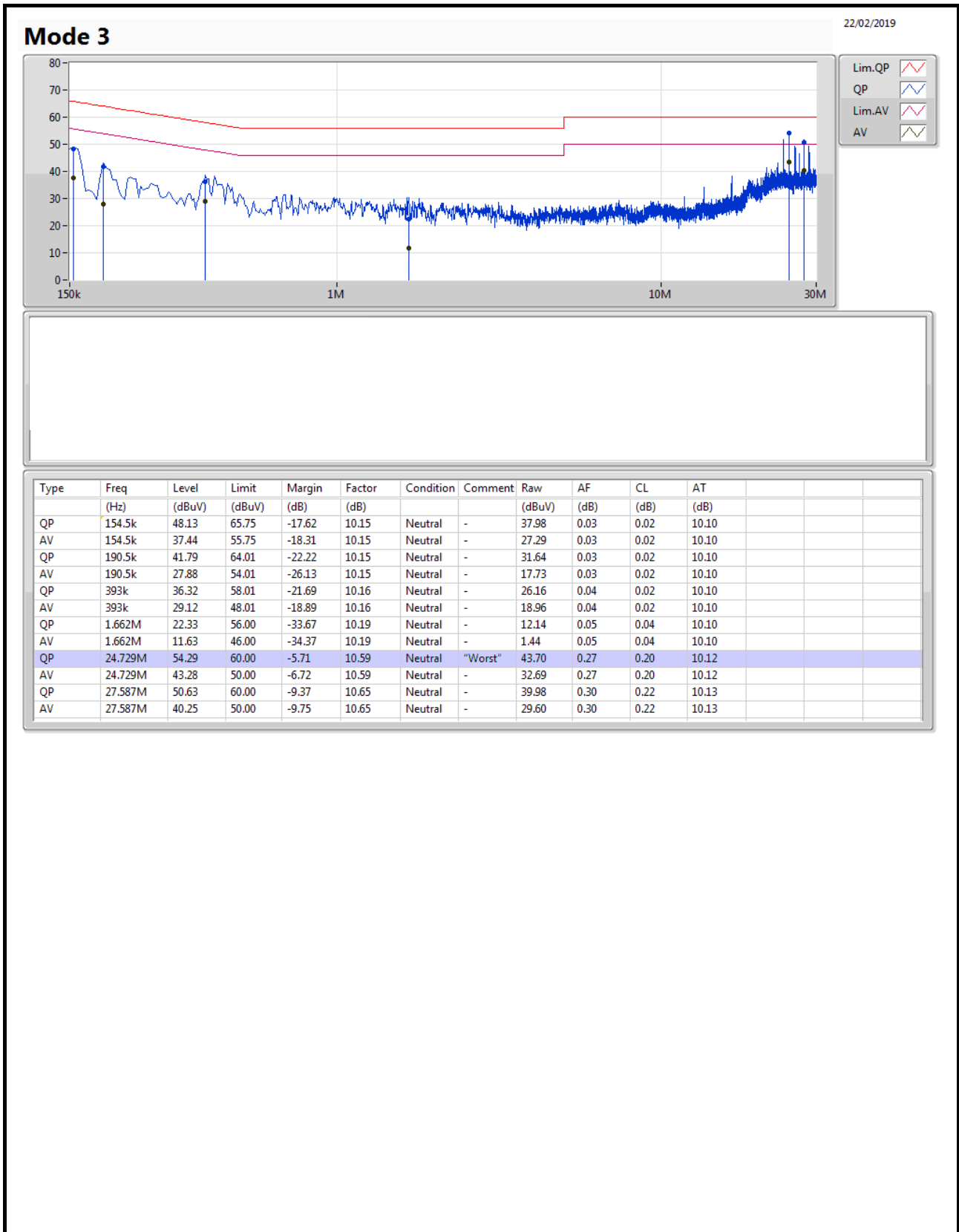



Radiated Emission below 1GHz Result

Appendix B.1

Test Mode	Mode 6	Frequency Range	30 MHz to 1,000 MHz
------------------	--------	------------------------	---------------------

Vertical 30 MHz to 1,000 MHz

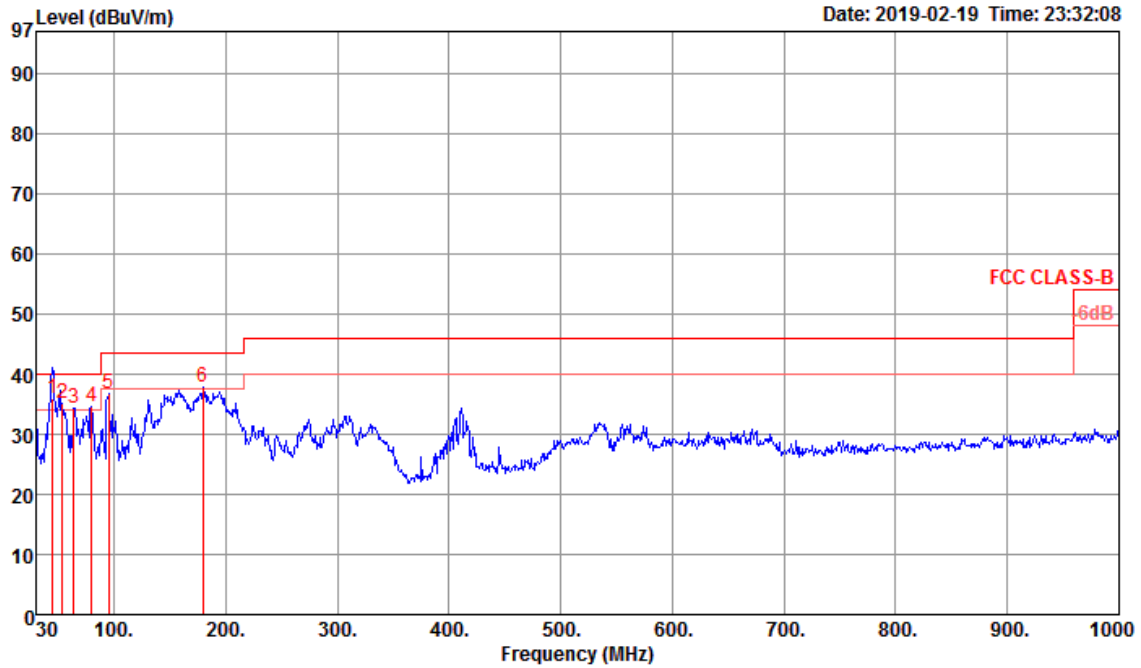

	Freq	Level	Limit	Over	Read	CableAntenna	Preamp	A/Pos	T/Pos	Remark	Pol/Phase
	MHz	dBuV/m	dBuV/m	dB	dBuV	dB	dB/m	dB	cm	deg	
1	44.55	35.97	40.00	-4.03	49.16	0.85	17.54	31.58	125	287 QP	VERTICAL
2	53.28	35.12	40.00	-4.88	52.06	0.97	13.70	31.61	300	360 Peak	VERTICAL
3	63.95	34.36	40.00	-5.64	52.53	0.99	12.50	31.66	300	360 Peak	VERTICAL
4	79.47	34.62	40.00	-5.38	51.60	1.13	13.60	31.71	300	360 Peak	VERTICAL
5	94.99	36.81	43.50	-6.69	50.99	1.23	16.30	31.71	300	360 Peak	VERTICAL
6	179.38	37.83	43.50	-5.67	52.38	1.67	15.55	31.77	300	360 Peak	VERTICAL



Horizontal 30 MHz to 1,000 MHz

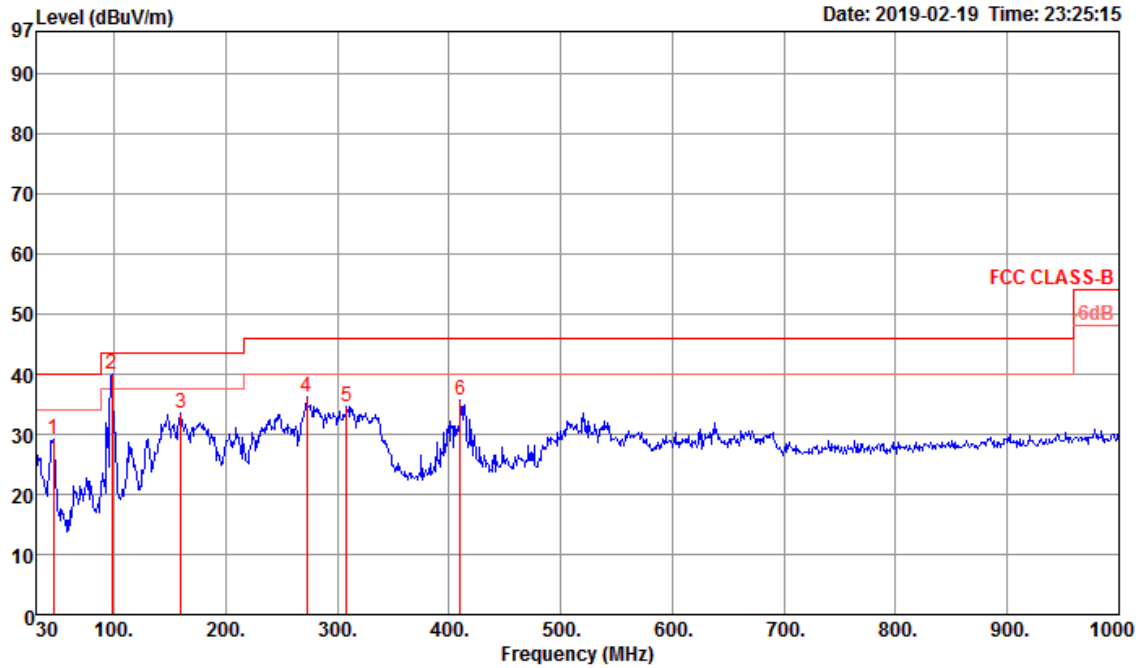

	Freq	Level	Limit Line	Over Limit	Read Level	CableAntenna Loss	Preamp Factor	A/Pos	T/Pos	Remark	Pol/Phase
	MHz	dBuV/m	dBuV/m	dB	dBuV	dB	dB/m	dB	cm	deg	
1	45.52	29.12	40.00	-10.88	42.89	0.86	16.95	31.58	100	0 Peak	HORIZONTAL
2	97.90	40.05	43.50	-3.45	53.69	1.23	16.83	31.70	100	0 Peak	HORIZONTAL
3	159.98	33.50	43.50	-10.00	47.06	1.60	16.60	31.76	100	0 Peak	HORIZONTAL
4	272.50	36.17	46.00	-9.83	46.60	2.02	19.36	31.81	100	0 Peak	HORIZONTAL
5	308.39	34.59	46.00	-11.41	44.51	2.15	19.78	31.85	100	0 Peak	HORIZONTAL
6	410.24	35.71	46.00	-10.29	42.25	2.52	22.90	31.96	100	0 Peak	HORIZONTAL



Summary

Mode	Result	Type	Freq (Hz)	Level (dBuV/m)	Limit (dBuV/m)	Margin (dB)	Factor (dB)	Dist (m)	Condition	Azimuth (°)	Height (m)	Comments
2.4-2.4835GHz	-	-	-	-	-	-	-	-	-	-	-	-
BT-LE(1Mbps)	Pass	AV	2.4848G	45.43	54.00	-8.57	32.42	3	Horizontal	54	1.80	-



BT-LE(1Mbps)

20/02/2019

2440MHz_TX

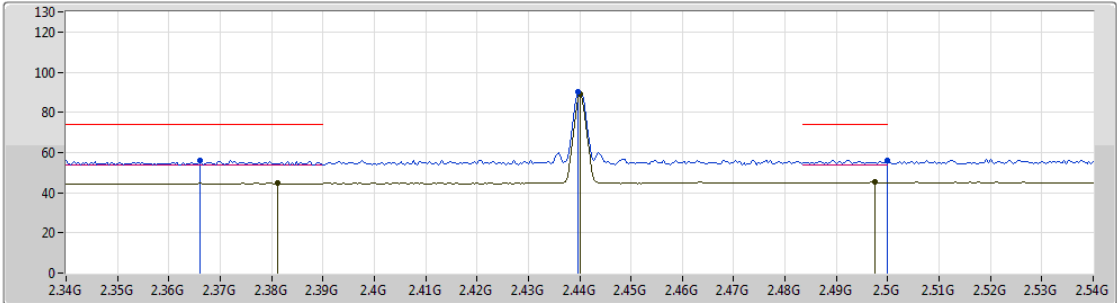

Lim.PK
 PK
 Lim.AV
 AV

EUT_Y_1TX
 Setting Default
 06-S-5
 FSP(100080)

Type	Freq (Hz)	Level (dBuV/m)	Limit (dBuV/m)	Margin (dB)	Factor (dB)	Dist (m)	Condition	Azimuth (°)	Height (m)	Comments
PK	2.366G	56.25	74.00	-17.75	32.04	3	Vertical	24	2.89	-
AV	2.3812G	44.87	54.00	-9.13	32.10	3	Vertical	24	2.89	-
PK	2.4396G	90.28	Inf	-Inf	32.28	3	Vertical	24	2.89	-
AV	2.44G	88.92	Inf	-Inf	32.28	3	Vertical	24	2.89	-
PK	2.5G	56.27	74.00	-17.73	32.46	3	Vertical	24	2.89	-
AV	2.4976G	45.19	54.00	-8.81	32.45	3	Vertical	24	2.89	-

BT-LE(1Mbps)

2440MHz_TX

20/02/2019

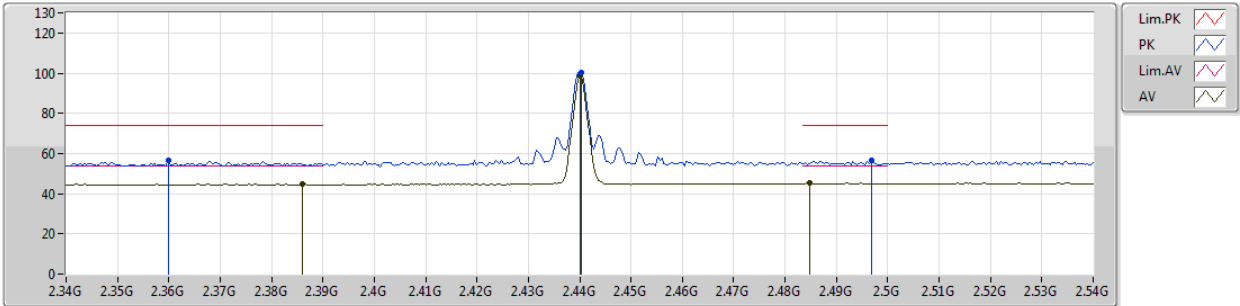

EUT_Y_1TX
Setting Default
06-S-5
FSP(100080)

Type	Freq (Hz)	Level (dBuV/m)	Limit (dBuV/m)	Margin (dB)	Factor (dB)	Dist (m)	Condition	Azimuth (°)	Height (m)	Comments
PK	2.36G	56.52	74.00	-17.48	32.02	3	Horizontal	54	1.80	-
AV	2.386G	44.86	54.00	-9.14	32.11	3	Horizontal	54	1.80	-
PK	2.440G	100.26	Inf	-Inf	32.28	3	Horizontal	54	1.80	-
AV	2.44G	98.88	Inf	-Inf	32.28	3	Horizontal	54	1.80	-
PK	2.496G	56.32	74.00	-17.68	32.45	3	Horizontal	54	1.80	-
AV	2.488G	45.43	54.00	-8.57	32.42	3	Horizontal	54	1.80	-



BT-LE(1Mbps)

20/02/2019

2440MHz_TX

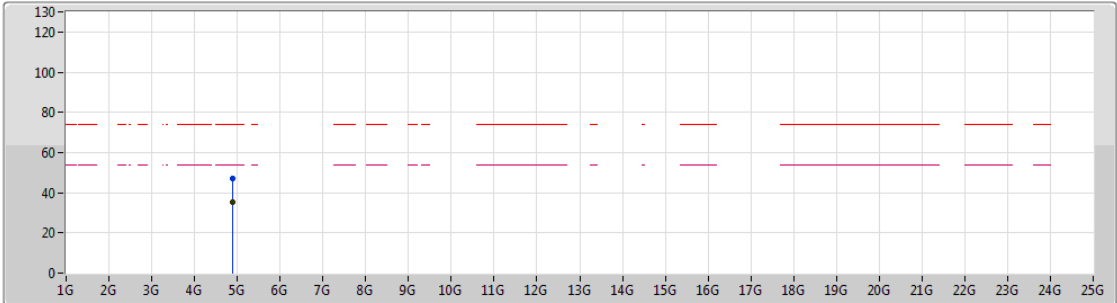

Lim.PK
 PK
 Lim.AV
 AV

EUT Y_1TX
 Setting Default
 06-S-5
 FSP(100080)

Type	Freq (Hz)	Level (dBuV/m)	Limit (dBuV/m)	Margin (dB)	Factor (dB)	Dist (m)	Condition	Azimuth (°)	Height (m)	Comments
PK	4.88182G	47.07	74.00	-26.93	6.72	3	Vertical	3	1.55	-
AV	4.87888G	35.26	54.00	-18.74	6.72	3	Vertical	3	1.55	-



BT-LE(1Mbps)

20/02/2019

2440MHz_TX

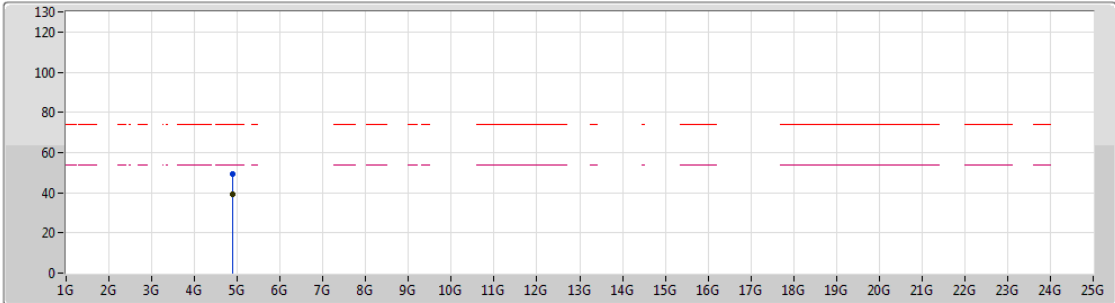

Lim.PK
 PK
 Lim.AV
 AV

EUT_Y_1TX
 Setting Default
 06-S-5
 FSP(100080)

Type	Freq (Hz)	Level (dBuV/m)	Limit (dBuV/m)	Margin (dB)	Factor (dB)	Dist (m)	Condition	Azimuth (°)	Height (m)	Comments
PK	4.88302G	49.04	74.00	-24.96	6.72	3	Horizontal	68	1.53	-
AV	4.88082G	39.17	54.00	-14.83	6.72	3	Horizontal	68	1.53	-