



# RADIO TEST REPORT

**FCC ID** : QXO-AP5010U  
**Equipment** : Access Point  
**Brand Name** : Extreme Networks  
**Model Name** : AP5010U  
**Applicant** : Extreme Networks, Inc.  
2121 RDU Center Drive Morrisville North Carolina  
United States 27560  
**Manufacturer** : Extreme Networks, Inc.  
2121 RDU Center Drive Morrisville North Carolina  
United States 27560  
**Standard** : 47 CFR FCC Part 15.247

The product was received on Dec. 03, 2021, and testing was started from Dec. 11, 2021 and completed on Apr. 28, 2022. We, Sporton International Inc. Hsinchu Laboratory, would like to declare that the tested sample has been evaluated in accordance with the procedures given in ANSI C63.10-2013 and shown compliance with the applicable technical standards.

The test results in this report apply exclusively to the tested model / sample. Without written approval of Sporton International Inc. Hsinchu Laboratory, the test report shall not be reproduced except in full.



Approved by: Sam Chen

**Sporton International Inc. Hsinchu Laboratory**

No.8, Ln. 724, Bo'ai St., Zhubei City, Hsinchu County 302010, Taiwan (R.O.C.)



## Table of Contents

**History of this test report.....3**

**Summary of Test Result.....4**

**1 General Description .....5**

1.1 Information.....5

1.2 Applicable Standards .....11

1.3 Testing Location Information.....11

1.4 Measurement Uncertainty .....11

**2 Test Configuration of EUT .....12**

2.1 Test Channel Mode .....12

2.2 The Worst Case Measurement Configuration.....12

2.3 EUT Operation during Test .....14

2.4 Accessories .....14

2.5 Support Equipment.....15

2.6 Test Setup Diagram .....16

**3 Transmitter Test Result .....19**

3.1 AC Power-line Conducted Emissions .....19

3.2 DTS Bandwidth .....21

3.3 Maximum Conducted Output Power .....22

3.4 Power Spectral Density .....25

3.5 Emissions in Non-restricted Frequency Bands .....27

3.6 Emissions in Restricted Frequency Bands.....28

**4 Test Equipment and Calibration Data .....32**

**Appendix A. Test Results of AC Power-line Conducted Emissions**

**Appendix B. Test Results of DTS Bandwidth**

**Appendix C. Test Results of Maximum Conducted Output Power**

**Appendix D. Test Results of Power Spectral Density**

**Appendix E. Test Results of Emissions in Non-restricted Frequency Bands**

**Appendix F. Test Results of Emissions in Restricted Frequency Bands**

**Appendix G. Test Photos**

**Photographs of EUT v01**





## Summary of Test Result

Report Clause	Ref Std. Clause	Test Items	Result (PASS/FAIL)	Remark
1.1.2	15.203	Antenna Requirement	PASS	-
3.1	15.207	AC Power-line Conducted Emissions	PASS	-
3.2	15.247(a)	DTS Bandwidth	PASS	-
3.3	15.247(b)	Maximum Conducted Output Power	PASS	-
3.4	15.247(e)	Power Spectral Density	PASS	-
3.5	15.247(d)	Emissions in Non-restricted Frequency Bands	PASS	-
3.6	15.247(d)	Emissions in Restricted Frequency Bands	PASS	-

**Declaration of Conformity:**

1. The test results with all measurement uncertainty excluded are presented in accordance with the regulation limits or requirements declared by manufacturers. It's means measurement values may risk exceeding the limit of regulation standards, if measurement uncertainty is include in test results.
2. The measurement uncertainty please refer to report "Measurement Uncertainty".

**Comments and Explanations:**

The declared of product specification for EUT presented in the report are provided by the manufacturer, and the manufacturer takes all the responsibilities for the accuracy of product specification.

**Reviewed by: Sam Chen****Report Producer: Viola Huang**



# 1 General Description

## 1.1 Information

### 1.1.1 RF General Information

Frequency Range (MHz)	Bluetooth Mode	Ch. Frequency (MHz)	Channel Number
2400-2483.5	LE	2402-2480	0-39 [40]

#### For Radio 4

Band	Mode	BWch (MHz)	Nant
2.4-2.4835GHz	BT-LE(1Mbps)	1	1
2.4-2.4835GHz	BT-LE(500Kb/s)	1	1
2.4-2.4835GHz	BT-LE(125Kb/s)	1	1
2.4-2.4835GHz	BT-LE(2Mbps)	2	1

Note:

- ◆ Bluetooth LE uses a GFSK modulation.
- ◆ BWch is the nominal channel bandwidth.



**1.1.2 Antenna Information**

Ant.	Port						Brand Name	Model Name	Antenna Type	Connector	Gain (dBi)
	WLAN 2.4GHz (Radio 1) (Scanning Radio 1)	WLAN 5GHz (Radio 2)	WLAN 6E (Radio 3)	WLAN 5GHz / WLAN 6GHz (Scanning Radio 1)	BT / IEEE802.15.4 (Radio 4)	UWB (Radio 5)					
1	3	3	-	-	-	-	WNC	95XEAJ15.30	PIFA	I-PEX	Note 1
2	1	1	-	-	-	-	WNC	95XEAJ15.31	PIFA	I-PEX	
3	2	2	-	-	-	-	WNC	95XEAJ15.32	PIFA	I-PEX	
4	4	4	-	-	-	-	WNC	95XEAJ15.33	PIFA	I-PEX	
5	-	-	2	-	-	-	WNC	95XEAJ15.34	PIFA	I-PEX	
6	-	-	1	-	-	-	WNC	95XEAJ15.35	PIFA	I-PEX	
7	-	-	4	-	-	-	WNC	95XEAJ15.36	PIFA	I-PEX	
8	-	-	3	-	-	-	WNC	95XEAJ15.37	PIFA	I-PEX	
9	-	-	-	1	-	-	WNC	95XEAJ15.38	PIFA	I-PEX	
10	-	-	-	2	-	-	WNC	95XEAJ15.39	PIFA	I-PEX	
11	-	-	-	-	1	-	WNC	95XEAJ15.40	PIFA	I-PEX	
12	-	-	-	-	-	1	WNC	95XEAJ15.41	PIFA	I-PEX	

Note 1:

Ant.	Antenna Gain (dBi)									
	WLAN 2.4GHz (Radio 1) (Scanning Radio 1)	WLAN 5GHz (Radio 2)				WLAN 6E (Radio 3)	WLAN 5GHz (Scanning Radio 1)	WLAN 6GHz (Scanning Radio 1)	BT / IEEE802.15.4 (Radio 4)	UWB (Radio 5)
		UNII 1	UNII 2A	UNII 2C	UNII 3					
1	2.12	2.98	2.63	2.13	2.48	-	-	-	-	-
2	2.97	2.59	2.78	1.18	1.38	-	-	-	-	-
3	3.07	3.23	3.25	2.01	1.61	-	-	-	-	-
4	2.73	2.52	2.93	1.67	1.64	-	-	-	-	-
5	-	-	-	-	-	5.2	-	-	-	-
6	-	-	-	-	-	5.2	-	-	-	-
7	-	-	-	-	-	5.2	-	-	-	-
8	-	-	-	-	-	5.2	-	-	-	-
9	-	-	-	-	-	-	5.9	6.0	-	-
10	-	-	-	-	-	-	5.9	6.0	-	-
11	-	-	-	-	-	-	-	-	4.2	-
12	-	-	-	-	-	-	-	-	-	4.7



Ant.	Directional Gain (dBi)									
	WLAN 2.4GHz (Radio 1) (Scanning Radio 1)		WLAN 5GHz (Radio 2)							
	2T1S	2T2S	UNII 1		UNII 2A		UNII 2C		UNII 3	
2T1S			2T2S	2T1S	2T2S	2T1S	2T2S	2T1S	2T2S	
2	5.57	2.58	4.98	2.07	4.99	2.08	3.67	0.78	3.86	0.88
3										

Ant.	Directional Gain (dBi)														
	WLAN 2.4GHz (Radio 1) (Scanning Radio 1)			WLAN 5GHz (Radio 2)											
	4T1S	4T2S	4T4S	UNII 1			UNII 2A			UNII 2C			UNII 3		
4T1S				4T2S	4T4S	4T1S	4T2S	4T4S	4T1S	4T2S	4T4S	4T1S	4T2S	4T4S	
1	7.68	4.68	1.72	6.37	3.37	0.60	6.09	3.25	0.35	6.00	3.00	0.08	6.27	3.27	0.29
2															
3															
4															

Note 2: The EUT has twelve antennas.

Note 3: The above information (except gain of Radio 1 2.4GHz, Scanning Radio 1 2.4GHz, Radio 2) was declared by manufacturer.

Note 4: Radio 1 2.4GHz, Scanning Radio 1 2.4GHz, Radio 2: Maximum Directional Gain following KDB662911 D03.

The antenna report is provided in the operational description for this application.

Note 5: Scanning Radio 1 5GHz: Maximum Directional Gain following KDB662911 D01.

Note 6: The EUT doesn't enable the DFS band.

Note 7: Scanning Radio 1 5GHz: Directional gain information.

Type	Maximum Output Power	Power Spectral Density
Non-BF	Directional gain = Max.gain + array gain. For power measurements on IEEE 802.11 devices Array Gain = 0 dB (i.e., no array gain) for N ANT ≤ 4	$DirectionalGain = 10 \cdot \log \left[ \frac{\sum_{j=1}^{N_{ANT}} \left( \sum_{k=1}^{N_{ANT}} g_{j,k} \right)^2}{N_{ANT}} \right]$

Ex.

Directional Gain (NSS1) formula :

$$DirectionalGain = 10 \cdot \log \left[ \frac{\sum_{j=1}^{N_{ANT}} \left( \sum_{k=1}^{N_{ANT}} g_{j,k} \right)^2}{N_{ANT}} \right]$$

$$NSS1(g1,1) = 10^{G1/20} ; NSS1(g1,2) = 10^{G2/20} ; NSS1(g1,2) = 10^{G3/20} ; NSS1(g1,2) = 10^{G4/20}$$

$$g_{j,k} = (NSS1(g1,1) + NSS1(g1,2) + NSS1(g1,3) + NSS1(g1,4))^2$$

$$DG = 10 \log[(NSS1(g1,1) + NSS1(g1,2) + NSS1(g1,3) + NSS1(g1,4))^2 / N_{ANT}] => 10$$

$$\log[(10^{G1/20} + 10^{G2/20} + 10^{G3/20} + 10^{G4/20})^2 / N_{ANT}]$$

Where ;

$$G1 = 5.9 ; G2 = 5.9$$

5 GHz U-NII-1 DG = 8.91 dBi

5 GHz U-NII-2A DG = 8.91 dBi

5 GHz U-NII-2C DG = 8.91 dBi

5 GHz U-NII-3 DG = 8.91 dBi

**For Radio 1****For 2.4GHz:****For IEEE 802.11b/g/n/VHT/ax mode (1TX/4RX):**

Only Port 1 can be use as transmitting antenna.

Port 1, Port 2 could transmit simultaneously.

Port 1, Port 2, Port 3, Port 4 can be used as receiving antennas.

Port 1, Port 2, Port 3, Port 4 could receive simultaneously.

**For IEEE 802.11b/g/n/VHT/ax mode (2TX/4RX):**

Port 1, Port 2 can be use as transmitting antenna.

Port 1, Port 2 could transmitting simultaneously.

Port 1, Port 2, Port 3, Port 4 can be used as receiving antennas.

Port 1, Port 2, Port 3, Port 4 could receive simultaneously.

**For IEEE 802.11b/g/n/VHT/ax mode (4TX/4RX):**

Port 1, Port 2, Port 3 and Port 4 can be used as transmitting/receiving antenna.

Port 1, Port 2, Port 3 and Port 4 could transmit/receive simultaneously.

**For Scanning Radio 1****For 2.4GHz:****For IEEE 802.11b/g/n/VHT/ax mode (4TX/4RX):**

Port 1, Port 2, Port 3 and Port 4 can be used as transmitting/receiving antenna.

Port 1, Port 2, Port 3 and Port 4 could transmit/receive simultaneously.

**For 5GHz UNII 1, 3:****For IEEE 802.11a/n/ac/ax mode (2TX/2RX):**

Port 1, Port 2 can be used as transmitting/receiving antenna.

Port 1, Port 2 could transmit/receive simultaneously.

**For 6GHz UNII 5~8:****For IEEE 802.11ax mode (2TX/2RX):**

Port 1, Port 2 can be used as transmitting/receiving antenna.

Port 1, Port 2 could transmit/receive simultaneously.

**For Radio 2****For 5GHz UNII 1, 3:****For IEEE 802.11a/n/ac/ax mode (1TX/4RX):**

Only Port 1 can be use as transmitting antenna.

Port 1, Port 2, Port 3, Port 4 can be used as receiving antennas.

Port 1, Port 2, Port 3, Port 4 could receive simultaneously.

**For IEEE 802.11a/n/ac/ax mode (2TX/4RX):**

Port 1, Port 2 can be use as transmitting antenna.

Port 1, Port 2 could transmitting simultaneously.

Port 1, Port 2, Port 3, Port 4 can be used as receiving antennas.

Port 1, Port 2, Port 3, Port 4 could receive simultaneously.

**For IEEE 802.11a/n/ac/ax mode (4TX/4RX):**

Port 1, Port 2, Port 3 and Port 4 can be used as transmitting/receiving antenna.

Port 1, Port 2, Port 3 and Port 4 could transmit/receive simultaneously.

**For Radio 3****For 6GHz UNII 5~8:****For IEEE 802.11ax mode (1TX/4RX):**

Only Port 1 can be use as transmitting antenna.

Port 1, Port 2, Port 3, Port 4 can be used as receiving antennas.

Port 1, Port 2, Port 3, Port 4 could receive simultaneously.

**For IEEE 802.11ax mode (2TX/4RX):**

Port 1, Port 2 can be use as transmitting antenna.

Port 1, Port 2 could transmitting simultaneously.

Port 1, Port 2, Port 3, Port 4 can be used as receiving antennas.

Port 1, Port 2, Port 3, Port 4 could receive simultaneously.





**For IEEE 802.11ax mode (4TX/4RX):**

Port 1, Port 2, Port 3 and Port 4 can be used as transmitting/receiving antenna.  
Port 1, Port 2, Port 3 and Port 4 could transmit/receive simultaneously.

**For Radio 4**

**Bluetooth / IEEE802.15.4 (1TX):**

Only Port 1 can be used as transmitting antenna.

**For Radio 5**

**UWB (1TX/1RX):**

Only Port 1 can be used as transmitting/receiving antenna.

**1.1.3 Mode Test Duty Cycle**

Mode	DC	DCF(dB)	T(s)	VBW(Hz) ≥ 1/T
BT-LE(1Mbps)	0.638	1.95	398.75u	3k
BT-LE(2Mbps)	0.34	4.69	212.813u	10k

Note:

- ◆ DC is Duty Cycle.
- ◆ DCF is Duty Cycle Factor.

**1.1.4 EUT Operational Condition**

<b>EUT Power Type</b>	From Power Adapter or PoE		
<b>Function</b>	<input checked="" type="checkbox"/> Point-to-multipoint	<input type="checkbox"/>	Point-to-point
<b>Test Software Version</b>	DOS [ver 6.1.7601]		
<b>Support Mode</b>	<input checked="" type="checkbox"/>	LE 1M PHY: 1 Mb/s	
	<input checked="" type="checkbox"/>	LE Coded PHY (S=2): 500 Kb/s	
	<input checked="" type="checkbox"/>	LE Coded PHY (S=8): 125 Kb/s	
	<input checked="" type="checkbox"/>	LE 2M PHY: 2 Mb/s	

Note: The above information was declared by manufacturer.

**1.1.5 Table for EUT support function**

Function
AP
Bridge
Mesh

Note: For above table list, only AP mode was tested and recorded in this test.

Note: The above information was declared by manufacturer.



**1.1.6 Table for Radio function**

Radio (R)	WLAN 2.4GHz	5GHz UNII 1, 3	Scanning radio (WLAN 2.4GHz 4TX / 5GHz UNII 1, 3 2TX / 6E UNII 5~8 2TX)	6E (UNII 5~8)	Bluetooth / IEEE802.15.4	UWB
R1	V (AP, Bridge, Mesh)	-	V (2.4GHz: AP, Bridge, Mesh/5GHz, 6E: AP)	-	-	-
R2	-	V AP for UNII 1, 3 Bridge, Mesh for UNII 1, 3	-	-	-	-
R3	-	-	-	V (AP)	-	-
R4	-	-	-	-	V	-
R5	-	-	-	-	-	V

Note: The above information was declared by manufacturer.



### 1.2 Applicable Standards

According to the specifications of the manufacturer, the EUT must comply with the requirements of the following standards:

- ♦ 47 CFR FCC Part 15.247
- ♦ ANSI C63.10-2013

The following reference test guidance is not within the scope of accreditation of TAF.

- ♦ FCC KDB 558074 D01 v05r02
- ♦ FCC KDB 414788 D01 v01r01

### 1.3 Testing Location Information

Testing Location Information	
Test Lab. : Sporton International Inc. Hsinchu Laboratory	
Hsinchu	ADD: No.8, Ln. 724, Bo'ai St., Zhubei City, Hsinchu County 302010, Taiwan (R.O.C.)
(TAF: 3787)	TEL: 886-3-656-9065 FAX: 886-3-656-9085
	Test site Designation No. TW3787 with FCC.
	Conformity Assessment Body Identifier (CABID) TW3787 with ISED.

Test Condition	Test Site No.	Test Engineer	Test Environment (°C / %)	Test Date
RF Conducted	TH02-CB	Jay Lo	20.3~21 / 59~61	Dec. 14, 2021~Apr. 23, 2022
Radiated below 1GHz	03CH05-CB	Stim Sung	24.4~25.5 / 55~58	Dec. 15, 2021~Dec. 16, 2021
Radiated above 1GHz	03CH01-CB	RJ Huang	23.5~24.4 / 56~59	Dec. 11, 2021~Apr. 28, 2022
AC Conduction	CO01-CB	Peter Wu	23~24 / 52~53	Dec. 22, 2021

### 1.4 Measurement Uncertainty

ISO/IEC 17025 requires that an estimate of the measurement uncertainties associated with the emissions test results be included in the report. The measurement uncertainties given below are based on a 95% confidence level (based on a coverage factor (k=2))

Test Items	Uncertainty	Remark
Conducted Emission (150kHz ~ 30MHz)	3.4 dB	Confidence levels of 95%
Radiated Emission (9kHz ~ 30MHz)	4.2 dB	Confidence levels of 95%
Radiated Emission (30MHz ~ 1,000MHz)	5.5 dB	Confidence levels of 95%
Radiated Emission (1GHz ~ 18GHz)	4.7 dB	Confidence levels of 95%
Radiated Emission (18GHz ~ 40GHz)	4.2 dB	Confidence levels of 95%
Conducted Emission	2.5 dB	Confidence levels of 95%
Output Power Measurement	1.3 dB	Confidence levels of 95%
Power Density Measurement	2.5 dB	Confidence levels of 95%
Bandwidth Measurement	0.9%	Confidence levels of 95%



## 2 Test Configuration of EUT

### 2.1 Test Channel Mode

Mode	Power Setting
BT-LE(1Mbps)	-
2402MHz	0E
2440MHz	0E
2480MHz	0E
BT-LE(2Mbps)	-
2402MHz	0E
2440MHz	0E
2480MHz	0E

### 2.2 The Worst Case Measurement Configuration

The Worst Case Mode for Following Conformance Tests	
<b>Tests Item</b>	AC power-line conducted emissions
<b>Condition</b>	AC power-line conducted measurement for line and neutral Test Voltage: 120Vac / 60Hz
<b>Operating Mode</b>	Normal Link, CTX
1	Normal Link (R1: (2.4GHz) + R2 + R3) + CTX (R4: (Bluetooth)) + adapter
2	Normal Link (R1: (2.4GHz) + R2 + R3) + CTX (R4: (IEEE802.15.4)) + adapter
3	Normal Link (R1: (2.4GHz) + R2 + R3) + CTX (R5: (UWB)) + adapter
Mode 1 has been evaluated to be the worst case among Mode 1~3, thus measurement for Mode 4~Mode 5 will follow this same test mode.	
4	Normal Link (Scanning radio 1: (5GHz UNII 1, UNII 3) + R2 + R3) + CTX (R4: (Bluetooth)) + adapter
5	Normal Link (Scanning radio 1: (6GHz UNII 5~UNII 8) + R2 + R3) + CTX (R4: (Bluetooth)) + adapter
Mode 1 has been evaluated to be the worst case among Mode 1~5, thus measurement for Mode 6 will follow this same test mode.	
6	Normal Link (R1: (2.4GHz) + R2 + R3) + CTX (R4: (Bluetooth)) + PoE
For operating mode 6 is the worst case and it was record in this test report.	

The Worst Case Mode for Following Conformance Tests	
<b>Tests Item</b>	DTS Bandwidth Maximum Conducted Output Power Power Spectral Density Emissions in Non-restricted Frequency Bands
<b>Test Condition</b>	Conducted measurement at transmit chains



<b>The Worst Case Mode for Following Conformance Tests</b>	
<b>Tests Item</b>	Emissions in Restricted Frequency Bands
<b>Test Condition</b>	Radiated measurement If EUT consist of multiple antenna assembly (multiple antenna are used in EUT regardless of spatial multiplexing MIMO configuration), the radiated test should be performed with highest antenna gain of each antenna type.
<b>Operating Mode &lt; 1GHz</b>	Normal Link, CTX
1	EUT in Z axis-Normal Link (R1: (2.4GHz) + R2 + R3) + CTX (R4: (Bluetooth)) + adapter
2	EUT in Y axis-Normal Link (R1: (2.4GHz) + R2 + R3) + CTX (R4: (Bluetooth)) + adapter
3	EUT in X axis-Normal Link (R1: (2.4GHz) + R2 + R3) + CTX (R4: (Bluetooth)) + adapter
Mode 3 has been evaluated to be the worst case among Mode 1~3, thus measurement for Mode 4~5 will follow this same test mode.	
4	EUT in X axis-Normal Link (R1: (2.4GHz) + R2 + R3) + CTX (R4: (IEEE802.15.4)) + adapter
5	EUT in X axis-Normal Link (R1: (2.4GHz) + R2 + R3) + CTX (R5: (UWB)) + adapter
Mode 4 has been evaluated to be the worst case among Mode 1~5, thus measurement for Mode 6~7 will follow this same test mode.	
6	EUT in X axis-Normal Link (Scanning radio 1: (5GHz UNII 1, UNII 3) + R2 + R3) + CTX (R4: (IEEE802.15.4)) + adapter
7	EUT in X axis-Normal Link (Scanning radio 1: (6GHz UNII 5~UNII 8) + R2 + R3) + CTX (R4: (IEEE802.15.4)) + adapter
Mode 4 has been evaluated to be the worst case among Mode 1~7, thus measurement for Mode 8 will follow this same test mode.	
8	EUT in X axis-Normal Link (R1: (2.4GHz) + R2 + R3) + CTX (R4: (IEEE802.15.4)) + PoE
For operating mode 4 is the worst case and it was record in this test report.	
<b>Operating Mode &gt; 1GHz</b>	CTX The EUT was performed at X axis, Y axis and Z axis and the worst case was found at Y axis. So the measurement will follow this same test configuration.
1	Radio 4_EUT in Y axis



<b>The Worst Case Mode for Following Conformance Tests</b>	
<b>Tests Item</b>	Simultaneous Transmission Analysis - Co-location RF Exposure Evaluation
<b>Operating Mode</b>	
1	R1: (2.4GHz) + R2 + R3 + R4: (Bluetooth)
2	R1: (2.4GHz) + R2 + R3 + R4: (IEEE802.15.4)
3	R1: (2.4GHz) + R2 + R3 + R5: (UWB)
4	Scanning radio 1: (5GHz UNII 1, UNII 3) + R2 + R3 + R4: (Bluetooth)
5	Scanning radio 1: (5GHz UNII 1, UNII 3) + R2 + R3 + R4: (IEEE802.15.4)
6	Scanning radio 1: (5GHz UNII 1, UNII 3) + R2 + R3 + R5: (UWB)
7	Scanning radio 1: (6GHz UNII 5~UNII 8) + R2 + R3 + R4: (Bluetooth)
8	Scanning radio 1: (6GHz UNII 5~UNII 8) + R2 + R3 + R4: (IEEE802.15.4)
9	Scanning radio 1: (6GHz UNII 5~UNII 8) + R2 + R3 + R5: (UWB)
Refer to Sporton Test Report No.: FA1N2902 for Co-location RF Exposure Evaluation.	

Note: The PoE and adapter are for measurement only, would not be marketed.

Their information as below:

<b>Power</b>	<b>Brand</b>	<b>Model</b>
PoE	Microsemi	PD-9001-10GC/AC
Adapter	Powertron	PA1045-120HIB300

### 2.3 EUT Operation during Test

For CTX Mode:

The EUT was programmed to be in continuously transmitting mode.

For Normal Link Mode:

During the test, the EUT operation to normal function.

### 2.4 Accessories

<b>Accessories</b>
Bracket*1



## 2.5 Support Equipment

For AC Conduction:

Support Equipment				
No.	Equipment	Brand Name	Model Name	FCC ID
A	PoE	Microsemi	PD-9501-10GC/AC	N/A
B	PD Load	JUNIPER	RXRB-MIB	N/A
C	5G WAN PC	DELL	T3400	N/A
D	LAN NB	DELL	E6430	N/A
E	2.4G NB	DELL	E6430	N/A
F	5G NB	DELL	E6430	N/A
G	6E device	JUNIPER	RXRB-MIB	N/A
H	6E NB	DELL	E6430	N/A
I	Flash disk3.0	Transcend	JetFlash-700	N/A

For Radiated (below 1GHz):

Support Equipment				
No.	Equipment	Brand Name	Model Name	FCC ID
A	Notebook(LAN NB)	DELL	E4300	N/A
B	Notebook(LAN NB)	DELL	E4300	N/A
C	Flash disk3.0	Silicon Power	B06	N/A
D	WIFI Access Point	Extreme Networks	AP5010U	N/A
E	Notebook(2.4G NB)	DELL	E4300	N/A
F	Notebook(5G NB)	DELL	E4300	N/A
G	Notebook(Client NB)	DELL	E4300	N/A
H	Adapter	Powertron	PA1045-120HIB300	N/A

For Radiated (above 1GHz) and RF Conducted:

Support Equipment				
No.	Equipment	Brand Name	Model Name	FCC ID
A	NB	DELL	E4300	N/A
B	Adapter	Powertron	PA1045-120HIB300	N/A

## 2.6 Test Setup Diagram

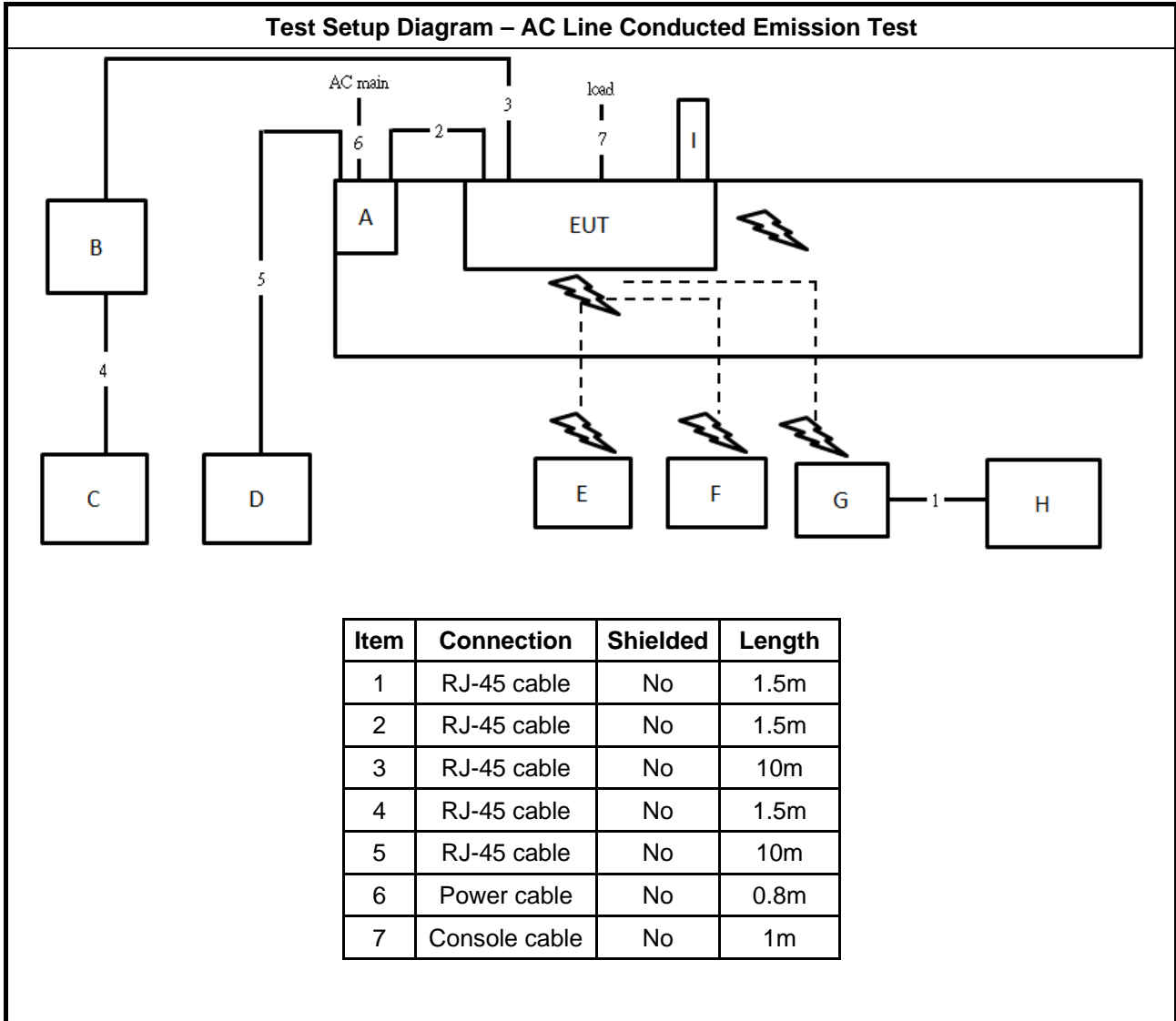



**Test Setup Diagram - Radiated Test < 1GHz**

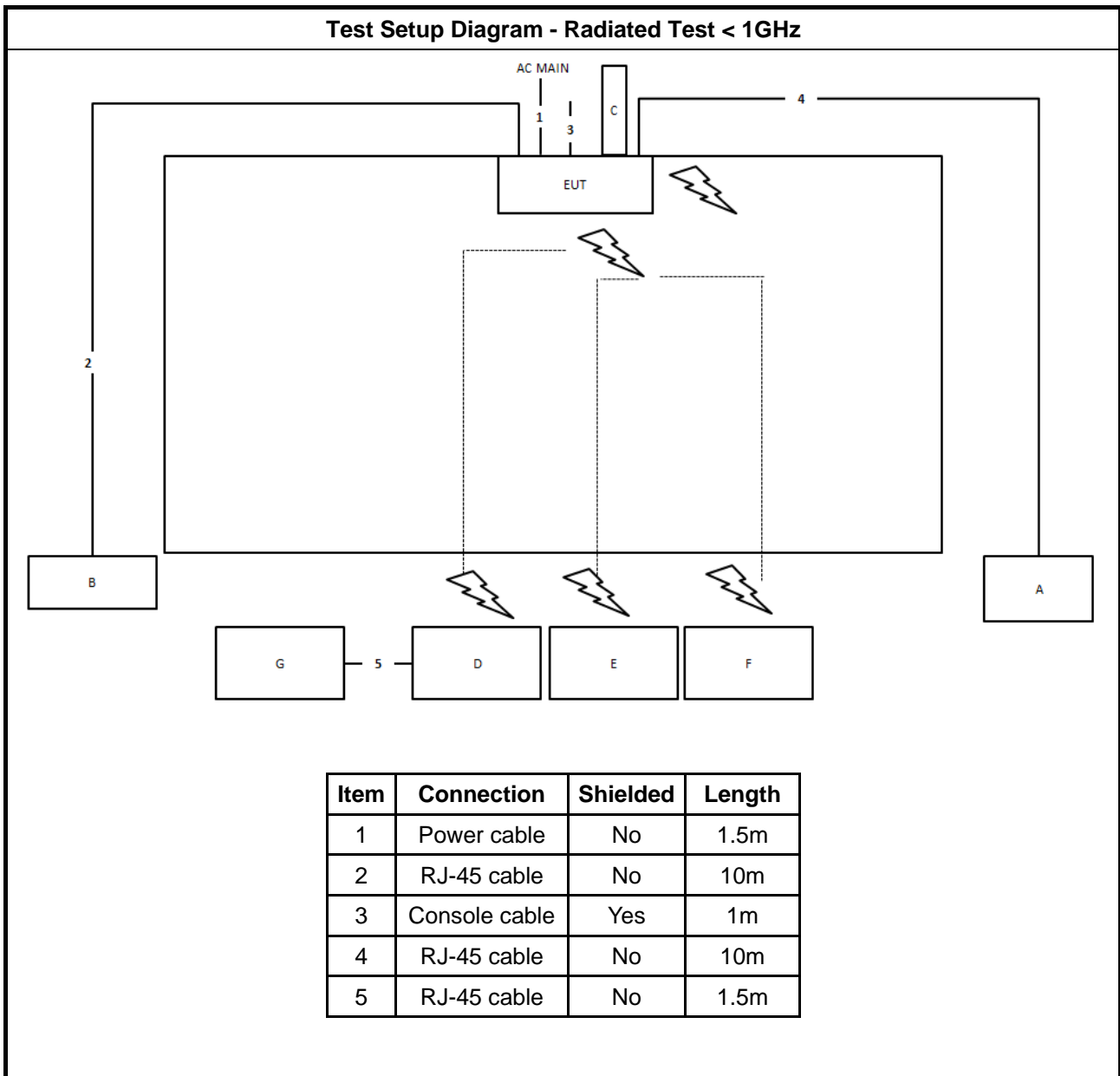

**Test Setup Diagram - Radiated Test > 1GHz**

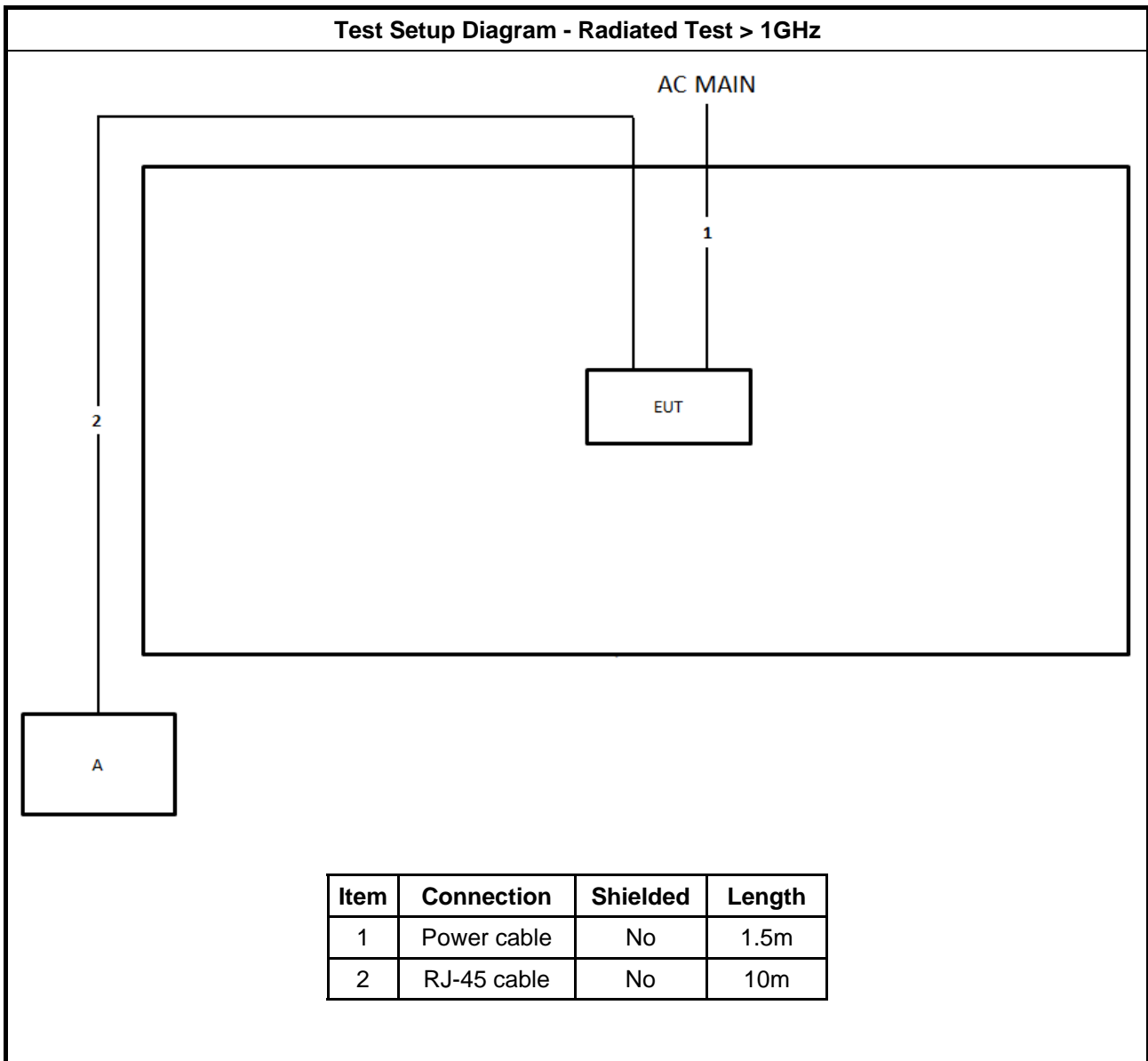

Item	Connection	Shielded	Length
1	Power cable	No	1.5m
2	RJ-45 cable	No	10m



### 3 Transmitter Test Result

#### 3.1 AC Power-line Conducted Emissions

##### 3.1.1 AC Power-line Conducted Emissions Limit

AC Power-line Conducted Emissions Limit		
Frequency Emission (MHz)	Quasi-Peak	Average
0.15-0.5	66 - 56 *	56 - 46 *
0.5-5	56	46
5-30	60	50

Note 1: \* Decreases with the logarithm of the frequency.

##### 3.1.2 Measuring Instruments

Refer a test equipment and calibration data table in this test report.

##### 3.1.3 Test Procedures

Test Method
▪ Refer as ANSI C63.10-2013, clause 6.2 for AC power-line conducted emissions.

### 3.1.4 Test Setup

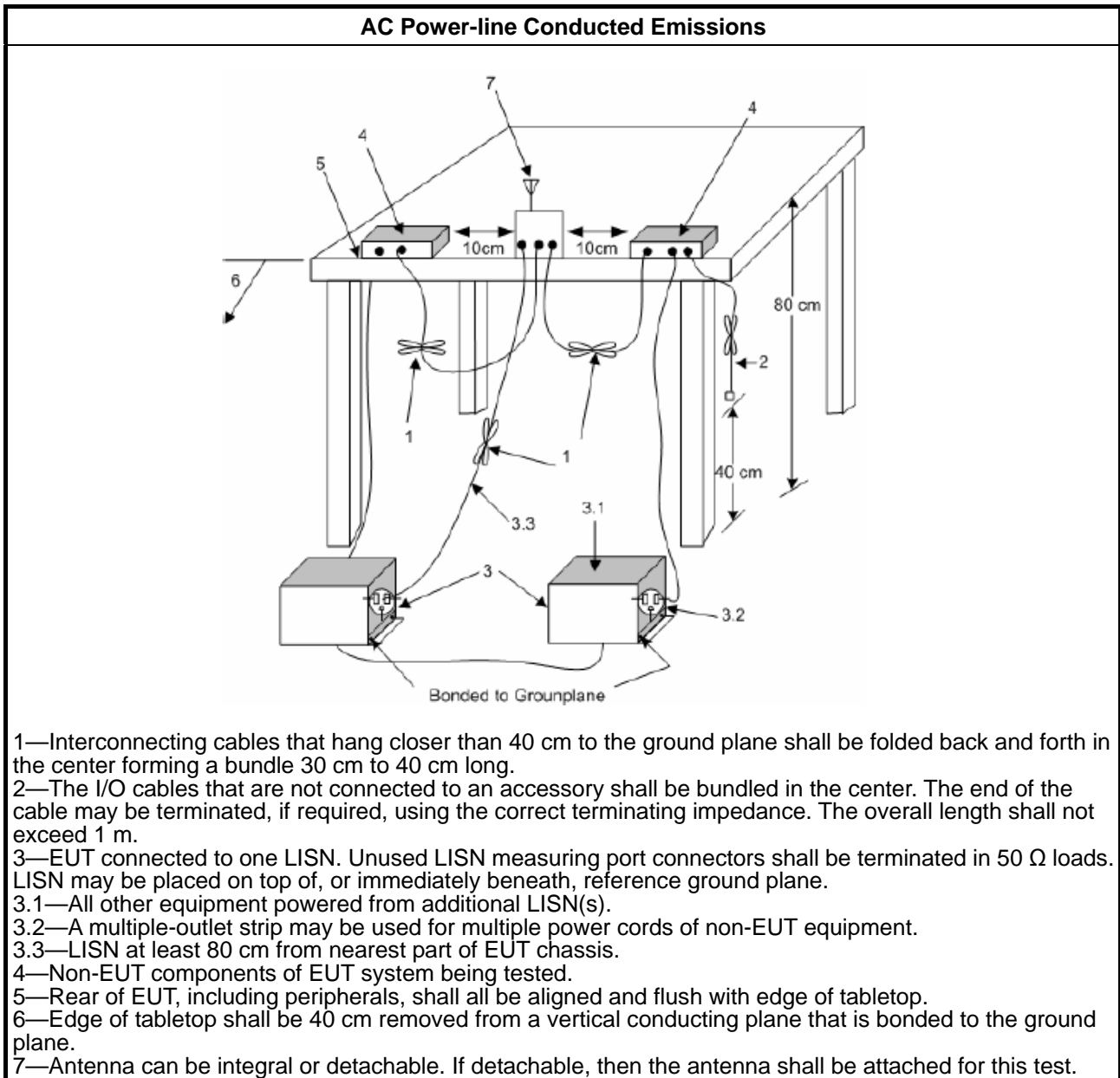

#### 1.1.1. Measurement Results Calculation

The measured Level is calculated using:

- a. Corrected Reading: LISN Factor (LISN) + Attenuator (AT/AUX) + Cable Loss (CL) + Read Level (Raw) = Level
- b. Margin = -Limit + Level

### 3.1.5 Test Result of AC Power-line Conducted Emissions

Refer as Appendix A

### 3.2 DTS Bandwidth

#### 3.2.1 6dB Bandwidth Limit

6dB Bandwidth Limit
<b>Systems using digital modulation techniques:</b>
<ul style="list-style-type: none"> <li>▪ 6 dB bandwidth <math>\geq</math> 500 kHz.</li> </ul>

#### 3.2.2 Measuring Instruments

Refer a test equipment and calibration data table in this test report.

#### 3.2.3 Test Procedures

Test Method
<ul style="list-style-type: none"> <li>▪ For the emission bandwidth shall be measured using one of the options below:</li> </ul>
<input checked="" type="checkbox"/> Refer as FCC KDB 558074, clause 8.2 & C63.10 clause 11.8.1 Option 1 for 6 dB bandwidth measurement.
<input type="checkbox"/> Refer as FCC KDB 558074, clause 8.2 & C63.10 clause 11.8.2 Option 2 for 6 dB bandwidth measurement.
<input type="checkbox"/> Refer as ANSI C63.10, clause 6.9.1 for occupied bandwidth testing.

#### 3.2.4 Test Setup

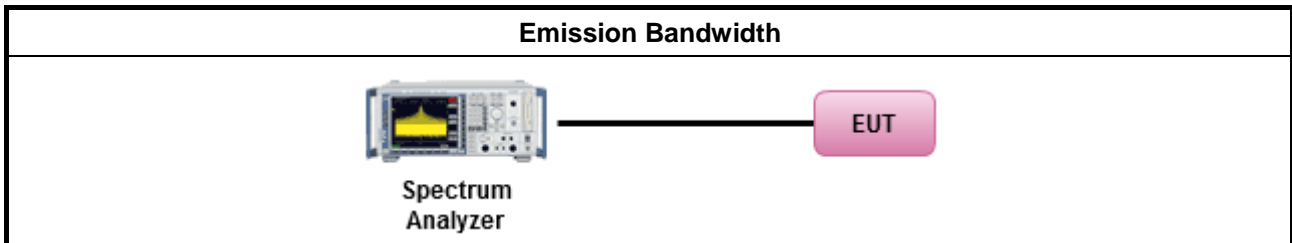

#### 3.2.5 Test Result of Emission Bandwidth

Refer as Appendix B

### 3.3 Maximum Conducted Output Power

#### 3.3.1 Maximum Conducted Output Power Limit

Maximum Conducted Output Power Limit	
	<ul style="list-style-type: none"> <li>▪ If <math>G_{TX} \leq 6</math> dBi, then <math>P_{Out} \leq 30</math> dBm (1 W)</li> </ul>
	<ul style="list-style-type: none"> <li>▪ Point-to-multipoint systems (P2M): If <math>G_{TX} &gt; 6</math> dBi, then <math>P_{Out} = 30 - (G_{TX} - 6)</math> dBm</li> </ul>
	<ul style="list-style-type: none"> <li>▪ Point-to-point systems (P2P): If <math>G_{TX} &gt; 6</math> dBi, then <math>P_{Out} = 30 - (G_{TX} - 6)/3</math> dBm</li> </ul>
	<ul style="list-style-type: none"> <li>▪ Smart antenna system (SAS):</li> </ul>
	<ul style="list-style-type: none"> <li>- Single beam: If <math>G_{TX} &gt; 6</math> dBi, then <math>P_{Out} = 30 - (G_{TX} - 6)/3</math> dBm</li> </ul>
	<ul style="list-style-type: none"> <li>- Overlap beam: If <math>G_{TX} &gt; 6</math> dBi, then <math>P_{Out} = 30 - (G_{TX} - 6)/3</math> dBm</li> </ul>
	<ul style="list-style-type: none"> <li>- Aggregate power on all beams: If <math>G_{TX} &gt; 6</math> dBi, then <math>P_{Out} = 30 - (G_{TX} - 6)/3 + 8</math> dB dBm</li> </ul>
$P_{Out}$ = maximum peak conducted output power or maximum conducted output power in dBm, $G_{TX}$ = the maximum transmitting antenna directional gain in dBi.	

#### 3.3.2 Measuring Instruments

Refer a test equipment and calibration data table in this test report.



**3.3.3 Test Procedures**

Test Method	
<ul style="list-style-type: none"> <li>▪ Maximum Peak Conducted Output Power</li> </ul>	
	<input type="checkbox"/> Refer as FCC KDB 558074, clause 8.3.1.1 & C63.10 clause 11.9.1.1 (RBW ≥ EBW method).
	<input type="checkbox"/> Refer as FCC KDB 558074, clause 8.3.1.3 & C63.10 clause 11.9.1.3 (peak power meter).
<ul style="list-style-type: none"> <li>▪ Maximum Conducted Output Power</li> </ul>	
[duty cycle ≥ 98% or external video / power trigger]	
	<input type="checkbox"/> Refer as FCC KDB 558074, clause 8.3.2.2 & C63.10 clause 11.9.2.2.2 Method AVGSA-1.
	<input type="checkbox"/> Refer as FCC KDB 558074, clause 8.3.2.2 & C63.10 clause 11.9.2.2.3 Method AVGSA-1A. (alternative)
duty cycle < 98% and average over on/off periods with duty factor	
	<input type="checkbox"/> Refer as FCC KDB 558074, clause 8.3.2.2 & C63.10 clause 11.9.2.2.4 Method AVGSA-2.
	<input type="checkbox"/> Refer as FCC KDB 558074, clause 8.3.2.2 & C63.10 clause 11.9.2.2.5 Method AVGSA-2A (alternative)
	<input type="checkbox"/> Refer as FCC KDB 558074, clause 8.3.2.2 & C63.10 clause 11.9.2.2.6 Method AVGSA-3
	<input type="checkbox"/> Refer as FCC KDB 558074, clause 8.3.2.2 & C63.10 clause 11.9.2.2.7 Method AVGSA-3A (alternative)
Measurement using a power meter (PM)	
	<input type="checkbox"/> Refer as FCC KDB 558074, clause 8.3.2.3 & C63.10 clause 11.9.2.3.1 Method AVGPM (using an RF average power meter).
	<input checked="" type="checkbox"/> Refer as FCC KDB 558074, clause 8.3.2.3 & C63.10 clause 11.9.2.3.2 Method AVGPM-G (using an gate RF average power meter).
<ul style="list-style-type: none"> <li>▪ For conducted measurement.</li> </ul>	
	<ul style="list-style-type: none"> <li>▪ If the EUT supports multiple transmit chains using options given below: Refer as FCC KDB 662911, In-band power measurements. Using the measure-and-sum approach, measured all transmit ports individually. Sum the power (in linear power units e.g., mW) of all ports for each individual sample and save them.</li> </ul>
	<ul style="list-style-type: none"> <li>▪ If multiple transmit chains, EIRP calculation could be following as methods:  <math display="block">P_{total} = P_1 + P_2 + \dots + P_n</math>                     (calculated in linear unit [mW] and transfer to log unit [dBm])  <math display="block">EIRP_{total} = P_{total} + DG</math> </li> </ul>

### 3.3.4 Test Setup

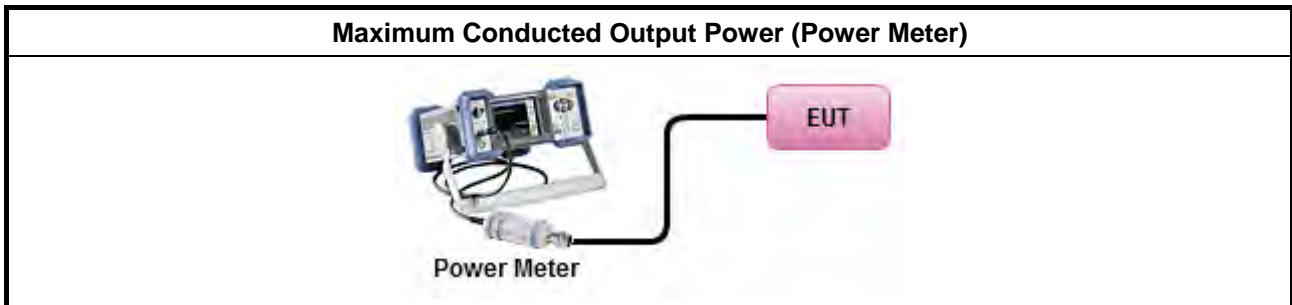

### 3.3.5 Test Result of Maximum Conducted Output Power

Refer as Appendix C





### 3.4 Power Spectral Density

#### 3.4.1 Power Spectral Density Limit

Power Spectral Density Limit
<ul style="list-style-type: none"> <li>Power Spectral Density (PSD) ≤ 8 dBm/3kHz</li> </ul>

#### 3.4.2 Measuring Instruments

Refer a test equipment and calibration data table in this test report.

#### 3.4.3 Test Procedures

Test Method
<ul style="list-style-type: none"> <li>Peak power spectral density procedures that the same method as used to determine the conducted output power. If maximum peak conducted output power was measured to demonstrate compliance to the output power limit, then the peak PSD procedure below (Method PKPSD) shall be used. If maximum conducted output power was measured to demonstrate compliance to the output power limit, then one of the average PSD procedures shall be used, as applicable based on the following criteria (the peak PSD procedure is also an acceptable option).</li> </ul>
<input checked="" type="checkbox"/> Refer as FCC KDB 558074, clause 8.4 & C63.10 clause 11.10 Method Max. PSD. [duty cycle ≥ 98% or external video / power trigger]
<ul style="list-style-type: none"> <li>For conducted measurement.</li> </ul>
<ul style="list-style-type: none"> <li>If The EUT supports multiple transmit chains using options given below:               <ul style="list-style-type: none"> <li><input type="checkbox"/> Option 1: Measure and sum the spectra across the outputs. Refer as FCC KDB 662911, In-band power spectral density (PSD). Sample all transmit ports simultaneously using a spectrum analyzer for each transmit port. Where the trace bin-by-bin of each transmit port summing can be performed. (i.e., in the first spectral bin of output 1 is summed with that in the first spectral bin of output 2 and that from the first spectral bin of output 3, and so on up to the NTX output to obtain the value for the first frequency bin of the summed spectrum.). Add up the amplitude (power) values for the different transmit chains and use this as the new data trace.</li> <li><input type="checkbox"/> Option 2: Measure and sum spectral maxima across the outputs. With this technique, spectra are measured at each output of the device at the required resolution bandwidth. The maximum value (peak) of each spectrum is determined. These maximum values are then summed mathematically in linear power units across the outputs. These operations shall be performed separately over frequency spans that have different out-of-band or spurious emission limits,</li> <li><input type="checkbox"/> Option 3: Measure and add 10 log(N) dB, where N is the number of transmit chains. Refer as FCC KDB 662911, In-band power spectral density (PSD). Performed at each transmit chains and each transmit chains shall be compared with the limit have been reduced with 10 log(N). Or each transmit chains shall be add 10 log(N) to compared with the limit.</li> </ul> </li> </ul>

### 3.4.4 Test Setup

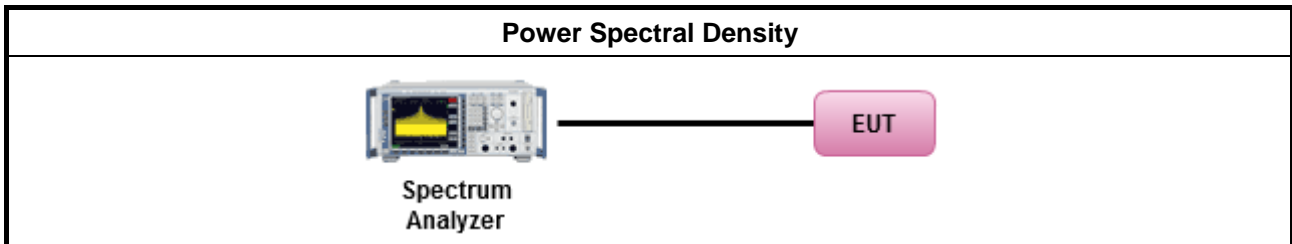

### 3.4.5 Test Result of Power Spectral Density

Refer as Appendix D

### 3.5 Emissions in Non-restricted Frequency Bands

#### 3.5.1 Emissions in Non-restricted Frequency Bands Limit

Un-restricted Band Emissions Limit	
RF output power procedure	Limit (dBc)
Peak output power procedure	20
Average output power procedure	30

Note 1: If the peak output power procedure is used to measure the fundamental emission power to demonstrate compliance to requirements, then the peak conducted output power measured within any 100 kHz outside the authorized frequency band shall be attenuated by at least 20 dB relative to the maximum measured in-band peak PSD level.

Note 2: If the average output power procedure is used to measure the fundamental emission power to demonstrate compliance to requirements, then the power in any 100 kHz outside of the authorized frequency band shall be attenuated by at least 30 dB relative to the maximum measured in-band average PSD level.

#### 3.5.2 Measuring Instruments

Refer a test equipment and calibration data table in this test report.

#### 3.5.3 Test Procedures

Test Method
<ul style="list-style-type: none"> <li>Refer as FCC KDB 558074, clause 8.5 for unwanted emissions into non-restricted bands.</li> </ul>

#### 3.5.4 Test Setup

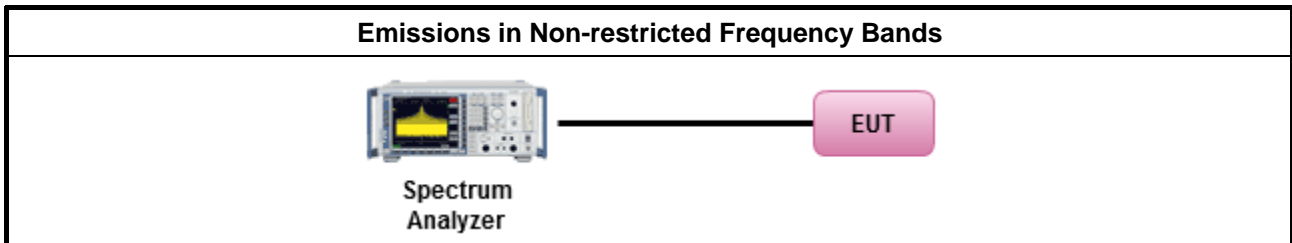

#### 3.5.5 Test Result of Emissions in Non-restricted Frequency Bands

Refer as Appendix E



### 3.6 Emissions in Restricted Frequency Bands

#### 3.6.1 Emissions in Restricted Frequency Bands Limit

Restricted Band Emissions Limit			
Frequency Range (MHz)	Field Strength (uV/m)	Field Strength (dBuV/m)	Measure Distance (m)
0.009~0.490	2400/F(kHz)	48.5 - 13.8	300
0.490~1.705	24000/F(kHz)	33.8 - 23	30
1.705~30.0	30	29	30
30~88	100	40	3
88~216	150	43.5	3
216~960	200	46	3
Above 960	500	54	3

Note 1: Test distance for frequencies at or above 30 MHz, measurements may be performed at a distance other than the limit distance provided they are not performed in the near field and the emissions to be measured can be detected by the measurement equipment. When performing measurements at a distance other than that specified, the results shall be extrapolated to the specified distance using an extrapolation factor of 20 dB/decade (inverse of linear distance for field-strength measurements, inverse of linear distance-squared for power-density measurements).

Note 2: Test distance for frequencies at below 30 MHz, measurements may be performed at a distance closer than the EUT limit distance; however, an attempt should be made to avoid making measurements in the near field. When performing measurements below 30 MHz at a closer distance than the limit distance, the results shall be extrapolated to the specified distance by either making measurements at a minimum of two or more distances on at least one radial to determine the proper extrapolation factor or by using the square of an inverse linear distance extrapolation factor (40 dB / decade). The test report shall specify the extrapolation method used to determine compliance of the EUT.

Note 3: Using the distance of 1m during the test for above 18 GHz, and the test value to correct for the distance factor at 3m.

#### 3.6.2 Measuring Instruments

Refer a test equipment and calibration data table in this test report.



**3.6.3 Test Procedures**

<b>Test Method</b>	
<ul style="list-style-type: none"> <li>▪ The average emission levels shall be measured in [duty cycle <math>\geq</math> 98 or duty factor].</li> </ul>	
<ul style="list-style-type: none"> <li>▪ Refer as ANSI C63.10, clause 6.10.3 band-edge testing shall be performed at the lowest frequency channel and highest frequency channel within the allowed operating band.</li> </ul>	
<ul style="list-style-type: none"> <li>▪ For the transmitter unwanted emissions shall be measured using following options below:</li> </ul>	
	<ul style="list-style-type: none"> <li>▪ Refer as FCC KDB 558074, clause 8.6 for unwanted emissions into restricted bands.</li> </ul>
	<input type="checkbox"/> Refer as FCC KDB 558074, clause 8.6 & C63.10 clause 11.12.2.5.1(trace averaging for duty cycle $\geq$ 98%).
	<input type="checkbox"/> Refer as FCC KDB 558074, clause 8.6 & C63.10 clause 11.12.2.5.2(trace averaging + duty factor).
	<input checked="" type="checkbox"/> Refer as FCC KDB 558074, clause 8.6 & C63.10 clause 11.12.2.5.3(Reduced VBW $\geq$ 1/T).
	<input type="checkbox"/> Refer as ANSI C63.10, clause 11.12.2.5.3 (Reduced VBW). VBW $\geq$ 1/T, where T is pulse time.
	<input type="checkbox"/> Refer as ANSI C63.10, clause 7.5 average value of pulsed emissions.
	<input checked="" type="checkbox"/> Refer as FCC KDB 558074, clause 8.6 & C63.10 clause 11.12.2.4 measurement procedure peak limit.
<ul style="list-style-type: none"> <li>▪ For the transmitter band-edge emissions shall be measured using following options below:</li> </ul>	
	<ul style="list-style-type: none"> <li>▪ Refer as FCC KDB 558074 clause 8.7 &amp; c63.10 clause 11.13.1, When the performing peak or average radiated measurements, emissions within 2 MHz of the authorized band edge may be measured using the marker-delta method described below.</li> </ul>
	<ul style="list-style-type: none"> <li>▪ Refer as FCC KDB 558074, clause 8.7 (ANSI C63.10, clause 6.10.6) for marker-delta method for band-edge measurements.</li> </ul>
	<ul style="list-style-type: none"> <li>▪ Refer as FCC KDB 558074, clause 8.7 for narrower resolution bandwidth (100kHz) using the band power and summing the spectral levels (i.e., 1 MHz).</li> </ul>
	<ul style="list-style-type: none"> <li>▪ For conducted unwanted emissions into restricted bands (absolute emission limits). Devices with multiple transmit chains using options given below:                (1) Measure and sum the spectra across the outputs or                (2) Measure and add 10 log(N) dB             </li> </ul>
	<ul style="list-style-type: none"> <li>▪ For FCC KDB 662911 The methodology described here may overestimate array gain, thereby resulting in apparent failures to satisfy the out-of-band limits even if the device is actually compliant. In such cases, compliance may be demonstrated by performing radiated tests around the frequencies at which the apparent failures occurred.</li> </ul>

**3.6.4 Test Setup**

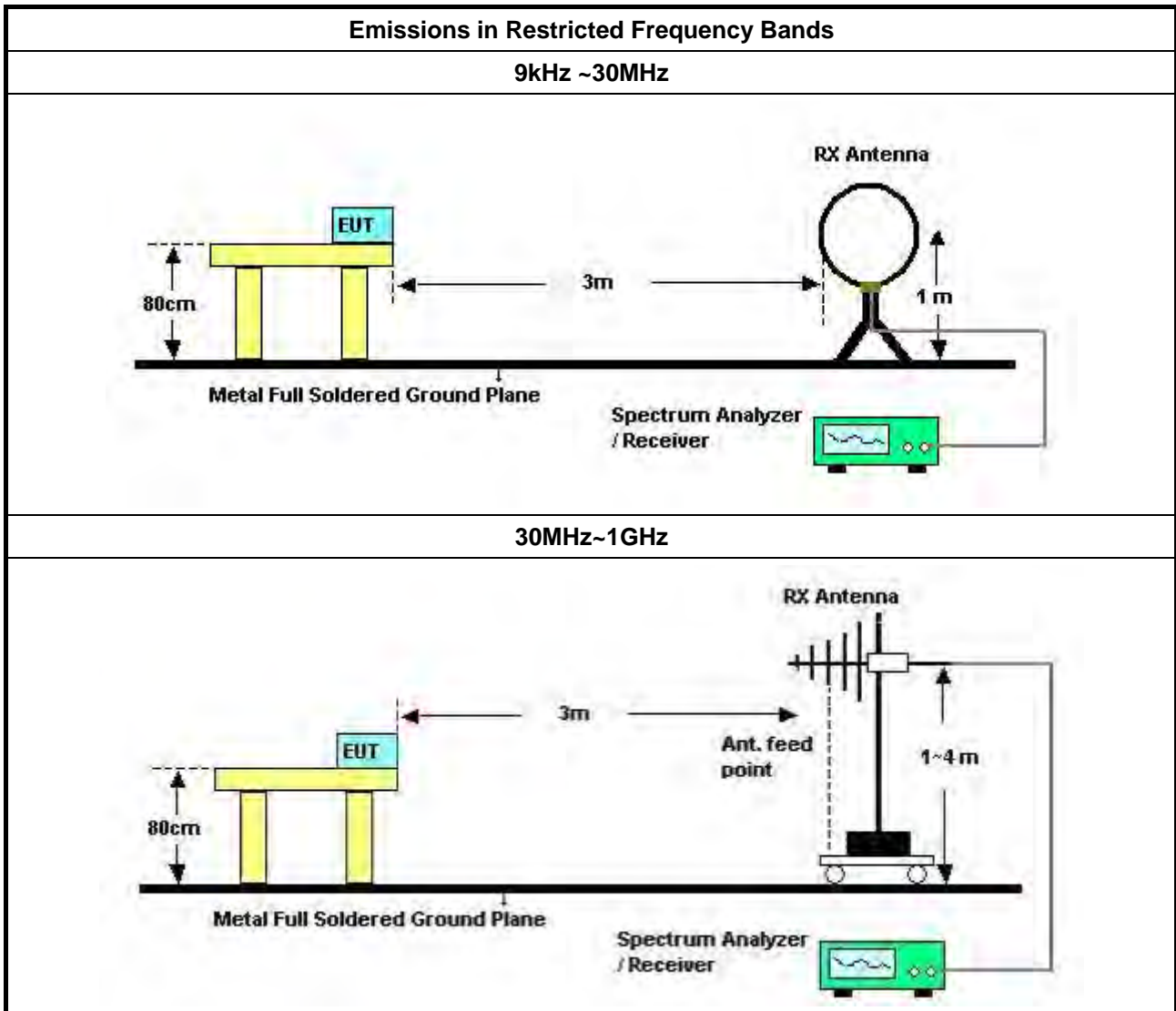

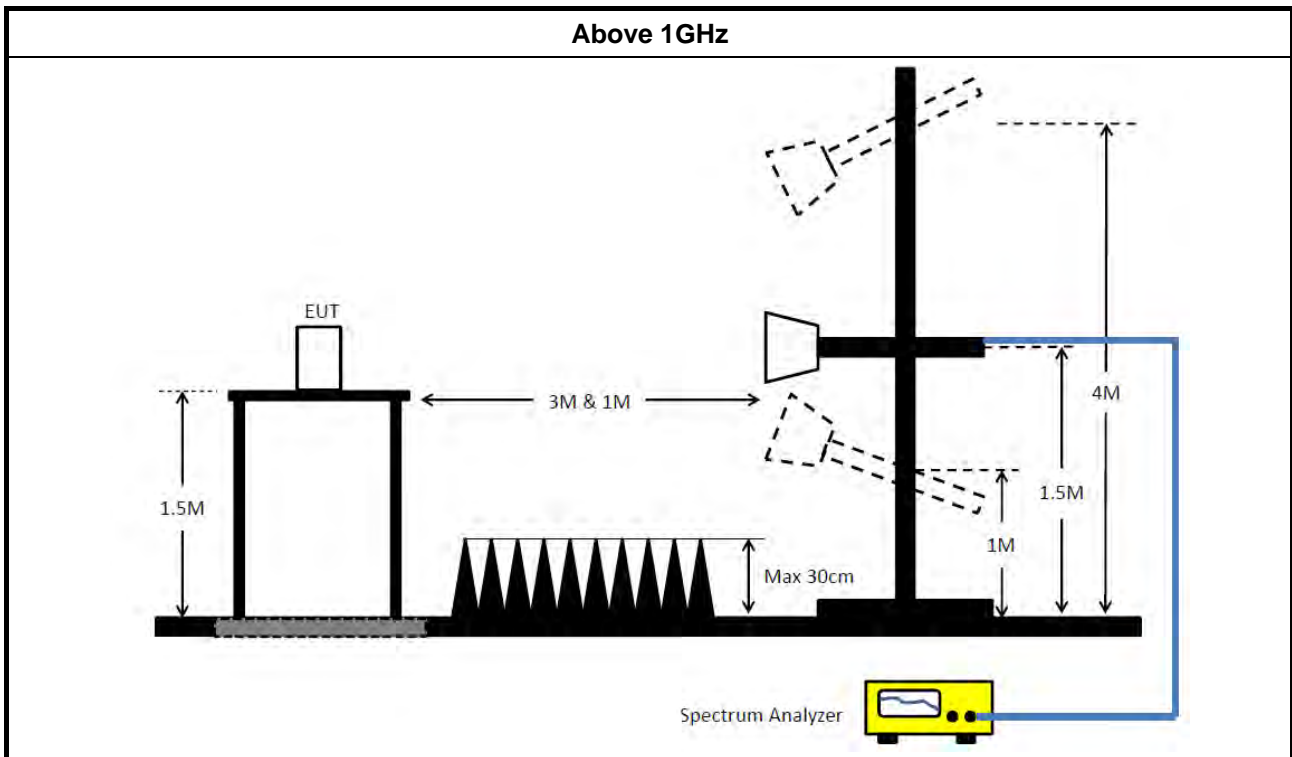

### 3.6.5 Measurement Results Calculation

The measured Level is calculated using:

Corrected Reading: Antenna factor (AF) + Cable loss (CL) + Read level (Raw) - Preamp factor (PA)(if applicable) = Level.

### 3.6.6 Emissions in Restricted Frequency Bands (Below 30MHz)

There is a comparison data of both open-field test site and alternative test site - semi-Anechoic chamber according to KDB414788 Radiated Test Site, and the result came out very similar.

All amplitude of spurious emissions that are attenuated by more than 20 dB below the permissible value has no need to be reported.

The radiated emissions were investigated from 9 kHz or the lowest frequency generated within the device, up to the 10th harmonic or 40 GHz, whichever is appropriate.

### 3.6.7 Test Result of Emissions in Restricted Frequency Bands

Refer as Appendix F



## 4 Test Equipment and Calibration Data

Instrument	Brand	Model No.	Serial No.	Characteristics	Calibration Date	Calibration Due Date	Remark
EMI Receiver	Agilent	N9038A	My52260123	9kHz ~ 8.4GHz	Mar. 03, 2021	Mar. 02, 2022	Conduction (CO01-CB)
LISN	F.C.C.	FCC-LISN-50-1 6-2	04083	150kHz ~ 100MHz	Jan. 06, 2021	Jan. 05, 2022	Conduction (CO01-CB)
LISN	Schwarzbeck	NSLK 8127	8127647	9kHz ~ 30MHz	Mar. 07, 2021	Mar. 06, 2022	Conduction (CO01-CB)
Pulse Limiter	Rohde& Schwarz	ESH3-Z2	100430	9kHz ~ 30MHz	Jan. 30, 2021	Jan. 29, 2022	Conduction (CO01-CB)
COND Cable	Woken	Cable	Low cable-CO01	9kHz ~ 30MHz	May 19, 2021	May 18, 2022	Conduction (CO01-CB)
Software	SPORTON	SENSE	V5.10	-	N.C.R.	N.C.R.	Conduction (CO01-CB)
Loop Antenna	Teseq	HLA 6120	24155	9kHz - 30 MHz	Apr. 14, 2021	Apr. 13, 2022	Radiation (03CH05-CB)
3m Semi Anechoic Chamber NSA	TDK	SAC-3M	03CH05-CB	30 MHz ~ 1 GHz	Aug. 09, 2021	Aug. 08, 2022	Radiation (03CH05-CB)
Bilog Antenna with 6dB Attenuator	TESEQ & EMCI	CBL 6112D & N-6-06	35236 & AT-N0610	30MHz ~ 2GHz	Mar. 26, 2021	Mar. 25, 2022	Radiation (03CH05-CB)
Pre-Amplifier	EMCI	EMC330N	980331	20MHz ~ 3GHz	Apr. 27, 2021	Apr. 26, 2022	Radiation (03CH05-CB)
Signal Analyzer	R&S	FSV40	101903	9kHz ~ 40GHz	Mar. 22, 2021	Mar. 21, 2022	Radiation (03CH05-CB)
EMI Test Receiver	R&S	ESCS	826547/017	9kHz ~ 2.75GHz	Jun. 21, 2021	Jun. 20, 2022	Radiation (03CH05-CB)
RF Cable-low	Woken	RG402	Low Cable-04+23	30MHz~1GHz	Oct. 13, 2021	Oct. 12, 2022	Radiation (03CH05-CB)
Test Software	SPORTON	SENSE	V5.10	-	N.C.R.	N.C.R.	Radiation (03CH05-CB)
3m Semi Anechoic Chamber VSWR	TDK	SAC-3M	03CH01-CB	1GHz ~18GHz 3m	May 07, 2021	May 06, 2022	Radiation (03CH01-CB)
Horn Antenna	ETS-LINDGR EN	3115	00075790	750MHz ~ 18GHz	Nov. 06, 2021	Nov. 05, 2022	Radiation (03CH01-CB)
Horn Antenna	Schwarzbeck	BBHA 9170	BBHA9170252	15GHz ~ 40GHz	Aug. 05, 2021	Aug. 04, 2022	Radiation (03CH01-CB)
Pre-Amplifier	Agilent	8449B	3008A02121	1GHz ~ 26.5GHz	May 20, 2021	May 19, 2022	Radiation (03CH01-CB)
Pre-Amplifier	MITEQ	TTA1840-35-H G	1864479	18GHz ~ 40GHz	Jul. 13, 2021	Jul. 12, 2022	Radiation (03CH01-CB)
Spectrum Analyzer	R&S	FSP40	100056	9kHz ~ 40GHz	May 03, 2021	May 02, 2022	Radiation (03CH01-CB)
RF Cable-high	Woken	RG402	High Cable-16	1 GHz ~ 18 GHz	Oct. 04, 2021	Oct. 03, 2022	Radiation (03CH01-CB)





Instrument	Brand	Model No.	Serial No.	Characteristics	Calibration Date	Calibration Due Date	Remark
RF Cable-high	Woken	RG402	High Cable-16+17	1 GHz ~ 18 GHz	Oct. 04, 2021	Oct. 03, 2022	Radiation (03CH01-CB)
RF Cable-high	Woken	RG402	High Cable-40G#1	18GHz ~ 40 GHz	Jul. 15, 2021	Jul. 14, 2022	Radiation (03CH01-CB)
RF Cable-high	Woken	RG402	High Cable-40G#2	18GHz ~ 40 GHz	Jul. 15, 2021	Jul. 14, 2022	Radiation (03CH01-CB)
High Cable	Woken	WCA0929M	40G#5+7	1GHz ~ 40 GHz	Dec. 14, 2021	Dec. 13, 2022	Radiation (03CH01-CB)
High Cable	Woken	WCA0929M	40G#5	1GHz ~ 40 GHz	Dec. 08, 2021	Dec. 07, 2022	Radiation (03CH01-CB)
High Cable	Woken	WCA0929M	40G#7	1GHz ~ 40 GHz	Dec. 14, 2021	Dec. 13, 2022	Radiation (03CH01-CB)
Test Software	SPORTON	SENSE	V5.10	-	N.C.R.	N.C.R.	Radiation (03CH01-CB)
Spectrum analyzer	R&S	FSV40	101027	9kHz~40GHz	Aug. 02, 2021	Aug. 01, 2022	Conducted (TH02-CB)
Power Sensor	Anritsu	MA2411B	1126203	300MHz~40GHz	Oct. 25, 2021	Oct. 24, 2022	Conducted (TH02-CB)
Power Meter	Anritsu	ML2495A	1210004	300MHz~40GHz	Oct. 25, 2021	Oct. 24, 2022	Conducted (TH02-CB)
RF Cable-high	Woken	RG402	High Cable-01	1 GHz – 18 GHz	Oct. 04, 2021	Oct. 03, 2022	Conducted (TH02-CB)
RF Cable-high	Woken	RG402	High Cable-02	1 GHz – 18 GHz	Oct. 04, 2021	Oct. 03, 2022	Conducted (TH02-CB)
RF Cable-high	Woken	RG402	High Cable-03	1 GHz – 18 GHz	Oct. 04, 2021	Oct. 03, 2022	Conducted (TH02-CB)
RF Cable-high	Woken	RG402	High Cable-04	1 GHz – 18 GHz	Oct. 04, 2021	Oct. 03, 2022	Conducted (TH02-CB)
RF Cable-high	Woken	RG402	High Cable-05	1 GHz – 18 GHz	Oct. 04, 2021	Oct. 03, 2022	Conducted (TH02-CB)
Switch	SPTCB	SP-SWI	SWI-02	1 GHz –26.5 GHz	Dec. 13, 2021	Dec. 12, 2022	Conducted (TH02-CB)
RF Cable-high	Woken	RG402	SWI-02-P1	1 GHz –26.5 GHz	Dec. 13, 2021	Dec. 12, 2022	Conducted (TH02-CB)
RF Cable-high	Woken	RG402	SWI-02-P2	1 GHz –26.5 GHz	Dec. 13, 2021	Dec. 12, 2022	Conducted (TH02-CB)
RF Cable-high	Woken	RG402	SWI-02-P3	1 GHz –26.5 GHz	Dec. 13, 2021	Dec. 12, 2022	Conducted (TH02-CB)
RF Cable-high	Woken	RG402	SWI-02-P4	1 GHz –26.5 GHz	Dec. 13, 2021	Dec. 12, 2022	Conducted (TH02-CB)
RF Cable-high	Woken	RG402	SWI-02-P5	1 GHz –26.5 GHz	Dec. 13, 2021	Dec. 12, 2022	Conducted (TH02-CB)
Test Software	SPORTON	SENSE	V5.10	-	N.C.R.	N.C.R.	Conducted (TH02-CB)

Note: Calibration Interval of instruments listed above is one year.

N.C.R. means Non-Calibration required.



**Summary**

Mode	Result	Type	Freq (Hz)	Level (dBuV)	Limit (dBuV)	Margin (dB)	Condition
Mode 6	Pass	AV	591k	39.11	46.00	-6.89	Neutral

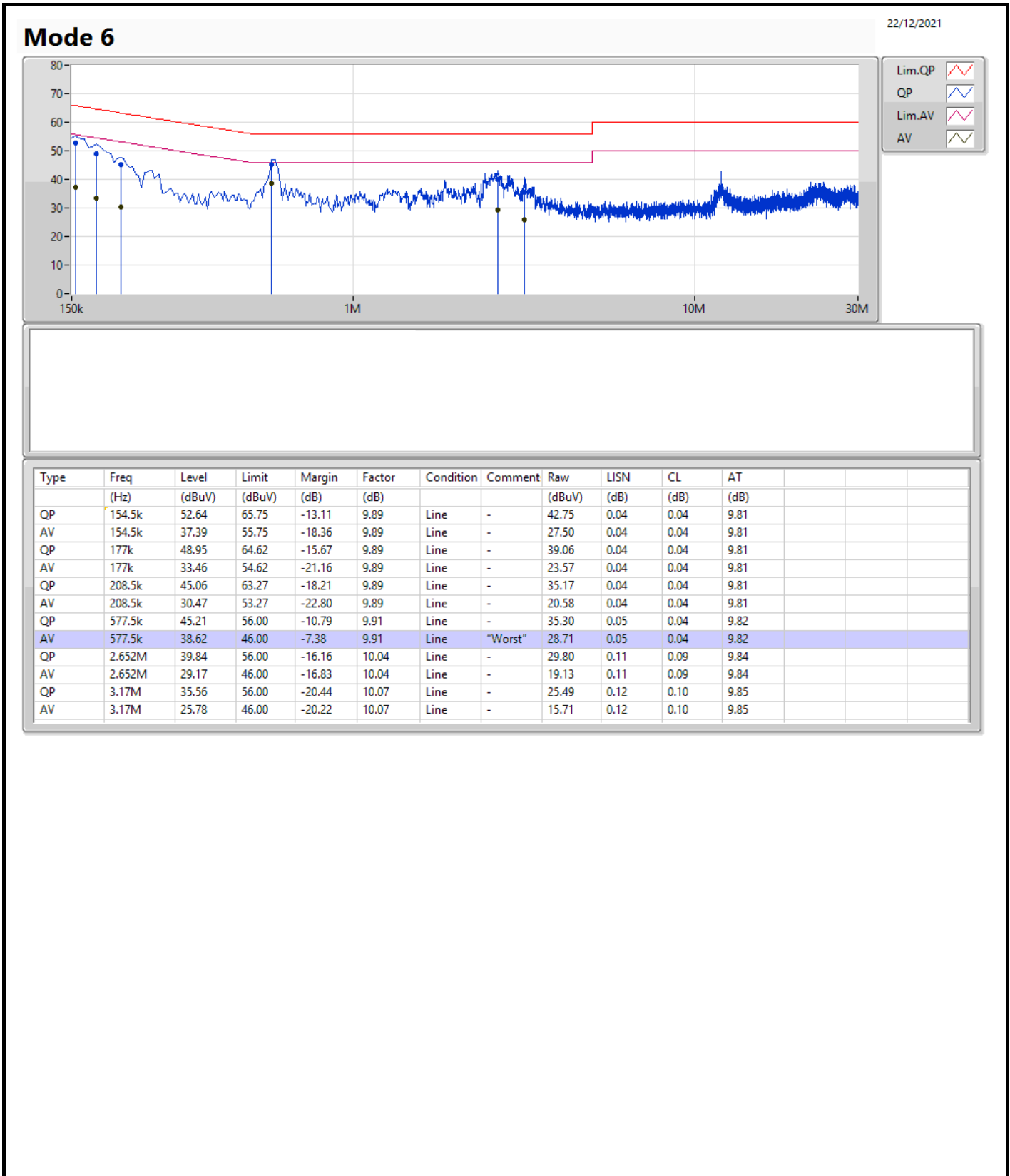

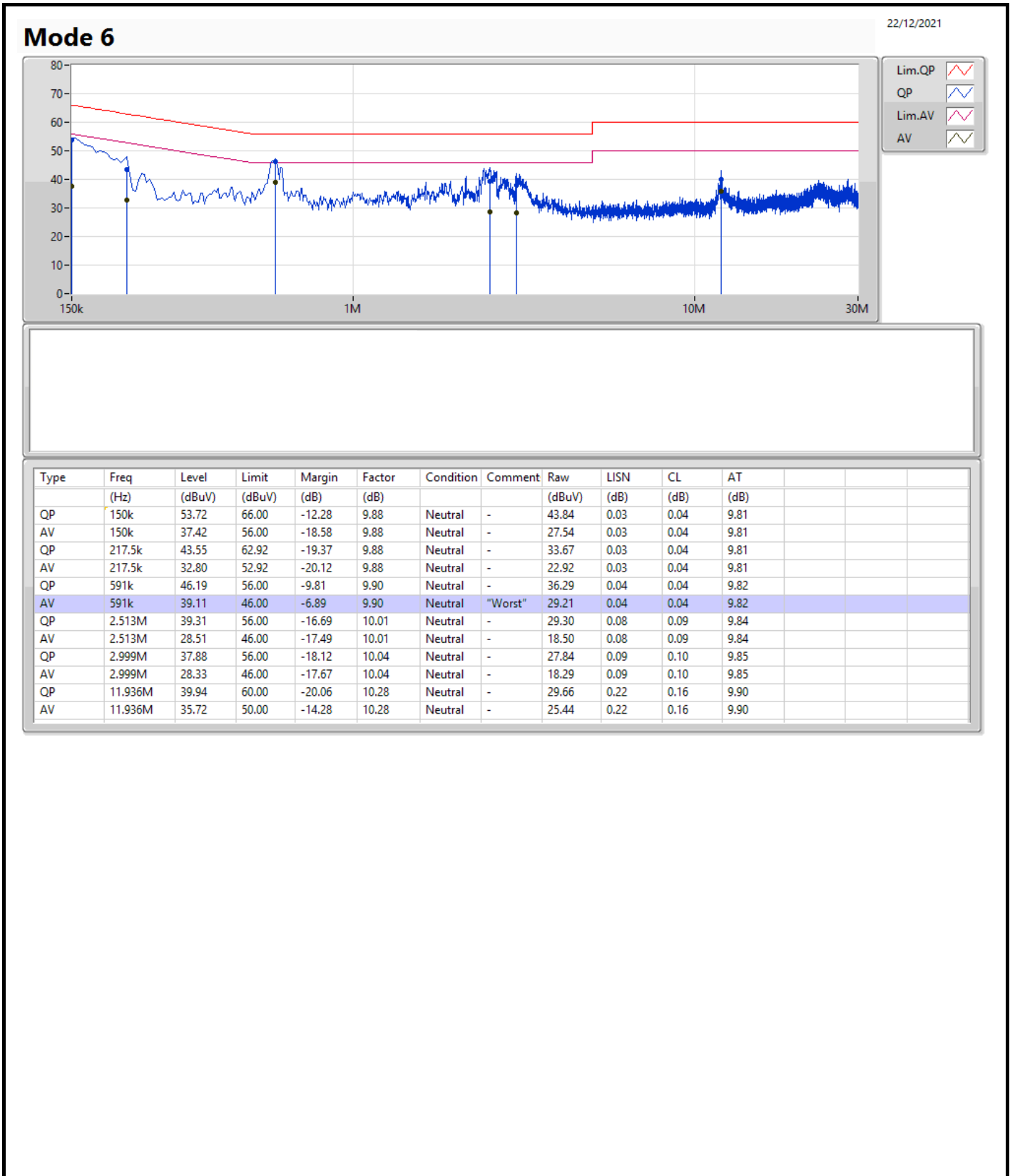



Summary

Mode	Max-N dB (Hz)	Max-OBW (Hz)	ITU-Code	Min-N dB (Hz)	Min-OBW (Hz)
2.4-2.4835GHz	-	-	-	-	-
BT-LE(1Mbps)	716.25k	1.059M	1M06F1D	662.5k	1.034M
BT-LE(2Mbps)	1.178M	2.061M	2M06F1D	1.16M	2.041M

Max-N dB = Maximum 6dB down bandwidth; Max-OBW = Maximum 99% occupied bandwidth;  
Min-N dB = Minimum 6dB down bandwidth; Min-OBW = Minimum 99% occupied bandwidth



Result

Mode	Result	Limit (Hz)	Port 1-N dB (Hz)	Port 1-OBW (Hz)
BT-LE(1Mbps)	-	-	-	-
2402MHz	Pass	500k	662.5k	1.034M
2440MHz	Pass	500k	716.25k	1.059M
2480MHz	Pass	500k	663.75k	1.037M
BT-LE(2Mbps)	-	-	-	-
2402MHz	Pass	500k	1.16M	2.041M
2440MHz	Pass	500k	1.178M	2.061M
2480MHz	Pass	500k	1.165M	2.051M

Port X-N dB = Port X 6dB down bandwidth;  
Port X-OBW = Port X 99% occupied bandwidth

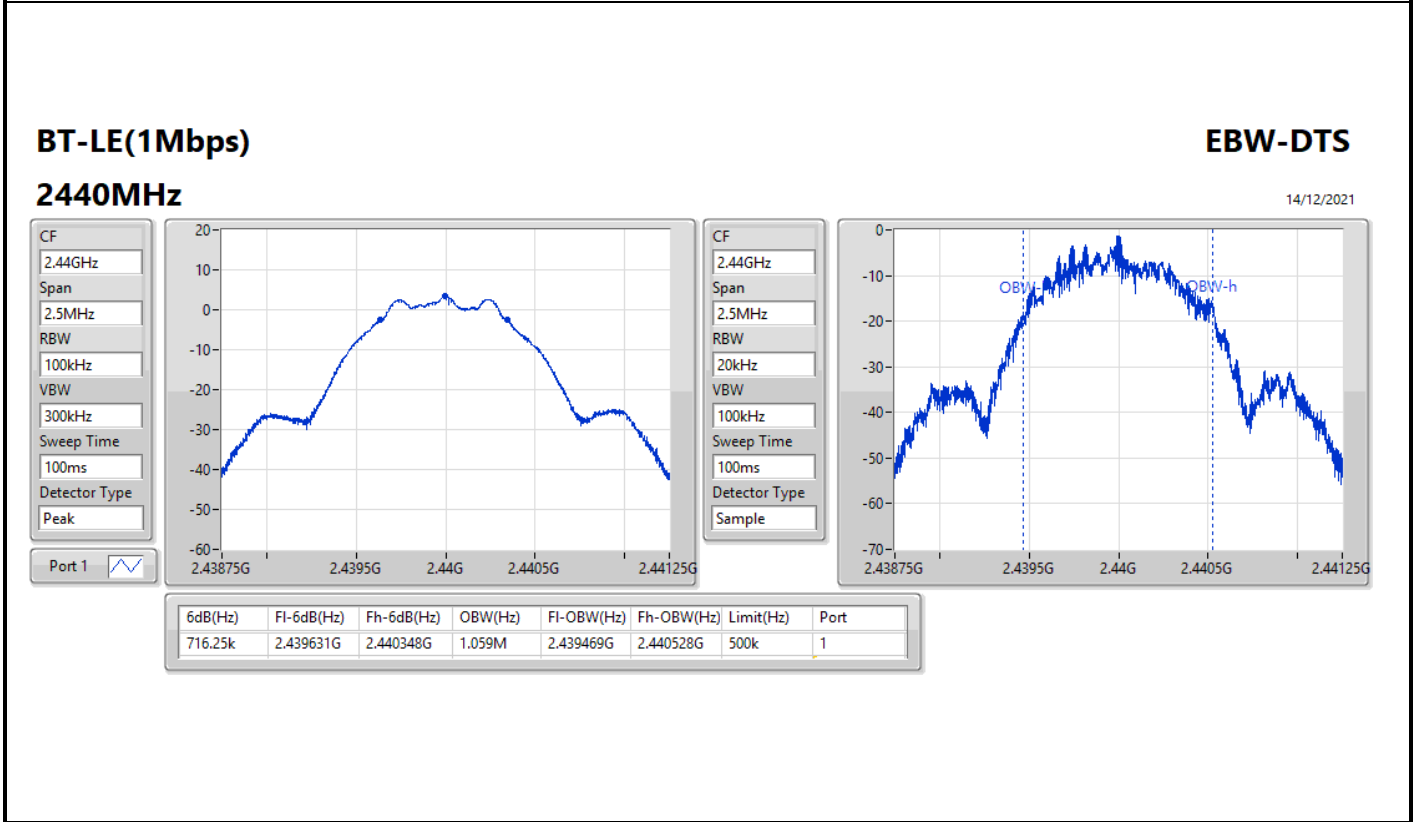
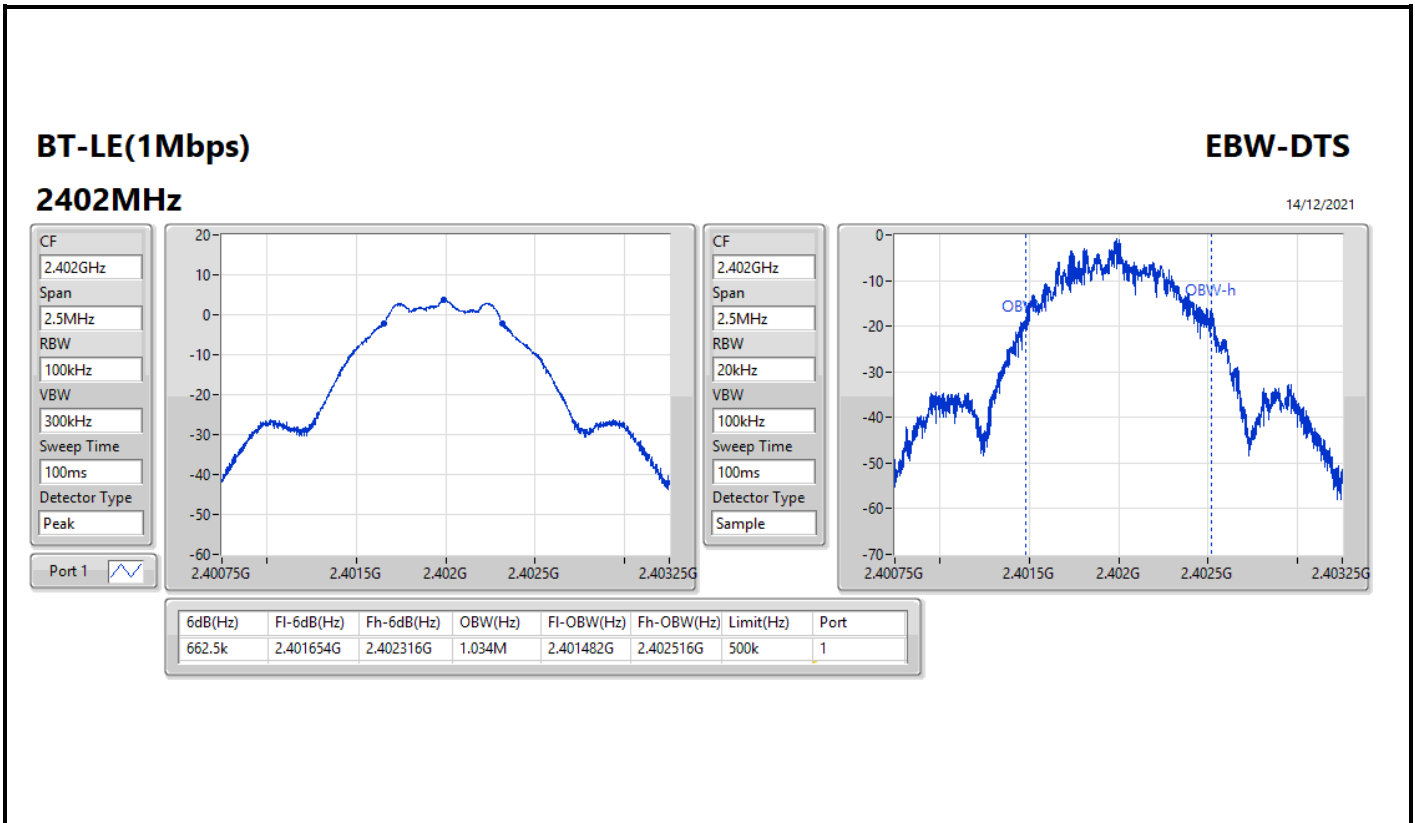

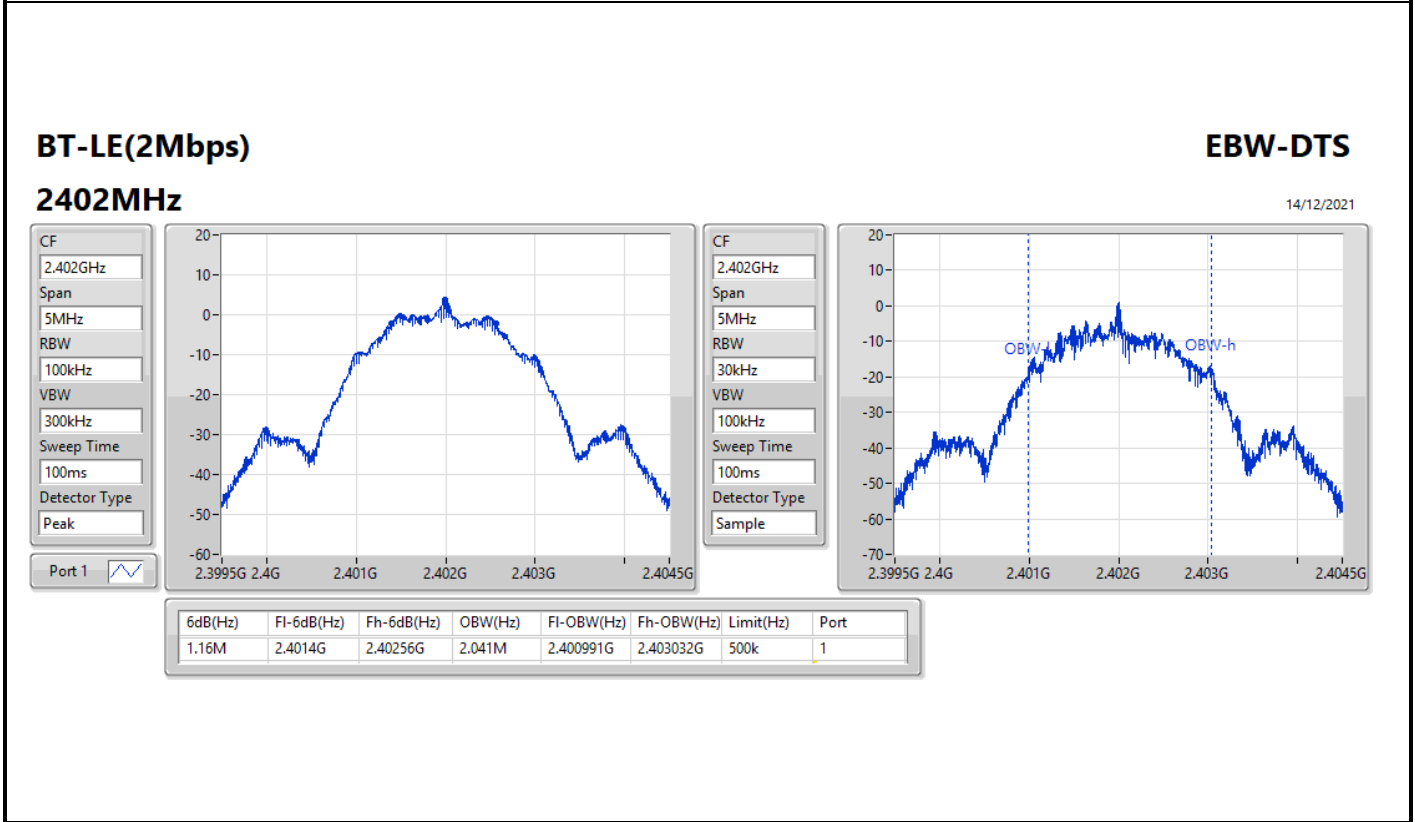
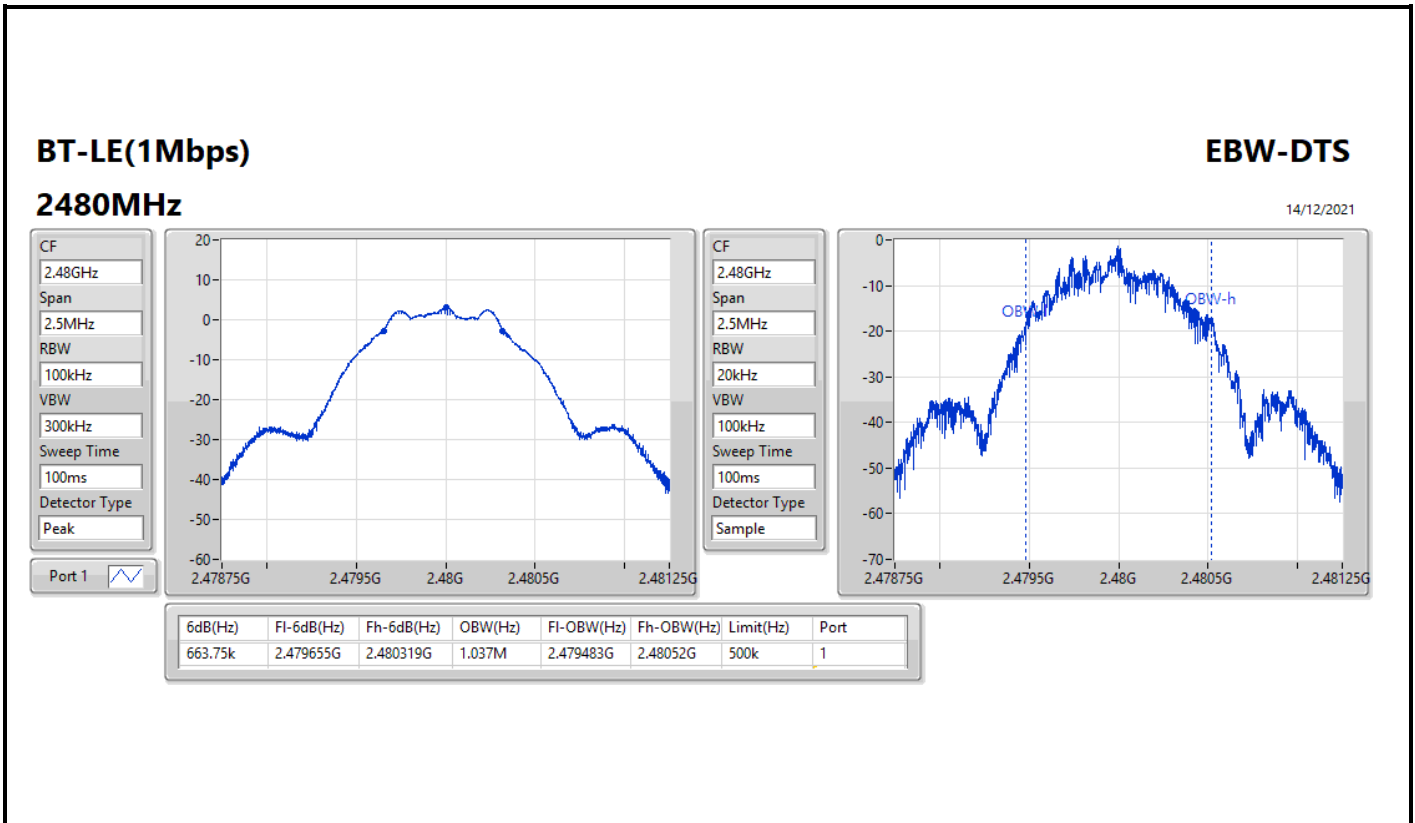



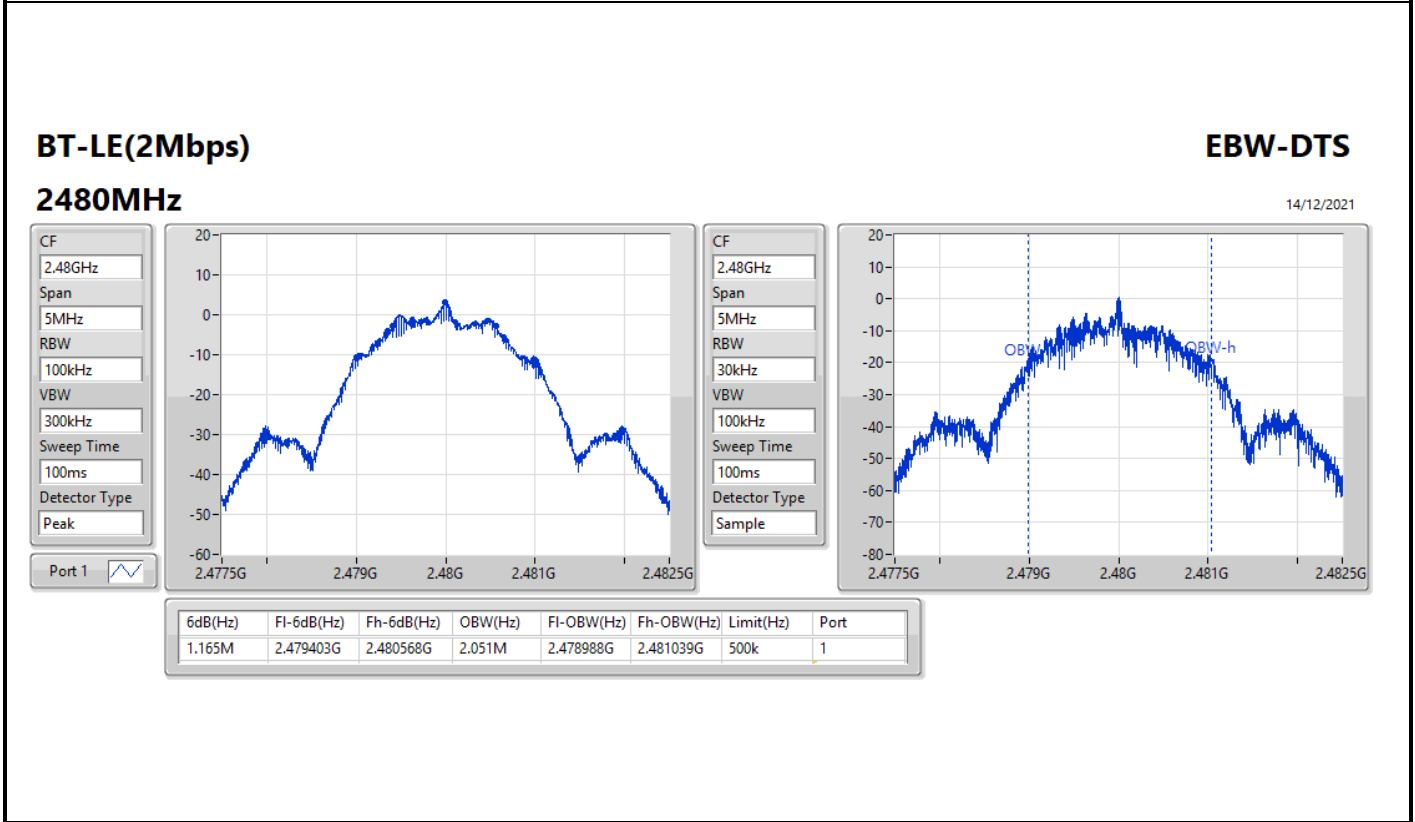
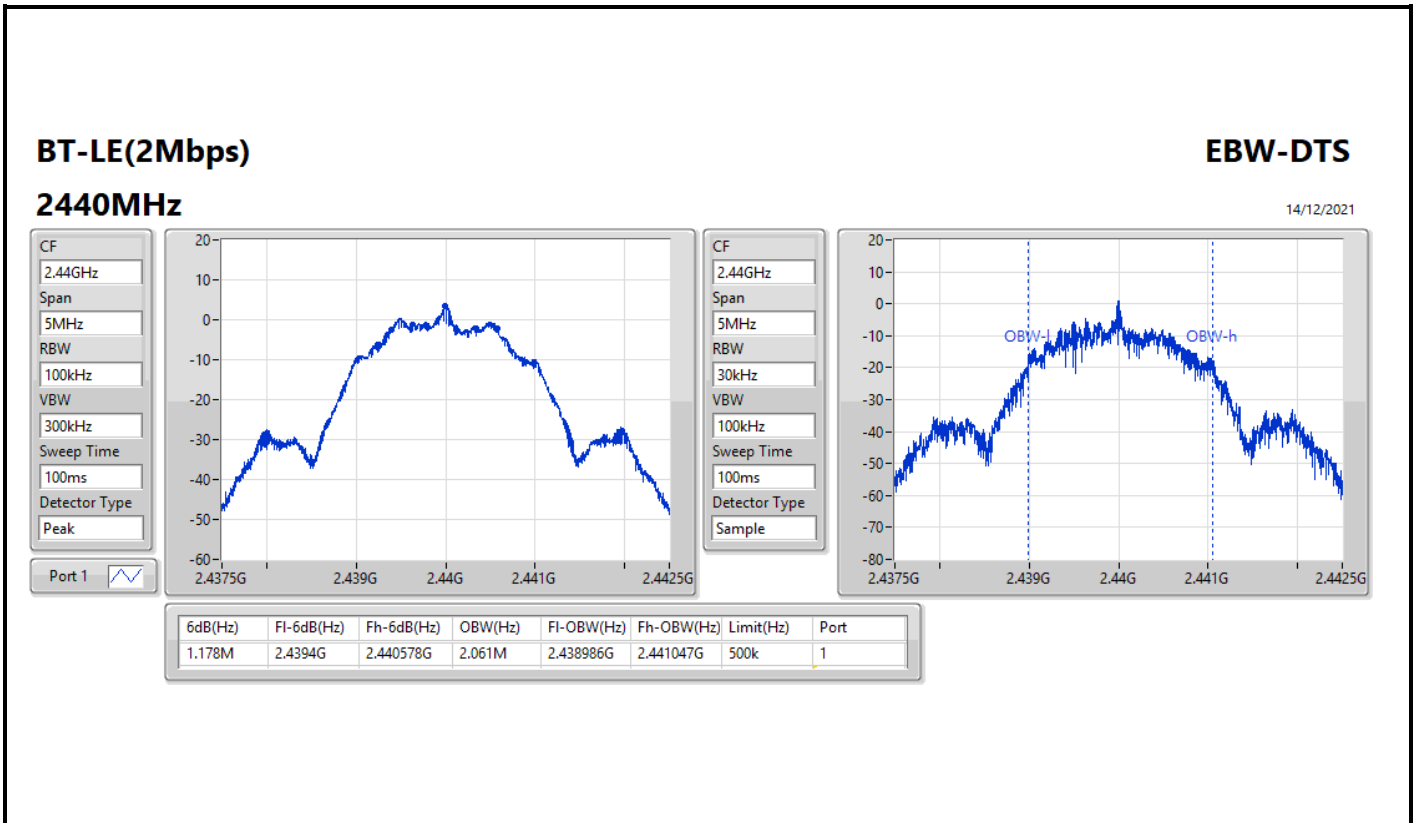



**Summary**

Mode	Power (dBm)	Power (W)
2.4-2.4835GHz	-	-
BT-LE(1Mbps)	3.25	0.00211
BT-LE(2Mbps)	3.15	0.00207



Result

Mode	Result	Gain (dBi)	Power (dBm)	Power Limit (dBm)
BT-LE(1Mbps)	-	-	-	-
2402MHz	Pass	4.20	3.25	30.00
2440MHz	Pass	4.20	2.53	30.00
2480MHz	Pass	4.20	2.52	30.00
BT-LE(2Mbps)	-	-	-	-
2402MHz	Pass	4.20	3.15	30.00
2440MHz	Pass	4.20	2.65	30.00
2480MHz	Pass	4.20	2.31	30.00

DG = Directional Gain; Port X = Port X output power



Summary

Mode	PD (dBm/RBW)
2.4-2.4835GHz	-
BT-LE(1Mbps)	-11.86
BT-LE(2Mbps)	-14.43

RBW = 3kHz;



Result

Mode	Result	Gain (dBi)	PD (dBm/RBW)	PD Limit (dBm/RBW)
BT-LE(1Mbps)	-	-	-	-
2402MHz	Pass	4.20	-11.86	8.00
2440MHz	Pass	4.20	-12.78	8.00
2480MHz	Pass	4.20	-12.81	8.00
BT-LE(2Mbps)	-	-	-	-
2402MHz	Pass	4.20	-14.43	8.00
2440MHz	Pass	4.20	-15.18	8.00
2480MHz	Pass	4.20	-15.02	8.00

DG = Directional Gain; RBW = 3kHz;  
PD = trace bin-by-bin of each transmits port summing can be performed maximum power density; Port X = Port X Power Density;

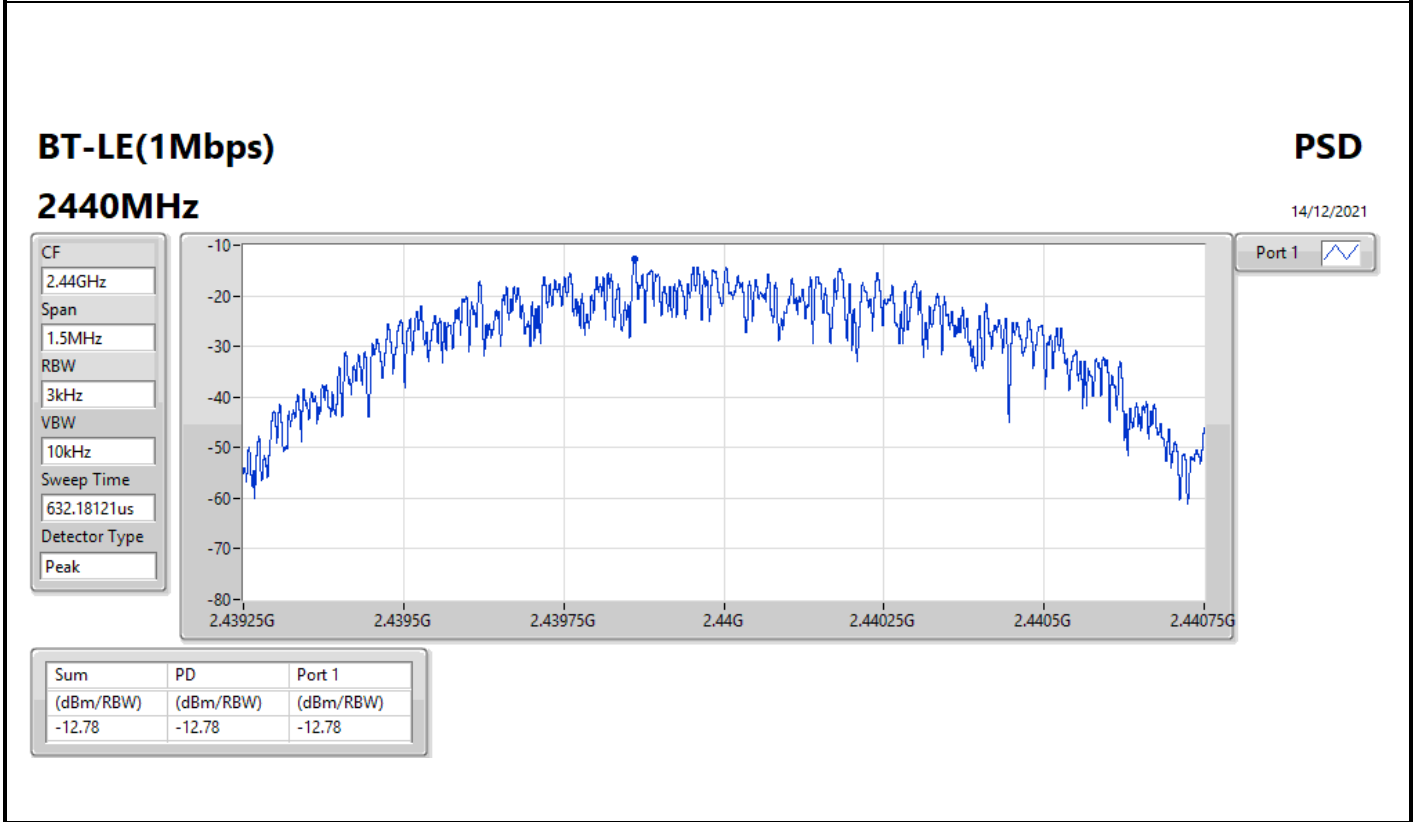
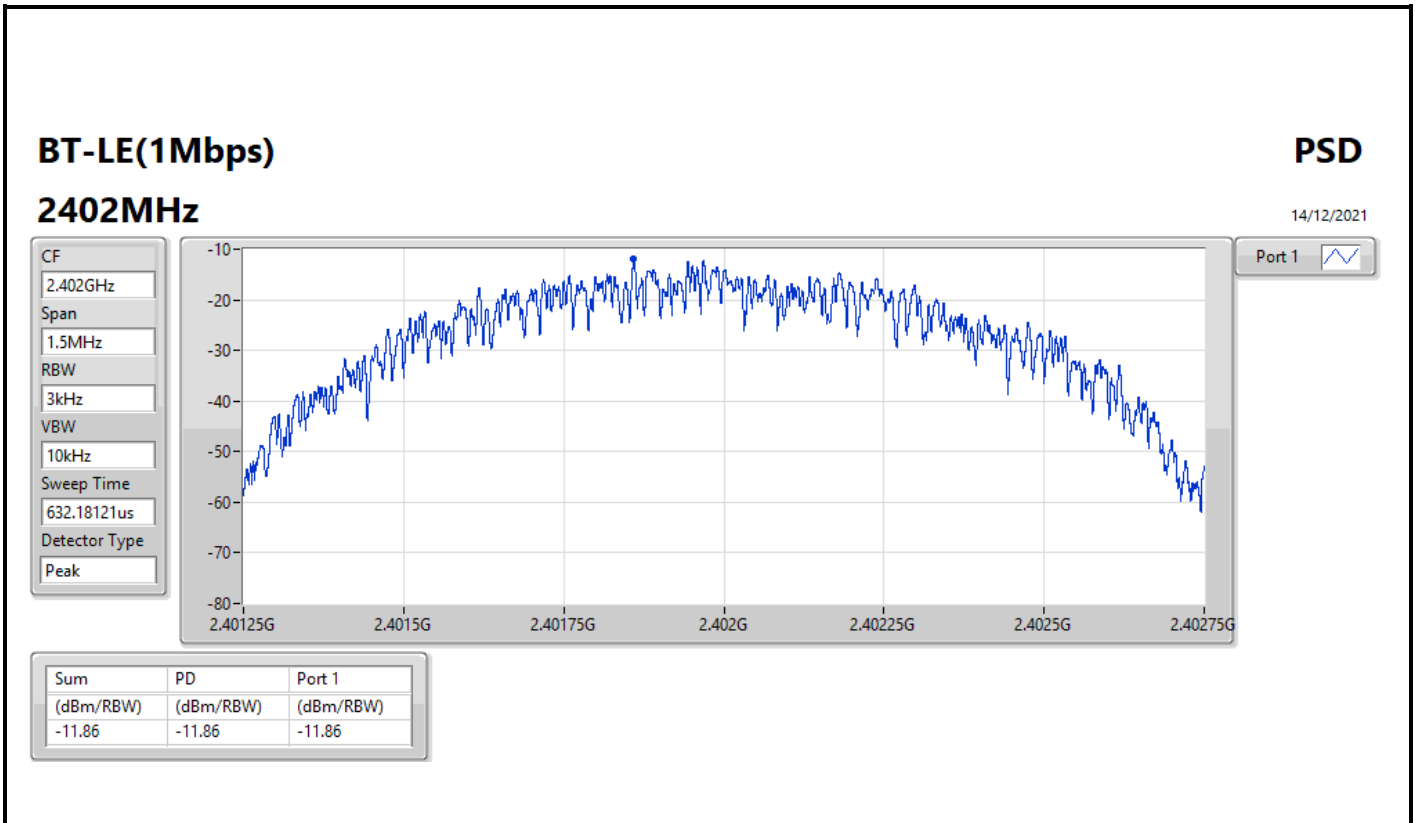

### BT-LE(1Mbps)

### PSD

2480MHz

14/12/2021

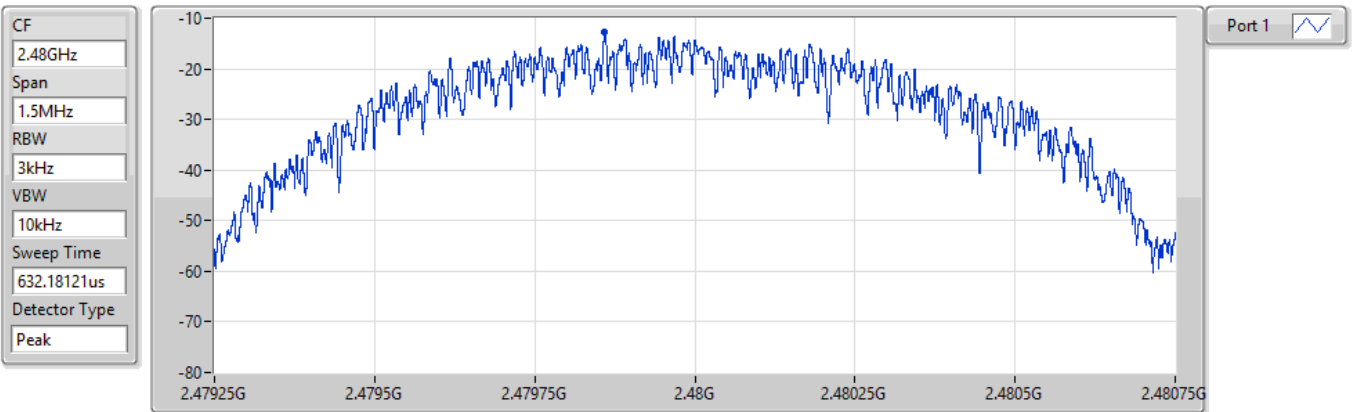

Sum	PD	Port 1
(dBm/RBW)	(dBm/RBW)	(dBm/RBW)
-12.81	-12.81	-12.81

### BT-LE(2Mbps)

### PSD

2402MHz

14/12/2021

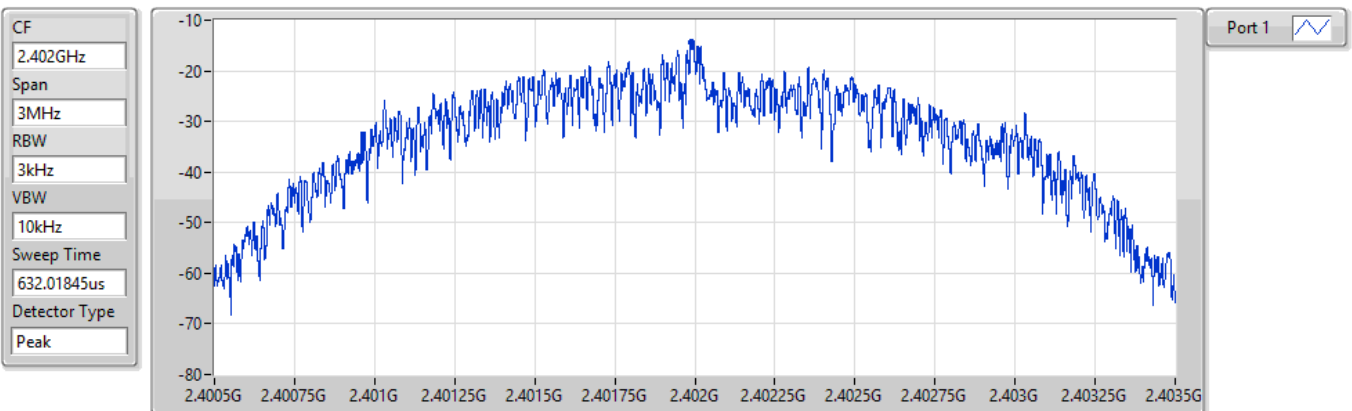

Sum	PD	Port 1
(dBm/RBW)	(dBm/RBW)	(dBm/RBW)
-14.43	-14.43	-14.43

**BT-LE(2Mbps)**

**PSD**

**2440MHz**

14/12/2021

CF  
2.44GHz

Span  
3MHz

RBW  
3kHz

VBW  
10kHz

Sweep Time  
632.01845us

Detector Type  
Peak

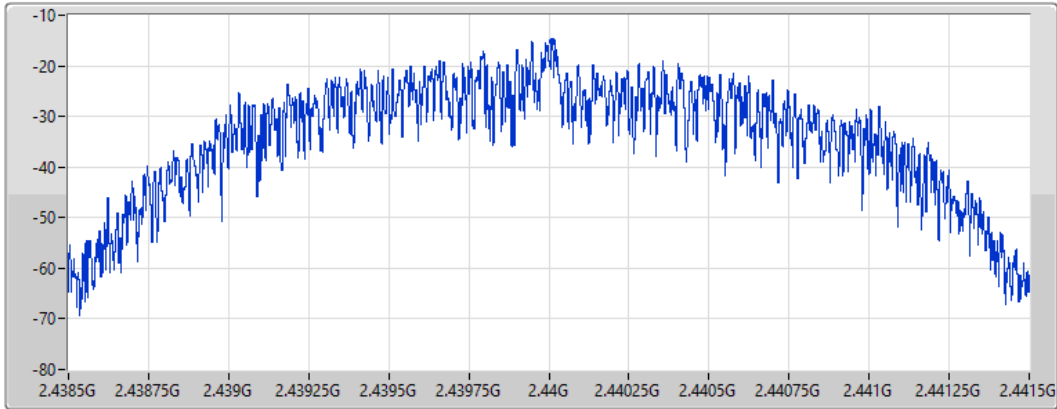

Port 1 

Sum	PD	Port 1
(dBm/RBW)	(dBm/RBW)	(dBm/RBW)
-15.18	-15.18	-15.18

**BT-LE(2Mbps)**

**PSD**

**2480MHz**

14/12/2021

CF  
2.48GHz

Span  
3MHz

RBW  
3kHz

VBW  
10kHz

Sweep Time  
632.01845us

Detector Type  
Peak

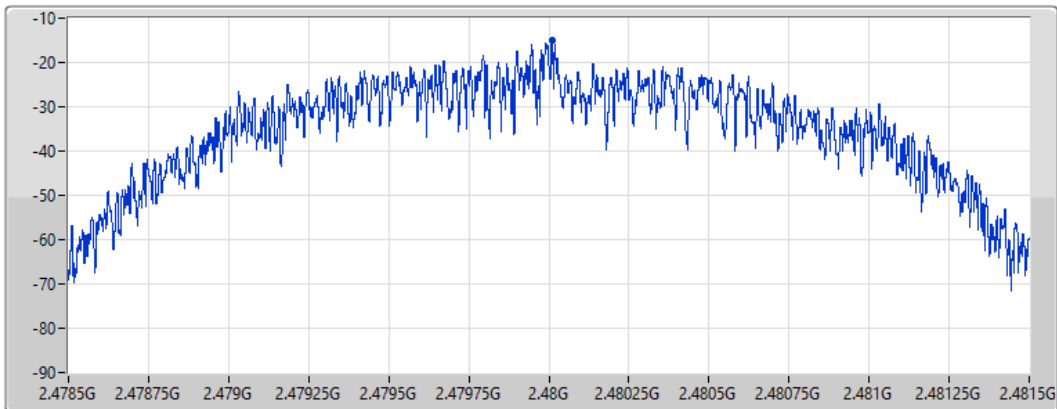

Port 1 

Sum	PD	Port 1
(dBm/RBW)	(dBm/RBW)	(dBm/RBW)
-15.02	-15.02	-15.02





Summary

Mode	Result	Ref (Hz)	Ref (dBm)	Limit (dBm)	Freq (Hz)	Level (dBm)	Freq (Hz)	Level (dBm)	Freq (Hz)	Level (dBm)	Freq (Hz)	Level (dBm)	Freq (Hz)	Level (dBm)	Port
2.4-2.4835GHz	-	-	-	-	-	-	-	-	-	-	-	-	-	-	-
BT-LE(1Mbps)	Pass	2.40196G	3.44	-26.56	751.74M	-52.08	2.39998G	-44.96	2.4G	-44.06	2.49229G	-51.69	15.16903G	-46.40	1
BT-LE(2Mbps)	Pass	2.40196G	3.69	-26.31	2.07127G	-53.09	2.4G	-28.19	2.4G	-29.19	2.50316G	-51.54	24.44602G	-45.17	1



Result

Mode	Result	Ref (Hz)	Ref (dBm)	Limit (dBm)	Freq (Hz)	Level (dBm)	Freq (Hz)	Level (dBm)	Freq (Hz)	Level (dBm)	Freq (Hz)	Level (dBm)	Freq (Hz)	Level (dBm)	Port
BT-LE(1Mbps)	-	-	-	-	-	-	-	-	-	-	-	-	-	-	-
2402MHz	Pass	2.40196G	3.44	-26.56	751.74M	-52.08	2.39998G	-44.96	2.4G	-44.06	2.49229G	-51.69	15.16903G	-46.40	1
2440MHz	Pass	2.40196G	3.44	-26.56	539.36M	-52.91	2.39048G	-52.21	2.4835G	-54.35	2.49437G	-51.44	15.19434G	-45.71	1
2480MHz	Pass	2.40196G	3.44	-26.56	2.04043G	-52.98	2.39207G	-52.36	2.4835G	-55.16	2.48812G	-51.76	15.16903G	-45.96	1
BT-LE(2Mbps)	-	-	-	-	-	-	-	-	-	-	-	-	-	-	-
2402MHz	Pass	2.40196G	3.69	-26.31	2.07127G	-53.09	2.4G	-28.19	2.4G	-29.19	2.50316G	-51.54	24.44602G	-45.17	1
2440MHz	Pass	2.40196G	3.69	-26.31	937.69M	-52.90	2.39578G	-52.46	2.4G	-54.55	2.49994G	-51.62	15.19715G	-45.75	1
2480MHz	Pass	2.40196G	3.69	-26.31	737.35M	-52.09	2.39238G	-52.79	2.4835G	-54.26	2.48593G	-50.63	6.78908G	-45.81	1

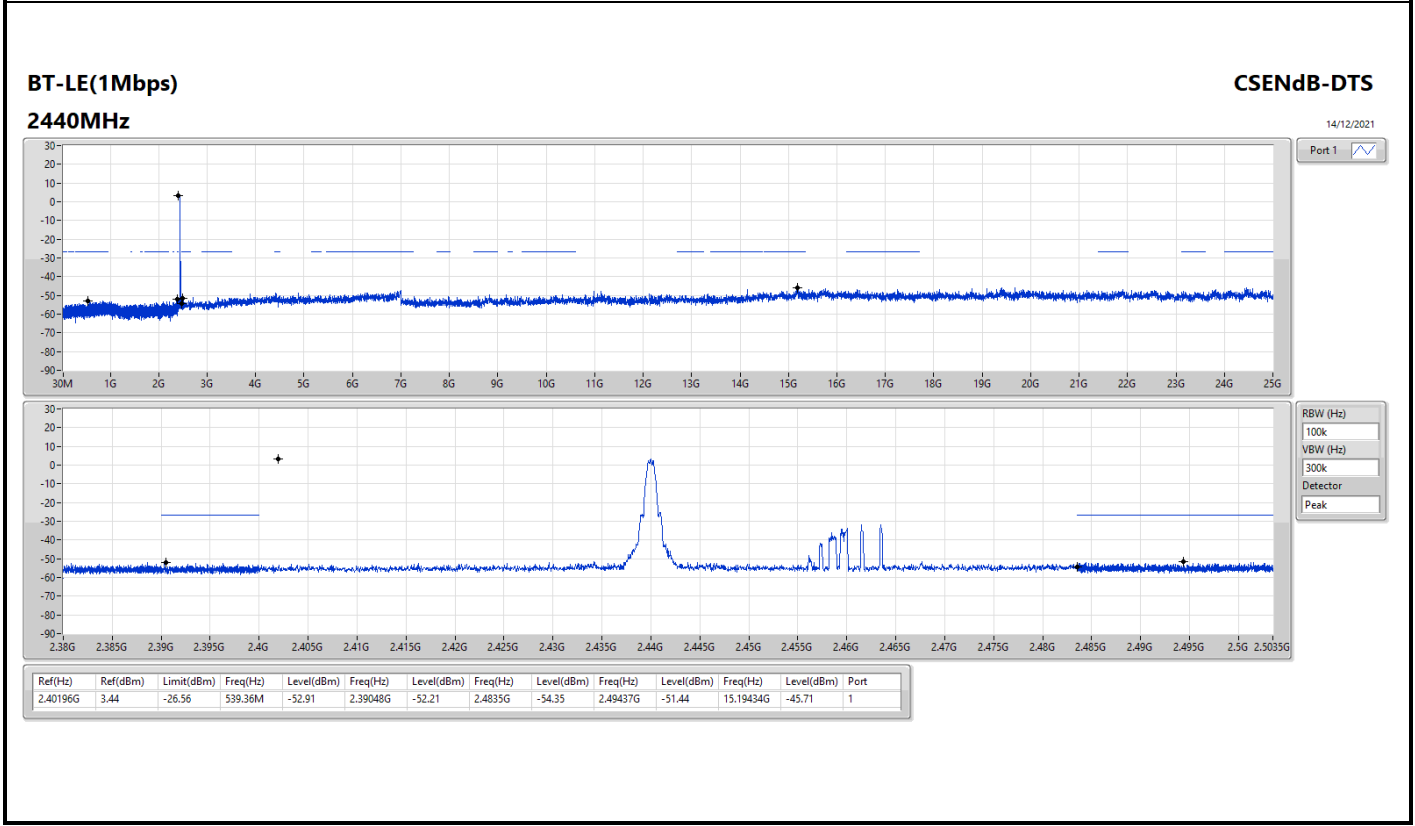
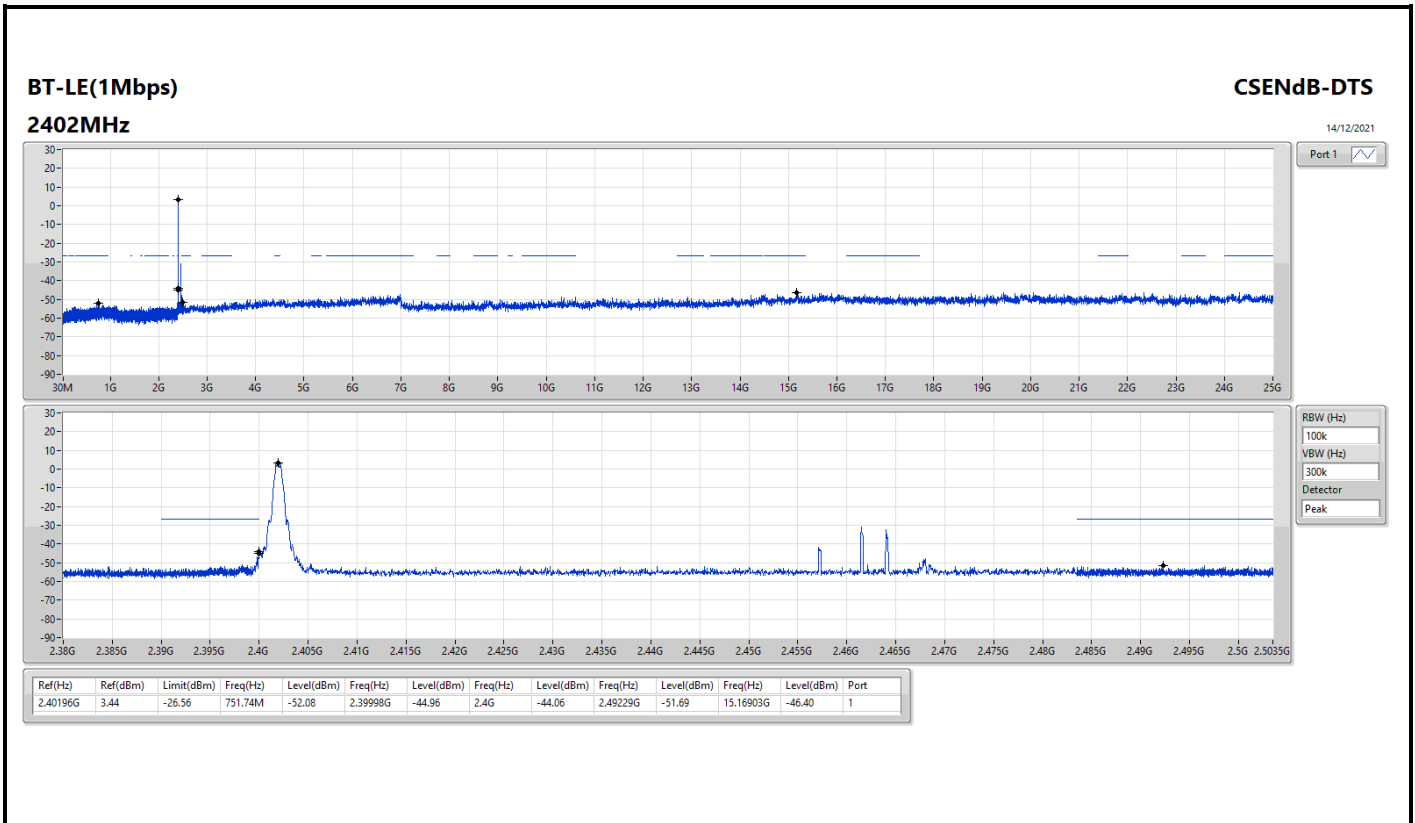

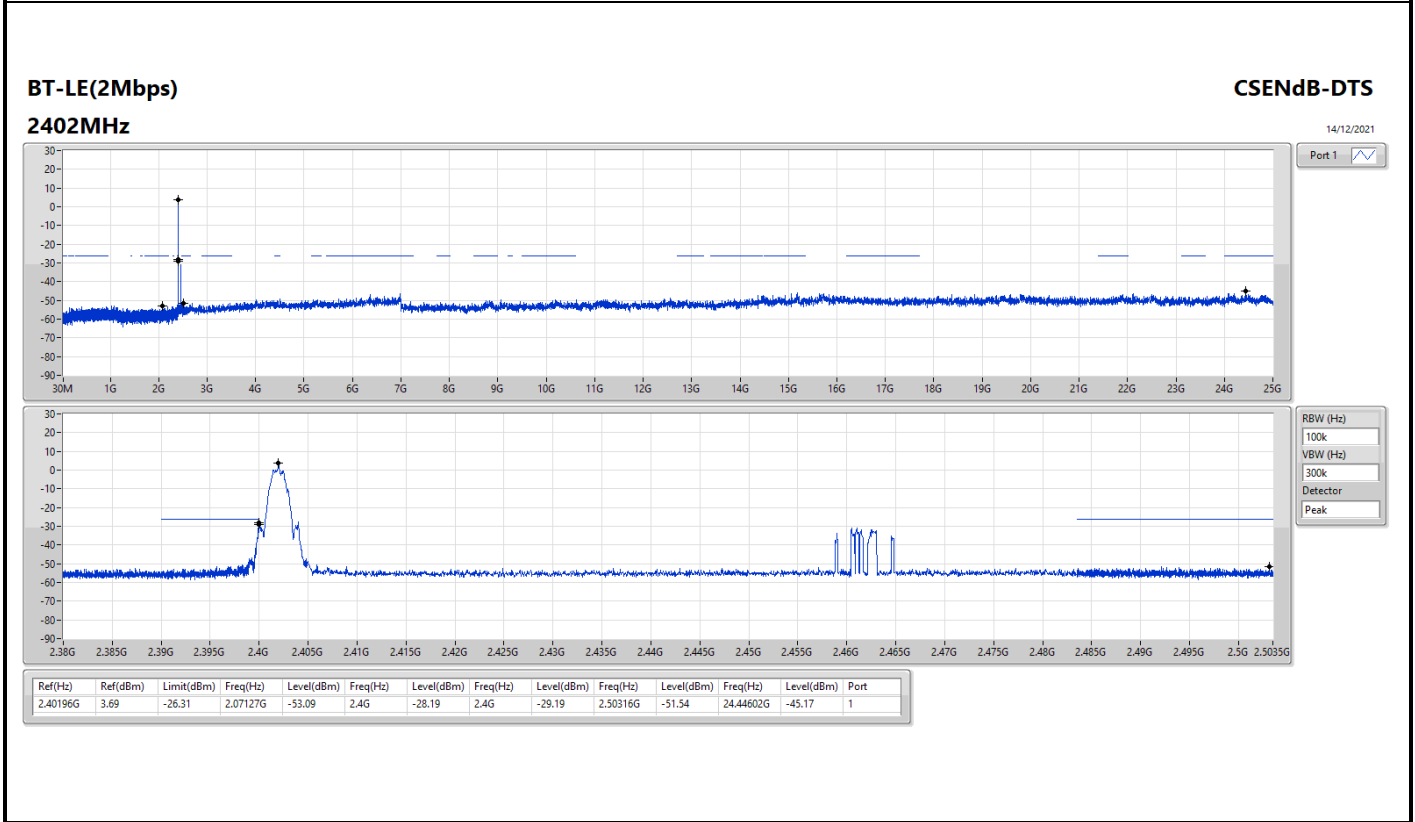
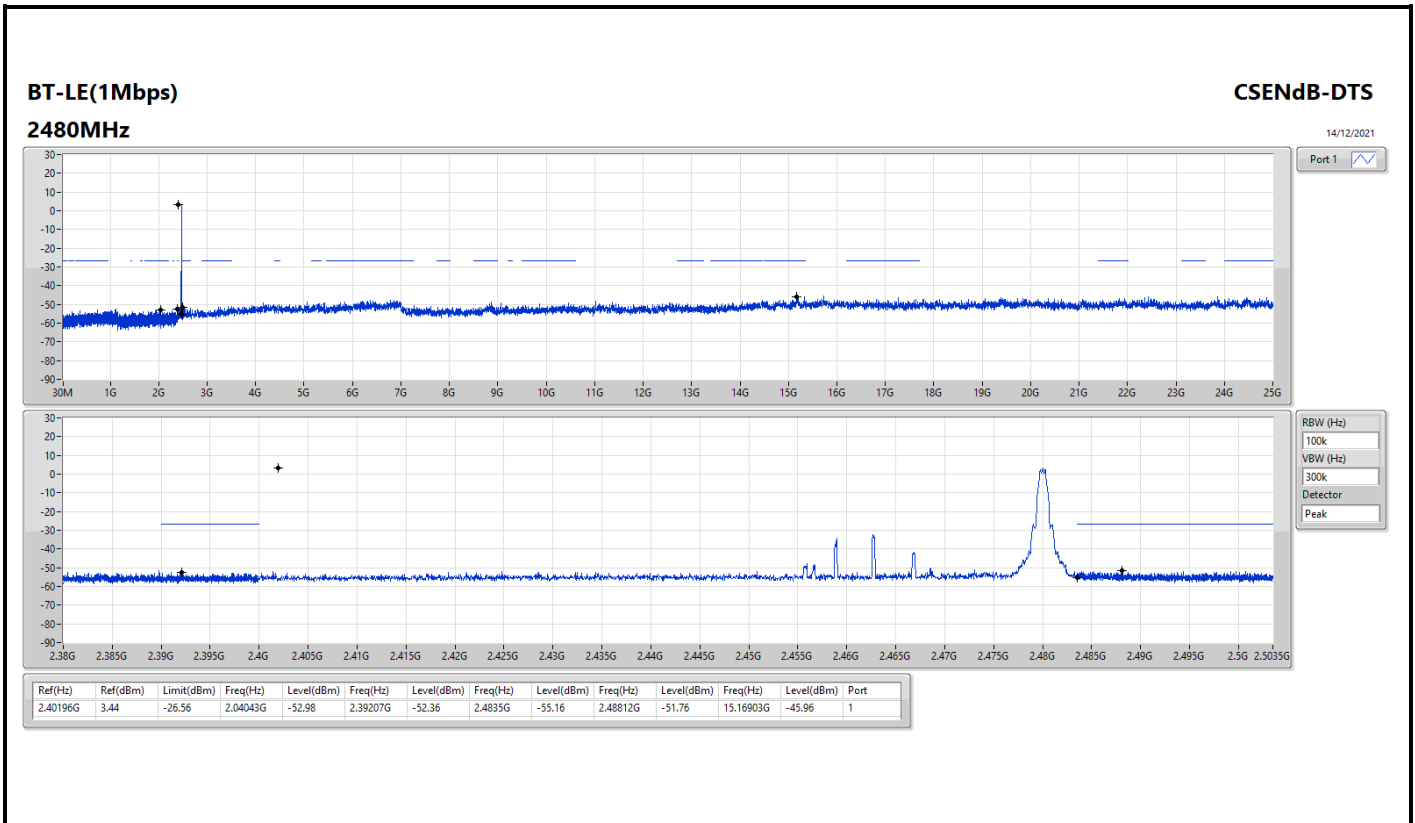

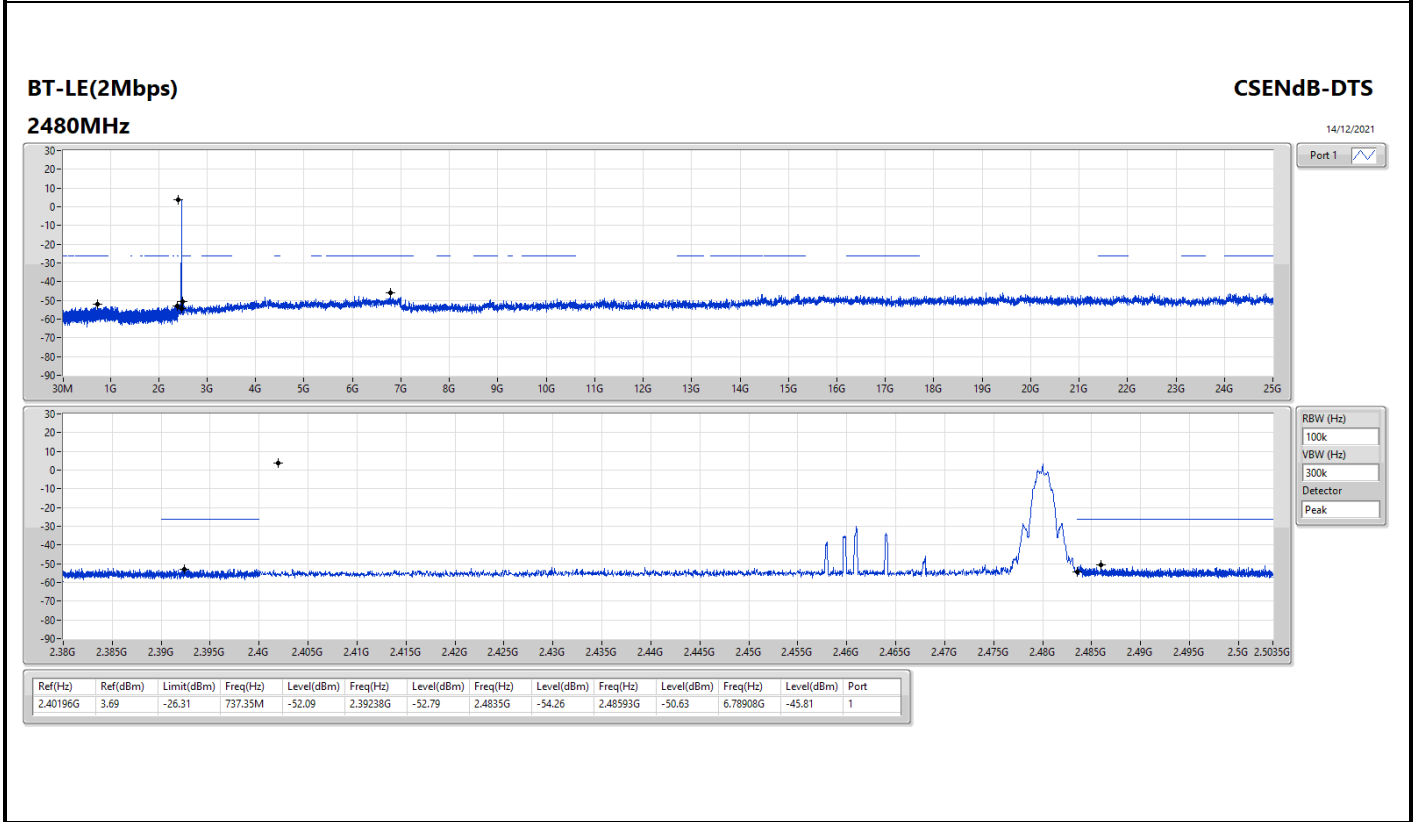
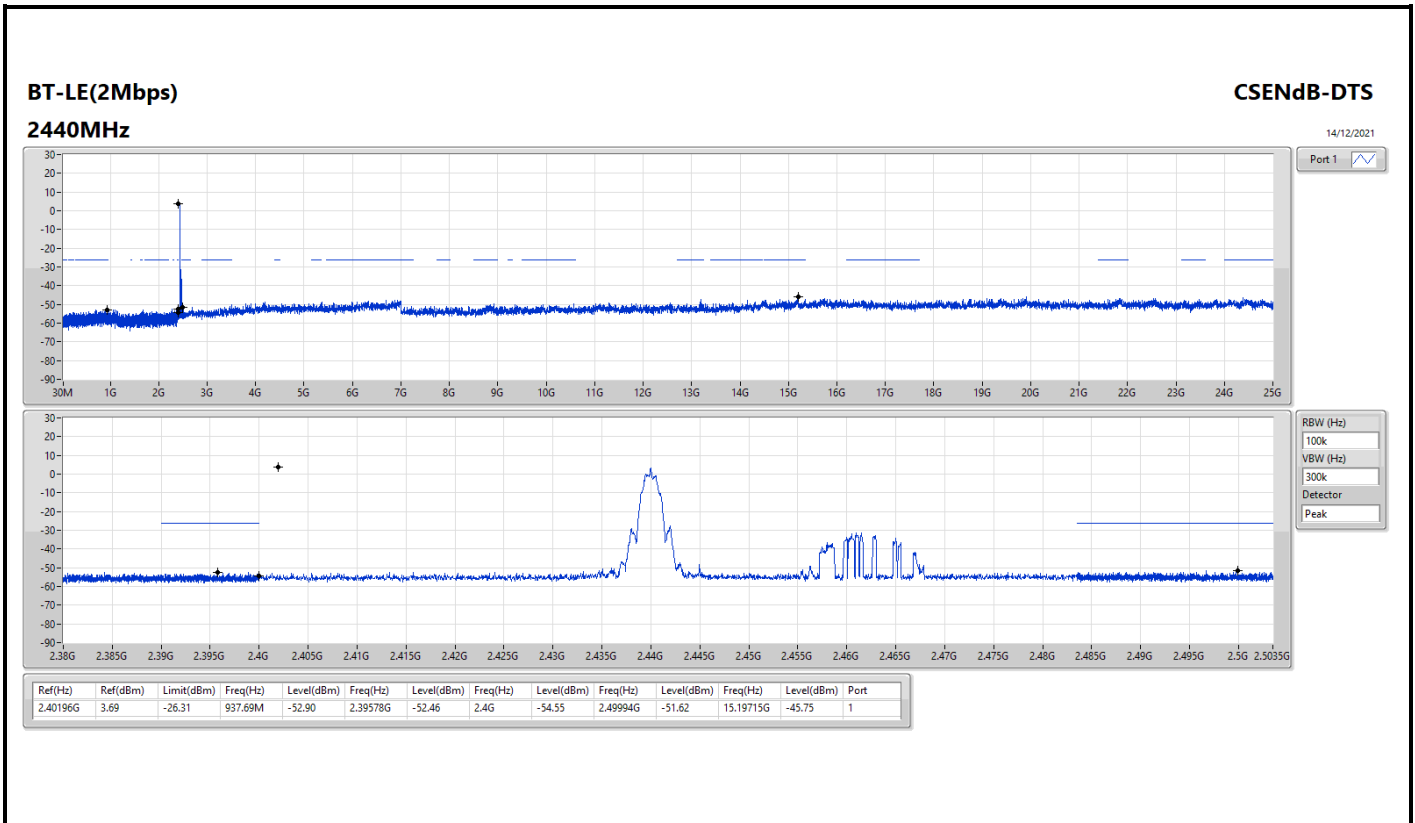



**Summary**

Mode	Result	Type	Freq (Hz)	Level (dBuV/m)	Limit (dBuV/m)	Margin (dB)	Condition
Mode 4	Pass	PK	53.28M	35.16	40.00	-4.84	Vertical

Mode 4

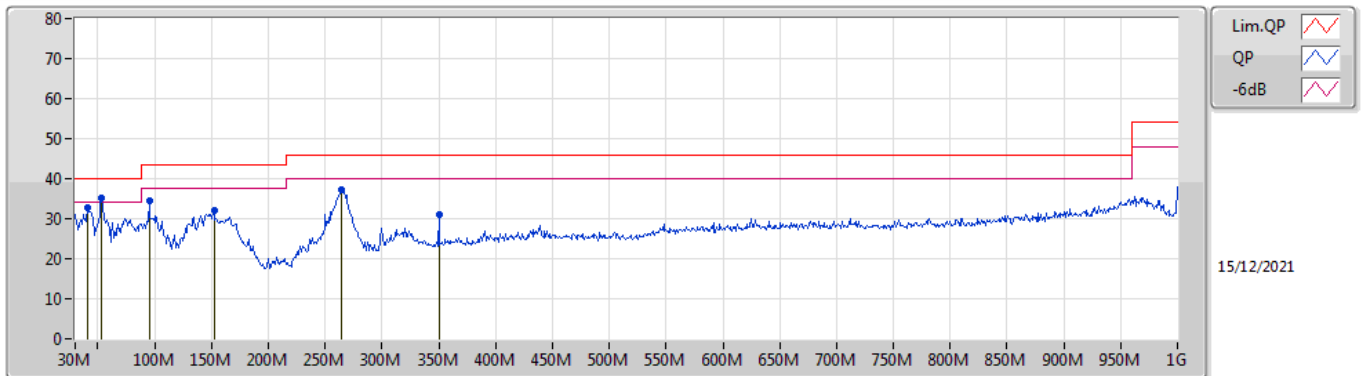

Type	Freq (Hz)	Level (dBuV/m)	Limit (dBuV/m)	Margin (dB)	Factor (dB)	Dist (m)	Condition	Azimuth (°)	Height (m)	Comment	Raw (dBuV)	AF (dB)	CL (dB)	PA (dB)
PK	40.67M	32.91	40.00	-7.09	-12.32	3	Vertical	227	1.25	-	45.23	18.44	0.91	31.67
PK	53.28M	35.16	40.00	-4.84	-17.82	3	Vertical	244	1.25	"Worst"	52.98	12.87	1.10	31.79
PK	94.99M	34.40	43.50	-9.10	-14.70	3	Vertical	360	1.25	-	49.10	15.79	1.40	31.89
PK	152.22M	32.07	43.50	-11.43	-13.92	3	Vertical	204	1.00	-	45.99	16.12	1.92	31.96
PK	264.74M	37.19	46.00	-8.81	-10.40	3	Vertical	21	1.00	-	47.59	19.07	2.56	32.03
PK	350.1M	31.15	46.00	-14.85	-8.83	3	Vertical	180	1.50	-	39.98	20.28	3.00	32.11

Mode 4

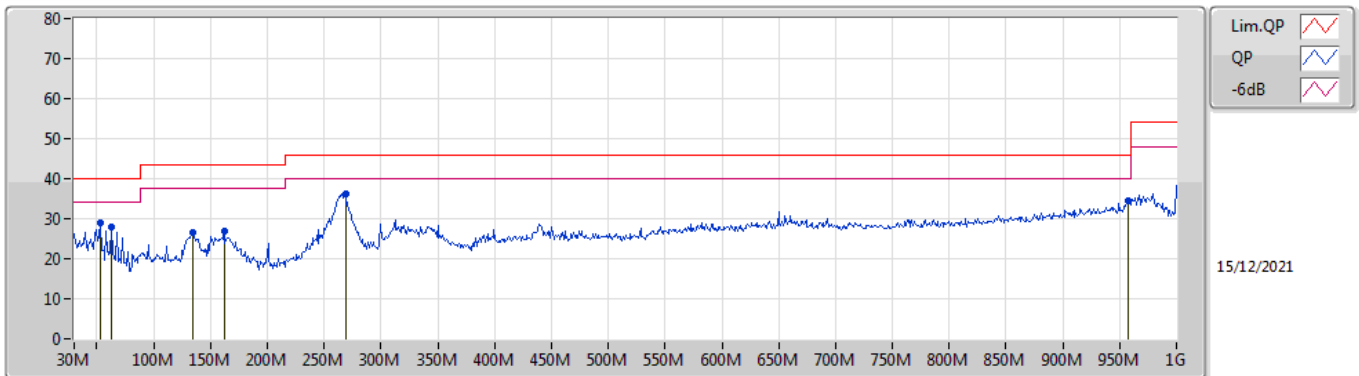

Type	Freq (Hz)	Level (dBuV/m)	Limit (dBuV/m)	Margin (dB)	Factor (dB)	Dist (m)	Condition	Azimuth (°)	Height (m)	Comment	Raw (dBuV)	AF (dB)	CL (dB)	PA (dB)
PK	53.28M	28.83	40.00	-11.17	-17.82	3	Horizontal	5	1.50	-	46.65	12.87	1.10	31.79
PK	62.98M	27.78	40.00	-12.22	-18.53	3	Horizontal	296	2.00	-	46.31	12.13	1.20	31.86
PK	134.76M	26.57	43.50	-16.93	-12.87	3	Horizontal	182	2.00	-	39.44	17.33	1.75	31.95
PK	161.92M	26.85	43.50	-16.65	-14.35	3	Horizontal	191	1.25	-	41.20	15.60	2.01	31.96
PK	268.62M	36.24	46.00	-9.76	-10.76	3	Horizontal	188	1.00	"Worst"	47.00	18.71	2.57	32.04
PK	957.32M	34.37	46.00	-11.63	-0.41	3	Horizontal	360	2.00	-	34.78	26.56	5.60	32.57





Summary

Mode	Result	Type	Freq (Hz)	Level (dBuV/m)	Limit (dBuV/m)	Margin (dB)	Dist (m)	Condition	Azimuth (°)	Height (m)	Comments
2.4-2.4835GHz	-	-	-	-	-	-	-	-	-	-	-
BT-LE(2Mbps)	Pass	AV	2.4835G	50.95	54.00	-3.05	3	Horizontal	51	2.07	-

**BT-LE(1Mbps)**

**2402MHz\_TX**

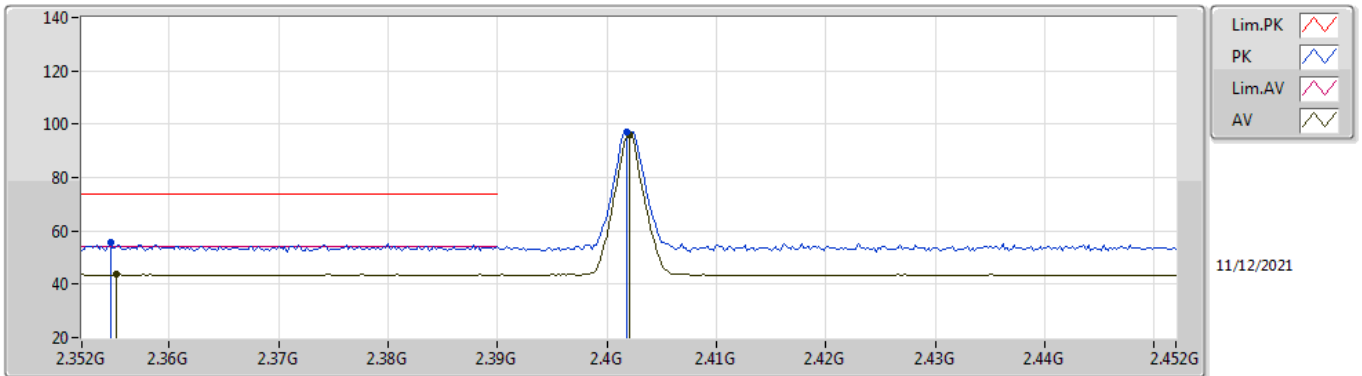

EUT\_Y\_1TX  
Setting OE  
01-A-R-5

Type	Freq (Hz)	Level (dBuV/m)	Limit (dBuV/m)	Margin (dB)	Raw (dBuV)	Dist (m)	Condition	Azimuth (°)	Height (m)	Comment	AF (dB)	CL (dB)	PA (dB)
PK	2.3546G	55.89	74.00	-18.11	24.40	3	Vertical	23	3.00	-	27.69	3.80	-
AV	2.3552G	43.71	54.00	-10.29	12.22	3	Vertical	23	3.00	-	27.69	3.80	-
PK	2.4018G	97.24	Inf	-Inf	65.84	3	Vertical	23	3.00	-	27.60	3.80	-
AV	2.402G	95.82	Inf	-Inf	64.42	3	Vertical	23	3.00	-	27.60	3.80	-

**BT-LE(1Mbps)**

**2402MHz\_TX**

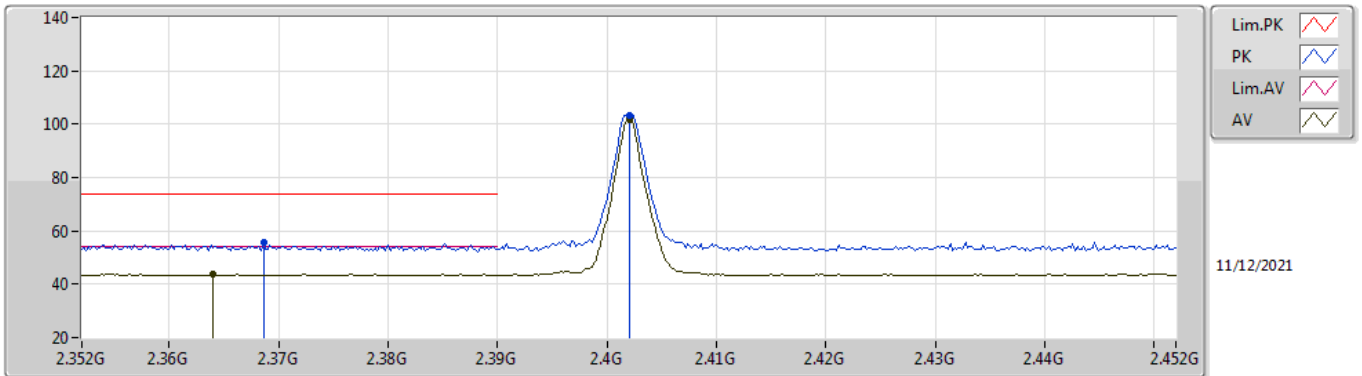

EUT Y\_1TX  
Setting OE  
01-A-R-5

Type	Freq (Hz)	Level (dBuV/m)	Limit (dBuV/m)	Margin (dB)	Raw (dBuV)	Dist (m)	Condition	Azimuth (°)	Height (m)	Comment	AF (dB)	CL (dB)	PA (dB)
PK	2.3686G	55.51	74.00	-18.49	24.05	3	Horizontal	50	2.46	-	27.66	3.80	-
AV	2.364G	43.76	54.00	-10.24	12.29	3	Horizontal	50	2.46	-	27.67	3.80	-
PK	2.402G	103.42	Inf	-Inf	72.02	3	Horizontal	50	2.46	-	27.60	3.80	-
AV	2.402G	101.90	Inf	-Inf	70.50	3	Horizontal	50	2.46	-	27.60	3.80	-

**BT-LE(1Mbps)**

**2402MHz\_TX**

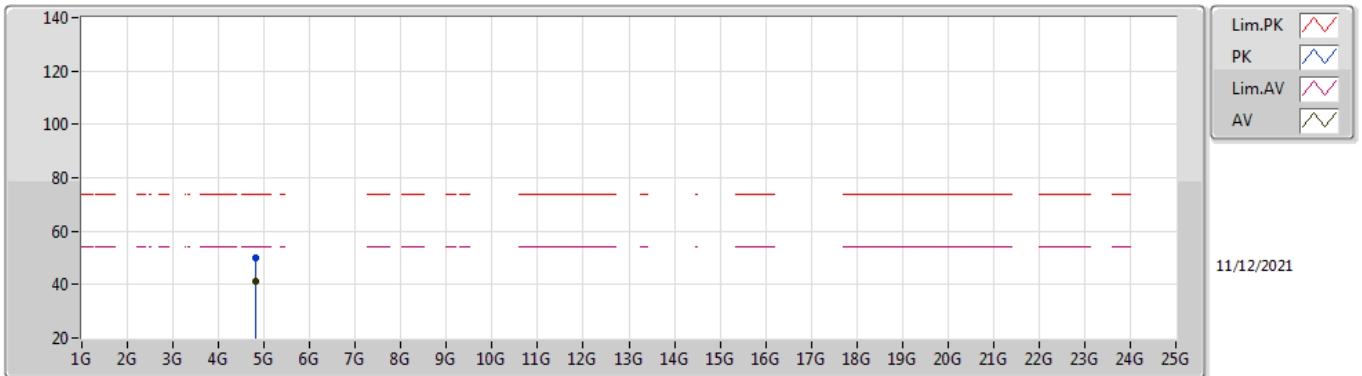

EUT Y\_1TX  
Setting 0E  
01-A-R-5

Type	Freq (Hz)	Level (dBuV/m)	Limit (dBuV/m)	Margin (dB)	Raw (dBuV)	Dist (m)	Condition	Azimuth (°)	Height (m)	Comment	AF (dB)	CL (dB)	PA (dB)
PK	4.80444G	50.01	74.00	-23.99	45.31	3	Vertical	313	2.01	-	31.39	6.30	32.99
AV	4.80396G	41.26	54.00	-12.74	36.56	3	Vertical	313	2.01	-	31.39	6.30	32.99

### BT-LE(1Mbps)

### 2402MHz\_TX

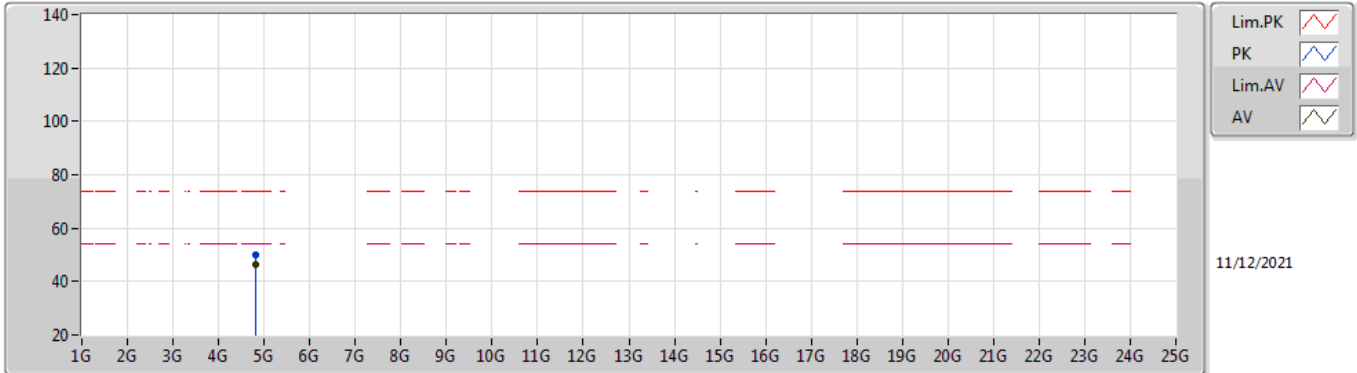

EUT Y\_1TX  
Setting 0E  
01-A-R-5

Type	Freq (Hz)	Level (dBuV/m)	Limit (dBuV/m)	Margin (dB)	Raw (dBuV)	Dist (m)	Condition	Azimuth (°)	Height (m)	Comment	AF (dB)	CL (dB)	PA (dB)
PK	4.80376G	49.77	74.00	-24.23	45.07	3	Horizontal	8	2.01	-	31.39	6.30	32.99
AV	4.80392G	46.60	54.00	-7.40	41.90	3	Horizontal	8	2.01	-	31.39	6.30	32.99

### BT-LE(1Mbps)

### 2440MHz\_TX

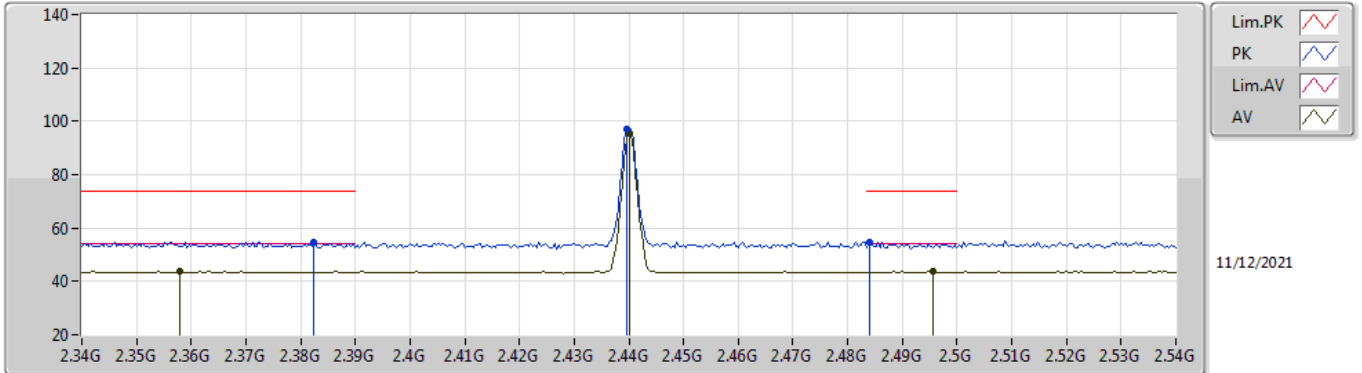

EUT\_V\_1TX  
Setting OE  
01-A-R-5

Type	Freq (Hz)	Level (dBuV/m)	Limit (dBuV/m)	Margin (dB)	Raw (dBuV)	Dist (m)	Condition	Azimuth (°)	Height (m)	Comment	AF (dB)	CL (dB)	PA (dB)
PK	2.3824G	54.71	74.00	-19.29	23.27	3	Vertical	21	2.96	-	27.64	3.80	-
AV	2.358G	43.78	54.00	-10.22	12.30	3	Vertical	21	2.96	-	27.68	3.80	-
PK	2.4396G	96.98	Inf	-Inf	65.64	3	Vertical	21	2.96	-	27.52	3.82	-
AV	2.44G	95.50	Inf	-Inf	64.16	3	Vertical	21	2.96	-	27.52	3.82	-
PK	2.484G	54.90	74.00	-19.10	23.56	3	Vertical	21	2.96	-	27.50	3.84	-
AV	2.4956G	43.75	54.00	-10.25	12.40	3	Vertical	21	2.96	-	27.50	3.85	-

**BT-LE(1Mbps)**

**2440MHz\_TX**

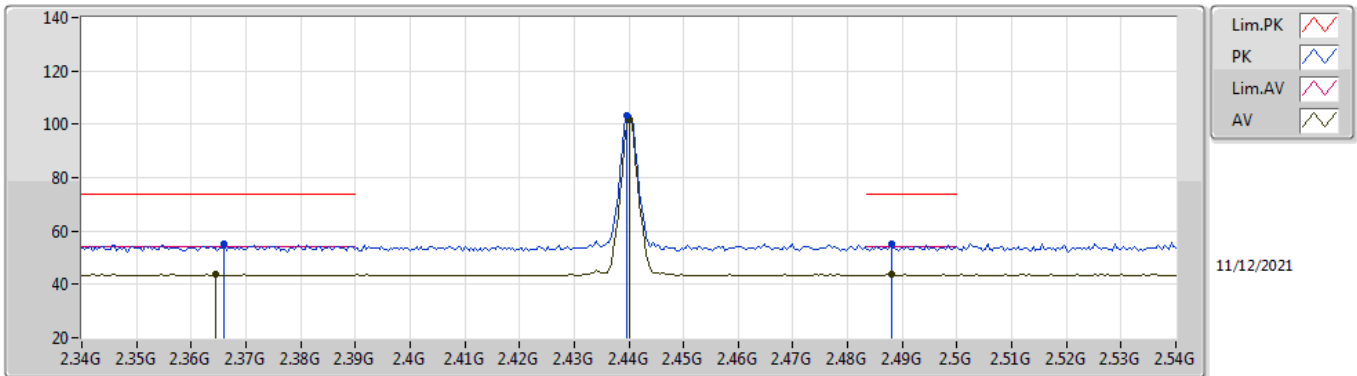

EUT\_V\_1TX  
Setting OE  
01-A-R-5

Type	Freq (Hz)	Level (dBuV/m)	Limit (dBuV/m)	Margin (dB)	Raw (dBuV)	Dist (m)	Condition	Azimuth (°)	Height (m)	Comment	AF (dB)	CL (dB)	PA (dB)
PK	2.366G	55.27	74.00	-18.73	23.80	3	Horizontal	53	2.65	-	27.67	3.80	-
AV	2.3644G	43.81	54.00	-10.19	12.34	3	Horizontal	53	2.65	-	27.67	3.80	-
PK	2.4396G	103.34	Inf	-Inf	72.00	3	Horizontal	53	2.65	-	27.52	3.82	-
AV	2.44G	101.89	Inf	-Inf	70.55	3	Horizontal	53	2.65	-	27.52	3.82	-
PK	2.488G	54.97	74.00	-19.03	23.63	3	Horizontal	53	2.65	-	27.50	3.84	-
AV	2.488G	43.68	54.00	-10.32	12.34	3	Horizontal	53	2.65	-	27.50	3.84	-

### BT-LE(1Mbps)

### 2440MHz\_TX

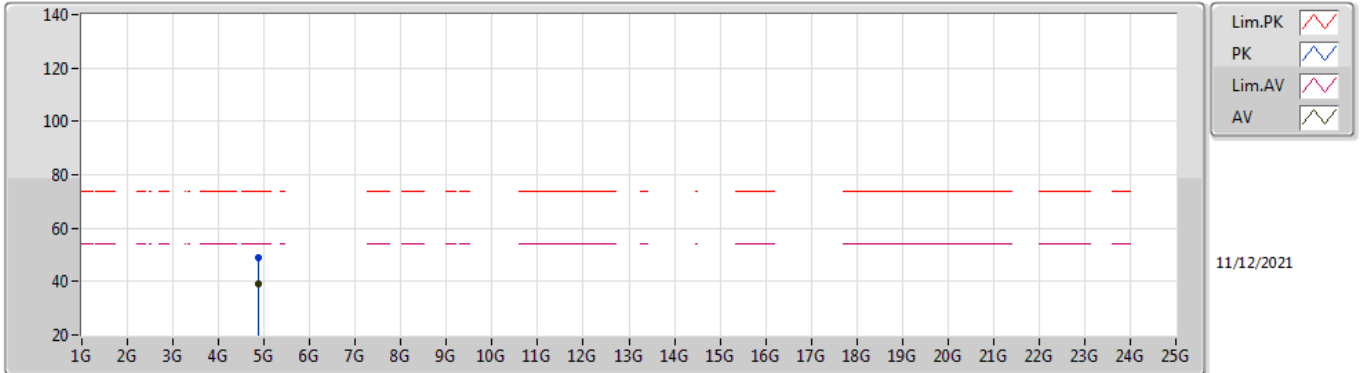

EUT Y\_1TX  
Setting 0E  
01-A-R-5

Type	Freq (Hz)	Level (dBuV/m)	Limit (dBuV/m)	Margin (dB)	Raw (dBuV)	Dist (m)	Condition	Azimuth (°)	Height (m)	Comment	AF (dB)	CL (dB)	PA (dB)
PK	4.8795G	48.89	74.00	-25.11	44.27	3	Vertical	313	2.08	-	31.30	6.30	32.98
AV	4.87958G	38.98	54.00	-15.02	34.36	3	Vertical	313	2.08	-	31.30	6.30	32.98



### BT-LE(1Mbps)

### 2440MHz\_TX

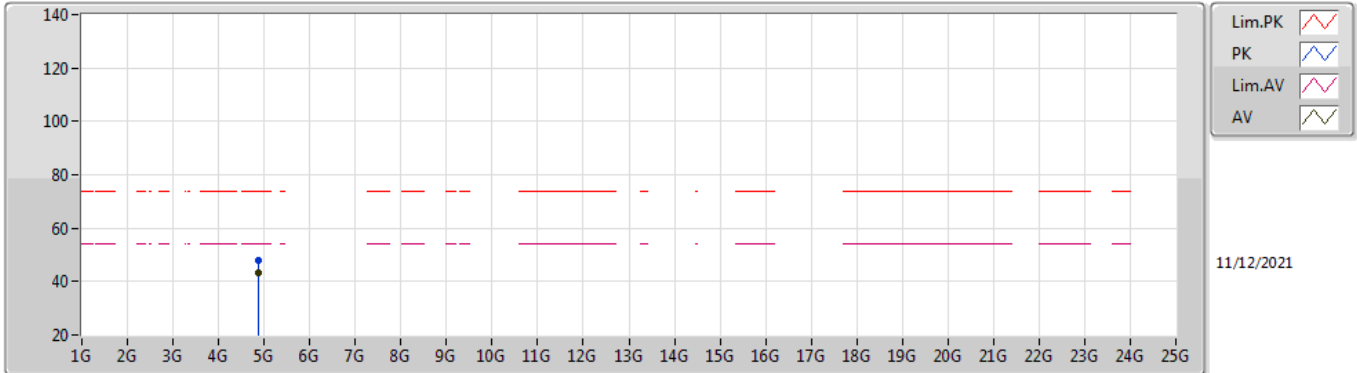

EUT Y\_1TX  
Setting 0E  
01-A-R-5

Type	Freq (Hz)	Level (dBuV/m)	Limit (dBuV/m)	Margin (dB)	Raw (dBuV)	Dist (m)	Condition	Azimuth (°)	Height (m)	Comment	AF (dB)	CL (dB)	PA (dB)
PK	4.87954G	48.10	74.00	-25.90	43.48	3	Horizontal	26	2.19	-	31.30	6.30	32.98
AV	4.87988G	43.49	54.00	-10.51	38.87	3	Horizontal	26	2.19	-	31.30	6.30	32.98

**BT-LE(1Mbps)**

**2480MHz\_TX**

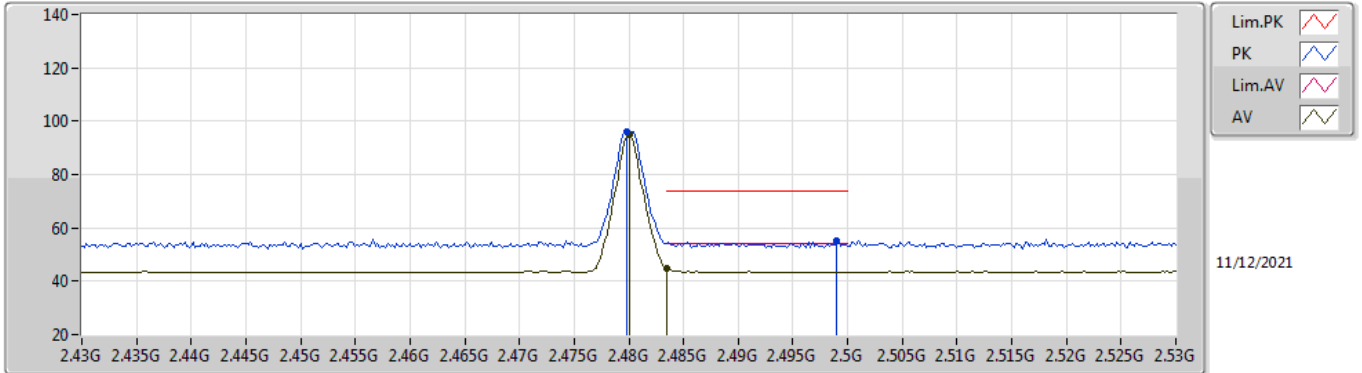

EUT Y\_1TX  
Setting OE  
01-A-R-5

Type	Freq (Hz)	Level (dBuV/m)	Limit (dBuV/m)	Margin (dB)	Raw (dBuV)	Dist (m)	Condition	Azimuth (°)	Height (m)	Comment	AF (dB)	CL (dB)	PA (dB)
PK	2.4798G	96.29	Inf	-Inf	64.95	3	Vertical	0	2.87	-	27.50	3.84	-
AV	2.48G	94.92	Inf	-Inf	63.58	3	Vertical	0	2.87	-	27.50	3.84	-
PK	2.499G	55.21	74.00	-18.79	23.86	3	Vertical	0	2.87	-	27.50	3.85	-
AV	2.4835G	44.79	54.00	-9.21	13.45	3	Vertical	0	2.87	-	27.50	3.84	-

**BT-LE(1Mbps)**

**2480MHz\_TX**

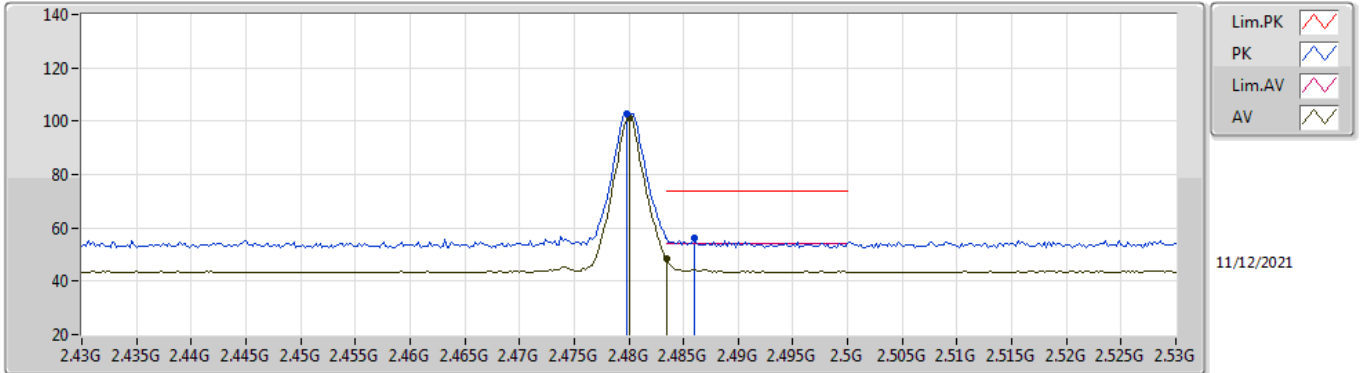

EUT Y\_1TX  
Setting OE  
01-A-R-5

Type	Freq (Hz)	Level (dBuV/m)	Limit (dBuV/m)	Margin (dB)	Raw (dBuV)	Dist (m)	Condition	Azimuth (°)	Height (m)	Comment	AF (dB)	CL (dB)	PA (dB)
PK	2.4798G	102.76	Inf	-Inf	71.42	3	Horizontal	50	2.32	-	27.50	3.84	-
AV	2.48G	101.33	Inf	-Inf	69.99	3	Horizontal	50	2.32	-	27.50	3.84	-
PK	2.486G	56.14	74.00	-17.86	24.80	3	Horizontal	50	2.32	-	27.50	3.84	-
AV	2.4835G	48.24	54.00	-5.76	16.90	3	Horizontal	50	2.32	-	27.50	3.84	-

### BT-LE(1Mbps)

### 2480MHz\_TX

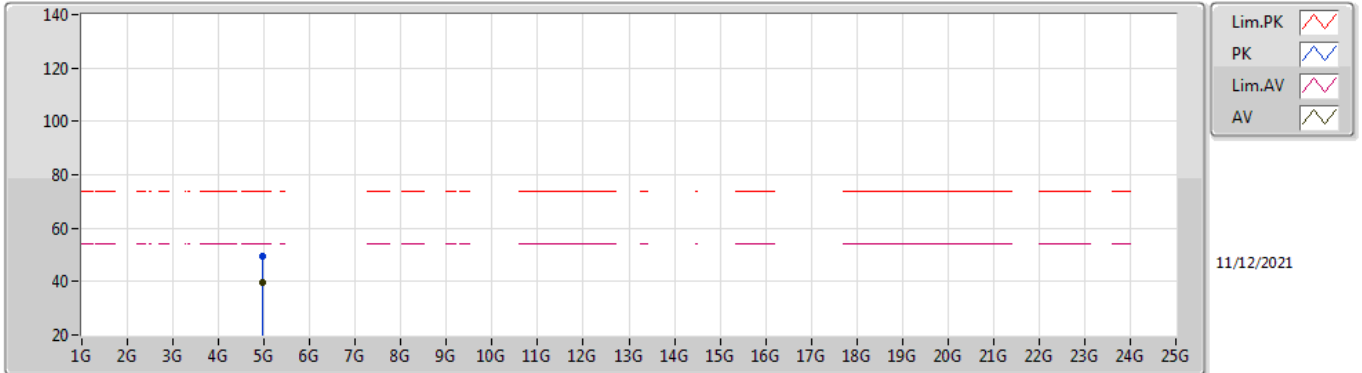

EUT Y\_1TX  
Setting 0E  
01-A-R-5

Type	Freq (Hz)	Level (dBuV/m)	Limit (dBuV/m)	Margin (dB)	Raw (dBuV)	Dist (m)	Condition	Azimuth (°)	Height (m)	Comment	AF (dB)	CL (dB)	PA (dB)
PK	4.9595G	49.73	74.00	-24.27	44.86	3	Vertical	342	2.54	-	31.54	6.30	32.97
AV	4.95952G	39.63	54.00	-14.37	34.76	3	Vertical	342	2.54	-	31.54	6.30	32.97

### BT-LE(1Mbps)

### 2480MHz\_TX

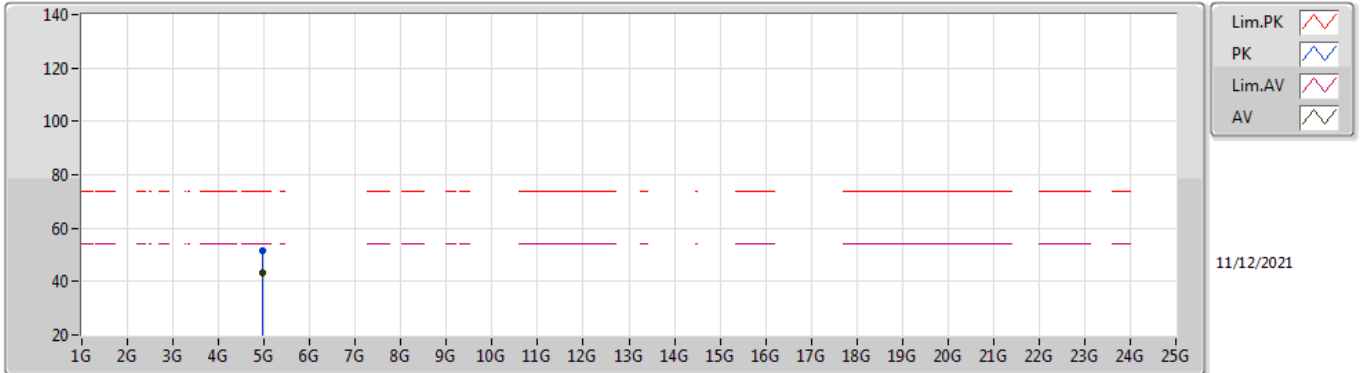

EUT Y\_1TX  
Setting 0E  
01-A-R-5

Type	Freq (Hz)	Level (dBuV/m)	Limit (dBuV/m)	Margin (dB)	Raw (dBuV)	Dist (m)	Condition	Azimuth (°)	Height (m)	Comment	AF (dB)	CL (dB)	PA (dB)
PK	4.9595G	51.43	74.00	-22.57	46.56	3	Horizontal	348	1.77	-	31.54	6.30	32.97
AV	4.9598G	43.25	54.00	-10.75	38.38	3	Horizontal	348	1.77	-	31.54	6.30	32.97

### BT-LE(2Mbps)

### 2402MHz\_TX

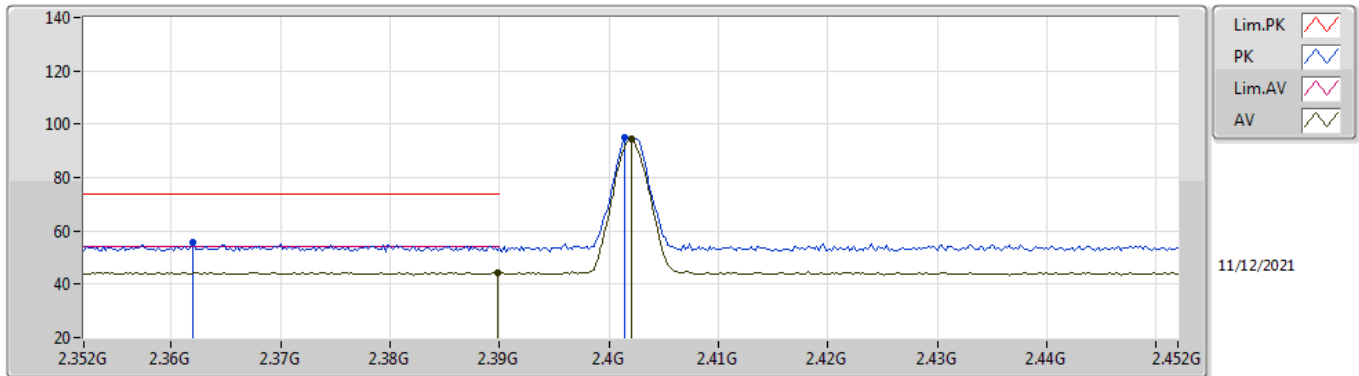

EUT Y\_1TX  
Setting OE  
01-A-R-5

Type	Freq (Hz)	Level (dBuV/m)	Limit (dBuV/m)	Margin (dB)	Raw (dBuV)	Dist (m)	Condition	Azimuth (°)	Height (m)	Comment	AF (dB)	CL (dB)	PA (dB)
PK	2.362G	55.76	74.00	-18.24	24.28	3	Vertical	19.1	3.00	-	27.68	3.80	-
AV	2.3898G	44.50	54.00	-9.50	13.08	3	Vertical	19.1	3.00	-	27.62	3.80	-
PK	2.4014G	95.03	Inf	-Inf	63.63	3	Vertical	19.1	3.00	-	27.60	3.80	-
AV	2.402G	94.58	Inf	-Inf	63.18	3	Vertical	19.1	3.00	-	27.60	3.80	-

**BT-LE(2Mbps)**

**2402MHz\_TX**

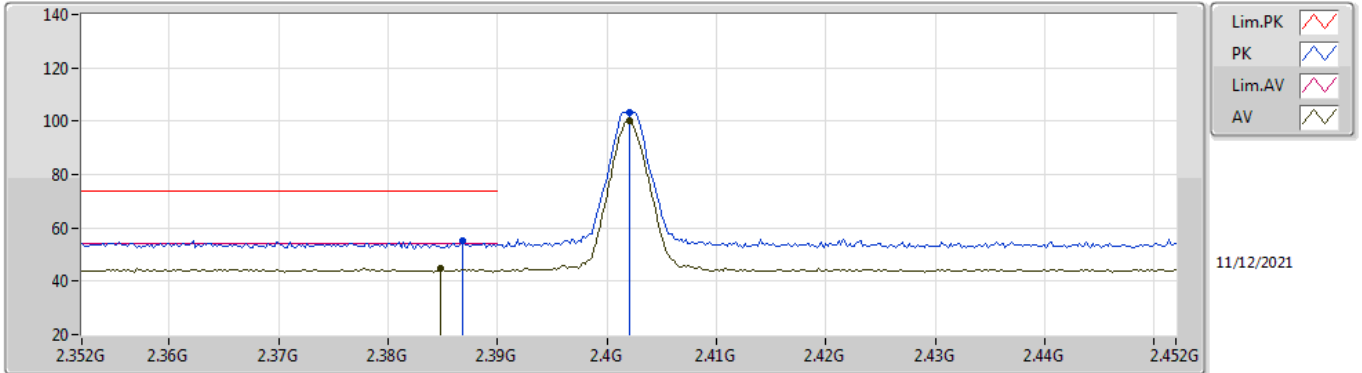

EUT Y\_1TX  
Setting OE  
01-A-R-5

Type	Freq (Hz)	Level (dBuV/m)	Limit (dBuV/m)	Margin (dB)	Raw (dBuV)	Dist (m)	Condition	Azimuth (°)	Height (m)	Comment	AF (dB)	CL (dB)	PA (dB)
PK	2.3868G	55.33	74.00	-18.67	23.90	3	Horizontal	57	2.46	-	27.63	3.80	-
AV	2.3848G	44.75	54.00	-9.25	13.32	3	Horizontal	57	2.46	-	27.63	3.80	-
PK	2.402G	103.22	Inf	-Inf	71.82	3	Horizontal	57	2.46	-	27.60	3.80	-
AV	2.402G	100.32	Inf	-Inf	68.92	3	Horizontal	57	2.46	-	27.60	3.80	-

**BT-LE(2Mbps)**

**2402MHz\_TX**

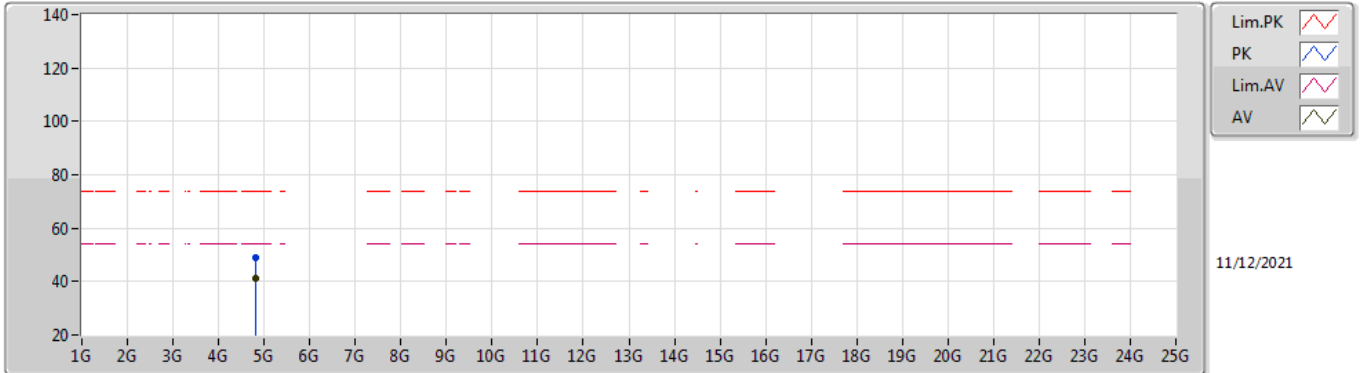

EUT Y\_1TX  
Setting 0E  
01-A-R-5

Type	Freq (Hz)	Level (dBuV/m)	Limit (dBuV/m)	Margin (dB)	Raw (dBuV)	Dist (m)	Condition	Azimuth (°)	Height (m)	Comment	AF (dB)	CL (dB)	PA (dB)
PK	4.80321G	49.16	74.00	-24.84	44.46	3	Vertical	321	1.80	-	31.39	6.30	32.99
AV	4.80301G	41.09	54.00	-12.91	36.39	3	Vertical	321	1.80	-	31.39	6.30	32.99



### BT-LE(2Mbps)

### 2402MHz\_TX

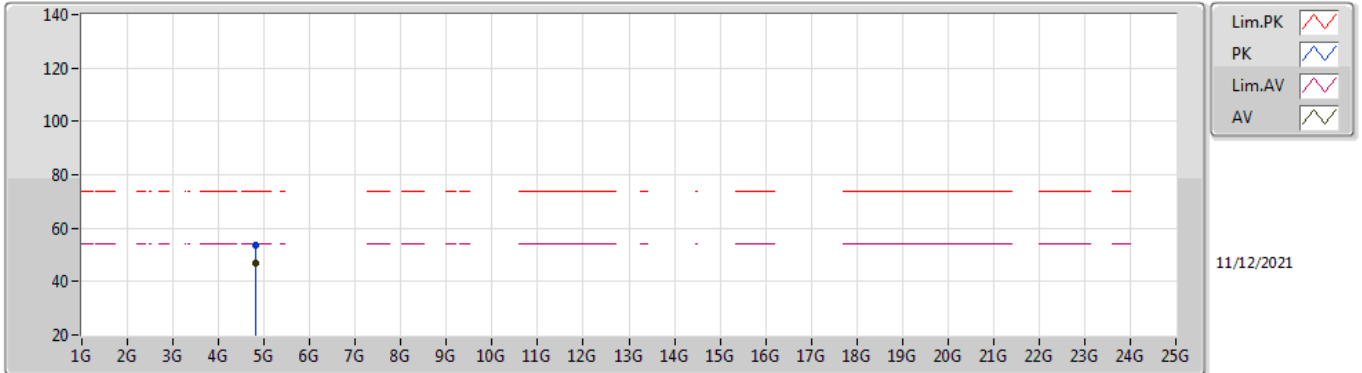

EUT Y\_1TX  
Setting 0E  
01-A-R-5

Type	Freq (Hz)	Level (dBuV/m)	Limit (dBuV/m)	Margin (dB)	Raw (dBuV)	Dist (m)	Condition	Azimuth (°)	Height (m)	Comment	AF (dB)	CL (dB)	PA (dB)
PK	4.80309G	53.87	74.00	-20.13	49.17	3	Horizontal	0	2.02	-	31.39	6.30	32.99
AV	4.80294G	46.64	54.00	-7.36	41.94	3	Horizontal	0	2.02	-	31.39	6.30	32.99

**BT-LE(2Mbps)**

**2440MHz\_TX**

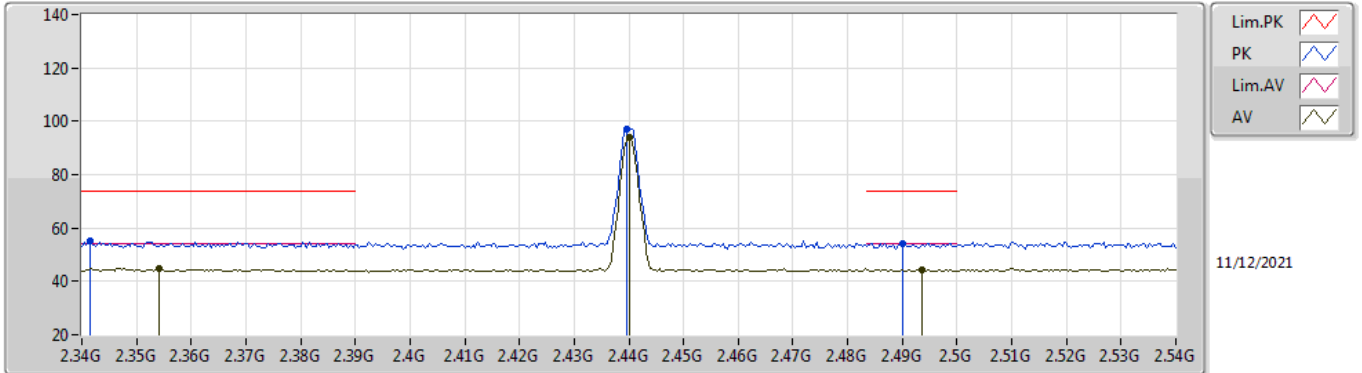

EUT\_V\_1TX  
Setting OE  
01-A-R-5

Type	Freq (Hz)	Level (dBuV/m)	Limit (dBuV/m)	Margin (dB)	Raw (dBuV)	Dist (m)	Condition	Azimuth (°)	Height (m)	Comment	AF (dB)	CL (dB)	PA (dB)
PK	2.3416G	55.15	74.00	-18.85	23.63	3	Vertical	0	2.97	-	27.72	3.80	-
AV	2.354G	44.94	54.00	-9.06	13.45	3	Vertical	0	2.97	-	27.69	3.80	-
PK	2.4396G	97.08	Inf	-Inf	65.74	3	Vertical	0	2.97	-	27.52	3.82	-
AV	2.44G	94.03	Inf	-Inf	62.69	3	Vertical	0	2.97	-	27.52	3.82	-
PK	2.49G	54.37	74.00	-19.63	23.03	3	Vertical	0	2.97	-	27.50	3.84	-
AV	2.4936G	44.34	54.00	-9.66	12.99	3	Vertical	0	2.97	-	27.50	3.85	-

**BT-LE(2Mbps)**

**2440MHz\_TX**

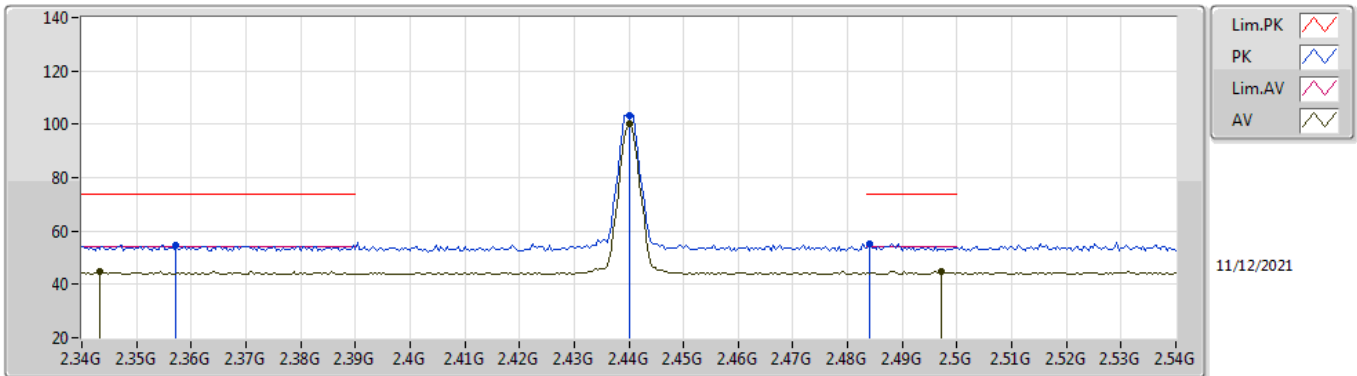

EUT\_V\_1TX  
Setting OE  
01-A-R-5

Type	Freq (Hz)	Level (dBuV/m)	Limit (dBuV/m)	Margin (dB)	Raw (dBuV)	Dist (m)	Condition	Azimuth (°)	Height (m)	Comment	AF (dB)	CL (dB)	PA (dB)
PK	2.3572G	54.58	74.00	-19.42	23.09	3	Horizontal	54	2.34	-	27.69	3.80	-
AV	2.3432G	44.87	54.00	-9.13	13.36	3	Horizontal	54	2.34	-	27.71	3.80	-
PK	2.44G	103.52	Inf	-Inf	72.18	3	Horizontal	54	2.34	-	27.52	3.82	-
AV	2.44G	100.33	Inf	-Inf	68.99	3	Horizontal	54	2.34	-	27.52	3.82	-
PK	2.484G	55.11	74.00	-18.89	23.77	3	Horizontal	54	2.34	-	27.50	3.84	-
AV	2.4972G	44.75	54.00	-9.25	13.40	3	Horizontal	54	2.34	-	27.50	3.85	-

### BT-LE(2Mbps)

### 2440MHz\_TX

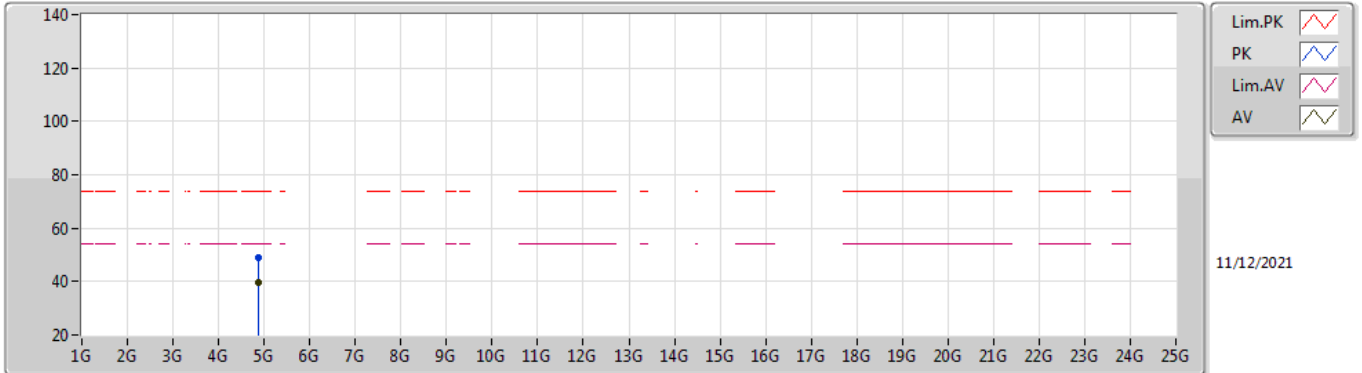

EUT Y\_1TX  
Setting 0E  
01-A-R-5

Type	Freq (Hz)	Level (dBuV/m)	Limit (dBuV/m)	Margin (dB)	Raw (dBuV)	Dist (m)	Condition	Azimuth (°)	Height (m)	Comment	AF (dB)	CL (dB)	PA (dB)
PK	4.88088G	48.77	74.00	-25.23	44.15	3	Vertical	346	3.00	-	31.30	6.30	32.98
AV	4.87902G	39.83	54.00	-14.17	35.21	3	Vertical	346	3.00	-	31.30	6.30	32.98

### BT-LE(2Mbps)

### 2440MHz\_TX

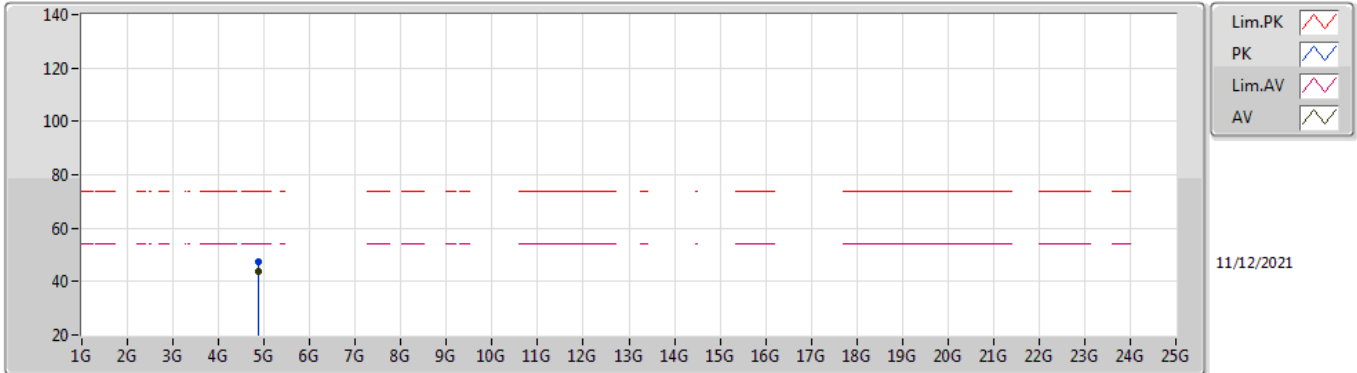

EUT Y\_1TX  
Setting 0E  
01-A-R-5

Type	Freq (Hz)	Level (dBuV/m)	Limit (dBuV/m)	Margin (dB)	Raw (dBuV)	Dist (m)	Condition	Azimuth (°)	Height (m)	Comment	AF (dB)	CL (dB)	PA (dB)
PK	4.88098G	47.16	74.00	-26.84	42.54	3	Horizontal	42	2.21	-	31.30	6.30	32.98
AV	4.879G	43.85	54.00	-10.15	39.23	3	Horizontal	42	2.21	-	31.30	6.30	32.98

**BT-LE(2Mbps)**

**2480MHz\_TX**

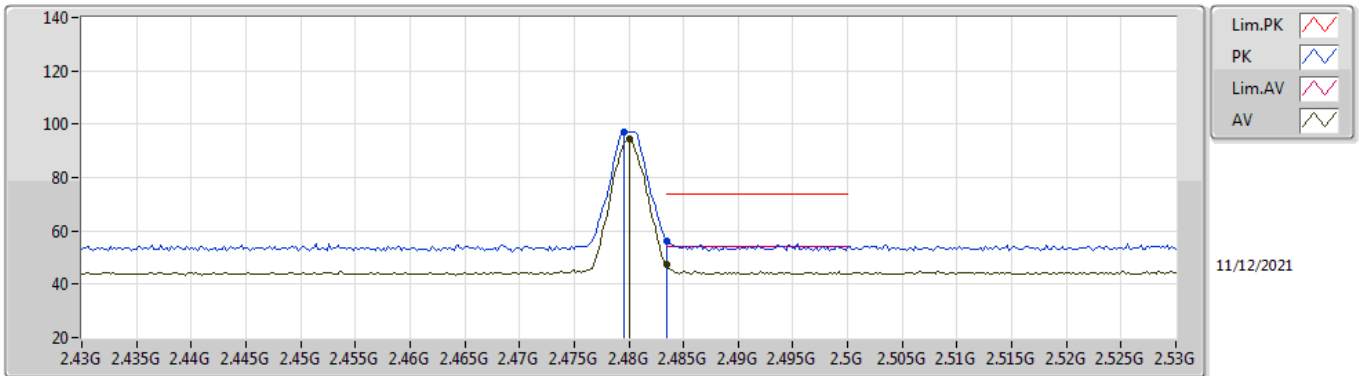

EUT Y\_1TX  
Setting OE  
01-A-R-5

Type	Freq (Hz)	Level (dBuV/m)	Limit (dBuV/m)	Margin (dB)	Raw (dBuV)	Dist (m)	Condition	Azimuth (°)	Height (m)	Comment	AF (dB)	CL (dB)	PA (dB)
PK	2.4796G	97.11	Inf	-Inf	65.77	3	Vertical	0	2.86	-	27.50	3.84	-
AV	2.48G	94.26	Inf	-Inf	62.92	3	Vertical	0	2.86	-	27.50	3.84	-
PK	2.4835G	56.36	74.00	-17.64	25.02	3	Vertical	0	2.86	-	27.50	3.84	-
AV	2.4835G	47.43	54.00	-6.57	16.09	3	Vertical	0	2.86	-	27.50	3.84	-

**BT-LE(2Mbps)**

**2480MHz\_TX**

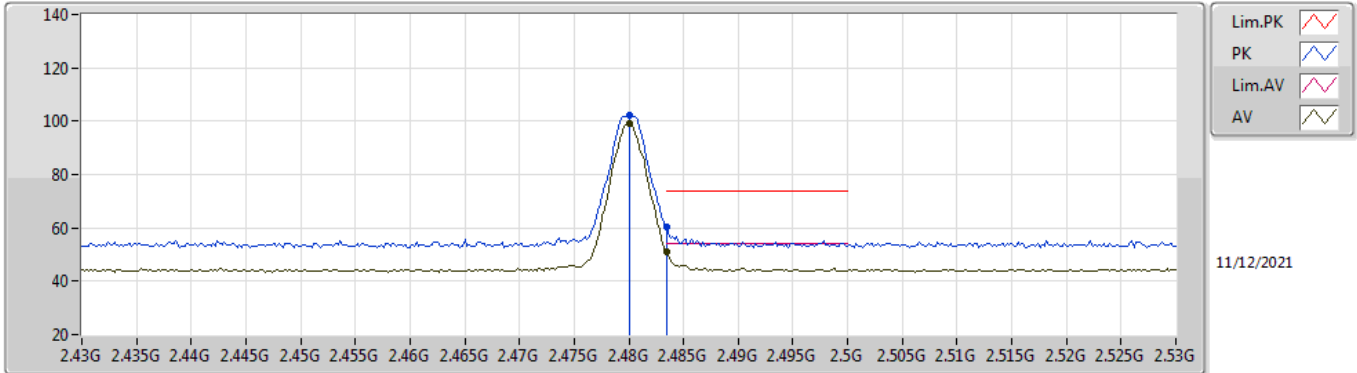

EUT Y\_1TX  
Setting OE  
01-A-R-5

Type	Freq (Hz)	Level (dBuV/m)	Limit (dBuV/m)	Margin (dB)	Raw (dBuV)	Dist (m)	Condition	Azimuth (°)	Height (m)	Comment	AF (dB)	CL (dB)	PA (dB)
PK	2.48G	102.01	Inf	-Inf	70.67	3	Horizontal	51	2.07	-	27.50	3.84	-
AV	2.48G	99.09	Inf	-Inf	67.75	3	Horizontal	51	2.07	-	27.50	3.84	-
PK	2.4835G	60.17	74.00	-13.83	28.83	3	Horizontal	51	2.07	-	27.50	3.84	-
AV	2.4835G	50.95	54.00	-3.05	19.61	3	Horizontal	51	2.07	-	27.50	3.84	-

**BT-LE(2Mbps)**

**2480MHz\_TX**

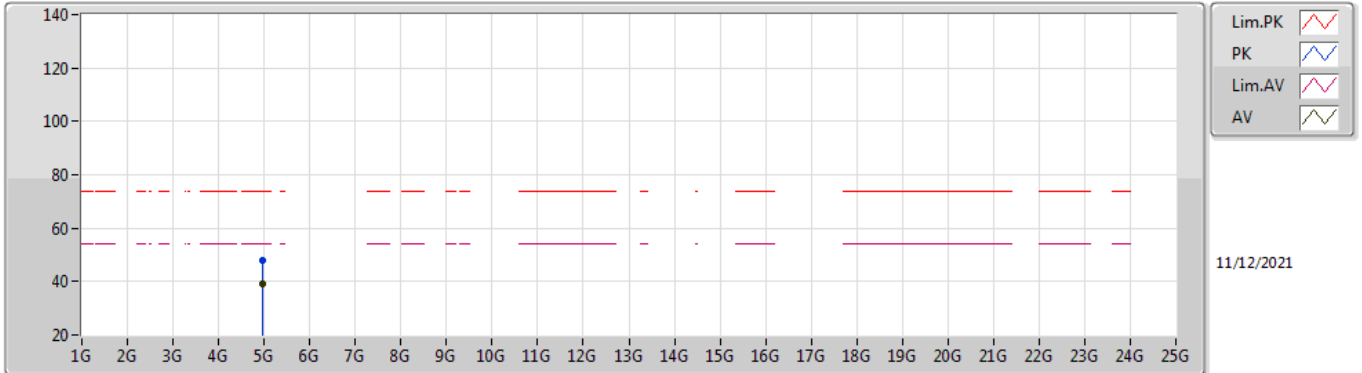

EUT Y\_1TX  
Setting 0E  
01-A-R-5

Type	Freq (Hz)	Level (dBuV/m)	Limit (dBuV/m)	Margin (dB)	Raw (dBuV)	Dist (m)	Condition	Azimuth (°)	Height (m)	Comment	AF (dB)	CL (dB)	PA (dB)
PK	4.96084G	48.02	74.00	-25.98	43.15	3	Vertical	317	2.84	-	31.54	6.30	32.97
AV	4.9601G	39.30	54.00	-14.70	34.43	3	Vertical	317	2.84	-	31.54	6.30	32.97



### BT-LE(2Mbps)

### 2480MHz\_TX

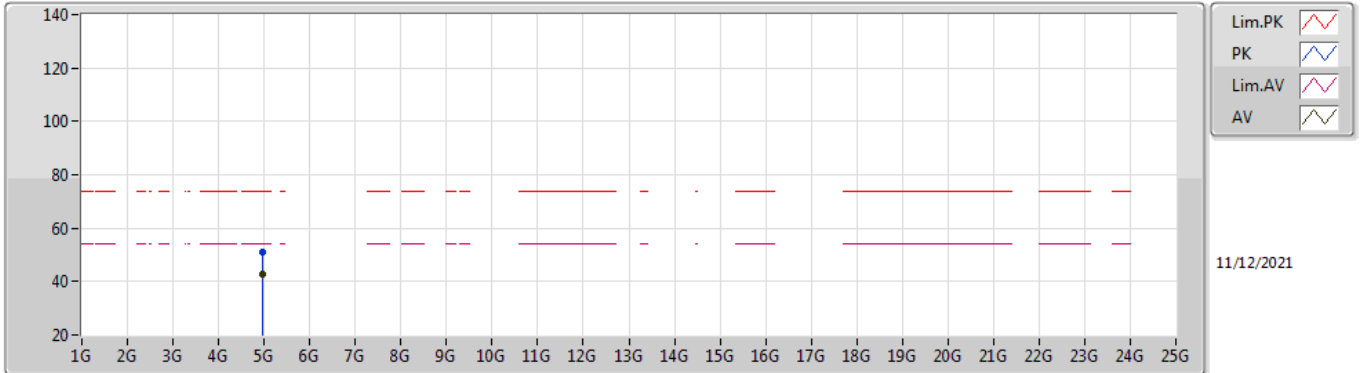

EUT Y\_1TX  
Setting 0E  
01-A-R-5

Type	Freq (Hz)	Level (dBuV/m)	Limit (dBuV/m)	Margin (dB)	Raw (dBuV)	Dist (m)	Condition	Azimuth (°)	Height (m)	Comment	AF (dB)	CL (dB)	PA (dB)
PK	4.96088G	50.78	74.00	-23.22	45.91	3	Horizontal	356	2.15	-	31.54	6.30	32.97
AV	4.95896G	42.76	54.00	-11.24	37.89	3	Horizontal	356	2.15	-	31.54	6.30	32.97