



FCC C2PC Test Report

FCC Part15 Subpart E

Product Name : Wireless Access Point
Model No. : AP460C
FCC ID : QXO-AP460C

Applicant : Extreme Networks, Inc
Address : 6480 Via Del Oro, San Jose, CA 95119

Date of Receipt : Oct. 28, 2019
Test Date : Sep. 20, 2019 ~ May. 12, 2020
Issued Date : May. 12, 2020
Report No. : 19A2144R-RF-US-P09V02
Report Version : V1.0

The test results presented in this report relate only to the object tested.

The measurement result is considered in conformance with the requirement if it is within the prescribed limit, It is not necessary to account the uncertainty associated with the measurement result, unless the specification, standard or customer have special requirements

This report shall not be reproduced, except in full, without the written approval of the Issuing CB Testing Laboratory

This report is not used for social proof in China (or Mainland China) market.

Test Report Certification

Issued Date : May. 12, 2020
Report No. : 19A2144R-RF-US-P09V02



Product Name : Wireless Access Point
 Applicant : Extreme Networks, Inc
 Address : 6480 Via Del Oro, San Jose, CA 95119
 Manufacturer : Extreme Networks, Inc
 Address : 6480 Via Del Oro, San Jose, CA 95119
 Model No. : AP460C
 Brand : Extreme Networks
 FCC ID : QXO-AP460C
 EUT Voltage : DC 37~57V
 Test Voltage : AC 120V/60Hz
 Applicable Standard : FCC CFR Title 47 Part 15 Subpart E
 ANSI C63.10:2013;
 789033 D02 General UNII Test Procedures New Rules
 v02r01
 KDB 662911 D01 Multiple Transmitter Output v02r01
 Test Result : Complied
 Performed Location : DEKRA Testing and Certification (Suzhou) Co., Ltd.
 No.99 Hongye Rd., Suzhou Industrial Park, Suzhou,215006,
 Jiangsu, China
 TEL: +86-512-6251-5088 / FAX: +86-512-6251-5098
 FCC Designation Number: CN1199;

Documented By : *Kitty Li*
 (Adm. Specialist: Kitty Li)

Reviewed By : *Frank He*
 (Technical Supervisor: Frank He)

Approved By : *Jack Zhang*
 (Engineer Supervisor: Jack Zhang)

TABLE OF CONTENTS

Description	Page
1. General Information	7
1.1. EUT Description	7
1.2. Antenna information	8
1.3. Working Frequency of Each Channel:.....	10
1.4. Mode of Operation.....	11
1.5. Tested System Details.....	12
1.6. Configuration of Tested System.....	13
1.7. EUT Exercise Software	14
2. Technical Test	15
2.1. Summary of Test Result	15
2.2. Test Frequency configuration:	16
2.3. Power vs Data Rate	17
2.4. Duty Cycle.....	23
2.5. Test Environment.....	26
2.6. Uncertainty	26
3. Conducted Emission	27
3.1. Test Equipment	27
3.2. Test Setup	27
3.3. Limit.....	28
3.4. Test Procedure	28
3.5. Test Result	29
4. Radiated Emission	31
4.1. Test Equipment	31
4.2. Test Setup	32
4.3. Limit.....	33
4.4. Test Procedure	36
4.5. EUT test Axis definition	37

- 4.6. Test Result38
- 5. Emission bandwidth and occupied bandwidth.....41
 - 5.1. Test Equipment43
 - 5.2. Test Setup43
 - 5.3. Limit.....43
 - 5.4. Test Procedure44
 - 5.5. EUT test Axis definition45
 - 5.6. Test Result46
- 6. 6dB bandwidth50
 - 6.1. Test Equipment50
 - 6.2. Test Setup50
 - 6.3. Limit.....50
 - 6.4. Test Procedure51
 - 6.5. EUT test Axis definition52
 - 6.6. Test Result53
- 7. Power Output.....56
 - 7.1. Test Equipment56
 - 7.2. Test Setup56
 - 7.3. Limit.....57
 - 7.4. Test Procedure58
 - 7.5. EUT test Axis definition60
 - 7.6. Test Result61
- 8. Peak Power Spectral Density.....62
 - 8.1. Test Equipment62
 - 8.2. Test Setup62
 - 8.3. Limit.....63
 - 8.4. Test Procedure65
 - 8.5. EUT test Axis definition66
 - 8.6. Test Result67

- 9. Band Edge 116
 - 9.1. Test Equipment 116
 - 9.2. Test Setup 116
 - 9.3. Limit..... 117
 - 9.4. Test Procedure 120
 - 9.5. EUT test Axis definition 121
 - 9.6. Test Result 122
- 10. Frequency Stability..... 199
 - 10.1. Test Equipment 199
 - 10.2. Test Setup 199
 - 10.3. Limit..... 200
 - 10.4. Test Procedure 201
 - 10.5. EUT test Axis definition 202
 - 10.6. Test Result 203
- 11. Antenna Requirement 207
 - 11.1. Limit..... 207
 - 11.2. Antenna Connector Construction 207

History of This Test Report

REPORT NO.	VERSION	DESCRIPTION	ISSUED DATE
19A2144R-RF-US-P09V02	V1.0	Initial Issued Report	May. 12, 2020

1. General Information

1.1. EUT Description

Product Name	Wireless Access Point					
Model No.	AP460C					
EUT Voltage	DC 37~57V					
Type of Modulation	OFDM-BPSK, QPSK, 16QAM, 64QAM, 256QAM, 1024QAM					
Data Rate	802.11a: 6/9/12/18/24/36/48/54Mbps					
	802.11n: up to 600Mbps					
	802.11ac: up to 1732Mbps					
	802.11ax: up to 4.8Gbps					
Channel Control	Auto					
Transmit modes	<input checked="" type="checkbox"/>	802.11a	<input checked="" type="checkbox"/>	802.11n(20MHz)	<input checked="" type="checkbox"/>	802.11n(40MHz)
	<input checked="" type="checkbox"/>	802.11ac(20MHz)	<input checked="" type="checkbox"/>	802.11ac(40MHz)	<input checked="" type="checkbox"/>	802.11ac(80MHz)
	<input checked="" type="checkbox"/>	802.11ax(20MHz)	<input checked="" type="checkbox"/>	802.11ax(40MHz)	<input checked="" type="checkbox"/>	802.11ax(80MHz)
	<input checked="" type="checkbox"/>	802.11ax(160MHz)				
Support Bands	<input checked="" type="checkbox"/>	5150MHz~5250MHz	<input checked="" type="checkbox"/>	Outdoor AP		
			<input type="checkbox"/>	Indoor AP		
			<input type="checkbox"/>	Fixed point-to-point AP		
			<input type="checkbox"/>	Mobile and Portable Client		
	<input checked="" type="checkbox"/>	5250MHz~5350MHz				
	<input checked="" type="checkbox"/>	5470MHz~5725MHz	<input checked="" type="checkbox"/>	With TDWR Channels		
<input type="checkbox"/>	Without TDWR Channels					
<input checked="" type="checkbox"/>	5725MHz~5850MHz					

1.2. Antenna information

AP460C:

Antenna Model No.	N/A							
Antenna Manufacturer	N/A							
Antenna Delivery	<input checked="" type="checkbox"/>	1*TX+1*RX	<input checked="" type="checkbox"/>	2*TX+2*RX	<input checked="" type="checkbox"/>	3*TX+3*RX	<input checked="" type="checkbox"/>	4*TX+4*RX
Antenna Technology	<input checked="" type="checkbox"/>	SISO						
	<input checked="" type="checkbox"/>	MIMO	<input type="checkbox"/>	Basic methodology				
			<input type="checkbox"/>	Sectorized antenna systems				
			<input type="checkbox"/>	Cross-polarized antennas				
			<input type="checkbox"/>	Unequal antenna gains, with equal transmit powers				
			<input checked="" type="checkbox"/>	Spatial Multiplexing				
<input checked="" type="checkbox"/>	Cyclic Delay Diversity (CDD)							
Antenna Type	PIFA							
Antenna Gain(Radio 1)								
Antenna Technology	Ant Gain (dBi)							
Ant 4(Radio 1)	3.42							
Antenna Gain(Radio 2)								
Antenna Technology	Ant Gain (dBi)							
<input checked="" type="checkbox"/>	SISO	<input checked="" type="checkbox"/>	Ant1 (Radio 2)	3.56				
		<input checked="" type="checkbox"/>	Ant2 (Radio 2)	3.51				
<input checked="" type="checkbox"/>	CDD			3.56dBi for Power; 6.57dBi for PSD				
<input checked="" type="checkbox"/>	Beam-forming			6.57dBi for Power; 6.57dBi for PSD				

Antenna Gain(Radio 3)				
Antenna Technology			Ant Gain (dBi)	
<input checked="" type="checkbox"/>	SISO	<input checked="" type="checkbox"/>	Ant3 (Radio 3)	4.19
		<input checked="" type="checkbox"/>	Ant5 (Radio 3)	3.22
		<input checked="" type="checkbox"/>	Ant6 (Radio 3)	3.96
		<input checked="" type="checkbox"/>	Ant7 (Radio 3)	4.21
<input checked="" type="checkbox"/>	2*2 CDD		4.21dBi for Power; 7.22dBi for PSD	
<input checked="" type="checkbox"/>	2*2 Beam-forming		7.22dBi for Power; 7.22dBi for PSD	
<input checked="" type="checkbox"/>	4*4 CDD		4.21dBi for Power; 10.23dBi for PSD	
<input checked="" type="checkbox"/>	4*4 Beam-forming		10.23dBi for Power; 10.23dBi for PSD	

Note1: The device supports 3 radios, radio 1(1*1 2.4GHz & 1*1 5GHz full band); radio 2(2*2 2.4GHz & 2*2 5GHz low band); radio 3(4*4 5GHz full band & 1*1 BLE), and radio 2 & 3 can works with Dual 2.4GHz & 5GHz mode and Dual 5GHz mode. As the 5GHz high band filter is different between two modes, additional Radio 3 5GHz high band mode is tested for compliance.

Dual 2.4GHz & 5GHz mode: Radio 2(2.4GHz 2*2) + Radio 3(5GHz full band 4*4)

Dual 5GHz mode: Radio 2(5GHz low band 2*2) + Radio 3(5GHz high band 4*4)

2: Radio 3 1*1 and 3*3 power will follow 2*2 and 4*4 power setting, so only 2*2 and 4*4 data are tested.

1.3. Working Frequency of Each Channel:

802.11a/n/ac/ax(20MHz) Working Frequency of Each Channel:							
Channel	Frequency	Channel	Frequency	Channel	Frequency	Channel	Frequency
36	5180 MHz	40	5200 MHz	44	5220 MHz	48	5240 MHz
52	5260 MHz	56	5280 MHz	60	5300 MHz	64	5320 MHz
100	5500 MHz	104	5520 MHz	108	5540 MHz	112	5550 MHz
116	5580 MHz	120	5600 MHz	124	5620 MHz	128	5640 MHz
132	5660 MHz	136	5680 MHz	140	5700 MHz	144	5720 MHz
149	5745 MHz	153	5765 MHz	157	5785 MHz	161	5805 MHz
165	5825 MHz	N/A	N/A	N/A	N/A	N/A	N/A
802.11n/ac/ax(40MHz) Working Frequency of Each Channel:							
Channel	Frequency	Channel	Frequency	Channel	Frequency	Channel	Frequency
38	5190 MHz	46	5230 MHz	54	5270 MHz	62	5310 MHz
102	5510 MHz	110	5550 MHz	118	5590 MHz	126	5630 MHz
134	5670 MHz	142	5710 MHz	151	5755 MHz	159	5795 MHz
802.11ac/ax(80MHz) Working Frequency of Each Channel:							
Channel	Frequency	Channel	Frequency	Channel	Frequency	Channel	Frequency
42	5210 MHz	58	5290 MHz	106	5530MHz	122	5610 MHz
138	5690 MHz	155	5775 MHz	N/A	N/A	N/A	N/A
802.11ax(160MHz) Working Frequency of Each Channel:							
Channel	Frequency	Channel	Frequency	Channel	Frequency	Channel	Frequency
50	5250 MHz	114	5570 MHz	N/A	N/A	N/A	N/A

1.4. Mode of Operation

DEKRA Testing and Certification (Suzhou) Co., Ltd. has verified the construction and function in typical operation. All the test modes were carried out with the EUT in normal operation, which was shown in this test report and defined as:

Test Mode
Mode 1: Transmit by 802.11a
Mode 2: Transmit by 802.11n(20MHz)
Mode 3: Transmit by 802.11n(40MHz)
Mode 4: Transmit by 802.11ac(20MHz)
Mode 5: Transmit by 802.11ac(40MHz)
Mode 6: Transmit by 802.11ac(80MHz)
Mode 7: Transmit by 802.11ax(20MHz)
Mode 8: Transmit by 802.11ax(40MHz)
Mode 9: Transmit by 802.11ax(80MHz)
Mode 10: Transmit by 802.11ax(160MHz)

Note 1: Regards to the frequency band operation: the lowest, middle and highest frequency channel were selected to perform the test, then shown on this report.

Note 2: For portable device, radiated tests was verified over X, Y, Z axis, and shown the worst case on this report.

1.5. Tested System Details

The types for all equipment, plus descriptions of all cables used in the tested system (including inserted cards) are:

Product		Manufacturer	Model No.	Serial No.	Power Cord
1	Notebook	Lenovo	Think pad x220	SUA0600195	Non-shielded
A	WLAN cable	N/A	N/A	N/A	Shielded, 0.5m
B	WLAN cable	N/A	N/A	N/A	Shielded, 10m

1.6. Configuration of Tested System

Test setup Diagram- AC Line Conducted Emission Test

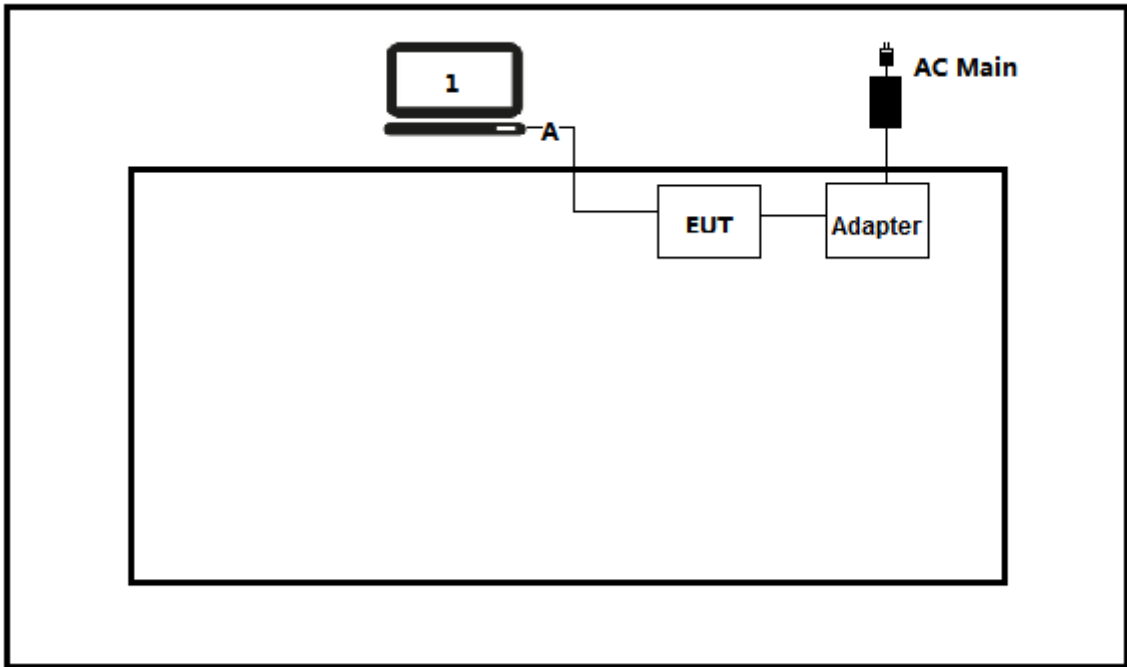

Test setup Diagram- Radiated Emission

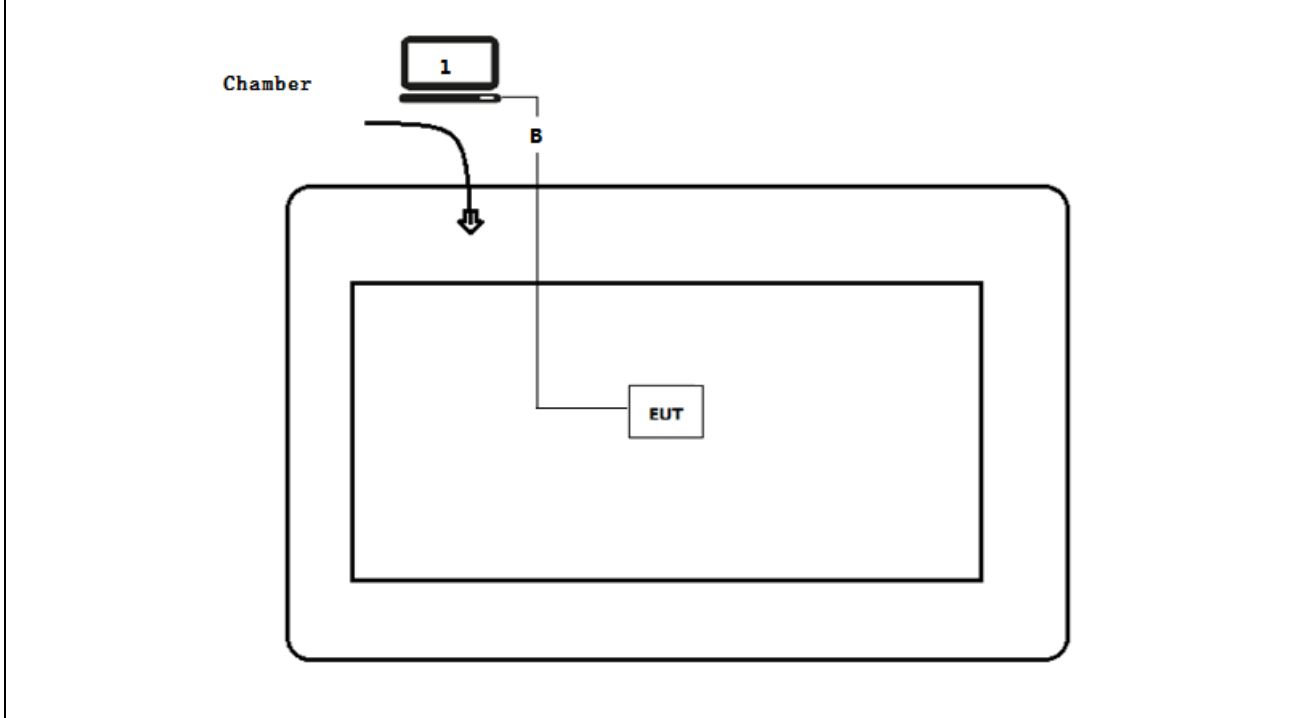

1.7. EUT Exercise Software

1	Setup the EUT and simulators as shown on above.
2	Turn on the power of equipment.
3	Run RF software [MTool], and set the test mode and channel, then press OK to start to continue transmit.

2. Technical Test

2.1. Summary of Test Result

- No deviations from the test standards
- Deviations from the test standards as below description:

Performed Test Item	Normative References	Limit	Result
Conducted Emission	FCC CFR Title 47 Part 15 Subpart E: Section 15.207	FCC 15.207	PASS
Radiated Emission	FCC CFR Title 47 Part 15 Subpart E: Section 15.209	FCC 15.209	PASS
Emission bandwidth and occupied bandwidth	FCC CFR Title 47 Part 15 Subpart E: Section 15.407(e)	FCC 15.407(e)	PASS
6dB Emission Bandwidth	FCC CFR Title 47 Part 15 Subpart E: Section 15.407(e)	FCC 15.407(e)	PASS
Power Output	FCC CFR Title 47 Part 15 Subpart E: Section 15.407(a)	FCC 15.407(a)	PASS
Peak Power Spectral Density	FCC CFR Title 47 Part 15 Subpart E: Section 15.407(a)	FCC 15.407(a)	PASS
Radiated Emission Band Edge	FCC CFR Title 47 Part 15 Subpart E: Section 15.205, 15.407(b)	FCC 15.407(b)	PASS
Frequency Stability	FCC CFR Title 47 Part 15 Subpart E: Section 15.407(g)	±20ppm	PASS

Note: The DFS report please refer to DEKRA report 19A2144R-RF-US-P09V03.

2.2. Test Frequency configuration:

Modulation Mode	Channel	Frequency	Channel	Frequency	Channel	Frequency
802.11a/n/ac/ax(20MHz)	36	5180MHz	44	5220MHz	48	5240MHz
	52	5260MHz	60	5300MHz	64	5320MHz
	100	5500MHz	116	5580MHz	132	5700MHz
	144	5720MHz	149	5745MHz	157	5785MHz
	165	5825MHz	N/A	N/A	N/A	N/A
802.11n/ac/ax(40MHz)	38	5190MHz	46	5230MHz	54	5270MHz
	62	5310MHz	102	5510MHz	110	5550MHz
	134	5670MHz	142	5710MHz	151	5755MHz
	159	5795MHz	N/A	N/A	N/A	N/A
802.11ac/ax(80MHz)	42	5210MHz	58	5290MHz	106	5530MHz
	138	5690MHz	155	5775MHz	N/A	N/A
802.11ax(160MHz)	50	5250MHz	114	5570MHz	N/A	N/A

2.3. Power vs Data Rate

MCS Index for 802.11n	Spatial Streams	Data Rate (Mbps)						
		802.11b	802.11g	802.11a	20MHz Bandwidth		40MHz Bandwidth	
					800ns GI	400ns GI	800ns GI	400ns GI
0	1	1	6	6	6.5	7.2	13.5	15.0
1	1	2	9	9	13.0	14.4	27.0	30.0
2	1	5.5	12	12	19.5	21.7	40.5	45.0
3	1	11	18	18	26.0	28.9	54.0	60.0
4	1	---	24	24	39.0	43.3	81.0	90.0
5	1	---	36	36	52.0	57.8	108.0	120.0
6	1	---	48	48	58.5	65.0	121.5	135.0
7	1	---	54	54	65.0	72.2	135.0	150.0
8	2	---	---	---	13.0	14.4	27.0	30.0
9	2	---	---	---	26.0	28.9	54.0	60.0
10	2	---	---	---	39.0	43.3	81.0	90.0
11	2	---	---	---	52.0	57.8	108.0	120.0
12	2	---	---	---	78.0	86.7	162.0	180.0
13	2	---	---	---	104.0	115.6	216.0	240.0
14	2	---	---	---	117.0	130.0	243.0	270.0
15	2	---	---	---	130.0	144.0	270.0	300.0
16	3	---	---	---	19.5	21.6	40.5	45
17	3	---	---	---	39	43.2	81	90
18	3	---	---	---	58.5	65.1	121.5	135
19	3	---	---	---	78	86.7	162	180
20	3	---	---	---	117	129.9	243	270
21	3	---	---	---	156	173.4	324	360
22	3	---	---	---	175.5	195	364.5	405
23	3	---	---	---	195	216.6	405	450
24	4	---	---	---	26	28.8	54	60
25	4	---	---	---	52	57.6	108	120
26	4	---	---	---	78	86.8	162	180
27	4	---	---	---	104	115.6	216	240
28	4	---	---	---	156	173.2	324	360
29	4	---	---	---	208	231.2	432	480
30	4	---	---	---	234	260	486	540

31	4	---	---	---	260	288.8	540	600
Note1: The blue form is the maximum power data rate.								
2: The EUT supports 4 spatial streams.								

Spatial Streams (Note1)	MCS Index	Modulation type	Coding rate	Data Rate(Mb/s)					
				20MHz		40MHz		80MHz	
				Guard Interval		Guard Interval		Guard Interval	
				800ns	400ns	800ns	400ns	800ns	400ns
1	0	BPSK	1/2	6.5	7.2	13.5	15	29.3	32.5
	1	QPSK	1/2	13	14.4	27	30	58.5	65
	2	QPSK	3/4	19.5	21.7	40.5	45	87.8	97.5
	3	16-QAM	1/2	26	28.9	54	60	117	130
	4	16-QAM	3/4	39	43.3	81	90	175.5	195
	5	64-QAM	2/3	52	57.8	108	120	234	260
	6	64-QAM	3/4	58.5	65	121.5	135	263.3	292.5
	7	64-QAM	5/6	65	72.2	135	150	292.5	325
	8	256-QAM	3/4	78	86.7	162	180	351	390
	9	256-QAM	5/6	N/A	N/A	180	200	390	433.3
2	10	BPSK	1/2	13.0	14.4	27.0	30.0	58.6	65.0
	11	QPSK	1/2	26.0	28.8	54.0	60.0	117.0	130.0
	12	QPSK	3/4	39.0	43.4	81.0	90.0	175.6	195.0
	13	16-QAM	1/2	52.0	57.8	108.0	120.0	234.0	260.0
	14	16-QAM	3/4	78.0	86.6	162.0	180.0	351.0	390.0
	15	64-QAM	2/3	104.0	115.6	216.0	240.0	468.0	520.0
	16	64-QAM	3/4	117.0	130.0	243.0	270.0	526.6	585.0
	17	64-QAM	5/6	130.0	144.4	270.0	300.0	585.0	650.0
	18	256-QAM	3/4	156.0	173.4	324.0	360.0	702.0	780.0
	19	256-QAM	5/6	N/A	N/A	360.0	400.0	780.0	866.6
3	20	BPSK	1/2	26	28.8	54	60	117.2	130
	21	QPSK	1/2	39	43.2	81	90	175.5	195
	22	QPSK	3/4	58.5	65.1	121.5	135	263.4	292.5
	23	16-QAM	1/2	78	86.7	162	180	351	390
	24	16-QAM	3/4	117	129.9	243	270	526.5	585
	25	64-QAM	2/3	156	173.4	324	360	702	780
	26	64-QAM	3/4	175.5	195	364.5	405	789.9	877.5
	27	64-QAM	5/6	195	216.6	405	450	877.5	975
	28	256-QAM	3/4	234	260.1	486	540	1053	1170
	29	256-QAM	5/6	N/A	N/A	540	600	1170	1299.9
4	30	BPSK	1/2	26	28.8	54	60	117.2	130
	31	QPSK	1/2	52	57.6	108	120	234	260
	32	QPSK	3/4	78	86.8	162	180	351.2	390

33	16-QAM	1/2	104	115.6	216	240	468	520
34	16-QAM	3/4	156	173.2	324	360	702	780
35	64-QAM	2/3	208	231.2	432	480	936	1040
36	64-QAM	3/4	234	260	486	540	1053.2	1170
37	64-QAM	5/6	260	288.8	540	600	1170	1300
38	256-QAM	3/4	312	346.8	648	720	1404	1560
39	256-QAM	5/6	N/A	N/A	720	800	1560	1733.2

Note 1: The blue form is the maximum power data rate.

2: The EUT supports 4 spatial streams.

Spatial Streams (Note1)	MCS Index	Modulation type	Coding rate	Data Rate(Mb/s)							
				20MHz		40MHz		80MHz		160MHz	
				Guard Interval		Guard Interval		Guard Interval		Guard Interval	
				1600 ns GI	800 ns GI	1600 ns GI	800 ns GI	1600 ns GI	800 ns GI	1600 ns GI	800 ns GI
1	0	BPSK	1/2	4	4	8	9	17	18	34	36
	1	QPSK	1/2	16	17	33	34	68	72	136	144
	2	QPSK	3/4	24	26	49	52	102	108	204	216
	3	16-QAM	1/2	33	34	65	69	136	144	272	282
	4	16-QAM	3/4	49	52	98	103	204	216	408	432
	5	64-QAM	2/3	65	69	130	138	272	288	544	576
	6	64-QAM	3/4	73	77	146	155	306	324	613	649
	7	64-QAM	5/6	81	86	163	172	340	360	681	721
	8	256-QAM	3/4	98	103	195	207	408	432	817	865
	9	256-QAM	5/6	108	115	217	229	453	480	907	961
	10	1024-QAM	3/4	122	129	244	258	510	540	1021	1081
11	1024-QAM	5/6	135	143	271	287	567	600	1134	1201	
2	12	BPSK	1/2	8	8	16	18	34	36	68	72
	13	QPSK	1/2	32	34	66	68	136	144	272	288
	14	QPSK	3/4	48	52	98	104	204	216	408	432
	15	16-QAM	1/2	66	68	130	138	272	288	544	564
	16	16-QAM	3/4	98	104	196	206	408	432	816	864
	17	64-QAM	2/3	130	138	260	276	544	576	1088	1152
	18	64-QAM	3/4	146	154	292	310	612	648	1226	1298
	19	64-QAM	5/6	162	172	326	344	680	720	1362	1442
	20	256-QAM	3/4	196	206	390	414	816	864	1634	1730
	21	256-QAM	5/6	216	230	434	458	906	960	1814	1922
	22	1024-QAM	3/4	244	258	488	516	1020	1080	2042	2162
	23	1024-QAM	5/6	270	286	542	574	1134	1200	2268	2402
3	24	BPSK	1/2	12	12	24	27	51	54	102	108
	25	QPSK	1/2	48	51	99	102	204	216	408	432
	26	QPSK	3/4	72	78	147	156	306	324	612	648
	27	16-QAM	1/2	99	102	195	207	408	432	816	846
	28	16-QAM	3/4	147	156	294	309	612	648	1224	1296
	29	64-QAM	2/3	195	207	390	414	816	864	1632	1728
	30	64-QAM	3/4	219	231	438	465	918	972	1839	1947
	31	64-QAM	5/6	243	258	489	516	1020	1080	2043	2163

	32	256-QAM	3/4	294	309	585	621	1224	1296	2451	2595
	33	256-QAM	5/6	324	345	651	687	1359	1440	2721	2883
	34	1024-QAM	3/4	366	387	732	774	1530	1620	3063	3243
	35	1024-QAM	5/6	405	429	813	861	1701	1800	3402	3603
4	36	BPSK	1/2	16	16	32	36	68	72	136	144
	37	QPSK	1/2	64	68	132	136	272	288	544	576
	38	QPSK	3/4	96	104	196	208	408	432	816	864
	39	16-QAM	1/2	132	136	260	276	544	576	1088	1128
	40	16-QAM	3/4	196	208	392	412	816	864	1632	1728
	41	64-QAM	2/3	260	276	520	552	1088	1152	2176	2304
	42	64-QAM	3/4	292	308	584	620	1224	1296	2452	2596
	43	64-QAM	5/6	324	344	652	688	1360	1440	2724	2884
	44	256-QAM	3/4	392	412	780	828	1632	1728	3268	3460
	45	256-QAM	5/6	432	460	868	916	1812	1920	3628	3844
	46	1024-QAM	3/4	488	516	976	1032	2040	2160	4084	4324
47	1024-QAM	5/6	540	572	1084	1148	2268	2400	4536	4804	

Note 1: The blue form is the maximum power data rate.

2: The EUT supports 4 spatial streams.

2.4. Duty Cycle

Radio 1:

Test Mode	Tx On (ms)	Tx Off (ms)	VBW(kHz)	Tx On + Tx Off (ms)	Duty Cycle (%)
802.11a	2.055	0.115	0.51	2.170	94.70
802.11n(20MHz)	1.920	0.105	0.56	2.025	94.81
802.11n(40MHz)	0.915	0.135	1.1	1.050	87.14
802.11ac(20MHz)	1.915	0.04	0.56	1.955	97.95
802.11ac(40MHz)	0.920	0.065	1.1	0.985	93.40
802.11ac(80MHz)	0.426	0.06	2.4	0.486	87.65
802.11ax(20MHz)	1.475	0.045	0.68	1.520	97.04
802.11ax(40MHz)	0.740	0.075	1.5	0.815	90.80
802.11ax(80MHz)	0.375	0.069	2.7	0.444	84.46

Note 1: T means the minimum transmission duration over which the transmitter is on and is transmitting at its maximum power control level for the tested mode of operation.

Note 2: According to KDB 789033, when test for Conducted Emission Band Edge and Radiated Emission, $VBW \geq 1/T$ will be used.

Radio 2:

Test Mode	Tx On (ms)	Tx Off (ms)	VBW(kHz)	Tx On + Tx Off (ms)	Duty Cycle (%)
802.11a	2.055	0.12	0.51	2.175	94.48
802.11n(20MHz)	1.915	0.11	0.56	2.025	94.57
802.11n(40MHz)	0.915	0.132	1.1	1.047	87.39
802.11ac(20MHz)	1.920	0.04	0.56	1.960	97.96
802.11ac(40MHz)	0.918	0.069	1.1	0.987	93.01
802.11ac(80MHz)	0.426	0.063	2.4	0.489	87.12
802.11ax(20MHz)	1.475	0.04	0.68	1.515	97.36
802.11ax(40MHz)	0.744	0.066	1.5	0.810	91.85
802.11ax(80MHz)	0.375	0.069	2.7	0.444	84.46

Note 1: T means the minimum transmission duration over which the transmitter is on and is transmitting at its maximum power control level for the tested mode of operation.

Note 2: According to KDB 789033, when test for Conducted Emission Band Edge and Radiated Emission, $VBW \geq 1/T$ will be used.

Beam-forming:

Test Mode	Tx On (ms)	Tx Off (ms)	VBW(kHz)	Tx On + Tx Off (ms)	Duty Cycle (%)
802.11n(20MHz)	1.917	0.111	0.56	2.028	94.53
802.11n(40MHz)	0.909	0.135	1.2	1.044	87.07
802.11ac(20MHz)	1.920	0.04	0.56	1.960	97.96
802.11ac(40MHz)	0.918	0.066	1.1	0.984	93.29
802.11ac(80MHz)	0.426	0.063	2.4	0.489	87.12
802.11ax(20MHz)	1.475	0.045	0.68	1.520	97.04
802.11ax(40MHz)	0.747	0.063	1.5	0.810	92.22
802.11ax(80MHz)	0.378	0.066	2.7	0.444	85.14

Note 1: T means the minimum transmission duration over which the transmitter is on and is transmitting at its maximum power control level for the tested mode of operation.

Note 2: According to KDB 789033, when test for Conducted Emission Band Edge and Radiated Emission, $VBW \geq 1/T$ will be used.

Radio 3:

Test Mode	Tx On (ms)	Tx Off (ms)	VBW(kHz)	Tx On + Tx Off (ms)	Duty Cycle (%)
802.11a	2.055	0.117	0.51	2.172	94.61
802.11n(20MHz)	1.917	0.108	0.56	2.025	94.67
802.11n(40MHz)	0.912	0.135	1.1	1.047	87.11
802.11ac(20MHz)	1.920	0.045	0.56	1.965	97.71
802.11ac(40MHz)	0.918	0.063	1.1	0.981	93.58
802.11ac(80MHz)	0.424	0.068	2.4	0.492	86.18
802.11ax(20MHz)	1.479	0.039	0.68	1.518	97.43
802.11ax(40MHz)	0.753	0.057	1.5	0.810	92.96
802.11ax(80MHz)	0.376	0.07	2.7	0.446	84.30
802.11ax(160MHz)	0.236	0.031	4.3	0.267	88.39

Note 1: T means the minimum transmission duration over which the transmitter is on and is transmitting at its maximum power control level for the tested mode of operation.

Note 2: According to KDB 789033, when test for Conducted Emission Band Edge and Radiated Emission, $VBW \geq 1/T$ will be used.

Beam-forming:

Test Mode	Tx On (ms)	Tx Off (ms)	VBW(kHz)	Tx On + Tx Off (ms)	Duty Cycle (%)
802.11n(20MHz)	1.915	0.11	0.56	2.025	94.57
802.11n(40MHz)	0.915	0.132	1.1	1.047	87.39
802.11ac(20MHz)	1.910	0.045	0.56	1.955	97.70
802.11ac(40MHz)	0.918	0.063	1.1	0.981	93.58
802.11ac(80MHz)	0.426	0.063	2.4	0.489	87.12
802.11ax(20MHz)	1.455	0.065	0.75	1.520	95.72
802.11ax(40MHz)	0.744	0.069	1.5	0.813	91.51
802.11ax(80MHz)	0.375	0.069	2.7	0.444	84.46
802.11ax(160MHz)	0.252	0.030	4.3	0.282	89.36

Note 1: T means the minimum transmission duration over which the transmitter is on and is transmitting at its maximum power control level for the tested mode of operation.

Note 2: According to KDB 789033, when test for Conducted Emission Band Edge and Radiated Emission, $VBW \geq 1/T$ will be used.

2.5. Test Environment

Items	Required (IEC 68-1)	Actual
Temperature (°C)	15-35	21
Humidity (%RH)	25-75	50
Barometric pressure (mbar)	860-1060	950-1000

2.6. Uncertainty

Test Items	Uncertainty
AC Power Line Conducted Emission	$\pm 2.02\text{dB}$
Radiated Emission	Below 1GHz $\pm 3.8\text{ dB}$
	Above 1GHz $\pm 3.9\text{ dB}$
RF Antenna Port Conducted Emission	$\pm 1.27\text{dB}$
Radiated Emission Band Edge	$\pm 3.9\text{dB}$
Occupied Bandwidth	$\pm 1\text{kHz}$
Power Spectral Density	$\pm 1.27\text{dB}$
Frequency Stability	$\pm 100\text{ Hz}$

3. Conducted Emission

3.1. Test Equipment

Conducted Emission / TR-1					
Instrument	Manufacturer	Type No.	Serial No.	Cal. Date	Cal. Due Date
EMI Test Receiver	R&S	ESCI	100906	2020.03.05	2021.03.04
Two-Line V-Network	R&S	ENV 216	101189	2019.06.16	2020.06.15
Two-Line V-Network	R&S	ENV 216	101044	2019.09.16	2020.09.15
50ohm Coaxial Switch	Anritsu	MP59B	6200464462	N/A	N/A
50ohm Termination	SHX	TF2	07081402	2019.09.16	2020.09.15
Temperature/Humidity Meter	Zhichen	ZC1-2	TR1-TH	2020.01.05	2021.01.04

Note: All equipment are calibrated with traceable calibrations. Each calibration is traceable to the national or international standards.

3.2. Test Setup

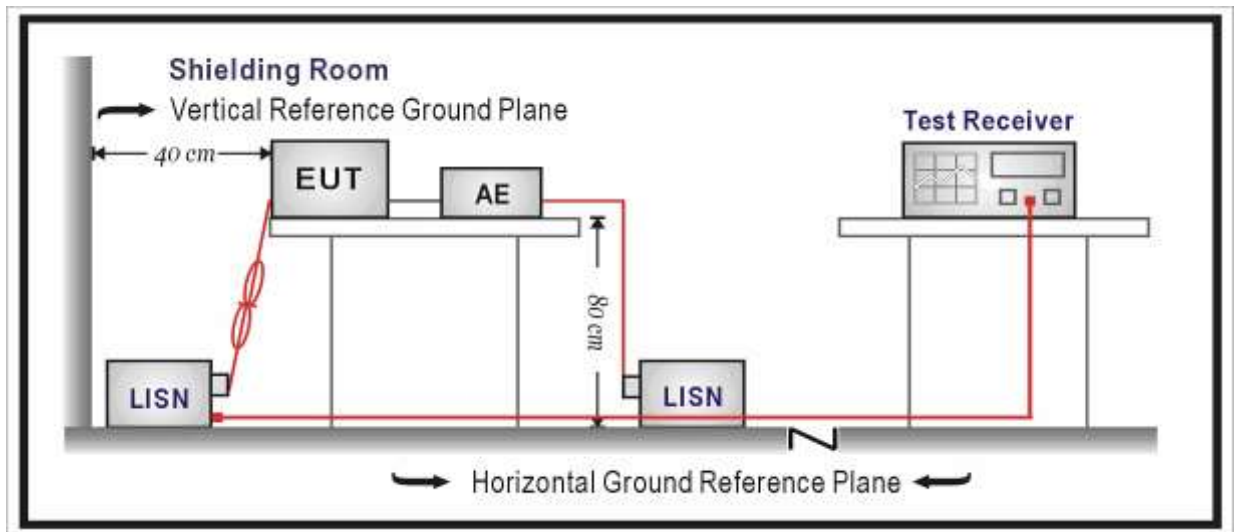

3.3. Limit

Frequency (MHz)	QP (dB μ V)	AV (dB μ V)
0.15 - 0.50	66 – 56	56 – 46
0.50 - 5.0	56	46
5.0 - 30	60	50

Note 1: The lower limit shall apply at the transition frequencies.

Note 2: The limit decreases linearly with the logarithm of the frequency in the range 0.15 MHz to 0.5 MHz.

3.4. Test Procedure

Test Method			
	References Rule	Chapter	Item
<input checked="" type="checkbox"/>	ANSI C63.10-2013	6.2	Standard test method for ac power-line conducted emissions from unlicensed wireless devices

3.5. Test Result

Engineer: Lynee	
Site: TR1	Time: 2019/11/20
Limit: FCC_Part15.207_CE_AC Power	Margin: 0
Probe: ENV216_101189(0.009-30MHz)	Polarity: Line
EUT: Wireless Access Point	Power: AC 120V/60Hz
Note: Simultaneous transmission with 2.4G WIFI + 5G WIFI + BLE	

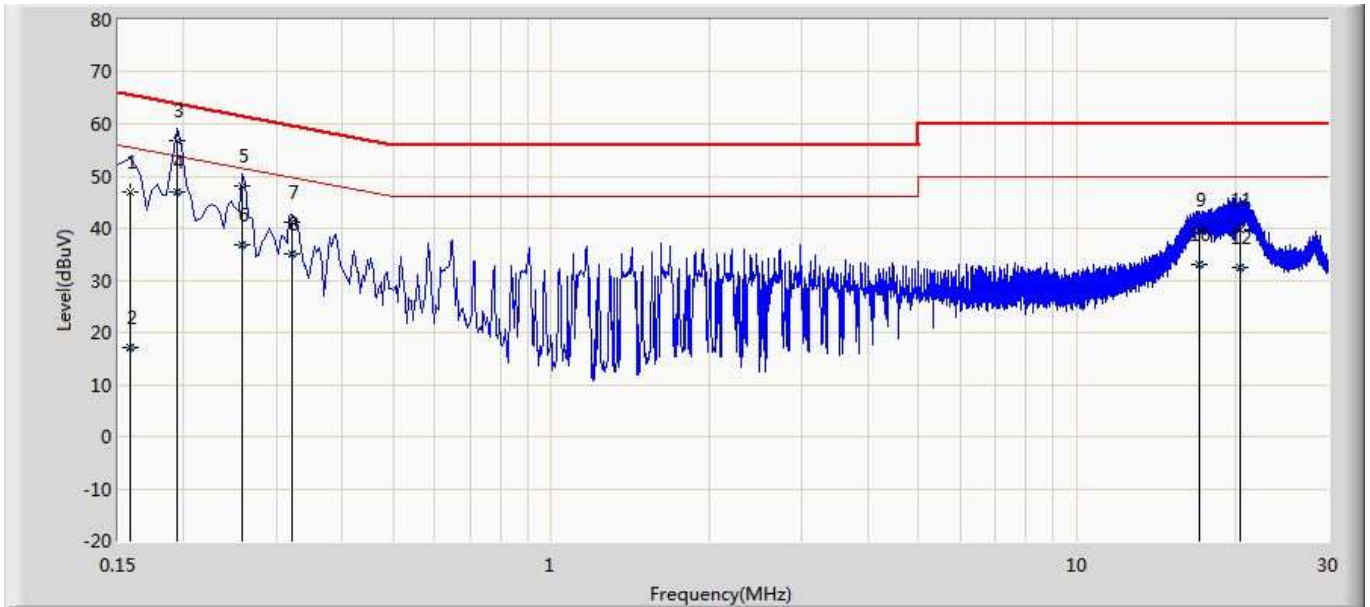

No	Mark	Frequency (MHz)	Measure Level (dBuV)	Reading Level (dBuV)	Over Limit (dB)	Limit (dBuV)	Probe (dB)	Cable (dB)	Amp (dB)	Type
1		0.158	46.959	37.078	-18.610	65.568	9.852	0.029	0.000	QP
2		0.158	17.234	7.354	-38.334	55.568	9.852	0.029	0.000	AV
3		0.194	56.667	46.780	-7.197	63.864	9.859	0.028	0.000	QP
4	*	0.194	46.984	37.097	-6.880	53.864	9.859	0.028	0.000	AV
5		0.258	48.154	38.260	-13.341	61.496	9.862	0.032	0.000	QP
6		0.258	36.875	26.981	-14.620	51.496	9.862	0.032	0.000	AV
7		0.322	41.253	31.354	-18.402	59.655	9.864	0.035	0.000	QP
8		0.322	35.092	25.193	-14.563	49.655	9.864	0.035	0.000	AV
9		17.030	39.722	29.517	-20.278	60.000	9.940	0.265	0.000	QP
10		17.030	33.072	22.866	-16.928	50.000	9.940	0.265	0.000	AV
11		20.442	39.728	29.432	-20.272	60.000	10.004	0.292	0.000	QP
12		20.442	32.568	22.272	-17.432	50.000	10.004	0.292	0.000	AV

Engineer: Lynee	
Site: TR1	Time: 2019/11/20
Limit: FCC_Part15.207_CE_AC Power	Margin: 0
Probe: ENV216_101189(0.009-30MHz)	Polarity: Neutral
EUT: Wireless Access Point	Power: AC 120V/60Hz
Note: Simultaneous transmission with 2.4G WIFI + 5G WIFI + BLE	

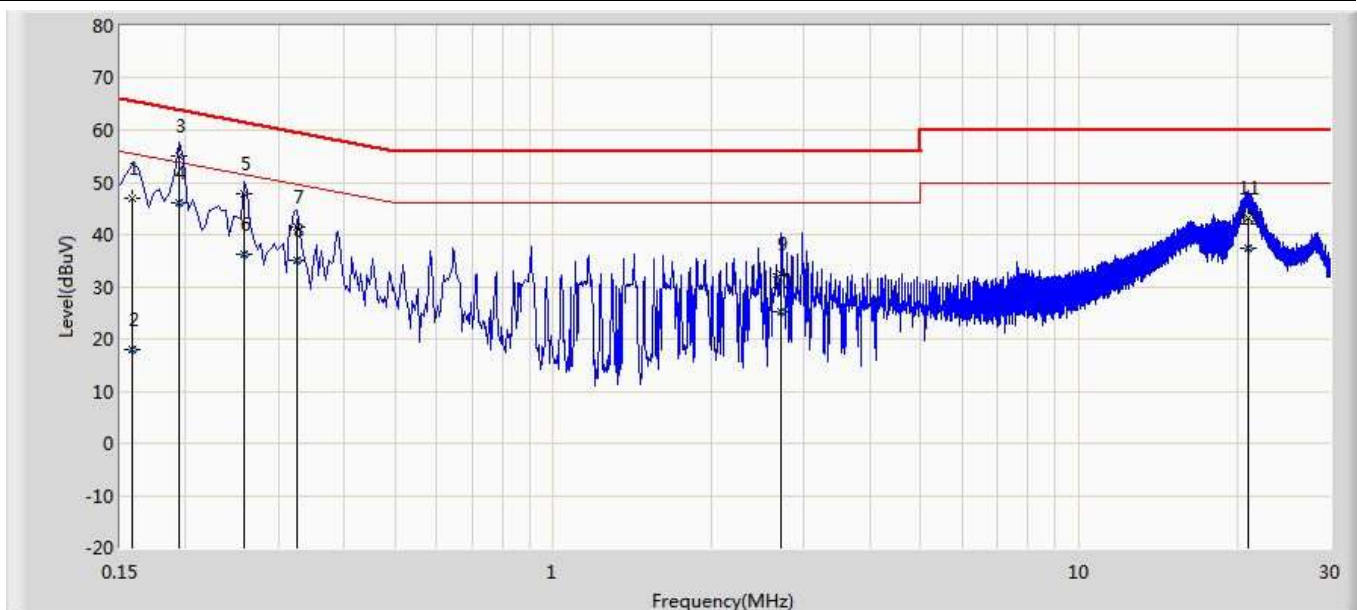

No	Mark	Frequency (MHz)	Measure Level (dBuV)	Reading Level (dBuV)	Over Limit (dB)	Limit (dBuV)	Probe (dB)	Cable (dB)	Amp (dB)	Type
1		0.158	47.009	37.138	-18.559	65.568	9.842	0.029	0.000	QP
2		0.158	17.936	8.065	-37.633	55.568	9.842	0.029	0.000	AV
3		0.194	55.166	45.289	-8.698	63.864	9.849	0.028	0.000	QP
4	*	0.194	46.078	36.201	-7.785	53.864	9.849	0.028	0.000	AV
5		0.258	47.853	37.969	-13.642	61.496	9.852	0.032	0.000	QP
6		0.258	36.279	26.395	-15.216	51.496	9.852	0.032	0.000	AV
7		0.326	41.442	31.552	-18.111	59.552	9.855	0.035	0.000	QP
8		0.326	35.044	25.154	-14.509	49.552	9.855	0.035	0.000	AV
9		2.718	32.475	22.723	-23.525	56.000	9.649	0.103	0.000	QP
10		2.718	25.261	15.509	-20.739	46.000	9.649	0.103	0.000	AV
11		20.962	43.255	33.313	-16.745	60.000	9.646	0.296	0.000	QP
12		20.962	37.289	27.347	-12.711	50.000	9.646	0.296	0.000	AV

Note:

1. " * ", means this data is the worst emission level.
2. Measurement Level = Reading Level + Factor(Probe+Cable-Amp).

4. Radiated Emission

4.1. Test Equipment

Radiated Emission(Below 1GHz) / AC-2					
Instrument	Manufacturer	Type No.	Serial No.	Cal. Date	Cal. Due Date
EMI Test Receiver	R&S	ESCI	100573	2020.03.29	2021.03.28
Loop Antenna	R&S	HFH2-Z2	833799/003	2019.11.16	2020.11.15
Bilog Antenna	Teseq GmbH	CBL6112D	27611	2019.10.16	2020.10.15
Coaxial Cable	Huber+Suhner	SUCOFLEX 106	AC2-C	2020.03.02	2021.03.01
Temperature/Humidity Meter	Zhichen	ZC1-2	AC2-TH	2020.01.04	2021.01.03

Note: All equipment are calibrated with traceable calibrations. Each calibration is traceable to the national or international standards.

Radiated Emission(Above 1GHz) / AC-5					
Instrument	Manufacturer	Type No.	Serial No.	Cal. Date	Cal. Due Date
Spectrum Analyzer	Agilent	E4446A	MY45300103	2020.01.04	2021.01.03
Preamplifier	Miteq	NSP1800-25	1364185	2020.05.06	2021.05.05
Preamplifier	QuieTek	AP-040G	CHM-0906001	2020.05.06	2021.05.05
DRG Horn	ETS-Lindgren	3117	00123988	2020.01.22	2021.01.21
Broad-Band Horn Antenna	Schwarzbeck	BBHA9170	294	2019.11.25	2020.11.24
Coaxial Cable	Huber+Suhner	SUCOFLEX 106	AC5-C1	2020.03.02	2021.03.01
Coaxial Cable	Huber+Suhner	SUCOFLEX 106	AC5-C2	2020.03.02	2021.03.01
Coaxial Cable	Huber+Suhner	SUCOFLEX 102	AC5-C3	2020.03.02	2021.03.01
EMI Receiver	Agilent	N9038A	MY51210196	2019.06.10	2020.06.09
Temperature/Humidity Meter	Zhichen	ZC1-2	AC5-TH	2020.01.04	2021.01.03

Note: All equipment are calibrated with traceable calibrations. Each calibration is traceable to the national or international standards.

4.2. Test Setup

Below 30MHz Test Setup:

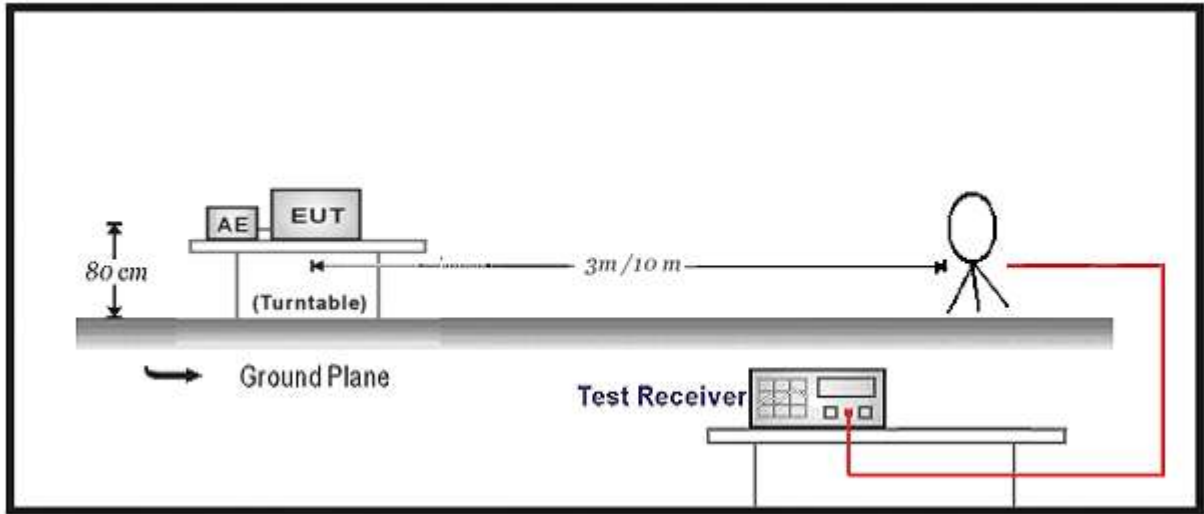

30MHz-1GHz Test Setup:

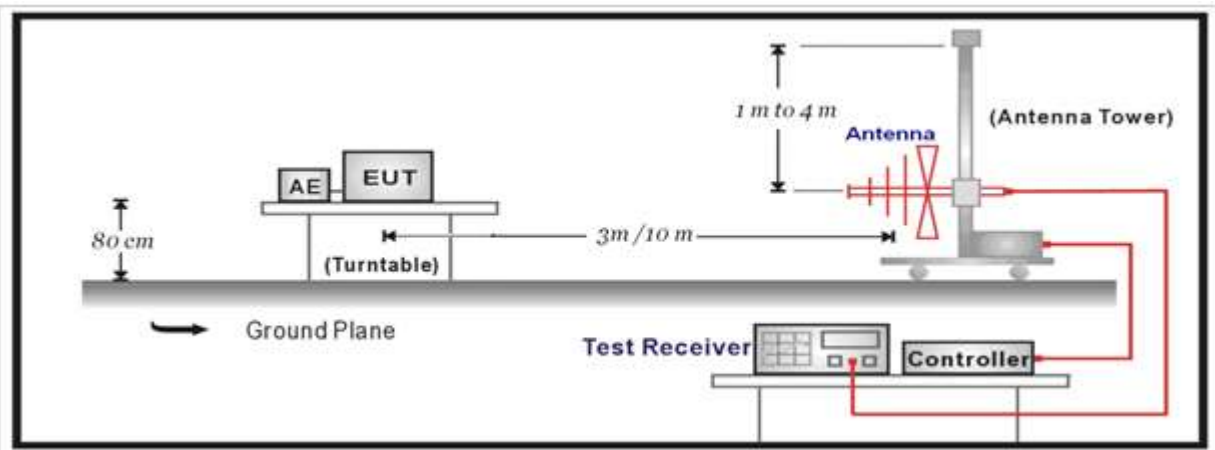

Above 1GHz Test Setup:

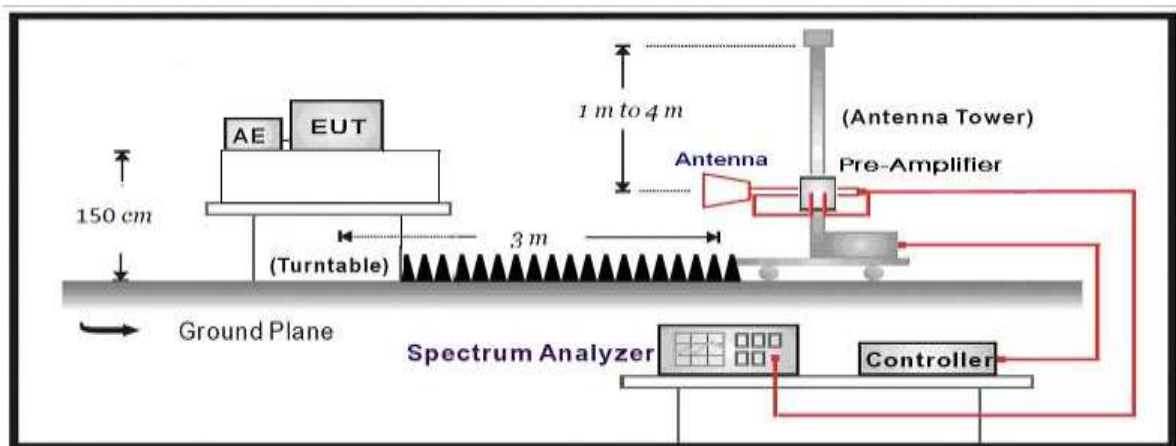

4.3. Limit

FCC Part 15 Subpart C Paragraph 15.209 (Restricted Band Emissions Limit)		
Frequency (MHz)	Distance (m)	Level (dB μ V/m)
0.009-0.490	300	2400/F(kHz)
0.490-1.705	30	24000/F(kHz)
1.705-30.0	30	30
30-88	3	100**
88-216	3	150**
216-960	3	200**
Above 960	3	500

Note 1: At frequencies below 30 MHz, measurements may be performed at a distance closer than that specified in the regulations; however, an attempt should be made to avoid making measurements in the near field. Pending the development of an appropriate measurement procedure for measurements performed below 30 MHz, when performing measurements at a closer distance than specified, the results shall be extrapolated to the specified distance by either making measurements at a minimum of two distances on at least one radial to determine the proper extrapolation factor or by using the square of an inverse linear distance extrapolation factor (40 dB/decade).

Note 2: At frequencies at or above 30 MHz, measurements may be performed at a distance other than what is specified provided: measurements are not made in the near field except where it can be shown that near field measurements are appropriate due to the characteristics of the device; and it can be demonstrated that the signal levels needed to be measured at the distance employed can be detected by the measurement equipment. Measurements shall not be performed at a distance greater than 30 meters unless it can be further demonstrated that measurements at a distance of 30 meters or less are impractical. When performing measurements at a distance other than that specified, the results shall be extrapolated to the specified distance using an extrapolation factor of 20 dB/decade (inverse linear-distance for field strength measurements; inverse-linear-distance-squared for power density measurements).



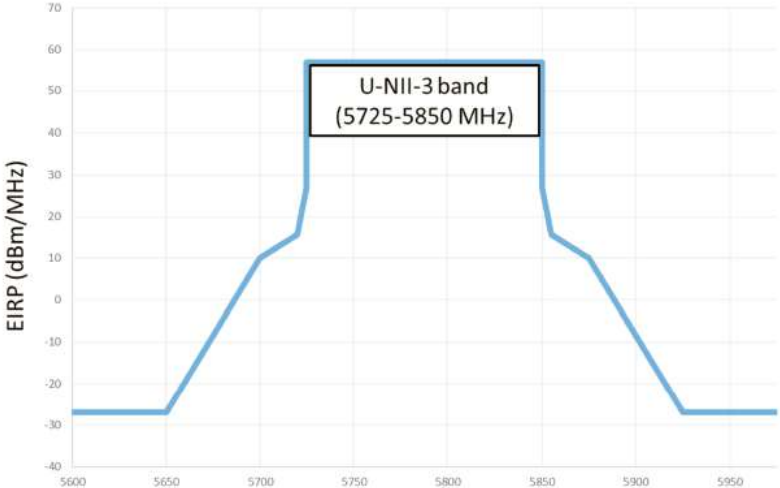

FCC Part 15 Subpart C Paragraph 15.205 (Restricted Band)			
Frequency (MHz)	Frequency (MHz)	Frequency (MHz)	Frequency (GHz)
0.090 – 0.110	16.42 – 16.423	399.9 – 410	4.5 – 5.15
0.495 – 0.505	16.69475 – 16.69525	608 – 614	5.35 – 5.46
2.1735 – 2.1905	16.80425 – 16.80475	960 – 1240	7.25 – 7.75
4.125 – 4.128	25.5 – 25.67	1300 – 1427	8.025 – 8.5
4.17725 – 4.17775	37.5 – 38.25	1435 – 1626.5	9.0 – 9.2
4.20725 – 4.20775	73 – 74.6	1645.5 – 1646.5	9.3 – 9.5
6.215 – 6.218	74.8 – 75.2	1660 – 1710	10.6 – 12.7
6.26775 – 6.26825	108 – 121.94	1718.8 – 1722.2	13.25 – 13.4
6.31175 – 6.31225	123 – 138	2200 – 2300	14.47 – 14.5
8.291 – 8.294	149.9 – 150.05	2310 – 2390	15.35 – 16.2
8.362 – 8.366	156.52475 – 156.52525	2483.5 – 2500	17.7 – 21.4
8.37625 – 8.38675	156.7 – 156.9	2690 – 2900	22.01 – 23.12
8.81425 – 8.81475	162.0125 – 167.17	3260 – 3267	23.6 – 24.0
12.29 – 12.293	167.72 – 173.2	3332 – 3339	31.2 – 31.8
12.51975 – 12.52025	240 – 285	3345.8 – 3358	36.43 – 36.5
12.57675 – 12.57725	322 – 335.4	3600 – 4400	
13.36 – 13.41			

FCC Part 15 Subpart C Paragraph 15.407(5)(b) (Unrestricted Band Emissions Limit)		
Operating Frequency Band (MHz)	EIRP Limit (dBm/MHz)	Equivalent Field Strength at 3m (dB μ V/m)
5150 - 5250	-27	68.3
5250 - 5350	-27	68.3
5470 - 5725	-27	68.3
Operating Frequency Band (MHz)	EIRP Limit (dBm/MHz)	
5725 - 5850		

4.4. Test Procedure

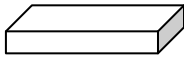
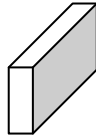
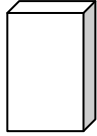
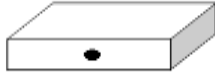
Test Method			
	References Rule	Chapter	Description
<input type="checkbox"/>	ANSI C63.10	12.7.3	Emissions in non-restricted frequency bands
<input checked="" type="checkbox"/>	ANSI C63.10	12.7.2	Emissions in restricted frequency bands
	<input checked="" type="checkbox"/>	ANSI C63.10	Radiated emission measurements
	<input checked="" type="checkbox"/>	ANSI C63.10	Procedure for peak unwanted emissions measurements above 1000 MHz
	<input checked="" type="checkbox"/>	ANSI C63.10	Procedures for average unwanted emissions measurements above 1000 MHz
	<input type="checkbox"/>	ANSI C63.10	12.7.7.2 Method AD (average detection)—primary method
	<input checked="" type="checkbox"/>	ANSI C63.10	12.7.7.3 Method VB-A (Alternative)
	<input checked="" type="checkbox"/>	ANSI C63.10	6.4 Radiated emissions from unlicensed wireless devices below 30 MHz
	<input checked="" type="checkbox"/>	ANSI C63.10	6.5 Radiated emissions from unlicensed wireless devices in the frequency range of 30 MHz to 1000 MHz
	<input checked="" type="checkbox"/>	ANSI C63.10	6.6 Radiated emissions from unlicensed wireless devices above 1 GHz
<input type="checkbox"/>	FCC KDB 789033 D02v02r01	G.2	Unwanted Emissions that fall Outside of the Restricted Bands
<input type="checkbox"/>	FCC KDB 789033 D02v02r01	G.1	Unwanted Emissions in the Restricted Bands
	<input type="checkbox"/>	FCC KDB 789033 D02v02r01	G.4 Procedure for Unwanted Emissions Measurements below 1000 MHz
	<input type="checkbox"/>	FCC KDB 789033 D02v02r01	G.5 Procedure for Unwanted Maximum Emissions Measurements above 1000 MHz
	<input type="checkbox"/>	FCC KDB 789033 D02v02r01	G.6 Procedures for Average Unwanted Emissions Measurements above 1000 MHz
	<input type="checkbox"/>	FCC KDB 789033 D02v02r01	G.6.c Method AD (Average detection)—primary method
	<input type="checkbox"/>	FCC KDB 789033 D02v02r01	G.6.d Method VB (Averaging using reduced video bandwidth): Alternative method.

4.5. EUT test Axis definition

Item	Radiated Emission			
Device Category	<input type="checkbox"/>	Indoor use		
	<input checked="" type="checkbox"/>	Outdoor use		
	<input type="checkbox"/>	Fix position use		
	<input type="checkbox"/>	Client use		
Test mode	Mode 1-10			
Test method	<input checked="" type="checkbox"/>	Radiated		
		X Axis	Y Axis	Z Axis
				
		Worst Axis <input checked="" type="checkbox"/>	Worst Axis <input type="checkbox"/>	Worst Axis <input type="checkbox"/>
	<input type="checkbox"/>	Conducted		
	<input type="checkbox"/>	Chain 1		
				
	<input type="checkbox"/>	Chain 1	Chain 2	
				
	<input type="checkbox"/>	Chain 1	Chain 2	Chain 3
				
<input type="checkbox"/>	Chain 1	Chain 2	Chain 3	Chain 4
				

4.6. Test Result

Note:

1. Measured Level = Reading Level + Factor.
2. The test frequency range, 9kHz~30MHz, 18GHz~40GHz, both of the worst case are at least 20dB below the limits, therefore no data appear in the report.
3. This limit applies for using average detector, if the test result on peak is lower than average limit, then average measurement needn't be performed.
4. As the radiated emission was performed, so conducted emission was not tested.
5. The data was too large so was showed in below attached files.

Appendix 3: 5GHz Radiated spurious emission

The worst case of Radiated Emission below 1GHz:

Engineer: Lacey	
Site: AC3	Time: 2019/11/21
Limit: FCC_Part15.209_RE(3m)	Margin: 0
Probe: AC3_3m (30-1000MHz)	Polarity: Horizontal
EUT: Wireless Access Point	Power: AC 120V/60Hz
Note: Simultaneous transmission with 2.4G WIFI +5G WIFI + BLE	

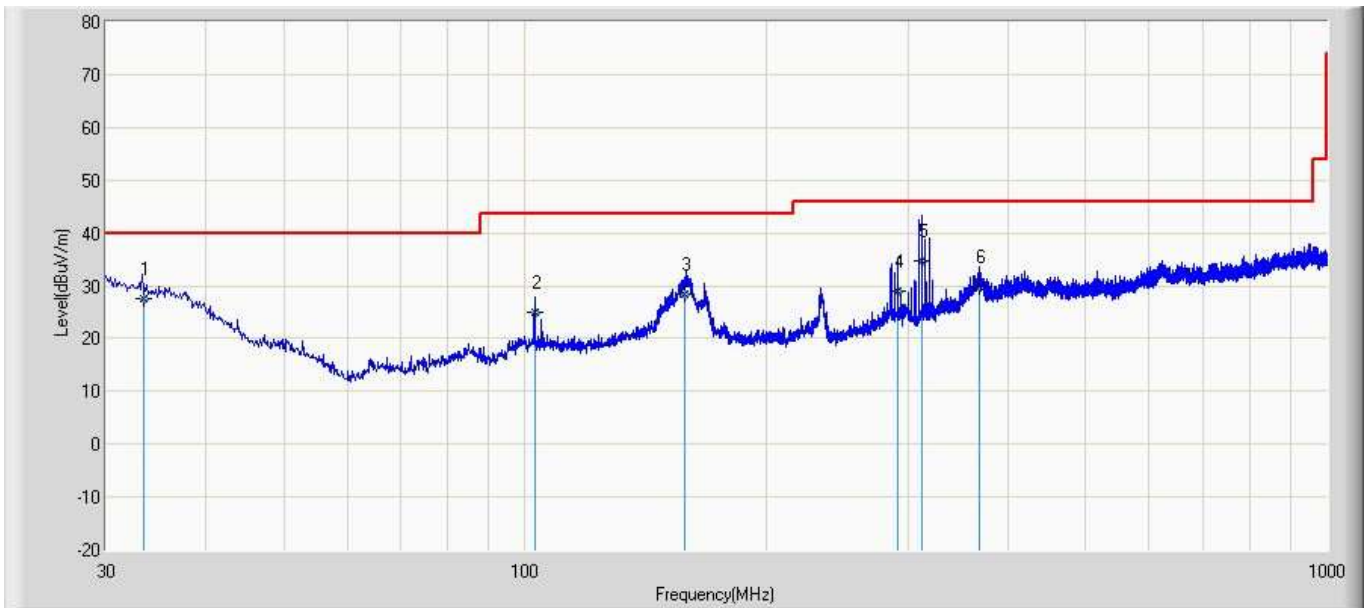

No	Mark	Frequency (MHz)	Measure Level (dBuV/m)	Reading Level (dBuV)	Over Limit (dB)	Limit (dBuV/m)	Probe (dB/m)	Cable (dB)	Amp (dB)	Ant Pos (cm)	Table Pos (deg)	Type
1		33.469	27.540	1.400	-12.460	40.000	19.664	6.476	0.000	100	144	QP
2		102.864	25.116	8.600	-18.384	43.500	9.649	6.868	0.000	200	203	QP
3		158.355	28.520	11.200	-14.980	43.500	10.204	7.115	0.000	100	139	QP
4		291.360	29.091	8.600	-16.909	46.000	12.903	7.589	0.000	100	214	QP
5	*	312.632	34.722	13.600	-11.278	46.000	13.468	7.654	0.000	200	125	QP
6		368.135	29.855	6.100	-16.145	46.000	15.937	7.818	0.000	100	258	QP

Engineer: Lacey	
Site: AC3	Time: 2019/11/21
Limit: FCC_Part15.209_RE(3m)	Margin: 0
Probe: AC3_3m (30-1000MHz)	Polarity: Vertical
EUT: Wireless Access Point	Power: AC 120V/60Hz
Note: Simultaneous transmission with 2.4G WIFI +5G WIFI + BLE	

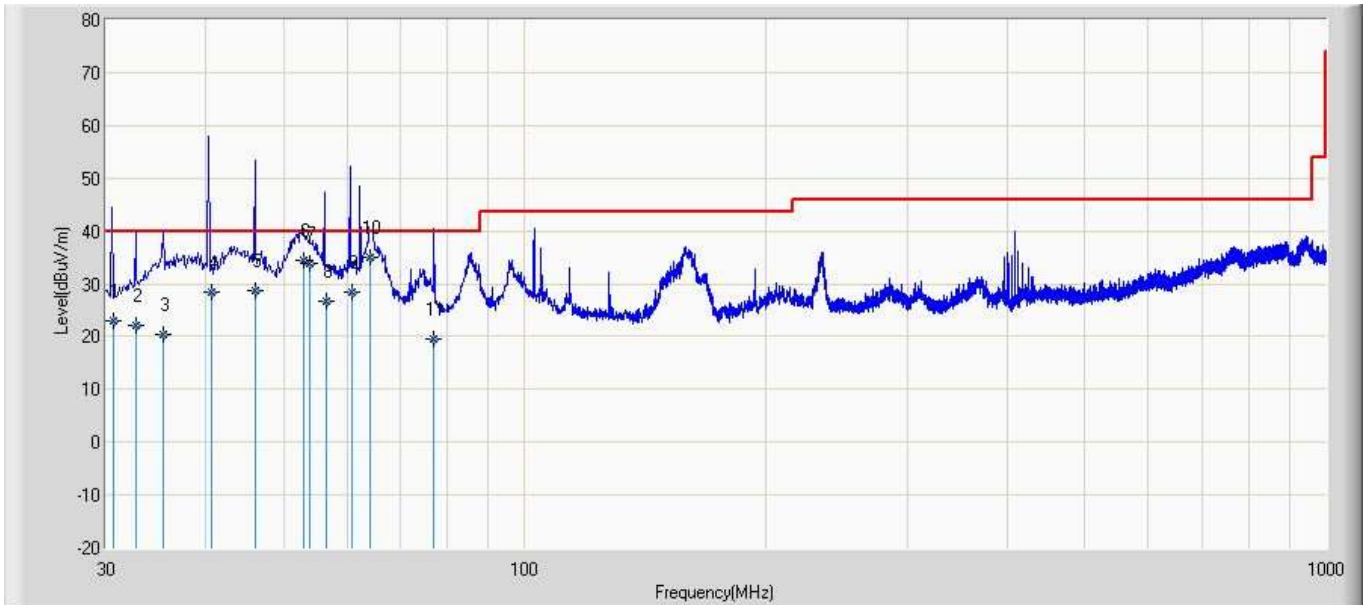

No	Mark	Frequency (MHz)	Measure Level (dBuV/m)	Reading Level (dBuV)	Over Limit (dB)	Limit (dBuV/m)	Probe (dB/m)	Cable (dB)	Amp (dB)	Ant Pos (cm)	Table Pos (deg)	Type
1		30.718	22.874	-1.000	-17.126	40.000	17.415	6.459	0.000	100	211	QP
2		32.667	22.042	-1.200	-17.958	40.000	16.773	6.469	0.000	100	20	QP
3		35.335	20.518	-1.800	-19.482	40.000	15.824	6.494	0.000	100	28	QP
4		40.685	28.368	10.400	-11.632	40.000	11.438	6.530	0.000	100	174	QP
5		46.054	28.803	10.900	-11.197	40.000	11.336	6.568	0.000	100	174	QP
6		52.916	34.477	17.000	-5.523	40.000	10.868	6.609	0.000	200	250	QP
7		53.794	33.745	16.500	-6.255	40.000	10.629	6.616	0.000	200	260	QP
8		56.615	26.780	10.500	-13.220	40.000	9.653	6.626	0.000	100	174	QP
9		60.877	28.333	12.400	-11.667	40.000	9.281	6.652	0.000	100	174	QP
10	*	64.192	34.971	19.100	-5.029	40.000	9.200	6.671	0.000	100	268	QP
11		77.045	19.665	5.000	-20.335	40.000	7.923	6.742	0.000	100	40	QP

Note:

1. " * ", means this data is the worst emission level.
2. Measurement Level = Reading Level + Factor(Probe+Cable-Amp).

The worst case of Simultaneous Radiated Emission:

Engineer: Simon	
Site: AC5	Time: 2020/03/10
Limit: FCC_Part15.209_RE(3m)	Margin: 0
Probe: Horn_3117_00167055(1-18GHz)	Polarity: Vertical
EUT: Wireless Access Point	Power: AC 120V/60Hz
Note: Simultaneous transmission with 2.4G WIFI +5G WIFI + BLE	

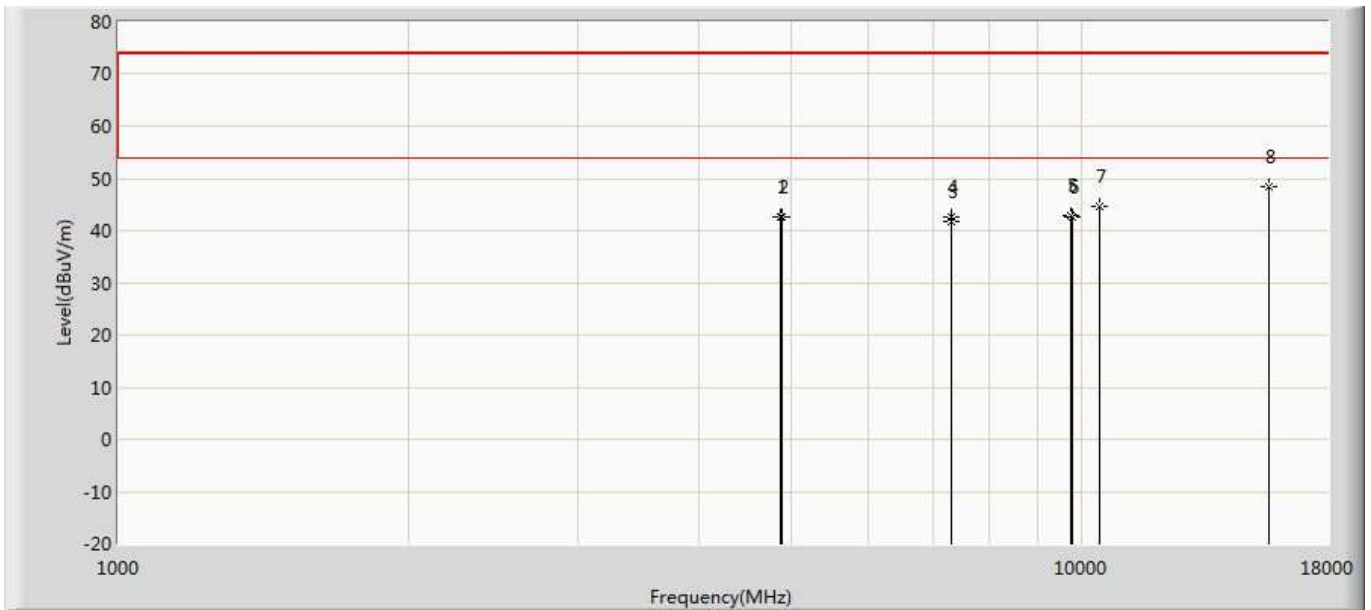

No	Mark	Frequency (MHz)	Measure Level (dBuV/m)	Reading Level (dBuV)	Over Limit (dB)	Limit (dBuV/m)	Factor (dB)	Type
1		4874.000	42.693	35.926	-31.307	74.000	6.767	PK
2		4880.000	42.618	35.890	-31.382	74.000	6.729	PK
3		7311.000	41.706	32.218	-32.294	74.000	9.488	PK
4		7320.000	42.472	32.982	-31.528	74.000	9.490	PK
5		9748.000	43.036	29.396	-30.964	74.000	13.640	PK
6		9760.000	42.712	29.247	-31.288	74.000	13.466	PK
7		10440.000	44.525	30.687	-29.475	74.000	13.838	PK
8	*	15660.000	48.432	28.131	-25.568	74.000	20.301	PK

Engineer: Simon	
Site: AC5	Time: 2020/3/10
Limit: FCC_Part15.209_RE(3m)	Margin: 0
Probe: Horn_3117_00167055(1-18GHz)	Polarity: Horizontal
EUT: Wireless Access Point	Power: AC 120V/60Hz
Note: Simultaneous transmission with 2.4G WIFI +5G WIFI + BLE	

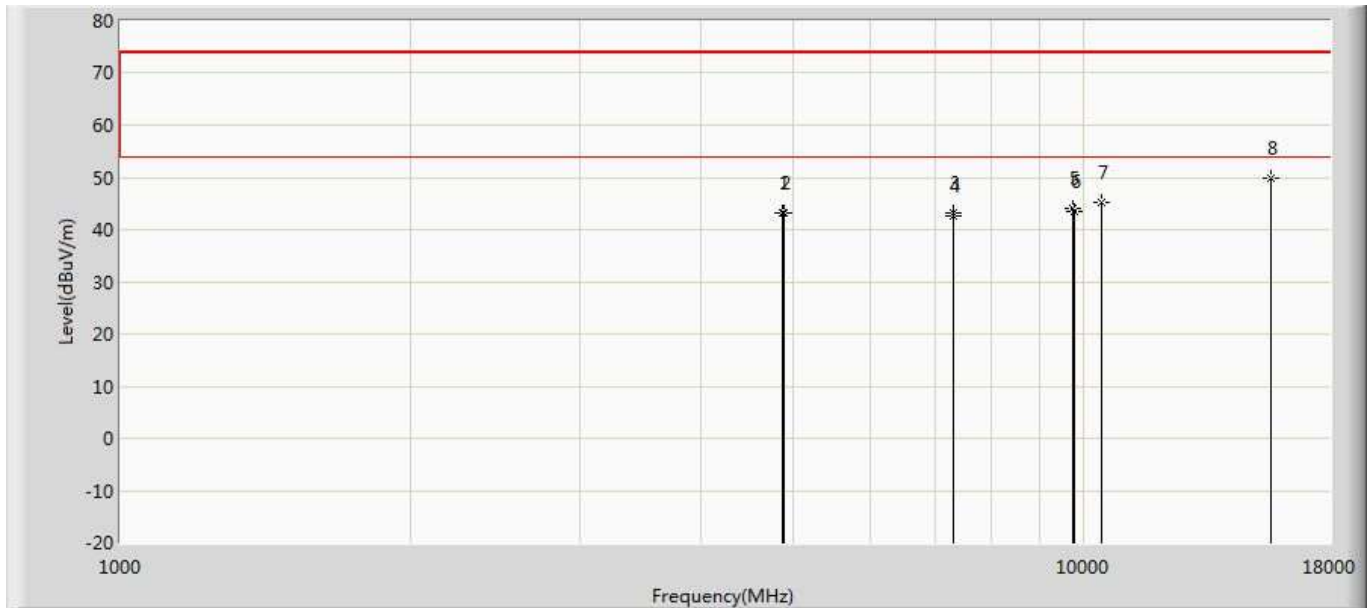

No	Mark	Frequency (MHz)	Measure Level (dBuV/m)	Reading Level (dBuV)	Over Limit (dB)	Limit (dBuV/m)	Factor (dB)	Type
1		4874.000	43.141	36.374	-30.859	74.000	6.767	PK
2		4880.000	43.187	36.459	-30.813	74.000	6.729	PK
3		7311.000	43.185	33.697	-30.815	74.000	9.488	PK
4		7320.000	42.735	33.245	-31.265	74.000	9.490	PK
5		9748.000	44.113	30.473	-29.887	74.000	13.640	PK
6		9760.000	43.340	29.875	-30.660	74.000	13.466	PK
7		10440.000	45.294	31.456	-28.706	74.000	13.838	PK
8	*	15660.000	49.777	29.476	-24.223	74.000	20.301	PK

5. Emission bandwidth and occupied bandwidth

5.1. Test Equipment

Emission bandwidth and occupied bandwidth / TR-8					
Instrument	Manufacturer	Type No.	Serial No.	Cal. Date	Cal. Due Date
Spectrum Analyzer	Agilent	N9010A	MY48030494	2020.02.04	2021.02.03
EXA Spectrum Analyzer	Keysight	N9010A	MY55370495	2020.04.09	2021.04.08
MXA Signal Analyzer	Keysight	N9020A	MY56060147	2020.04.09	2021.04.08
Temperature/Humidity Meter	zhichen	ZC1-2	TR8-TH	2020.04.10	2021.04.09

Note: All equipment are calibrated with traceable calibrations. Each calibration is traceable to the national or international standards.

5.2. Test Setup

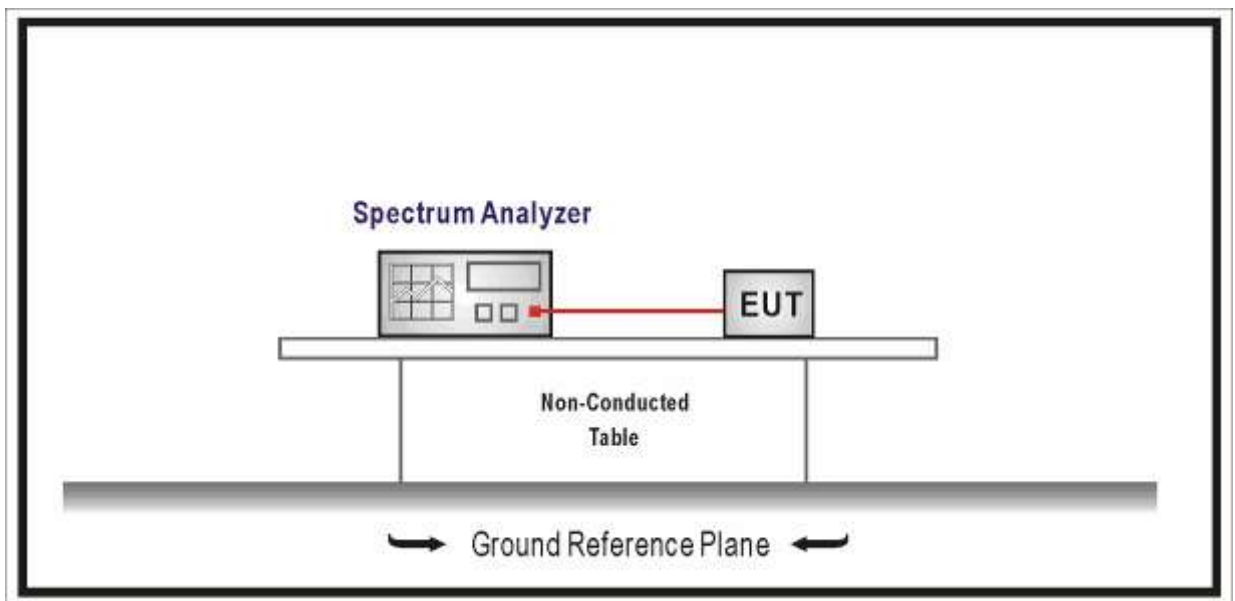





5.3. Limit

N/A

5.4. Test Procedure

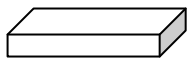
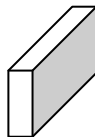
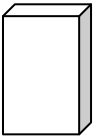
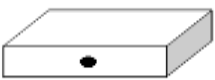
Test Method			
	References Rule	Chapter	Description
<input type="checkbox"/>	ANSI C63.10	12.4	Emission bandwidth and occupied bandwidth
	<input type="checkbox"/> ANSI C63.10	12.4.1	Emission bandwidth (26dB)
	<input type="checkbox"/> ANSI C63.10	12.4.2	Occupied bandwidth (99%)
<input checked="" type="checkbox"/>	FCC KDB 789033 D02v02r01	C	Bandwidth Measurement
	<input checked="" type="checkbox"/> FCC KDB 789033 D02v02r01	C.1	Emission Bandwidth (26dB)
	<input type="checkbox"/> FCC KDB 789033 D02v02r01	C.2	Minimum Emission Bandwidth for the band 5.725-5.85 GHz (6dB)
<input checked="" type="checkbox"/>	FCC KDB 789033 D02v02r01	D	99 Percent Occupied Bandwidth

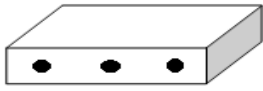
5.5. EUT test Axis definition

Item	Occupied bandwidth			
Device Category	<input type="checkbox"/>	Indoor use		
	<input checked="" type="checkbox"/>	Outdoor use		
	<input type="checkbox"/>	Fix position use		
	<input type="checkbox"/>	Client use		
Test mode	Mode 1-10			
Test method	<input type="checkbox"/>	Radiated		
		X Axis	Y Axis	Z Axis
				
		Worst Axis <input type="checkbox"/>	Worst Axis <input type="checkbox"/>	Worst Axis <input type="checkbox"/>
	<input checked="" type="checkbox"/>	Conducted		
	<input checked="" type="checkbox"/>	Chain 1		
				
	<input checked="" type="checkbox"/>	Chain 1	Chain 2	
				
	<input type="checkbox"/>	Chain 1	Chain 2	Chain 3
				
	<input checked="" type="checkbox"/>	Chain 1	Chain 2	Chain 3
				

5.6. Test Result

Product Name	: Wireless Access Point	Power	: AC 120V/60Hz
Test Mode	: Mode 1-10	Test Site	: TR8
Test Date	: 2019.11.12	Test Engineer	: Simon

Mode 1: Transmit by 802.11a					
Channel No.	Frequency (MHz)	26dB Occupied Bandwidth (MHz)	99% Occupied Bandwidth (MHz)	Lower/Higher Frequency (MHz)	Result
CH36	5180	36.25	17.279	5171.361	Pass
CH44	5220	22.80	17.111	N/A	Pass
CH48	5240	36.68	17.563	5248.782	Pass
CH52	5260	20.36	16.500	N/A	Pass
CH60	5300	20.50	16.493	N/A	Pass
CH64	5320	20.57	16.478	N/A	Pass
CH100	5500	20.50	16.484	N/A	Pass
CH116	5580	20.28	16.489	N/A	Pass
CH140	5700	20.60	16.455	N/A	Pass

Mode 2: Transmit by 802.11n(20MHz)					
Channel No.	Frequency (MHz)	26dB Occupied Bandwidth (MHz)	99% Occupied Bandwidth (MHz)	Lower/Higher Frequency (MHz)	Result
CH36	5180	31.60	18.866	5170.567	Pass
CH44	5220	29.97	18.862	N/A	Pass
CH48	5240	24.76	18.208	5249.104	Pass
CH52	5260	28.60	18.300	N/A	Pass
CH60	5300	26.97	18.481	N/A	Pass
CH64	5320	25.90	18.463	N/A	Pass
CH100	5500	24.17	18.340	N/A	Pass
CH116	5580	27.99	18.565	N/A	Pass
CH140	5700	21.97	18.492	N/A	Pass

Mode 3: Transmit by 802.11n(40MHz)					
Channel No.	Frequency (MHz)	26dB Occupied Bandwidth (MHz)	99% Occupied Bandwidth (MHz)	Lower/Higher Frequency (MHz)	Result
CH38	5190	67.16	36.521	5171.740	Pass
CH46	5230	52.61	36.517	5248.259	Pass
CH54	5270	64.14	36.558	N/A	Pass
CH62	5310	67.33	36.600	N/A	Pass
CH102	5510	67.31	36.638	N/A	Pass
CH134	5670	41.25	36.683	N/A	Pass

Mode 4: Transmit by 802.11ac(20MHz)					
Channel No.	Frequency (MHz)	26dB Occupied Bandwidth (MHz)	99% Occupied Bandwidth (MHz)	Lower/Higher Frequency (MHz)	Result
CH36	5180	31.84	18.643	5170.679	Pass
CH44	5220	30.36	18.451	N/A	Pass
CH48	5240	24.01	18.458	5249.229	Pass
CH52	5260	27.86	19.196	N/A	Pass
CH60	5300	29.10	19.230	N/A	Pass
CH64	5320	25.13	19.167	N/A	Pass
CH100	5500	25.38	19.234	N/A	Pass
CH116	5580	30.99	19.147	N/A	Pass
CH140	5700	24.54	19.123	N/A	Pass

Mode 5: Transmit by 802.11ac(40MHz)					
Channel No.	Frequency (MHz)	26dB Occupied Bandwidth (MHz)	99% Occupied Bandwidth (MHz)	Lower/Higher Frequency (MHz)	Result
CH38	5190	54.47	36.495	5171.753	Pass
CH46	5230	48.14	36.503	5248.252	Pass
CH54	5270	56.38	36.510	N/A	Pass
CH62	5310	60.42	36.542	N/A	Pass
CH102	5510	56.19	36.550	N/A	Pass
CH134	5670	43.17	36.554	N/A	Pass

Mode 6: Transmit by 802.11ac(80MHz)					
Channel No.	Frequency (MHz)	26dB Occupied Bandwidth (MHz)	99% Occupied Bandwidth (MHz)	Lower/Higher Frequency (MHz)	Result
CH42	5210	112.3	76.300	5171.85/5248.15	Pass
CH58	5290	103.6	76.184	N/A	Pass
CH106	5530	141.7	76.159	N/A	Pass

Mode 7: Transmit by 802.11ax(20MHz)					
Channel No.	Frequency (MHz)	26dB Occupied Bandwidth (MHz)	99% Occupied Bandwidth (MHz)	Lower/Higher Frequency (MHz)	Result
CH36	5180	32.46	19.367	5170.317	Pass
CH44	5220	22.04	19.119	N/A	Pass
CH48	5240	25.88	19.197	5249.599	Pass
CH52	5260	24.29	18.225	N/A	Pass
CH60	5300	27.97	18.356	N/A	Pass
CH64	5320	26.07	18.307	N/A	Pass
CH100	5500	22.78	18.374	N/A	Pass
CH116	5580	22.08	18.246	N/A	Pass
CH140	5700	21.98	18.360	N/A	Pass

Mode 8: Transmit by 802.11ax(40MHz)					
Channel No.	Frequency (MHz)	26dB Occupied Bandwidth (MHz)	99% Occupied Bandwidth (MHz)	Lower/Higher Frequency (MHz)	Result
CH38	5190	46.83	37.677	5171.162	Pass
CH46	5230	40.93	37.723	5248.862	Pass
CH54	5270	50.95	37.844	N/A	Pass
CH62	5310	40.42	37.828	N/A	Pass
CH102	5510	46.33	37.706	N/A	Pass
CH134	5670	40.23	37.782	N/A	Pass

Mode 9: Transmit by 802.11ax(80MHz)					
Channel No.	Frequency (MHz)	26dB Occupied Bandwidth (MHz)	99% Occupied Bandwidth (MHz)	Lower/Higher Frequency (MHz)	Result
CH42	5210	97.46	77.283	5171.359/5248.642	Pass
CH58	5290	89.00	77.349	N/A	Pass
CH106	5530	127.7	77.544	N/A	Pass

Mode 10: Transmit by 802.11ax(160MHz)					
Channel No.	Frequency (MHz)	26dB Occupied Bandwidth (MHz)	99% Occupied Bandwidth (MHz)	Lower/Higher Frequency (MHz)	Result
CH50	5250	164.5	155.59	5171.359/5248.642	Pass
CH114	5570	165.9	158.44	N/A	Pass

The worst case of Occupied Bandwidth as below:

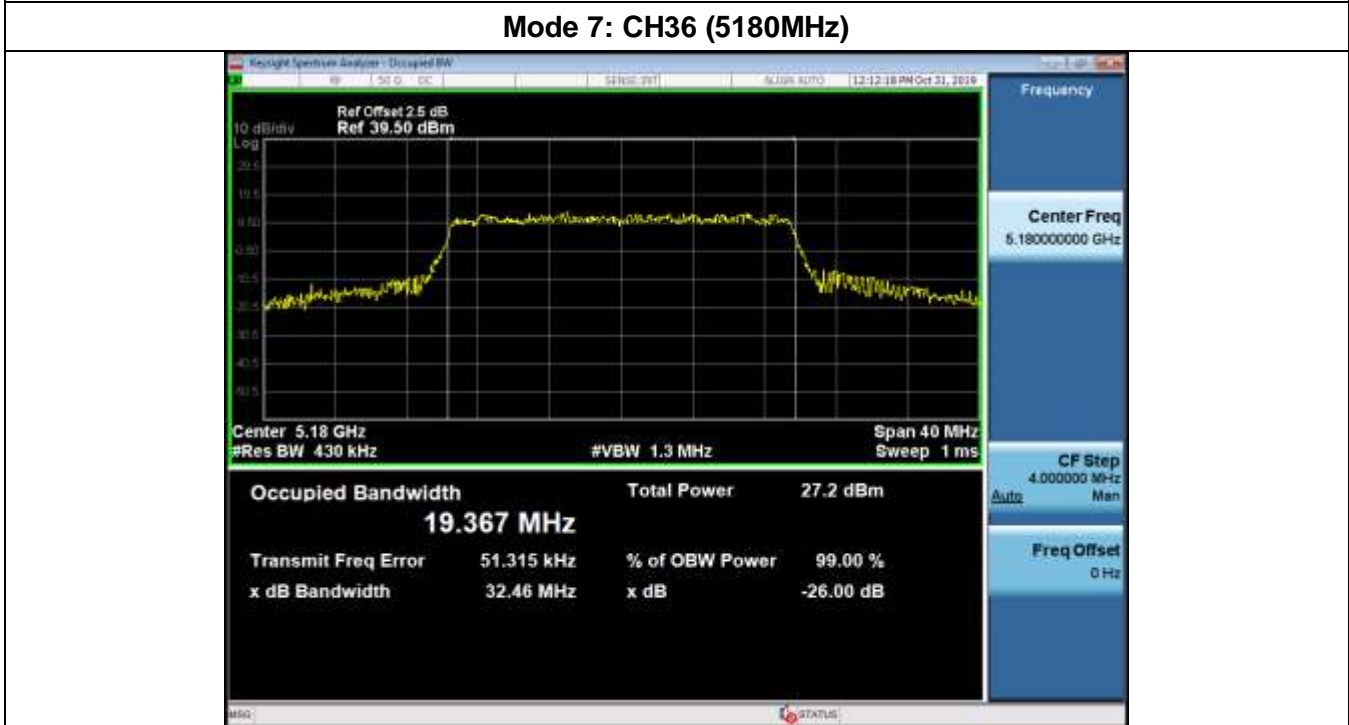

6. 6dB bandwidth

6.1. Test Equipment

6dB bandwidth / TR-8					
Instrument	Manufacturer	Type No.	Serial No.	Cal. Date	Cal. Due Date
Spectrum Analyzer	Agilent	N9010A	MY48030494	2020.02.04	2021.02.03
EXA Spectrum Analyzer	Keysight	N9010A	MY55370495	2020.04.09	2021.04.08
MXA Signal Analyzer	Keysight	N9020A	MY56060147	2020.04.09	2021.04.08
Temperature/Humidity Meter	zhichen	ZC1-2	TR8-TH	2020.04.10	2021.04.09

Note: All equipment are calibrated with traceable calibrations. Each calibration is traceable to the national or international standards.

6.2. Test Setup

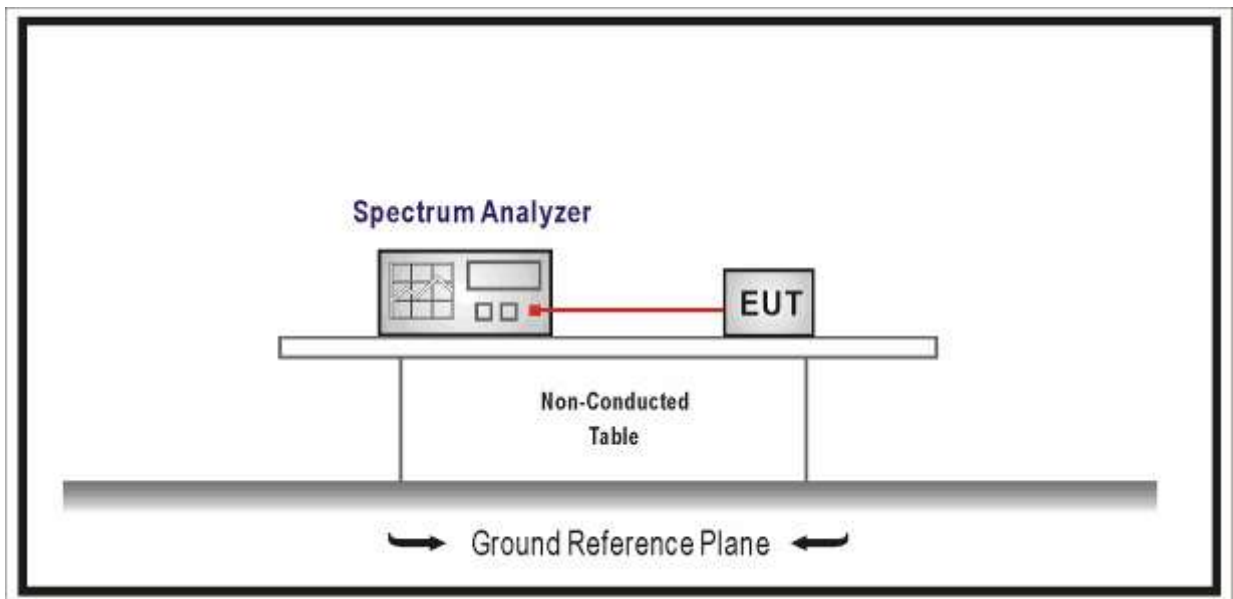





6.3. Limit

>500kHz

6.4. Test Procedure

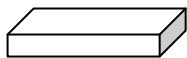
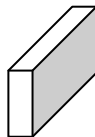
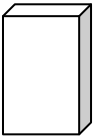
Test Method			
	References Rule	Chapter	Description
<input type="checkbox"/>	ANSI C63.10	12.4	Emission bandwidth and occupied bandwidth
	<input type="checkbox"/> ANSI C63.10	12.4.1	Emission bandwidth (26dB)
	<input type="checkbox"/> ANSI C63.10	12.4.2	Occupied bandwidth (99%)
<input checked="" type="checkbox"/>	FCC KDB 789033 D02v02r01	C	Bandwidth Measurement
	<input type="checkbox"/> FCC KDB 789033 D02v02r01	C.1	Emission Bandwidth (26dB)
	<input checked="" type="checkbox"/> FCC KDB 789033 D02v02r01	C.2	Minimum Emission Bandwidth for the band 5.725-5.85 GHz (6dB)
<input type="checkbox"/>	FCC KDB 789033 D02v02r01	D	99 Percent Occupied Bandwidth

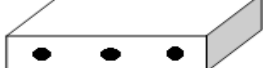
6.5. EUT test Axis definition

Item	6dB bandwidth			
Device Category	<input type="checkbox"/>	Indoor use		
	<input checked="" type="checkbox"/>	Outdoor use		
	<input type="checkbox"/>	Fix position use		
	<input type="checkbox"/>	Client use		
Test mode	Mode 1-10			
Test method	<input type="checkbox"/>	Radiated		
		X Axis	Y Axis	Z Axis
				
		Worst Axis <input type="checkbox"/>	Worst Axis <input type="checkbox"/>	Worst Axis <input type="checkbox"/>
	<input checked="" type="checkbox"/>	Conducted		
	<input checked="" type="checkbox"/>	Chain 1		
				
	<input checked="" type="checkbox"/>	Chain 1	Chain 2	
				
	<input type="checkbox"/>	Chain 1	Chain 2	Chain 3
				
	<input checked="" type="checkbox"/>	Chain 1	Chain 2	Chain 3
				

6.6. Test Result

Product Name	: Wireless Access Point	Power	: AC 120V/60Hz
Test Mode	: Mode 1-10	Test Site	: TR8
Test Date	: 2019.11.12	Test Engineer	: Simon

Mode 1: Transmit by 802.11a				
Channel No.	Frequency (MHz)	6dB Bandwidth (MHz)	Limit (kHz)	Result
149	5745	16.38	>500	Pass
157	5785	16.52		Pass
165	5825	16.49		Pass
Mode 2: Transmit by 802.11n(20MHz)				
Channel No.	Frequency (MHz)	6dB Bandwidth (MHz)	Limit (kHz)	Result
149	5745	17.59	>500	Pass
157	5785	17.62		Pass
165	5825	17.10		Pass
Mode 3: Transmit by 802.11n(40MHz)				
Channel No.	Frequency (MHz)	6dB Bandwidth (MHz)	Limit (kHz)	Result
151	5755	36.14	>500	Pass
159	5795	35.01		Pass
Mode 4: Transmit by 802.11ac(20MHz)				
Channel No.	Frequency (MHz)	6dB Bandwidth (MHz)	Limit (kHz)	Result
149	5745	17.75	>500	Pass
157	5785	17.58		Pass
165	5825	17.17		Pass

Mode 5: Transmit by 802.11ac(40MHz)				
Channel No.	Frequency (MHz)	6dB Bandwidth (MHz)	Limit (kHz)	Result
151	5755	36.13	>500	Pass
159	5795	36.13		Pass
Mode 6: Transmit by 802.11ac(80MHz)				
Channel No.	Frequency (MHz)	6dB Bandwidth (MHz)	Limit (kHz)	Result
155	5775	74.58	>500	Pass
Mode 7: Transmit by 802.11ax(20MHz)				
Channel No.	Frequency (MHz)	6dB Bandwidth (MHz)	Limit (kHz)	Result
149	5745	18.79	>500	Pass
157	5785	19.00		Pass
165	5825	19.11		Pass
Mode 8: Transmit by 802.11ax(40MHz)				
Channel No.	Frequency (MHz)	6dB Bandwidth (MHz)	Limit (kHz)	Result
151	5755	36.40	>500	Pass
159	5795	37.09		Pass
Mode 9: Transmit by 802.11ax(80MHz)				
Channel No.	Frequency (MHz)	6dB Bandwidth (MHz)	Limit (kHz)	Result
155	5775	76.66	>500	Pass

The worst case of 6dB Bandwidth as below:

Mode 1: CH149 (5745MHz)

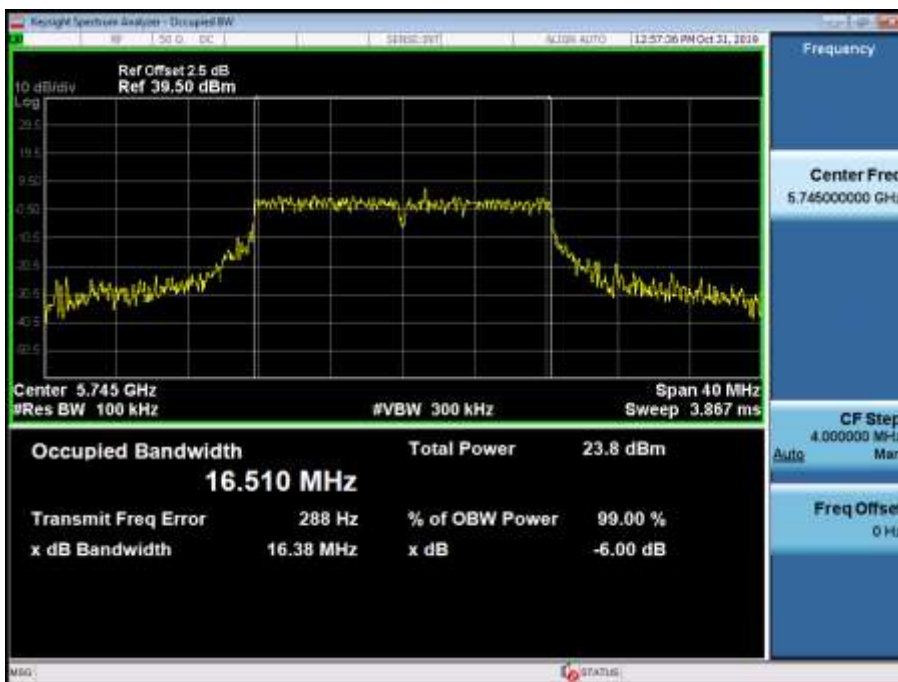

7. Power Output

7.1. Test Equipment

Power Output / TR-8					
Instrument	Manufacturer	Type No.	Serial No.	Cal. Date	Cal. Due Date
Spectrum Analyzer	Agilent	E4446A	MY45300103	2020.01.04	2021.01.03
Spectrum Analyzer	Agilent	N9010A	MY48030494	2020.02.04	2021.02.03
Wideband Peak Power Meter	Anritsu	ML2495A	0905006	2019.10.14	2020.10.13
Power Sensor	Anritsu	MA2411B	0846014	2019.10.14	2020.10.13
Temperature/Humidity Meter	zhicheng	ZC1-2	TR8-TH	2020.04.10	2021.04.09

Note: All equipment are calibrated with traceable calibrations. Each calibration is traceable to the national or international standards.

7.2. Test Setup

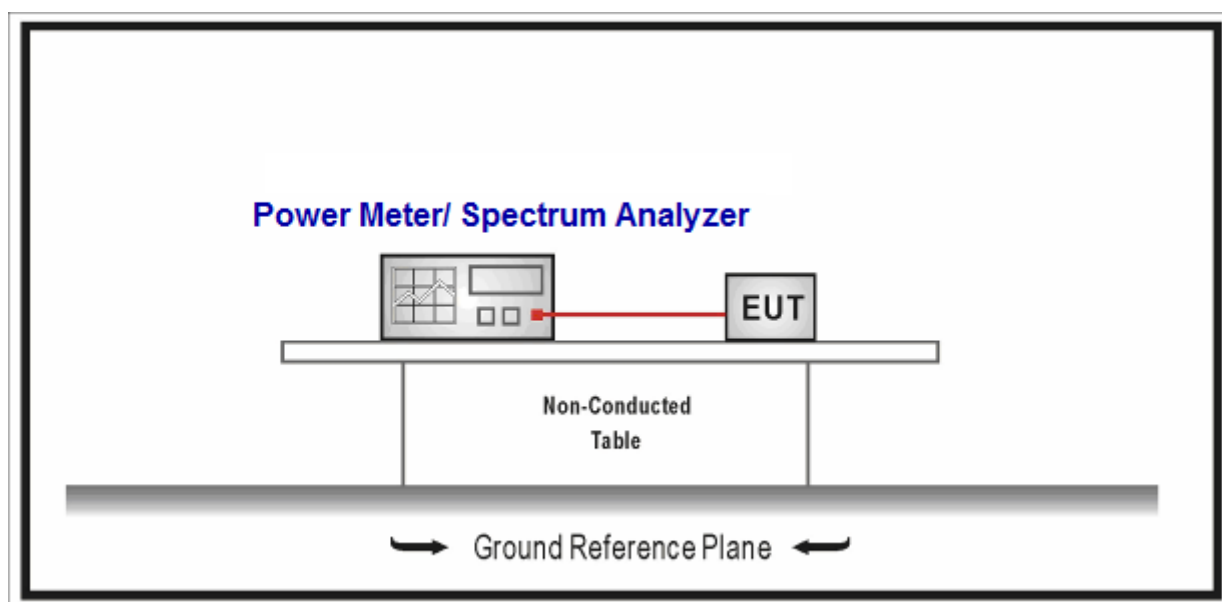

7.3. Limit



Fundamental emission output power Limit	
<input checked="" type="checkbox"/>	For the band 5.15-5.25 GHz
<input checked="" type="checkbox"/>	Outdoor access point: the maximum conducted output power shall not exceed 1 W. If $G_{TX} > 6\text{dBi}$, then $P_{out} \leq 30 - (G_{TX} - 6)$ and $\leq 125\text{mW}$ at any angle above 30 degrees
<input type="checkbox"/>	Indoor access point: the maximum conducted output power shall not exceed 1 W. If $G_{TX} > 6\text{dBi}$, then $P_{out} \leq 30 - (G_{TX} - 6)$
<input type="checkbox"/>	Fixed point-to-point access points: the maximum conducted output power shall not exceed 1 W. If $G_{TX} > 23\text{dBi}$, then $P_{out} \leq 30 - (G_{TX} - 23)$
<input type="checkbox"/>	Mobile and portable client devices: the maximum conducted output power shall not exceed 250mW. If $G_{TX} > 6\text{dBi}$, then $P_{out} \leq 24 - (G_{TX} - 6)$
<input checked="" type="checkbox"/>	For the band 5.25-5.35 GHz:
<input checked="" type="checkbox"/>	The maximum conducted output power shall not exceed 250mW or $11\text{dBm} + 10 \text{Log B}$, where B is the 26dB emission bandwidth in MHz. If $G_{TX} > 6\text{dBi}$, then $P_{out} \leq (\text{The lesser of } 24 \text{ or } 11\text{dBm} + 10 \text{Log B}) - (G_{TX} - 6)$
<input checked="" type="checkbox"/>	For the 5.47-5.725 GHz:
<input checked="" type="checkbox"/>	The maximum conducted output power shall not exceed 250mW or $11\text{dBm} + 10 \text{Log B}$, where B is the 26dB emission bandwidth in MHz. If $G_{TX} > 6\text{dBi}$, then $P_{out} \leq (\text{The lesser of } 24 \text{ or } 11\text{dBm} + 10 \text{Log B}) - (G_{TX} - 6)$
<input checked="" type="checkbox"/>	For the band 5.725-5.85 GHz:
<input checked="" type="checkbox"/>	Point-to-multipoint systems (P2M): the maximum conducted output power (P_{Out}) shall not exceed the lesser of 1 W. If $G_{TX} > 6 \text{ dBi}$, then $P_{Out} = 30 - (G_{TX} - 6)$
<input type="checkbox"/>	Point-to-point systems (P2P): the maximum conducted output power (P_{Out}) shall not exceed the lesser of 1 W
Note 1 : G_{TX} directional gain of transmitting antennas.	
Note 2 : P_{out} is maximum peak conducted output power .	

7.4. Test Procedure

Fundamental emission output power Test Method			
	References Rule	Chapter	Description
<input checked="" type="checkbox"/>	ANSI C63.10	12.3	Maximum conducted output power
<input checked="" type="checkbox"/>	ANSI C63.10	12.3.2	Maximum conducted output power measurement using a spectrum analyzer (SA) or EMI receiver
<input type="checkbox"/>	ANSI C63.10	12.3.2.2	Method SA-1
<input type="checkbox"/>	ANSI C63.10	12.3.2.3	Method SA-1A (alternative)
<input checked="" type="checkbox"/>	ANSI C63.10	12.3.2.4	Method SA-2
<input type="checkbox"/>	ANSI C63.10	12.3.2.5	Method SA-2A (alternative)
<input type="checkbox"/>	ANSI C63.10	12.3.2.6	Method SA-3
<input type="checkbox"/>	ANSI C63.10	12.3.2.7	Method SA-3A (alternative)
<input checked="" type="checkbox"/>	ANSI C63.10	12.3.3	Maximum conducted output power using a power meter
<input type="checkbox"/>	ANSI C63.10	12.3.3.1	Method PM
<input checked="" type="checkbox"/>	ANSI C63.10	12.3.3.2	Method PM-G

Directional Gain Calculations for In-Band test method				
	References	Rule	Chapter	Description
<input type="checkbox"/>	KDB 662911		F2)a)	Basic methodology
	<input type="checkbox"/>	KDB 662911	F2)a) (i)	transmit signals are correlated
	<input type="checkbox"/>	KDB 662911	F2)a) (ii)	transmit signals are uncorrelated
<input type="checkbox"/>	KDB 662911		F2)b)	Sectorized antenna systems.
<input type="checkbox"/>	KDB 662911		F2)c)	Cross-polarized antennas
	<input type="checkbox"/>	ANSI C63.10	F2)c) (i)	Cross-polarized antennas
	<input type="checkbox"/>	ANSI C63.10	F2)c) (ii)	Multiple antennas
<input checked="" type="checkbox"/>	KDB 662911		F2)e)	Spatial stream
	<input type="checkbox"/>	KDB 662911	F2)e) (i)	Antennas have the same gain
	<input type="checkbox"/>	KDB 662911	F2)e) (ii)	Antenna have the different gain with one spatial stream
	<input checked="" type="checkbox"/>	KDB 662911	F2)e) (iii)	Antenna have the different gain with more than one spatial stream
<input checked="" type="checkbox"/>	KDB 662911		F2)f)	Cyclic Delay Diversity (CDD)
	<input type="checkbox"/>	KDB 662911	F2)f) (i)	Antennas have the same gain
	<input type="checkbox"/>	KDB 662911	F2)f) (ii)	Antenna have the different gain with one spatial stream
	<input checked="" type="checkbox"/>	KDB 662911	F2)f) (iii)	Antenna have the different gain with more than one spatial stream

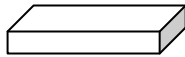
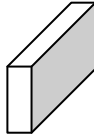
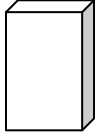
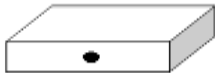
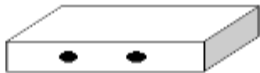
7.5. EUT test Axis definition

Item	output power			
Device Category	<input type="checkbox"/>	Indoor use		
	<input checked="" type="checkbox"/>	Outdoor use		
	<input type="checkbox"/>	Fix position use		
	<input type="checkbox"/>	Client use		
Test mode	Mode 1-10			
Test method	<input type="checkbox"/>	Radiated		
		X Axis	Y Axis	Z Axis
				
		Worst Axis <input type="checkbox"/>	Worst Axis <input type="checkbox"/>	Worst Axis <input type="checkbox"/>
	<input checked="" type="checkbox"/>	Conducted		
	<input checked="" type="checkbox"/>	Chain 1		
				
	<input checked="" type="checkbox"/>	Chain 1	Chain 2	
				
	<input type="checkbox"/>	Chain 1	Chain 2	Chain 3
				
<input checked="" type="checkbox"/>	Chain 1	Chain 2	Chain 3	Chain 4
				

7.6. Test Result

Pass

The test data please refer to the files attached.

Appendix 4: 5GHz FCC&ISED RF output power

Appendix 5: 5.15~5.25GHz above 30° antenna gain

8. Peak Power Spectral Density

8.1. Test Equipment

Peak Power Spectral Density / TR-8					
Instrument	Manufacturer	Type No.	Serial No.	Cal. Date	Cal. Due Date
Spectrum Analyzer	Agilent	N9010A	MY48030494	2020.02.04	2021.02.03
EXA Spectrum Analyzer	Keysight	N9010A	MY55370495	2020.04.09	2021.04.08
MXA Signal Analyzer	Keysight	N9020A	MY56060147	2020.04.09	2021.04.08
Temperature/Humidity Meter	zhichen	ZC1-2	TR8-TH	2020.04.10	2021.04.09

Note: All equipment are calibrated with traceable calibrations. Each calibration is traceable to the national or international standards.

8.2. Test Setup

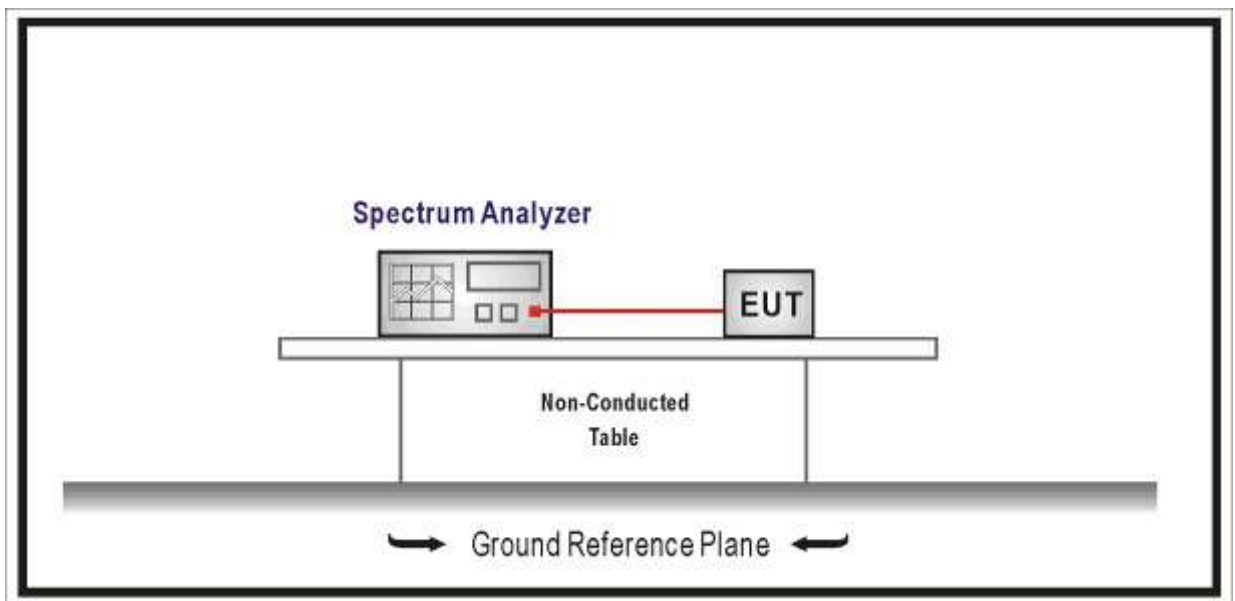

8.3. Limit



Fundamental emission output power Limit	
<input checked="" type="checkbox"/>	For the band 5.15-5.25 GHz
<input checked="" type="checkbox"/>	Outdoor access point: the maximum power spectral density shall not exceed 17 dBm/MHz. If $G_{TX} > 6\text{dBi}$, then $P_{out} \leq 17 - (G_{TX} - 6)$
<input type="checkbox"/>	Indoor access point: the maximum power spectral density shall not exceed 17 dBm/MHz. If $G_{TX} > 6\text{dBi}$, then $P_{out} \leq 17 - (G_{TX} - 6)$
<input type="checkbox"/>	Fixed point-to-point access points: the maximum power spectral density shall not exceed 17 dBm/MHz. If $G_{TX} > 23\text{dBi}$, then $P_{out} \leq 17 - (G_{TX} - 23)$
<input type="checkbox"/>	Mobile and portable client devices: the maximum power spectral density shall not exceed 11 dBm/MHz. If $G_{TX} > 6\text{dBi}$, then $P_{out} \leq 11 - (G_{TX} - 6)$
<input checked="" type="checkbox"/>	For the 5.25-5.35 GHz:
<input checked="" type="checkbox"/>	the maximum power spectral density shall not exceed 11 dBm/MHz. If $G_{TX} > 6\text{dBi}$, then $P_{out} \leq 11 - (G_{TX} - 6)$
<input checked="" type="checkbox"/>	For the 5.47-5.725 GHz:
<input checked="" type="checkbox"/>	the maximum power spectral density shall not exceed 11 dBm/MHz. If $G_{TX} > 6\text{dBi}$, then $P_{out} \leq 11 - (G_{TX} - 6)$
<input checked="" type="checkbox"/>	For the band 5.725-5.85 GHz:
<input checked="" type="checkbox"/>	the maximum power spectral density shall not exceed 30 dBm/500KHz. If $G_{TX} > 6\text{dBi}$, then $P_{out} \leq 30 - (G_{TX} - 6)$
Note 1: G_{TX} directional gain of transmitting antennas.	
Note 2: P_{out} is maximum peak conducted output power.	

Directional Gain Calculations for In-Band test method				
	References	Rule	Chapter	Description
<input type="checkbox"/>	KDB 662911		F2)a)	Basic methodology
	<input type="checkbox"/>	KDB 662911	F2)a) (i)	transmit signals are correlated
	<input type="checkbox"/>	KDB 662911	F2)a) (ii)	transmit signals are uncorrelated
<input type="checkbox"/>	KDB 662911		F2)b)	Sectorized antenna systems.
<input type="checkbox"/>	KDB 662911		F2)c)	Cross-polarized antennas
	<input type="checkbox"/>	ANSI C63.10	F2)c) (i)	Cross-polarized antennas
	<input type="checkbox"/>	ANSI C63.10	F2)c) (ii)	Multiple antennas
<input checked="" type="checkbox"/>	KDB 662911		F2)e)	Spatial stream
	<input type="checkbox"/>	KDB 662911	F2)e) (i)	Antennas have the same gain
	<input type="checkbox"/>	KDB 662911	F2)e) (ii)	Antenna have the different gain with one spatial stream
	<input checked="" type="checkbox"/>	KDB 662911	F2)e) (iii)	Antenna have the different gain with more than one spatial stream
<input checked="" type="checkbox"/>	KDB 662911		F2)f)	Cyclic Delay Diversity (CDD)
	<input type="checkbox"/>	KDB 662911	F2)f) (i)	Antennas have the same gain
	<input type="checkbox"/>	KDB 662911	F2)f) (ii)	Antenna have the different gain with one spatial stream
	<input checked="" type="checkbox"/>	KDB 662911	F2)f) (iii)	Antenna have the different gain with more than one spatial stream

8.4. Test Procedure

Fundamental emission output power Test Method			
	References Rule	Chapter	Description
<input checked="" type="checkbox"/>	ANSI C63.10	12.5	Peak power spectral density
<input checked="" type="checkbox"/>	FCC KDB 789033 D02v02r01	F	Maximum Power Spectral Density (PSD)

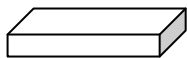
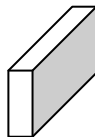
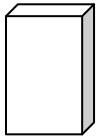
8.5. EUT test Axis definition

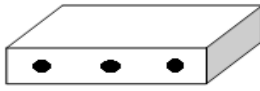
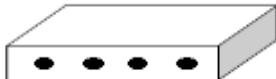
Item	Power Spectral Density			
Device Category	<input type="checkbox"/>	Indoor use		
	<input checked="" type="checkbox"/>	Outdoor use		
	<input type="checkbox"/>	Fix position use		
	<input type="checkbox"/>	Client use		
Test mode	Mode 1-10			
Test method	<input type="checkbox"/>	Radiated		
		X Axis	Y Axis	Z Axis
				
		Worst Axis <input type="checkbox"/>	Worst Axis <input type="checkbox"/>	Worst Axis <input type="checkbox"/>
	<input checked="" type="checkbox"/>	Conducted		
	<input checked="" type="checkbox"/>	Chain 1		
				
	<input checked="" type="checkbox"/>	Chain 1	Chain 2	
				
	<input type="checkbox"/>	Chain 1	Chain 2	Chain 3
				
	<input checked="" type="checkbox"/>	Chain 1	Chain 2	Chain 3
				

8.6. Test Result

Product Name	: Wireless Access Point	Power	: AC 120V/60Hz
Test Mode	: Mode 1~10	Test Site	: TR8
Test Date	: 2019.11.18	Test Engineer	: Simon

Product Name	: Wireless Access Point	Power	: AC 120V/60Hz
Test Mode	: Mode 1~10	Test Site	: TR8
Test Date	: 2019.11.18	Test Engineer	: Simon

Radio 1:

Mode 1: Transmit by 802.11a with SISO						
Channel No.	Frequency (MHz)	Measurement Power Spectral Density (dBm/MHz)	Duty factor	Total Measurement PSD (dBm/MHz)	Limit (dBm/MHz)	Result
		Worst Chain				
CH36	5180	6.812	0.237	7.049	17	Pass
CH44	5220	7.508	0.237	7.745	17	Pass
CH48	5240	7.801	0.237	8.038	17	Pass
CH52	5260	8.357	0.237	8.594	11	Pass
CH60	5300	8.248	0.237	8.485	11	Pass
CH64	5320	8.226	0.237	8.463	11	Pass
CH100	5500	7.275	0.237	7.512	11	Pass
CH116	5580	8.103	0.237	8.340	11	Pass
CH140	5700	7.154	0.237	7.391	11	Pass
Channel No.	Frequency (MHz)	Measurement Power Spectral Density (dBm/500KHz)	Duty factor	Total Measurement PSD (dBm/500KHz)	Limit (dBm/500KHz)	Limit (dBm/500KHz)
		Worst Chain				
CH149	5745	5.817	0.237	6.054	30	Pass
CH157	5785	3.234	0.237	3.471	30	Pass
CH165	5825	4.652	0.237	4.889	30	Pass

Mode 2: Transmit by 802.11n(20MHz) with SISO						
Channel No.	Frequency (MHz)	Measurement Power Spectral Density (dBm/MHz)	Duty factor	Total Measurement PSD (dBm/MHz)	Limit (dBm/MHz)	Result
		Worst Chain				
CH36	5180	6.731	0.231	6.962	17	Pass
CH44	5220	7.524	0.231	7.755	17	Pass
CH48	5240	7.789	0.231	8.020	17	Pass
CH52	5260	8.272	0.231	8.503	11	Pass
CH60	5300	8.139	0.231	8.370	11	Pass
CH64	5320	7.941	0.231	8.172	11	Pass
CH100	5500	7.954	0.231	8.185	11	Pass
CH116	5580	7.988	0.231	8.219	11	Pass
CH140	5700	7.035	0.231	7.266	11	Pass
Channel No.	Frequency (MHz)	Measurement Power Spectral Density (dBm/500KHz)	Duty factor	Total Measurement PSD (dBm/500KHz)	Limit (dBm/500KHz)	Limit (dBm/500KHz)
		Worst Chain				
CH149	5745	5.845	0.231	6.076	30	Pass
CH157	5785	5.389	0.231	5.620	30	Pass
CH165	5825	4.516	0.231	4.747	30	Pass

Mode 3: Transmit by 802.11n(40MHz) with SISO						
Channel No.	Frequency (MHz)	Measurement Power Spectral Density (dBm/MHz)	Duty factor	Total Measurement PSD (dBm/MHz)	Limit (dBm/MHz)	Result
		Worst Chain				
CH38	5190	1.362	0.598	1.960	17	Pass
CH46	5230	3.815	0.598	4.413	17	Pass
CH54	5270	5.093	0.598	5.691	11	Pass
CH62	5310	5.172	0.598	5.770	11	Pass
CH102	5510	4.632	0.598	5.230	11	Pass
CH134	5670	4.073	0.598	4.671	11	Pass
Channel No.	Frequency (MHz)	Measurement Power Spectral Density (dBm/500KHz)	Duty factor	Total Measurement PSD (dBm/500KHz)	Limit (dBm/500KHz)	Limit (dBm/500KHz)
		Worst Chain				
CH151	5755	2.482	0.598	3.080	30	Pass
CH159	5795	1.922	0.598	2.520	30	Pass

Mode 4: Transmit by 802.11ac(20MHz) with SISO						
Channel No.	Frequency (MHz)	Measurement Power Spectral Density (dBm/MHz)	Duty factor	Total Measurement PSD (dBm/MHz)	Limit (dBm/MHz)	Result
		Worst Chain				
CH36	5180	6.676	0.090	6.766	17	Pass
CH44	5220	7.585	0.090	7.675	17	Pass
CH48	5240	7.704	0.090	7.794	17	Pass
CH52	5260	8.193	0.090	8.283	11	Pass
CH60	5300	8.274	0.090	8.364	11	Pass
CH64	5320	8.362	0.090	8.452	11	Pass
CH100	5500	7.936	0.090	8.026	11	Pass
CH116	5580	7.920	0.090	8.010	11	Pass
CH140	5700	7.210	0.090	7.300	11	Pass
Channel No.	Frequency (MHz)	Measurement Power Spectral Density (dBm/500KHz)	Duty factor	Total Measurement PSD (dBm/500KHz)	Limit (dBm/500KHz)	Limit (dBm/500KHz)
		Worst Chain				
CH149	5745	5.749	0.090	5.839	30	Pass
CH157	5785	5.204	0.090	5.294	30	Pass
CH165	5825	4.569	0.090	4.659	30	Pass

Mode 5: Transmit by 802.11ac(40MHz) with SISO						
Channel No.	Frequency (MHz)	Measurement Power Spectral Density (dBm/MHz)	Duty factor	Total Measurement PSD (dBm/MHz)	Limit (dBm/MHz)	Result
		Worst Chain				
CH38	5190	1.205	0.297	1.502	17	Pass
CH46	5230	3.824	0.297	4.121	17	Pass
CH54	5270	5.149	0.297	5.446	11	Pass
CH62	5310	5.145	0.297	5.442	11	Pass
CH102	5510	4.480	0.297	4.777	11	Pass
CH134	5670	4.228	0.297	4.525	11	Pass
Channel No.	Frequency (MHz)	Measurement Power Spectral Density (dBm/500KHz)	Duty factor	Total Measurement PSD (dBm/500KHz)	Limit (dBm/500KHz)	Limit (dBm/500KHz)
		Worst Chain				
CH151	5755	2.570	0.297	2.867	30	Pass
CH159	5795	1.740	0.297	2.037	30	Pass

Mode 6: Transmit by 802.11ac(80MHz) with SISO						
Channel No.	Frequency (MHz)	Measurement Power Spectral Density (dBm/MHz)	Duty factor	Total Measurement PSD (dBm/MHz)	Limit (dBm/MHz)	Result
		Worst Chain				
CH42	5210	-0.990	0.572	-0.418	17	Pass
CH58	5290	2.414	0.572	2.986	11	Pass
CH106	5530	1.974	0.572	2.546	11	Pass
Channel No.	Frequency (MHz)	Measurement Power Spectral Density (dBm/500KHz)	Duty factor	Total Measurement PSD (dBm/500KHz)	Limit (dBm/500KHz)	Limit (dBm/500KHz)
		Worst Chain				
CH155	5775	-0.855	0.572	-0.283	30	Pass

Mode 7: Transmit by 802.11ax(20MHz) with SISO						
Channel No.	Frequency (MHz)	Measurement Power Spectral Density (dBm/MHz)	Duty factor	Total Measurement PSD (dBm/MHz)	Limit (dBm/MHz)	Result
		Worst Chain				
CH36	5180	6.695	0.130	6.825	17	Pass
CH44	5220	7.625	0.130	7.755	17	Pass
CH48	5240	7.858	0.130	7.988	17	Pass
CH52	5260	8.221	0.130	8.351	11	Pass
CH60	5300	8.154	0.130	8.284	11	Pass
CH64	5320	8.028	0.130	8.158	11	Pass
CH100	5500	7.814	0.130	7.944	11	Pass
CH116	5580	7.743	0.130	7.873	11	Pass
CH140	5700	7.082	0.130	7.212	11	Pass
Channel No.	Frequency (MHz)	Measurement Power Spectral Density (dBm/500KHz)	Duty factor	Total Measurement PSD (dBm/500KHz)	Limit (dBm/500KHz)	Limit (dBm/500KHz)
		Worst Chain				
CH149	5745	5.757	0.130	5.887	30	Pass
CH157	5785	5.568	0.130	5.698	30	Pass
CH165	5825	4.483	0.130	4.613	30	Pass

Mode 8: Transmit by 802.11ax(40MHz) with SISO						
Channel No.	Frequency (MHz)	Measurement Power Spectral Density (dBm/MHz)	Duty factor	Total Measurement PSD (dBm/MHz)	Limit (dBm/MHz)	Result
		Worst Chain				
CH38	5190	1.455	0.419	1.874	17	Pass
CH46	5230	4.191	0.419	4.610	17	Pass
CH54	5270	5.065	0.419	5.484	11	Pass
CH62	5310	5.038	0.419	5.457	11	Pass
CH102	5510	4.560	0.419	4.979	11	Pass
CH134	5670	4.136	0.419	4.555	11	Pass
Channel No.	Frequency (MHz)	Measurement Power Spectral Density (dBm/500KHz)	Duty factor	Total Measurement PSD (dBm/500KHz)	Limit (dBm/500KHz)	Limit (dBm/500KHz)
		Worst Chain				
CH151	5755	2.432	0.419	2.851	30	Pass
CH159	5795	1.997	0.419	2.416	30	Pass

Mode 9: Transmit by 802.11ax(80MHz) with SISO						
Channel No.	Frequency (MHz)	Measurement Power Spectral Density (dBm/MHz)	Duty factor	Total Measurement PSD (dBm/MHz)	Limit (dBm/MHz)	Result
		Worst Chain				
CH42	5210	-0.856	0.733	-0.123	17	Pass
CH58	5290	2.178	0.733	2.911	11	Pass
CH106	5530	1.966	0.733	2.699	11	Pass
Channel No.	Frequency (MHz)	Measurement Power Spectral Density (dBm/500KHz)	Duty factor	Total Measurement PSD (dBm/500KHz)	Limit (dBm/500KHz)	Limit (dBm/500KHz)
		Worst Chain				
CH155	5775	-0.768	0.733	-0.035	30	Pass

Radio 2:

Mode 1: Transmit by 802.11a with SISO						
Channel No.	Frequency (MHz)	Measurement Power Spectral Density (dBm/MHz)	Duty factor	Total Measurement PSD (dBm/MHz)	Limit (dBm/MHz)	Result
		Worst Chain				
CH36	5180	6.806	0.247	7.053	17	Pass
CH44	5220	5.016	0.247	5.263	17	Pass
CH48	5240	7.436	0.247	7.683	17	Pass
CH52	5260	8.296	0.247	8.543	11	Pass
CH60	5300	8.843	0.247	9.090	11	Pass
CH64	5320	8.949	0.247	9.196	11	Pass

Mode 1: Transmit by 802.11a with 2*2 CDD						
Channel No.	Frequency (MHz)	Measurement Power Spectral Density (dBm/MHz)	Duty factor	Total Measurement PSD (dBm/MHz)	Limit (dBm/MHz)	Result
		Worst Chain				
CH36	5180	3.995	0.247	4.242	13.42	Pass
CH44	5220	7.463	0.247	7.710	13.42	Pass
CH48	5240	7.332	0.247	7.579	13.42	Pass
CH52	5260	5.955	0.247	6.202	7.42	Pass
CH60	5300	6.140	0.247	6.387	7.42	Pass
CH64	5320	6.023	0.247	6.270	7.42	Pass

Mode 2: Transmit by 802.11n(20MHz)with SISO						
Channel No.	Frequency (MHz)	Measurement Power Spectral Density (dBm/MHz)	Duty factor	Total Measurement PSD (dBm/MHz)	Limit (dBm/MHz)	Result
		Worst Chain				
CH36	5180	6.659	0.242	6.901	17	Pass
CH44	5220	7.770	0.242	8.012	17	Pass
CH48	5240	7.303	0.242	7.545	17	Pass
CH52	5260	8.305	0.242	8.547	11	Pass
CH60	5300	8.802	0.242	9.044	11	Pass
CH64	5320	8.777	0.242	9.019	11	Pass

Mode 2: Transmit by 802.11n(20MHz)with 2*2 CDD						
Channel No.	Frequency (MHz)	Measurement Power Spectral Density (dBm/MHz)	Duty factor	Total Measurement PSD (dBm/MHz)	Limit (dBm/MHz)	Result
		Worst Chain				
CH36	5180	4.045	0.242	4.287	13.42	Pass
CH44	5220	7.967	0.242	8.209	13.42	Pass
CH48	5240	7.423	0.242	7.665	13.42	Pass
CH52	5260	5.698	0.242	5.940	7.42	Pass
CH60	5300	6.172	0.242	6.414	7.42	Pass
CH64	5320	6.058	0.242	6.300	7.42	Pass

Mode 2: Transmit by 802.11n(20MHz)with 2*2 Beamforming						
Channel No.	Frequency (MHz)	Measurement Power Spectral Density (dBm/MHz)	Duty factor	Total Measurement PSD (dBm/MHz)	Limit (dBm/MHz)	Result
		Worst Chain				
CH36	5180	3.453	0.244	3.697	13.42	Pass
CH44	5220	7.022	0.244	7.266	13.42	Pass
CH48	5240	7.179	0.244	7.423	13.42	Pass
CH52	5260	4.564	0.244	4.808	7.42	Pass
CH60	5300	5.228	0.244	5.472	7.42	Pass
CH64	5320	5.249	0.244	5.493	7.42	Pass

Mode 3: Transmit by 802.11n(40MHz)with SISO						
Channel No.	Frequency (MHz)	Measurement Power Spectral Density (dBm/MHz)	Duty factor	Total Measurement PSD (dBm/MHz)	Limit (dBm/MHz)	Result
		Worst Chain				
CH38	5190	2.505	0.585	3.090	17	Pass
CH46	5230	4.935	0.585	5.520	17	Pass
CH54	5270	5.431	0.585	6.016	11	Pass
CH62	5310	5.654	0.585	6.239	11	Pass

Mode 3: Transmit by 802.11n(40MHz)with 2*2 CDD						
Channel No.	Frequency (MHz)	Measurement Power Spectral Density (dBm/MHz)	Duty factor	Total Measurement PSD (dBm/MHz)	Limit (dBm/MHz)	Result
		Worst Chain				
CH38	5190	-0.077	0.585	0.508	13.42	Pass
CH46	5230	4.836	0.585	5.421	13.42	Pass
CH54	5270	2.217	0.585	2.802	7.42	Pass
CH62	5310	2.778	0.585	3.363	7.42	Pass

Mode 3: Transmit by 802.11n(40MHz)with 2*2 Beamforming						
Channel No.	Frequency (MHz)	Measurement Power Spectral Density (dBm/MHz)	Duty factor	Total Measurement PSD (dBm/MHz)	Limit (dBm/MHz)	Result
		Worst Chain				
CH38	5190	-0.683	0.601	-0.082	13.42	Pass
CH46	5230	4.073	0.601	4.674	13.42	Pass
CH54	5270	1.999	0.601	2.600	7.42	Pass
CH62	5310	2.297	0.601	2.898	7.42	Pass

Mode 4: Transmit by 802.11ac(20MHz)with SISO						
Channel No.	Frequency (MHz)	Measurement Power Spectral Density (dBm/MHz)	Duty factor	Total Measurement PSD (dBm/MHz)	Limit (dBm/MHz)	Result
		Worst Chain				
CH36	5180	6.693	0.090	6.783	17	Pass
CH44	5220	7.731	0.090	7.821	17	Pass
CH48	5240	7.474	0.090	7.564	17	Pass
CH52	5260	8.387	0.090	8.477	11	Pass
CH60	5300	8.560	0.090	8.650	11	Pass
CH64	5320	8.894	0.090	8.984	11	Pass

Mode 4: Transmit by 802.11ac(20MHz)with 2*2 CDD						
Channel No.	Frequency (MHz)	Measurement Power Spectral Density (dBm/MHz)	Duty factor	Total Measurement PSD (dBm/MHz)	Limit (dBm/MHz)	Result
		Worst Chain				
CH36	5180	4.090	0.090	4.180	13.42	Pass
CH44	5220	7.738	0.090	7.828	13.42	Pass
CH48	5240	7.276	0.090	7.366	13.42	Pass
CH52	5260	5.793	0.090	5.883	7.42	Pass
CH60	5300	6.149	0.090	6.239	7.42	Pass
CH64	5320	5.773	0.090	5.863	7.42	Pass

Mode 4: Transmit by 802.11ac(20MHz)with 2*2 Beamforming						
Channel No.	Frequency (MHz)	Measurement Power Spectral Density (dBm/MHz)	Duty factor	Total Measurement PSD (dBm/MHz)	Limit (dBm/MHz)	Result
		Worst Chain				
CH36	5180	3.355	0.090	3.445	13.42	Pass
CH44	5220	7.051	0.090	7.141	13.42	Pass
CH48	5240	6.972	0.090	7.062	13.42	Pass
CH52	5260	4.730	0.090	4.820	7.42	Pass
CH60	5300	5.077	0.090	5.167	7.42	Pass
CH64	5320	5.215	0.090	5.305	7.42	Pass

Mode 5: Transmit by 802.11ac(40MHz)with SISO						
Channel No.	Frequency (MHz)	Measurement Power Spectral Density (dBm/MHz)	Duty factor	Total Measurement PSD (dBm/MHz)	Limit (dBm/MHz)	Result
		Worst Chain				
CH38	5190	2.414	0.315	2.729	17	Pass
CH46	5230	4.788	0.315	5.103	17	Pass
CH54	5270	5.400	0.315	5.715	11	Pass
CH62	5310	5.765	0.315	6.080	11	Pass

Mode 5: Transmit by 802.11ac(40MHz)with 2*2 CDD						
Channel No.	Frequency (MHz)	Measurement Power Spectral Density (dBm/MHz)	Duty factor	Total Measurement PSD (dBm/MHz)	Limit (dBm/MHz)	Result
		Worst Chain				
CH38	5190	-0.077	0.315	0.238	13.42	Pass
CH46	5230	4.755	0.315	5.070	13.42	Pass
CH54	5270	2.467	0.315	2.782	7.42	Pass
CH62	5310	2.368	0.315	2.683	7.42	Pass

Mode 5: Transmit by 802.11ac(40MHz)with 2*2 Beamforming						
Channel No.	Frequency (MHz)	Measurement Power Spectral Density (dBm/MHz)	Duty factor	Total Measurement PSD (dBm/MHz)	Limit (dBm/MHz)	Result
		Worst Chain				
CH38	5190	-0.533	0.302	-0.231	13.42	Pass
CH46	5230	4.172	0.302	4.474	13.42	Pass
CH54	5270	1.626	0.302	1.928	7.42	Pass
CH62	5310	2.284	0.302	2.586	7.42	Pass

Mode 6: Transmit by 802.11ac(80MHz)with SISO						
Channel No.	Frequency (MHz)	Measurement Power Spectral Density (dBm/MHz)	Duty factor	Total Measurement PSD (dBm/MHz)	Limit (dBm/MHz)	Result
		Worst Chain				
CH42	5210	-1.196	0.599	-0.597	17	Pass
CH58	5290	2.573	0.599	3.172	11	Pass

Mode 6: Transmit by 802.11ac(80MHz)with 2*2 CDD						
Channel No.	Frequency (MHz)	Measurement Power Spectral Density (dBm/MHz)	Duty factor	Total Measurement PSD (dBm/MHz)	Limit (dBm/MHz)	Result
		Worst Chain				
CH42	5210	-3.094	0.599	-2.495	13.42	Pass
CH58	5290	0.193	0.599	0.792	7.42	Pass

Mode 6: Transmit by 802.11ac(80MHz)with 2*2 Beamforming						
Channel No.	Frequency (MHz)	Measurement Power Spectral Density (dBm/MHz)	Duty factor	Total Measurement PSD (dBm/MHz)	Limit (dBm/MHz)	Result
		Worst Chain				
CH42	5210	-3.346	0.599	-2.747	13.42	Pass
CH58	5290	-0.698	0.599	-0.099	7.42	Pass

Mode 7: Transmit by 802.11ax(20MHz)with SISO						
Channel No.	Frequency (MHz)	Measurement Power Spectral Density (dBm/MHz)	Duty factor	Total Measurement PSD (dBm/MHz)	Limit (dBm/MHz)	Result
		Worst Chain				
CH36	5180	6.699	0.116	6.815	17	Pass
CH44	5220	7.533	0.116	7.649	17	Pass
CH48	5240	7.401	0.116	7.517	17	Pass
CH52	5260	8.319	0.116	8.435	11	Pass
CH60	5300	8.636	0.116	8.752	11	Pass
CH64	5320	8.837	0.116	8.953	11	Pass

Mode 7: Transmit by 802.11ax(20MHz)with 2*2 CDD						
Channel No.	Frequency (MHz)	Measurement Power Spectral Density (dBm/MHz)	Duty factor	Total Measurement PSD (dBm/MHz)	Limit (dBm/MHz)	Result
		Worst Chain				
CH36	5180	3.958	0.116	4.074	13.42	Pass
CH44	5220	7.754	0.116	7.870	13.42	Pass
CH48	5240	7.282	0.116	7.398	13.42	Pass
CH52	5260	5.895	0.116	6.011	7.42	Pass
CH60	5300	6.306	0.116	6.422	7.42	Pass
CH64	5320	5.897	0.116	6.013	7.42	Pass

Mode 7: Transmit by 802.11ax(20MHz)with 2*2 Beamforming						
Channel No.	Frequency (MHz)	Measurement Power Spectral Density (dBm/MHz)	Duty factor	Total Measurement PSD (dBm/MHz)	Limit (dBm/MHz)	Result
		Worst Chain				
CH36	5180	3.416	0.130	3.546	13.42	Pass
CH44	5220	7.231	0.130	7.361	13.42	Pass
CH48	5240	6.788	0.130	6.918	13.42	Pass
CH52	5260	4.792	0.130	4.922	7.42	Pass
CH60	5300	5.234	0.130	5.364	7.42	Pass
CH64	5320	5.213	0.130	5.343	7.42	Pass

Mode 8: Transmit by 802.11ax(40MHz)with SISO						
Channel No.	Frequency (MHz)	Measurement Power Spectral Density (dBm/MHz)	Duty factor	Total Measurement PSD (dBm/MHz)	Limit (dBm/MHz)	Result
		Worst Chain				
CH38	5190	2.393	0.369	2.762	17	Pass
CH46	5230	4.926	0.369	5.295	17	Pass
CH54	5270	5.394	0.369	5.763	11	Pass
CH62	5310	5.809	0.369	6.178	11	Pass

Mode 8: Transmit by 802.11ax(40MHz)with 2*2 CDD						
Channel No.	Frequency (MHz)	Measurement Power Spectral Density (dBm/MHz)	Duty factor	Total Measurement PSD (dBm/MHz)	Limit (dBm/MHz)	Result
		Worst Chain				
CH38	5190	-0.132	0.369	0.237	13.42	Pass
CH46	5230	4.726	0.369	5.095	13.42	Pass
CH54	5270	2.302	0.369	2.671	7.42	Pass
CH62	5310	2.458	0.369	2.827	7.42	Pass

Mode 8: Transmit by 802.11ax(40MHz)with 2*2 Beamforming						
Channel No.	Frequency (MHz)	Measurement Power Spectral Density (dBm/MHz)	Duty factor	Total Measurement PSD (dBm/MHz)	Limit (dBm/MHz)	Result
		Worst Chain				
CH38	5190	-0.445	0.352	-0.093	13.42	Pass
CH46	5230	4.054	0.352	4.406	13.42	Pass
CH54	5270	1.589	0.352	1.941	7.42	Pass
CH62	5310	2.079	0.352	2.431	7.42	Pass

Mode 9: Transmit by 802.11ax(80MHz)with SISO						
Channel No.	Frequency (MHz)	Measurement Power Spectral Density (dBm/MHz)	Duty factor	Total Measurement PSD (dBm/MHz)	Limit (dBm/MHz)	Result
		Worst Chain				
CH42	5210	-1.136	0.733	-0.403	17	Pass
CH58	5290	2.334	0.733	3.067	11	Pass

Mode 9: Transmit by 802.11ax(80MHz)with 2*2 CDD						
Channel No.	Frequency (MHz)	Measurement Power Spectral Density (dBm/MHz)	Duty factor	Total Measurement PSD (dBm/MHz)	Limit (dBm/MHz)	Result
		Worst Chain				
CH42	5210	-3.037	0.733	-2.304	13.42	Pass
CH58	5290	-0.384	0.733	0.349	7.42	Pass

Mode 9: Transmit by 802.11ax(80MHz)with 2*2 Beamforming						
Channel No.	Frequency (MHz)	Measurement Power Spectral Density (dBm/MHz)	Duty factor	Total Measurement PSD (dBm/MHz)	Limit (dBm/MHz)	Result
		Worst Chain				
CH42	5210	-3.462	0.699	-2.763	13.42	Pass
CH58	5290	-0.957	0.699	-0.258	7.42	Pass

Note1: Both of two chains are tested and only the worst chain of the PSD was showed.

2: PSD limit = 17/11dBm/MHz - 10Log(2) - (3.56 + 10Log(2) - 6)

Radio 3:

Mode 1: Transmit by 802.11a with 2*2 CDD						
Channel No.	Frequency (MHz)	Measurement Power Spectral Density (dBm/MHz)	Duty factor	Total Measurement PSD (dBm/MHz)	Limit (dBm/MHz)	Result
		Worst Chain				
CH36	5180	2.645	0.241	2.886	12.77	Pass
CH44	5220	5.079	0.241	5.320	12.77	Pass
CH48	5240	5.295	0.241	5.536	12.77	Pass
CH52	5260	5.785	0.241	6.026	6.77	Pass
CH60	5300	5.893	0.241	6.134	6.77	Pass
CH64	5320	5.029	0.241	5.270	6.77	Pass
CH100	5500	5.248	0.241	5.489	6.77	Pass
CH116	5580	4.634	0.241	4.875	6.77	Pass
CH140	5700	5.867	0.241	6.108	6.77	Pass
Channel No.	Frequency (MHz)	Measurement Power Spectral Density (dBm/500KHz)	Duty factor	Total Measurement PSD (dBm/500KHz)	Limit (dBm/500KHz)	Limit (dBm/500KHz)
		Worst Chain				
CH149	5745	9.421	0.241	9.662	25.77	Pass
CH157	5785	9.071	0.241	9.312	25.77	Pass
CH165	5825	8.495	0.241	8.736	25.77	Pass

Mode 1: Transmit by 802.11a with 4*4 CDD						
Channel No.	Frequency (MHz)	Measurement Power Spectral Density (dBm/MHz)	Duty factor	Total Measurement PSD (dBm/MHz)	Limit (dBm/MHz)	Result
		Worst Chain				
CH36	5180	2.958	0.241	3.199	6.75	Pass
CH44	5220	4.953	0.241	5.194	6.75	Pass
CH48	5240	4.844	0.241	5.085	6.75	Pass
CH52	5260	-0.558	0.241	-0.317	0.75	Pass
CH60	5300	-0.438	0.241	-0.197	0.75	Pass
CH64	5320	-0.652	0.241	-0.411	0.75	Pass
CH100	5500	-0.328	0.241	-0.087	0.75	Pass
CH116	5580	-0.302	0.241	-0.061	0.75	Pass
CH140	5700	-0.199	0.241	0.042	0.75	Pass
Channel No.	Frequency (MHz)	Measurement Power Spectral Density (dBm/500KHz)	Duty factor	Total Measurement PSD (dBm/500KHz)	Limit (dBm/500KHz)	Limit (dBm/500KHz)
		Worst Chain				
CH149	5745	9.009	0.241	9.250	19.75	Pass
CH157	5785	9.283	0.241	9.524	19.75	Pass
CH165	5825	8.076	0.241	8.317	19.75	Pass

Mode 2: Transmit by 802.11n(20MHz) with 2*2 CDD						
Channel No.	Frequency (MHz)	Measurement Power Spectral Density (dBm/MHz)	Duty factor	Total Measurement PSD (dBm/MHz)	Limit (dBm/MHz)	Result
		Worst Chain				
CH36	5180	2.468	0.238	2.706	12.77	Pass
CH44	5220	4.857	0.238	5.095	12.77	Pass
CH48	5240	5.253	0.238	5.491	12.77	Pass
CH52	5260	5.931	0.238	6.169	6.77	Pass
CH60	5300	5.828	0.238	6.066	6.77	Pass
CH64	5320	5.406	0.238	5.644	6.77	Pass
CH100	5500	5.244	0.238	5.482	6.77	Pass
CH116	5580	4.617	0.238	4.855	6.77	Pass
CH140	5700	5.543	0.238	5.781	6.77	Pass
Channel No.	Frequency (MHz)	Measurement Power Spectral Density (dBm/500KHz)	Duty factor	Total Measurement PSD (dBm/500KHz)	Limit (dBm/500KHz)	Limit (dBm/500KHz)
		Worst Chain				
CH149	5745	9.447	0.238	9.685	25.77	Pass
CH157	5785	9.038	0.238	9.276	25.77	Pass
CH165	5825	8.580	0.238	8.818	25.77	Pass

Mode 2: Transmit by 802.11n(20MHz) with 4*4 CDD						
Channel No.	Frequency (MHz)	Measurement Power Spectral Density (dBm/MHz)	Duty factor	Total Measurement PSD (dBm/MHz)	Limit (dBm/MHz)	Result
		Worst Chain				
CH36	5180	2.569	0.238	2.807	6.75	Pass
CH44	5220	5.123	0.238	5.361	6.75	Pass
CH48	5240	5.211	0.238	5.449	6.75	Pass
CH52	5260	-0.686	0.238	-0.448	0.75	Pass
CH60	5300	-0.762	0.238	-0.524	0.75	Pass
CH64	5320	-0.889	0.238	-0.651	0.75	Pass
CH100	5500	-0.420	0.238	-0.182	0.75	Pass
CH116	5580	-0.407	0.238	-0.169	0.75	Pass
CH140	5700	-0.278	0.238	-0.040	0.75	Pass
Channel No.	Frequency (MHz)	Measurement Power Spectral Density (dBm/500KHz)	Duty factor	Total Measurement PSD (dBm/500KHz)	Limit (dBm/500KHz)	Limit (dBm/500KHz)
		Worst Chain				
CH149	5745	9.141	0.238	9.379	19.75	Pass
CH157	5785	9.384	0.238	9.622	19.75	Pass
CH165	5825	8.971	0.238	9.209	19.75	Pass

Mode 2: Transmit by 802.11n(20MHz) with 2*2 Beam-forming						
Channel No.	Frequency (MHz)	Measurement Power Spectral Density (dBm/MHz)	Duty factor	Total Measurement PSD (dBm/MHz)	Limit (dBm/MHz)	Result
		Worst Chain				
CH36	5180	2.491	0.242	2.733	12.77	Pass
CH44	5220	4.520	0.242	4.762	12.77	Pass
CH48	5240	4.606	0.242	4.848	12.77	Pass
CH52	5260	4.786	0.242	5.028	6.77	Pass
CH60	5300	4.803	0.242	5.045	6.77	Pass
CH64	5320	4.624	0.242	4.866	6.77	Pass
CH100	5500	4.620	0.242	4.862	6.77	Pass
CH116	5580	4.550	0.242	4.792	6.77	Pass
CH140	5700	4.674	0.242	4.916	6.77	Pass
Channel No.	Frequency (MHz)	Measurement Power Spectral Density (dBm/500KHz)	Duty factor	Total Measurement PSD (dBm/500KHz)	Limit (dBm/500KHz)	Limit (dBm/500KHz)
		Worst Chain				
CH149	5745	9.066	0.242	9.308	25.77	Pass
CH157	5785	8.975	0.242	9.217	25.77	Pass
CH165	5825	8.709	0.242	8.951	25.77	Pass

Mode 2: Transmit by 802.11n(20MHz) with 4*4 Beam-forming						
Channel No.	Frequency (MHz)	Measurement Power Spectral Density (dBm/MHz)	Duty factor	Total Measurement PSD (dBm/MHz)	Limit (dBm/MHz)	Result
		Worst Chain				
CH36	5180	-1.319	0.242	-1.077	6.75	Pass
CH44	5220	1.086	0.242	1.328	6.75	Pass
CH48	5240	1.217	0.242	1.459	6.75	Pass
CH52	5260	-0.936	0.242	-0.694	0.75	Pass
CH60	5300	-0.849	0.242	-0.607	0.75	Pass
CH64	5320	-0.919	0.242	-0.677	0.75	Pass
CH100	5500	-0.580	0.242	-0.338	0.75	Pass
CH116	5580	-0.491	0.242	-0.249	0.75	Pass
CH140	5700	-0.274	0.242	-0.032	0.75	Pass
Channel No.	Frequency (MHz)	Measurement Power Spectral Density (dBm/500KHz)	Duty factor	Total Measurement PSD (dBm/500KHz)	Limit (dBm/500KHz)	Limit (dBm/500KHz)
		Worst Chain				
CH149	5745	6.200	0.242	6.442	19.75	Pass
CH157	5785	6.040	0.242	6.772	19.75	Pass
CH165	5825	5.764	0.242	6.006	19.75	Pass

Mode 3: Transmit by 802.11n(40MHz) with 2*2 CDD						
Channel No.	Frequency (MHz)	Measurement Power Spectral Density (dBm/MHz)	Duty factor	Total Measurement PSD (dBm/MHz)	Limit (dBm/MHz)	Result
		Worst Chain				
CH38	5190	-2.656	0.599	-2.057	12.77	Pass
CH46	5230	2.450	0.599	3.049	12.77	Pass
CH54	5270	2.816	0.599	3.415	6.77	Pass
CH62	5310	2.497	0.599	3.096	6.77	Pass
CH102	5510	1.988	0.599	2.587	6.77	Pass
CH134	5670	2.274	0.599	2.873	6.77	Pass
Channel No.	Frequency (MHz)	Measurement Power Spectral Density (dBm/500KHz)	Duty factor	Total Measurement PSD (dBm/500KHz)	Limit (dBm/500KHz)	Limit (dBm/500KHz)
		Worst Chain				
CH151	5755	6.669	0.599	7.268	25.77	Pass
CH159	5795	5.696	0.599	6.295	25.77	Pass

Mode 3: Transmit by 802.11n(40MHz) with 4*4 CDD						
Channel No.	Frequency (MHz)	Measurement Power Spectral Density (dBm/MHz)	Duty factor	Total Measurement PSD (dBm/MHz)	Limit (dBm/MHz)	Result
		Worst Chain				
CH38	5190	-2.815	0.599	-2.216	6.75	Pass
CH46	5230	2.294	0.599	2.893	6.75	Pass
CH54	5270	-0.282	0.599	0.317	0.75	Pass
CH62	5310	-0.691	0.599	-0.092	0.75	Pass
CH102	5510	-0.350	0.599	0.249	0.75	Pass
CH134	5670	-0.288	0.599	0.311	0.75	Pass
Channel No.	Frequency (MHz)	Measurement Power Spectral Density (dBm/500KHz)	Duty factor	Total Measurement PSD (dBm/500KHz)	Limit (dBm/500KHz)	Limit (dBm/500KHz)
		Worst Chain				
CH151	5755	6.720	0.599	7.319	19.75	Pass
CH159	5795	5.691	0.599	6.290	19.75	Pass

Mode 3: Transmit by 802.11n(40MHz) with 2*2 Beam-forming						
Channel No.	Frequency (MHz)	Measurement Power Spectral Density (dBm/MHz)	Duty factor	Total Measurement PSD (dBm/MHz)	Limit (dBm/MHz)	Result
		Worst Chain				
CH38	5190	-3.397	0.585	-2.812	12.77	Pass
CH46	5230	0.816	0.585	1.401	12.77	Pass
CH54	5270	1.901	0.585	2.486	6.77	Pass
CH62	5310	1.845	0.585	2.430	6.77	Pass
CH102	5510	1.579	0.585	2.164	6.77	Pass
CH134	5670	1.845	0.585	2.430	6.77	Pass
Channel No.	Frequency (MHz)	Measurement Power Spectral Density (dBm/500KHz)	Duty factor	Total Measurement PSD (dBm/500KHz)	Limit (dBm/500KHz)	Limit (dBm/500KHz)
		Worst Chain				
CH151	5755	6.274	0.585	6.859	25.77	Pass
CH159	5795	5.624	0.585	6.209	25.77	Pass

Mode 3: Transmit by 802.11n(40MHz) with 4*4 Beam-forming						
Channel No.	Frequency (MHz)	Measurement Power Spectral Density (dBm/MHz)	Duty factor	Total Measurement PSD (dBm/MHz)	Limit (dBm/MHz)	Result
		Worst Chain				
CH38	5190	-6.601	0.585	-6.016	6.75	Pass
CH46	5230	-3.261	0.585	-2.676	6.75	Pass
CH54	5270	-3.195	0.585	-2.610	0.75	Pass
CH62	5310	-3.299	0.585	-2.714	0.75	Pass
CH102	5510	-3.660	0.585	-3.075	0.75	Pass
CH134	5670	-2.785	0.585	-2.200	0.75	Pass
Channel No.	Frequency (MHz)	Measurement Power Spectral Density (dBm/500KHz)	Duty factor	Total Measurement PSD (dBm/500KHz)	Limit (dBm/500KHz)	Limit (dBm/500KHz)
		Worst Chain				
CH151	5755	3.681	0.585	4.266	19.75	Pass
CH159	5795	3.155	0.585	3.740	19.75	Pass

Mode 4: Transmit by 802.11ac(20MHz) with 2*2 CDD						
Channel No.	Frequency (MHz)	Measurement Power Spectral Density (dBm/MHz)	Duty factor	Total Measurement PSD (dBm/MHz)	Limit (dBm/MHz)	Result
		Worst Chain				
CH36	5180	2.755	0.101	2.856	12.77	Pass
CH44	5220	4.791	0.101	4.892	12.77	Pass
CH48	5240	5.211	0.101	5.312	12.77	Pass
CH52	5260	5.748	0.101	5.849	6.77	Pass
CH60	5300	5.654	0.101	5.755	6.77	Pass
CH64	5320	5.415	0.101	5.516	6.77	Pass
CH100	5500	4.991	0.101	5.092	6.77	Pass
CH116	5580	4.679	0.101	4.780	6.77	Pass
CH140	5700	5.563	0.101	5.664	6.77	Pass
Channel No.	Frequency (MHz)	Measurement Power Spectral Density (dBm/500KHz)	Duty factor	Total Measurement PSD (dBm/500KHz)	Limit (dBm/500KHz)	Limit (dBm/500KHz)
		Worst Chain				
CH149	5745	9.620	0.101	9.721	25.77	Pass
CH157	5785	9.004	0.101	9.105	25.77	Pass
CH165	5825	8.569	0.101	8.670	25.77	Pass

Mode 4: Transmit by 802.11ac(20MHz) with 4*4 CDD						
Channel No.	Frequency (MHz)	Measurement Power Spectral Density (dBm/MHz)	Duty factor	Total Measurement PSD (dBm/MHz)	Limit (dBm/MHz)	Result
		Worst Chain				
CH36	5180	2.830	0.101	2.931	6.75	Pass
CH44	5220	5.269	0.101	5.370	6.75	Pass
CH48	5240	5.142	0.101	5.243	6.75	Pass
CH52	5260	-0.371	0.101	-0.270	0.75	Pass
CH60	5300	-0.899	0.101	-0.798	0.75	Pass
CH64	5320	-0.762	0.101	-0.661	0.75	Pass
CH100	5500	-0.465	0.101	-0.364	0.75	Pass
CH116	5580	-0.533	0.101	-0.432	0.75	Pass
CH140	5700	-0.298	0.101	-0.197	0.75	Pass
Channel No.	Frequency (MHz)	Measurement Power Spectral Density (dBm/500KHz)	Duty factor	Total Measurement PSD (dBm/500KHz)	Limit (dBm/500KHz)	Limit (dBm/500KHz)
		Worst Chain				
CH149	5745	9.416	0.101	9.517	19.75	Pass
CH157	5785	9.097	0.101	9.198	19.75	Pass
CH165	5825	8.920	0.101	9.021	19.75	Pass

Mode 4: Transmit by 802.11ac(20MHz) with 2*2 Beam-forming						
Channel No.	Frequency (MHz)	Measurement Power Spectral Density (dBm/MHz)	Duty factor	Total Measurement PSD (dBm/MHz)	Limit (dBm/MHz)	Result
		Worst Chain				
CH36	5180	2.275	0.101	2.376	12.77	Pass
CH44	5220	4.501	0.101	4.602	12.77	Pass
CH48	5240	4.619	0.101	4.720	12.77	Pass
CH52	5260	4.558	0.101	4.659	6.77	Pass
CH60	5300	4.847	0.101	4.948	6.77	Pass
CH64	5320	4.747	0.101	4.848	6.77	Pass
CH100	5500	4.617	0.101	4.718	6.77	Pass
CH116	5580	4.306	0.101	4.407	6.77	Pass
CH140	5700	4.617	0.101	4.718	6.77	Pass
Channel No.	Frequency (MHz)	Measurement Power Spectral Density (dBm/500KHz)	Duty factor	Total Measurement PSD (dBm/500KHz)	Limit (dBm/500KHz)	Limit (dBm/500KHz)
		Worst Chain				
CH149	5745	9.026	0.101	9.127	25.77	Pass
CH157	5785	9.026	0.101	9.127	25.77	Pass
CH165	5825	8.647	0.101	8.748	25.77	Pass

Mode 4: Transmit by 802.11ac(20MHz) with 4*4 Beam-forming						
Channel No.	Frequency (MHz)	Measurement Power Spectral Density (dBm/MHz)	Duty factor	Total Measurement PSD (dBm/MHz)	Limit (dBm/MHz)	Result
		Worst Chain				
CH36	5180	-1.242	0.101	-1.141	6.75	Pass
CH44	5220	0.864	0.101	0.965	6.75	Pass
CH48	5240	1.521	0.101	1.622	6.75	Pass
CH52	5260	-0.888	0.101	-0.787	0.75	Pass
CH60	5300	-0.778	0.101	-0.677	0.75	Pass
CH64	5320	-0.669	0.101	-0.568	0.75	Pass
CH100	5500	-0.723	0.101	-0.622	0.75	Pass
CH116	5580	-0.719	0.101	-0.618	0.75	Pass
CH140	5700	-0.283	0.101	-0.182	0.75	Pass
Channel No.	Frequency (MHz)	Measurement Power Spectral Density (dBm/500KHz)	Duty factor	Total Measurement PSD (dBm/500KHz)	Limit (dBm/500KHz)	Limit (dBm/500KHz)
		Worst Chain				
CH149	5745	6.320	0.101	6.421	19.75	Pass
CH157	5785	6.032	0.101	6.133	19.75	Pass
CH165	5825	5.528	0.101	5.629	19.75	Pass

Mode 5: Transmit by 802.11ac(40MHz) with 2*2 CDD						
Channel No.	Frequency (MHz)	Measurement Power Spectral Density (dBm/MHz)	Duty factor	Total Measurement PSD (dBm/MHz)	Limit (dBm/MHz)	Result
		Worst Chain				
CH38	5190	-2.745	0.288	-2.457	12.77	Pass
CH46	5230	2.546	0.288	2.834	12.77	Pass
CH54	5270	2.731	0.288	3.019	6.77	Pass
CH62	5310	2.311	0.288	2.599	6.77	Pass
CH102	5510	1.629	0.288	1.917	6.77	Pass
CH134	5670	2.178	0.288	2.466	6.77	Pass
Channel No.	Frequency (MHz)	Measurement Power Spectral Density (dBm/500KHz)	Duty factor	Total Measurement PSD (dBm/500KHz)	Limit (dBm/500KHz)	Limit (dBm/500KHz)
		Worst Chain				
CH151	5755	6.177	0.288	6.465	25.77	Pass
CH159	5795	6.009	0.288	6.297	25.77	Pass

Mode 5: Transmit by 802.11ac(40MHz) with 4*4 CDD						
Channel No.	Frequency (MHz)	Measurement Power Spectral Density (dBm/MHz)	Duty factor	Total Measurement PSD (dBm/MHz)	Limit (dBm/MHz)	Result
		Worst Chain				
CH38	5190	-2.532	0.288	-2.244	6.75	Pass
CH46	5230	2.400	0.288	2.688	6.75	Pass
CH54	5270	-0.640	0.288	-0.352	0.75	Pass
CH62	5310	-0.724	0.288	-0.436	0.75	Pass
CH102	5510	-0.344	0.288	-0.056	0.75	Pass
CH134	5670	-0.188	0.288	0.100	0.75	Pass
Channel No.	Frequency (MHz)	Measurement Power Spectral Density (dBm/500KHz)	Duty factor	Total Measurement PSD (dBm/500KHz)	Limit (dBm/500KHz)	Limit (dBm/500KHz)
		Worst Chain				
CH151	5755	6.448	0.288	6.736	19.75	Pass
CH159	5795	5.853	0.288	6.141	19.75	Pass

Mode 5: Transmit by 802.11ac(40MHz) with 2*2 Beam-forming						
Channel No.	Frequency (MHz)	Measurement Power Spectral Density (dBm/MHz)	Duty factor	Total Measurement PSD (dBm/MHz)	Limit (dBm/MHz)	Result
		Worst Chain				
CH38	5190	-3.293	0.288	-3.005	12.77	Pass
CH46	5230	0.988	0.288	1.276	12.77	Pass
CH54	5270	2.141	0.288	2.429	6.77	Pass
CH62	5310	1.548	0.288	1.836	6.77	Pass
CH102	5510	1.387	0.288	1.675	6.77	Pass
CH134	5670	1.404	0.288	1.692	6.77	Pass
Channel No.	Frequency (MHz)	Measurement Power Spectral Density (dBm/500KHz)	Duty factor	Total Measurement PSD (dBm/500KHz)	Limit (dBm/500KHz)	Limit (dBm/500KHz)
		Worst Chain				
CH151	5755	6.406	0.288	6.694	25.77	Pass
CH159	5795	5.949	0.288	6.237	25.77	Pass

Mode 5: Transmit by 802.11ac(40MHz) with 4*4 Beam-forming						
Channel No.	Frequency (MHz)	Measurement Power Spectral Density (dBm/MHz)	Duty factor	Total Measurement PSD (dBm/MHz)	Limit (dBm/MHz)	Result
		Worst Chain				
CH38	5190	-6.763	0.288	-6.475	6.75	Pass
CH46	5230	-3.199	0.288	-2.911	6.75	Pass
CH54	5270	-3.311	0.288	-3.023	0.75	Pass
CH62	5310	-3.443	0.288	-3.155	0.75	Pass
CH102	5510	-3.504	0.288	-3.216	0.75	Pass
CH134	5670	-2.561	0.288	-2.273	0.75	Pass
Channel No.	Frequency (MHz)	Measurement Power Spectral Density (dBm/500KHz)	Duty factor	Total Measurement PSD (dBm/500KHz)	Limit (dBm/500KHz)	Limit (dBm/500KHz)
		Worst Chain				
CH151	5755	3.522	0.288	3.810	19.75	Pass
CH159	5795	3.172	0.288	3.460	19.75	Pass

Mode 6: Transmit by 802.11ac(80MHz) with 2*2 CDD						
Channel No.	Frequency (MHz)	Measurement Power Spectral Density (dBm/MHz)	Duty factor	Total Measurement PSD (dBm/MHz)	Limit (dBm/MHz)	Result
		Worst Chain				
CH42	5210	-6.773	0.646	-6.127	12.77	Pass
CH58	5290	0.058	0.646	0.704	6.77	Pass
CH106	5530	0.789	0.646	1.435	6.77	Pass
Channel No.	Frequency (MHz)	Measurement Power Spectral Density (dBm/500KHz)	Duty factor	Total Measurement PSD (dBm/500KHz)	Limit (dBm/500KHz)	Limit (dBm/500KHz)
		Worst Chain				
CH155	5775	3.589	0.646	4.235	25.77	Pass

Mode 6: Transmit by 802.11ac(80MHz) with 4*4 CDD						
Channel No.	Frequency (MHz)	Measurement Power Spectral Density (dBm/MHz)	Duty factor	Total Measurement PSD (dBm/MHz)	Limit (dBm/MHz)	Result
		Worst Chain				
CH42	5210	-5.541	0.646	-4.895	6.75	Pass
CH58	5290	-2.415	0.646	-1.769	0.75	Pass
CH106	5530	-1.759	0.646	-1.113	0.75	Pass
Channel No.	Frequency (MHz)	Measurement Power Spectral Density (dBm/500KHz)	Duty factor	Total Measurement PSD (dBm/500KHz)	Limit (dBm/500KHz)	Limit (dBm/500KHz)
		Worst Chain				
CH155	5775	4.038	0.646	4.684	19.75	Pass

Mode 6: Transmit by 802.11ac(80MHz) with 2*2 Beam-forming						
Channel No.	Frequency (MHz)	Measurement Power Spectral Density (dBm/MHz)	Duty factor	Total Measurement PSD (dBm/MHz)	Limit (dBm/MHz)	Result
		Worst Chain				
CH42	5210	-5.784	0.599	-5.185	12.77	Pass
CH58	5290	-0.760	0.599	-0.161	6.77	Pass
CH106	5530	-1.132	0.599	-0.533	6.77	Pass
Channel No.	Frequency (MHz)	Measurement Power Spectral Density (dBm/500KHz)	Duty factor	Total Measurement PSD (dBm/500KHz)	Limit (dBm/500KHz)	Limit (dBm/500KHz)
		Worst Chain				
CH155	5775	-2.921	0.599	-2.322	25.77	Pass

Mode 6: Transmit by 802.11ac(80MHz) with 4*4 Beam-forming						
Channel No.	Frequency (MHz)	Measurement Power Spectral Density (dBm/MHz)	Duty factor	Total Measurement PSD (dBm/MHz)	Limit (dBm/MHz)	Result
		Worst Chain				
CH42	5210	-8.407	0.599	-7.808	6.75	Pass
CH58	5290	-5.635	0.599	-5.036	0.75	Pass
CH106	5530	-5.629	0.599	-5.030	0.75	Pass
Channel No.	Frequency (MHz)	Measurement Power Spectral Density (dBm/500KHz)	Duty factor	Total Measurement PSD (dBm/500KHz)	Limit (dBm/500KHz)	Limit (dBm/500KHz)
		Worst Chain				
CH155	5775	-3.243	0.599	-2.644	19.75	Pass

Mode 7: Transmit by 802.11ax(20MHz) with 2*2 CDD						
Channel No.	Frequency (MHz)	Measurement Power Spectral Density (dBm/MHz)	Duty factor	Total Measurement PSD (dBm/MHz)	Limit (dBm/MHz)	Result
		Worst Chain				
CH36	5180	2.957	0.113	3.070	12.77	Pass
CH44	5220	4.643	0.113	4.756	12.77	Pass
CH48	5240	5.264	0.113	5.377	12.77	Pass
CH52	5260	5.899	0.113	6.012	6.77	Pass
CH60	5300	5.746	0.113	5.859	6.77	Pass
CH64	5320	5.537	0.113	5.650	6.77	Pass
CH100	5500	5.065	0.113	5.178	6.77	Pass
CH116	5580	4.538	0.113	4.651	6.77	Pass
CH140	5700	5.560	0.113	5.673	6.77	Pass
Channel No.	Frequency (MHz)	Measurement Power Spectral Density (dBm/500KHz)	Duty factor	Total Measurement PSD (dBm/500KHz)	Limit (dBm/500KHz)	Limit (dBm/500KHz)
		Worst Chain				
CH149	5745	9.387	0.113	9.500	25.77	Pass
CH157	5785	9.083	0.113	9.196	25.77	Pass
CH165	5825	8.498	0.113	8.611	25.77	Pass

Mode 7: Transmit by 802.11ax(20MHz) with 4*4 CDD						
Channel No.	Frequency (MHz)	Measurement Power Spectral Density (dBm/MHz)	Duty factor	Total Measurement PSD (dBm/MHz)	Limit (dBm/MHz)	Result
		Worst Chain				
CH36	5180	2.859	0.113	2.972	6.75	Pass
CH44	5220	4.851	0.113	4.964	6.75	Pass
CH48	5240	5.154	0.113	5.267	6.75	Pass
CH52	5260	-0.752	0.113	-0.639	0.75	Pass
CH60	5300	-0.837	0.113	-0.724	0.75	Pass
CH64	5320	-0.658	0.113	-0.545	0.75	Pass
CH100	5500	-0.588	0.113	-0.475	0.75	Pass
CH116	5580	-0.449	0.113	-0.336	0.75	Pass
CH140	5700	-0.325	0.113	-0.212	0.75	Pass
Channel No.	Frequency (MHz)	Measurement Power Spectral Density (dBm/500KHz)	Duty factor	Total Measurement PSD (dBm/500KHz)	Limit (dBm/500KHz)	Limit (dBm/500KHz)
		Worst Chain				
CH149	5745	9.552	0.113	9.665	19.75	Pass
CH157	5785	8.931	0.113	9.044	19.75	Pass
CH165	5825	8.963	0.113	9.076	19.75	Pass

Mode 7: Transmit by 802.11ax(20MHz) with 2*2 Beam-forming						
Channel No.	Frequency (MHz)	Measurement Power Spectral Density (dBm/MHz)	Duty factor	Total Measurement PSD (dBm/MHz)	Limit (dBm/MHz)	Result
		Worst Chain				
CH36	5180	2.465	0.190	2.655	12.77	Pass
CH44	5220	4.461	0.190	4.651	12.77	Pass
CH48	5240	4.701	0.190	4.891	12.77	Pass
CH52	5260	4.627	0.190	4.817	6.77	Pass
CH60	5300	4.584	0.190	4.774	6.77	Pass
CH64	5320	4.761	0.190	4.951	6.77	Pass
CH100	5500	4.541	0.190	4.731	6.77	Pass
CH116	5580	4.299	0.190	4.489	6.77	Pass
CH140	5700	4.687	0.190	4.877	6.77	Pass
Channel No.	Frequency (MHz)	Measurement Power Spectral Density (dBm/500KHz)	Duty factor	Total Measurement PSD (dBm/500KHz)	Limit (dBm/500KHz)	Limit (dBm/500KHz)
		Worst Chain				
CH149	5745	9.159	0.190	9.349	25.77	Pass
CH157	5785	8.858	0.190	9.048	25.77	Pass
CH165	5825	8.601	0.190	8.791	25.77	Pass

Mode 7: Transmit by 802.11ax(20MHz) with 4*4 Beam-forming						
Channel No.	Frequency (MHz)	Measurement Power Spectral Density (dBm/MHz)	Duty factor	Total Measurement PSD (dBm/MHz)	Limit (dBm/MHz)	Result
		Worst Chain				
CH36	5180	-1.463	0.190	-1.273	6.75	Pass
CH44	5220	0.923	0.190	1.113	6.75	Pass
CH48	5240	0.974	0.190	1.164	6.75	Pass
CH52	5260	-1.011	0.190	-0.821	0.75	Pass
CH60	5300	-0.870	0.190	-0.680	0.75	Pass
CH64	5320	-0.698	0.190	-0.508	0.75	Pass
CH100	5500	-0.703	0.190	-0.513	0.75	Pass
CH116	5580	-0.707	0.190	-0.517	0.75	Pass
CH140	5700	-0.228	0.190	-0.038	0.75	Pass
Channel No.	Frequency (MHz)	Measurement Power Spectral Density (dBm/500KHz)	Duty factor	Total Measurement PSD (dBm/500KHz)	Limit (dBm/500KHz)	Limit (dBm/500KHz)
		Worst Chain				
CH149	5745	6.186	0.190	6.376	19.75	Pass
CH157	5785	6.242	0.190	6.432	19.75	Pass
CH165	5825	5.873	0.190	6.063	19.75	Pass

Mode 8: Transmit by 802.11ax(40MHz) with 2*2 CDD						
Channel No.	Frequency (MHz)	Measurement Power Spectral Density (dBm/MHz)	Duty factor	Total Measurement PSD (dBm/MHz)	Limit (dBm/MHz)	Result
		Worst Chain				
CH38	5190	-2.881	0.317	-2.564	12.77	Pass
CH46	5230	2.426	0.317	2.743	12.77	Pass
CH54	5270	2.668	0.317	2.985	6.77	Pass
CH62	5310	2.456	0.317	2.773	6.77	Pass
CH102	5510	1.496	0.317	1.813	6.77	Pass
CH134	5670	1.978	0.317	2.295	6.77	Pass
Channel No.	Frequency (MHz)	Measurement Power Spectral Density (dBm/500KHz)	Duty factor	Total Measurement PSD (dBm/500KHz)	Limit (dBm/500KHz)	Limit (dBm/500KHz)
		Worst Chain				
CH151	5755	6.246	0.317	6.563	25.77	Pass
CH159	5795	5.622	0.317	5.939	25.77	Pass

Mode 8: Transmit by 802.11ax(40MHz) with 4*4 CDD						
Channel No.	Frequency (MHz)	Measurement Power Spectral Density (dBm/MHz)	Duty factor	Total Measurement PSD (dBm/MHz)	Limit (dBm/MHz)	Result
		Worst Chain				
CH38	5190	-2.747	0.317	-2.430	6.75	Pass
CH46	5230	2.571	0.317	2.888	6.75	Pass
CH54	5270	-0.693	0.317	-0.376	0.75	Pass
CH62	5310	-0.849	0.317	-0.532	0.75	Pass
CH102	5510	-0.572	0.317	-0.255	0.75	Pass
CH134	5670	-0.220	0.317	0.097	0.75	Pass
Channel No.	Frequency (MHz)	Measurement Power Spectral Density (dBm/500KHz)	Duty factor	Total Measurement PSD (dBm/500KHz)	Limit (dBm/500KHz)	Limit (dBm/500KHz)
		Worst Chain				
CH151	5755	6.711	0.317	7.028	19.75	Pass
CH159	5795	5.865	0.317	6.182	19.75	Pass

Mode 8: Transmit by 802.11ax(40MHz) with 2*2 Beam-forming						
Channel No.	Frequency (MHz)	Measurement Power Spectral Density (dBm/MHz)	Duty factor	Total Measurement PSD (dBm/MHz)	Limit (dBm/MHz)	Result
		Worst Chain				
CH38	5190	-3.413	0.385	-3.028	12.77	Pass
CH46	5230	0.941	0.385	1.326	12.77	Pass
CH54	5270	1.621	0.385	2.006	6.77	Pass
CH62	5310	1.407	0.385	1.792	6.77	Pass
CH102	5510	1.354	0.385	1.739	6.77	Pass
CH134	5670	1.565	0.385	1.950	6.77	Pass
Channel No.	Frequency (MHz)	Measurement Power Spectral Density (dBm/500KHz)	Duty factor	Total Measurement PSD (dBm/500KHz)	Limit (dBm/500KHz)	Limit (dBm/500KHz)
		Worst Chain				
CH151	5755	6.501	0.385	6.886	25.77	Pass
CH159	5795	6.016	0.385	6.401	25.77	Pass

Mode 8: Transmit by 802.11ax(40MHz) with 4*4 Beam-forming						
Channel No.	Frequency (MHz)	Measurement Power Spectral Density (dBm/MHz)	Duty factor	Total Measurement PSD (dBm/MHz)	Limit (dBm/MHz)	Result
		Worst Chain				
CH38	5190	-6.924	0.385	-6.539	6.75	Pass
CH46	5230	-3.150	0.385	-2.765	6.75	Pass
CH54	5270	-3.590	0.385	-3.205	0.75	Pass
CH62	5310	-3.316	0.385	-2.931	0.75	Pass
CH102	5510	-3.482	0.385	-3.097	0.75	Pass
CH134	5670	-2.848	0.385	-2.463	0.75	Pass
Channel No.	Frequency (MHz)	Measurement Power Spectral Density (dBm/500KHz)	Duty factor	Total Measurement PSD (dBm/500KHz)	Limit (dBm/500KHz)	Limit (dBm/500KHz)
		Worst Chain				
CH151	5755	3.712	0.385	4.097	19.75	Pass
CH159	5795	3.083	0.385	3.468	19.75	Pass

Mode 9: Transmit by 802.11ax(80MHz) with 2*2 CDD						
Channel No.	Frequency (MHz)	Measurement Power Spectral Density (dBm/MHz)	Duty factor	Total Measurement PSD (dBm/MHz)	Limit (dBm/MHz)	Result
		Worst Chain				
CH42	5210	-5.759	0.742	-5.017	12.77	Pass
CH58	5290	0.041	0.742	0.783	6.77	Pass
CH106	5530	0.264	0.742	1.006	6.77	Pass
Channel No.	Frequency (MHz)	Measurement Power Spectral Density (dBm/500KHz)	Duty factor	Total Measurement PSD (dBm/500KHz)	Limit (dBm/500KHz)	Limit (dBm/500KHz)
		Worst Chain				
CH155	5775	3.513	0.742	4.255	25.77	Pass

Mode 9: Transmit by 802.11ax(80MHz) with 4*4 CDD						
Channel No.	Frequency (MHz)	Measurement Power Spectral Density (dBm/MHz)	Duty factor	Total Measurement PSD (dBm/MHz)	Limit (dBm/MHz)	Result
		Worst Chain				
CH42	5210	-5.479	0.742	-4.737	6.75	Pass
CH58	5290	-2.411	0.742	-1.669	0.75	Pass
CH106	5530	-1.571	0.742	-0.829	0.75	Pass
Channel No.	Frequency (MHz)	Measurement Power Spectral Density (dBm/500KHz)	Duty factor	Total Measurement PSD (dBm/500KHz)	Limit (dBm/500KHz)	Limit (dBm/500KHz)
		Worst Chain				
CH155	5775	3.675	0.742	4.417	19.75	Pass

Mode 9: Transmit by 802.11ax(80MHz) with 2*2 Beam-forming						
Channel No.	Frequency (MHz)	Measurement Power Spectral Density (dBm/MHz)	Duty factor	Total Measurement PSD (dBm/MHz)	Limit (dBm/MHz)	Result
		Worst Chain				
CH42	5210	-5.780	0.733	-5.047	12.77	Pass
CH58	5290	-0.970	0.733	-0.237	6.77	Pass
CH106	5530	-1.163	0.733	-0.430	6.77	Pass
Channel No.	Frequency (MHz)	Measurement Power Spectral Density (dBm/500KHz)	Duty factor	Total Measurement PSD (dBm/500KHz)	Limit (dBm/500KHz)	Limit (dBm/500KHz)
		Worst Chain				
CH155	5775	-2.969	0.733	-2.236	25.77	Pass

Mode 9: Transmit by 802.11ax(80MHz) with 4*4 Beam-forming						
Channel No.	Frequency (MHz)	Measurement Power Spectral Density (dBm/MHz)	Duty factor	Total Measurement PSD (dBm/MHz)	Limit (dBm/MHz)	Result
		Worst Chain				
CH42	5210	-8.345	0.733	-7.612	6.75	Pass
CH58	5290	-5.963	0.733	-5.230	0.75	Pass
CH106	5530	-5.802	0.733	-5.069	0.75	Pass
Channel No.	Frequency (MHz)	Measurement Power Spectral Density (dBm/500KHz)	Duty factor	Total Measurement PSD (dBm/500KHz)	Limit (dBm/500KHz)	Limit (dBm/500KHz)
		Worst Chain				
CH155	5775	-3.058	0.733	-2.325	19.75	Pass

Mode 10: Transmit by 802.11ax(160MHz) with 2*2 CDD						
Channel No.	Frequency (MHz)	Measurement Power Spectral Density (dBm/MHz)	Duty factor	Total Measurement PSD (dBm/MHz)	Limit (dBm/MHz)	Result
		Worst Chain				
CH50	5250	-2.734	0.536	-2.198	12.77	Pass
CH114	5570	-2.993	0.536	-2.457	6.77	Pass

Mode 10: Transmit by 802.11ax(160MHz) with 4*4 CDD						
Channel No.	Frequency (MHz)	Measurement Power Spectral Density (dBm/MHz)	Duty factor	Total Measurement PSD (dBm/MHz)	Limit (dBm/MHz)	Result
		Worst Chain				
CH50	5250	-4.412	0.536	-3.876	6.75	Pass
CH114	5570	-5.125	0.536	-4.589	0.75	Pass

Mode 10: Transmit by 802.11ax(160MHz) with 2*2 Beam-forming						
Channel No.	Frequency (MHz)	Measurement Power Spectral Density (dBm/MHz)	Duty factor	Total Measurement PSD (dBm/MHz)	Limit (dBm/MHz)	Result
		Worst Chain				
CH50	5250	-3.534	0.489	-3.045	12.77	Pass
CH114	5570	-3.783	0.489	-3.294	6.77	Pass

Note1: Both of two chains are tested and only the worst chain of the PSD was showed.

2: PSD limit = 17/11dBm/MHz - 10Log(2) - (4.21 + 10Log(2) - 6)

Mode 10: Transmit by 802.11ax(160MHz) with 4*4 Beam-forming						
Channel No.	Frequency (MHz)	Measurement Power Spectral Density (dBm/MHz)	Duty factor	Total Measurement PSD (dBm/MHz)	Limit (dBm/MHz)	Result
		Worst Chain				
CH50	5250	-8.183	0.489	-7.694	6.75	Pass
CH114	5570	-8.955	0.489	-8.466	0.75	Pass

Note1: Both of two chains are tested and only the worst chain of the PSD was showed.

2: PSD limit = 17/11dBm/MHz - 10Log(4) - (4.21 + 10Log(4) - 6)

9. Band Edge

9.1. Test Equipment

Band Edge / TR-8					
Instrument	Manufacturer	Type No.	Serial No.	Cal. Date	Cal. Due Date
Spectrum Analyzer	Agilent	N9010A	MY48030494	2020.02.04	2021.02.03
EXA Spectrum Analyzer	Keysight	N9010A	MY55370495	2020.04.09	2021.04.08
Signal Analyzer	R&S	FSV	104212	2020.02.23	2021.02.22
MXA Signal Analyzer	Keysight	N9020A	MY56060147	2020.04.09	2021.04.08
Temperature/Humidity Meter	zhichen	ZC1-2	TR8-TH	2020.04.10	2021.04.09

Note: All equipment are calibrated with traceable calibrations. Each calibration is traceable to the national or international standards.

9.2. Test Setup

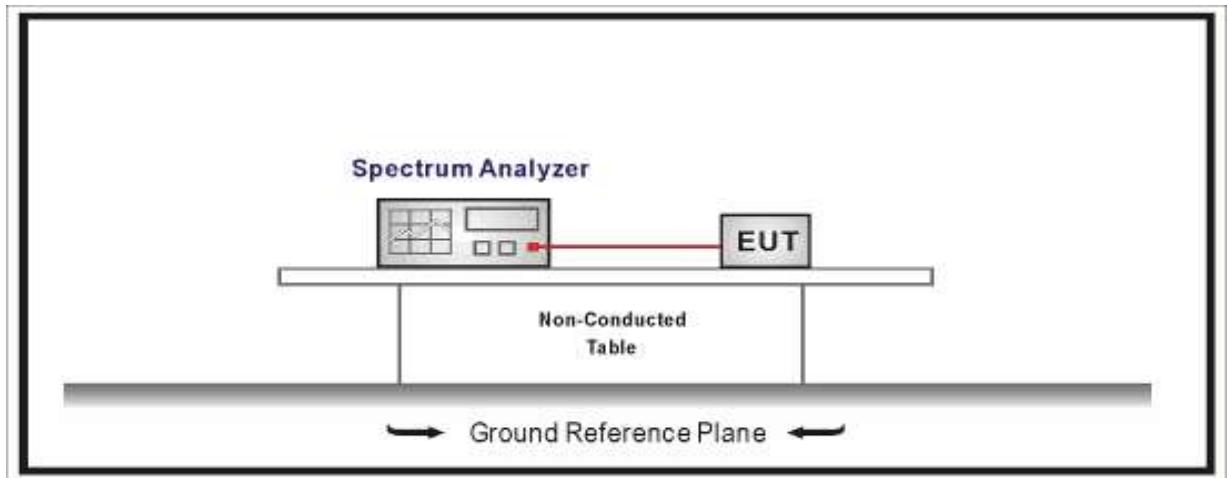

9.3. Limit

FCC Part 15 Subpart C Paragraph 15.209 (Restricted Band Emissions Limit)		
Frequency (MHz)	Distance (m)	Level (dBµV/m)
0.009-0.490	300	2400/F(kHz)
0.490-1.705	30	24000/F(kHz)
1.705-30.0	30	30
30-88	3	100**
88-216	3	150**
216-960	3	200**
Above 960	3	500

Note 1: At frequencies below 30 MHz, measurements may be performed at a distance closer than that specified in the regulations; however, an attempt should be made to avoid making measurements in the near field. Pending the development of an appropriate measurement procedure for measurements performed below 30 MHz, when performing measurements at a closer distance than specified, the results shall be extrapolated to the specified distance by either making measurements at a minimum of two distances on at least one radial to determine the proper extrapolation factor or by using the square of an inverse linear distance extrapolation factor (40 dB/decade).

Note 2: At frequencies at or above 30 MHz, measurements may be performed at a distance other than what is specified provided: measurements are not made in the near field except where it can be shown that near field measurements are appropriate due to the characteristics of the device; and it can be demonstrated that the signal levels needed to be measured at the distance employed can be detected by the measurement equipment. Measurements shall not be performed at a distance greater than 30 meters unless it can be further demonstrated that measurements at a distance of 30 meters or less are impractical. When performing measurements at a distance other than that specified, the results shall be extrapolated to the specified distance using an extrapolation factor of 20 dB/decade (inverse linear-distance for field strength measurements; inverse-linear-distance-squared for power density measurements).

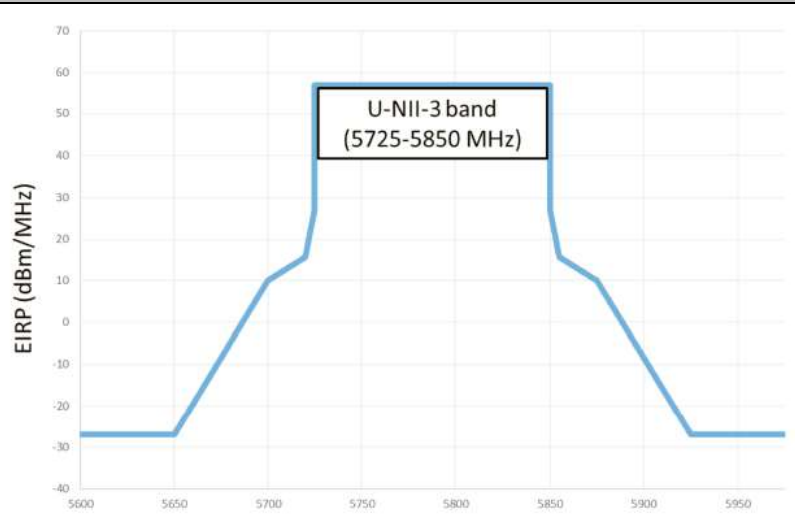

FCC Part 15 Subpart C Paragraph 15.205 (Restricted Band)			
Frequency (MHz)	Frequency (MHz)	Frequency (MHz)	Frequency (MHz)
0.090 – 0.110	16.42 – 16.423	399.9 – 410	4.5 – 5.15
0.495 – 0.505	16.69475 – 16.69525	608 – 614	5.35 – 5.46
2.1735 – 2.1905	16.80425 – 16.80475	960 – 1240	7.25 – 7.75
4.125 – 4.128	25.5 – 25.67	1300 – 1427	8.025 – 8.5
4.17725 – 4.17775	37.5 – 38.25	1435 – 1626.5	9.0 – 9.2
4.20725 – 4.20775	73 – 74.6	1645.5 – 1646.5	9.3 – 9.5
6.215 – 6.218	74.8 – 75.2	1660 – 1710	10.6 – 12.7
6.26775 – 6.26825	108 – 121.94	1718.8 – 1722.2	13.25 – 13.4
6.31175 – 6.31225	123 – 138	2200 – 2300	14.47 – 14.5
8.291 – 8.294	149.9 – 150.05	2310 – 2390	15.35 – 16.2
8.362 – 8.366	156.52475 – 156.52525	2483.5 – 2500	17.7 – 21.4
8.37625 – 8.38675	156.7 – 156.9	2690 – 2900	22.01 – 23.12
8.81425 – 8.81475	162.0125 – 167.17	3260 – 3267	23.6 – 24.0
12.29 – 12.293	167.72 – 173.2	3332 – 3339	31.2 – 31.8
12.51975 – 12.52025	240 – 285	3345.8 – 3358	36.43 – 36.5
12.57675 – 12.57725	322 – 335.4	3600 – 4400	
13.36 – 13.41			

FCC Part 15 Subpart E Paragraph 15.407(5)(b) (Unrestricted Band Emissions Limit)		
Operating Frequency Band (MHz)	EIRP Limit (dBm/MHz)	Equivalent Field Strength at 3m (dB μ V/m)
5150 - 5250	-27	68.3
5250 - 5350	-27	68.3
5470 - 5725	-27	68.3
Operating Frequency Band (MHz)	EIRP Limit (dBm/MHz)	
5725 - 5850	 <p>U-NII-3 band (5725-5850 MHz)</p>	

9.4. Test Procedure

Test Method			
	References Rule	Chapter	Description
<input type="checkbox"/>	ANSI C63.10	12.7.3	Emissions in non-restricted frequency bands
<input checked="" type="checkbox"/>	ANSI C63.10	12.7.2	Emissions in restricted frequency bands
<input type="checkbox"/>	ANSI C63.10	12.7.5	Radiated emission measurements
<input checked="" type="checkbox"/>	ANSI C63.10	12.7.6	Procedure for peak unwanted emissions measurements above 1000 MHz
<input checked="" type="checkbox"/>	ANSI C63.10	12.7.7	Procedures for average unwanted emissions measurements above 1000 MHz
<input type="checkbox"/>	ANSI C63.10	12.7.7.2	Method AD (average detection)—primary method
<input checked="" type="checkbox"/>	ANSI C63.10	12.7.7.3	Method VB-A (Alternative)
<input type="checkbox"/>	ANSI C63.10	6.4	Radiated emissions from unlicensed wireless devices below 30 MHz
<input type="checkbox"/>	ANSI C63.10	6.5	Radiated emissions from unlicensed wireless devices in the frequency range of 30 MHz to 1000 MHz
<input type="checkbox"/>	ANSI C63.10	6.6	Radiated emissions from unlicensed wireless devices above 1 GHz
<input type="checkbox"/>	FCC KDB 789033 D02v02r01	G.2	Unwanted Emissions that fall Outside of the Restricted Bands
<input type="checkbox"/>	FCC KDB 789033 D02v02r01	G.1	Unwanted Emissions in the Restricted Bands
<input type="checkbox"/>	FCC KDB 789033 D02v02r01	G.4	Procedure for Unwanted Emissions Measurements below 1000 MHz
<input type="checkbox"/>	FCC KDB 789033 D02v02r01	G.5	Procedure for Unwanted Maximum Emissions Measurements above 1000 MHz
<input type="checkbox"/>	FCC KDB 789033 D02v02r01	G.6	Procedures for Average Unwanted Emissions Measurements above 1000 MHz
<input type="checkbox"/>	FCC KDB 789033 D02v02r01	G.6.c	Method AD (Average detection)—primary method
<input type="checkbox"/>	FCC KDB 789033 D02v02r01	G.6.d	Method VB (Averaging using reduced video bandwidth): Alternative method.

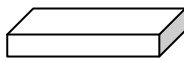
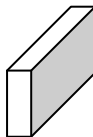
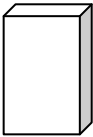
9.5. EUT test Axis definition

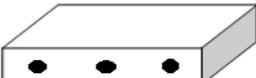
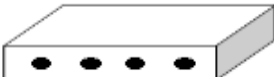
Item	Band Edge			
Device Category	<input type="checkbox"/>	Indoor use		
	<input checked="" type="checkbox"/>	Outdoor use		
	<input type="checkbox"/>	Fix position use		
	<input type="checkbox"/>	Client use		
Test mode	Mode 1-10			
Test method	<input type="checkbox"/>	Radiated		
		X Axis	Y Axis	Z Axis
				
	Worst Axis <input type="checkbox"/>	Worst Axis <input type="checkbox"/>	Worst Axis <input type="checkbox"/>	Worst Axis <input type="checkbox"/>
	<input checked="" type="checkbox"/>	Conducted		
	<input checked="" type="checkbox"/>	Chain 1		
				
	<input checked="" type="checkbox"/>	Chain 1	Chain 2	
				
	<input type="checkbox"/>	Chain 1	Chain 2	Chain 3
				
<input checked="" type="checkbox"/>	Chain 1	Chain 2	Chain 3	Chain 4
				

9.6. Test Result

Radio 1:

SISO PK Limit=74dBuV/m-95.2-3.42(Antenna Gain)=-24.62dBm

SISO AV Limit=54dBuV/m-95.2-3.42(Antenna Gain)=-44.62dBm

Radio 2:

SISO PK Limit=74dBuV/m-95.2-3.56(Antenna Gain)=-24.76dBm

SISO AV Limit=54dBuV/m-95.2-3.56(Antenna Gain)=-44.76dBm

2*2 CDD/Beamforming PK Limit=74dBuV/m-95.2-10lg2(2Tx)-6.57(Directional Gain)=-30.78dBm

2*2 CDD/Beamforming AV Limit=54dBuV/m-95.2-10lg2(2Tx)-6.57(Directional Gain)=-50.78dBm

Radio 3:

2*2 CDD/Beamforming PK Limit=74dBuV/m-95.2-10lg2(2Tx)-7.22(Directional Gain)=-31.43dBm

2*2 CDD/Beamforming AV Limit=54dBuV/m-95.2-10lg2(2Tx)-7.22(Directional Gain)=-51.43dBm

4*4 CDD/Beamforming PK Limit=74dBuV/m-95.2-10lg4(4Tx)-10.23(Directional Gain)=-37.45dBm

4*4 CDD/Beamforming AV Limit=54dBuV/m-95.2-10lg4(4Tx)-10.23(Directional Gain)=-57.45dBm

Note: Above limit is the worst case of AP460C.

Radio 1:
802.11a

5180MHz PK

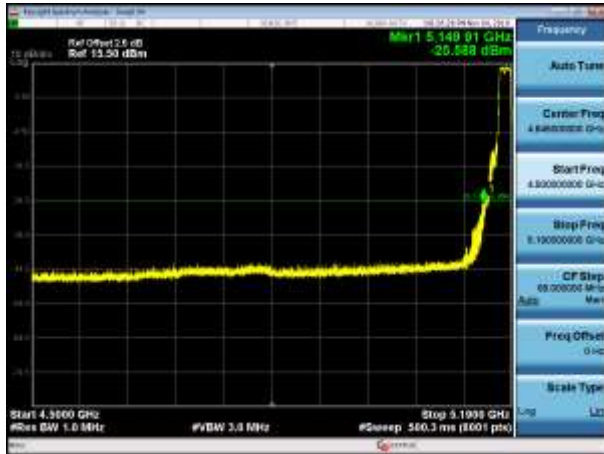

5180MHz AV

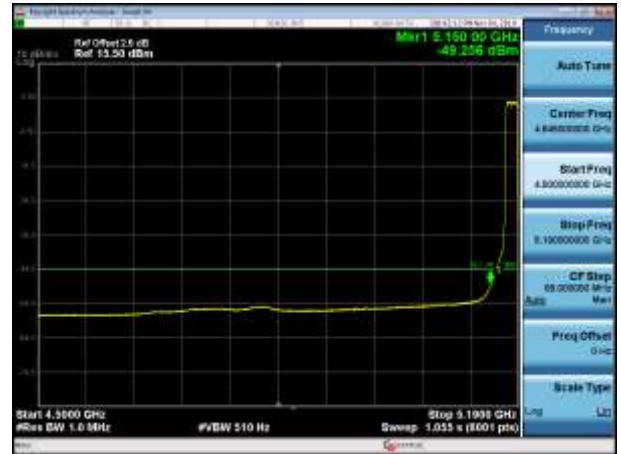

5200MHz PK

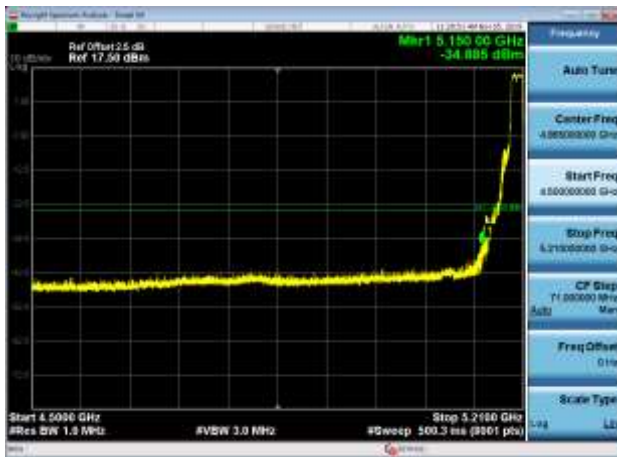

5200MHz AV



5300MHz PK

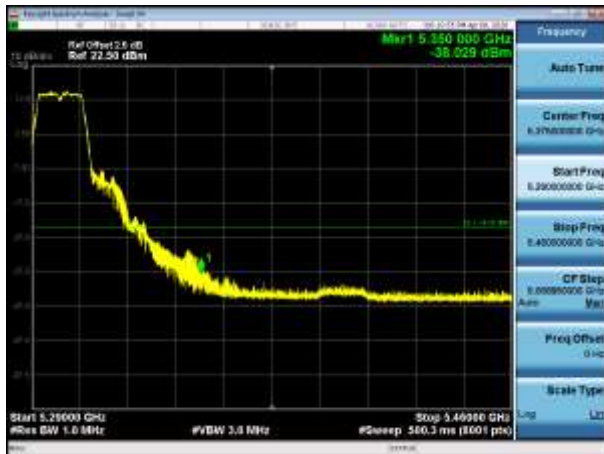

5300MHz AV

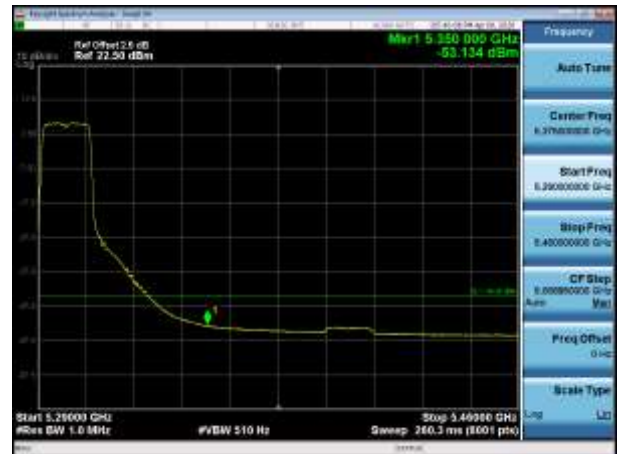

5320MHz PK

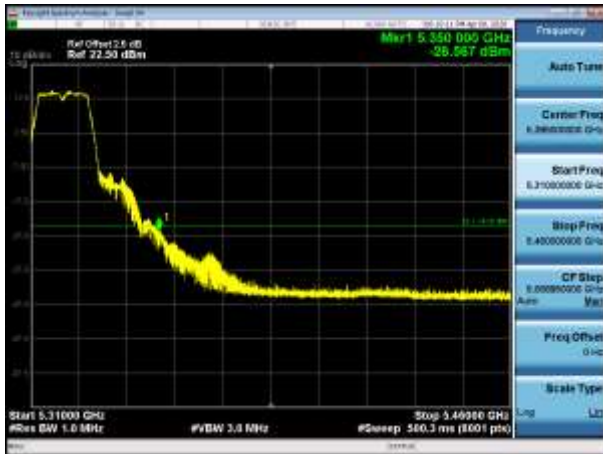

5320MHz AV

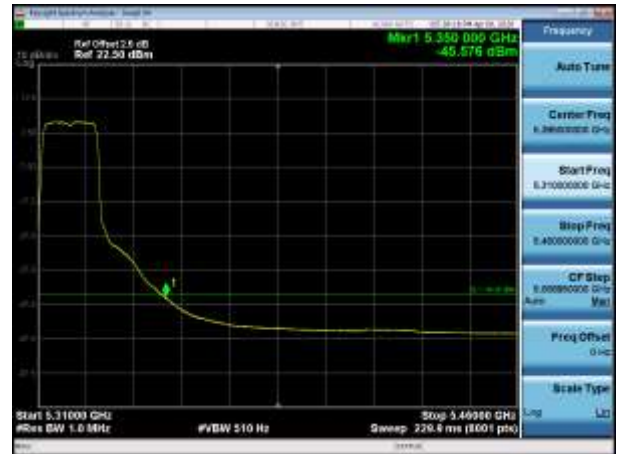

5500MHz PK

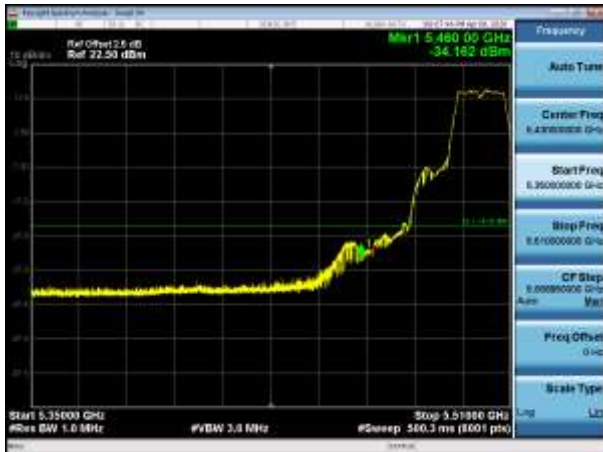

5500MHz AV

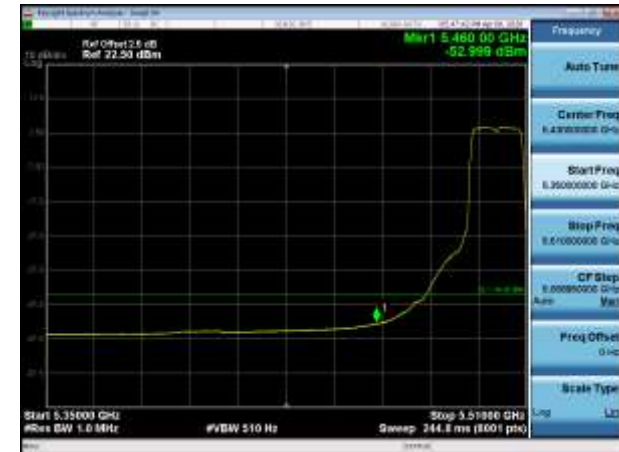

5520MHz PK

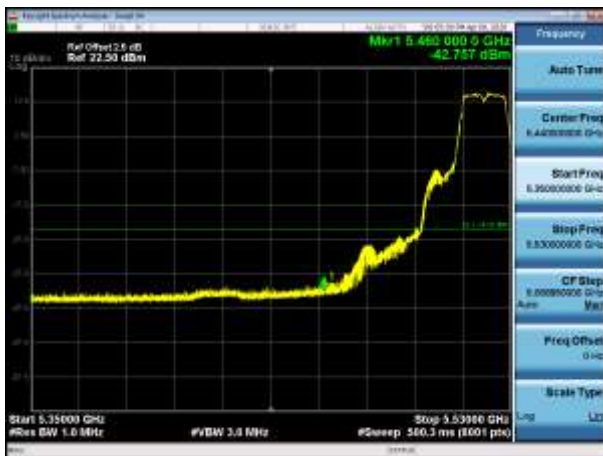

5520MHz AV

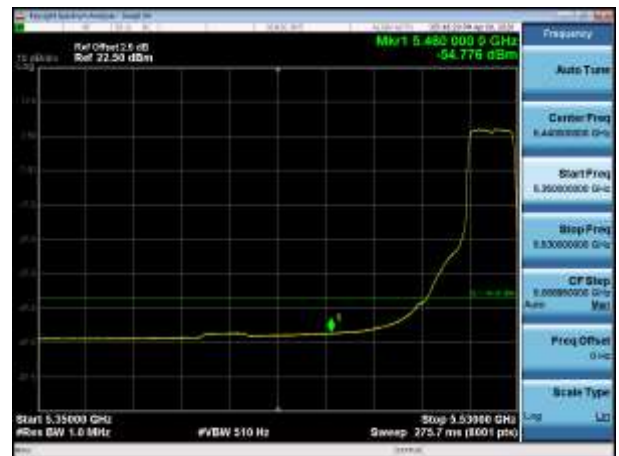

5745MHz PK

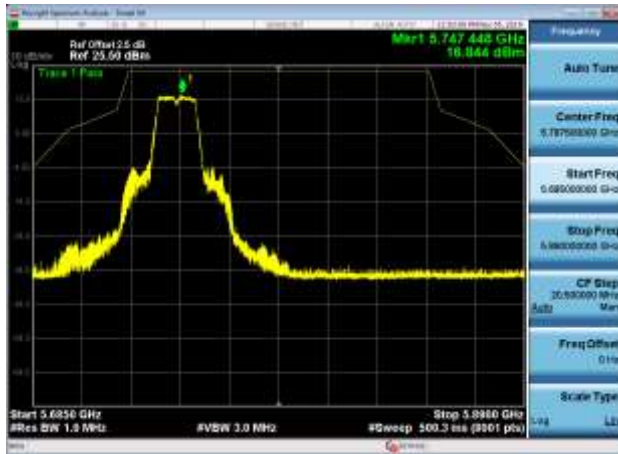

5825MHz PK

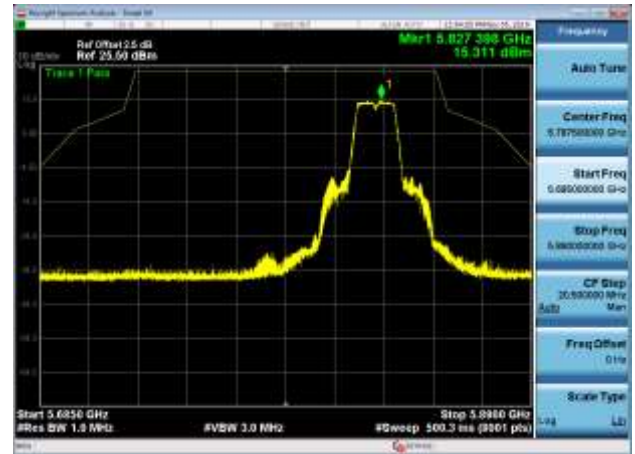

802.11n(20MHz)

5180MHz PK

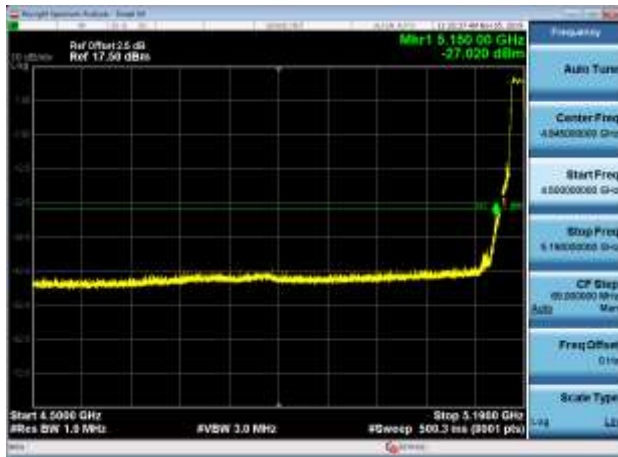

5180MHz AV

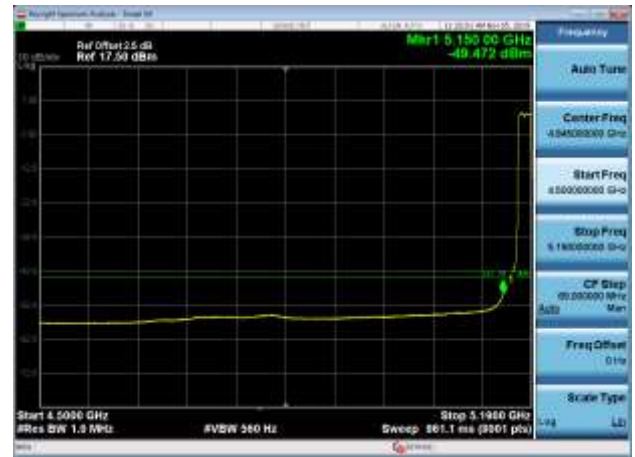

5200MHz PK

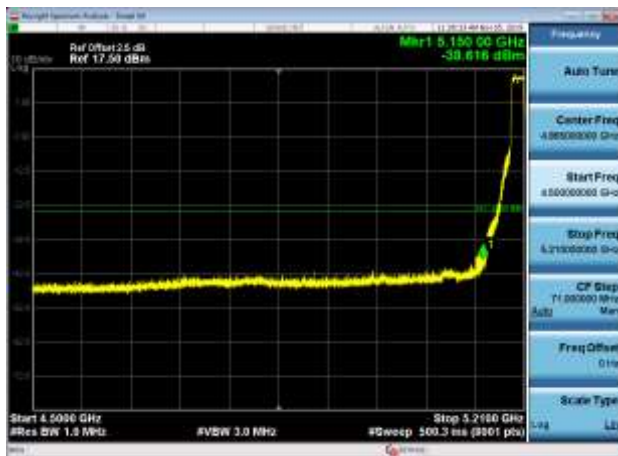

5200MHz AV

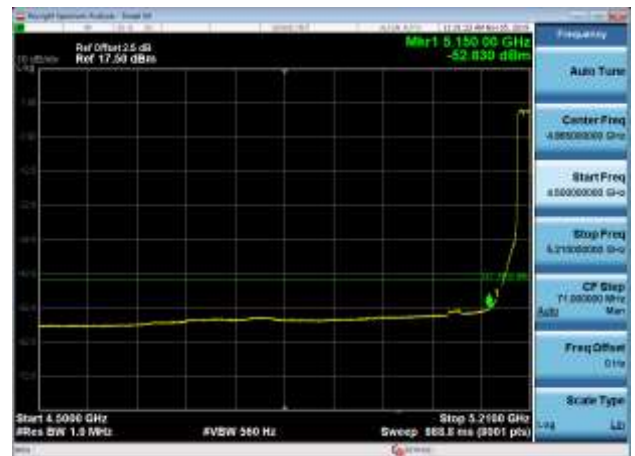

5300MHz PK

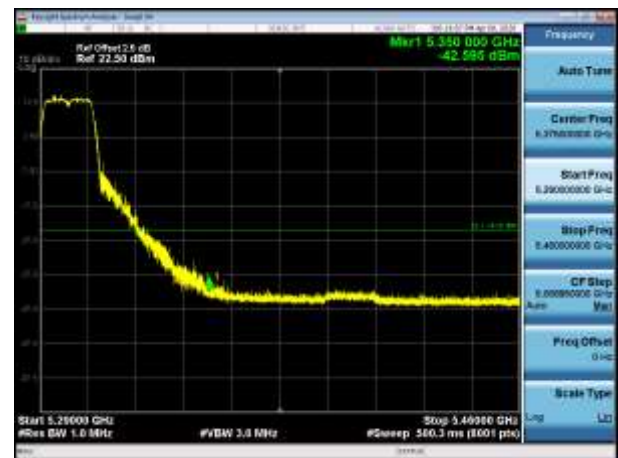

5300MHz AV

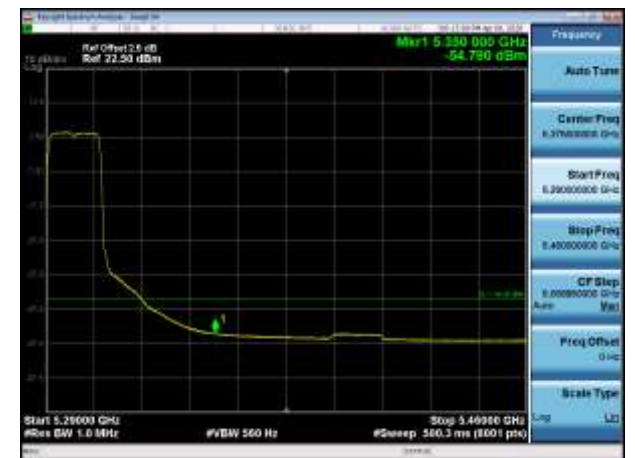

5320MHz PK

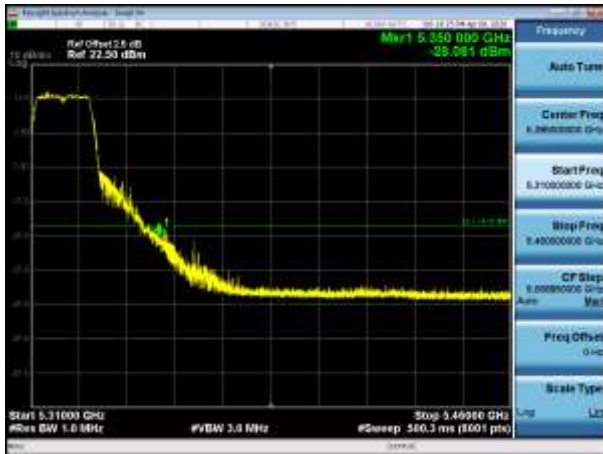

5320MHz AV

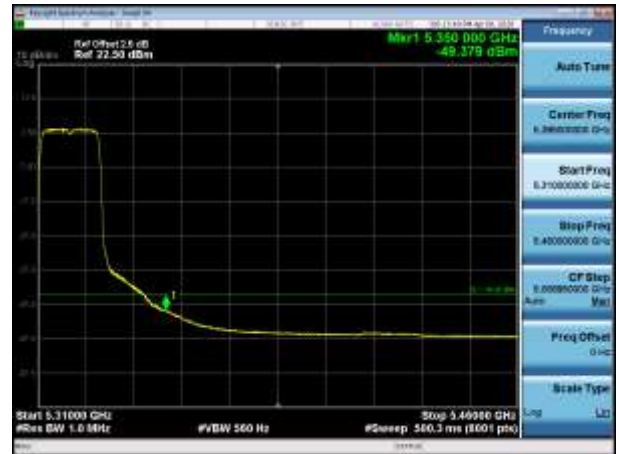

5500MHz PK

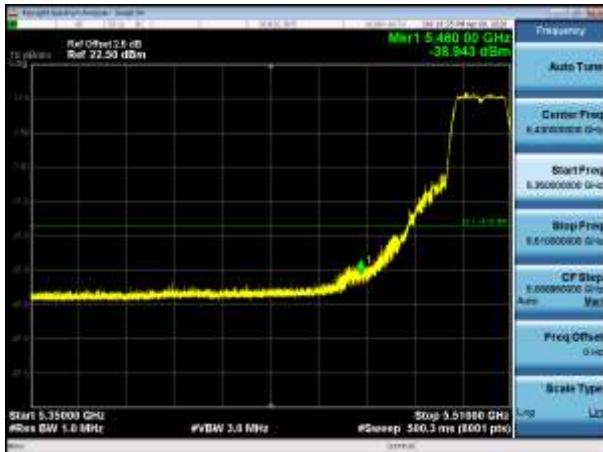

5500MHz AV

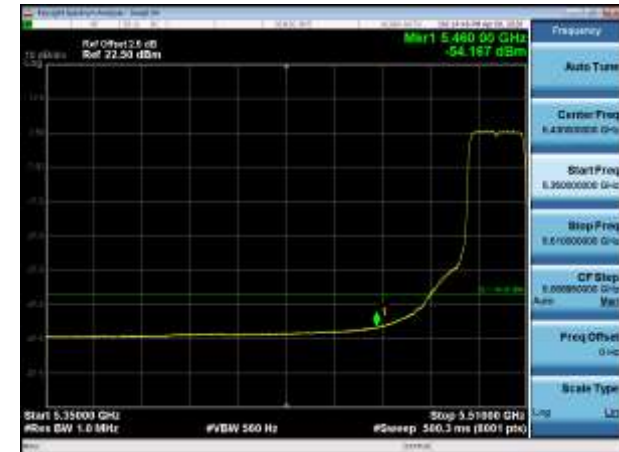

5520MHz PK

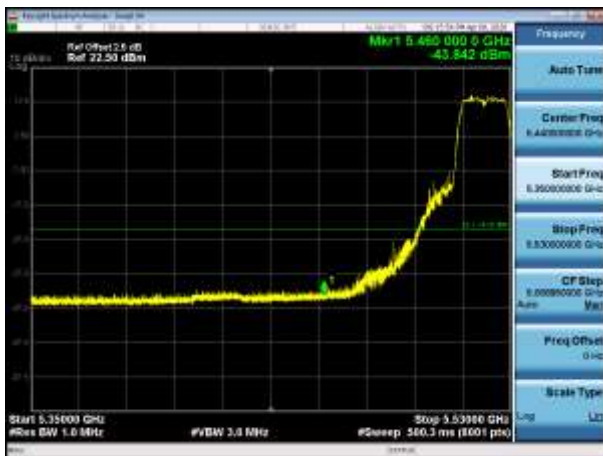

5520MHz AV

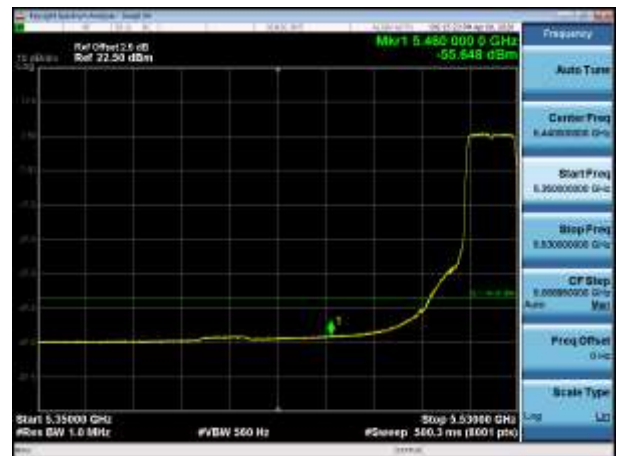

5745MHz PK

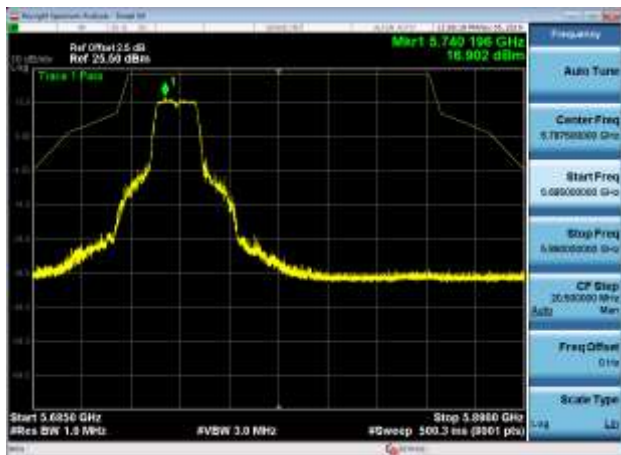

5825MHz PK

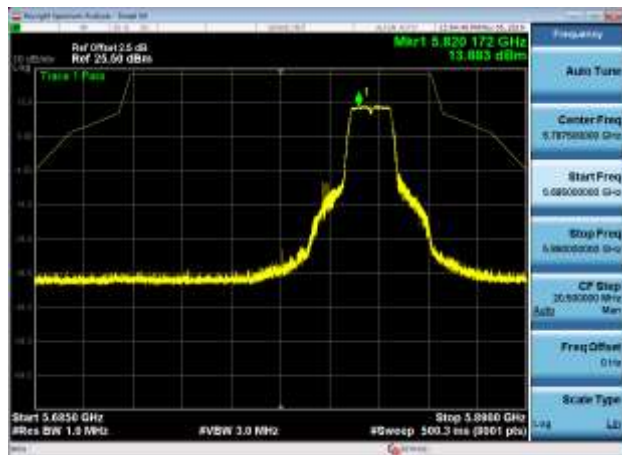

802.11n(40MHz)

5190MHz PK

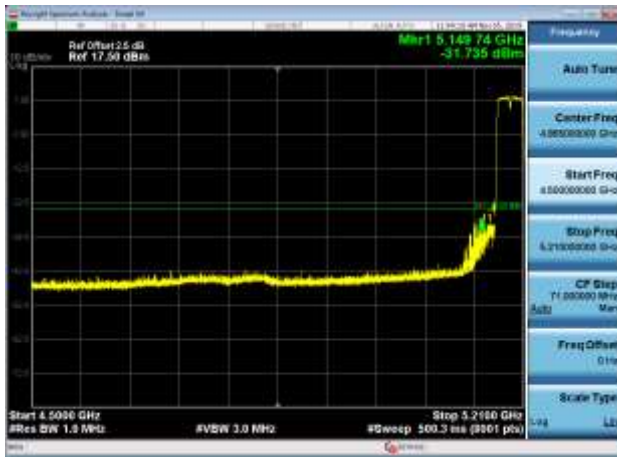

5190MHz AV

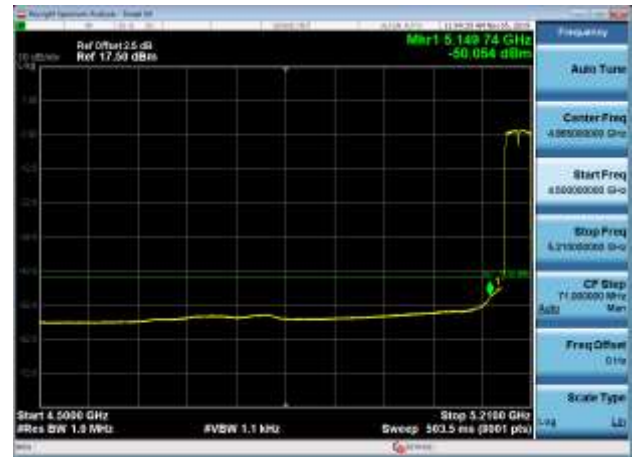

5230MHz PK

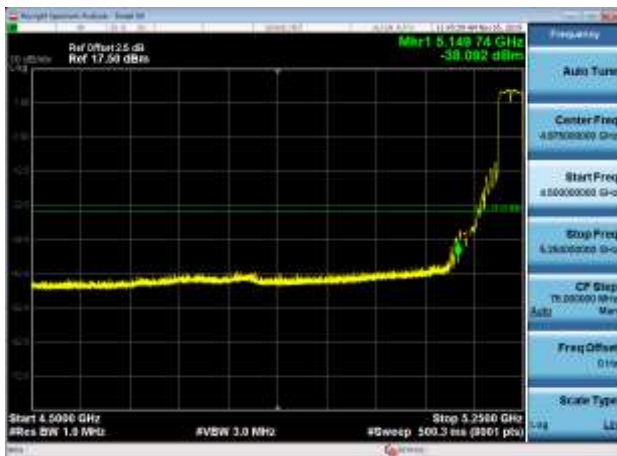

5230MHz AV

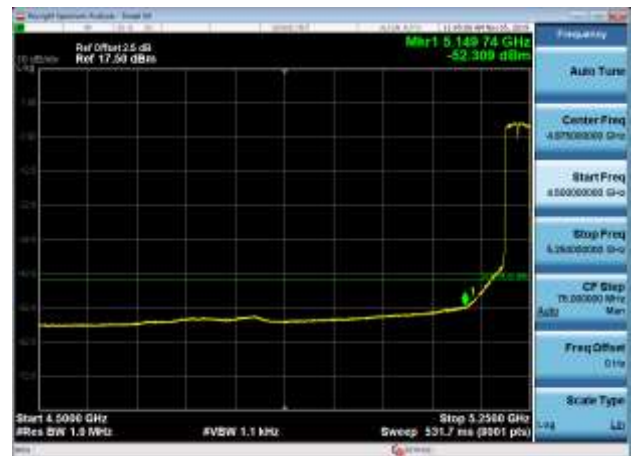

5270MHz PK

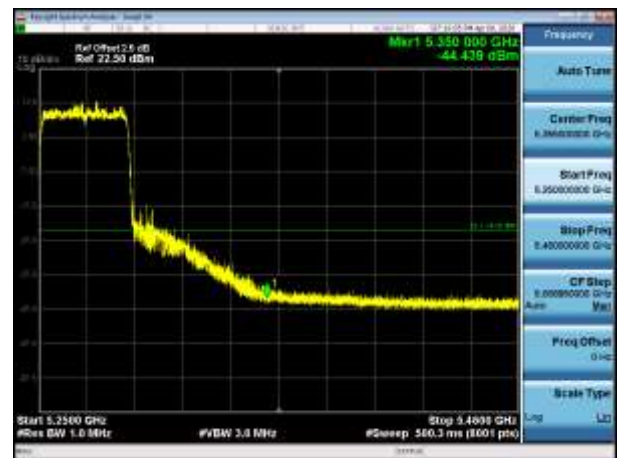

5270MHz AV

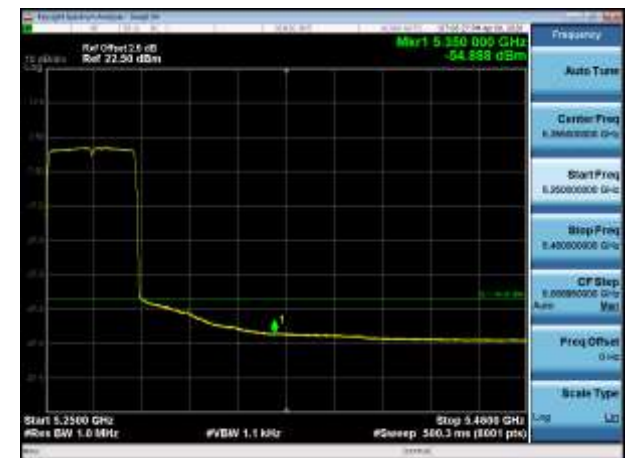

5310MHz PK

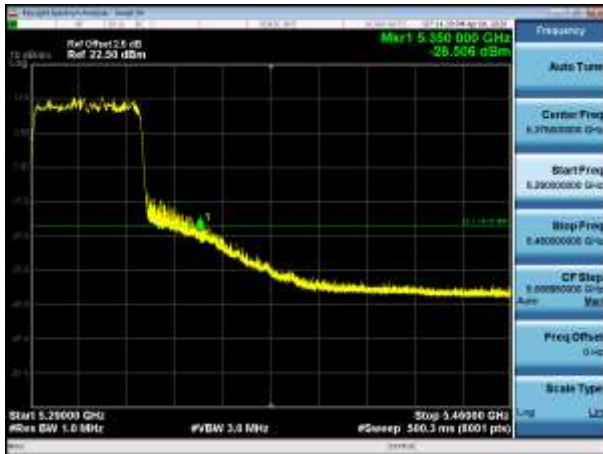

5310MHz AV

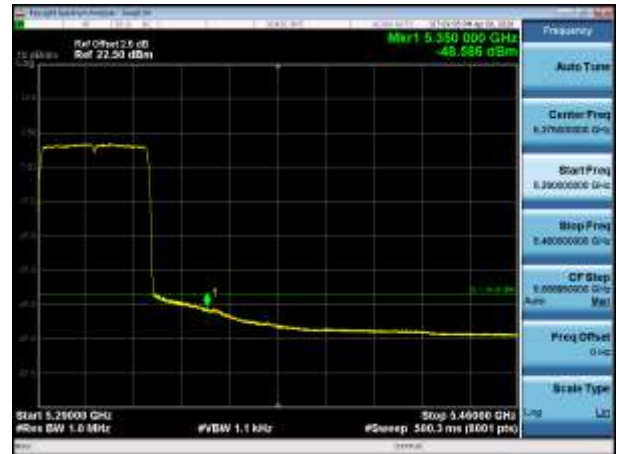

5510MHz PK

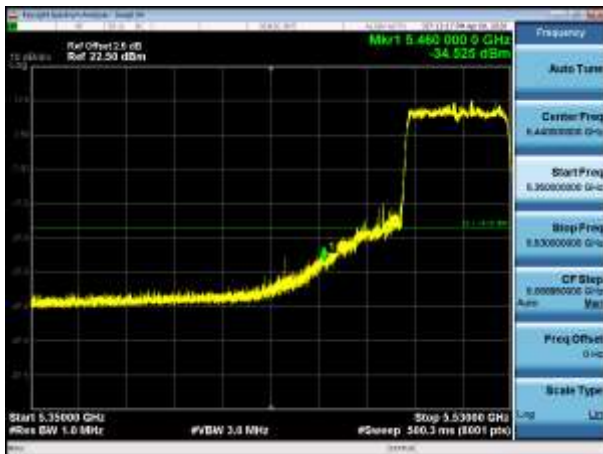

5510MHz AV

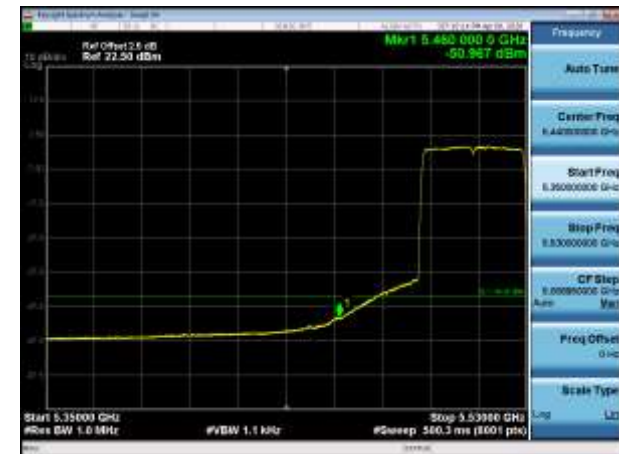

5550MHz PK

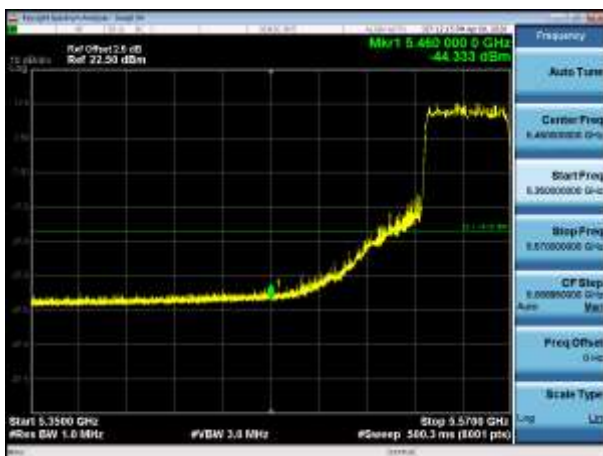

5550MHz AV

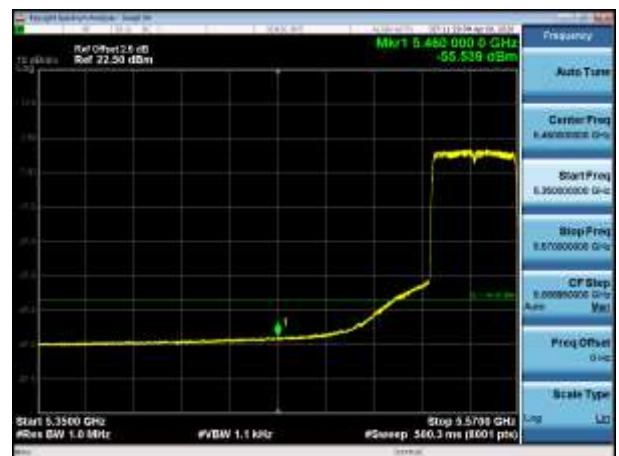

5755MHz PK

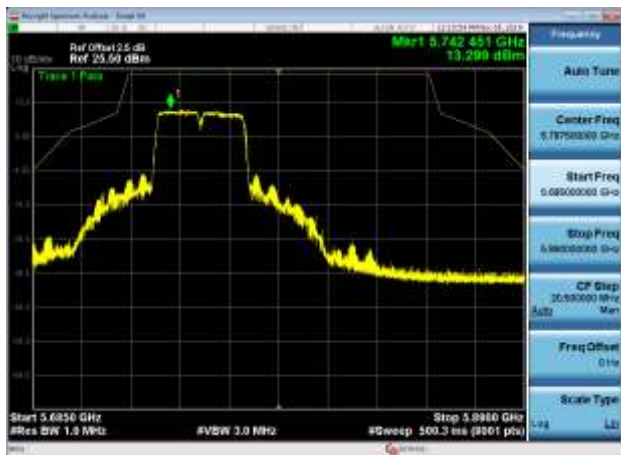

5795MHz PK

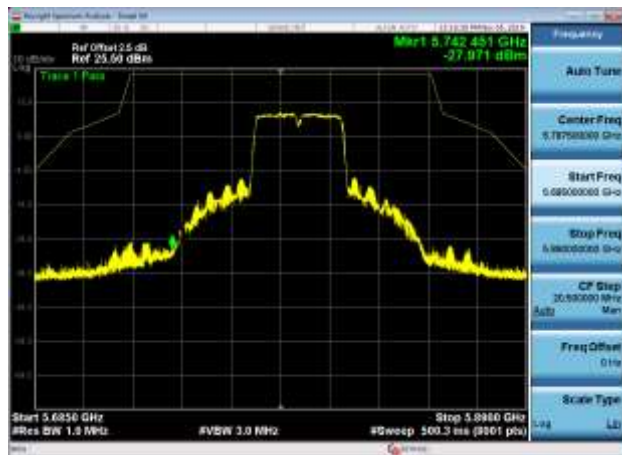

802.11ac(20MHz)

5180MHz PK

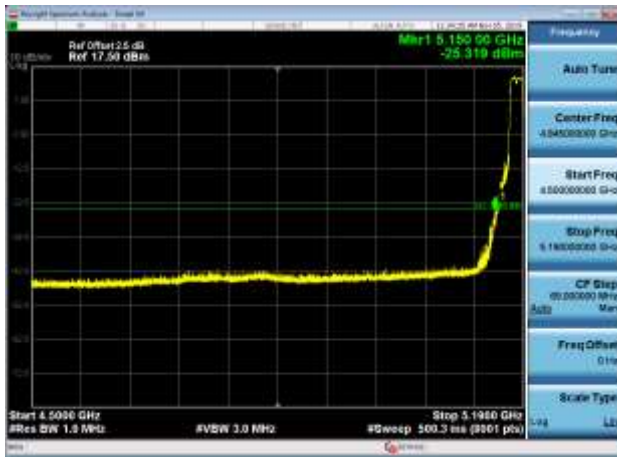

5180MHz AV

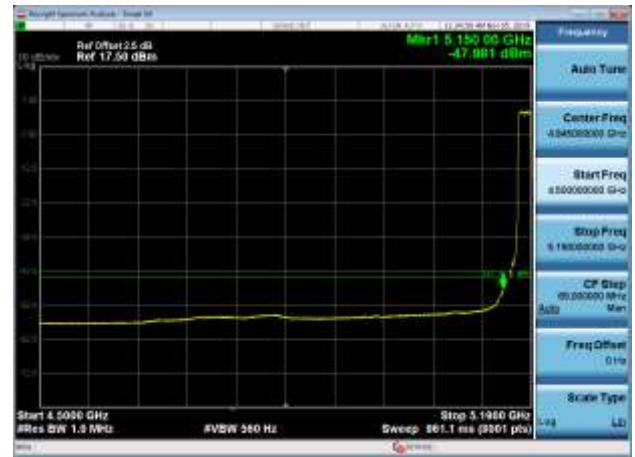

5200MHz PK

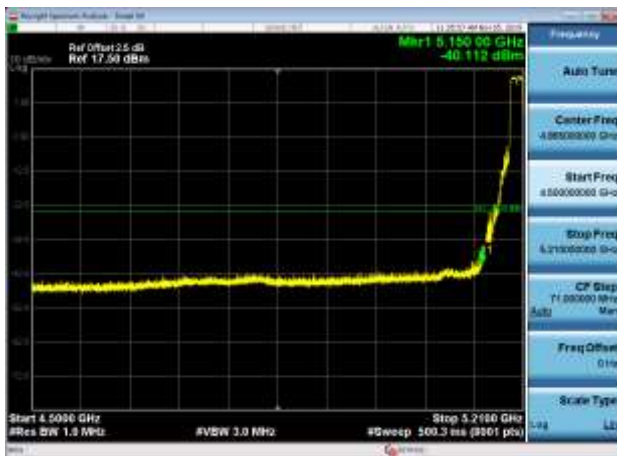

5200MHz AV

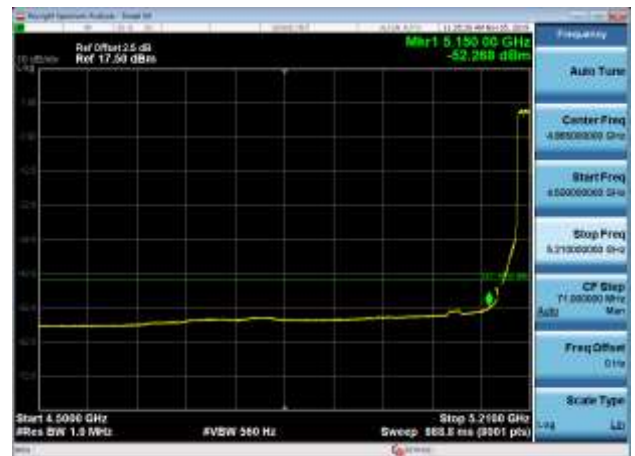

5300MHz PK

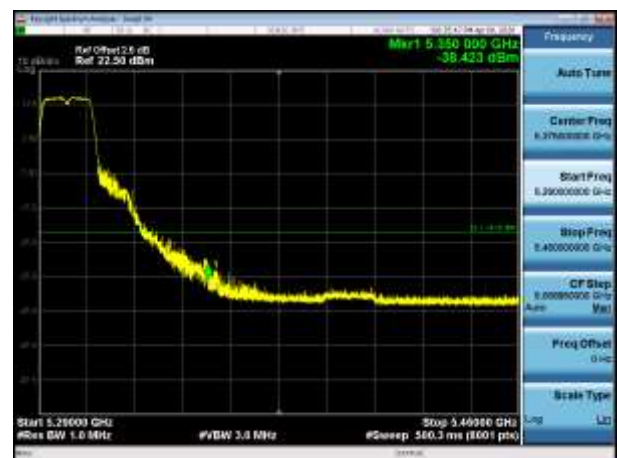

5300MHz AV

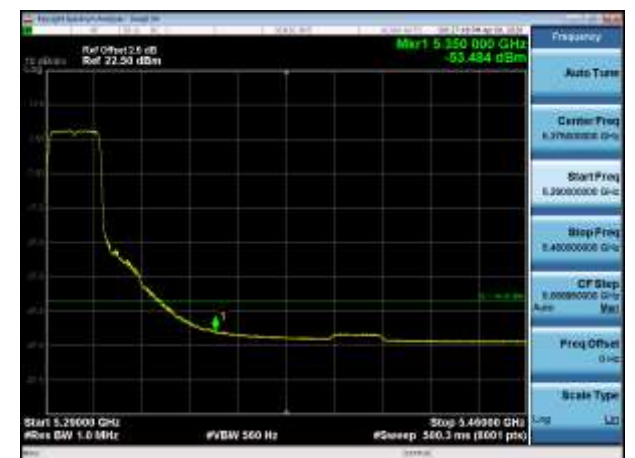

5320MHz PK

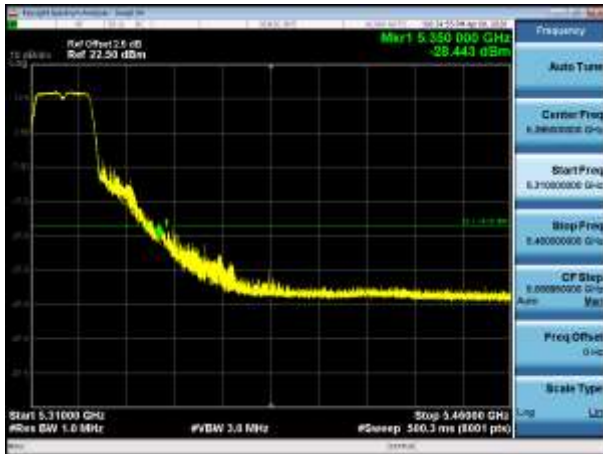

5320MHz AV

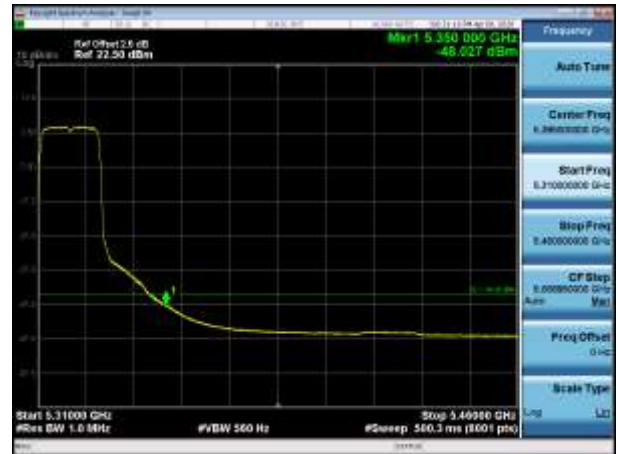

5500MHz PK

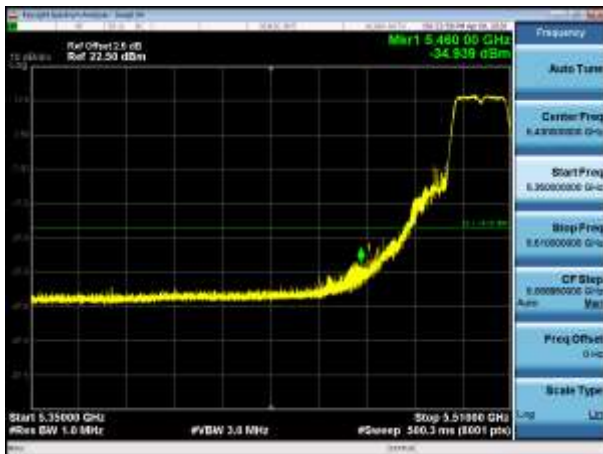

5500MHz AV

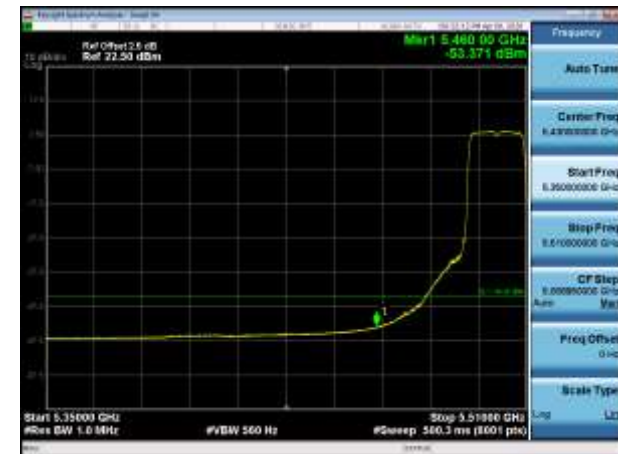

5520MHz PK

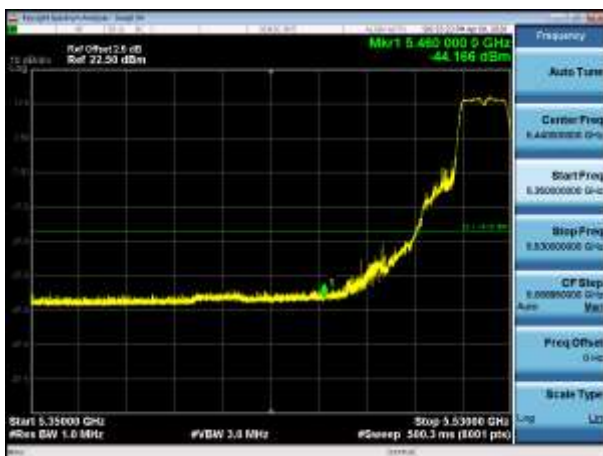

5520MHz AV

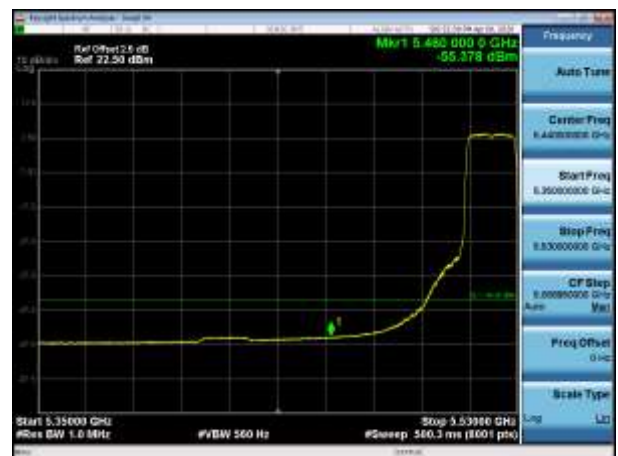

5745MHz PK

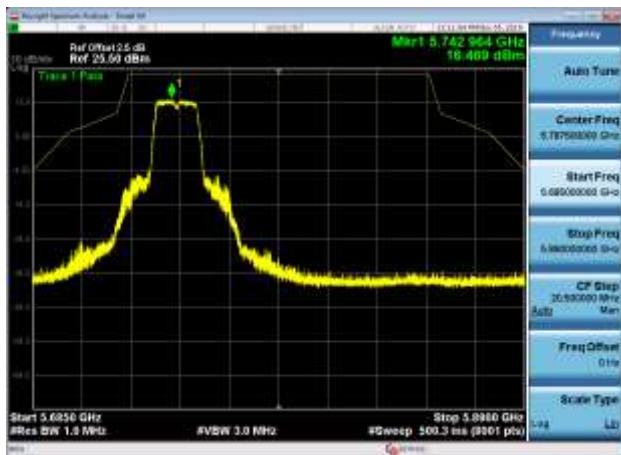

5825MHz PK

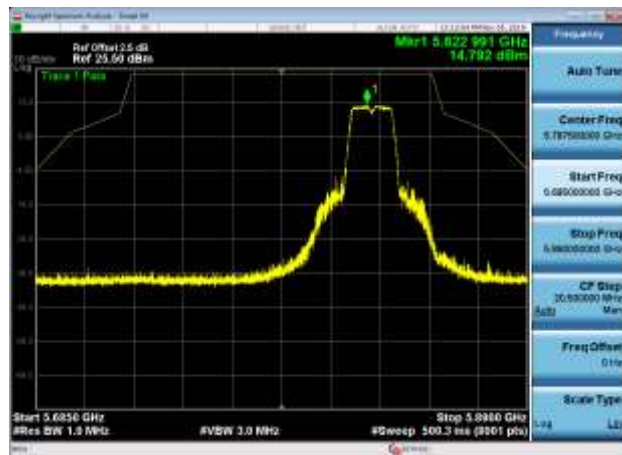

802.11ac(40MHz)

5190MHz PK

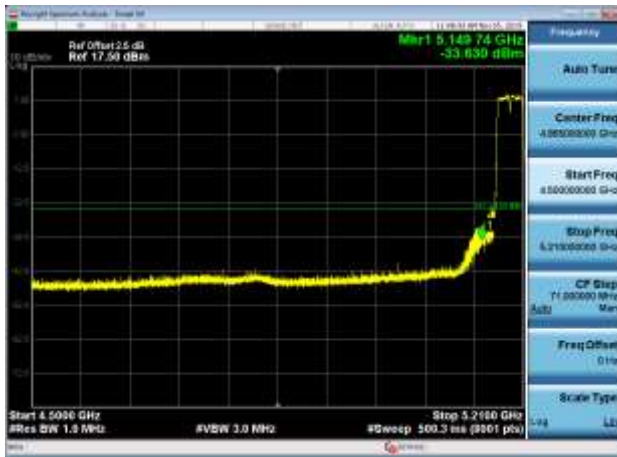

5190MHz AV

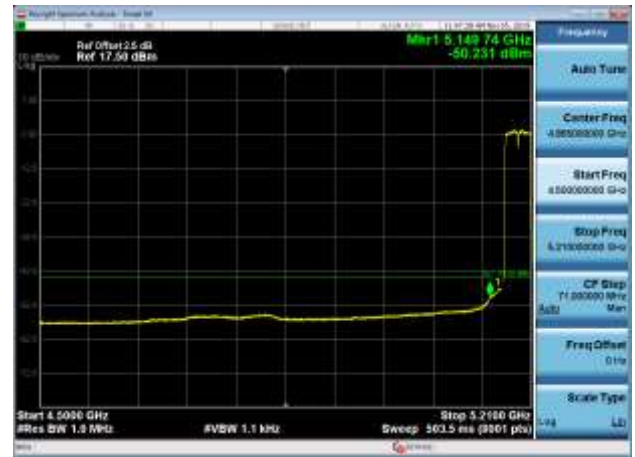

5230MHz PK

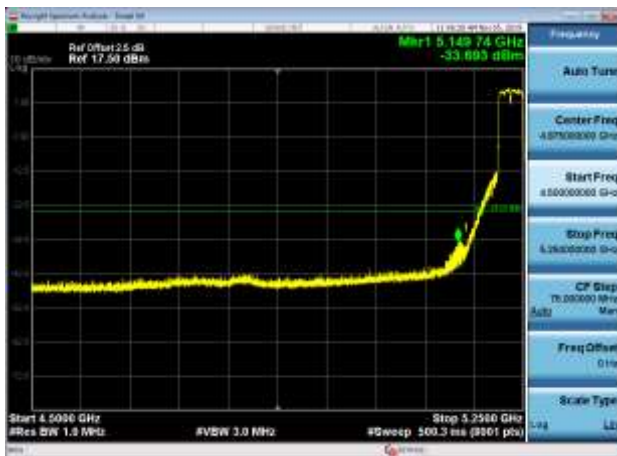

5230MHz AV

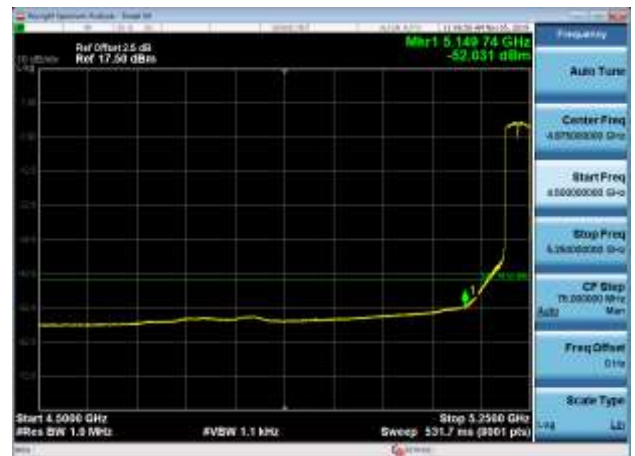

5270MHz PK

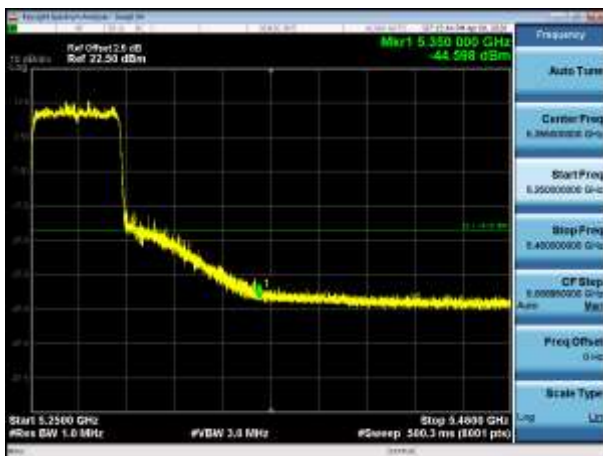

5270MHz AV

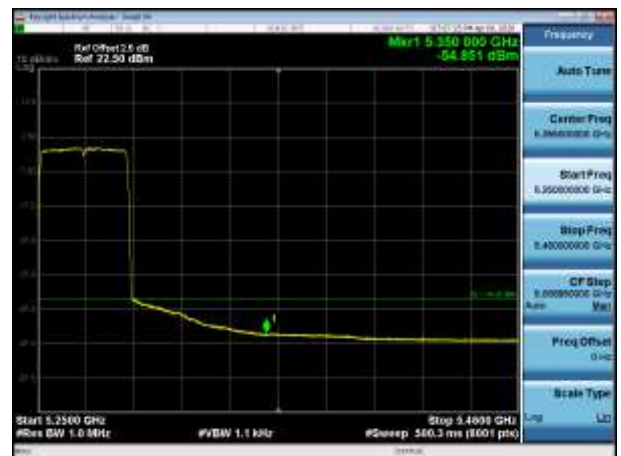

5310MHz PK

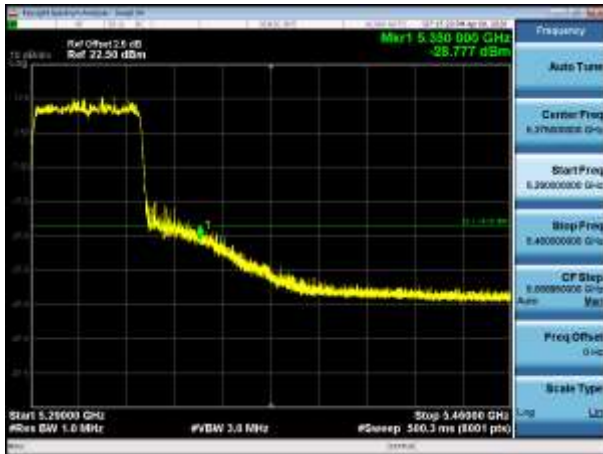

5310MHz AV

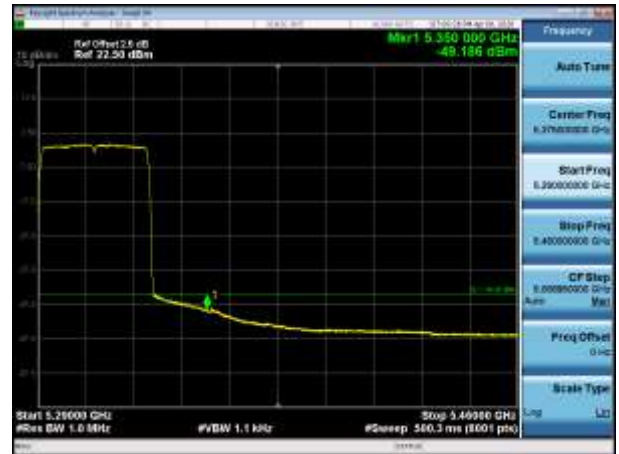

5510MHz PK

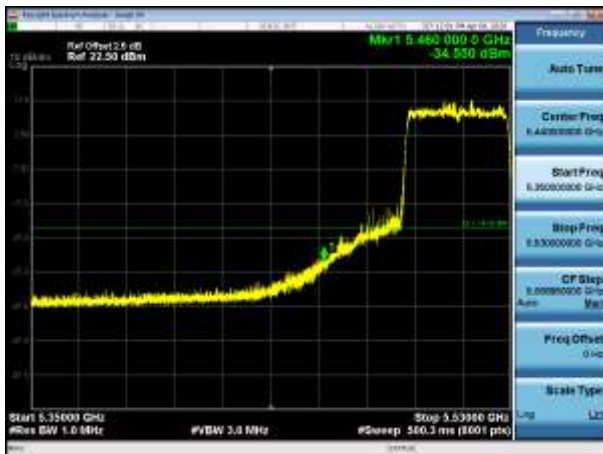

5510MHz AV

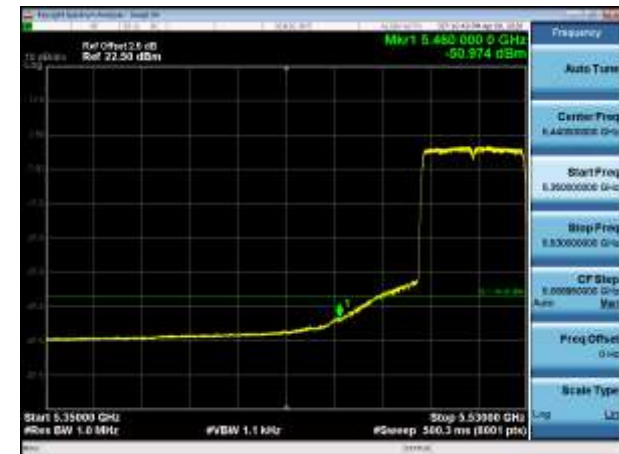

5550MHz PK

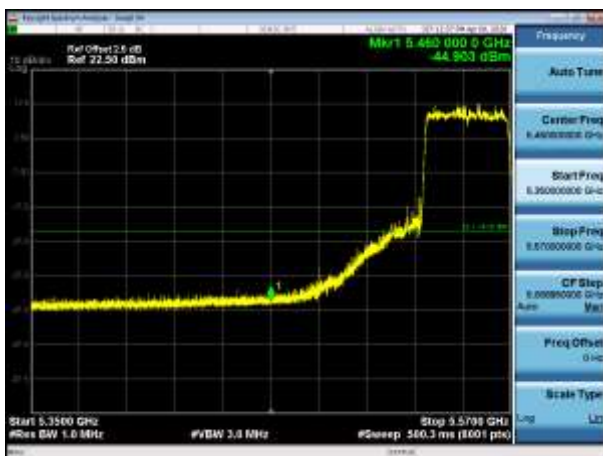

5550MHz AV

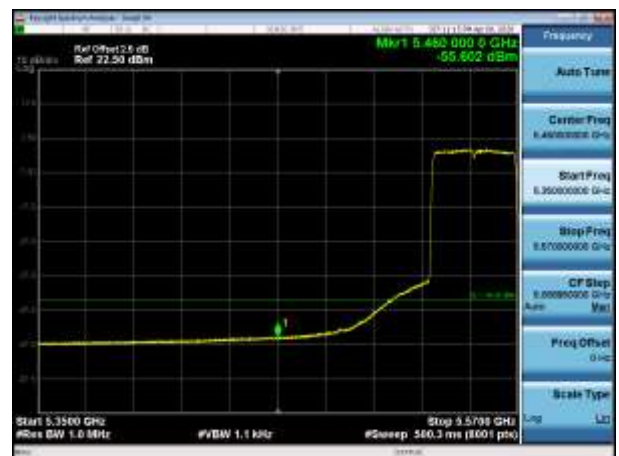

5755MHz PK

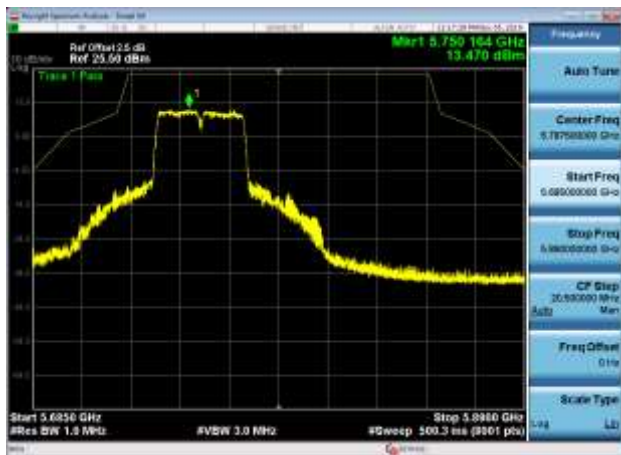

5795MHz PK

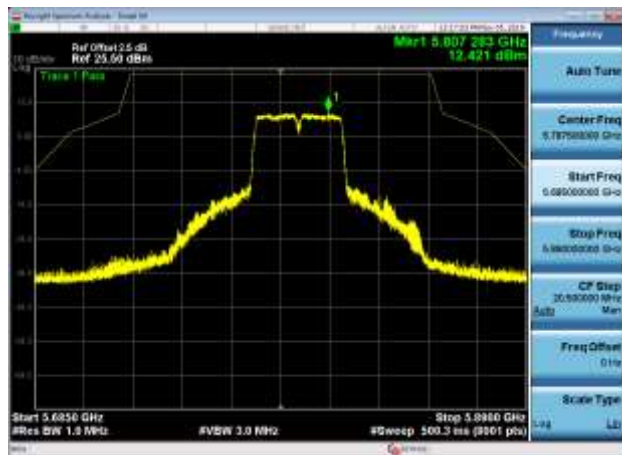

802.11ac(80MHz)

5210MHz PK

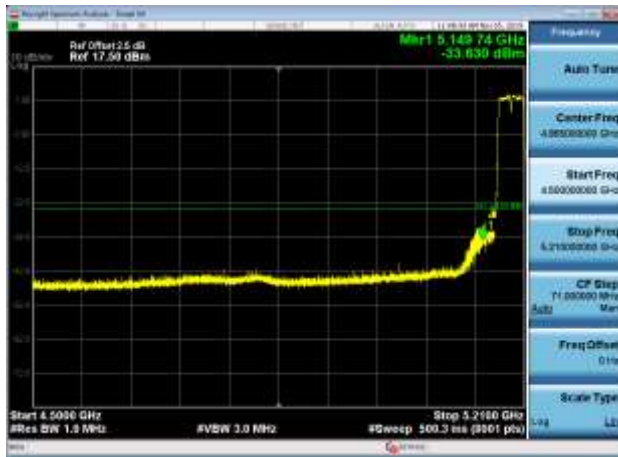

5210MHz AV

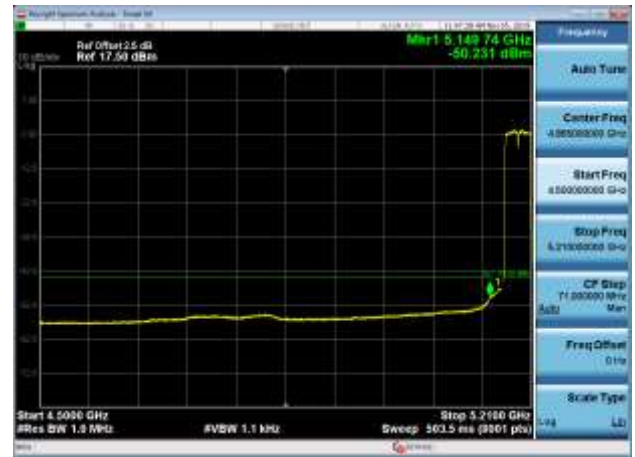

5290MHz PK

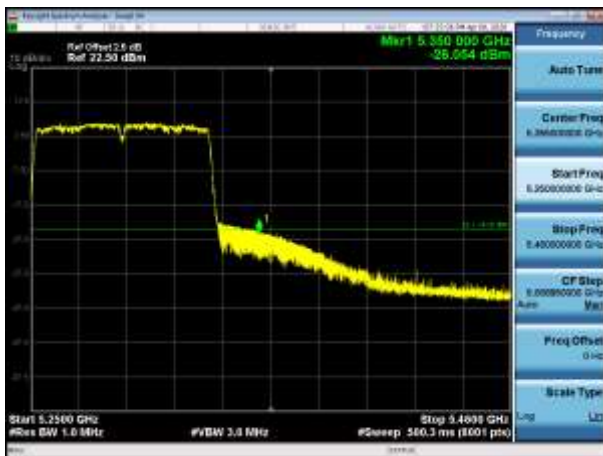

5290MHz AV

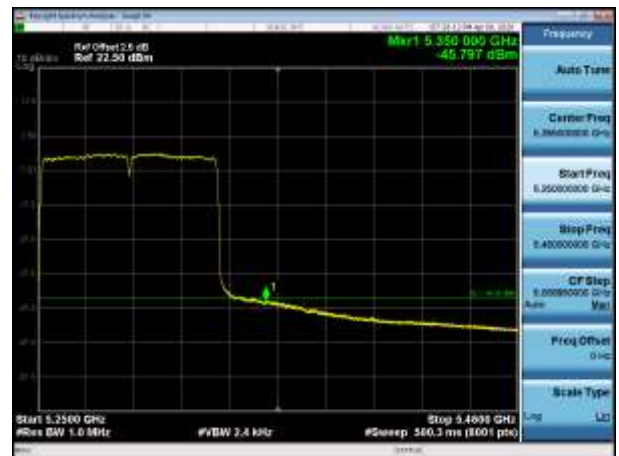

5530MHz PK

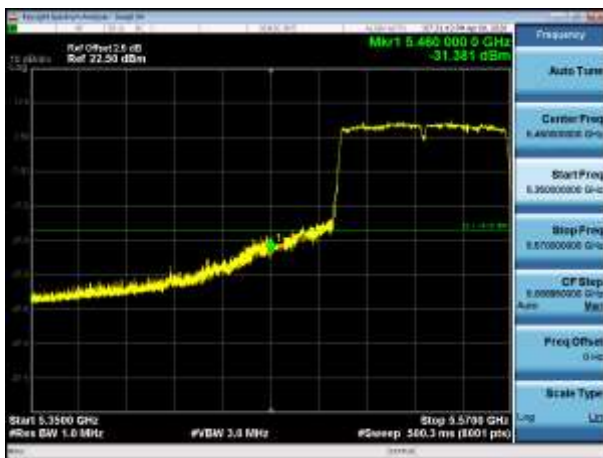

5530MHz AV

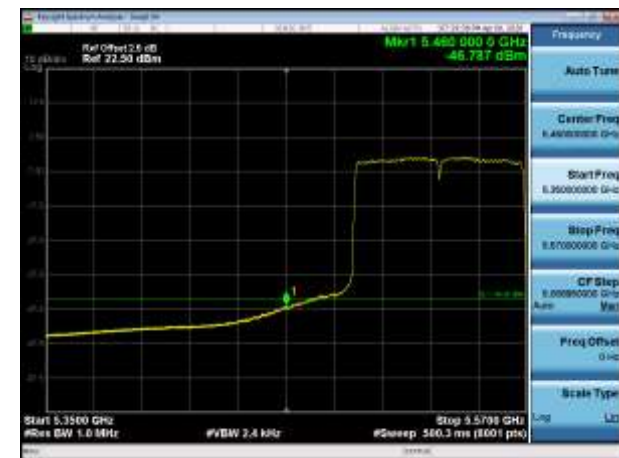

5610MHz PK

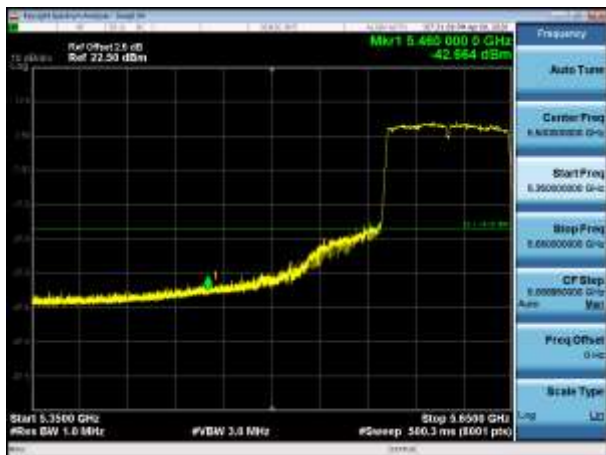

5610MHz AV

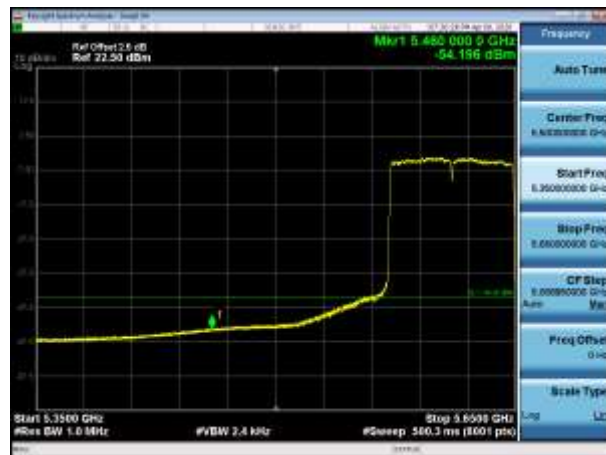

5775MHz PK

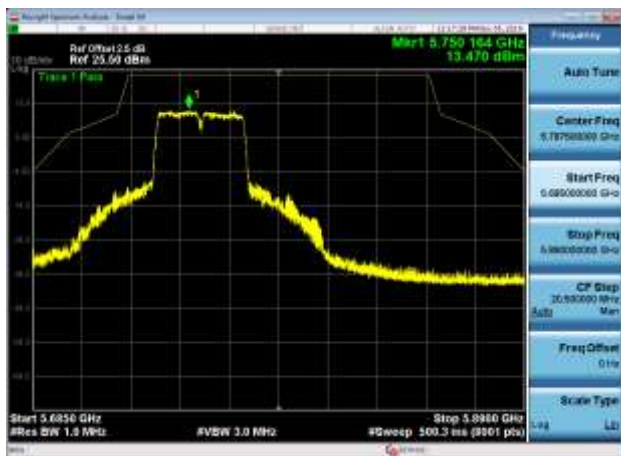

802.11ax(20MHz)

5180MHz PK

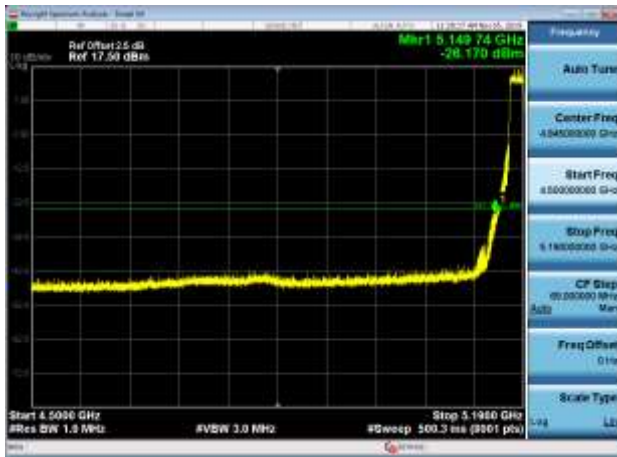

5180MHz AV

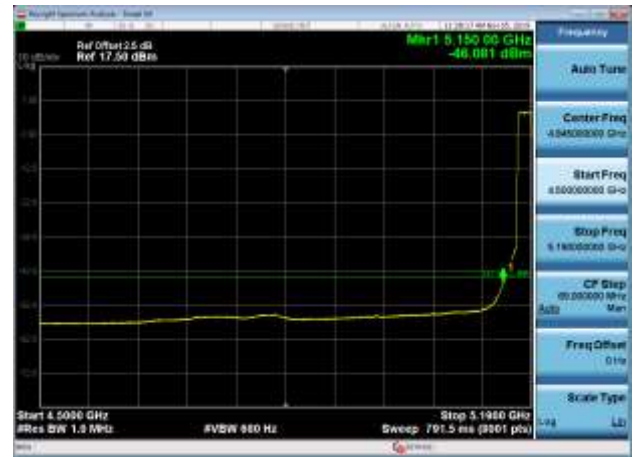

5200MHz PK

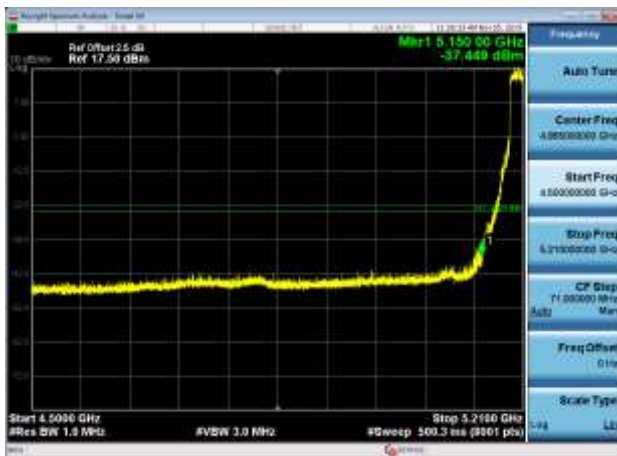

5200MHz AV

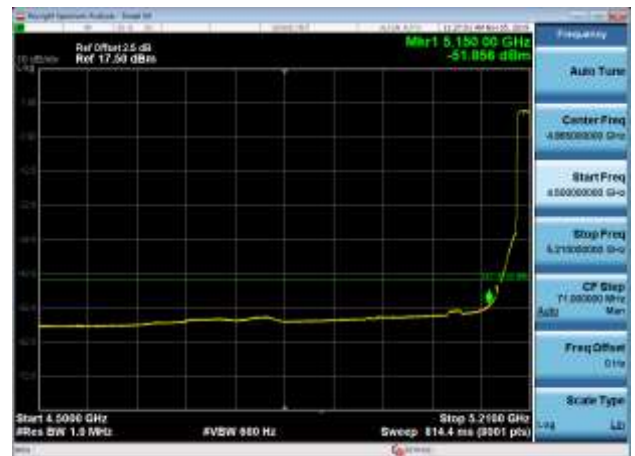

5300MHz PK

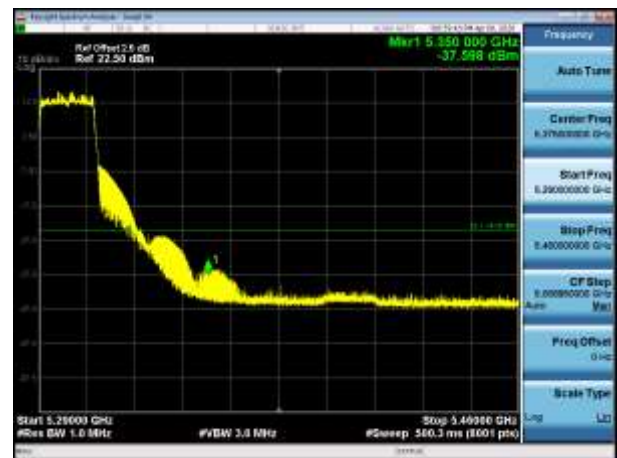

5300MHz AV

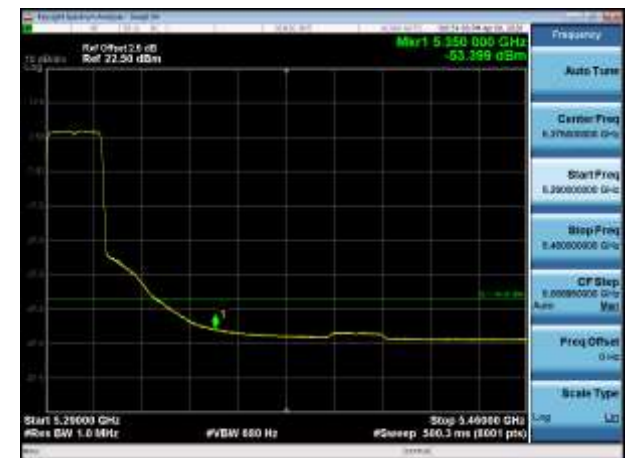

5320MHz PK

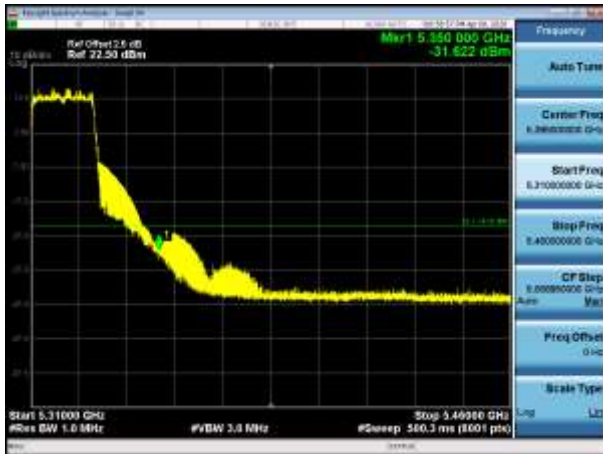

5320MHz AV

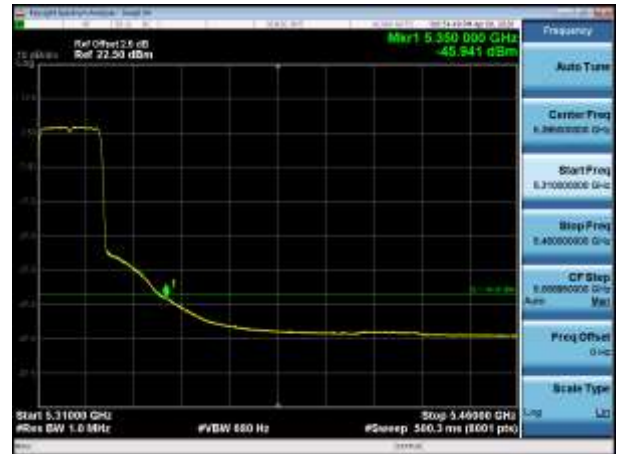

5500MHz PK

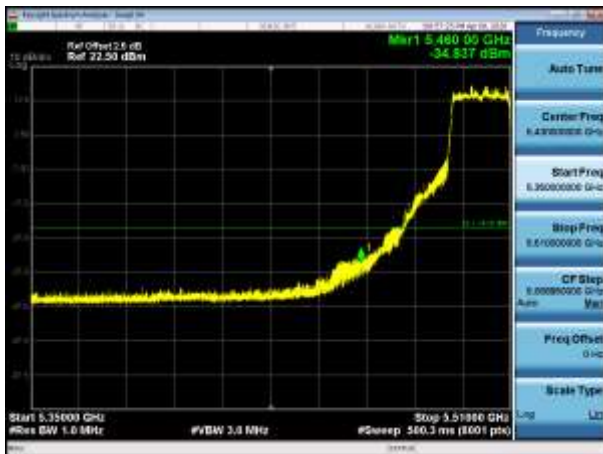

5500MHz AV

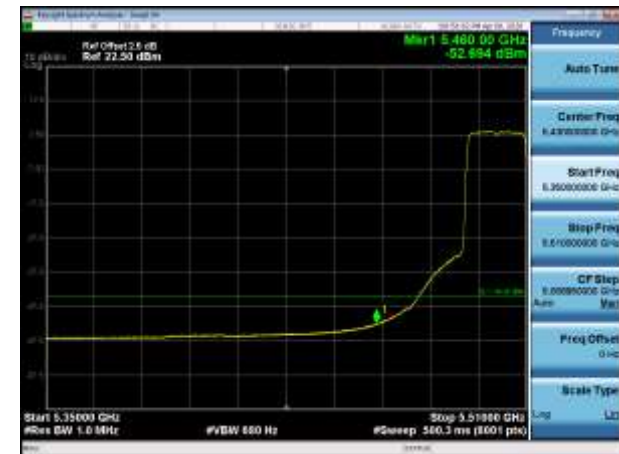

5520MHz PK

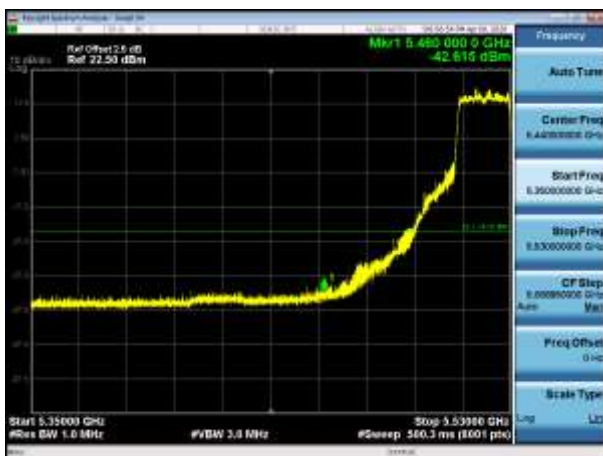

5520MHz AV

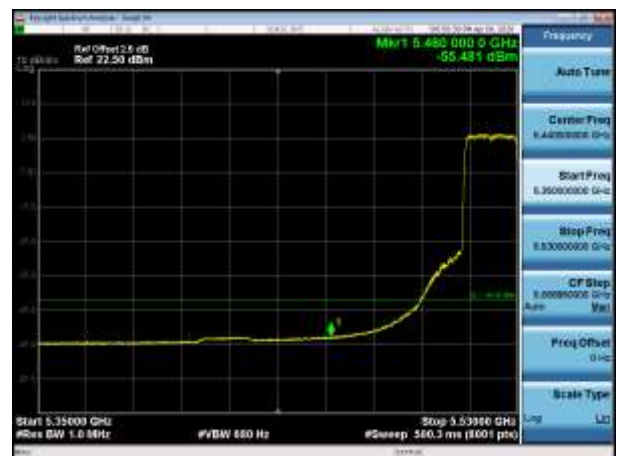

5745MHz PK

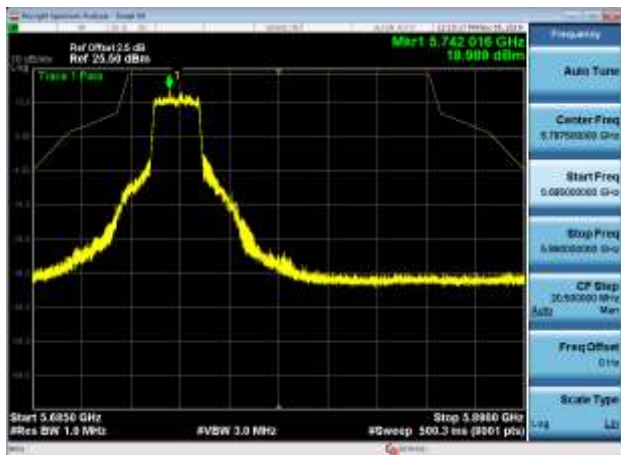

5825MHz PK

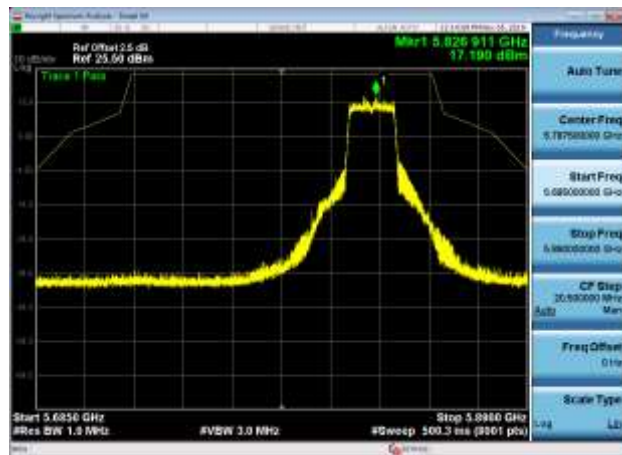

802.11ax(40MHz)

5190MHz PK

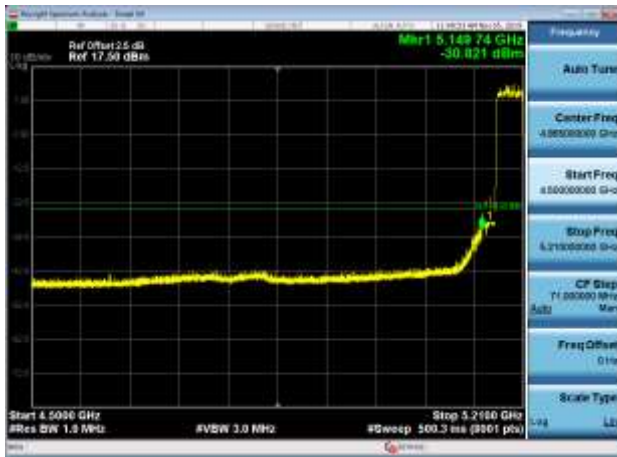

5190MHz AV

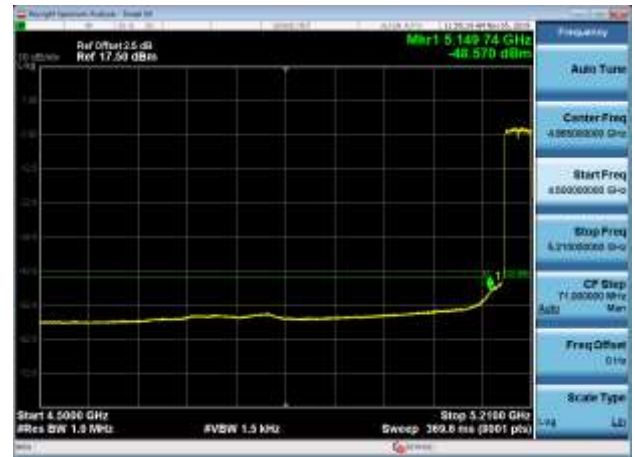

5230MHz PK

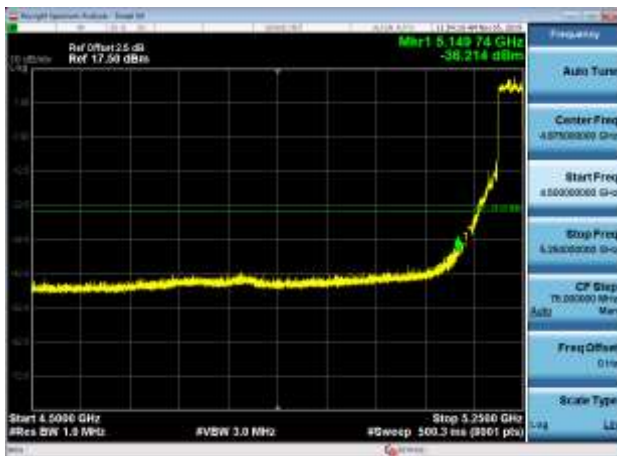

5230MHz AV

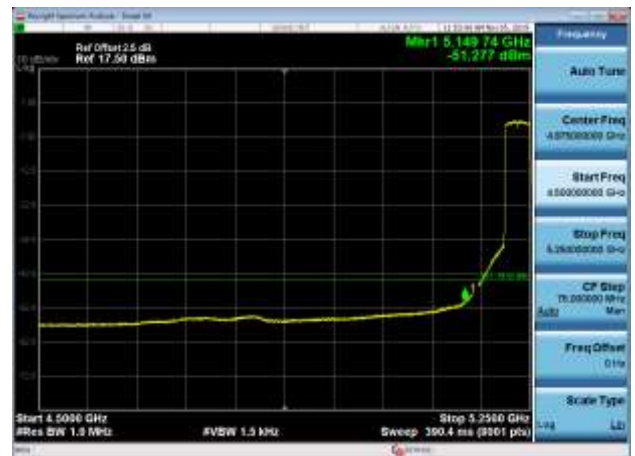

5270MHz PK

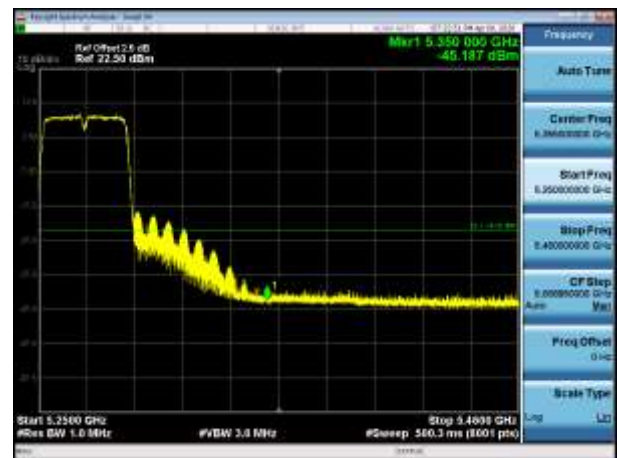

5270MHz AV

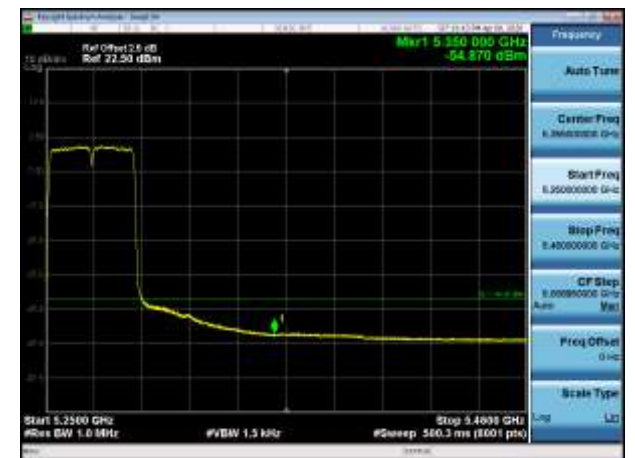

5310MHz PK

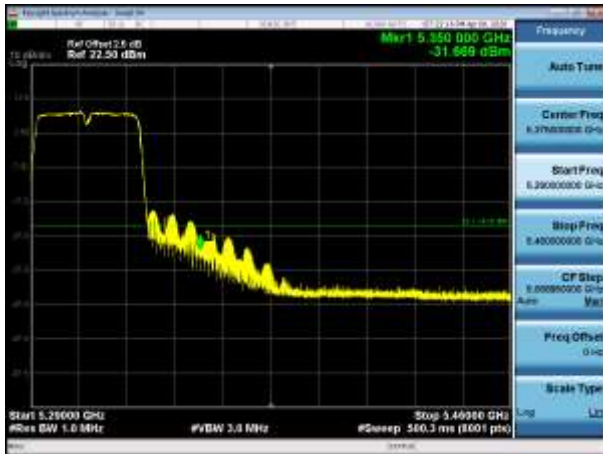

5310MHz AV

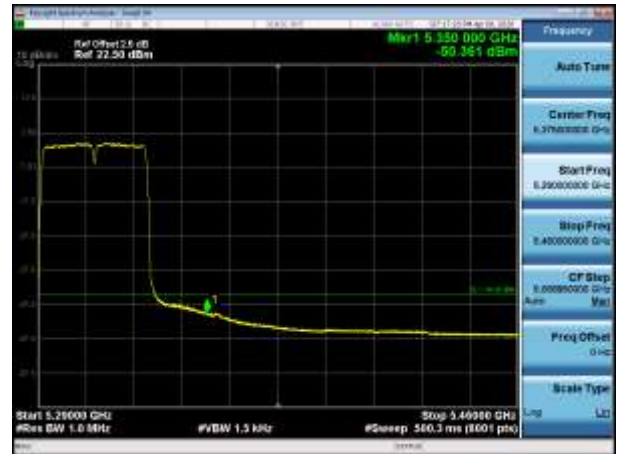

5510MHz PK

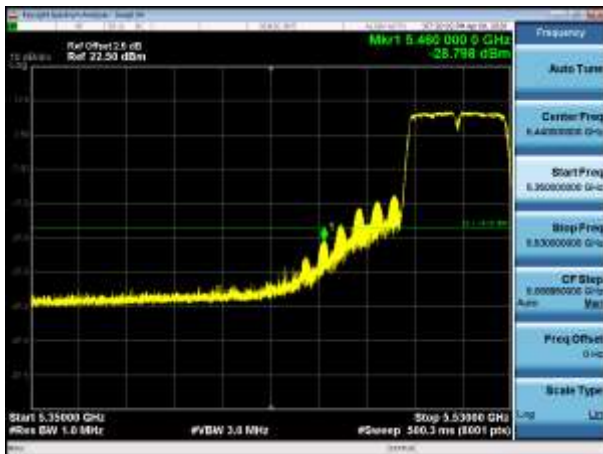

5510MHz AV

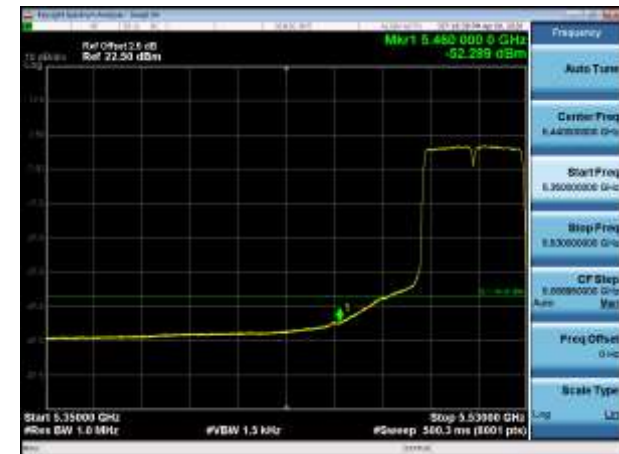

5550MHz PK

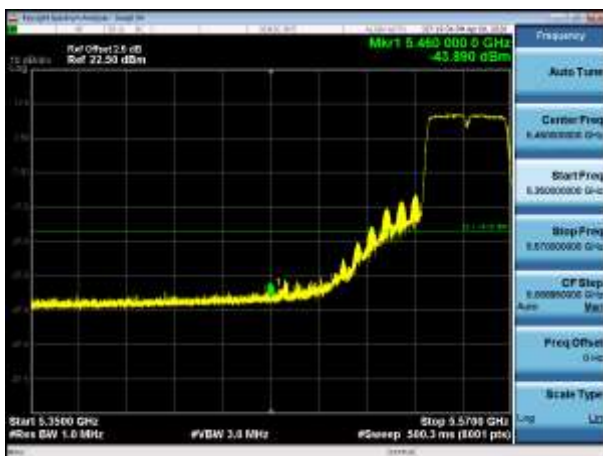

5550MHz AV

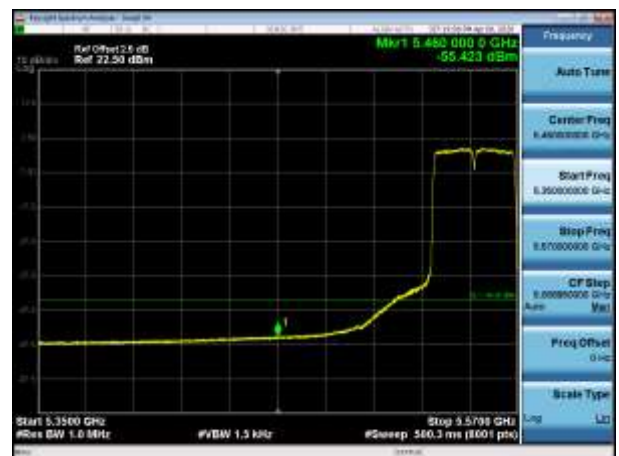

5755MHz PK

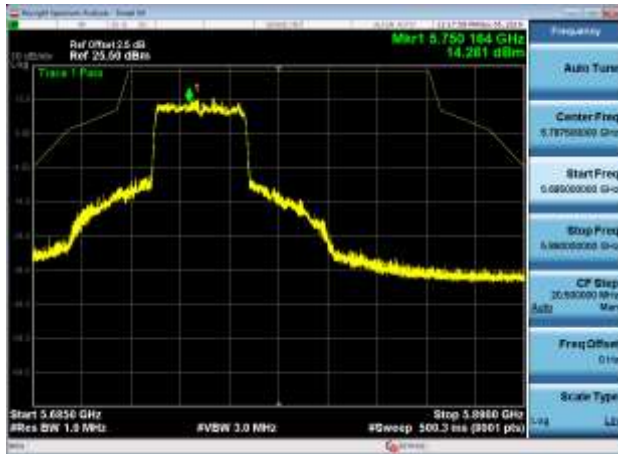

5795MHz PK

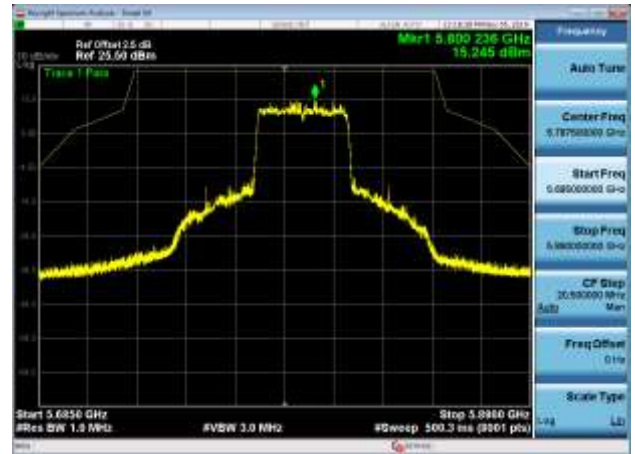

802.11ax(80MHz)

5210MHz PK

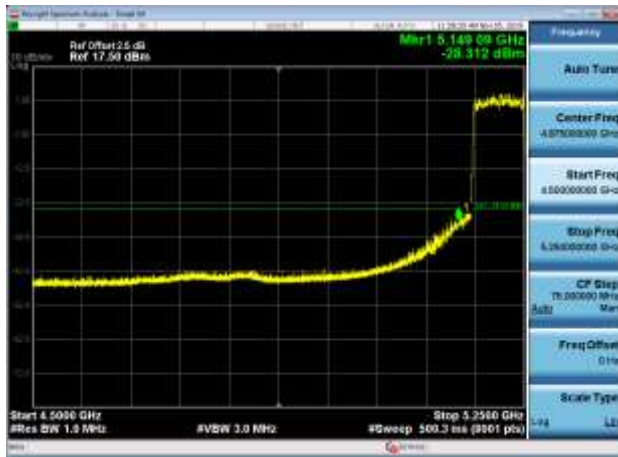

5210MHz AV

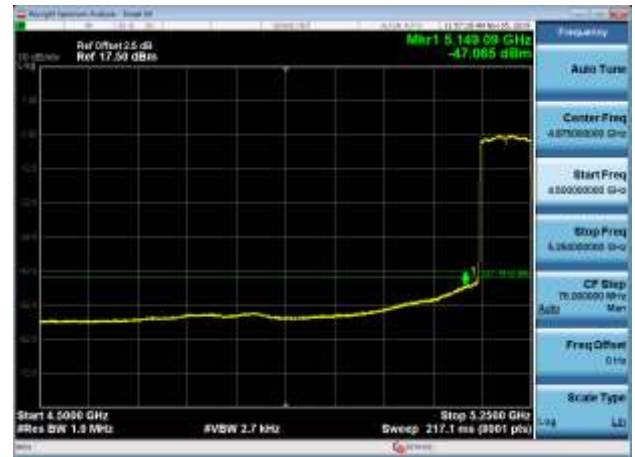

5290MHz PK

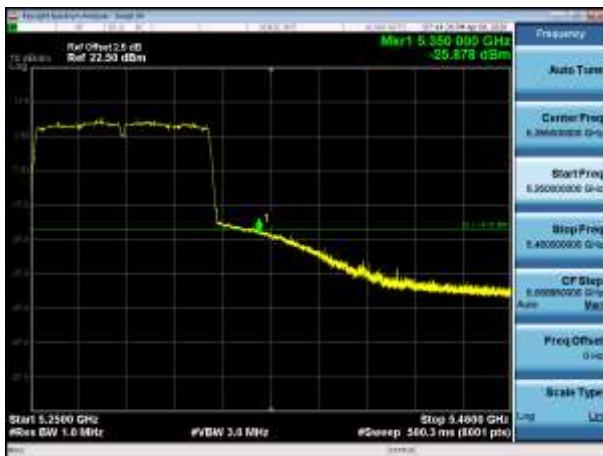

5290MHz AV

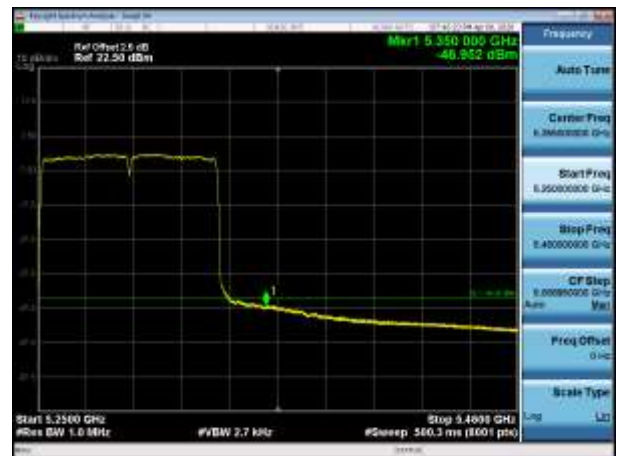

5530MHz PK

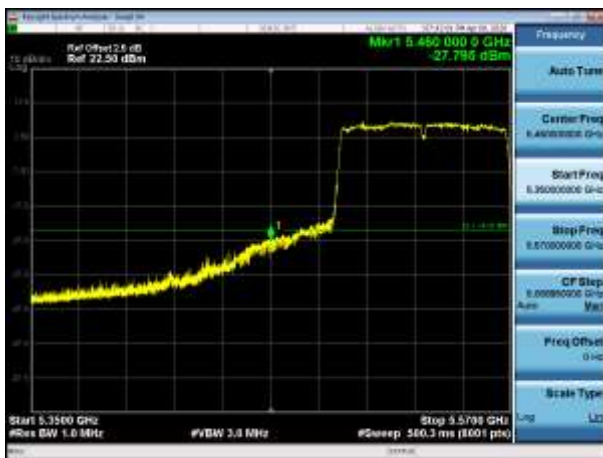

5530MHz AV

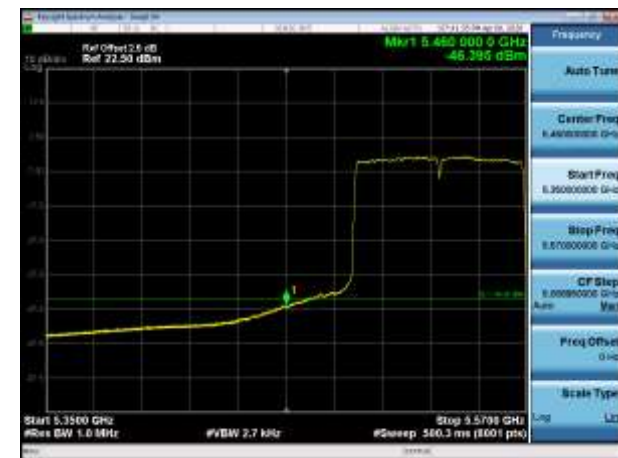

5610MHz PK

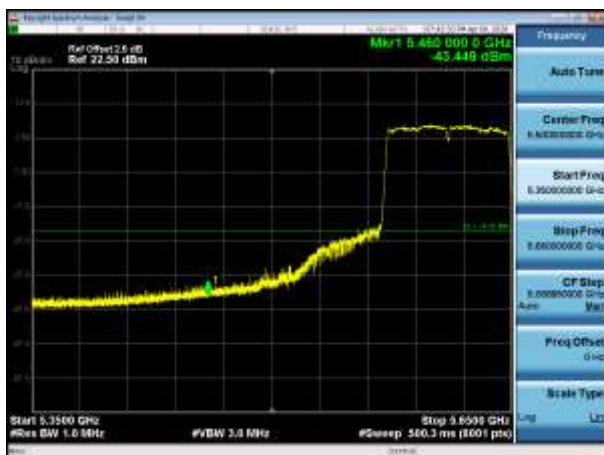

5610MHz AV

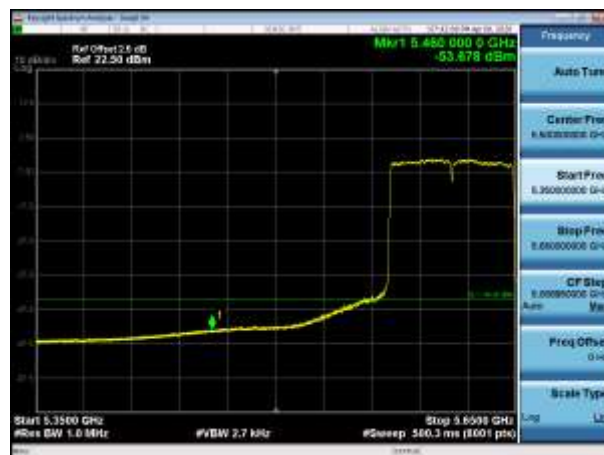

5775MHz PK

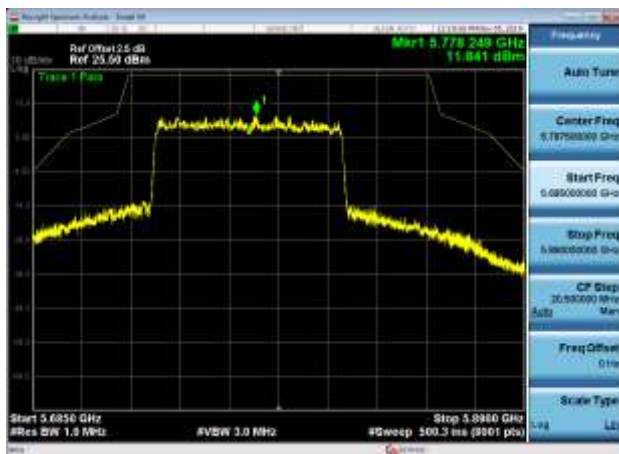

**Radio 2:
802.11a**

5180MHz with 2*2 CDD PK

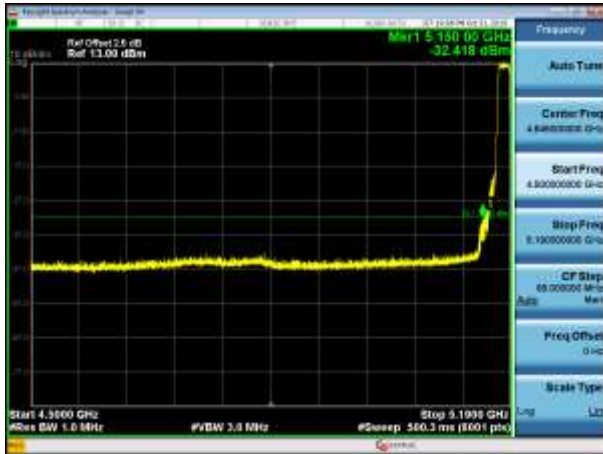

5180MHz with 2*2 CDD AV

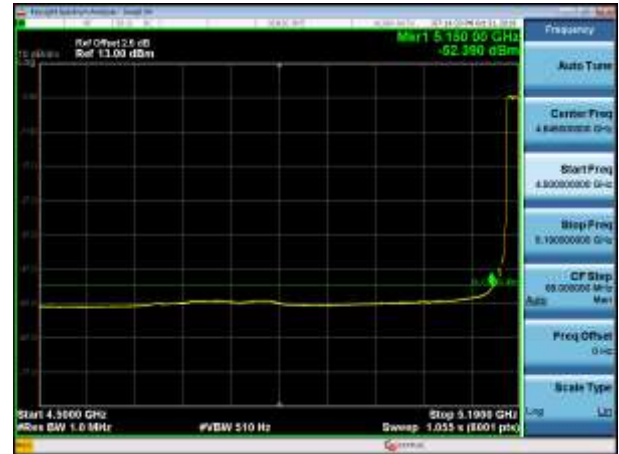

5200MHz with 2*2 CDD PK

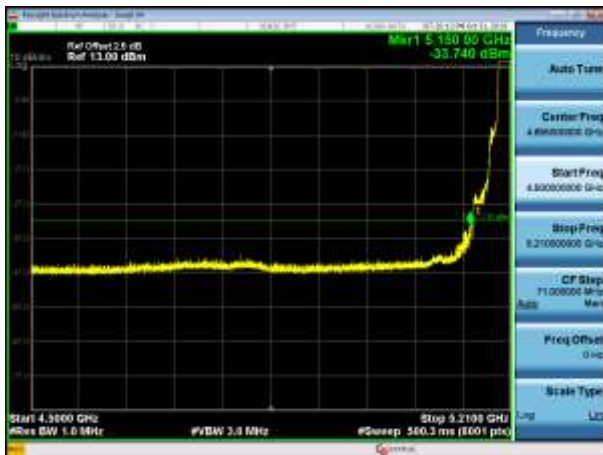

5200MHz with 2*2 CDD AV



5320MHz with 2*2 CDD PK

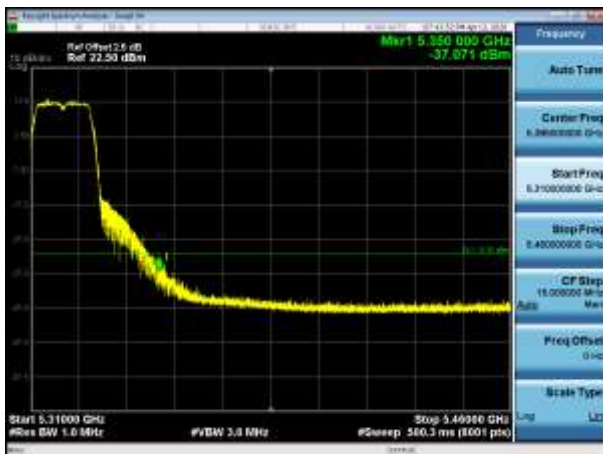

5320MHz with 2*2 CDD AV

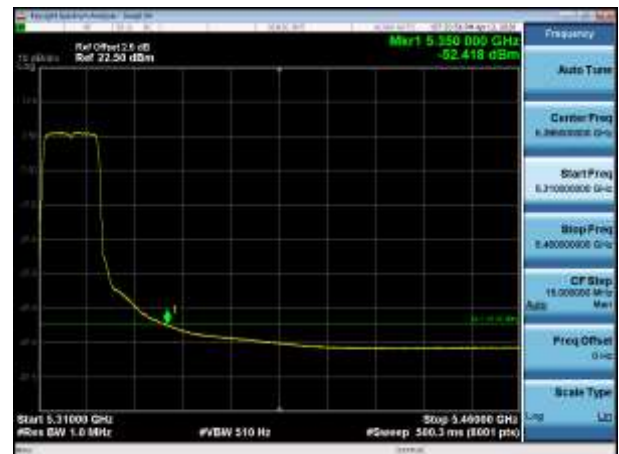

802.11n(20MHz)

5180MHz with 2*2 CDD PK

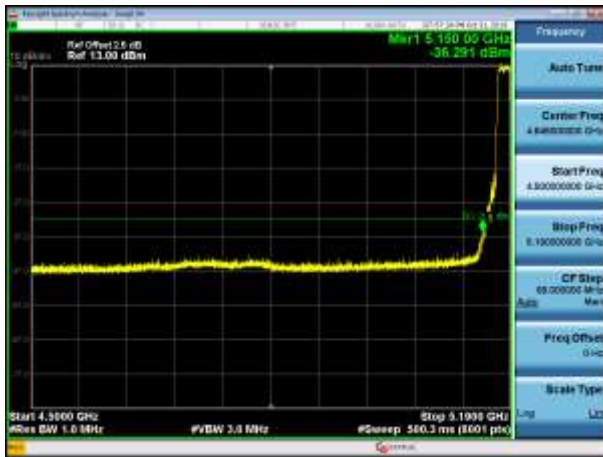

5180MHz with 2*2 CDD AV

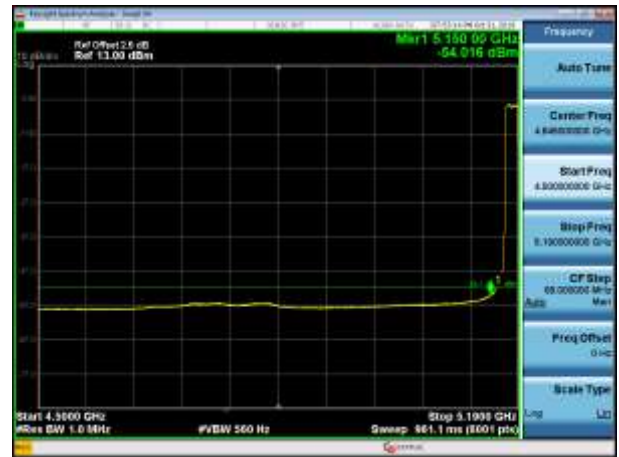

5200MHz with 2*2 CDD PK

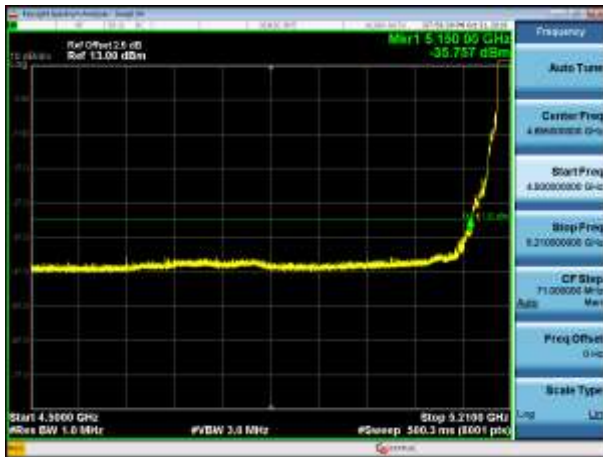

5200MHz with 2*2 CDD AV

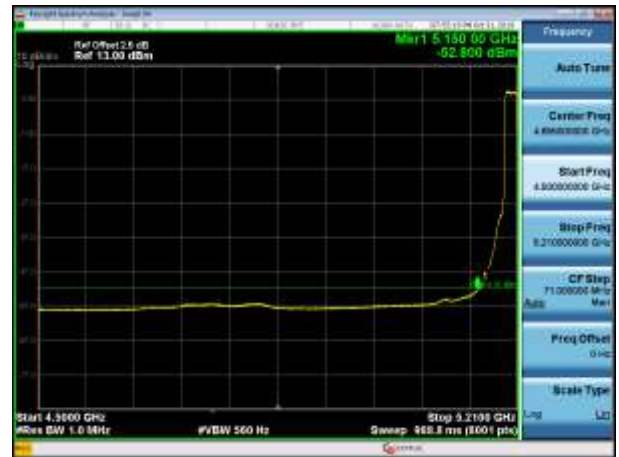

5320MHz with 2*2 CDD PK

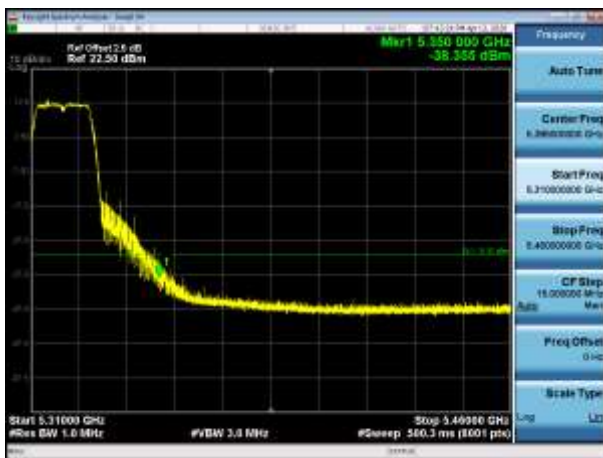

5320MHz with 2*2 CDD AV

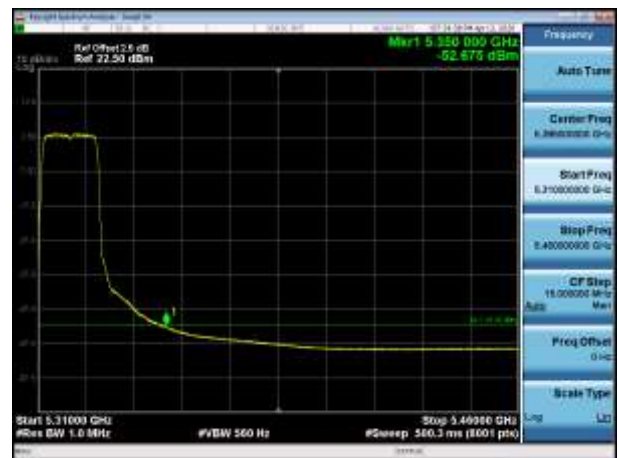

5180MHz with 2*2 Beamforming PK

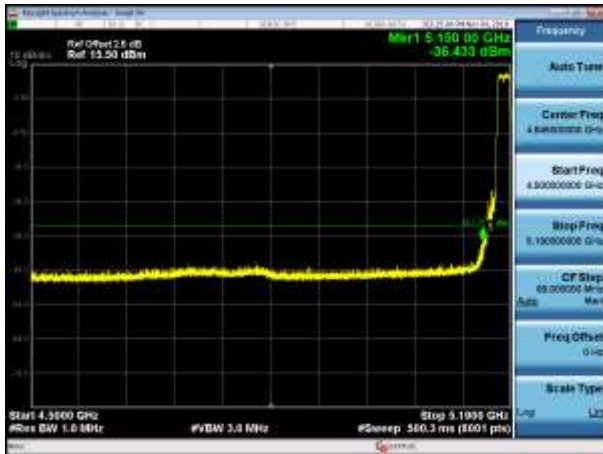

5180MHz with 2*2 Beamforming AV

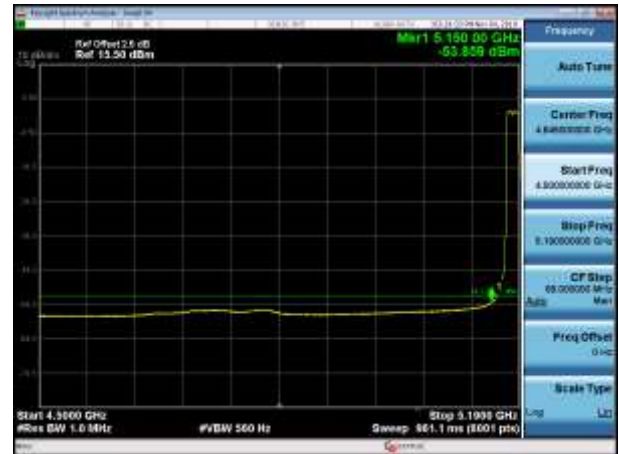

5200MHz with 2*2 Beamforming PK

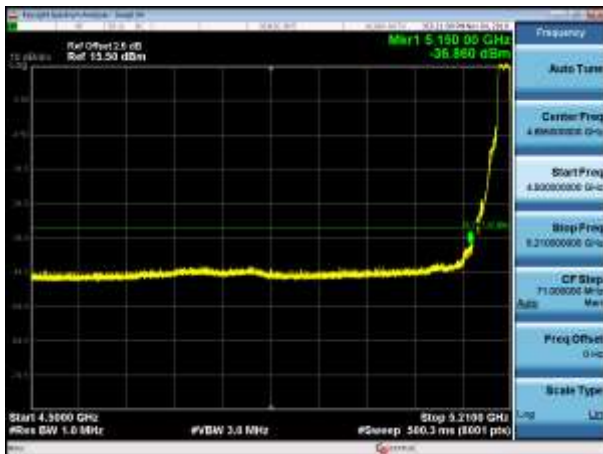

5200MHz with 2*2 Beamforming AV

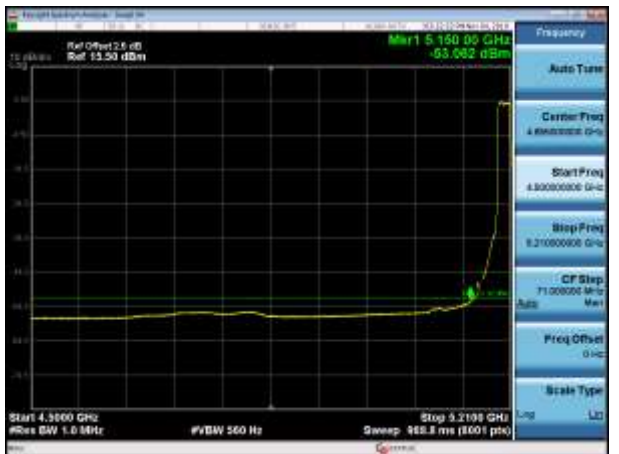

5320MHz with 2*2 Beamforming PK

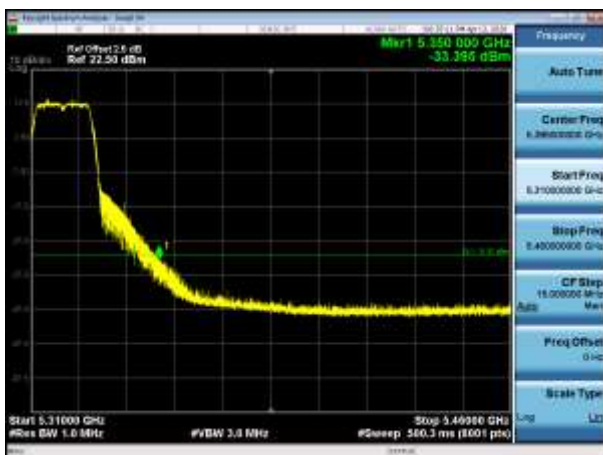

5320MHz with 2*2 Beamforming AV

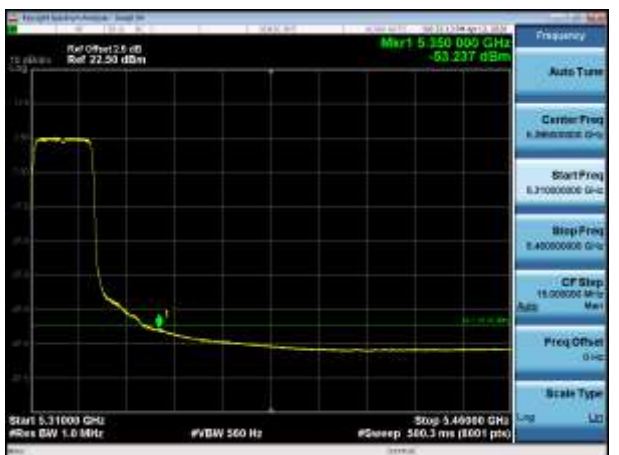

802.11n(40MHz)

5190MHz with 2*2 CDD PK

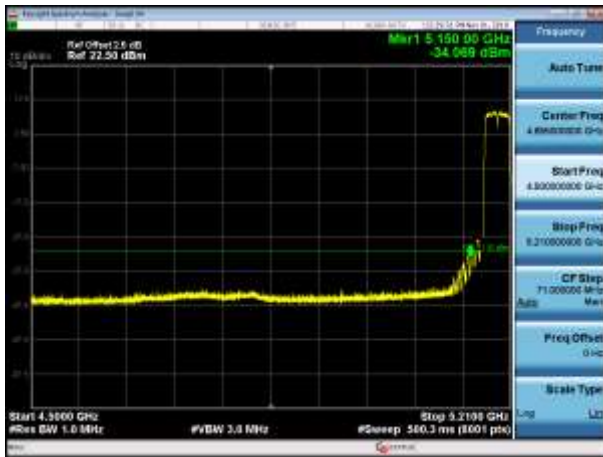

5190MHz with 2*2 CDD AV

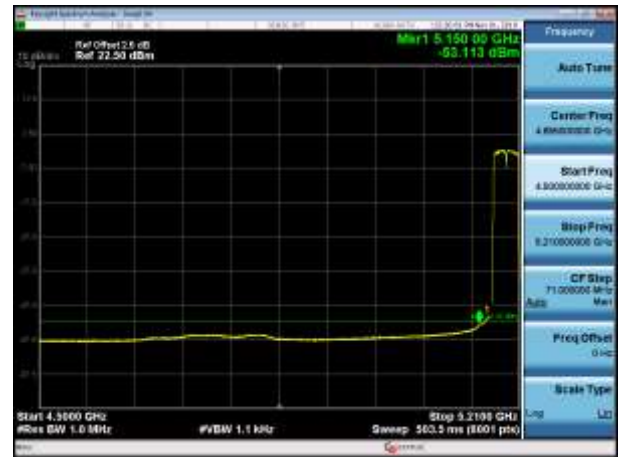

5230MHz with 2*2 CDD PK

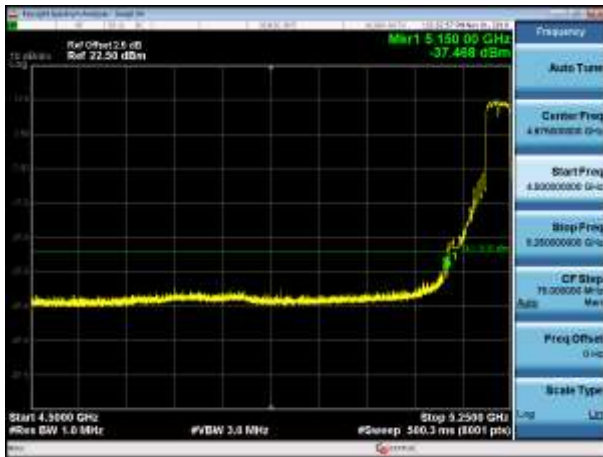

5230MHz with 2*2 CDD AV



5310MHz with 2*2 CDD PK

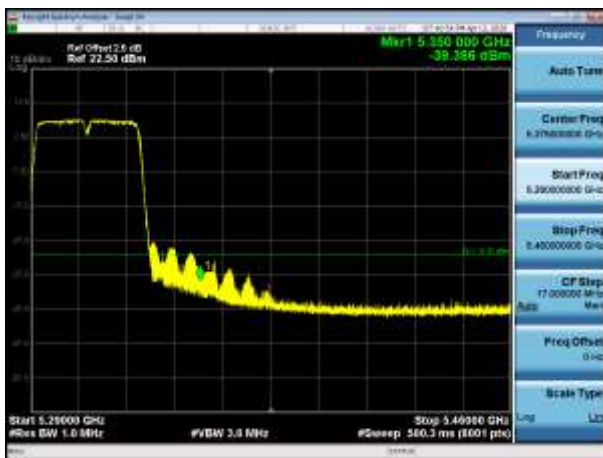

5310MHz with 2*2 CDD AV

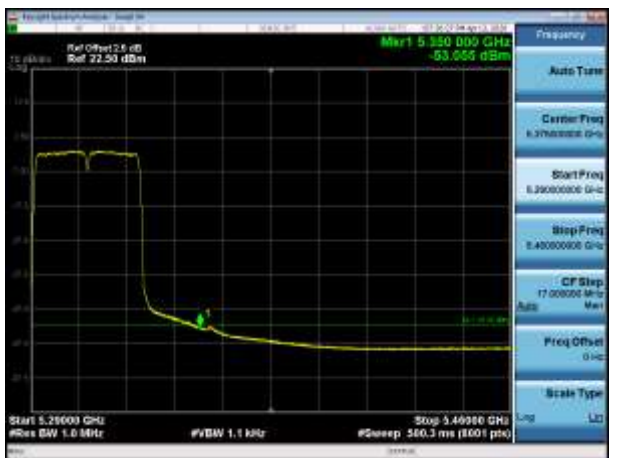

5190MHz with 2*2 Beamforming PK

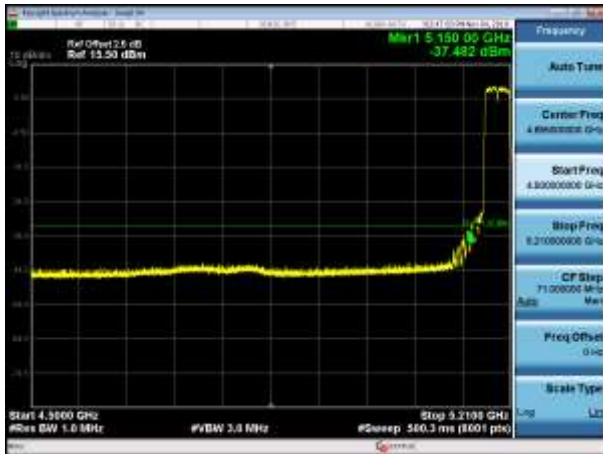

5190MHz with 2*2 Beamforming AV



5230MHz with 2*2 Beamforming PK

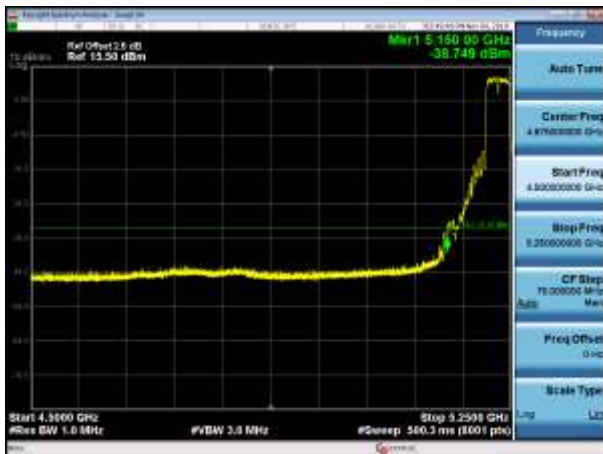

5230MHz with 2*2 Beamforming AV

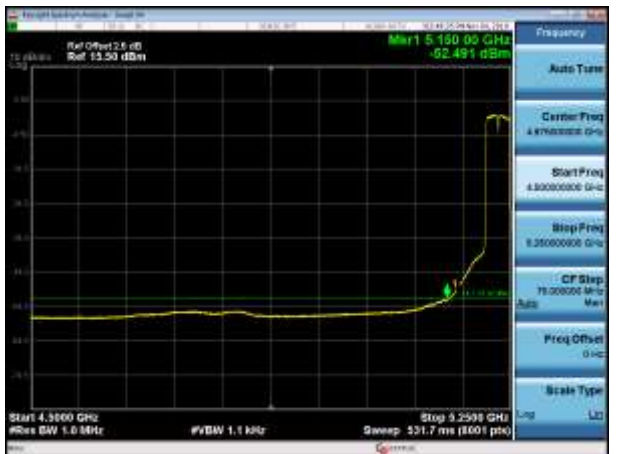

5310MHz with 2*2 Beamforming PK

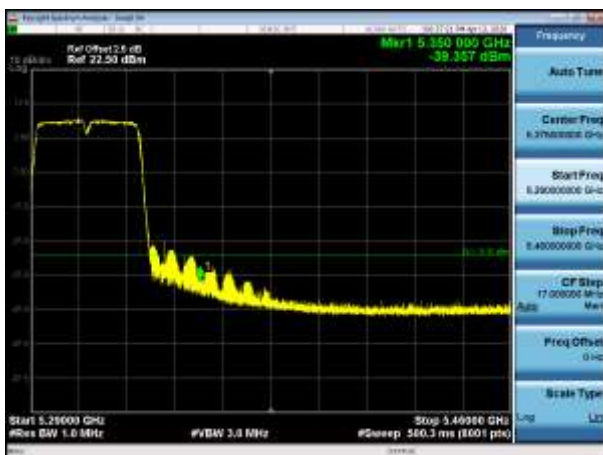

5310MHz with 2*2 Beamforming AV

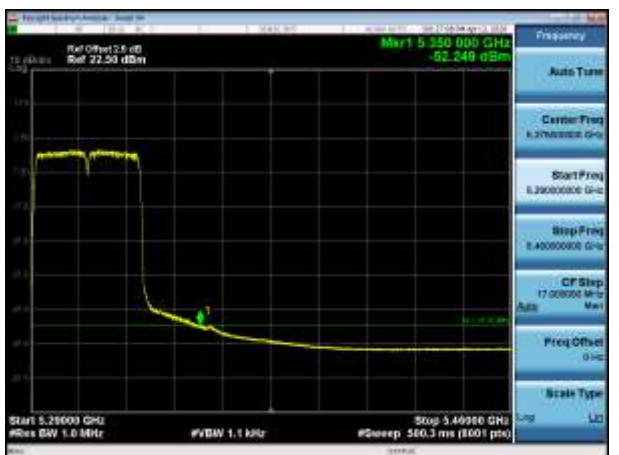

802.11ac(20MHz)

5180MHz with 2*2 CDD PK

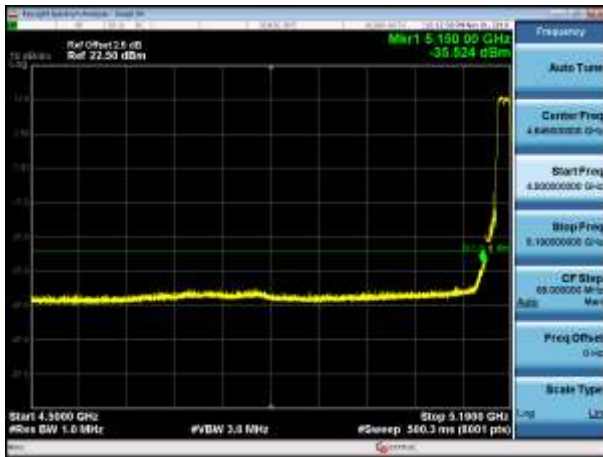

5180MHz with 2*2 CDD AV

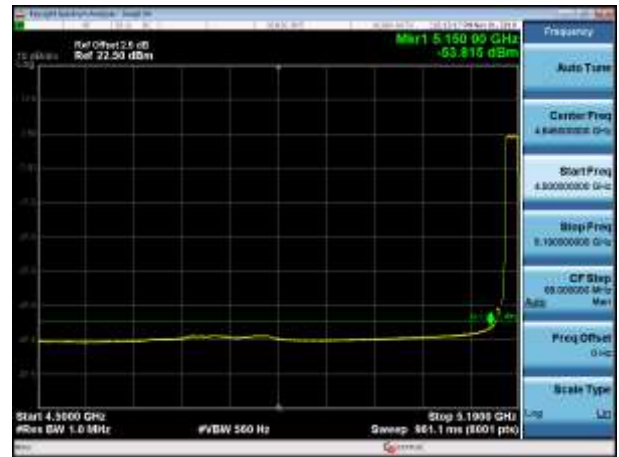

5200MHz with 2*2 CDD PK

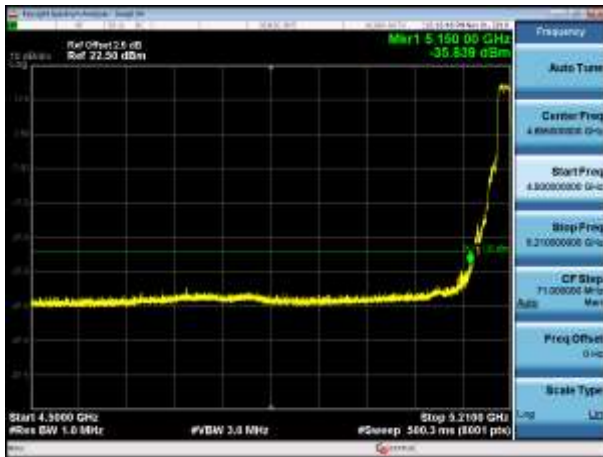

5200MHz with 2*2 CDD AV

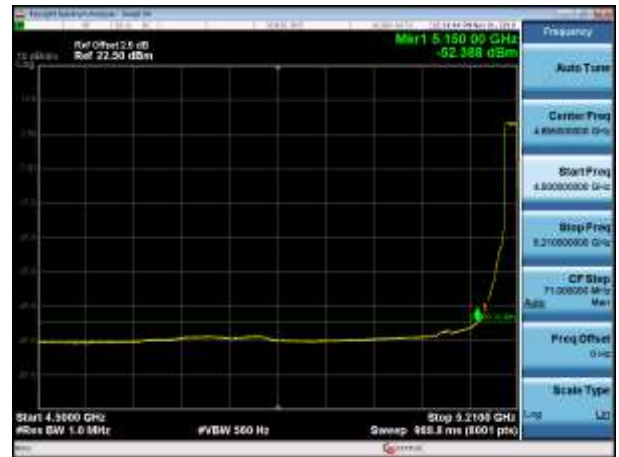

5320MHz with 2*2 CDD PK

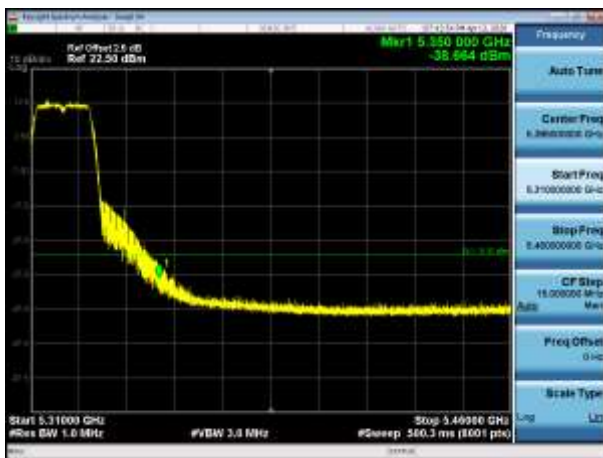

5320MHz with 2*2 CDD AV

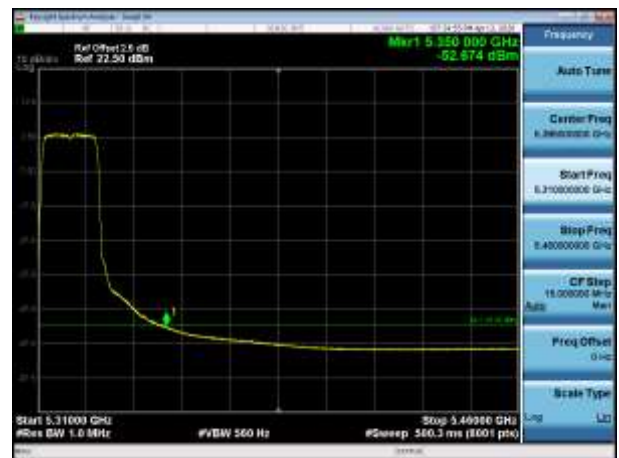

5180MHz with 2*2 Beamforming PK

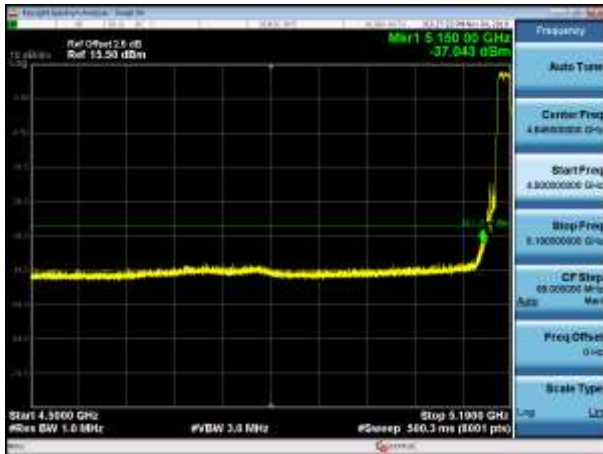

5180MHz with 2*2 Beamforming AV

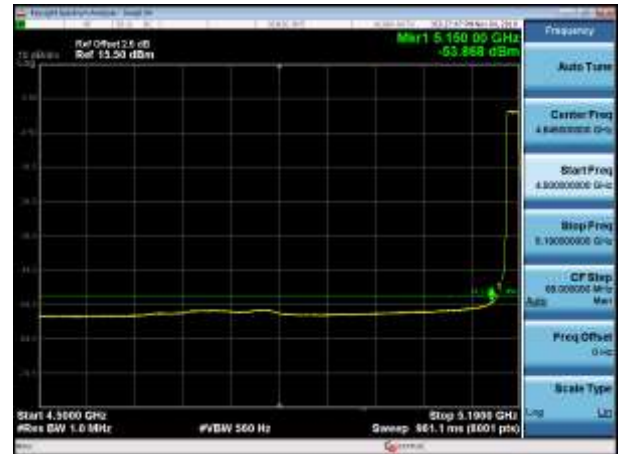

5200MHz with 2*2 Beamforming PK

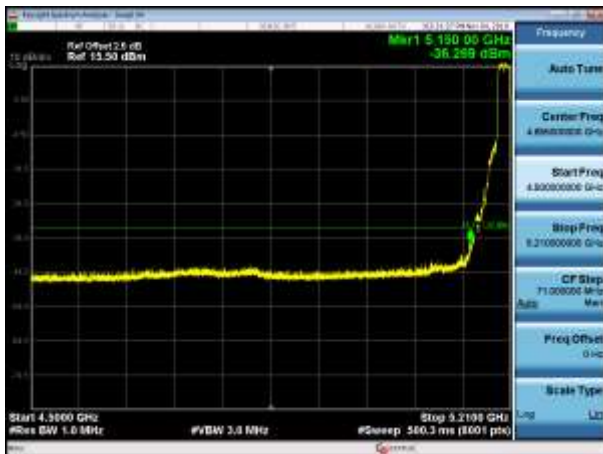

5200MHz with 2*2 Beamforming AV

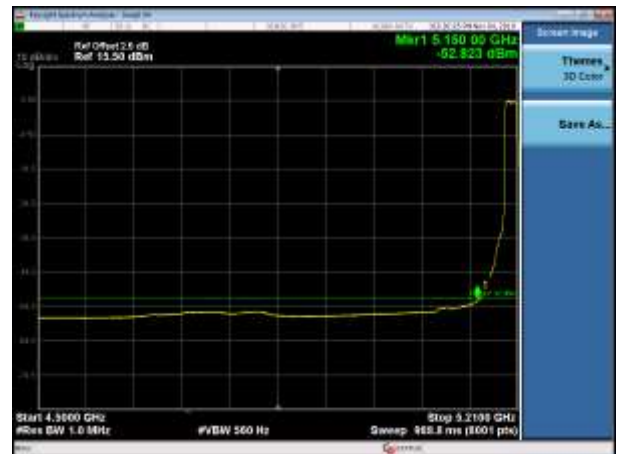

5320MHz with 2*2 Beamforming PK

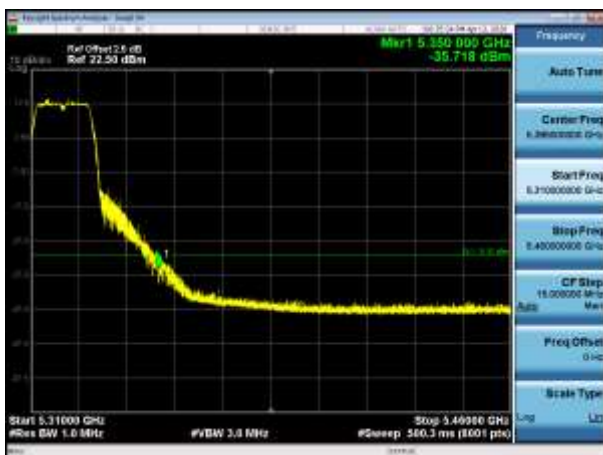

5320MHz with 2*2 Beamforming AV

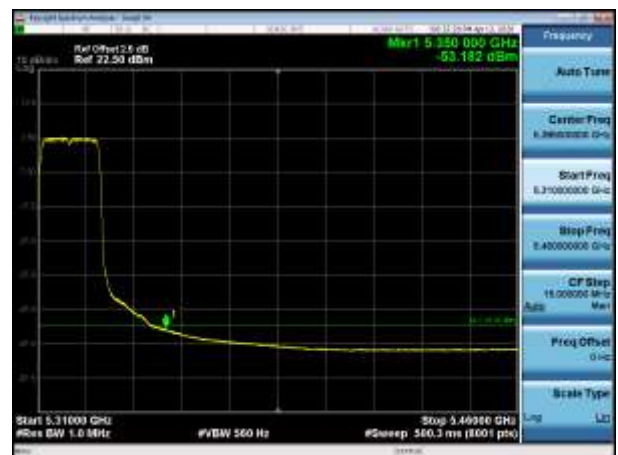

802.11ac(40MHz)

5190MHz with 2*2 CDD PK

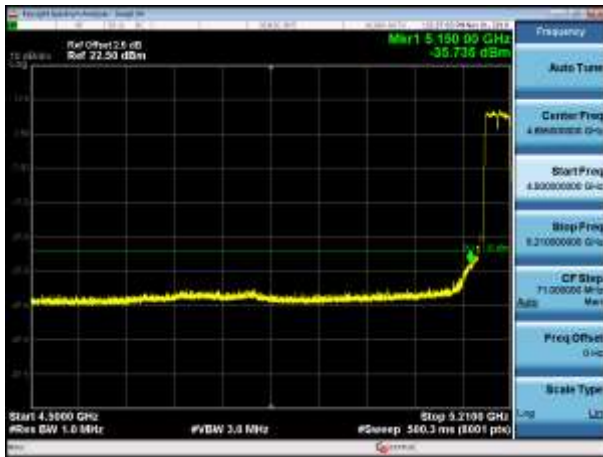

5190MHz with 2*2 CDD AV

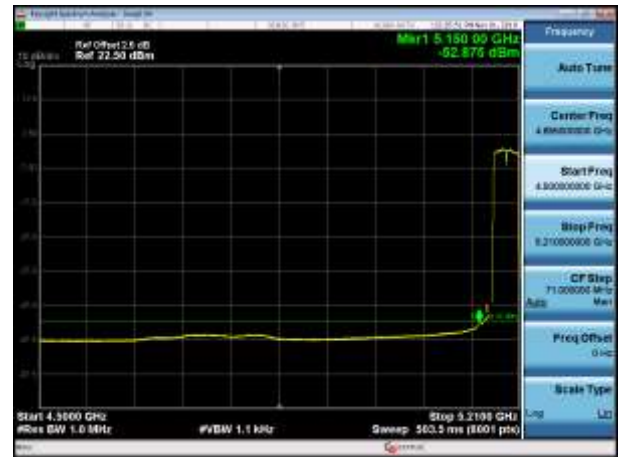

5230MHz with 2*2 CDD PK

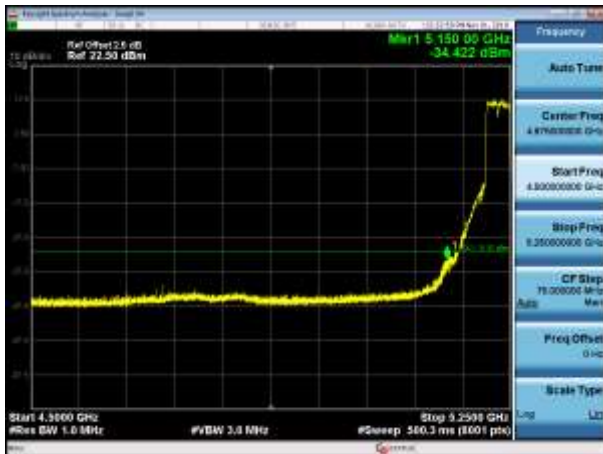

5230MHz with 2*2 CDD AV

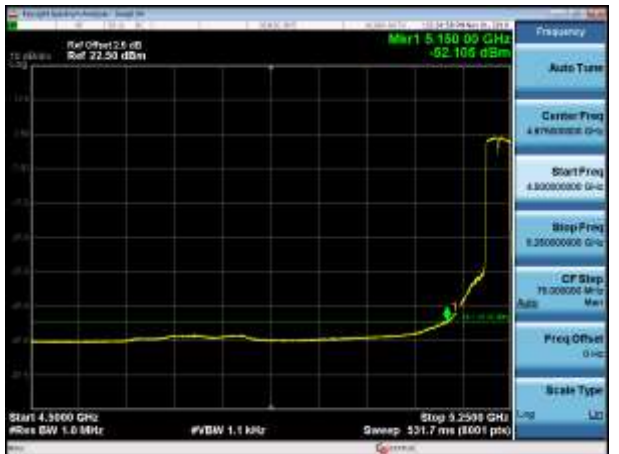

5310MHz with 2*2 CDD PK

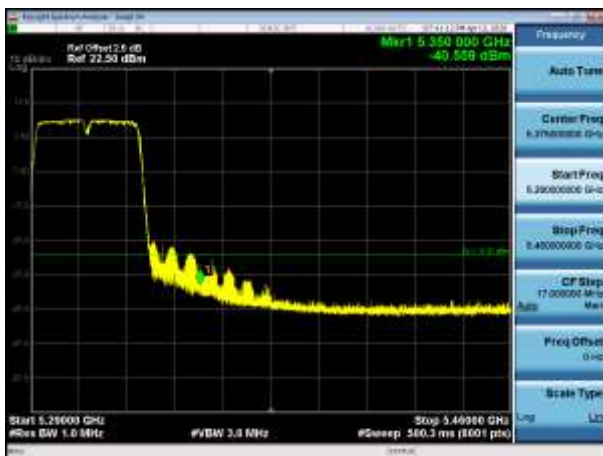

5310MHz with 2*2 CDD AV

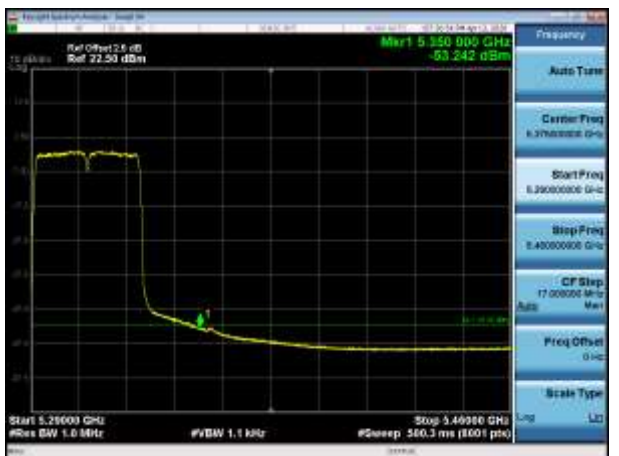

5190MHz with 2*2 Beamforming PK

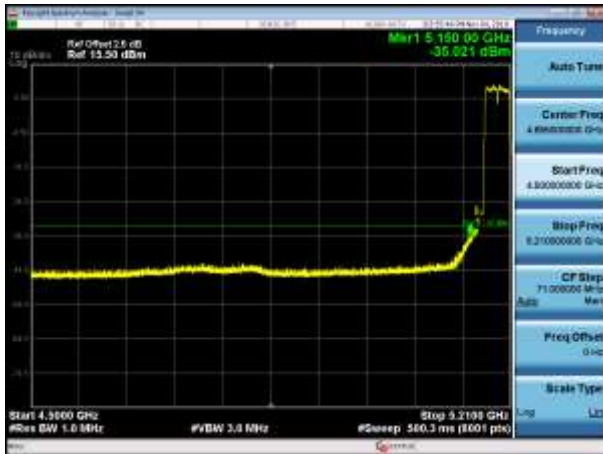

5190MHz with 2*2 Beamforming AV



5230MHz with 2*2 Beamforming PK

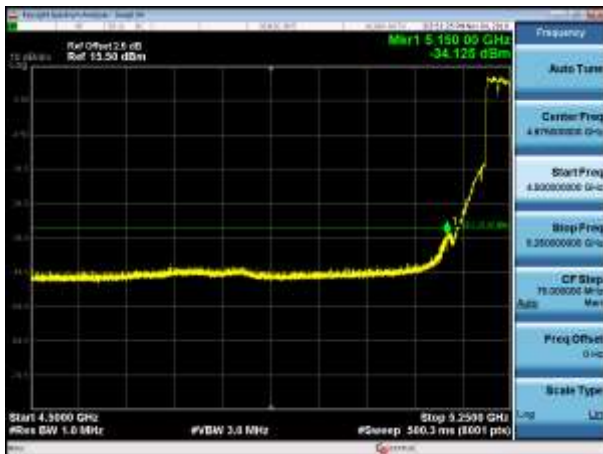

5230MHz with 2*2 Beamforming AV

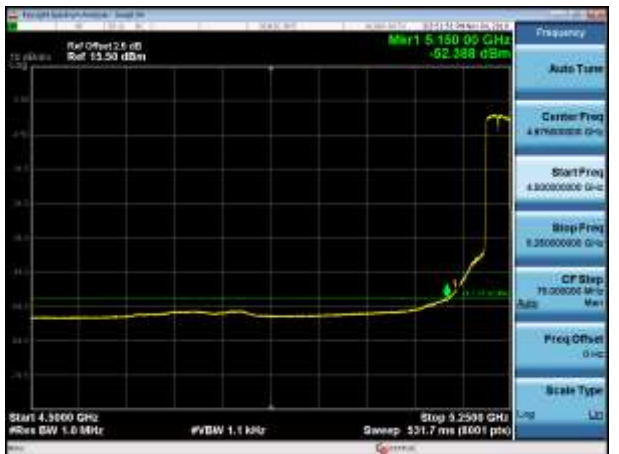

5310MHz with 2*2 Beamforming PK

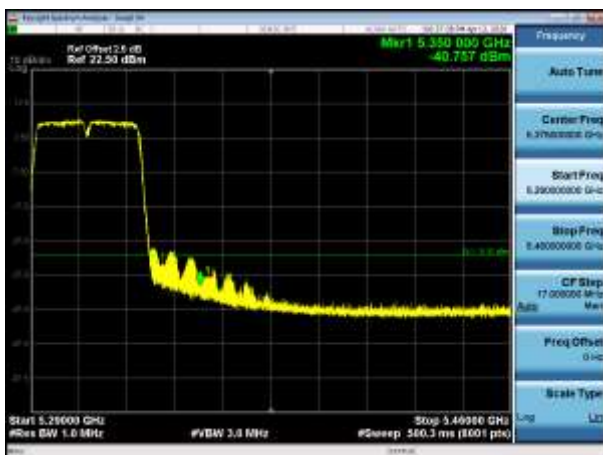

5310MHz with 2*2 Beamforming AV

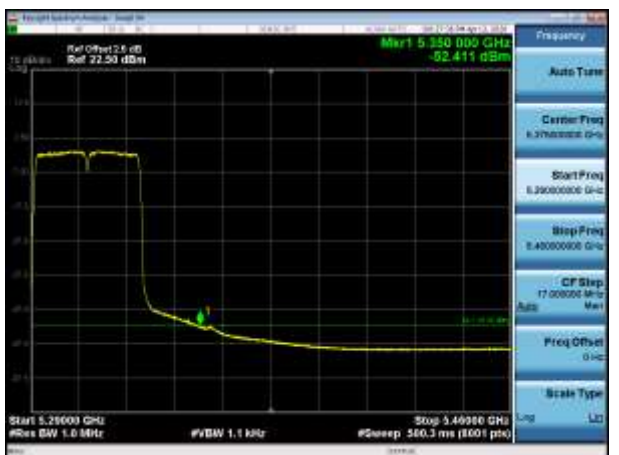

802.11ac(80MHz)

5210MHz with 2*2 CDD PK

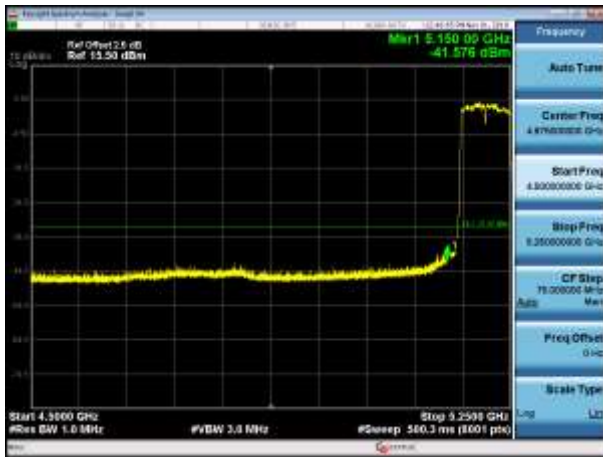

5210MHz with 2*2 CDD AV



5290MHz with 2*2 CDD PK

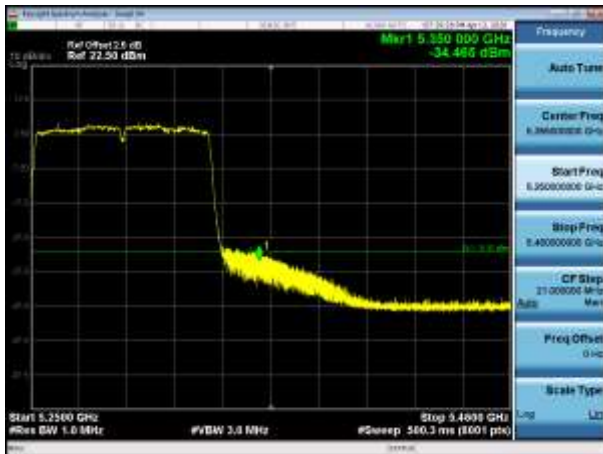

5290MHz with 2*2 CDD AV

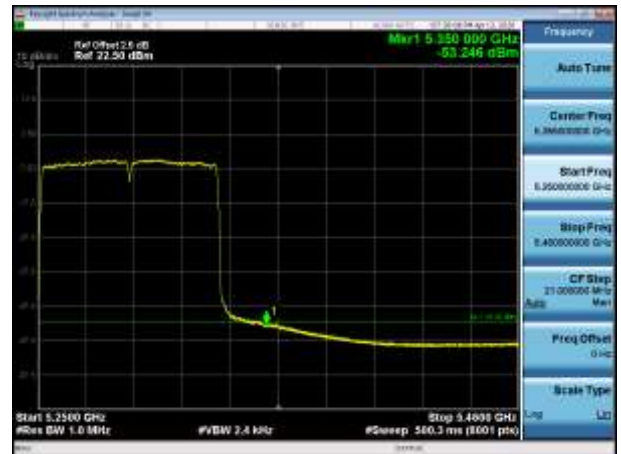

5210MHz with 2*2 Beamforming PK

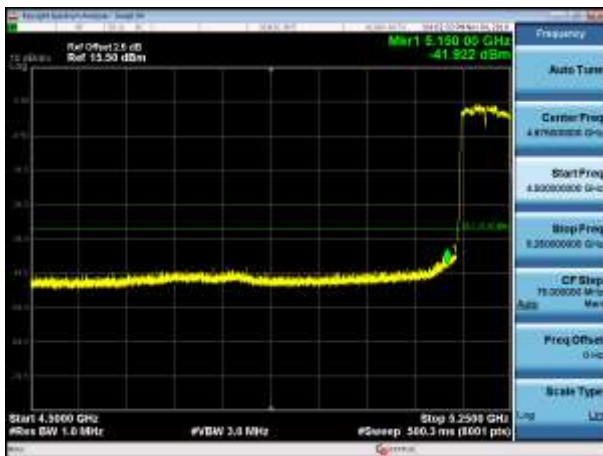

5210MHz with 2*2 Beamforming AV

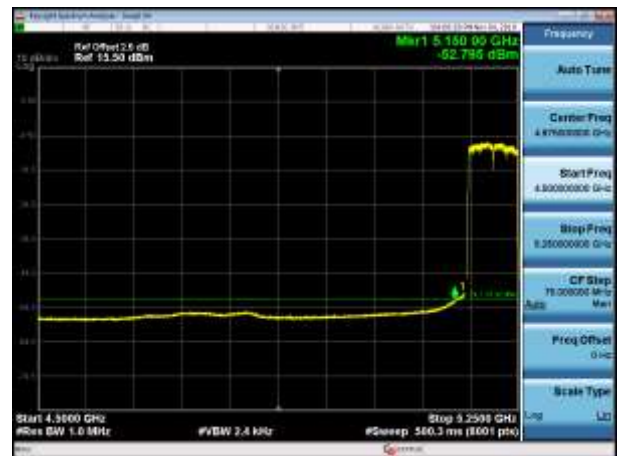

5290MHz with 2*2 Beamforming PK

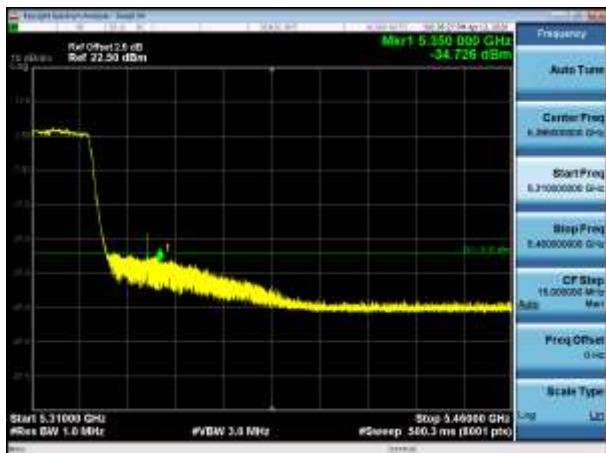

5290MHz with 2*2 Beamforming AV

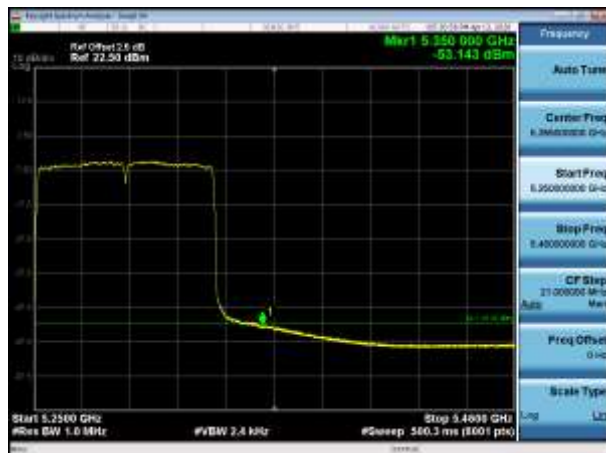

802.11ax(20MHz)

5180MHz with 2*2 CDD PK

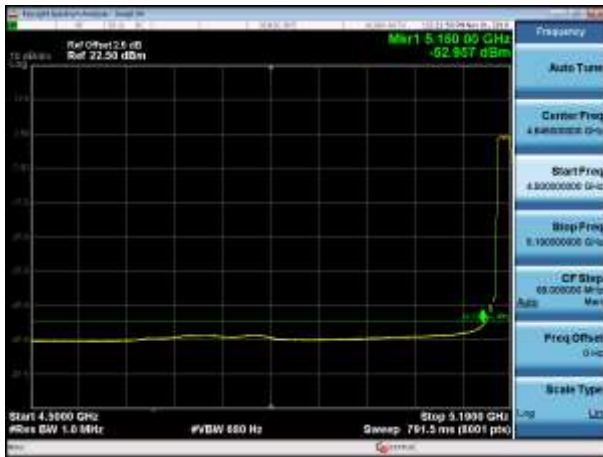

5180MHz with 2*2 CDD AV

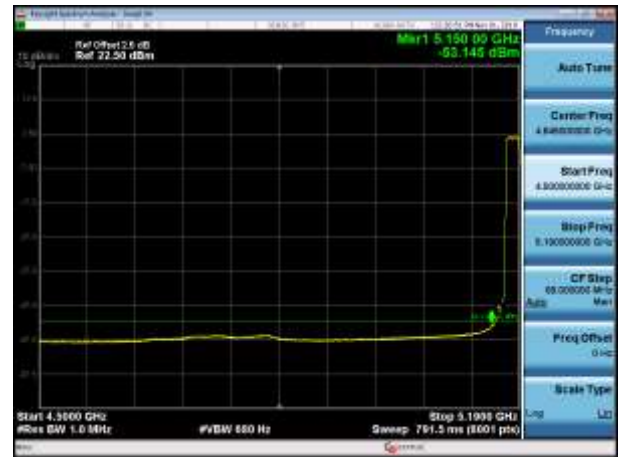

5200MHz with 2*2 CDD PK

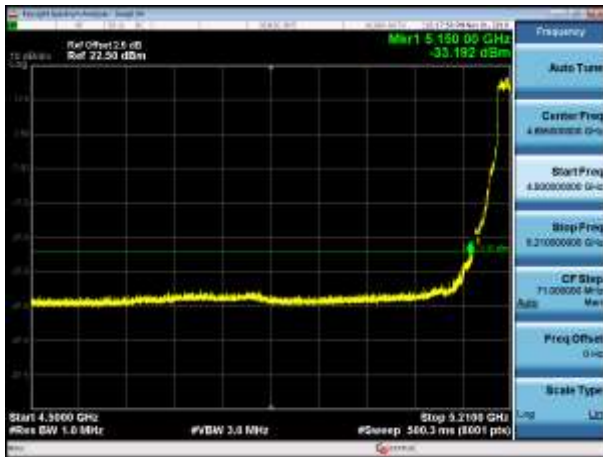

5200MHz with 2*2 CDD AV



5320MHz with 2*2 CDD PK

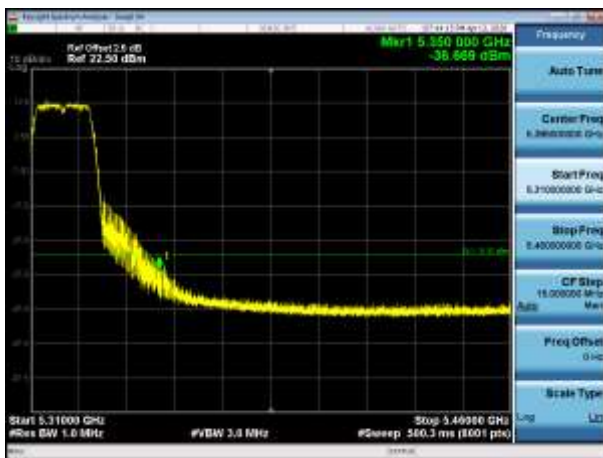

5320MHz with 2*2 CDD AV

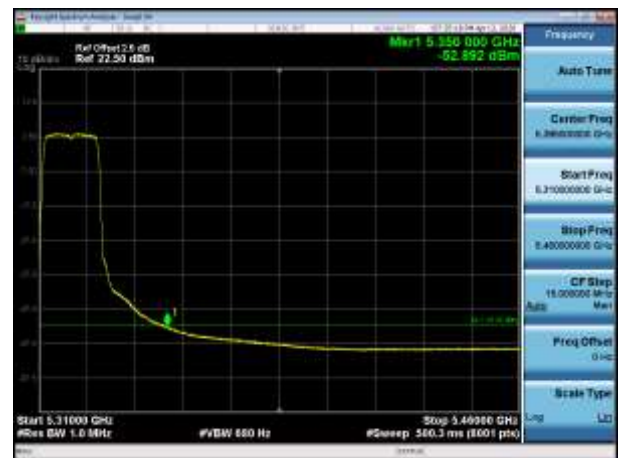

5180MHz with 2*2 Beamforming PK

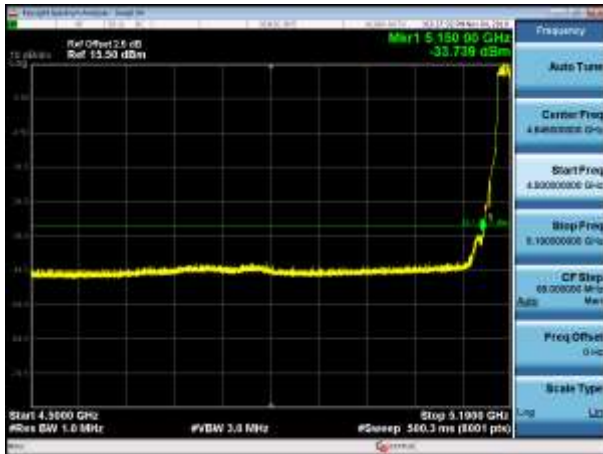

5180MHz with 2*2 Beamforming AV

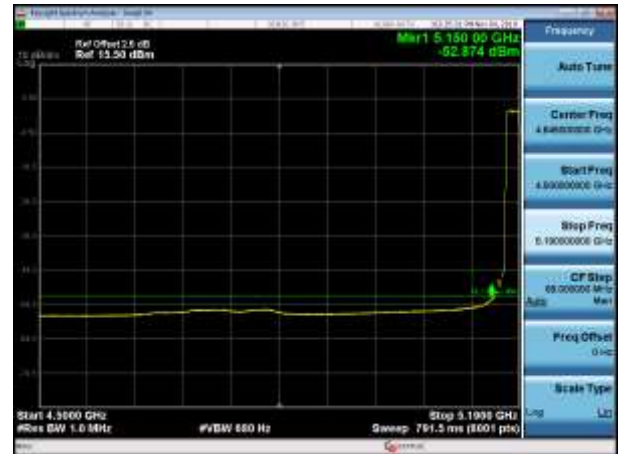

5200MHz with 2*2 Beamforming PK

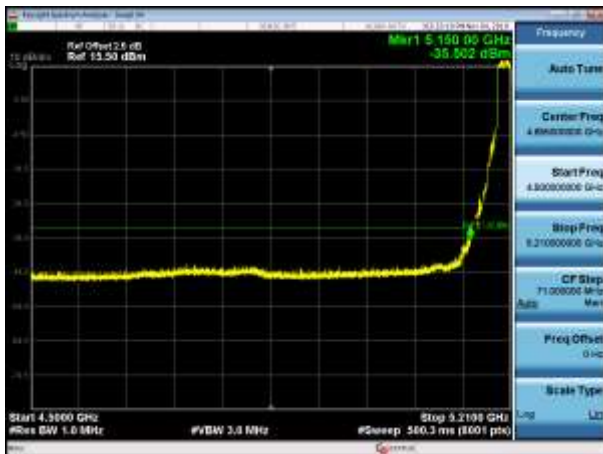

5200MHz with 2*2 Beamforming AV

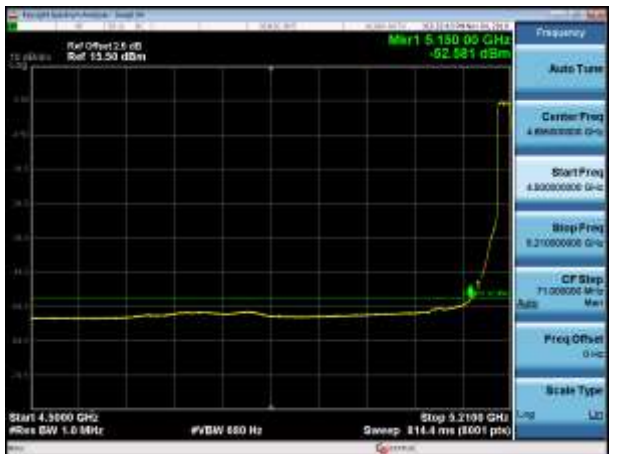

5320MHz with 2*2 Beamforming PK

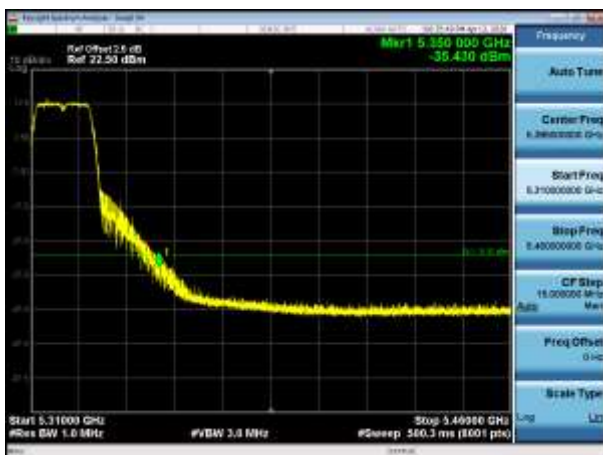

5320MHz with 2*2 Beamforming AV

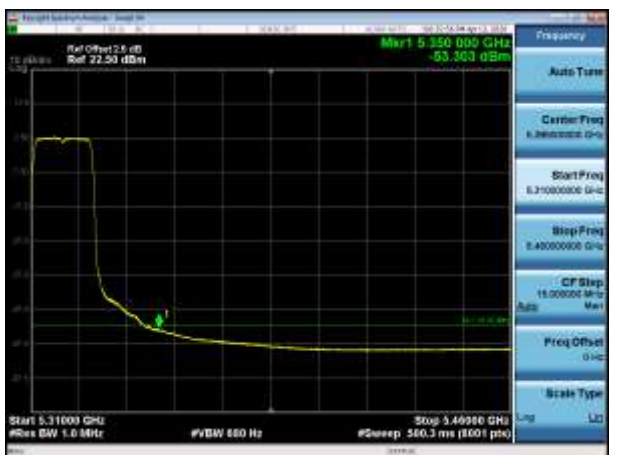

802.11ax(40MHz)

5190MHz with 2*2 CDD PK

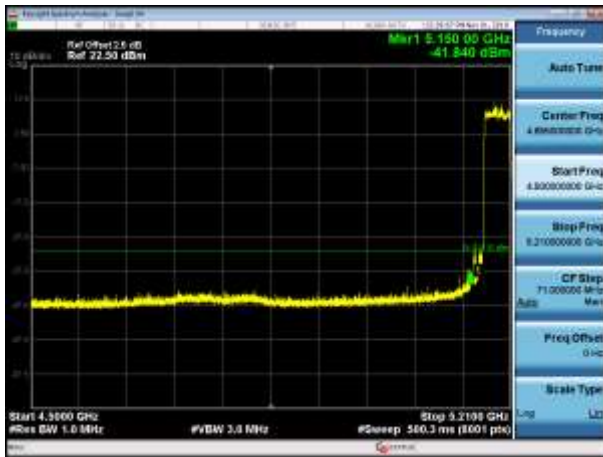

5190MHz with 2*2 CDD AV

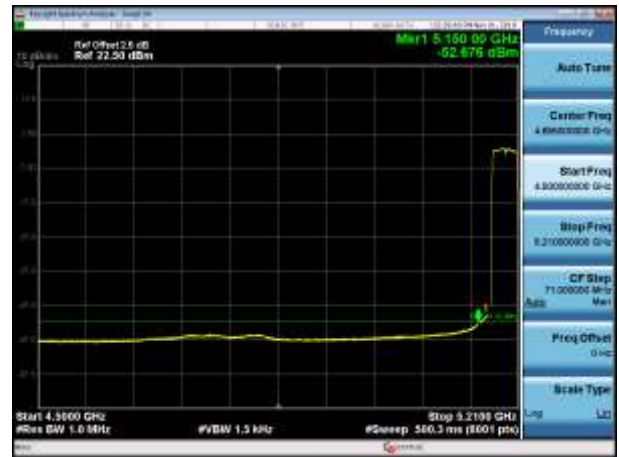

5230MHz with 2*2 CDD PK

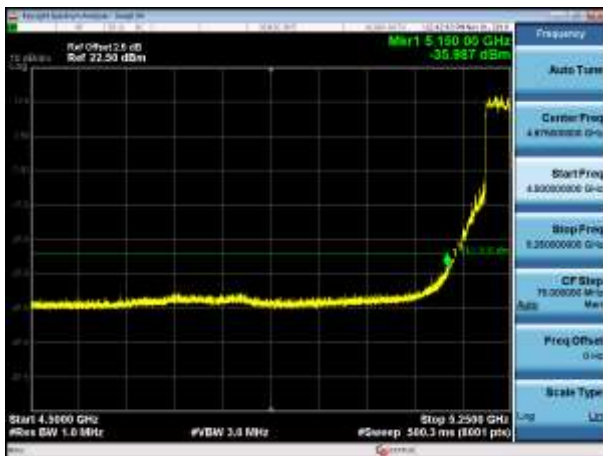

5230MHz with 2*2 CDD AV

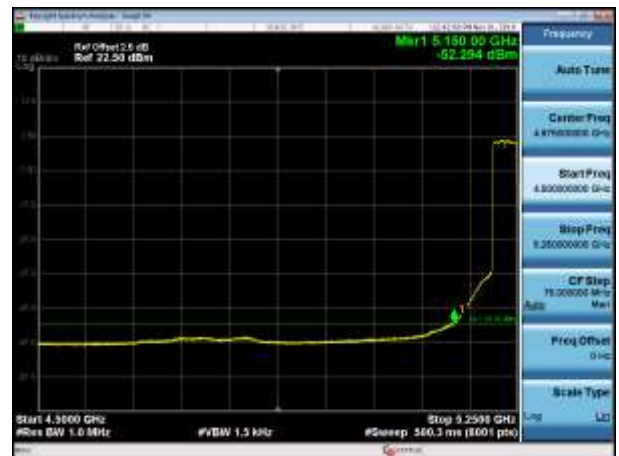

5310MHz with 2*2 CDD PK

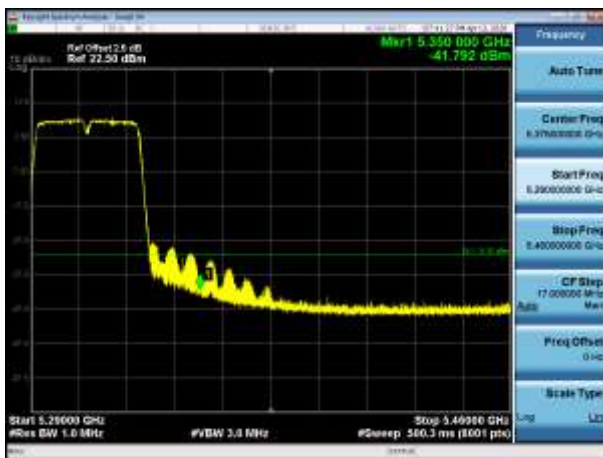

5310MHz with 2*2 CDD AV

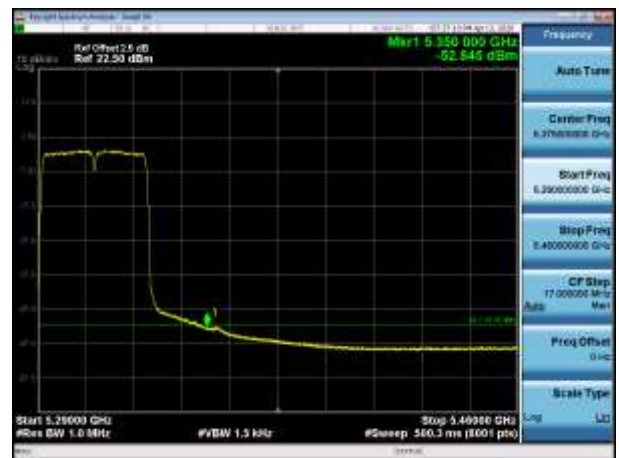

5190MHz with 2*2 Beamforming PK

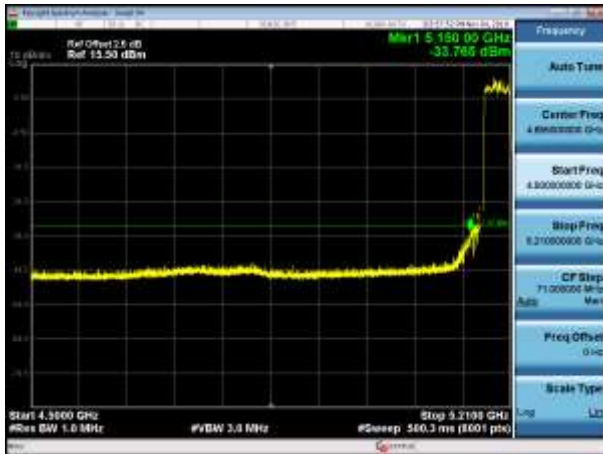

5190MHz with 2*2 Beamforming AV

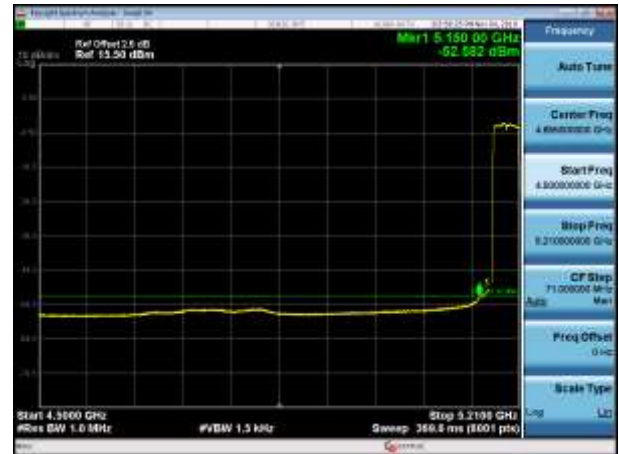

5230MHz with 2*2 Beamforming PK

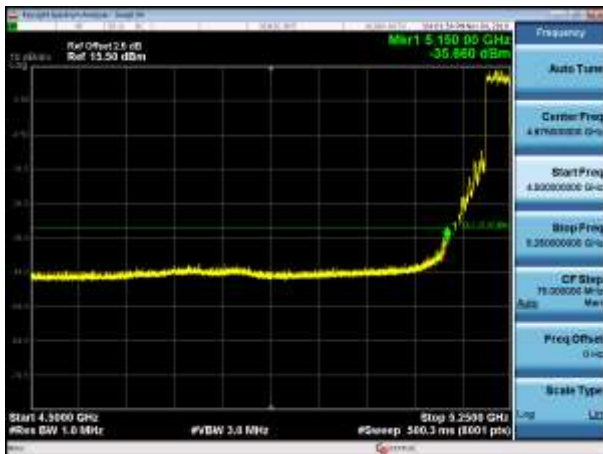

5230MHz with 2*2 Beamforming AV



5310MHz with 2*2 Beamforming PK

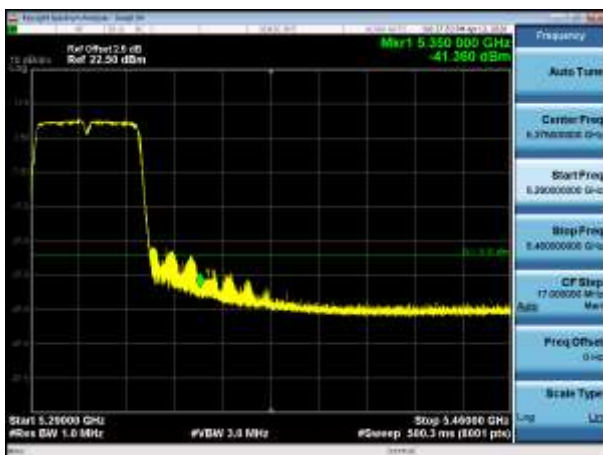

5310MHz with 2*2 Beamforming AV

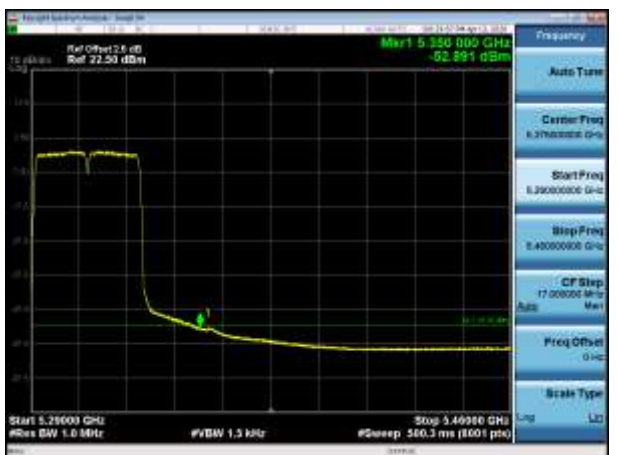

802.11ax(80MHz)

5210MHz with 2*2 CDD PK

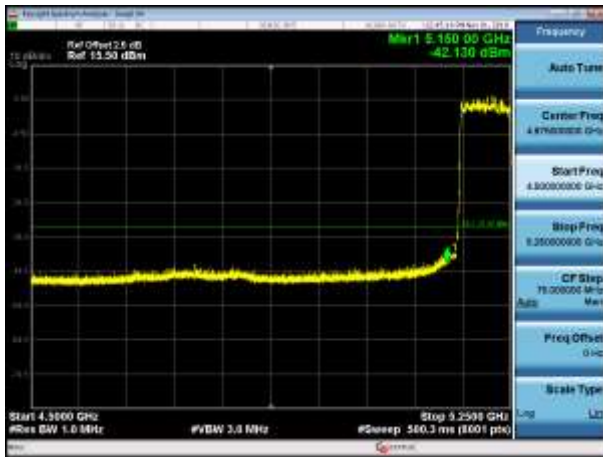

5210MHz with 2*2 CDD AV

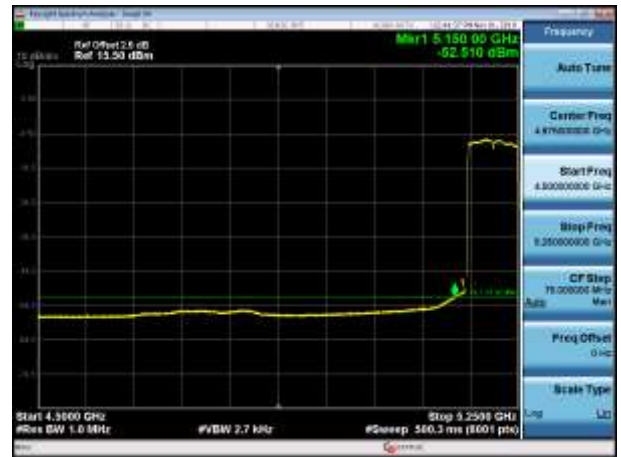

5290MHz with 2*2 CDD PK

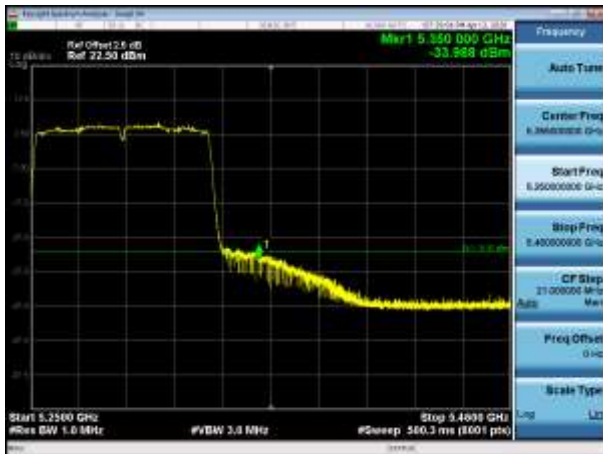

5290MHz with 2*2 CDD AV

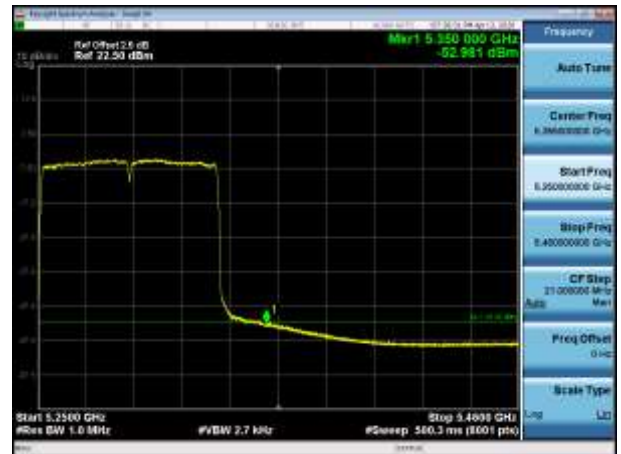

5210MHz with 2*2 Beamforming PK

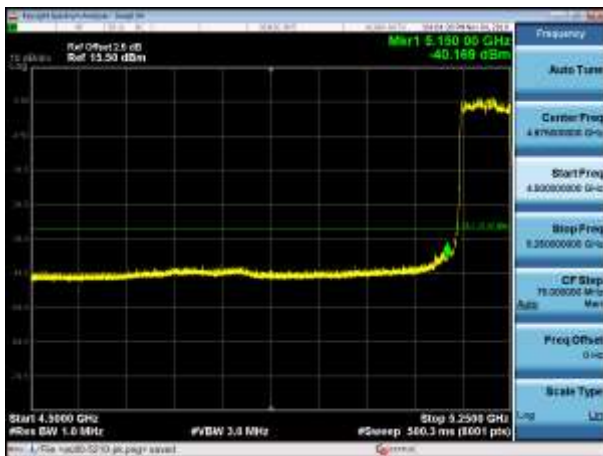

5210MHz with 2*2 Beamforming AV

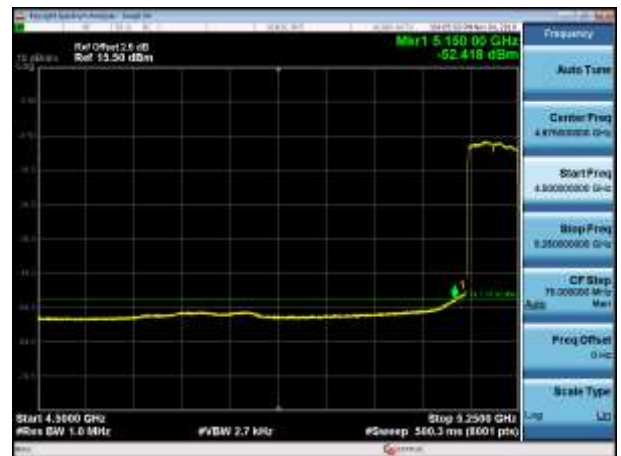

Radio 3:
802.11a

5180MHz with 4*4 CDD PK

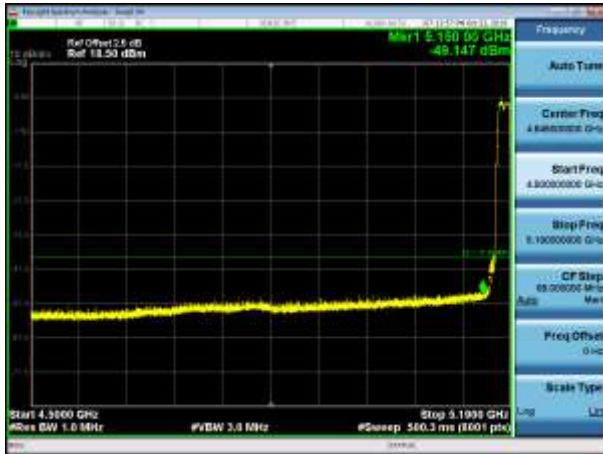

5180MHz with 4*4 CDD AV

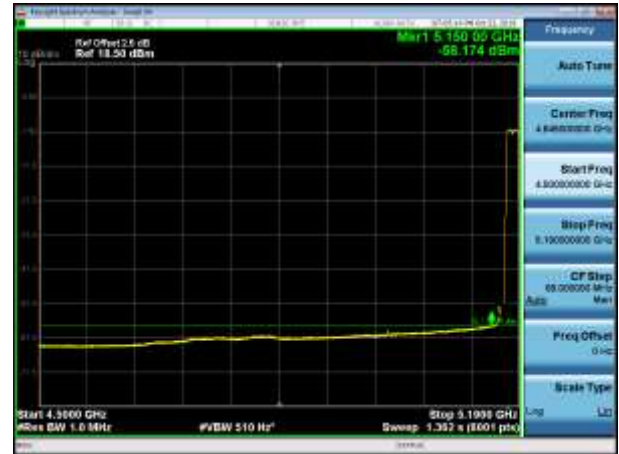

5200MHz with 4*4 CDD PK

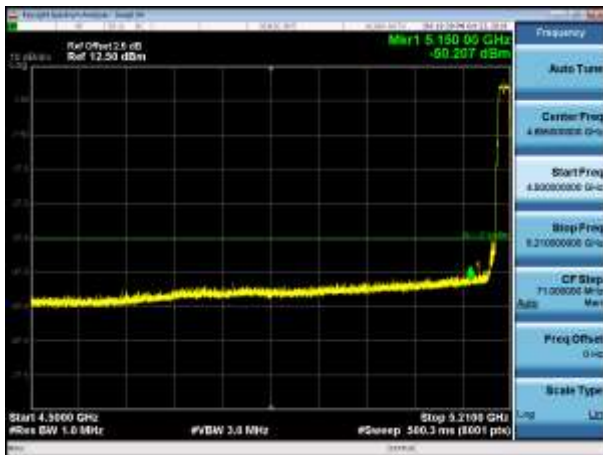

5200MHz with 4*4 CDD AV

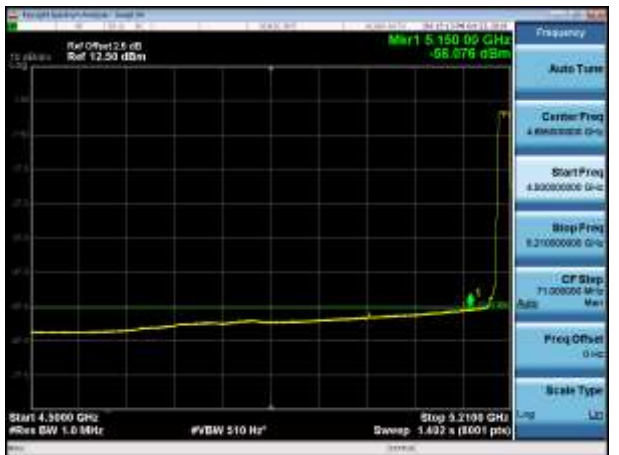

5320MHz with 4*4 CDD PK

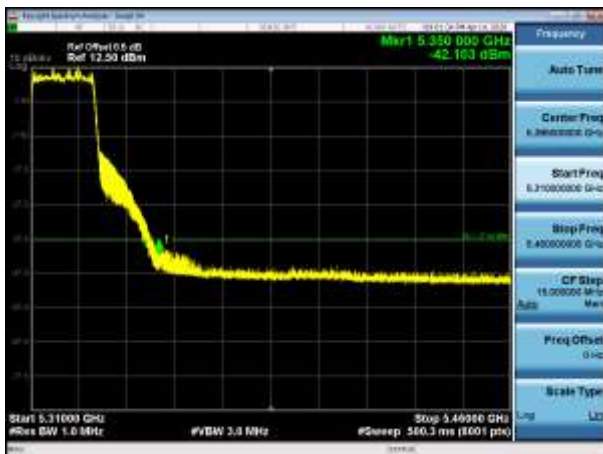

5320MHz with 4*4 CDD AV

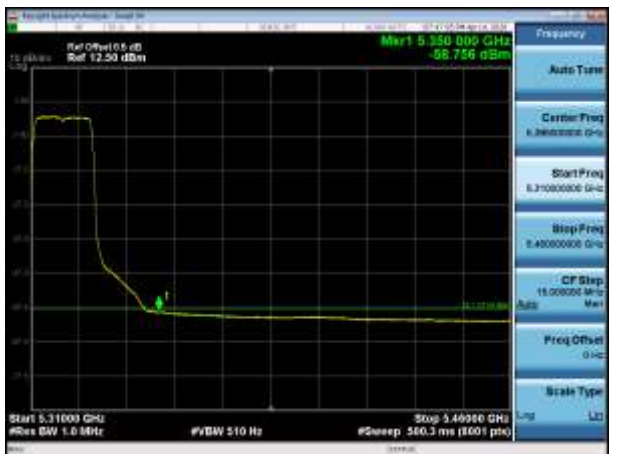

5500MHz with 4*4 CDD PK

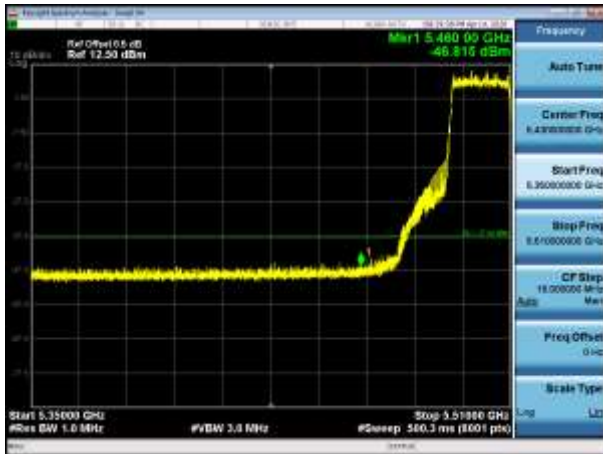

5500MHz with 4*4 CDD AV



5745MHz with 4*4 CDD PK

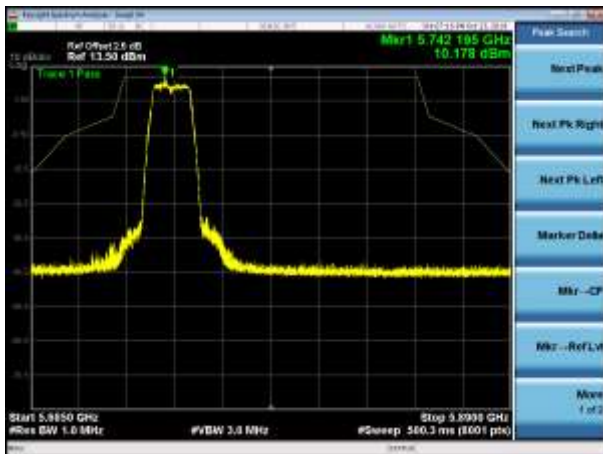

5825MHz with 4*4 CDD PK

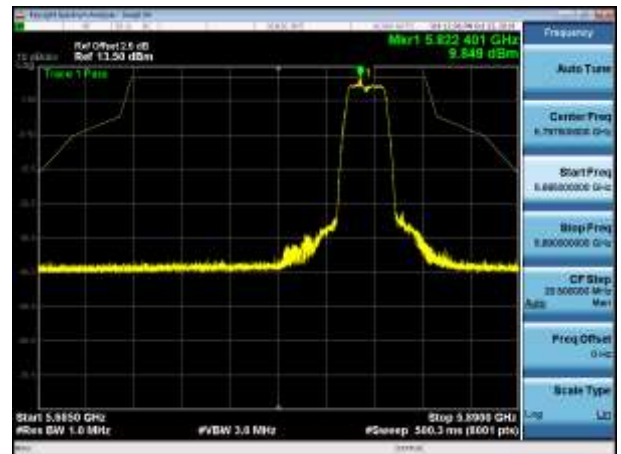

802.11n(20MHz)

5180MHz with 4*4 CDD PK

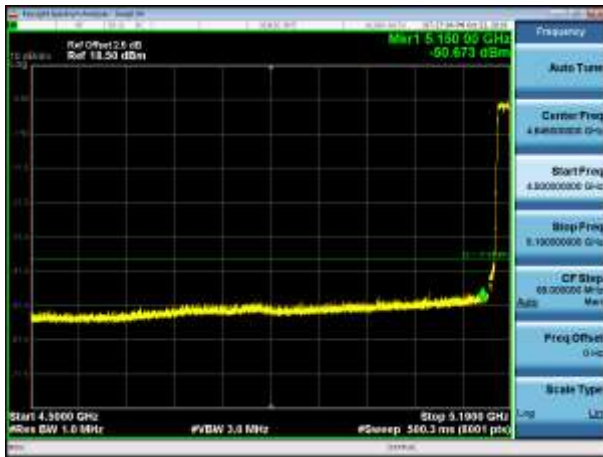

5180MHz with 4*4 CDD AV

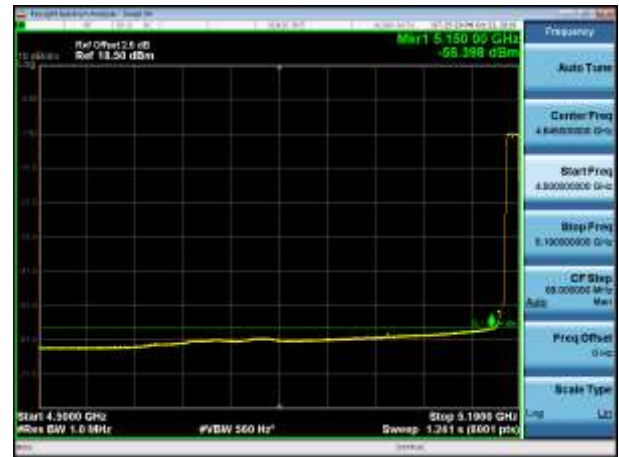

5200MHz with 4*4 CDD PK

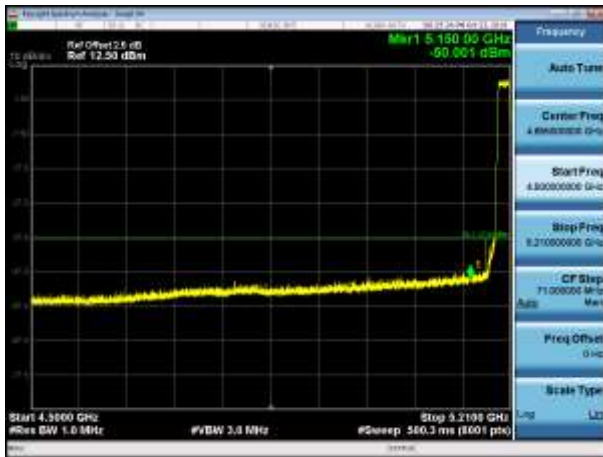

5200MHz with 4*4 CDD AV



5320MHz with 4*4 CDD PK

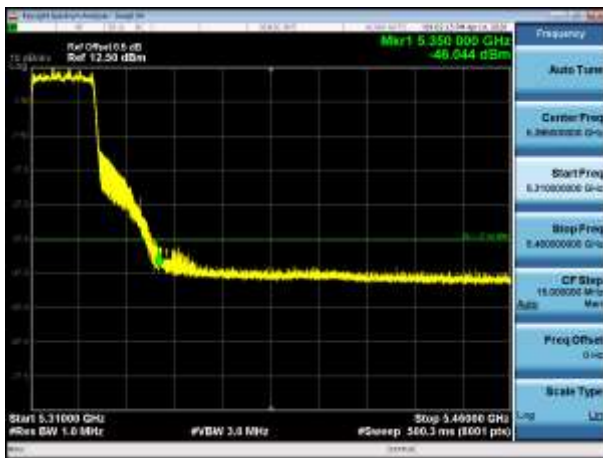

5320MHz with 4*4 CDD AV

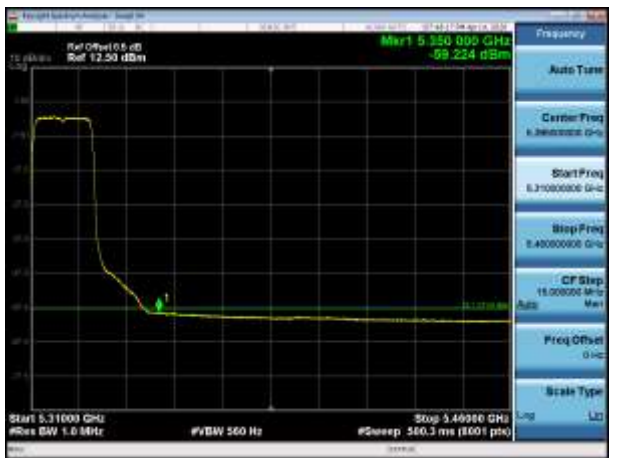

5500MHz with 4*4 CDD PK

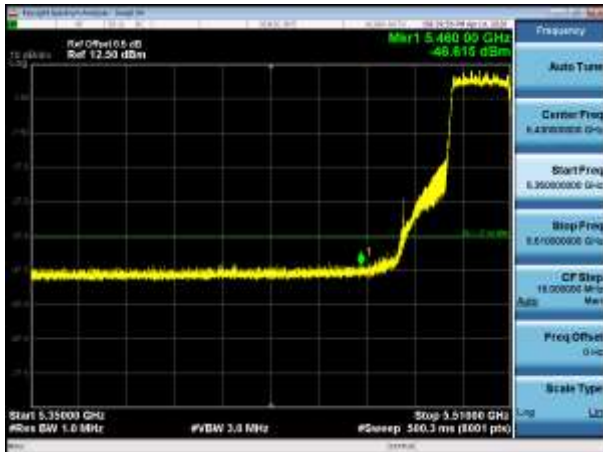

5500MHz with 4*4 CDD AV

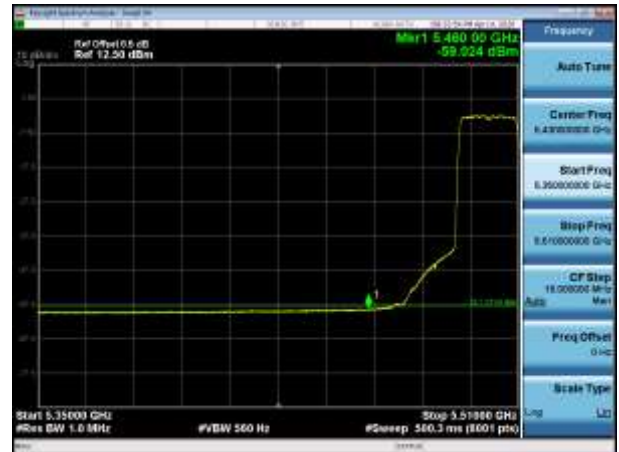

5745MHz with 4*4 CDD PK

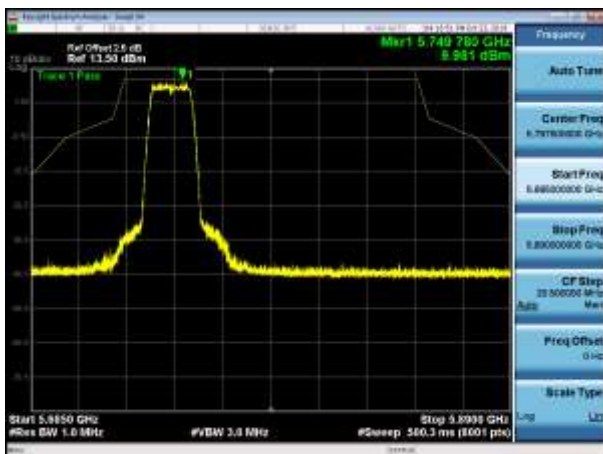

5825MHz with 4*4 CDD PK

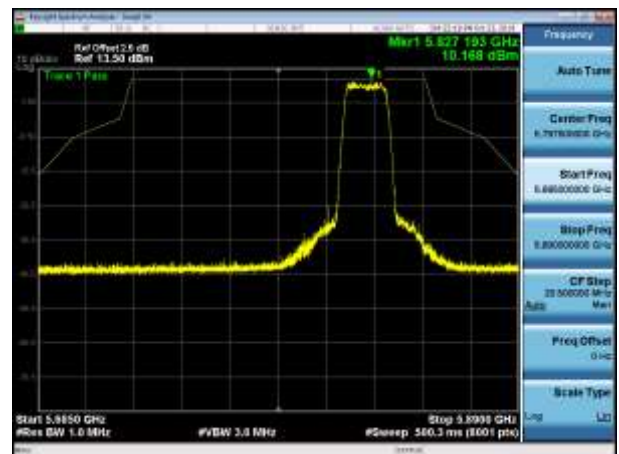

5180MHz with 4*4 Beamforming PK

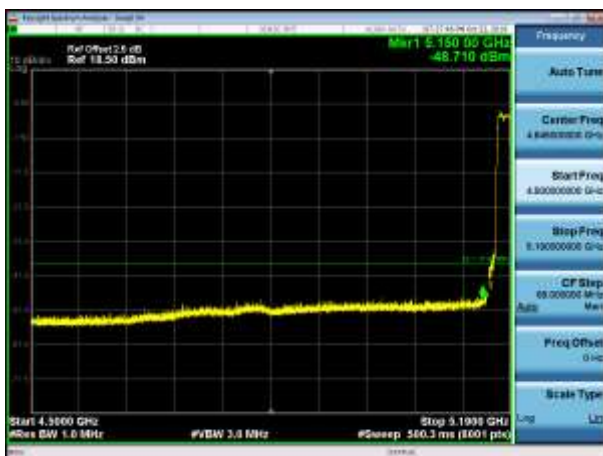

5180MHz with 4*4 Beamforming AV

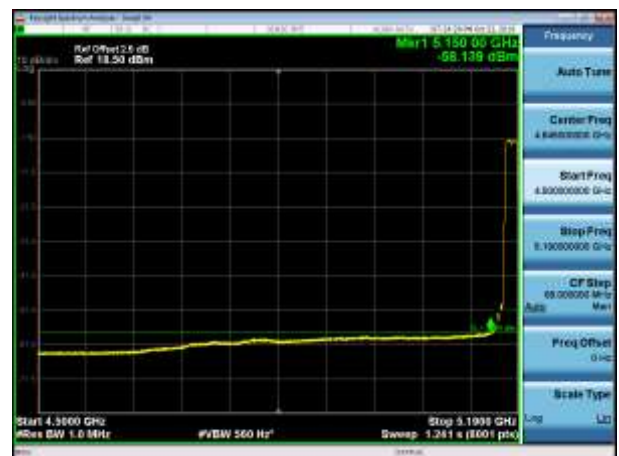

5200MHz with 4*4 Beamforming PK

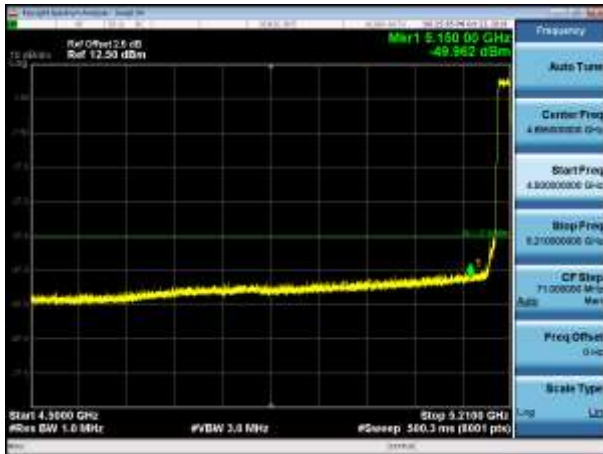

5200MHz with 4*4 Beamforming AV

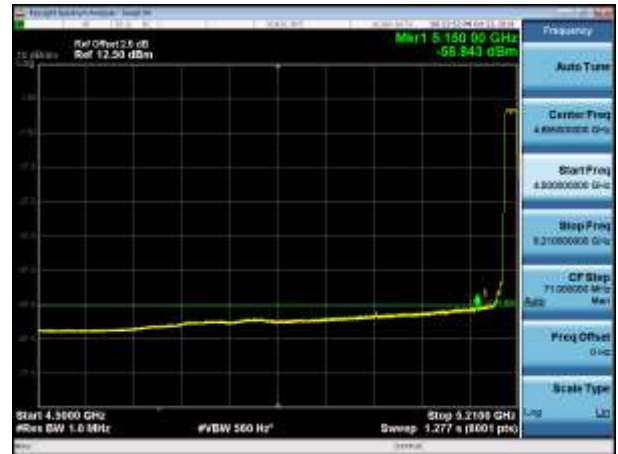

5320MHz with 4*4 Beamforming PK

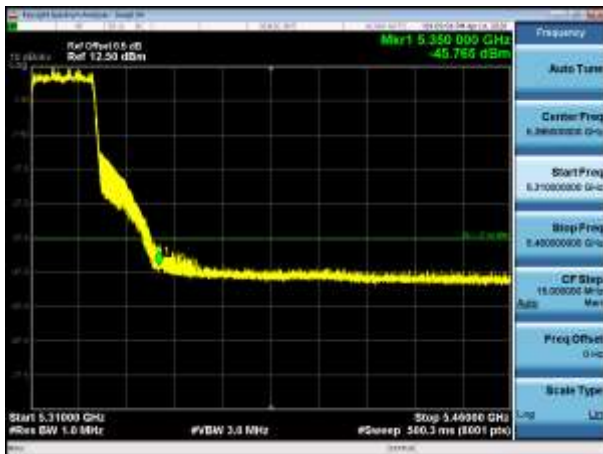

5320MHz with 4*4 Beamforming AV

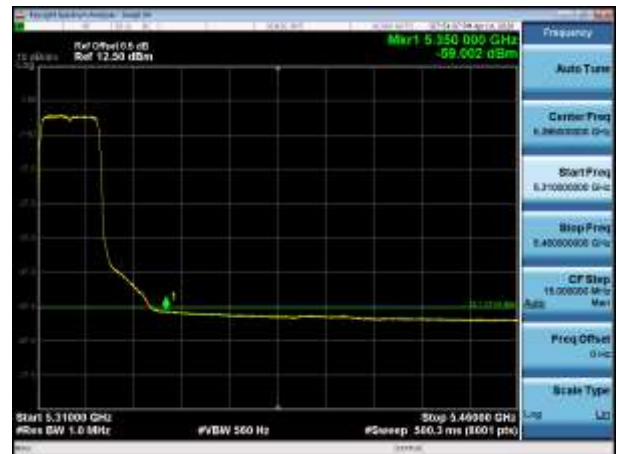

5500MHz with 4*4 Beamforming PK

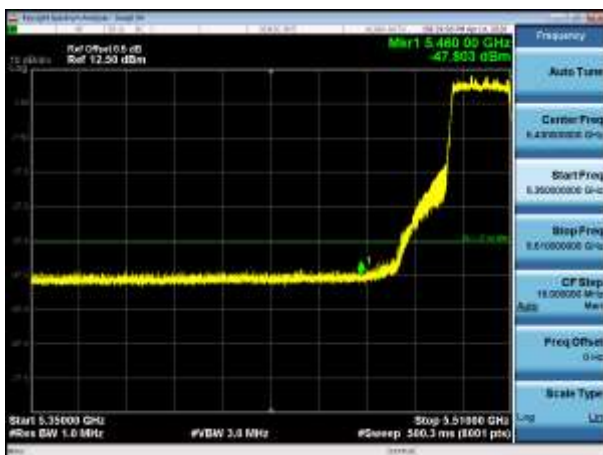

5500MHz with 4*4 Beamforming AV

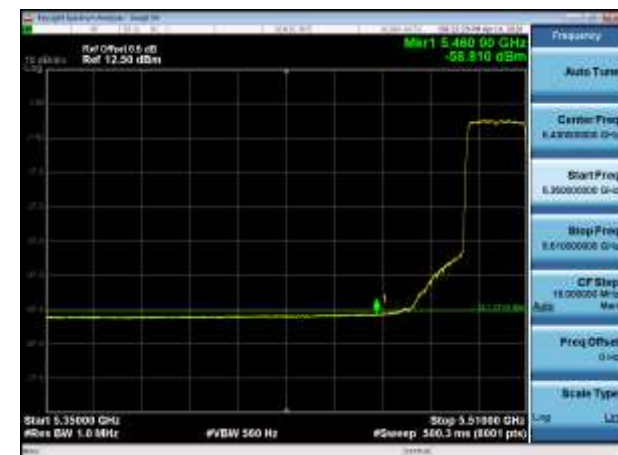

5745MHz with 4*4 Beamforming PK

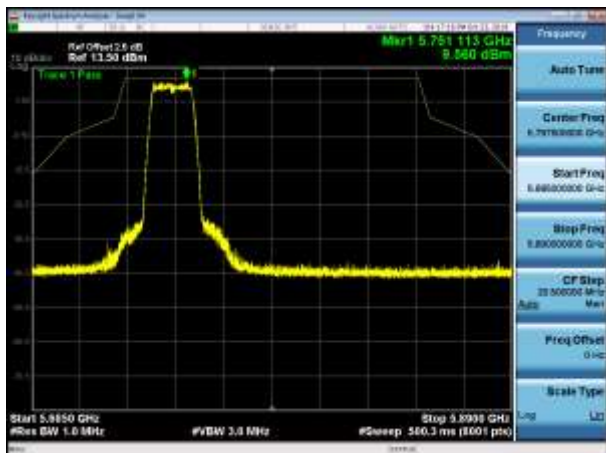

5825MHz with 4*4 Beamforming PK

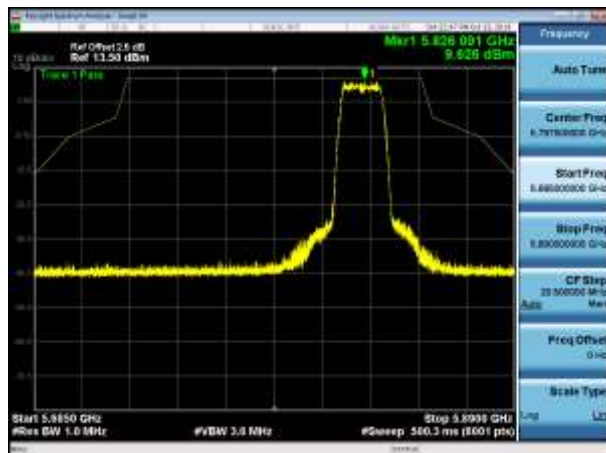

802.11n(40MHz)

5190MHz with 4*4 CDD PK

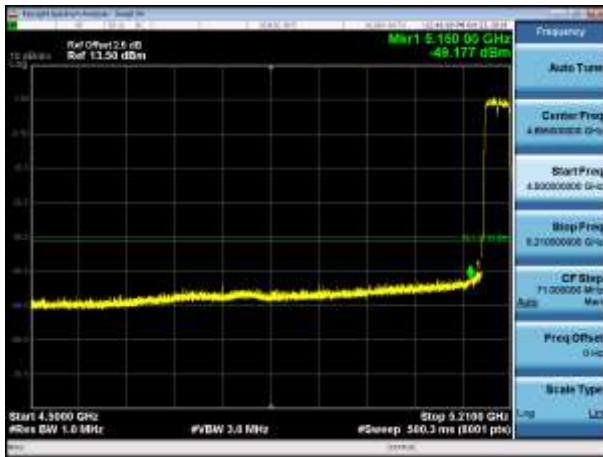

5190MHz with 4*4 CDD AV

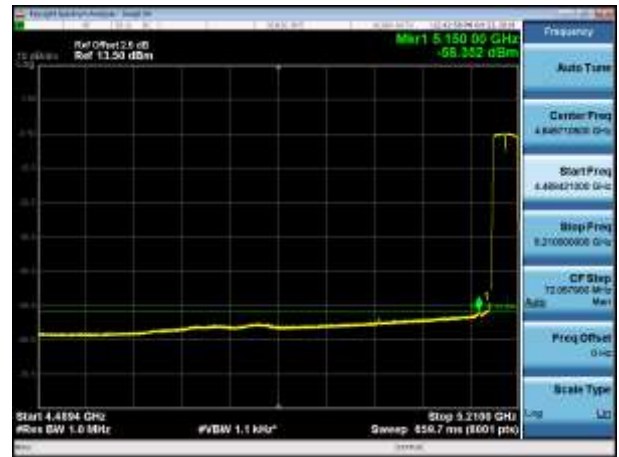

5230MHz with 4*4 CDD PK

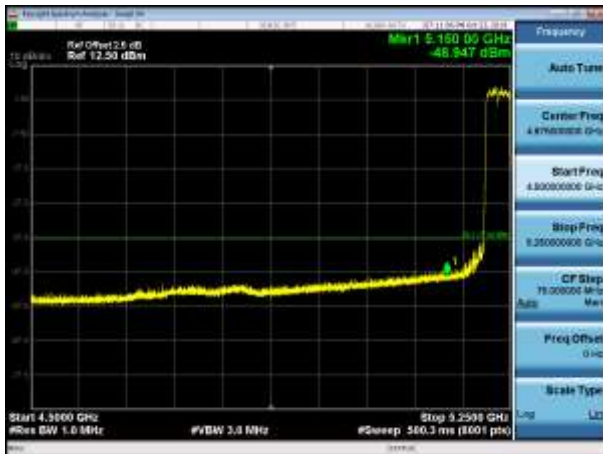

5230MHz with 4*4 CDD AV



5310MHz with 4*4 CDD PK

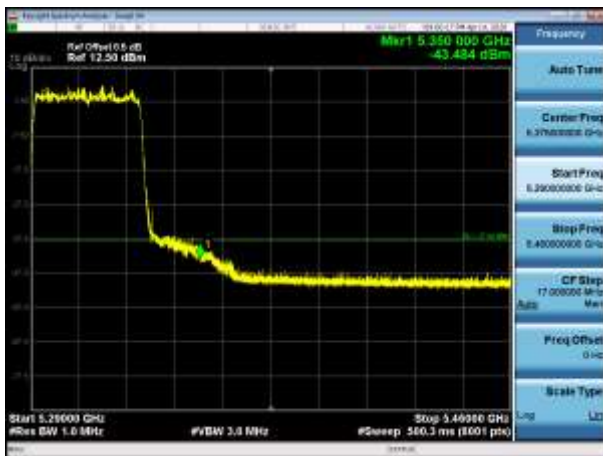

5310MHz with 4*4 CDD AV

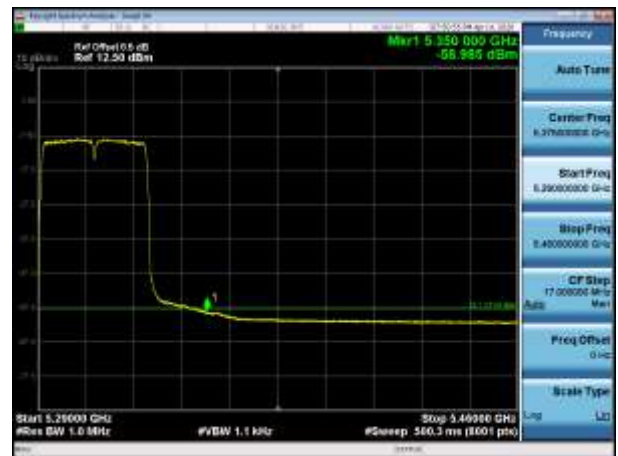

5510MHz with 4*4 CDD PK

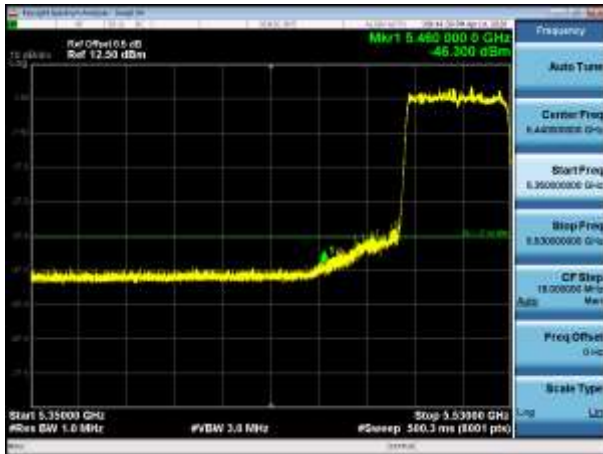

5510MHz with 4*4 CDD AV

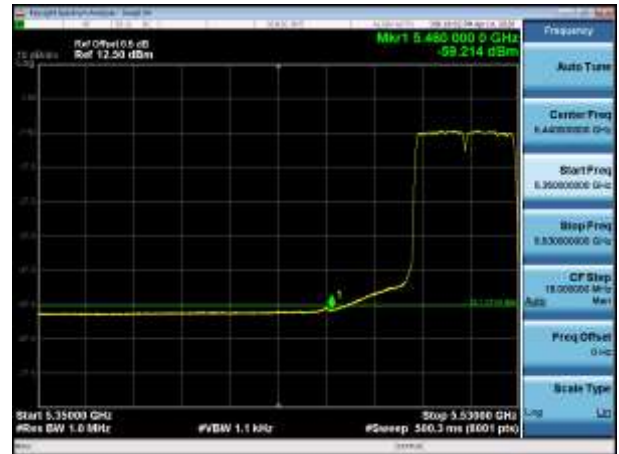

5755MHz with 4*4 CDD PK

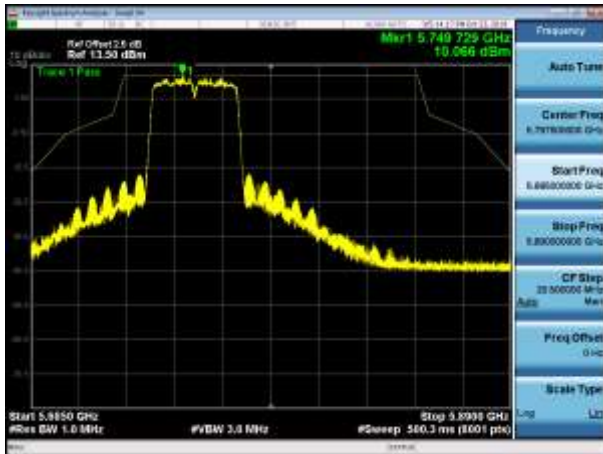

5795MHz with 4*4 CDD PK

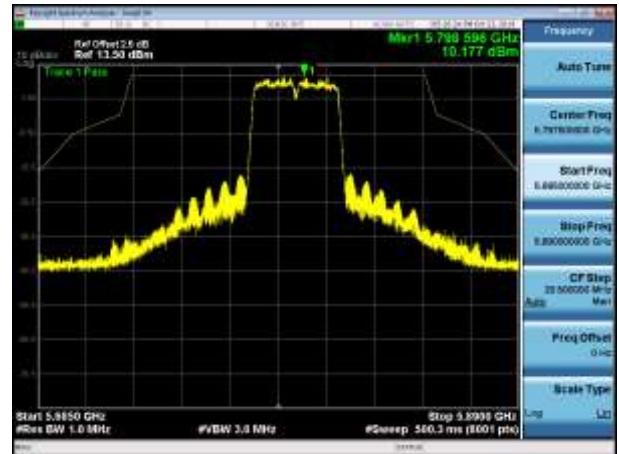

5190MHz with 4*4 Beamforming PK

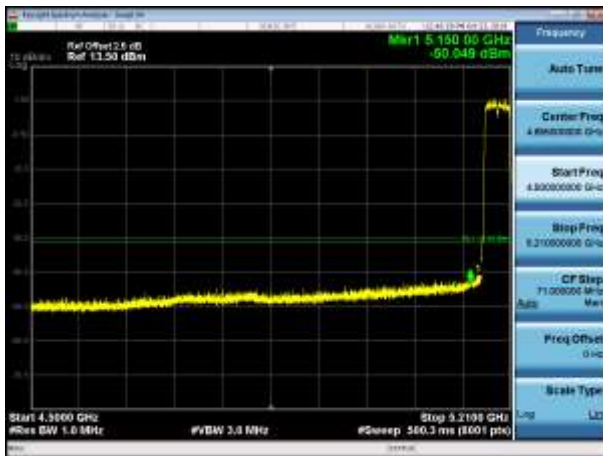

5190MHz with 4*4 Beamforming AV

