



FCC Test Report

FCC ID : QXO-AP460
Equipment : Wireless Access Point
Brand Name : Extreme Networks, Inc.
Model Name : AP460i, AP460e
Applicant : Extreme Networks, Inc.
6480 Via Del Oro, San Jose, CA 95119, United States
Manufacturer : Extreme Networks, Inc.
6480 Via Del Oro, San Jose, CA 95119, United States
Standard : 47 CFR FCC Part 15.407

The product was received on Aug. 13, 2019, and testing was started from Aug. 26, 2019 and completed on Nov. 12, 2019. We, SPORTON INTERNATIONAL INC. EMC & Wireless Communications Laboratory, would like to declare that the tested sample has been evaluated in accordance with the procedures given in ANSI C63.10-2013 and shown compliance with the applicable technical standards.

The report must not be used by the client to claim product certification, approval, or endorsement by TAF or any agency of government.

The test results in this report apply exclusively to the tested model / sample. Without written approval of SPORTON INTERNATIONAL INC. EMC & Wireless Communications Laboratory, the test report shall not be reproduced except in full.

Approved by: Allen Lin

SPORTON INTERNATIONAL INC. EMC & Wireless Communications Laboratory

No. 52, Huaya 1st Rd., Guishan Dist., Taoyuan City, Taiwan (R.O.C.)



Table of Contents

HISTORY OF THIS TEST REPORT3

SUMMARY OF TEST RESULT4

1 GENERAL DESCRIPTION5

1.1 Information.....5

1.2 Testing Applied Standards14

1.3 Testing Location Information14

1.4 Measurement Uncertainty14

2 TEST CONFIGURATION OF EUT.....15

2.1 Test Condition15

2.2 Test Channel Mode15

2.3 The Worst Case Measurement Configuration.....54

2.4 Support Equipment.....56

2.5 Test Setup Diagram57

3 TRANSMITTER TEST RESULT61

3.1 AC Power-line Conducted Emissions61

3.2 Emission Bandwidth63

3.3 Maximum Conducted Output Power64

3.4 Peak Power Spectral Density.....66

3.5 Unwanted Emissions.....68

4 TEST EQUIPMENT AND CALIBRATION DATA.....73

APPENDIX A. TEST RESULTS OF AC POWER-LINE CONDUCTED EMISSIONS

APPENDIX B. TEST RESULTS OF EMISSION BANDWIDTH

**APPENDIX C. TEST RESULTS OF MAXIMUM CONDUCTED OUTPUT POWER AND
MAX. E.I.R.P. AT ANY ELEVATION ANGLE ABOVE 30 DEGREES**

APPENDIX D. TEST RESULTS OF PEAK POWER SPECTRAL DENSITY

APPENDIX E. TEST RESULTS OF UNWANTED EMISSIONS

APPENDIX F. TEST PHOTOS

PHOTOGRAPHS OF EUT V01



Summary of Test Result

Report Clause	Ref. Std. Clause	Test Items	Result (PASS/FAIL)	Remark
1.1.2	15.203	Antenna Requirement	PASS	-
3.1	15.207	AC Power-line Conducted Emissions	PASS	-
3.2	15.407(a)	Emission Bandwidth	PASS	-
3.3	15.407(a)	Maximum Conducted Output Power	PASS	-
3.4	15.407(a)	Peak Power Spectral Density	PASS	-
3.5	15.407(b)	Unwanted Emissions	PASS	-

Declaration of Conformity:
The test results with all measurement uncertainty excluded are presented in accordance with the regulation limits or requirements declared by manufacturers.
Comments and explanations:
None

Reviewed by: Sam Tsai

Report Producer: Jenny Yang



1 General Description

1.1 Information

1.1.1 RF General Information

Frequency Range (MHz)	IEEE Std. 802.11	Ch. Frequency (MHz)	Channel Number
5150-5250	a, n (HT20), ac (VHT20), ax(HEW 20)	5180-5240	36-48 [4]
5725-5850		5745-5825	149-165 [5]
5150-5250	n (HT40), ac (VHT40), ax(HEW 40)	5190-5230	38-46 [2]
5725-5850		5755-5795	151-159 [2]
5150-5250	ac (VHT80), ax(HEW 80)	5210	42 [1]
5725-5850		5775	155 [1]

Non-Beamforming

Band	Mode	BWch (MHz)	Nant
5.15-5.25GHz	802.11a	20	1TX
5.725-5.85GHz	802.11a	20	1TX
5.15-5.25GHz	802.11ac VHT20	20	1TX
5.725-5.85GHz	802.11ac VHT20	20	1TX
5.15-5.25GHz	802.11ac VHT40	40	1TX
5.725-5.85GHz	802.11ac VHT40	40	1TX
5.15-5.25GHz	802.11ac VHT80	80	1TX
5.725-5.85GHz	802.11ac VHT80	80	1TX
5.15-5.25GHz	802.11ax HEW20	20	1TX
5.725-5.85GHz	802.11ax HEW20	20	1TX
5.15-5.25GHz	802.11ax HEW40	40	1TX
5.725-5.85GHz	802.11ax HEW40	40	1TX
5.15-5.25GHz	802.11ax HEW80	80	1TX
5.725-5.85GHz	802.11ax HEW80	80	1TX
5.15-5.25GHz	802.11a	20	2TX
5.725-5.85GHz	802.11a	20	2TX
5.15-5.25GHz	802.11ac VHT20	20	2TX
5.725-5.85GHz	802.11ac VHT20	20	2TX
5.15-5.25GHz	802.11ac VHT40	40	2TX
5.725-5.85GHz	802.11ac VHT40	40	2TX
5.15-5.25GHz	802.11ac VHT80	80	2TX



Band	Mode	BWch (MHz)	Nant
5.725-5.85GHz	802.11ac VHT80	80	2TX
5.15-5.25GHz	802.11ax HEW20	20	2TX
5.725-5.85GHz	802.11ax HEW20	20	2TX
5.15-5.25GHz	802.11ax HEW40	40	2TX
5.725-5.85GHz	802.11ax HEW40	40	2TX
5.15-5.25GHz	802.11ax HEW80	80	2TX
5.725-5.85GHz	802.11ax HEW80	80	2TX
5.15-5.25GHz	802.11ac VHT20	20	4TX
5.725-5.85GHz	802.11ac VHT20	20	4TX
5.15-5.25GHz	802.11ac VHT40	40	4TX
5.725-5.85GHz	802.11ac VHT40	40	4TX
5.15-5.25GHz	802.11ac VHT80	80	4TX
5.725-5.85GHz	802.11ac VHT80	80	4TX
5.15-5.25GHz	802.11ax HEW20	20	4TX
5.725-5.85GHz	802.11ax HEW20	20	4TX
5.15-5.25GHz	802.11ax HEW40	40	4TX
5.725-5.85GHz	802.11ax HEW40	40	4TX
5.15-5.25GHz	802.11ax HEW80	80	4TX
5.725-5.85GHz	802.11ax HEW80	80	4TX

Beamforming

Band	Mode	BWch (MHz)	Nant
5.15-5.25GHz	802.11ac VHT20-BF	20	2TX
5.725-5.85GHz	802.11ac VHT20-BF	20	2TX
5.15-5.25GHz	802.11ac VHT40-BF	40	2TX
5.725-5.85GHz	802.11ac VHT40-BF	40	2TX
5.15-5.25GHz	802.11ac VHT80-BF	80	2TX
5.725-5.85GHz	802.11ac VHT80-BF	80	2TX
5.15-5.25GHz	802.11ax HEW20-BF	20	2TX
5.725-5.85GHz	802.11ax HEW20-BF	20	2TX
5.15-5.25GHz	802.11ax HEW40-BF	40	2TX
5.725-5.85GHz	802.11ax HEW40-BF	40	2TX
5.15-5.25GHz	802.11ax HEW80-BF	80	2TX
5.725-5.85GHz	802.11ax HEW80-BF	80	2TX
5.15-5.25GHz	802.11ac VHT20-BF	20	4TX



Band	Mode	BWch (MHz)	Nant
5.725-5.85GHz	802.11ac VHT20-BF	20	4TX
5.15-5.25GHz	802.11ac VHT40-BF	40	4TX
5.725-5.85GHz	802.11ac VHT40-BF	40	4TX
5.15-5.25GHz	802.11ac VHT80-BF	80	4TX
5.725-5.85GHz	802.11ac VHT80-BF	80	4TX
5.15-5.25GHz	802.11ax HEW20-BF	20	4TX
5.725-5.85GHz	802.11ax HEW20-BF	20	4TX
5.15-5.25GHz	802.11ax HEW40-BF	40	4TX
5.725-5.85GHz	802.11ax HEW40-BF	40	4TX
5.15-5.25GHz	802.11ax HEW80-BF	80	4TX
5.725-5.85GHz	802.11ax HEW80-BF	80	4TX

Note:

- ♦ 11a, HT20 and HT40 use a combination of OFDM-BPSK, QPSK, 16QAM, 64QAM modulation.
- ♦ VHT20, VHT40, VHT80 use a combination of OFDM-BPSK, QPSK, 16QAM, 64QAM, 256QAM modulation.
- ♦ HEW20, HEW40, HEW80 use a combination of OFDMA-BPSK, QPSK, 16QAM, 64QAM, 256QAM, 1024QAM modulation.
- ♦ BWch is the nominal channel bandwidth.
- ♦ The resource unit of HEW 20, HEW 40, HEW 80 only support full loading.

1.1.2 Antenna Information

(AP460i) Internal Antenna

Ant.	Brand	Model Number (P/N)	Antenna Type	Connector	Antenna Gain (dBi)			Remark
					2.4GHz	5GHz	BLE/Thread	
1	SENAO	5718A0462300	PIFA	IPEX	-	5.58	-	Radio 2
2	SENAO	5718A0463300	PIFA	IPEX	-	5.58	-	Radio 2
3	SENAO	5718A0465300	PIFA	IPEX	-	5.58	-	Radio 2
4	SENAO	5718A0464300	PIFA	IPEX	-	5.58	-	Radio 2
5	SENAO	5718A0458300	PIFA	IPEX	4.82	-	-	Radio 1
6	SENAO	5718A0459300	PIFA	IPEX	4.82	-	-	Radio 1
7	SENAO	5718A0460300	PIFA	IPEX	4.87	5.02	-	Radio 3
8	SENAO	5718A0461300	PIFA	IPEX	4.87	5.02	-	Radio 3
9	SENAO	5718A0466300	PIFA	IPEX	-	-	4.65	Radio 4

(AP460e) External Antenna

Group	Brand	Model Number (P/N)	Antenna Type	Connector	Antenna Gain (dBi)		
					2.4GHz	5GHz	BLE/Thread
1	Extreme	ML-2452-APA2-01	Omni	RP SMA male	3.17	4.85	-
2	Extreme	ML-2452-APA2-02	Omni	RP SMA male	3.17	4.85	-
3	Extreme	ML-2452-HPA5-036	Omni	RP SMA male	3.9	5.7	-
4	Extreme	ML-2452-HPAG4A6-01	Omni	N male	4	7.3	-
5	Extreme	ML-2452-PNA5-01R	Panel	Type N-Male	4.5	5	-
6	Extreme	ML-2452-PTA4M4-036	Omni	Rev-Polarity SMA Male 4x	5	6.6	-
7	Extreme	ML-2452-HPAG5A8-01	Omni	N male	5	8	-
8	Extreme	WS-AO-DQ04360N	Omni	N male	5.5	6	-
9	Extreme	AI-DQ04360S	Omni	RP SMA male	5.5	6	-
10	Extreme	ML-2452-SEC6M4-036 / WS-AI-DQ05120	Panel	RP SMA male	6.92	7.23	-
11	Extreme	WS-AI-DE07025	Panel	RP SMA male	7.5	6.5	-
12	Extreme	ML-2452-PNA7-01R	Panel 1	Type N-Male	7.8	10.7	7.8
13	Extreme	WS-AI-DE10055	Panel 2	RP SMA male	10.5	7.5	-
14	Extreme	ML-2499-HPA8-01	Dipole	N male	-	-	8



Note 1: Group 7, 12 and 13 were measured during the test for WLAN 2.4G Mode.
 Note 2: Group 12 and 14 were measured during the test for Bluetooth/Thread Mode.
 Note 3: Group 7 and 12 were measured during the test for WLAN 5G Mode.

For 2.4GHz function:

For IEEE 802.11 b/g/n/ax mode (1TX/1RX)
 Only port 1 can be used as transmitting/receiving antenna.
 For IEEE 802.11 b/g/n/ax mode (2TX/2RX)
 Port 1 and port 2 could transmit/receive simultaneously.

For BT function:

For IEEE 802.15.1 Bluetooth mode (1TX/1RX)
 Only port 1 can be used as transmitting/receiving antenna.

For Thread function:

For IEEE 802.15.4 Thread mode (1TX/1RX)
 Only port 1 can be used as transmitting/receiving antenna.

For 5GHz function:

For IEEE 802.11 a/n/ac/ax mode (1TX/1RX)
 Only port 1 can be used as transmitting/receiving antenna.
 For IEEE 802.11 a/n/ac/ax mode (2TX/2RX)
 Port 1 and port 2 could transmit/receive simultaneously.
 For IEEE 802.11 a/n/ac/ax mode (4TX/4RX)
 Port 1, port 2, port 3 and port 4 could transmit/receive simultaneously.

1.1.3 EUT Information

Operational Condition			
EUT Power Type	From PoE		
EUT Function	<input checked="" type="checkbox"/>	Outdoor AP	<input type="checkbox"/> Indoor AP
	<input type="checkbox"/>	Fixed P2P AP	<input type="checkbox"/> Outdoor/Indoor Client
Beamforming Function	<input checked="" type="checkbox"/>	With beamforming	<input type="checkbox"/> Without beamforming
Type of EUT			
<input checked="" type="checkbox"/>	Stand-alone		
<input type="checkbox"/>	Combined (EUT where the radio part is fully integrated within another device)		
	Combined Equipment - Brand Name / Model No.:		...
<input type="checkbox"/>	Plug-in radio (EUT intended for a variety of host systems)		
	Host System - Brand Name / Model No.:		...
<input type="checkbox"/>	Other:		



1.1.4 Table for Multiple Listing

Sample Number	Model Name	Description
1	AP460i	The "i" in AP460i indicates that it comes with internal antennas and the "e" in AP460e indicates that the access point comes with external antenna connectors.
2	AP460e	

1.1.5 Mode Test Duty Cycle

Non-Beamforming

Sample 1 & 2_Radio 2_1T1S

Mode	DC	DCF(dB)	T(s)	VBW(Hz) ≥ 1/T
802.11a_Nss1,(6Mbps)_1TX	0.952	0.21	2.066m	1k
802.11ac VHT20_Nss1,(MCS0)_1TX	0.985	0.07	n/a (DC>=0.98)	n/a (DC>=0.98)
802.11ac VHT40_Nss1,(MCS0)_1TX	0.971	0.13	953.75u	3k
802.11ac VHT80_Nss1,(MCS0)_1TX	0.942	0.26	461.25u	3k
802.11ax HEW20_Nss1,(MCS0)_1TX	0.979	0.09	1.489m	1k
802.11ax HEW40_Nss1,(MCS0)_1TX	0.963	0.16	773.75u	3k
802.11ax HEW80_Nss1,(MCS0)_1TX	0.928	0.32	402.5u	3k

Sample 1 & 2_Radio 2_2T2S

Mode	DC	DCF(dB)	T(s)	VBW(Hz) ≥ 1/T
802.11a_Nss1,(6Mbps)_2TX	0.951	0.22	2.066m	1k
802.11ac VHT20_Nss2,(MCS0)_2TX	0.972	0.12	990.625u	3k
802.11ac VHT40_Nss2,(MCS0)_2TX	0.947	0.24	501.563u	3k
802.11ac VHT80_Nss2,(MCS0)_2TX	0.902	0.45	257.813u	10k
802.11ax HEW20_Nss2,(MCS0)_2TX	0.963	0.16	781.25u	3k
802.11ax HEW40_Nss2,(MCS0)_2TX	0.931	0.31	423.438u	3k
802.11ax HEW80_Nss2,(MCS0)_2TX	0.891	0.5	242.187u	10k



Sample 1 & 2_Radio 2_4T1S

Mode	DC	DCF(dB)	T(s)	VBW(Hz) ≥ 1/T
802.11a_Nss1,(6Mbps)_4TX	0.952	0.21	2.066m	1k
802.11ac VHT20_Nss1,(MCS0)_4TX	0.986	0.06	n/a (DC>=0.98)	n/a (DC>=0.98)
802.11ac VHT40_Nss1,(MCS0)_4TX	0.972	0.12	953.75u	3k
802.11ac VHT80_Nss1,(MCS0)_4TX	0.942	0.26	461.25u	3k
802.11ax HEW20_Nss1,(MCS0)_4TX	0.979	0.09	1.489m	1k
802.11ax HEW40_Nss1,(MCS0)_4TX	0.963	0.16	773.75u	3k
802.11ax HEW80_Nss1,(MCS0)_4TX	0.929	0.32	402.5u	3k

Sample 1 & 2_Radio 2_4T4S

Mode	DC	DCF(dB)	T(s)	VBW(Hz) ≥ 1/T
802.11ac VHT20_Nss4,(MCS0)_4TX	0.949	0.23	526.25u	3k
802.11ac VHT40_Nss4,(MCS0)_4TX	0.909	0.41	281.25u	10k
802.11ac VHT80_Nss4,(MCS0)_4TX	0.851	0.7	161.25u	10k
802.11ax HEW20_Nss4,(MCS0)_4TX	0.932	0.31	437.5u	3k
802.11ax HEW40_Nss4,(MCS0)_4TX	0.895	0.48	261.25u	10k
802.11ax HEW80_Nss4,(MCS0)_4TX	0.842	0.75	170u	10k

Sample 1 & 2_Radio 3_1T1S

Mode	DC	DCF(dB)	T(s)	VBW(Hz) ≥ 1/T
802.11a_Nss1,(6Mbps)_1TX	0.951	0.22	2.066m	1k
802.11ac VHT20_Nss1,(MCS0)_1TX	0.986	0.06	n/a (DC>=0.98)	n/a (DC>=0.98)
802.11ac VHT40_Nss1,(MCS0)_1TX	0.972	0.12	954.688u	3k
802.11ac VHT80_Nss1,(MCS0)_1TX	0.943	0.25	462.5u	3k
802.11ax HEW20_Nss1,(MCS0)_1TX	0.98	0.09	n/a (DC>=0.98)	n/a (DC>=0.98)
802.11ax HEW40_Nss1,(MCS0)_1TX	0.963	0.16	775u	3k
802.11ax HEW80_Nss1,(MCS0)_1TX	0.929	0.32	403.125u	3k



Sample 1 & 2_Radio 3_2T2S

Mode	DC	DCF(dB)	T(s)	VBW(Hz) ≥ 1/T
802.11a_Nss1,(6Mbps)_2TX	0.952	0.21	2.065m	1k
802.11ac VHT20_Nss2,(MCS0)_2TX	0.964	0.16	781.25u	3k
802.11ac VHT40_Nss2,(MCS0)_2TX	0.931	0.31	423.75u	3k
802.11ac VHT80_Nss2,(MCS0)_2TX	0.89	0.51	241.25u	10k
802.11ax HEW20_Nss2,(MCS0)_2TX	0.973	0.12	990u	3k
802.11ax HEW40_Nss2,(MCS0)_2TX	0.947	0.24	501.25u	3k
802.11ax HEW80_Nss2,(MCS0)_2TX	0.902	0.45	257.5u	10k

Beamforming

Sample 1_Radio 2

Mode	DC	DCF(dB)	T(s)	VBW(Hz) ≥ 1/T
802.11ac VHT20-BF_Nss1,(MCS0)_4TX	0.902	0.45	1.95m	1k
802.11ac VHT40-BF_Nss1,(MCS0)_4TX	0.906	0.43	2.798m	1k
802.11ac VHT80-BF_Nss1,(MCS0)_4TX	0.88	0.56	3.43m	300
802.11ax HEW20-BF_Nss1,(MCS0)_4TX	0.867	0.62	1.503m	1k
802.11ax HEW40-BF_Nss1,(MCS0)_4TX	0.88	0.56	2.224m	1k
802.11ax HEW80-BF_Nss1,(MCS0)_4TX	0.714	1.46	3.843m	300

Sample 1& 2_Radio 3

Mode	DC	DCF(dB)	T(s)	VBW(Hz) ≥ 1/T
802.11ac VHT20-BF_Nss1,(MCS0)_2TX	0.889	0.51	1.95m	1k
802.11ac VHT40-BF_Nss1,(MCS0)_2TX	0.908	0.42	2.798m	1k
802.11ac VHT80-BF_Nss1,(MCS0)_2TX	0.919	0.37	3.43m	300
802.11ax HEW20-BF_Nss1,(MCS0)_2TX	0.875	0.58	1.503m	1k
802.11ax HEW40-BF_Nss1,(MCS0)_2TX	0.881	0.55	2.224m	1k
802.11ax HEW80-BF_Nss1,(MCS0)_2TX	0.929	0.32	3.844m	300



Sample 2_Radio 2

Mode	DC	DCF(dB)	T(s)	VBW(Hz) ≥ 1/T
802.11ac VHT20-BF_Nss1,(MCS0)_4TX	0.888	0.52	1.95m	1k
802.11ac VHT40-BF_Nss1,(MCS0)_4TX	0.902	0.45	2.798m	1k
802.11ac VHT80-BF_Nss1,(MCS0)_4TX	0.906	0.43	3.43m	300
802.11ax HEW20-BF_Nss1,(MCS0)_4TX	0.775	1.11	1.503m	1k
802.11ax HEW40-BF_Nss1,(MCS0)_4TX	0.891	0.5	2.224m	1k
802.11ax HEW80-BF_Nss1,(MCS0)_4TX	0.72	1.43	3.844m	300

Note. If DC < 0.98, the DCF was added while measuring Output power and PSD.

1.2 Testing Applied Standards

According to the specifications of the manufacturer, the EUT must comply with the requirements of the following standards:

- ◆ 47 CFR FCC Part 15
- ◆ ANSI C63.10-2013
- ◆ KDB 789033 D02 v02r01
- ◆ KDB 662911 D01 v02r01
- ◆ KDB 414788 D01 v01r01

1.3 Testing Location Information

Testing Location			
<input checked="" type="checkbox"/>	HWA YA	ADD : No. 52, Huaya 1st Rd., Guishan Dist., Taoyuan City, Taiwan (R.O.C.)	
		TEL : 886-3-327-3456	FAX : 886-3-327-0973
Test site Designation No. TW1190 with FCC.			
<input type="checkbox"/>	JHUBEI	ADD : No.8, Ln. 724, Bo'ai St., Zhubei City, Hsinchu County, Taiwan (R.O.C.)	
		TEL : 886-3-656-9065	FAX : 886-3-656-9085
Test site Designation No. TW0006 with FCC.			

Test Condition	Test Site No.	Test Engineer	Test Environment	Test Date
AC Conduction	CO04-HY	Edward Wang	20.9~22.1°C / 60.4~64.2%	08/Nov/2019~ 12/Nov/2019
RF Conducted	TH06-HY	Tim Chen	23.1~25°C / 61~67%	26/Aug/2019~ 09/Nov/2019
Radiated	03CH03-HY	Edward Wand	22.2~22.2°C / 51.8~51.8%	07/Sep/2019~ 18/Oct/2019

1.4 Measurement Uncertainty

ISO/IEC 17025 requires that an estimate of the measurement uncertainties associated with the emissions test results be included in the report. The measurement uncertainties given below are based on a 95% confidence level (based on a coverage factor (k=2))

Test Items	Uncertainty	Remark
Conducted Emission (150kHz ~ 30MHz)	3.54 dB	Confidence levels of 95%
Radiated Emission (9kHz ~ 30MHz)	1.6 dB	Confidence levels of 95%
Radiated Emission (30MHz ~ 1,000MHz)	4.3 dB	Confidence levels of 95%
Radiated Emission (1GHz ~ 18GHz)	3.9 dB	Confidence levels of 95%
Radiated Emission (18GHz ~ 40GHz)	3.5 dB	Confidence levels of 95%
Conducted Emission	1.3 dB	Confidence levels of 95%
Temperature	0.7 °C	Confidence levels of 95%
Humidity	4 %	Confidence levels of 95%



2 Test Configuration of EUT

2.1 Test Condition

Condition Item	Abbreviation/Remark	Remark
TnomVnom	Tnom	20°C
	Vnom	120V

2.2 Test Channel Mode

Test Software Version	accessMTool_REL_3_1_0_1
-----------------------	-------------------------

Non-Beamforming_ Sample 1_Radio 2_1T1S

Mode	Power Setting
802.11a_Nss1,(6Mbps)_1TX	-
5180MHz	15.25
5200MHz	15.25
5240MHz	15.5
5745MHz	30
5785MHz	30
5825MHz	30
802.11ac VHT20_Nss1,(MCS0)_1TX	
5180MHz	15
5200MHz	15
5240MHz	15
5745MHz	30
5785MHz	30
5825MHz	30
802.11ac VHT40_Nss1,(MCS0)_1TX	
5190MHz	15
5230MHz	15.25
5755MHz	28
5795MHz	28.25
802.11ac VHT80_Nss1,(MCS0)_1TX	
5210MHz	15
5775MHz	19.75
802.11ax HEW20_Nss1,(MCS0)_1TX	



Mode	Power Setting
5180MHz	15
5200MHz	15
5240MHz	15
5745MHz	30
5785MHz	30
5825MHz	30
802.11ax HEW40_Nss1,(MCS0)_1TX	
5190MHz	15
5230MHz	15.25
5755MHz	28
5795MHz	28.25
802.11ax HEW80_Nss1,(MCS0)_1TX	
5210MHz	15
5775MHz	19.75



Sample 1_Radio 2_2T2S

Mode	Power Setting
802.11a_Nss1,(6Mbps)_2TX	-
5180MHz	12.25
5200MHz	12.25
5240MHz	12.25
5745MHz	29.25
5785MHz	30
5825MHz	30
802.11ac VHT20_Nss2,(MCS0)_2TX	
5180MHz	11.75
5200MHz	12
5240MHz	12
5745MHz	30
5785MHz	30
5825MHz	30
802.11ac VHT40_Nss2,(MCS0)_2TX	
5190MHz	12
5230MHz	12.25
5755MHz	24
5795MHz	25.75
802.11ac VHT80_Nss2,(MCS0)_2TX	
5210MHz	12
5775MHz	19.5
802.11ax HEW20_Nss2,(MCS0)_2TX	
5180MHz	11.75
5200MHz	12
5240MHz	12
5745MHz	30
5785MHz	30
5825MHz	30
802.11ax HEW40_Nss2,(MCS0)_2TX	
5190MHz	12
5230MHz	12.25
5755MHz	24
5795MHz	25.75



Mode	Power Setting
802.11ax HEW80_Nss2,(MCS0)_2TX	
5210MHz	12
5775MHz	19.5



Sample 1_Radio 2_4T1S

Mode	Power Setting
802.11a_Nss1,(6Mbps)_4TX	-
5180MHz	9.5
5200MHz	9.5
5240MHz	9.5
5745MHz	28
5785MHz	28
5825MHz	28.5
802.11ac VHT20_Nss1,(MCS0)_4TX	
5180MHz	9
5200MHz	9.25
5240MHz	9.25
5745MHz	27.5
5785MHz	27.5
5825MHz	27.75
802.11ac VHT40_Nss1,(MCS0)_4TX	
5190MHz	9
5230MHz	9
5755MHz	22.25
5795MHz	26.25
802.11ac VHT80_Nss1,(MCS0)_4TX	
5210MHz	8.75
5775MHz	17.75
802.11ax HEW20_Nss1,(MCS0)_4TX	
5180MHz	9
5200MHz	9.25
5240MHz	9.25
5745MHz	27.5
5785MHz	27.5
5825MHz	27.75
802.11ax HEW40_Nss1,(MCS0)_4TX	
5190MHz	9
5230MHz	9
5755MHz	22.25
5795MHz	26.25



Mode	Power Setting
802.11ax HEW80_Nss1,(MCS0)_4TX	
5210MHz	8.75
5775MHz	17.75



Sample 1_Radio 2_4T4S

Mode	Power Setting
802.11ac VHT20_Nss4,(MCS0)_4TX	-
5180MHz	9.25
5200MHz	9.5
5240MHz	9.75
5745MHz	26.25
5785MHz	28
5825MHz	28
802.11ac VHT40_Nss4,(MCS0)_4TX	
5190MHz	9.25
5230MHz	9.25
5755MHz	24.5
5795MHz	26.5
802.11ac VHT80_Nss4,(MCS0)_4TX	
5210MHz	9.25
5775MHz	19
802.11ax HEW20_Nss4,(MCS0)_4TX	
5180MHz	9.25
5200MHz	9.5
5240MHz	9.75
5745MHz	26.25
5785MHz	28
5825MHz	28
802.11ax HEW40_Nss4,(MCS0)_4TX	
5190MHz	9.25
5230MHz	9.25
5755MHz	24.5
5795MHz	26.5
802.11ax HEW80_Nss4,(MCS0)_4TX	
5210MHz	9.25
5775MHz	19



Sample 1_Radio 3_1T1S

Mode	Power Setting
802.11a_Nss1,(6Mbps)_1TX	-
5180MHz	16
5200MHz	16
5240MHz	16.25
5745MHz	23.5
5785MHz	20.75
5825MHz	21
802.11ac VHT20_Nss1,(MCS0)_1TX	
5180MHz	15.75
5200MHz	15.75
5240MHz	15.75
5745MHz	22.5
5785MHz	21.25
5825MHz	21.25
802.11ac VHT40_Nss1,(MCS0)_1TX	
5190MHz	15.75
5230MHz	15.75
5755MHz	22.25
5795MHz	21.75
802.11ac VHT80_Nss1,(MCS0)_1TX	
5210MHz	16
5775MHz	21.75
802.11ax HEW20_Nss1,(MCS0)_1TX	
5180MHz	15.75
5200MHz	15.75
5240MHz	15.75
5745MHz	22.5
5785MHz	21.25
5825MHz	21.25
802.11ax HEW40_Nss1,(MCS0)_1TX	
5190MHz	15.75
5230MHz	15.75
5755MHz	22.25
5795MHz	21.75



Mode	Power Setting
802.11ax HEW80_Nss1,(MCS0)_1TX	
5210MHz	16
5775MHz	21.75



Sample 1_Radio 3_2T2S

Mode	Power Setting
802.11a_Nss1,(6Mbps)_2TX	-
5180MHz	13.5
5200MHz	13.5
5240MHz	13.5
5745MHz	23
5785MHz	21.5
5825MHz	20.5
802.11ac VHT20_Nss2,(MCS0)_2TX	
5180MHz	13.25
5200MHz	13.25
5240MHz	13
5745MHz	22.5
5785MHz	21.25
5825MHz	21
802.11ac VHT40_Nss2,(MCS0)_2TX	
5190MHz	13.25
5230MHz	13.25
5755MHz	21
5795MHz	20.5
802.11ac VHT80_Nss2,(MCS0)_2TX	
5210MHz	13.25
5775MHz	21
802.11ax HEW20_Nss2,(MCS0)_2TX	
5180MHz	13.25
5200MHz	13.25
5240MHz	13
5745MHz	22.5
5785MHz	21.25
5825MHz	21
802.11ax HEW40_Nss2,(MCS0)_2TX	
5190MHz	13.25
5230MHz	13.25
5755MHz	21
5795MHz	20.5



Mode	Power Setting
802.11ax HEW80_Nss2,(MCS0)_2TX	
5210MHz	13.25
5775MHz	21



Sample 2_Radio 2_Omni_1T1S

Mode	Power Setting
802.11a_Nss1,(6Mbps)_1TX	-
5180MHz	23.5
5200MHz	29
5240MHz	29.5
5745MHz	30
5785MHz	30
5825MHz	30
802.11ac VHT20_Nss1,(MCS0)_1TX	-
5180MHz	21.25
5200MHz	28
5240MHz	28.75
5745MHz	30
5785MHz	30
5825MHz	30
802.11ac VHT40_Nss1,(MCS0)_1TX	-
5190MHz	18.5
5230MHz	24.5
5755MHz	26
5795MHz	26.75
802.11ac VHT80_Nss1,(MCS0)_1TX	-
5210MHz	19.25
5775MHz	19.5
802.11ax HEW20_Nss1,(MCS0)_1TX	-
5180MHz	21.25
5200MHz	28
5240MHz	28.75
5745MHz	30
5785MHz	30
5825MHz	30
802.11ax HEW40_Nss1,(MCS0)_1TX	-
5190MHz	18.5
5230MHz	24.5
5755MHz	26
5795MHz	26.75



Mode	Power Setting
802.11ax HEW80_Nss1,(MCS0)_1TX	-
5210MHz	19.25
5775MHz	19.5



Sample 2_Radio 2_Omni_2T2S

Mode	Power Setting
802.11a_Nss1,(6Mbps)_2TX	-
5180MHz	22
5200MHz	22.5
5240MHz	22.5
5745MHz	27.5
5785MHz	27.5
5825MHz	27.5
802.11ac VHT20_Nss2,(MCS0)_2TX	
5180MHz	20
5200MHz	23.75
5240MHz	24
5745MHz	27
5785MHz	27
5825MHz	27
802.11ac VHT40_Nss2,(MCS0)_2TX	
5190MHz	18.5
5230MHz	24.25
5755MHz	26.5
5795MHz	26.5
802.11ac VHT80_Nss2,(MCS0)_2TX	
5210MHz	19
5775MHz	20
802.11ax HEW20_Nss2,(MCS0)_2TX	
5180MHz	20
5200MHz	23.75
5240MHz	24
5745MHz	27
5785MHz	27
5825MHz	27
802.11ax HEW40_Nss2,(MCS0)_2TX	
5190MHz	18.5
5230MHz	24.25
5755MHz	26.5
5795MHz	26.5



Mode	Power Setting
802.11ax HEW80_Nss2,(MCS0)_2TX	
5210MHz	19
5775MHz	20



Sample 2 Radio 2 Omni_4T1S

Mode	Power Setting
802.11a_Nss1,(6Mbps)_4TX	-
5180MHz	15.75
5200MHz	16.25
5240MHz	16.25
5745MHz	23.75
5785MHz	23.75
5825MHz	23.75
802.11ac VHT20_Nss1,(MCS0)_4TX	
5180MHz	16
5200MHz	16
5240MHz	16.25
5745MHz	23
5785MHz	23
5825MHz	23
802.11ac VHT40_Nss1,(MCS0)_4TX	
5190MHz	16.5
5230MHz	19.75
5755MHz	23
5795MHz	23
802.11ac VHT80_Nss1,(MCS0)_4TX	
5210MHz	16.5
5775MHz	17.75
802.11ax HEW20_Nss1,(MCS0)_4TX	
5180MHz	16
5200MHz	16
5240MHz	16.25
5745MHz	23
5785MHz	23
5825MHz	23
802.11ax HEW40_Nss1,(MCS0)_4TX	
5190MHz	16.5
5230MHz	19.75
5755MHz	23
5795MHz	23



Mode	Power Setting
802.11ax HEW80_Nss1,(MCS0)_4TX	
5210MHz	16.5
5775MHz	17.75



Sample 2_Radio 2_Omni_4T4S

Mode	Power Setting
802.11ac VHT20_Nss4,(MCS0)_4TX	-
5180MHz	18.75
5200MHz	21.25
5240MHz	21.5
5745MHz	23
5785MHz	23
5825MHz	23.25
802.11ac VHT40_Nss4,(MCS0)_4TX	-
5190MHz	15.25
5230MHz	21.25
5755MHz	21.75
5795MHz	23.75
802.11ac VHT80_Nss4,(MCS0)_4TX	-
5210MHz	16.25
5775MHz	17.75
802.11ax HEW20_Nss4,(MCS0)_4TX	-
5180MHz	18.75
5200MHz	21.25
5240MHz	21.5
5745MHz	23
5785MHz	23
5825MHz	23.25
802.11ax HEW40_Nss4,(MCS0)_4TX	-
5190MHz	15.25
5230MHz	21.25
5755MHz	21.75
5795MHz	23.75
802.11ax HEW80_Nss4,(MCS0)_4TX	-
5210MHz	16.25
5775MHz	17.75



Sample 2_Radio 2_Panel 1_1T1S

Mode	Power Setting
802.11a_Nss1,(6Mbps)_1TX(Port1)	-
5180MHz	12
5200MHz	12
5240MHz	12.25
5745MHz	29.25
5785MHz	29.5
5825MHz	29.75
802.11ac VHT20_Nss1,(MCS0)_1TX(Port1)	
5180MHz	11.75
5200MHz	11.75
5240MHz	12
5745MHz	28.75
5785MHz	28.75
5825MHz	29
802.11ac VHT40_Nss1,(MCS0)_1TX(Port1)	
5190MHz	11.75
5230MHz	12
5755MHz	25.5
5795MHz	28.25
802.11ac VHT80_Nss1,(MCS0)_1TX(Port1)	
5210MHz	12
5775MHz	19.75
802.11ax HEW20_Nss1,(MCS0)_1TX(Port1)	
5180MHz	11.75
5200MHz	11.75
5240MHz	12
5745MHz	28.75
5785MHz	28.75
5825MHz	29
802.11ax HEW40_Nss1,(MCS0)_1TX(Port1)	
5190MHz	11.75
5230MHz	12
5755MHz	25.5
5795MHz	28.25



Mode	Power Setting
802.11ax HEW80_Nss1,(MCS0)_1TX(Port1)	
5210MHz	12
5775MHz	19.75



Sample 2_Radio 2_Panel 1_2T2S

Mode	Power Setting
802.11a_Nss1,(6Mbps)_2TX	-
5180MHz	9.5
5200MHz	9.5
5240MHz	9.75
5745MHz	19.75
5785MHz	19.75
5825MHz	19.75
802.11ac VHT20_Nss2,(MCS0)_2TX	
5180MHz	9.25
5200MHz	9.25
5240MHz	9.25
5745MHz	22
5785MHz	22
5825MHz	22.25
802.11ac VHT40_Nss2,(MCS0)_2TX	
5190MHz	9
5230MHz	9.25
5755MHz	21.75
5795MHz	22
802.11ac VHT80_Nss2,(MCS0)_2TX	
5210MHz	9
5775MHz	19
802.11ax HEW20_Nss2,(MCS0)_2TX	
5180MHz	9.25
5200MHz	9.25
5240MHz	9.25
5745MHz	22
5785MHz	22
5825MHz	22.25
802.11ax HEW40_Nss2,(MCS0)_2TX	
5190MHz	9
5230MHz	9.25
5755MHz	21.75
5795MHz	22



Mode	Power Setting
802.11ax HEW80_Nss2,(MCS0)_2TX	
5210MHz	9
5775MHz	19



Sample 2_Radio 2_Panel 1_4T1S

Mode	Power Setting
802.11a_Nss1,(6Mbps)_4TX	-
5180MHz	7.25
5200MHz	7.25
5240MHz	7.25
5745MHz	19
5785MHz	19
5825MHz	19.5
802.11ac VHT20_Nss1,(MCS0)_4TX	
5180MHz	6.75
5200MHz	6.75
5240MHz	7
5745MHz	18.5
5785MHz	18.5
5825MHz	18.75
802.11ac VHT40_Nss1,(MCS0)_4TX	
5190MHz	6.75
5230MHz	7
5755MHz	18.25
5795MHz	18.75
802.11ac VHT80_Nss1,(MCS0)_4TX	
5210MHz	6.5
5775MHz	18
802.11ax HEW20_Nss1,(MCS0)_4TX	
5180MHz	6.75
5200MHz	6.75
5240MHz	7
5745MHz	18.5
5785MHz	18.5
5825MHz	18.75
802.11ax HEW40_Nss1,(MCS0)_4TX	
5190MHz	6.75
5230MHz	7
5755MHz	18.25
5795MHz	18.75



Mode	Power Setting
802.11ax HEW80_Nss1,(MCS0)_4TX	
5210MHz	6.5
5775MHz	18



Sample 2_Radio 2_Panel 1_4T4S

Mode	Power Setting
802.11ac VHT20_Nss4,(MCS0)_4TX	-
5180MHz	7.25
5200MHz	7.25
5240MHz	7.25
5745MHz	18.25
5785MHz	18.25
5825MHz	18.75
802.11ac VHT40_Nss4,(MCS0)_4TX	
5190MHz	7
5230MHz	7.25
5755MHz	18.5
5795MHz	18.75
802.11ac VHT80_Nss4,(MCS0)_4TX	
5210MHz	6.75
5775MHz	19.25
802.11ax HEW20_Nss4,(MCS0)_4TX	
5180MHz	7.25
5200MHz	7.25
5240MHz	7.25
5745MHz	18.25
5785MHz	18.25
5825MHz	18.75
802.11ax HEW40_Nss4,(MCS0)_4TX	
5190MHz	7
5230MHz	7.25
5755MHz	18.5
5795MHz	18.75
802.11ax HEW80_Nss4,(MCS0)_4TX	
5210MHz	6.75
5775MHz	19.25



Sample 2_Radio 3_Omni_1T1S

Mode	Power Setting
802.11a_Nss1,(6Mbps)_1TX	-
5180MHz	19.25
5200MHz	22.25
5240MHz	23.75
5745MHz	23.25
5785MHz	22.75
5825MHz	24
802.11ac VHT20_Nss1,(MCS0)_1TX	
5180MHz	18.25
5200MHz	21
5240MHz	22.5
5745MHz	24.75
5785MHz	24
5825MHz	24.25
802.11ac VHT40_Nss1,(MCS0)_1TX	
5190MHz	18.75
5230MHz	23.25
5755MHz	24
5795MHz	25.25
802.11ac VHT80_Nss1,(MCS0)_1TX	
5210MHz	15.5
5775MHz	22
802.11ax HEW20_Nss1,(MCS0)_1TX	
5180MHz	18.25
5200MHz	21
5240MHz	22.5
5745MHz	24.75
5785MHz	24
5825MHz	24.25
802.11ax HEW40_Nss1,(MCS0)_1TX	
5190MHz	18.75
5230MHz	23.25
5755MHz	24
5795MHz	25.25



Mode	Power Setting
802.11ax HEW80_Nss1,(MCS0)_1TX	
5210MHz	15.5
5775MHz	22



Sample 2 Radio 3 Omni_2T2S

Mode	Power Setting
802.11a_Nss1,(6Mbps)_2TX	-
5180MHz	16.5
5200MHz	18.75
5240MHz	18.5
5745MHz	24
5785MHz	21
5825MHz	23.25
802.11ac VHT20_Nss2,(MCS0)_2TX	
5180MHz	16.25
5200MHz	19.5
5240MHz	19.5
5745MHz	23.75
5785MHz	23.75
5825MHz	24
802.11ac VHT40_Nss2,(MCS0)_2TX	
5190MHz	17.5
5230MHz	22
5755MHz	23.5
5795MHz	23.75
802.11ac VHT80_Nss2,(MCS0)_2TX	
5210MHz	12.25
5775MHz	21
802.11ax HEW20_Nss2,(MCS0)_2TX	
5180MHz	16.25
5200MHz	19.5
5240MHz	19.5
5745MHz	23.75
5785MHz	23.75
5825MHz	24
802.11ax HEW40_Nss2,(MCS0)_2TX	
5190MHz	17.5
5230MHz	22
5755MHz	23.5
5795MHz	23.75



Mode	Power Setting
802.11ax HEW80_Nss2,(MCS0)_2TX	
5210MHz	12.25
5775MHz	21



Sample 2_Radio 3_Panel 1_1T1S

Mode	Power Setting
802.11a_Nss1,(6Mbps)_1TX	-
5180MHz	11.5
5200MHz	11.5
5240MHz	11.5
5745MHz	23.25
5785MHz	23.5
5825MHz	23.5
802.11ac VHT20_Nss1,(MCS0)_1TX	
5180MHz	11.5
5200MHz	11.5
5240MHz	11.5
5745MHz	23.25
5785MHz	23.5
5825MHz	23.25
802.11ac VHT40_Nss1,(MCS0)_1TX	
5190MHz	11.75
5230MHz	11.75
5755MHz	23.25
5795MHz	23.25
802.11ac VHT80_Nss1,(MCS0)_1TX	
5210MHz	11.75
5775MHz	20.25
802.11ax HEW20_Nss1,(MCS0)_1TX	
5180MHz	11.5
5200MHz	11.5
5240MHz	11.5
5745MHz	23.25
5785MHz	23.5
5825MHz	23.25
802.11ax HEW40_Nss1,(MCS0)_1TX	
5190MHz	11.75
5230MHz	11.75
5755MHz	23.25
5795MHz	23.25



Mode	Power Setting
802.11ax HEW80_Nss1,(MCS0)_1TX	
5210MHz	11.75
5775MHz	20.25



Sample 2 Radio 3 Panel 1_2T2S

Mode	Power Setting
802.11a_Nss1,(6Mbps)_2TX	-
5180MHz	9.75
5200MHz	9.5
5240MHz	9.5
5745MHz	21.25
5785MHz	21.5
5825MHz	21.5
802.11ac VHT20_Nss2,(MCS0)_2TX	
5180MHz	9.5
5200MHz	9.25
5240MHz	9.25
5745MHz	20.75
5785MHz	21.25
5825MHz	21.25
802.11ac VHT40_Nss2,(MCS0)_2TX	
5190MHz	9.25
5230MHz	9.5
5755MHz	21
5795MHz	21
802.11ac VHT80_Nss2,(MCS0)_2TX	
5210MHz	9.5
5775MHz	20
802.11ax HEW20_Nss2,(MCS0)_2TX	
5180MHz	9.5
5200MHz	9.25
5240MHz	9.25
5745MHz	20.75
5785MHz	21.25
5825MHz	21.25
802.11ax HEW40_Nss2,(MCS0)_2TX	
5190MHz	9.25
5230MHz	9.5
5755MHz	21
5795MHz	21



Mode	Power Setting
802.11ax HEW80_Nss2,(MCS0)_2TX	
5210MHz	9.5
5775MHz	20



Beamforming
Sample 1_Radio 2_4T1S

Mode	Power Setting
802.11ac VHT20-BF_Nss1,(MCS0)_4TX	-
5180MHz	8.5
5200MHz	8.5
5240MHz	8.5
5745MHz	16.25
5785MHz	16.5
5825MHz	16.75
802.11ac VHT40-BF_Nss1,(MCS0)_4TX	
5190MHz	8.25
5230MHz	8.25
5755MHz	16.75
5795MHz	16.75
802.11ac VHT80-BF_Nss1,(MCS0)_4TX	
5210MHz	8
5775MHz	16
802.11ax HEW20-BF_Nss1,(MCS0)_4TX	
5180MHz	8.5
5200MHz	8.5
5240MHz	8.5
5745MHz	16.25
5785MHz	16.5
5825MHz	16.75
802.11ax HEW40-BF_Nss1,(MCS0)_4TX	
5190MHz	8.25
5230MHz	8.25
5755MHz	16.75
5795MHz	16.75
802.11ax HEW80-BF_Nss1,(MCS0)_4TX	
5210MHz	8
5775MHz	16



Sample 1_Radio 3_2T1S

Mode	Power Setting
802.11ac VHT20-BF_Nss1,(MCS0)_2TX	-
5180MHz	12.75
5200MHz	12.75
5240MHz	12.75
5745MHz	17
5785MHz	17
5825MHz	17
802.11ac VHT40-BF_Nss1,(MCS0)_2TX	-
5190MHz	11.25
5230MHz	12.75
5755MHz	20.75
5795MHz	21.25
802.11ac VHT80-BF_Nss1,(MCS0)_2TX	-
5210MHz	11.5
5775MHz	18.25
802.11ax HEW20-BF_Nss1,(MCS0)_2TX	-
5180MHz	12.75
5200MHz	12.75
5240MHz	12.75
5745MHz	17
5785MHz	17
5825MHz	17
802.11ax HEW40-BF_Nss1,(MCS0)_2TX	-
5190MHz	11.25
5230MHz	12.75
5755MHz	20.75
5795MHz	21.25
802.11ax HEW80-BF_Nss1,(MCS0)_2TX	-
5210MHz	11.5
5775MHz	18.25



Sample 2_Radio 2_Omni_4T1S

Mode	Power Setting
802.11ac VHT20-BF_Nss1,(MCS0)_4TX	-
5180MHz	13
5200MHz	13.25
5240MHz	14
5745MHz	14.75
5785MHz	15
5825MHz	15.25
802.11ac VHT40-BF_Nss1,(MCS0)_4TX	-
5190MHz	8.5
5230MHz	15.25
5755MHz	15.25
5795MHz	15.25
802.11ac VHT80-BF_Nss1,(MCS0)_4TX	-
5210MHz	8.75
5775MHz	13
802.11ax HEW20-BF_Nss1,(MCS0)_4TX	-
5180MHz	13
5200MHz	13.25
5240MHz	14
5745MHz	14.75
5785MHz	15
5825MHz	15.25
802.11ax HEW40-BF_Nss1,(MCS0)_4TX	-
5190MHz	8.5
5230MHz	15.25
5755MHz	15.25
5795MHz	15.25
802.11ax HEW80-BF_Nss1,(MCS0)_4TX	-
5210MHz	8.75
5775MHz	13



Sample 2_Radio 2_Panel 1_4T1S

Mode	Power Setting
802.11ac VHT20-BF_Nss1,(MCS0)_4TX	-
5180MHz	4.25
5200MHz	4.25
5240MHz	4.5
5745MHz	10.75
5785MHz	10.75
5825MHz	10.75
802.11ac VHT40-BF_Nss1,(MCS0)_4TX	
5190MHz	4.5
5230MHz	4.5
5755MHz	11
5795MHz	11
802.11ac VHT80-BF_Nss1,(MCS0)_4TX	
5210MHz	4.5
5775MHz	11
802.11ax HEW20-BF_Nss1,(MCS0)_4TX	
5180MHz	4.25
5200MHz	4.25
5240MHz	4.5
5745MHz	10.75
5785MHz	10.75
5825MHz	10.75
802.11ax HEW40-BF_Nss1,(MCS0)_4TX	
5190MHz	4.5
5230MHz	4.5
5755MHz	11
5795MHz	11
802.11ax HEW80-BF_Nss1,(MCS0)_4TX	
5210MHz	4.5
5775MHz	11



Sample 2_Radio 3_Omni_2T1S

Mode	Power Setting
802.11ac VHT20-BF_Nss1,(MCS0)_2TX	-
5180MHz	17
5200MHz	15
5240MHz	16.75
5745MHz	20
5785MHz	22
5825MHz	22
802.11ac VHT40-BF_Nss1,(MCS0)_2TX	
5190MHz	14
5230MHz	18
5755MHz	20.5
5795MHz	22
802.11ac VHT80-BF_Nss1,(MCS0)_2TX	
5210MHz	12.75
5775MHz	19
802.11ax HEW20-BF_Nss1,(MCS0)_2TX	
5180MHz	17
5200MHz	15
5240MHz	16.75
5745MHz	20
5785MHz	22
5825MHz	22
802.11ax HEW40-BF_Nss1,(MCS0)_2TX	
5190MHz	14
5230MHz	18
5755MHz	20.5
5795MHz	22
802.11ax HEW80-BF_Nss1,(MCS0)_2TX	
5210MHz	12.75
5775MHz	19



Sample 2_Radio 3_Panel 1_2T1S



Mode	Power Setting
802.11ac VHT20-BF_Nss1,(MCS0)_2TX	-
5180MHz	11
5200MHz	11
5240MHz	11
5745MHz	19.25
5785MHz	19.25
5825MHz	19.5
802.11ac VHT40-BF_Nss1,(MCS0)_2TX	
5190MHz	10.75
5230MHz	10.75
5755MHz	19.25
5795MHz	19.25
802.11ac VHT80-BF_Nss1,(MCS0)_2TX	
5210MHz	10.75
5775MHz	18.25
802.11ax HEW20-BF_Nss1,(MCS0)_2TX	
5180MHz	11
5200MHz	11
5240MHz	11
5745MHz	19.25
5785MHz	19.25
5825MHz	19.5
802.11ax HEW40-BF_Nss1,(MCS0)_2TX	
5190MHz	10.75
5230MHz	10.75
5755MHz	19.25
5795MHz	19.25
802.11ax HEW80-BF_Nss1,(MCS0)_2TX	
5210MHz	10.75
5775MHz	18.25

2.3 The Worst Case Measurement Configuration

The Worst Case Mode for Following Conformance Tests	
Tests Item	AC power-line conducted emissions
Condition	AC power-line conducted measurement for line and neutral
Operating Mode	CTX
1	PoE mode (Non-Beamforming_Sample 1_Radio2)
2	PoE mode (Non-Beamforming_Sample 1_Radio3)
3	PoE mode (Non-Beamforming_Sample 2_Radio2)
4	PoE mode (Non-Beamforming_Sample 2_Radio3)
5	PoE mode (Beamforming_Sample 1_Radio2)
6	PoE mode (Beamforming_Sample 1_Radio3)
7	PoE mode (Beamforming_Sample 2_Radio2)
8	PoE mode (Beamforming_Sample 2_Radio3)

The Worst Case Mode for Following Conformance Tests	
Tests Item	Emission Bandwidth Maximum Conducted Output Power Peak Power Spectral Density
Test Condition	Conducted measurement at transmit chains

The Worst Case Mode for Following Conformance Tests	
Tests Item	Unwanted Emissions
Test Condition	Radiated measurement If EUT consist of multiple antenna assembly (multiple antenna are used in EUT regardless of spatial multiplexing MIMO configuration), the radiated test should be performed with highest antenna gain of each antenna type.
Operating Mode < 1GHz	CTX
1	PoE Mode (Non-Beamforming_outdoor_Sample 1_Radio 2_1T1S)
2	PoE Mode (Non-Beamforming_outdoor_Sample 1_Radio 2_2T2S)
3	PoE Mode (Non-Beamforming_outdoor_Sample 1_Radio 2_4T1S)
4	PoE Mode (Non-Beamforming_outdoor_Sample 1_Radio 2_4T4S)
5	PoE Mode (Non-Beamforming_outdoor_Sample 1_Radio 3_1T1S)
6	PoE Mode (Non-Beamforming_outdoor_Sample 1_Radio 3_2T2S)
7	PoE Mode (Non-Beamforming_outdoor_Sample 2_Radio 2_Omni_1T1S)
8	PoE Mode (Non-Beamforming_outdoor_Sample 2_Radio 2_Omni_2T2S)
9	PoE Mode (Non-Beamforming_outdoor_Sample 2_Radio 2_Omni_4T1S)
10	PoE Mode (Non-Beamforming_outdoor_Sample 2_Radio 2_Omni_4T4S)

11	PoE Mode (Non-Beamforming_outdoor_Sample 2_Radio 2_Panel 1_1T1S)		
12	PoE Mode (Non-Beamforming_outdoor_Sample 2_Radio 2_Panel 1_2T2S)		
13	PoE Mode (Non-Beamforming_outdoor_Sample 2_Radio 2_Panel 1_4T1S)		
14	PoE Mode (Non-Beamforming_outdoor_Sample 2_Radio 2_Panel 1_4T4S)		
15	PoE Mode (Non-Beamforming_outdoor_Sample 2_Radio 3_Omni_1T1S)		
16	PoE Mode (Non-Beamforming_outdoor_Sample 2_Radio 3_Omni_2T2S)		
17	PoE Mode (Non-Beamforming_outdoor_Sample 2_Radio 3_Panel 1_1T1S)		
18	PoE Mode (Non-Beamforming_outdoor_Sample 2_Radio 3_Panel 1_2T2S)		
19	PoE Mode (Beamforming_outdoor_Sample 1_Radio 2_4T1S)		
20	PoE Mode (Beamforming_outdoor_Sample 1_Radio 3_2T1S)		
21	PoE Mode (Beamforming_outdoor_Sample 2_Radio 2_Omni_4T1S)		
22	PoE Mode (Beamforming_outdoor_Sample 2_Radio 2_Panel 1_4T1S)		
23	PoE Mode (Beamforming_outdoor_Sample 2_Radio 3_Omni_2T1S)		
24	PoE Mode (Beamforming_outdoor_Sample 2_Radio 3_Panel 1_2T1S)		
Operating Mode > 1GHz	CTX		
Orthogonal Planes of EUT	X Plane	Y Plane	Z Plane
			
Worst Planes of EUT	V	V	V

The Worst Case Mode for Following Conformance Tests	
Tests Item	Simultaneous Transmission Analysis
Operating Mode	CTX
1	WLAN 2.4G+ WLAN 5G+ WLAN 2.4G+Thread
2	WLAN 2.4G+ WLAN 5G+ WLAN 2.4G+BT
3	WLAN 2.4G+ WLAN 5G+ WLAN 5G+Thread
4	WLAN 2.4G+ WLAN 5G+ WLAN 5G+BT
Refer to Sporton Test Report No.: FA970235 for Co-location RF Exposure Evaluation.	

2.4 Support Equipment

Support Equipment – AC Conduction				
No.	Equipment	Brand Name	Model Name	FCC ID
1	Load	Sporton	-	-
2	LAN Cable	Power Sync	CAT-6E-01	-
3	LAN Cable	Power Sync	CAT-6E-10	-
4	PoE	EnGenius	EPA5006GP	-
5	AC Power Cable	-	-	-
6	Notebook (remote)	DELL	M-S69	-
7	LAN Cable(remote)	Power Sync	CAT-6E-01	-
8	Adapter for Notebook (remote)	DELL	M-S69	-

Note: Support equipment No.4, 5 were provided by customer.

Support Equipment – RF Conducted				
No.	Equipment	Brand Name	Model Name	FCC ID
1	Notebook	DELL	E5410	DoC
2	Adapter for NB	DELL	HA65NM130	DoC
3	Notebook	DELL	E5410	DoC
4	Adapter for NB	DELL	HA65NM130	DoC
5	PoE	EnGenius	EPA5006GP	-

Note: Support equipment No.5 was provided by customer.

Support Equipment – Radiated Emission				
No.	Equipment	Brand Name	Model Name	FCC ID
1	Load	Sporton	-	-
2	LAN Cable	Power Sync	CAT-6E-01	-
3	LAN Cable	Power Sync	CAT-6E-10	-
4	PoE (remote)	EnGenius	EPA5006GP	-
5	AC Power Cable (remote)	-	-	-
6	Notebook (remote)	DELL	M-S69	-
7	LAN Cable (remote)	Power Sync	CAT-6E-01	-
8	Adapter for Notebook (remote)	DELL	M-S69	-

Note: Support equipment No.4, 5 were provided by customer.

2.5 Test Setup Diagram

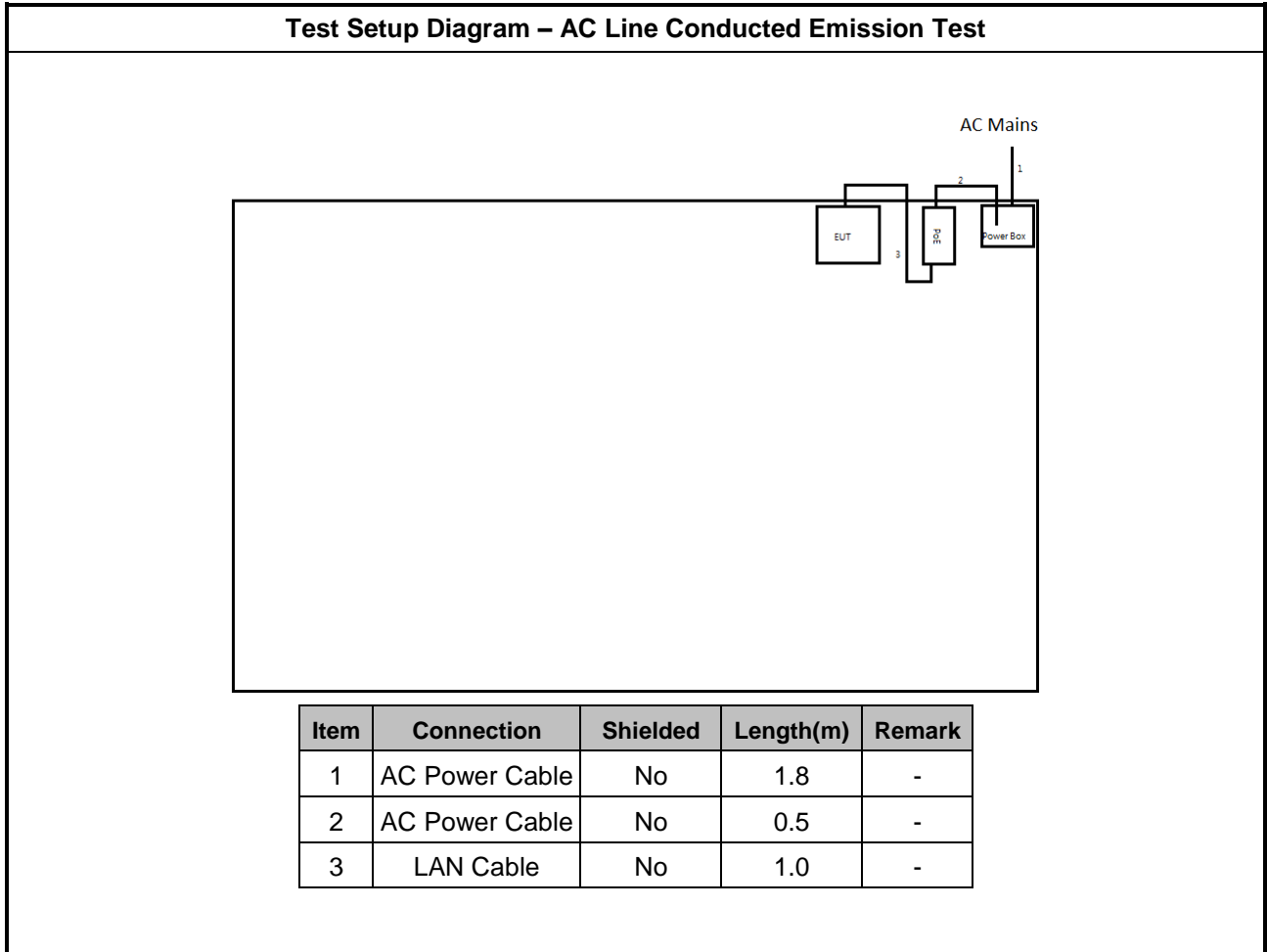

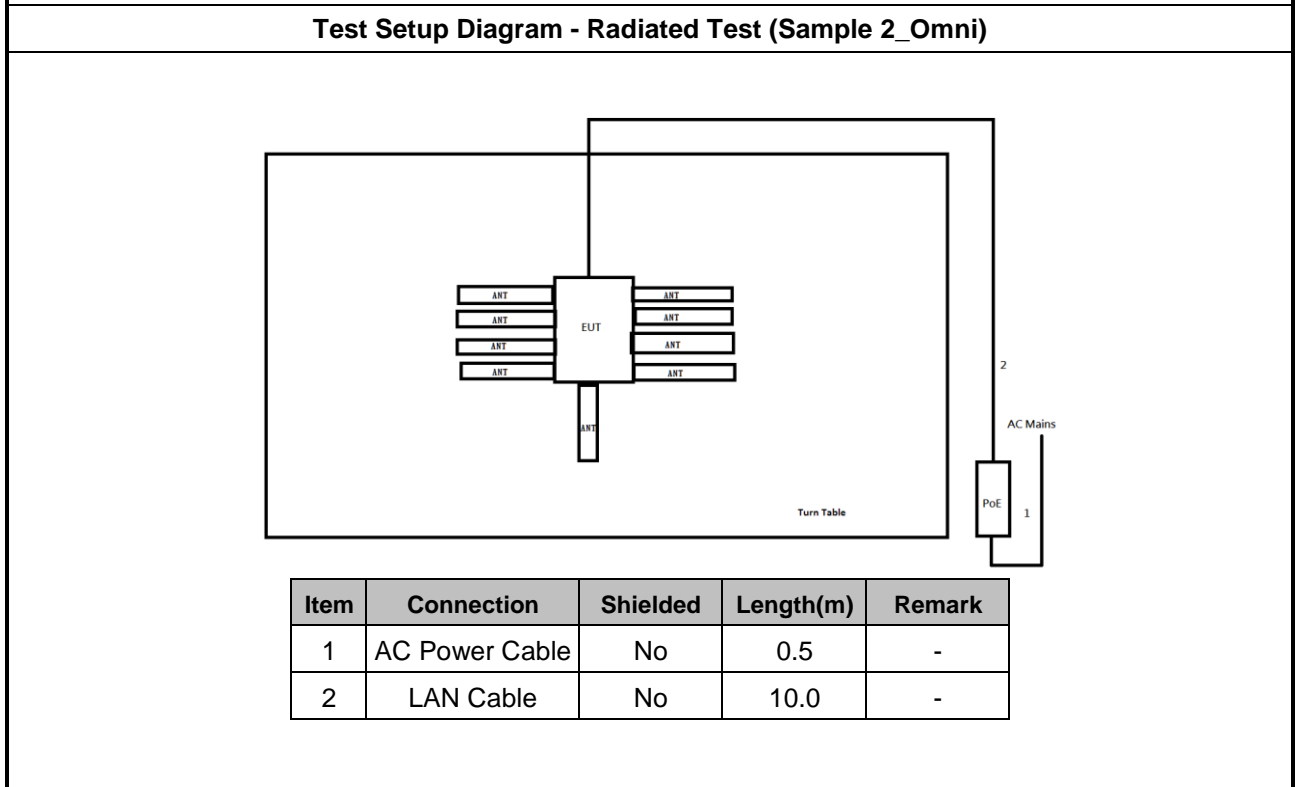
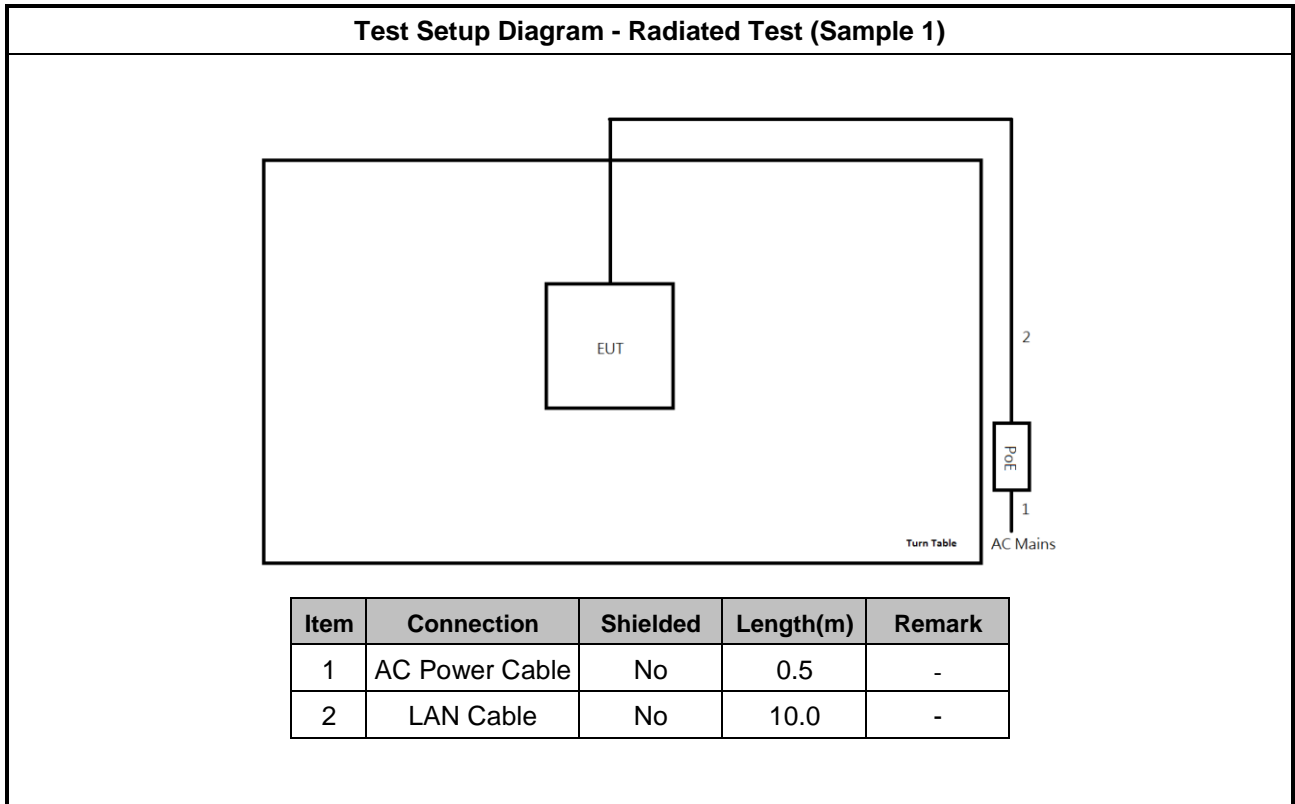

Test Setup Diagram - Radiated Test (Sample 2_Panel 1)

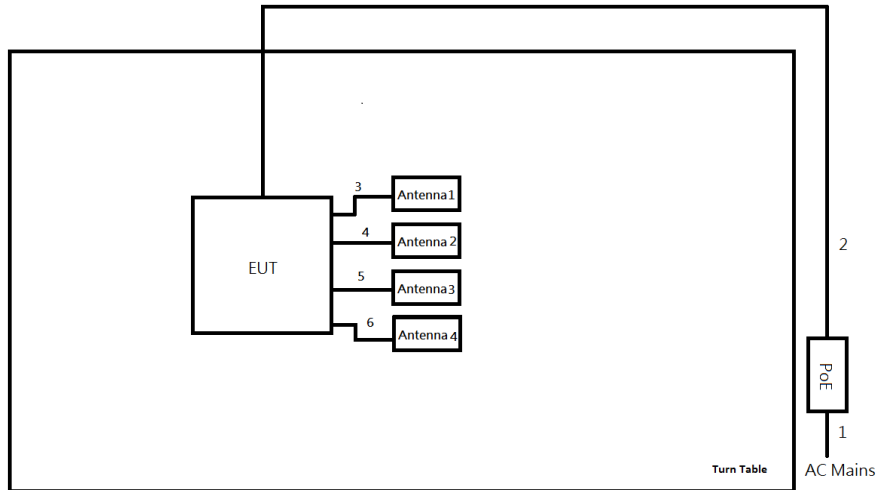

Item	Connection	Shielded	Length(m)	Remark
1	AC Power Cable	No	0.5	-
2	LAN Cable	No	10.0	-
3	Antenna Cable	No	0.5	-
4	Antenna Cable	No	0.5	-
5	Antenna Cable	No	0.5	-
6	Antenna Cable	No	0.5	-

Test Setup Diagram - Radiated Test (Sample 2_Panel 2)

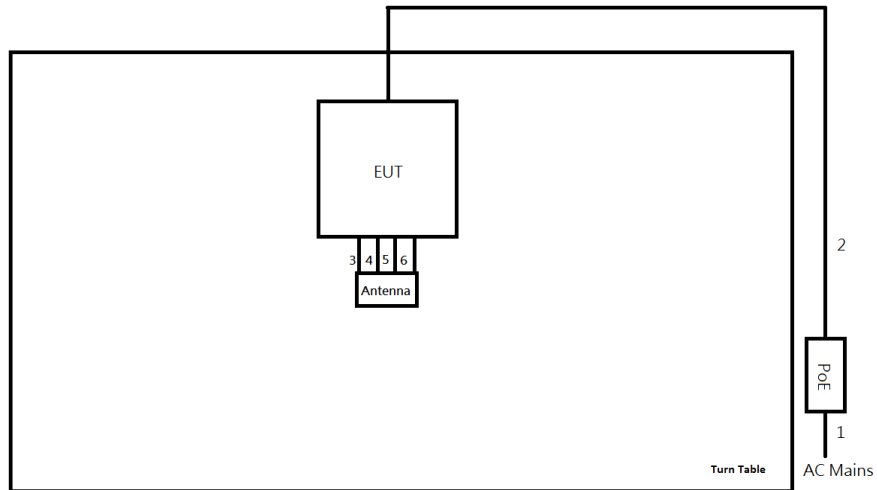

Item	Connection	Shielded	Length(m)	Remark
1	AC Power Cable	No	0.5	-
2	LAN Cable	No	10.0	-
3	Antenna Cable	No	0.5	-
4	Antenna Cable	No	0.5	-
5	Antenna Cable	No	0.5	-
6	Antenna Cable	No	0.5	-

3 Transmitter Test Result

3.1 AC Power-line Conducted Emissions

3.1.1 AC Power-line Conducted Emissions Limit

AC Power-line Conducted Emissions Limit		
Frequency Emission (MHz)	Quasi-Peak	Average
0.15-0.5	66 - 56 *	56 - 46 *
0.5-5	56	46
5-30	60	50

Note 1: * Decreases with the logarithm of the frequency.

3.1.2 Measuring Instruments

Refer a test equipment and calibration data table in this test report.

3.1.3 Test Procedures

Test Method
<input checked="" type="checkbox"/> Refer as ANSI C63.10-2013, clause 6.2 for AC power-line conducted emissions.

3.1.4 Test Setup

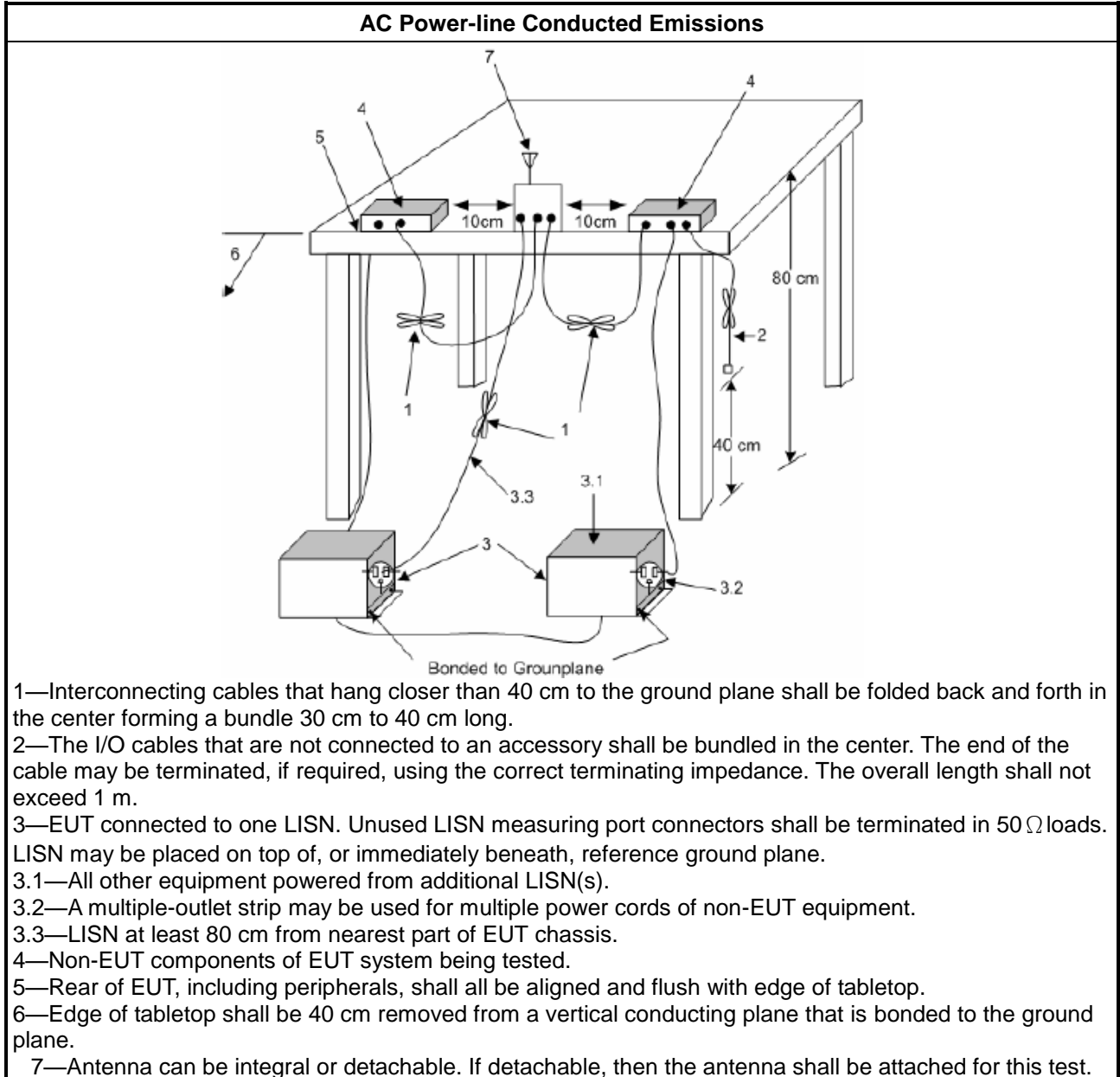

3.1.5 Test Result of AC Power-line Conducted Emissions

Refer as Appendix A

3.2 Emission Bandwidth

3.2.1 Emission Bandwidth Limit

Emission Bandwidth Limit	
UNII Devices	
<input checked="" type="checkbox"/>	For the 5.15-5.25 GHz band, N/A
<input type="checkbox"/>	For the 5.25-5.35 GHz band, N/A
<input type="checkbox"/>	For the 5.47-5.725 GHz band, N/A
<input checked="" type="checkbox"/>	For the 5.725-5.85 GHz band, 6 dB emission bandwidth \geq 500kHz.

3.2.2 Measuring Instruments

Refer a test equipment and calibration data table in this test report.

3.2.3 Test Procedures

Test Method	
<ul style="list-style-type: none"> ▪ For the emission bandwidth shall be measured using one of the options below: 	
<input checked="" type="checkbox"/>	Refer as KDB 789033, clause C for EBW and clause D for OBW measurement.
<input type="checkbox"/>	Refer as ANSI C63.10, clause 6.9.3 for occupied bandwidth testing.
<input type="checkbox"/>	Refer as IC RSS-Gen, clause 6.7 for bandwidth testing.

3.2.4 Test Setup

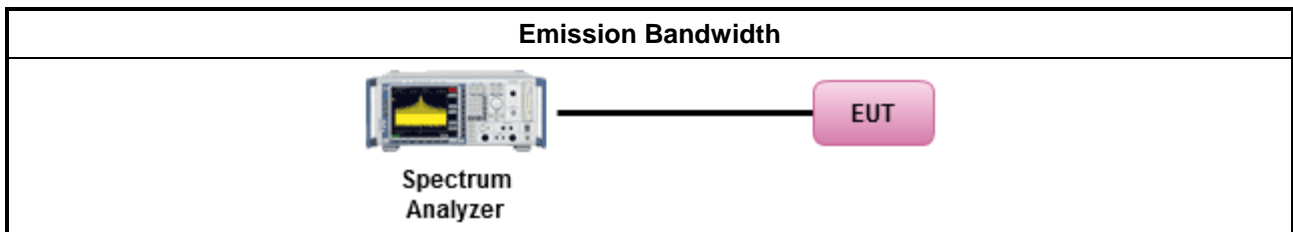

3.2.5 Test Result of Emission Bandwidth

Refer as Appendix B

3.3 Maximum Conducted Output Power

3.3.1 Maximum Conducted Output Power Limit

Maximum Conducted Output Power Limit	
UNII Devices	
<input checked="" type="checkbox"/> For the 5.15-5.25 GHz band:	
	<ul style="list-style-type: none"> ▪ Outdoor AP: the maximum conducted output power (P_{Out}) shall not exceed the lesser of 1 W. If $G_{TX} > 6$ dBi, then $P_{Out} = 30 - (G_{TX} - 6)$. e.i.r.p. at any elevation angle above 30 degrees $\leq 125mW$ [21dBm] ▪ Indoor AP: the maximum conducted output power (P_{Out}) shall not exceed the lesser of 1 W. If $G_{TX} > 6$ dBi, then $P_{Out} = 30 - (G_{TX} - 6)$ ▪ Point-to-point AP: the maximum conducted output power (P_{Out}) shall not exceed the lesser of 1 W. If $G_{TX} > 23$ dBi, then $P_{Out} = 30 - (G_{TX} - 23)$. ▪ Mobile or Portable Client: the maximum conducted output power (P_{Out}) shall not exceed the lesser of 250 mW. If $G_{TX} > 6$ dBi, then $P_{Out} = 24 - (G_{TX} - 6)$.
<input type="checkbox"/> For the 5.25-5.35 GHz band, the maximum conducted output power (P_{Out}) shall not exceed the lesser of 250 mW or $11 \text{ dBm} + 10 \log B$, where B is the 26 dB emission bandwidth in MHz. If $G_{TX} > 6$ dBi, then $P_{Out} = 24 - (G_{TX} - 6)$.	
<input type="checkbox"/> For the 5.47-5.725 GHz band, the maximum conducted output power (P_{Out}) shall not exceed the lesser of 250 mW or $11 \text{ dBm} + 10 \log B$, where B is the 26 dB emission bandwidth in MHz. If $G_{TX} > 6$ dBi, then $P_{Out} = 24 - (G_{TX} - 6)$.	
<input checked="" type="checkbox"/> For the 5.725-5.85 GHz band:	
	<ul style="list-style-type: none"> ▪ Point-to-multipoint systems (P2M): the maximum conducted output power (P_{Out}) shall not exceed the lesser of 1 W. If $G_{TX} > 6$ dBi, then $P_{Out} = 30 - (G_{TX} - 6)$. ▪ Point-to-point systems (P2P): the maximum conducted output power (P_{Out}) shall not exceed the lesser of 1 W.
P_{Out} = maximum conducted output power in dBm, G_{TX} = the maximum transmitting antenna directional gain in dBi.	

3.3.2 Measuring Instruments

Refer a test equipment and calibration data table in this test report.

3.3.3 Test Procedures

Test Method	
<ul style="list-style-type: none"> Maximum Conducted Output Power 	
	Duty cycle ≥ 98%
<input type="checkbox"/>	Refer as KDB 789033, clause E Method SA-2 (spectral trace averaging).
	Duty cycle < 98%
<input type="checkbox"/>	Refer as KDB 789033, clause E Method SA-2 Alt. (RMS detection with slow sweep speed)
	Wideband RF power meter and average over on/off periods with duty factor
<input checked="" type="checkbox"/>	Refer as KDB 789033, clause E Method PM (using an RF average power meter).
<ul style="list-style-type: none"> For conducted measurement. 	
	<ul style="list-style-type: none"> If the EUT supports multiple transmit chains using options given below: Refer as KDB 662911, In-band power measurements. Using the measure-and-sum approach, measured all transmit ports individually. Sum the power (in linear power units e.g., mW) of all ports for each individual sample and save them.
	<ul style="list-style-type: none"> If multiple transmit chains, EIRP calculation could be following as methods: $P_{total} = P_1 + P_2 + \dots + P_n$ (calculated in linear unit [mW] and transfer to log unit [dBm]) $EIRP_{total} = P_{total} + DG$

3.3.4 Test Setup

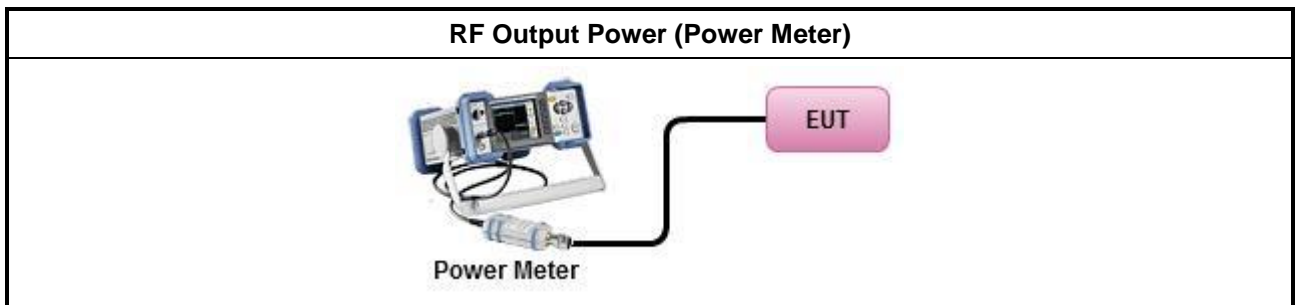

3.3.5 Test Result of Maximum Conducted Output Power

Refer as Appendix C

3.4 Peak Power Spectral Density

3.4.1 Peak Power Spectral Density Limit

Peak Power Spectral Density Limit	
UNII Devices	
<input checked="" type="checkbox"/> For the 5.15-5.25 GHz band:	
<input type="checkbox"/>	<ul style="list-style-type: none"> ▪ Outdoor AP: the peak power spectral density (PPSD) shall not exceed the lesser of 17dBm/MHz. If $G_{TX} > 6$ dBi, then $P_{Out} = 17 - (G_{TX} - 6)$. ▪ Indoor AP: the peak power spectral density (PPSD) shall not exceed the lesser of 17dBm/MHz. If $G_{TX} > 6$ dBi, then $P_{Out} = 17 - (G_{TX} - 6)$. ▪ Point-to-point AP: the peak power spectral density (PPSD) shall not exceed the lesser of 17dBm/MHz. If $G_{TX} > 23$ dBi, then $P_{Out} = 17 - (G_{TX} - 23)$. ▪ Mobile or Portable Client: the peak power spectral density (PPSD) ≤ 11 dBm/MHz. If $G_{TX} > 6$ dBi, then $PPSD = 11 - (G_{TX} - 6)$.
<input type="checkbox"/> For the 5.25-5.35 GHz band, the peak power spectral density (PPSD) ≤ 11 dBm/MHz. If $G_{TX} > 6$ dBi, then $PPSD = 11 - (G_{TX} - 6)$.	
<input type="checkbox"/> For the 5.47-5.725 GHz band, the peak power spectral density (PPSD) ≤ 11 dBm/MHz. If $G_{TX} > 6$ dBi, then $PPSD = 11 - (G_{TX} - 6)$.	
<input checked="" type="checkbox"/> For the 5.725-5.85 GHz band:	
<input type="checkbox"/>	<ul style="list-style-type: none"> ▪ Point-to-multipoint systems (P2M): the peak power spectral density (PPSD) ≤ 30 dBm/500kHz. If $G_{TX} > 6$ dBi, then $PPSD = 30 - (G_{TX} - 6)$. ▪ Point-to-point systems (P2P): the peak power spectral density (PPSD) ≤ 30 dBm/500kHz.
<p>PPSD = peak power spectral density that he same method as used to determine the conducted output power shall be used to determine the power spectral density. And power spectral density in dBm/MHz</p> <p>G_{TX} = the maximum transmitting antenna directional gain in dBi.</p>	

3.4.2 Measuring Instruments

Refer a test equipment and calibration data table in this test report.

3.4.3 Test Procedures

Test Method	
<ul style="list-style-type: none"> ▪ Peak power spectral density procedures that the same method as used to determine the conducted output power shall be used to determine the peak power spectral density and use the peak search function on the spectrum analyzer to find the peak of the spectrum. For the peak power spectral density shall be measured using below options: 	
<input type="checkbox"/>	Refer as KDB 789033, F)5) power spectral density can be measured using resolution bandwidths < 1 MHz provided that the results are integrated over 1 MHz bandwidth
Duty cycle ≥ 98%	
<input type="checkbox"/>	Refer as KDB 789033, clause E Method SA-2 (spectral trace averaging).
Duty cycle < 98%	
<input checked="" type="checkbox"/>	Refer as KDB 789033, clause E Method SA-2 Alt. (RMS detection with slow sweep speed)
<ul style="list-style-type: none"> ▪ For conducted measurement. 	
<ul style="list-style-type: none"> ▪ If the EUT supports multiple transmit chains using options given below: <ul style="list-style-type: none"> ▪ Measure and sum the spectra across the outputs. Refer as KDB 662911, In-band power spectral density (PSD). Sample all transmit ports simultaneously using a spectrum analyzer for each transmit port. Where the trace bin-by-bin of each transmit port summing can be performed. (i.e., in the first spectral bin of output 1 is summed with that in the first spectral bin of output 2 and that from the first spectral bin of output 3, and so on up to the NTX output to obtain the value for the first frequency bin of the summed spectrum.). Add up the amplitude (power) values for the different transmit chains and use this as the new data trace. ▪ If multiple transmit chains, EIRP PPSD calculation could be following as methods: $PPSD_{total} = PPSD_1 + PPSD_2 + \dots + PPSD_n$ (calculated in linear unit [mW] and transfer to log unit [dBm]) $EIRP_{total} = PPSD_{total} + DG$ 	

3.4.4 Test Setup

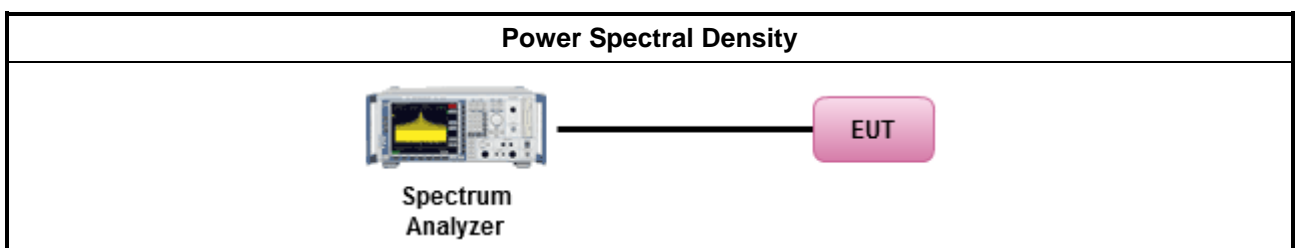

3.4.5 Test Result of Peak Power Spectral Density

Refer as Appendix D

3.5 Unwanted Emissions

3.5.1 Transmitter Radiated Unwanted Emissions Limit

Unwanted emissions below 1 GHz and restricted band emissions above 1GHz limit			
Frequency Range (MHz)	Field Strength (uV/m)	Field Strength (dBuV/m)	Measure Distance (m)
0.009~0.490	2400/F(kHz)	48.5 - 13.8	300
0.490~1.705	24000/F(kHz)	33.8 - 23	30
1.705~30.0	30	29	30
30~88	100	40	3
88~216	150	43.5	3
216~960	200	46	3
Above 960	500	54	3

Note 1: Test distance for frequencies at or above 30 MHz, measurements may be performed at a distance other than the limit distance provided they are not performed in the near field and the emissions to be measured can be detected by the measurement equipment. When performing measurements at a distance other than that specified, the results shall be extrapolated to the specified distance using an extrapolation factor of 20 dB/decade (inverse of linear distance for field-strength measurements, inverse of linear distance-squared for power-density measurements).

Note 2: Test distance for frequencies at below 30 MHz, measurements may be performed at a distance closer than the EUT limit distance; however, an attempt should be made to avoid making measurements in the near field. When performing measurements below 30 MHz at a closer distance than the limit distance, the results shall be extrapolated to the specified distance by either making measurements at a minimum of two or more distances on at least one radial to determine the proper extrapolation factor or by using the square of an inverse linear distance extrapolation factor (40 dB/decade). The test report shall specify the extrapolation method used to determine compliance of the EUT.

Note 3: Using the distance of 1m during the test for above 18 GHz, and the test value to correct for the distance factor at 3m.

Un-restricted band emissions above 1GHz Limit	
Operating Band	Limit
5.15 - 5.25 GHz	e.i.r.p. -27 dBm [68.2 dBuV/m@3m]
5.25 - 5.35 GHz	e.i.r.p. -27 dBm [68.2 dBuV/m@3m]
5.47 - 5.725 GHz	e.i.r.p. -27 dBm [68.2 dBuV/m@3m]
5.725 - 5.85 GHz	5.650-5700 GHz: e.i.r.p. -27 ~ 10 dBm [68.2 ~ 105.2 dBuV/m@3m] 5.700-5720 GHz: e.i.r.p. 10 ~ 15.6 dBm [105.2 ~ 110.8 dBuV/m@3m] 5.720-5725 GHz: e.i.r.p. 15.6 ~ 27 dBm [110.8 ~ 122.2 dBuV/m@3m] 5.850-5.855 GHz: e.i.r.p. 27 ~ 15.6 dBm [122.2 ~ 110.8 dBuV/m@3m] 5.855-5.875 GHz: e.i.r.p. 15.6 ~ 10 dBm [110.8 ~ 105.2 dBuV/m@3m] 5.875-5.925 GHz: e.i.r.p. 10 ~ -27 dBm [105.2 ~ 68.2dBuV/m@3m] Other un-restricted band: e.i.r.p. -27 dBm [68.2 dBuV/m@3m]
Note 1: Measurements may be performed at a distance other than the limit distance provided they are not performed in the near field and the emissions to be measured can be detected by the measurement equipment. When performing measurements at a distance other than that specified, the results shall be extrapolated to the specified distance using an extrapolation factor of 20 dB/decade (inverse of linear distance for field-strength measurements, inverse of linear distance-squared for power-density measurements).	

3.5.2 Measuring Instruments

Refer a test equipment and calibration data table in this test report.

3.5.3 Test Procedures

Test Method	
<ul style="list-style-type: none"> ▪ Measurements may be performed at a distance other than the limit distance provided they are not performed in the near field and the emissions to be measured can be detected by the measurement equipment. Measurements shall not be performed at a distance greater than 30 m for frequencies above 30 MHz, unless it can be further demonstrated that measurements at a distance of 30 m or less are impractical. When performing measurements at a distance other than that specified, the results shall be extrapolated to the specified distance using an extrapolation factor of 20 dB/decade (inverse of linear distance for field-strength measurements, inverse of linear distance-squared for power-density measurements). 	
<ul style="list-style-type: none"> ▪ The average emission levels shall be measured in [duty cycle \geq 98 or duty factor]. 	
<ul style="list-style-type: none"> ▪ For the transmitter unwanted emissions shall be measured using following options below: 	
	<ul style="list-style-type: none"> ▪ Refer as KDB 789033, clause G)2) for unwanted emissions into non-restricted bands.
	<ul style="list-style-type: none"> ▪ Refer as KDB 789033, clause G)1) for unwanted emissions into restricted bands.
	<input checked="" type="checkbox"/> Refer as KDB 789033, G)6) Method VB (ANSI C63.10, clause 4.1.4.2.3), Reduced VBW.
	<input checked="" type="checkbox"/> Refer as KDB 789033, clause G)5) (ANSI C63.10, clause 4.1.4.2.2), measurement procedure peak limit.
<ul style="list-style-type: none"> ▪ For radiated measurement. 	
	<ul style="list-style-type: none"> ▪ Refer as ANSI C63.10, clause 6.4 for radiated emissions below 30 MHz and test distance is 3m.
	<ul style="list-style-type: none"> ▪ Refer as ANSI C63.10, clause 6.5 for radiated emissions 30 MHz to 1 GHz and test distance is 3m.
	<ul style="list-style-type: none"> ▪ Refer as ANSI C63.10, clause 6.6 for radiated emissions above 1GHz.
<ul style="list-style-type: none"> ▪ The any unwanted emissions level shall not exceed the fundamental emission level. 	
<ul style="list-style-type: none"> ▪ All amplitude of spurious emissions that are attenuated by more than 20 dB below the permissible value has no need to be reported. 	

3.5.4 Test Setup

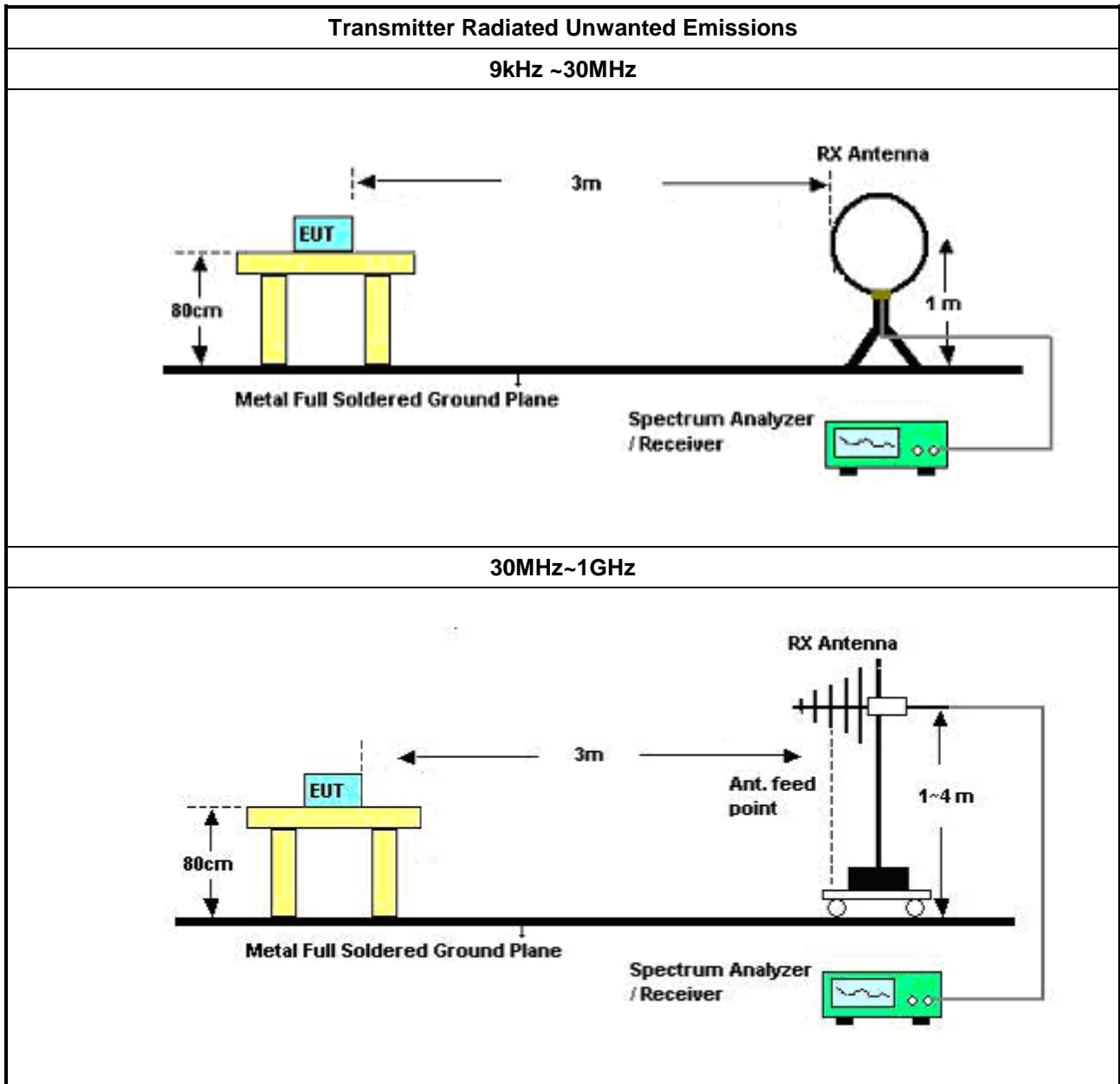

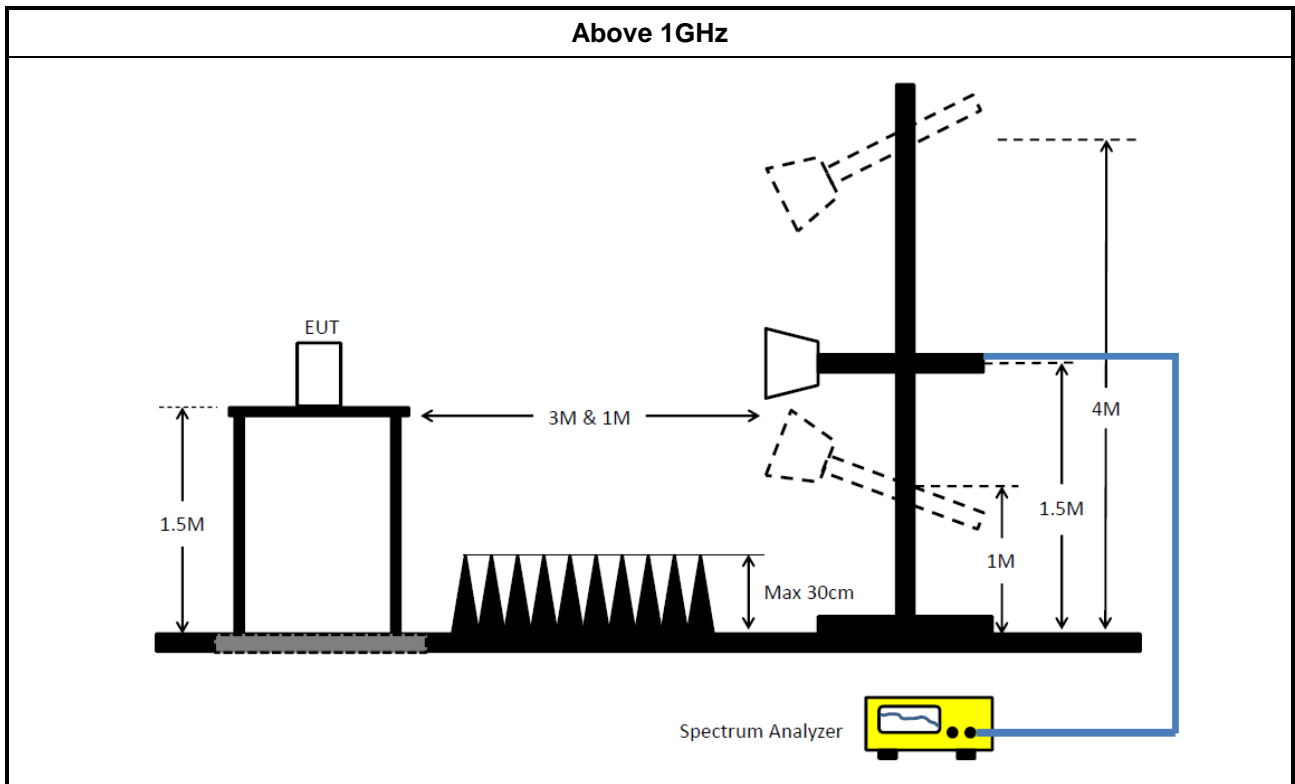

3.5.5 Transmitter Unwanted Emissions (Below 30MHz)

The amplitude of spurious emissions which are attenuated by more than 20dB below the permissible value has no need to be reported.

3.5.6 Test Result of Transmitter Unwanted Emissions

Refer as Appendix E

4 Test Equipment and Calibration Data

Instrument for AC Conduction

Instrument	Manufacturer	Model No.	Serial No.	Spec.	Calibration Date	Calibration Due Date
EMC Receiver	R&S	ESR3	102052	9kHz ~ 3.6GHz	09/Apr/2019	08/Apr/2020
LISN	R&S	ENV216	101295	9kHz ~ 30MHz	05/Nov/2019	04/Nov/2020
RF Cable-CON	MTJ	RG142	CB002-CO	9kHz ~ 200MHz	12/Sep/2019	11/Sep/2020
AC POWER	APC	AFC-11005G	F310050055	47Hz~63Hz 5~300V	NCR	NCR
Impuls Begrenzer Pulse Limiter	SCHWARZBECK	VTSD 9561-F	9561-F041	9 kHz ~ 30 MHz	24/Sep/2019	23/Sep/2020

NCR : Non-Calibration Require

Instrument for Conducted Test

Instrument	Manufacturer	Model No.	Serial No.	Spec.	Calibration Date	Calibration Due Date
Spectrum Analyzer	R&S	FSV 40	101013	10Hz~40GHz	13/Mar/2019	12/Mar/2020
SMB100A Signal Generator	R&S	SMB100A03	181147	100kHz~40GHz	12/Nov/2018	10/Nov/2020
Power Sensor	Anritsu	MA2411B	0917017	300MHz ~ 40GHz	19/Feb/2019	18/Feb/2020
Power Meter	Anritsu	ML2495A	0949003	300MHz ~ 40GHz	19/Feb/2019	18/Feb/2020
Cable 0.2m	HUBER	MY10710/4	RF Cable - 01	30MHz~18G	11/Jan/2019	10/Jan/2020
Cable 0.2m	HUBER	MY10711/4	RF Cable - 02	30MHz~18G	11/Jan/2019	10/Jan/2020
Cable 0.5m	HUBER	MY10714/4	RF Cable - 05	30MHz~1G	11/Jan/2019	10/Jan/2020



Instrument for Radiated Test

Instrument	Manufacturer	Model No.	Serial No.	Spec.	Calibration Date	Calibration Due Date
3m Semi Anechoic Chamber	SIDT FRANKONIA	SAC-3M	03CH03-HY	30MHz ~ 1GHz 3m	30/Aug/2019	29/Aug/2020
3m Semi Anechoic Chamber	SIDT FRANKONIA	SAC-3M	03CH03-HY	1GHz ~ 18GHz 3m	30/Aug/2019	29/Aug/2020
Amplifier	HP	8447D	2944A08033	10kHz ~ 1.3GHz	22/Apr/2019	21/Apr/2020
EMI Test Receiver	R&S	ESR3	102052	9kHz ~ 3.6GHz	09/Apr/2019	08/Apr/2020
Bilog Antenna & 5db Attenuator	SCHAFFNER/MTJ	CBL6112D / MTJ6102-05	2678 / 001	30MHz ~ 2GHz	06/Jul/2019	05/Jul/2020
Bilog Antenna & 5dB Attenuator	SCHAFFNER / MTJ	CBL 6112B / MTJ6102-05	2723 / 2	30MHz ~ 2GHz	11/Oct/2019	10/Oct/2020
Microwave Preamplifier	Agilent	8449B	3008A02373	1GHz ~ 26.5GHz	23/Oct/2018	22/Oct/2019
Microwave System Preamplifier	KEYSIGHT	83017A	MY53270196	1GHz ~ 26.5GHz	09/Sep/2019	08/Sep/2020
Signal Analyzer	R&S	FSP40	100305	9 kHz ~ 40 GHz;-140+30dBm	10/Jun/2019	09/Jun/2020
RF Cable-R03m	Jye Bao	RG142	CB021	9kHz ~ 1GHz	22/Mar/2019	21/Mar/2020
RF CABLE 6m	HUBER+SUHNER	SUOFLEX 104	SN 805801/4	1GHz ~ 40GHz	21/Mar/2019	20/Mar/2020
RF CABLE	HUBER+SUHNER	SUOFLEX 104	802378/4	1 GHz ~ 18 GHz	04/Jul/2019	03/Jul/2020
Broadband Horn Antenna	SCHWARZBECK	BBHA 9170	BBHA 9170221	15GHz ~ 40GHz	22/Mar/2019	21/Mar/2020
Double Ridged Guide Horn Antenna	SCHWARZBECK	BBHA 9120 D	BBHA 9120 D 1531	1GHz ~ 18GHz	09/Mar/2019	08/Mar/2020
Loop Antenna	TESEQ	HLA 6120	31244	9k-30MHz	15/Mar/2019	14/Mar/2020



AC Power-line Conducted Emissions_ Non Beamforming_Sample 1_Radio2

Appendix A.1

AC Power-line Conducted Emissions Result

Operating Mode	1	Power Phase	Neutral
Operating Function	Non Beamforming ; Sample 1 ; PoE mode ; Radio2 WIFI 5G TX		

08/11/2019

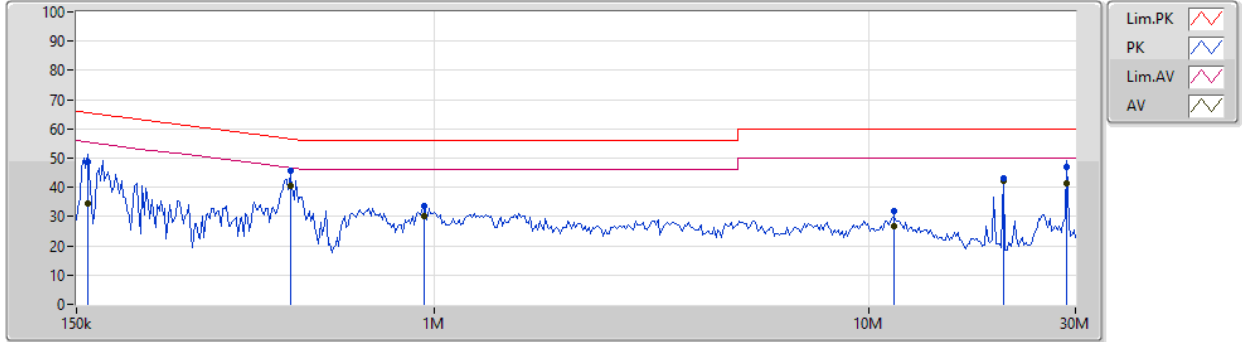

Type	Freq (Hz)	Level (dBuV)	Limit (dBuV)	Margin (dB)	Factor (dB)	Condition	Comment	Raw (dBuV)	LISN (dB)	CL (dB)	AT (dB)
QP	159.228k	48.70	65.50	-16.80	19.48	Neutral	-	29.22	9.60	0.01	9.87
AV	159.228k	34.30	55.50	-21.20	19.48	Neutral	-	14.82	9.60	0.01	9.87
QP	466.367k	45.62	56.57	-10.95	19.48	Neutral	-	26.14	9.59	0.01	9.88
AV	466.367k	40.63	46.57	-5.94	19.48	Neutral	"Worst"	21.15	9.59	0.01	9.88
QP	945.247k	33.80	56.00	-22.20	19.49	Neutral	-	14.31	9.59	0.02	9.88
AV	945.247k	30.15	46.00	-15.85	19.49	Neutral	-	10.66	9.59	0.02	9.88
QP	11.487M	31.69	60.00	-28.31	19.64	Neutral	-	12.05	9.67	0.08	9.89
AV	11.487M	26.77	50.00	-23.23	19.64	Neutral	-	7.13	9.67	0.08	9.89
QP	20.457M	43.05	60.00	-16.95	19.69	Neutral	-	23.36	9.68	0.11	9.90
AV	20.457M	42.16	50.00	-7.84	19.69	Neutral	-	22.47	9.68	0.11	9.90
QP	28.693M	46.93	60.00	-13.07	19.70	Neutral	-	27.23	9.67	0.13	9.90
AV	28.693M	41.48	50.00	-8.52	19.70	Neutral	-	21.78	9.67	0.13	9.90



AC Power-line Conducted Emissions_
Non Beamforming_Sample 1_Radio2

Appendix A.1

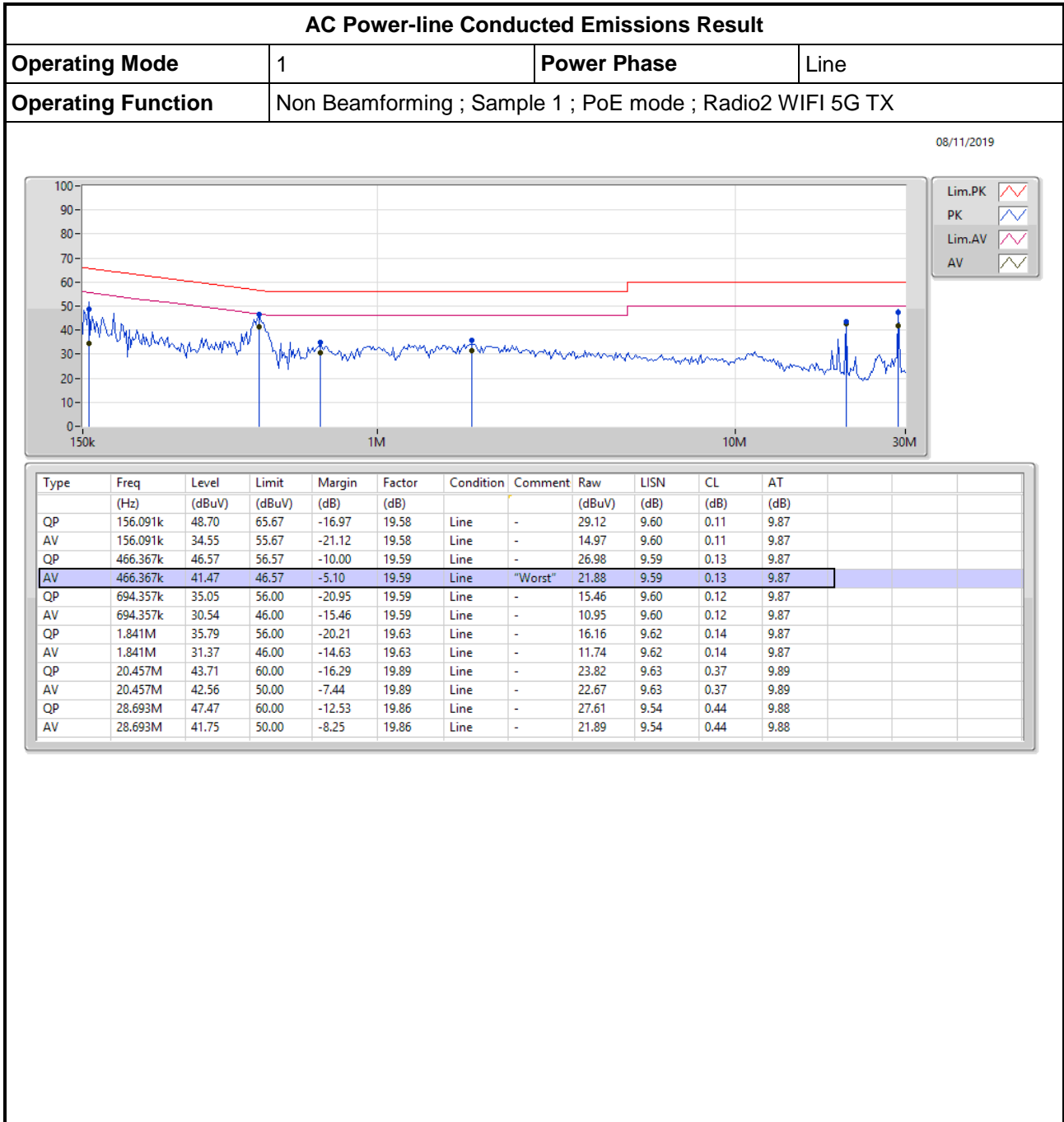



AC Power-line Conducted Emissions_
Non Beamforming_Sample 1_Radio3

Appendix A.2

AC Power-line Conducted Emissions Result

Operating Mode	2	Power Phase	Neutral
Operating Function	Non Beamforming ; Sample 1 ; PoE mode; Radio3 WIFI 5G TX		

08/11/2019

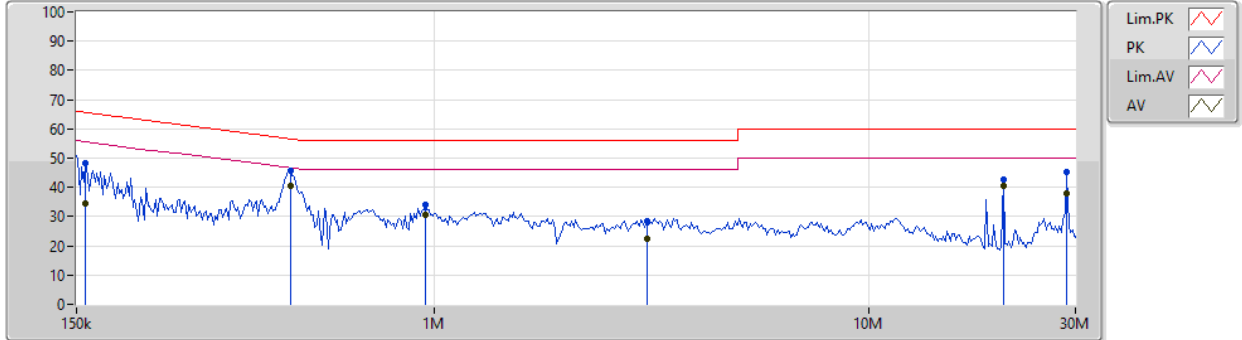

Type	Freq (Hz)	Level (dBuV)	Limit (dBuV)	Margin (dB)	Factor (dB)	Condition	Comment	Raw (dBuV)	LISN (dB)	CL (dB)	AT (dB)
QP	157.652k	48.49	65.58	-17.09	19.58	Neutral	-	28.91	9.60	0.11	9.87
AV	157.652k	34.41	55.58	-21.17	19.58	Neutral	-	14.83	9.60	0.11	9.87
QP	466.367k	45.82	56.57	-10.75	19.59	Neutral	-	26.23	9.59	0.13	9.87
AV	466.367k	40.63	46.57	-5.94	19.59	Neutral	"Worst"	21.04	9.59	0.13	9.87
QP	954.7k	33.84	56.00	-22.16	19.58	Neutral	-	14.26	9.59	0.11	9.88
AV	954.7k	30.51	46.00	-15.49	19.58	Neutral	-	10.93	9.59	0.11	9.88
QP	3.089M	28.41	56.00	-27.59	19.66	Neutral	-	8.75	9.61	0.17	9.88
AV	3.089M	22.35	46.00	-23.65	19.66	Neutral	-	2.69	9.61	0.17	9.88
QP	20.457M	42.62	60.00	-17.38	19.94	Neutral	-	22.68	9.68	0.37	9.89
AV	20.457M	40.51	50.00	-9.49	19.94	Neutral	-	20.57	9.68	0.37	9.89
QP	28.693M	45.13	60.00	-14.87	19.99	Neutral	-	25.14	9.67	0.44	9.88
AV	28.693M	37.93	50.00	-12.07	19.99	Neutral	-	17.94	9.67	0.44	9.88



AC Power-line Conducted Emissions_
Non Beamforming_Sample 1_Radio3

Appendix A.2

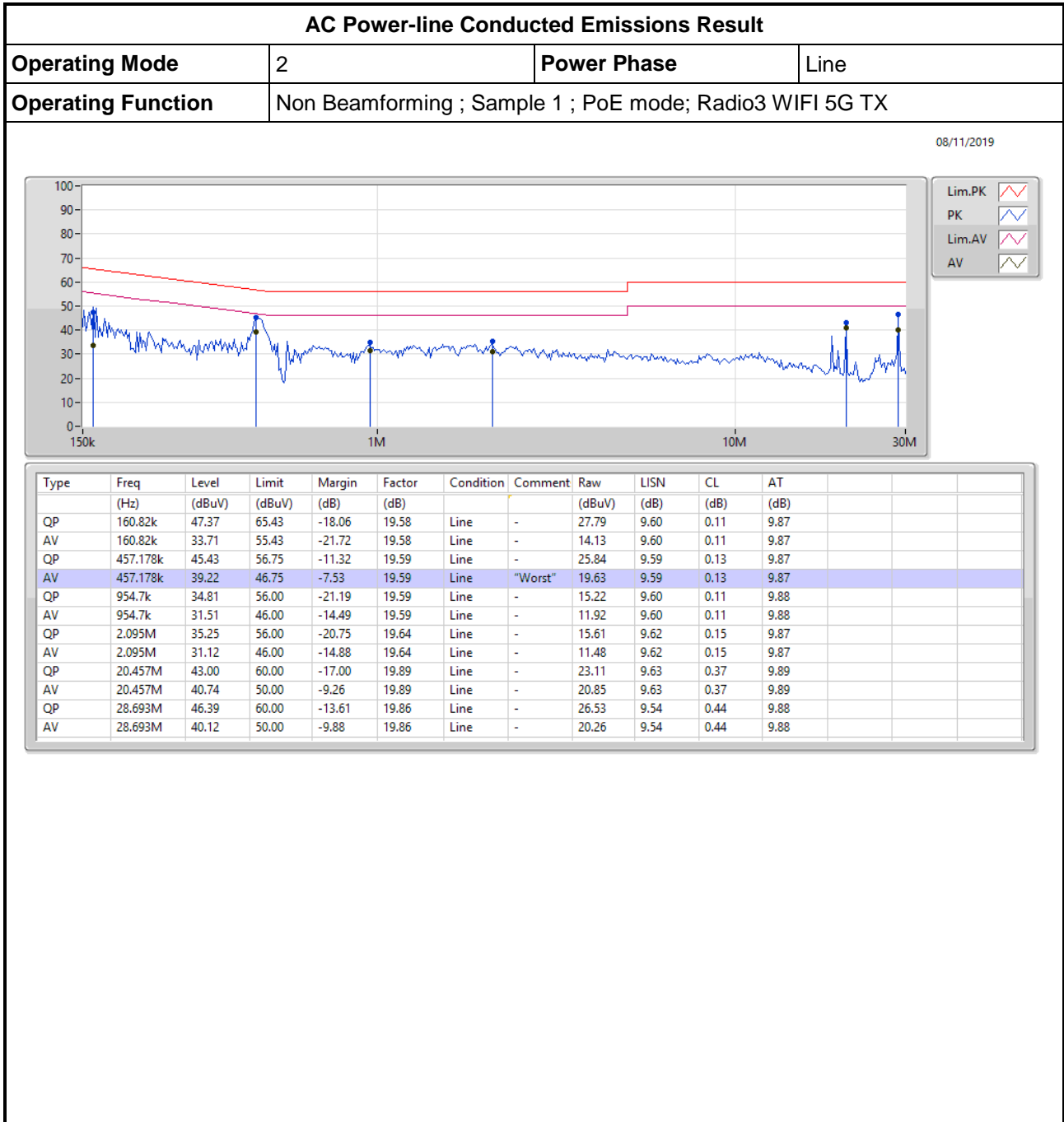



AC Power-line Conducted Emissions_
Non Beamforming_Sample 2_Radio2

Appendix A.3

AC Power-line Conducted Emissions Result

Operating Mode	3	Power Phase	Neutral
Operating Function	Non Beamforming ; Sample 2 ; PoE mode; Radio2 WIFI 5G TX		

11/11/2019

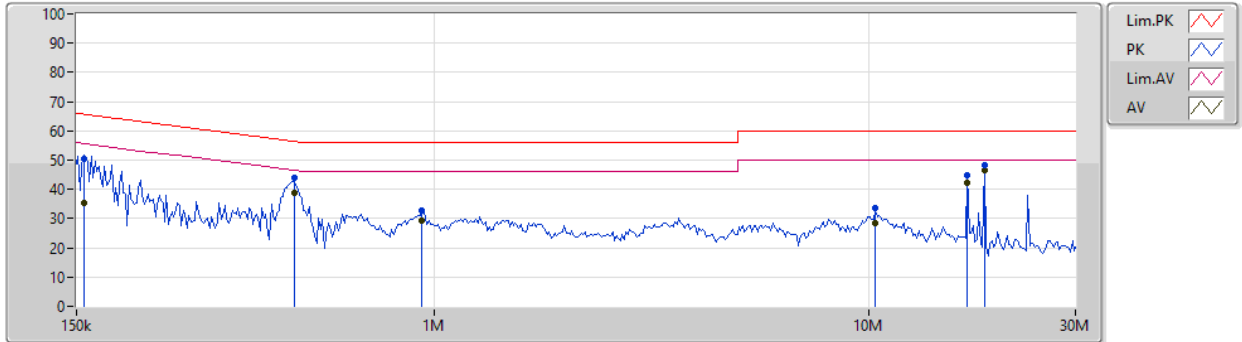

Type	Freq (Hz)	Level (dBuV)	Limit (dBuV)	Margin (dB)	Factor (dB)	Condition	Comment	Raw (dBuV)	LISN (dB)	CL (dB)	AT (dB)
QP	156.091k	50.51	65.67	-15.16	19.58	Neutral	-	30.93	9.60	0.11	9.87
AV	156.091k	35.16	55.67	-20.51	19.58	Neutral	-	15.58	9.60	0.11	9.87
QP	475.741k	43.78	56.42	-12.64	19.59	Neutral	-	24.19	9.59	0.13	9.87
AV	475.741k	38.63	46.42	-7.79	19.59	Neutral	-	19.04	9.59	0.13	9.87
QP	935.888k	32.73	56.00	-23.27	19.58	Neutral	-	13.15	9.59	0.11	9.88
AV	935.888k	29.19	46.00	-16.81	19.58	Neutral	-	9.61	9.59	0.11	9.88
QP	10.399M	33.67	60.00	-26.33	19.82	Neutral	-	13.85	9.67	0.27	9.88
AV	10.399M	28.53	50.00	-21.47	19.82	Neutral	-	8.71	9.67	0.27	9.88
QP	16.933M	44.68	60.00	-15.32	19.89	Neutral	-	24.79	9.68	0.33	9.88
AV	16.933M	42.10	50.00	-7.90	19.89	Neutral	-	22.21	9.68	0.33	9.88
QP	18.52M	48.46	60.00	-11.54	19.92	Neutral	-	28.54	9.68	0.35	9.89
AV	18.52M	46.64	50.00	-3.36	19.92	Neutral	"Worst"	26.72	9.68	0.35	9.89



AC Power-line Conducted Emissions_
Non Beamforming_Sample 2_Radio2

Appendix A.3

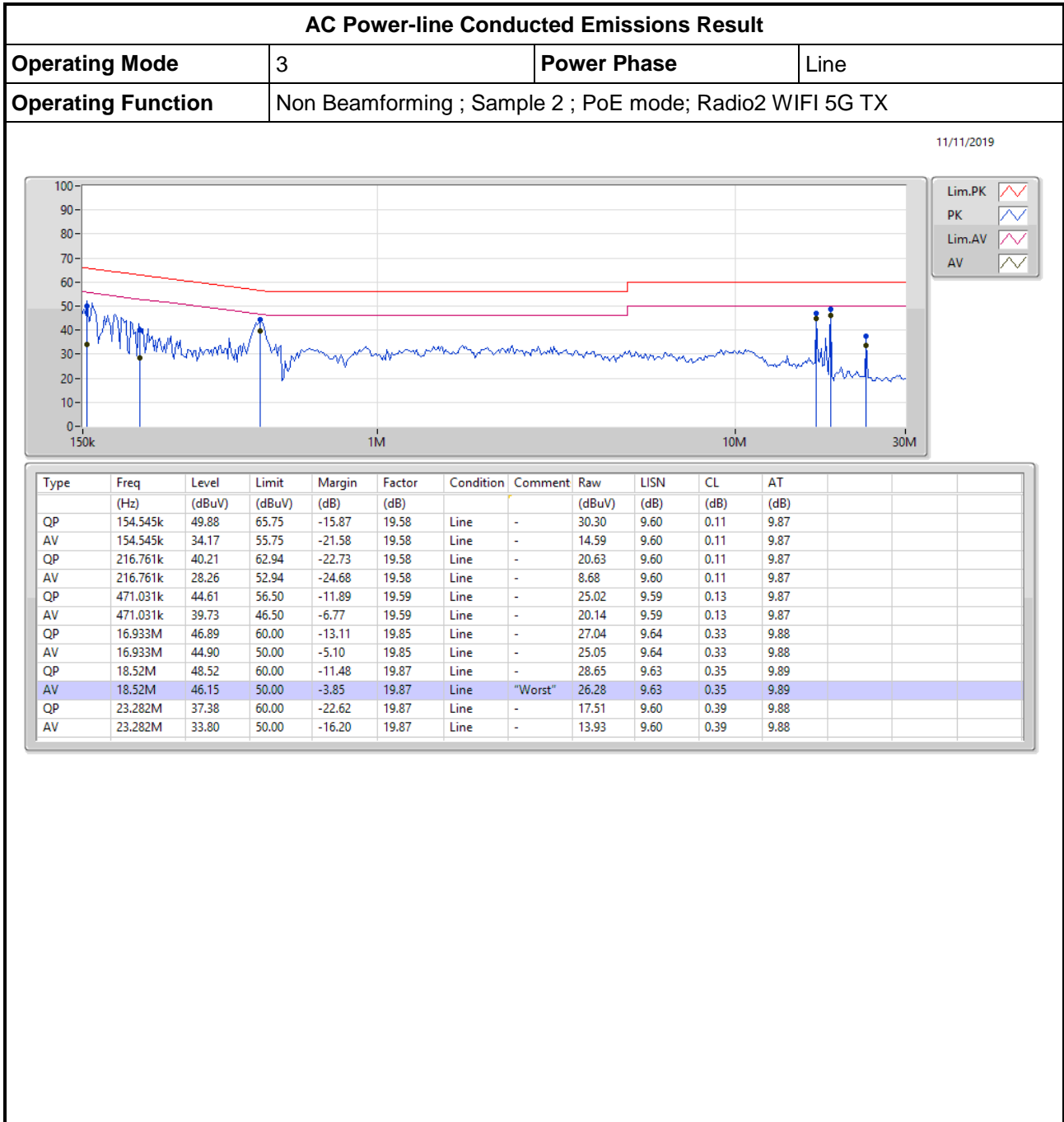



AC Power-line Conducted Emissions_
Non Beamforming_Sample 2_ Radio3

Appendix A.4

AC Power-line Conducted Emissions Result

Operating Mode	4	Power Phase	Neutral
Operating Function	Non Beamforming ; Sample 2; PoE mode; Radio3 WIFI 5G TX		

11/11/2019

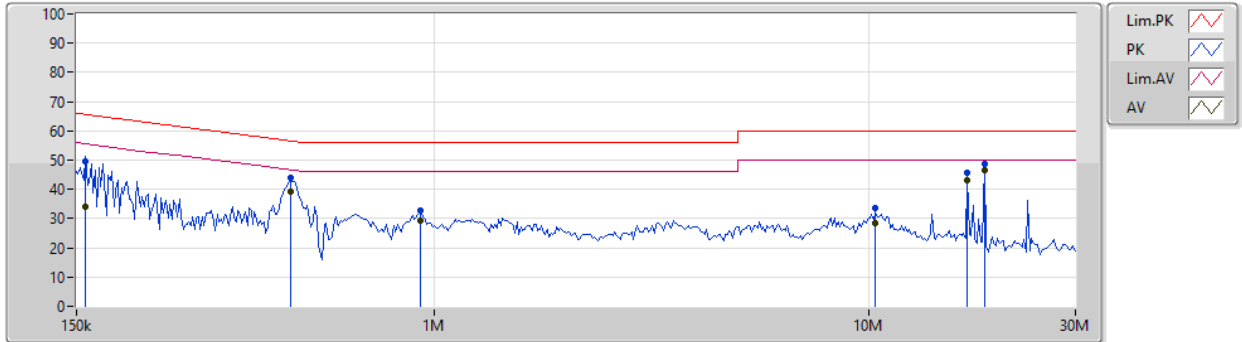

Type	Freq (Hz)	Level (dBuV)	Limit (dBuV)	Margin (dB)	Factor (dB)	Condition	Comment	Raw (dBuV)	LISN (dB)	CL (dB)	AT (dB)
QP	157.652k	49.36	65.58	-16.22	19.58	Neutral	-	29.78	9.60	0.11	9.87
AV	157.652k	34.26	55.58	-21.32	19.58	Neutral	-	14.68	9.60	0.11	9.87
QP	466.367k	44.13	56.57	-12.44	19.59	Neutral	-	24.54	9.59	0.13	9.87
AV	466.367k	39.14	46.57	-7.43	19.59	Neutral	-	19.55	9.59	0.13	9.87
QP	926.622k	32.79	56.00	-23.21	19.58	Neutral	-	13.21	9.59	0.11	9.88
AV	926.622k	29.32	46.00	-16.68	19.58	Neutral	-	9.74	9.59	0.11	9.88
QP	10.399M	33.67	60.00	-26.33	19.82	Neutral	-	13.85	9.67	0.27	9.88
AV	10.399M	28.32	50.00	-21.68	19.82	Neutral	-	8.50	9.67	0.27	9.88
QP	16.933M	45.59	60.00	-14.41	19.89	Neutral	-	25.70	9.68	0.33	9.88
AV	16.933M	43.14	50.00	-6.86	19.89	Neutral	-	23.25	9.68	0.33	9.88
QP	18.52M	48.56	60.00	-11.44	19.92	Neutral	-	28.64	9.68	0.35	9.89
AV	18.52M	46.48	50.00	-3.52	19.92	Neutral	"Worst"	26.56	9.68	0.35	9.89



AC Power-line Conducted Emissions_
Non Beamforming_Sample 2_ Radio3

Appendix A.4

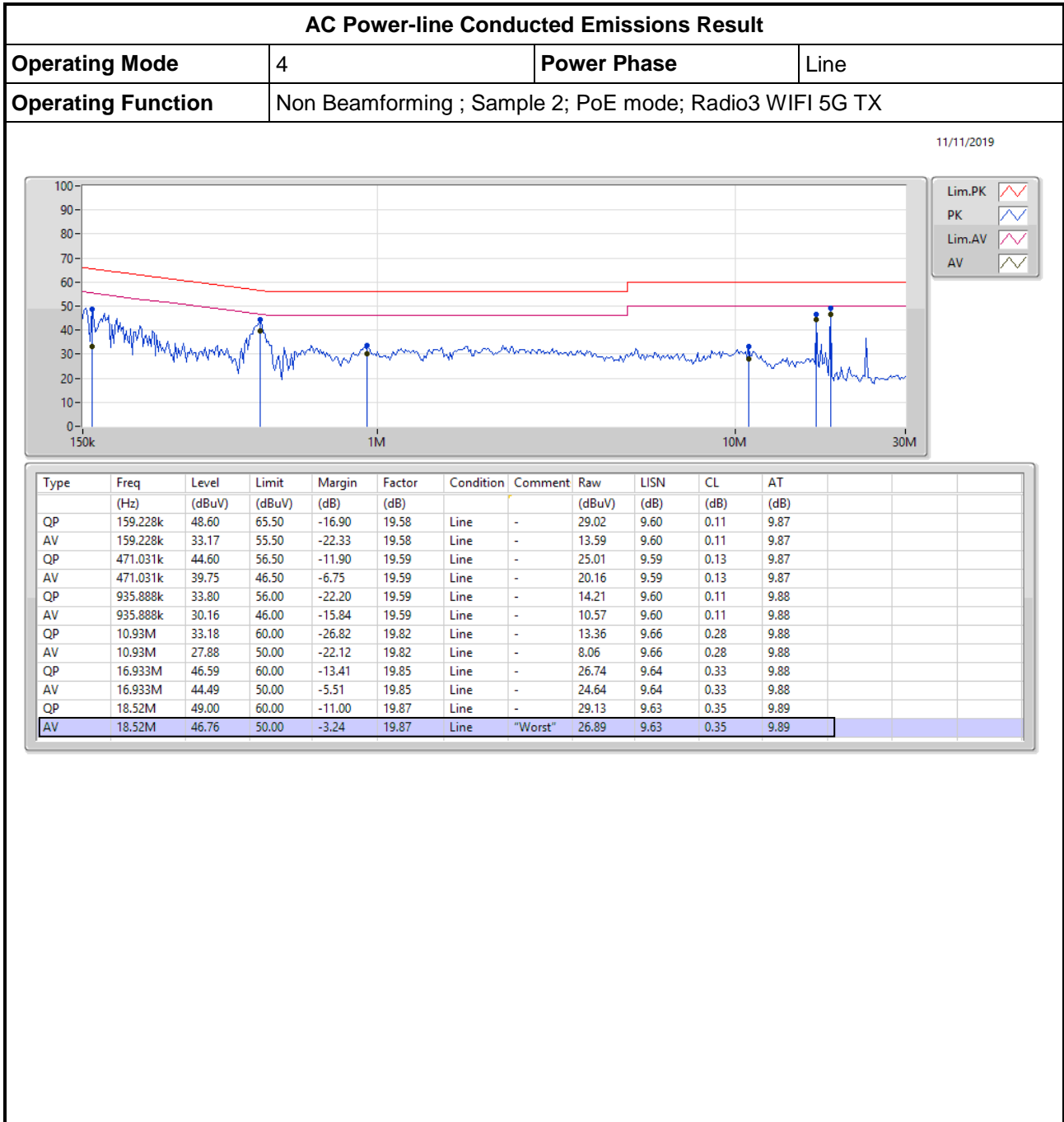



AC Power-line Conducted Emissions_
Beamforming_Sample 1_Radio2

Appendix A.5

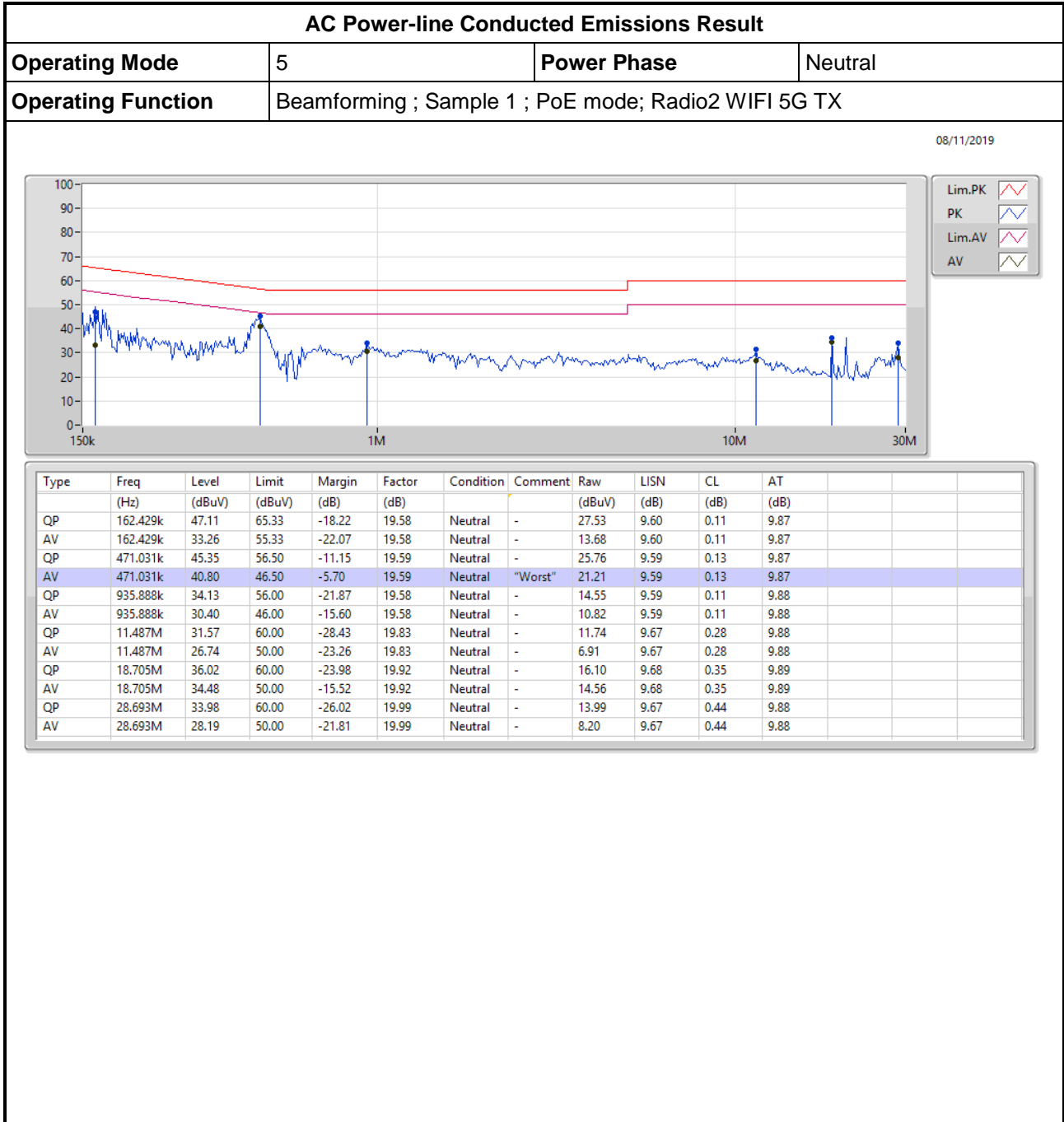



AC Power-line Conducted Emissions_
Beamforming_Sample 1_Radio2

Appendix A.5

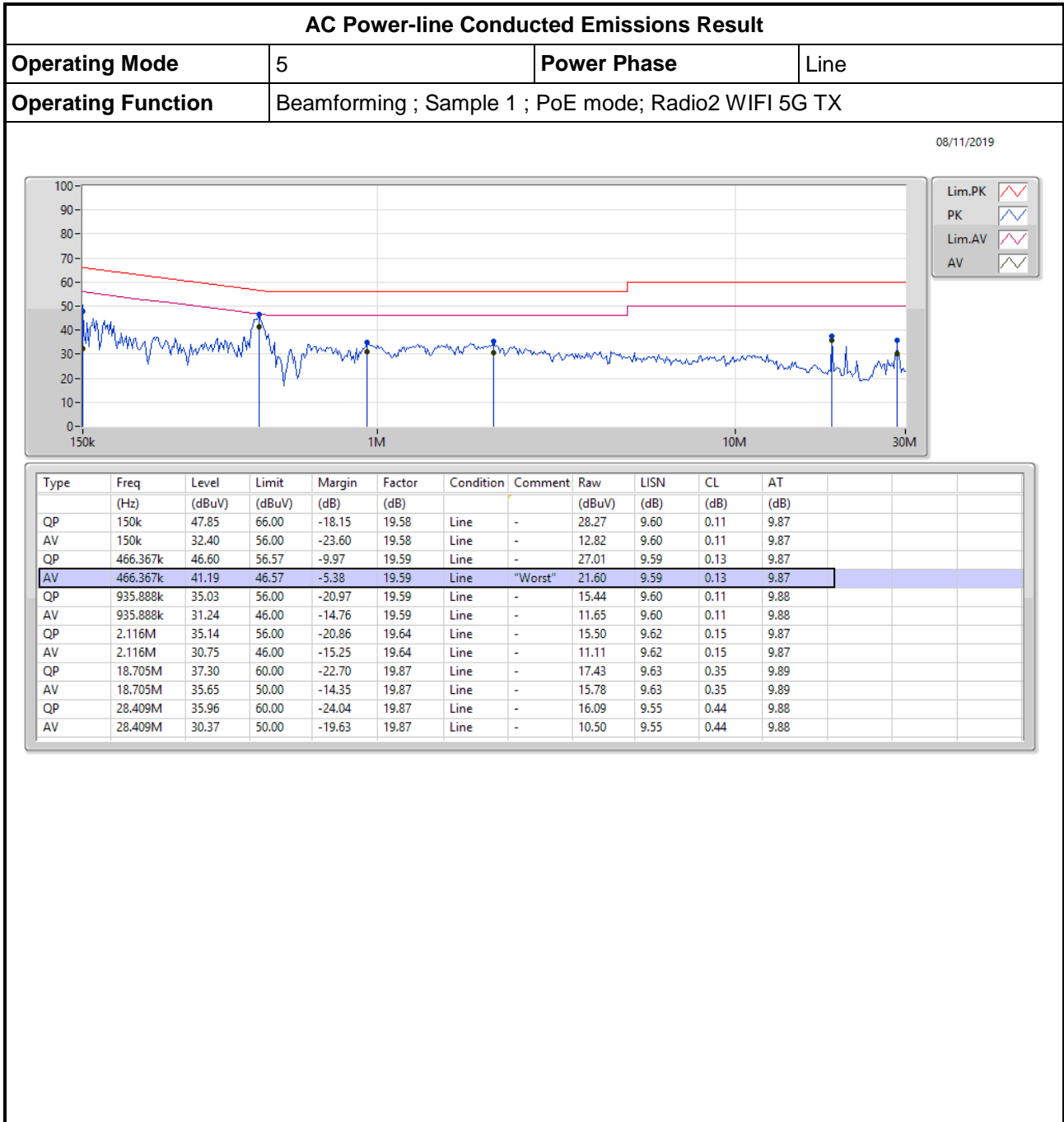



AC Power-line Conducted Emissions_
Beamforming_Sample 1_Radio3

Appendix A.6

AC Power-line Conducted Emissions Result

Operating Mode	6	Power Phase	Neutral
Operating Function	Beamforming ; Sample 1 ; PoE mode; Radio3 WIFI 5G TX		

12/11/2019

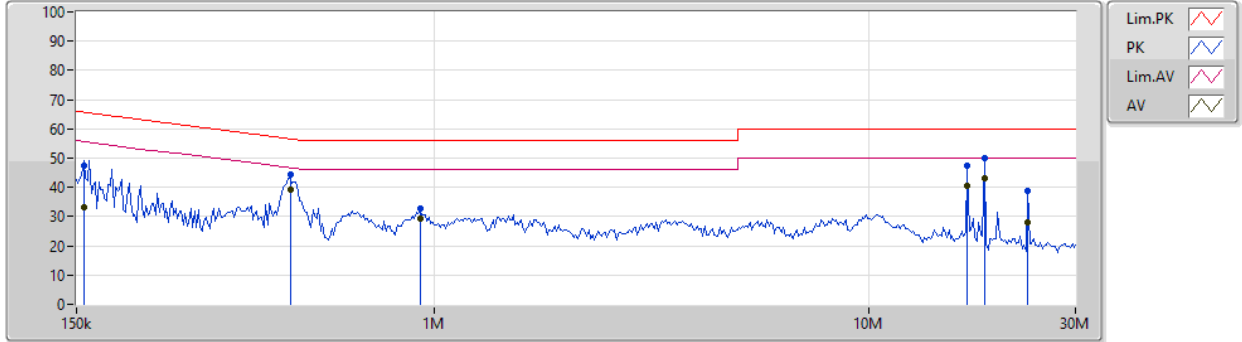

Type	Freq (Hz)	Level (dBuV)	Limit (dBuV)	Margin (dB)	Factor (dB)	Condition	Comment	Raw (dBuV)	LISN (dB)	CL (dB)	AT (dB)
QP	156.091k	47.59	65.67	-18.08	19.58	Neutral	-	28.01	9.60	0.11	9.87
AV	156.091k	33.40	55.67	-22.27	19.58	Neutral	-	13.82	9.60	0.11	9.87
QP	466.367k	44.30	56.57	-12.27	19.59	Neutral	-	24.71	9.59	0.13	9.87
AV	466.367k	39.38	46.57	-7.19	19.59	Neutral	-	19.79	9.59	0.13	9.87
QP	926.622k	32.80	56.00	-23.20	19.58	Neutral	-	13.22	9.59	0.11	9.88
AV	926.622k	29.47	46.00	-16.53	19.58	Neutral	-	9.89	9.59	0.11	9.88
QP	16.933M	47.48	60.00	-12.52	19.89	Neutral	-	27.59	9.68	0.33	9.88
AV	16.933M	40.59	50.00	-9.41	19.89	Neutral	-	20.70	9.68	0.33	9.88
QP	18.52M	50.03	60.00	-9.97	19.92	Neutral	-	30.11	9.68	0.35	9.89
AV	18.52M	43.02	50.00	-6.98	19.92	Neutral	"Worst"	23.10	9.68	0.35	9.89
QP	23.282M	38.68	60.00	-21.32	19.95	Neutral	-	18.73	9.68	0.39	9.88
AV	23.282M	28.18	50.00	-21.82	19.95	Neutral	-	8.23	9.68	0.39	9.88



AC Power-line Conducted Emissions_
Beamforming_Sample 1_Radio3

Appendix A.6

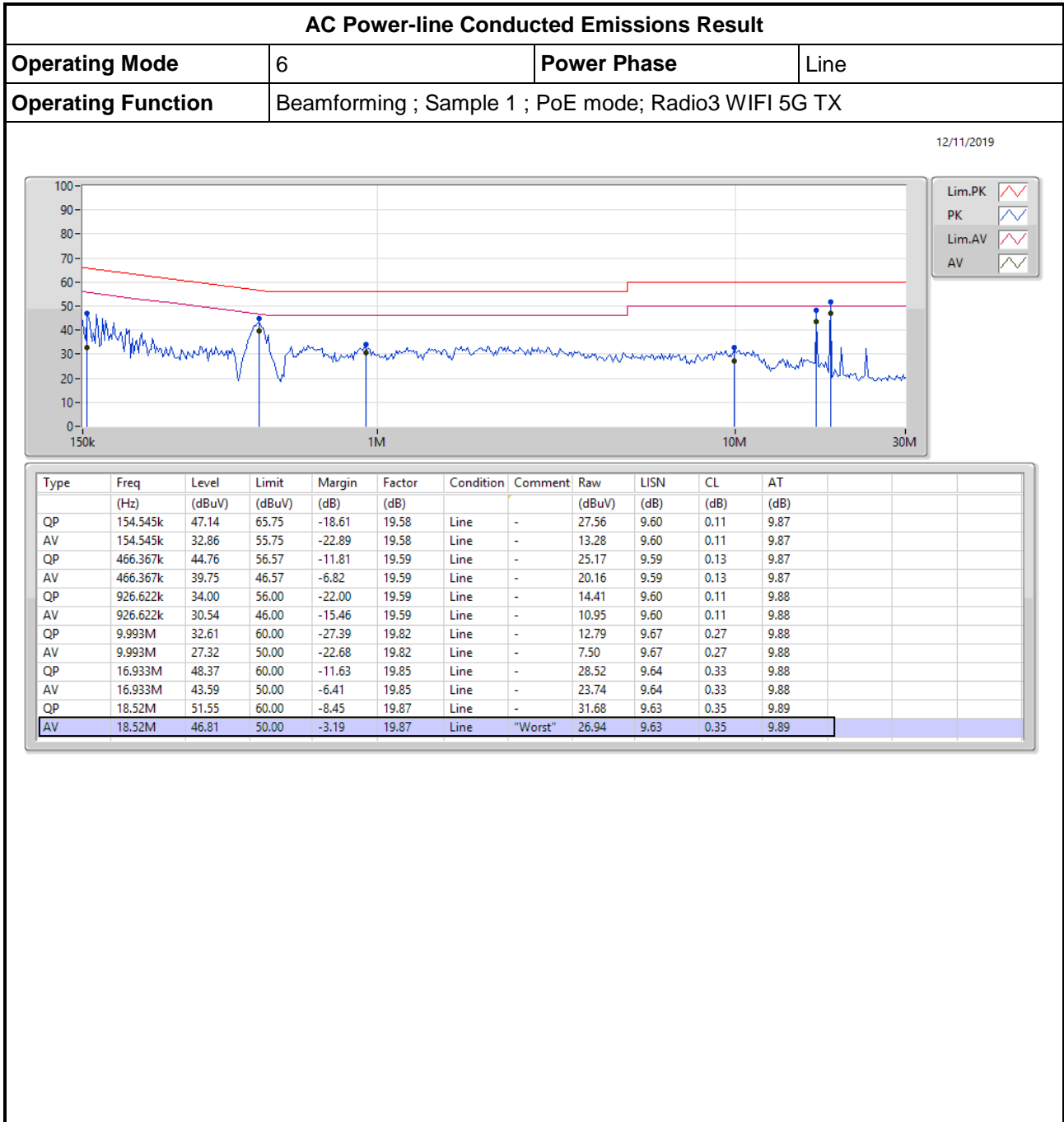



AC Power-line Conducted Emissions_
Beamforming_Sample 2_Radio2

Appendix A.7

AC Power-line Conducted Emissions Result

Operating Mode	7	Power Phase	Neutral
Operating Function	Beamforming ; Sample 2 ; PoE mode; Radio2 WIFI 5G TX		

12/11/2019

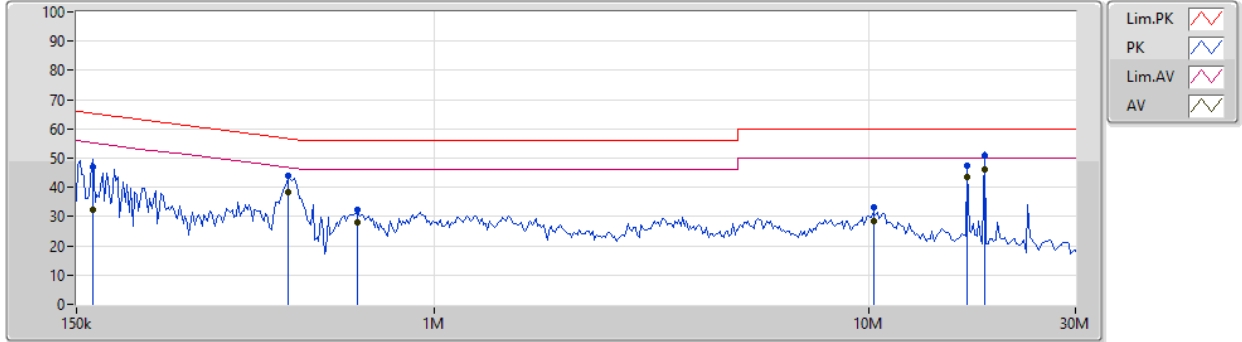

Type	Freq (Hz)	Level (dBuV)	Limit (dBuV)	Margin (dB)	Factor (dB)	Condition	Comment	Raw (dBuV)	LISN (dB)	CL (dB)	AT (dB)
QP	164.053k	47.09	65.25	-18.16	19.58	Neutral	-	27.51	9.60	0.11	9.87
AV	164.053k	32.26	55.25	-22.99	19.58	Neutral	-	12.68	9.60	0.11	9.87
QP	461.75k	43.82	56.67	-12.85	19.59	Neutral	-	24.23	9.59	0.13	9.87
AV	461.75k	38.20	46.67	-8.47	19.59	Neutral	-	18.61	9.59	0.13	9.87
QP	667.263k	32.43	56.00	-23.57	19.58	Neutral	-	12.85	9.59	0.12	9.87
AV	667.263k	28.18	46.00	-17.82	19.58	Neutral	-	8.60	9.59	0.12	9.87
QP	10.296M	33.38	60.00	-26.62	19.82	Neutral	-	13.56	9.67	0.27	9.88
AV	10.296M	28.24	50.00	-21.76	19.82	Neutral	-	8.42	9.67	0.27	9.88
QP	16.933M	47.38	60.00	-12.62	19.89	Neutral	-	27.49	9.68	0.33	9.88
AV	16.933M	43.63	50.00	-6.37	19.89	Neutral	-	23.74	9.68	0.33	9.88
QP	18.52M	50.66	60.00	-9.34	19.92	Neutral	-	30.74	9.68	0.35	9.89
AV	18.52M	46.32	50.00	-3.68	19.92	Neutral	"Worst"	26.40	9.68	0.35	9.89



AC Power-line Conducted Emissions_
Beamforming_Sample 2_Radio2

Appendix A.7

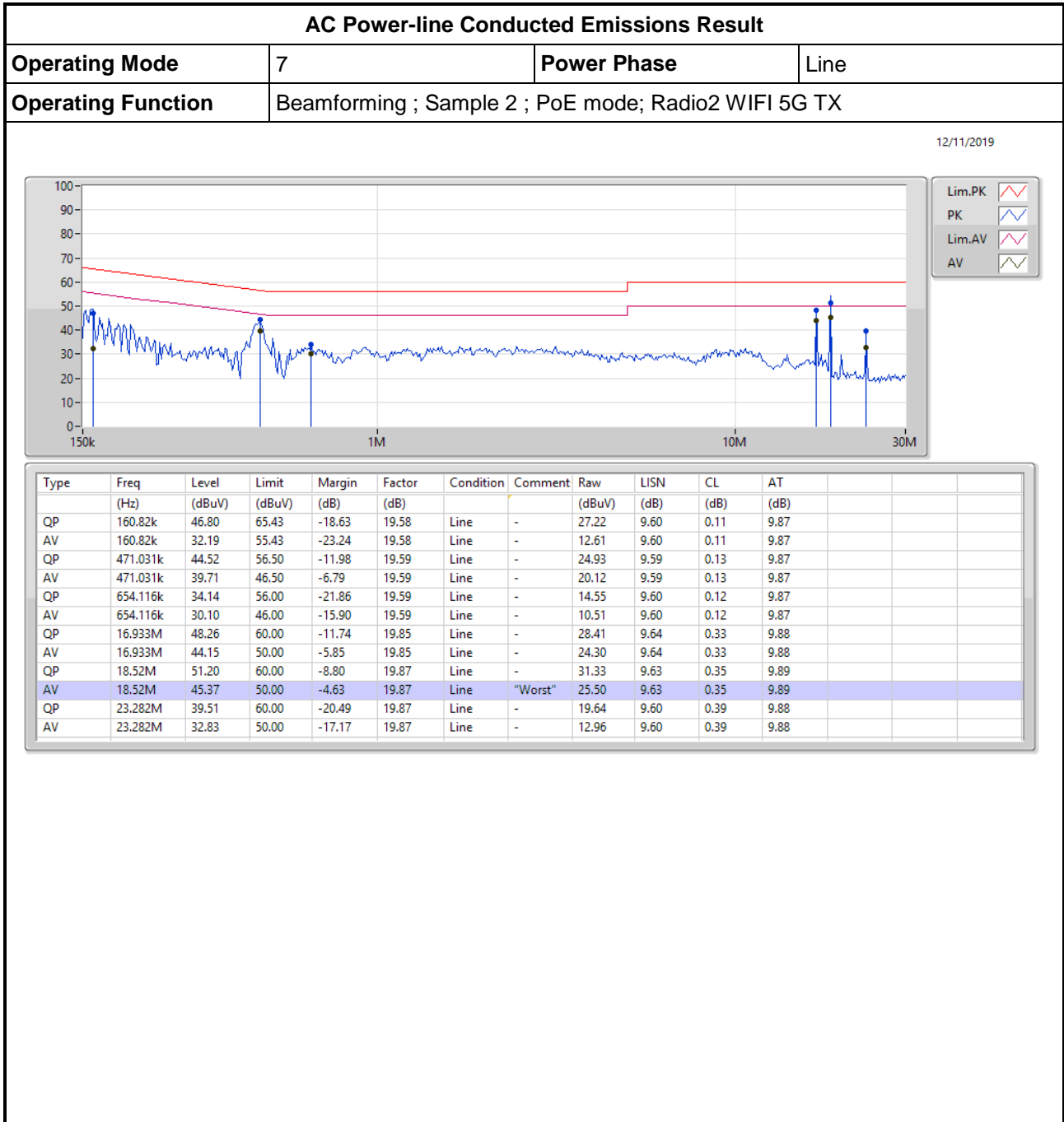



AC Power-line Conducted Emissions
Beamforming Sample 2 Radio3

Appendix A.8

AC Power-line Conducted Emissions Result

Operating Mode	8	Power Phase	Neutral
Operating Function	Beamforming ; Sample 2 ; PoE mode; Radio3 WIFI 5G TX		

12/11/2019

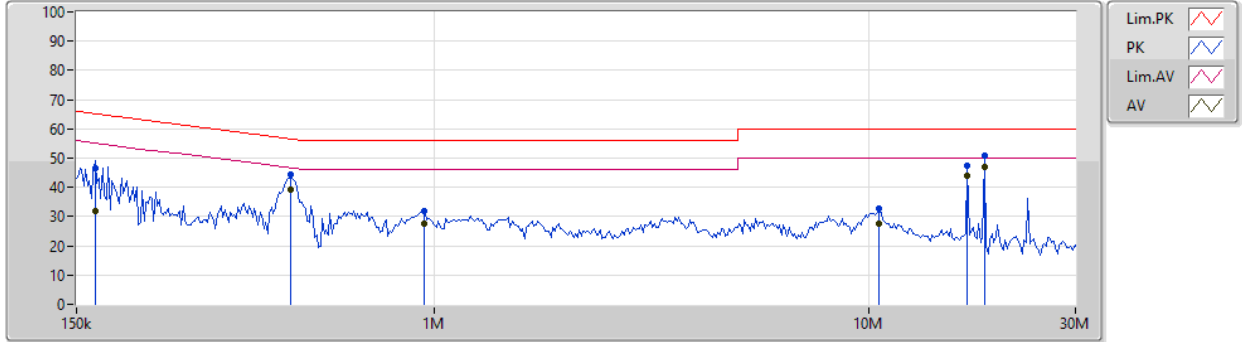

Type	Freq (Hz)	Level (dBuV)	Limit (dBuV)	Margin (dB)	Factor (dB)	Condition	Comment	Raw (dBuV)	LISN (dB)	CL (dB)	AT (dB)
QP	165.693k	46.43	65.18	-18.75	19.58	Neutral	-	26.85	9.60	0.11	9.87
AV	165.693k	31.79	55.18	-23.39	19.58	Neutral	-	12.21	9.60	0.11	9.87
QP	466.367k	44.32	56.57	-12.25	19.59	Neutral	-	24.73	9.59	0.13	9.87
AV	466.367k	39.41	46.57	-7.16	19.59	Neutral	-	19.82	9.59	0.13	9.87
QP	945.247k	31.91	56.00	-24.09	19.58	Neutral	-	12.33	9.59	0.11	9.88
AV	945.247k	27.74	46.00	-18.26	19.58	Neutral	-	8.16	9.59	0.11	9.88
QP	10.608M	32.93	60.00	-27.07	19.83	Neutral	-	13.10	9.67	0.28	9.88
AV	10.608M	27.80	50.00	-22.20	19.83	Neutral	-	7.97	9.67	0.28	9.88
QP	16.933M	47.33	60.00	-12.67	19.89	Neutral	-	27.44	9.68	0.33	9.88
AV	16.933M	43.99	50.00	-6.01	19.89	Neutral	-	24.10	9.68	0.33	9.88
QP	18.52M	50.76	60.00	-9.24	19.92	Neutral	-	30.84	9.68	0.35	9.89
AV	18.52M	46.78	50.00	-3.22	19.92	Neutral	"Worst"	26.86	9.68	0.35	9.89



AC Power-line Conducted Emissions
Beamforming_Sample 2_Radio3

Appendix A.8

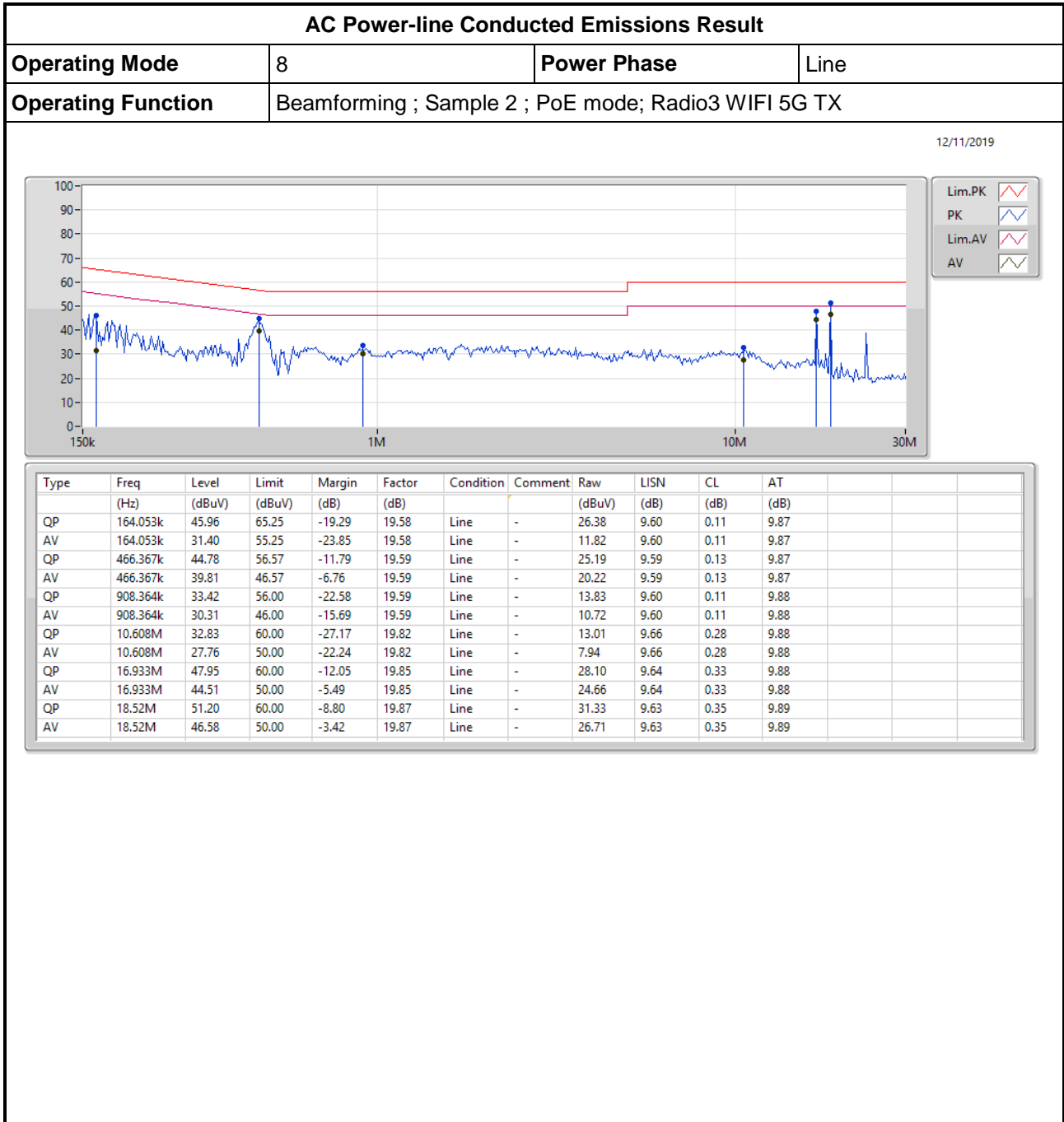



Summary

Mode	Max-N dB (Hz)	Max-OBW (Hz)	ITU-Code	Min-N dB (Hz)	Min-OBW (Hz)
5.15-5.25GHz	-	-	-	-	-
802.11a_Nss1,(6Mbps)_1TX	21.6M	16.642M	16M6D1D	21.54M	16.612M
802.11ac VHT20_Nss1,(MCS0)_1TX	21.75M	17.811M	17M8D1D	21.72M	17.751M
802.11ac VHT40_Nss1,(MCS0)_1TX	40.38M	36.282M	36M3D1D	40.38M	36.282M
802.11ac VHT80_Nss1,(MCS0)_1TX	82.44M	75.802M	75M8D1D	82.44M	75.802M
802.11ax HEW20_Nss1,(MCS0)_1TX	21.66M	19.01M	19M0D1D	21.63M	18.981M
802.11ax HEW40_Nss1,(MCS0)_1TX	40.14M	37.541M	37M5D1D	40.08M	37.541M
802.11ax HEW80_Nss1,(MCS0)_1TX	82.32M	76.882M	76M9D1D	82.32M	76.882M
5.725-5.85GHz	-	-	-	-	-
802.11a_Nss1,(6Mbps)_1TX	16.32M	26.537M	26M5D1D	16.26M	25.277M
802.11ac VHT20_Nss1,(MCS0)_1TX	17.58M	28.606M	28M6D1D	17.52M	26.837M
802.11ac VHT40_Nss1,(MCS0)_1TX	36.3M	49.355M	49M4D1D	36.3M	43.478M
802.11ac VHT80_Nss1,(MCS0)_1TX	76.08M	75.802M	75M8D1D	76.08M	75.802M
802.11ax HEW20_Nss1,(MCS0)_1TX	18.9M	29.355M	29M4D1D	18.87M	28.756M
802.11ax HEW40_Nss1,(MCS0)_1TX	37.5M	48.936M	48M9D1D	37.26M	42.699M
802.11ax HEW80_Nss1,(MCS0)_1TX	76.8M	76.882M	76M9D1D	76.8M	76.882M

Max-N dB = Maximum 6dB down bandwidth for 5.725-5.85GHz band / Maximum 26dB down bandwidth for other band;

Max-OBW = Maximum 99% occupied bandwidth;

Min-N dB = Minimum 6dB down bandwidth for 5.725-5.85GHz band / Maximum 26dB down bandwidth for other band;

Min-OBW = Minimum 99% occupied bandwidth;



Result

Mode	Result	Limit (Hz)	Port 1-N dB (Hz)	Port 1-OBW (Hz)
802.11a_Nss1,(6Mbps)_1TX	-	-	-	-
5180MHz	Pass	Inf	21.54M	16.612M
5200MHz	Pass	Inf	21.6M	16.612M
5240MHz	Pass	Inf	21.57M	16.642M
5745MHz	Pass	500k	16.29M	25.277M
5785MHz	Pass	500k	16.32M	26.057M
5825MHz	Pass	500k	16.26M	26.537M
802.11ac VHT20_Nss1,(MCS0)_1TX	-	-	-	-
5180MHz	Pass	Inf	21.75M	17.751M
5200MHz	Pass	Inf	21.75M	17.751M
5240MHz	Pass	Inf	21.72M	17.811M
5745MHz	Pass	500k	17.52M	26.837M
5785MHz	Pass	500k	17.58M	28.606M
5825MHz	Pass	500k	17.52M	28.036M
802.11ac VHT40_Nss1,(MCS0)_1TX	-	-	-	-
5190MHz	Pass	Inf	40.38M	36.282M
5230MHz	Pass	Inf	40.38M	36.282M
5755MHz	Pass	500k	36.3M	43.478M
5795MHz	Pass	500k	36.3M	49.355M
802.11ac VHT80_Nss1,(MCS0)_1TX	-	-	-	-
5210MHz	Pass	Inf	82.44M	75.802M
5775MHz	Pass	500k	76.08M	75.802M
802.11ax HEW20_Nss1,(MCS0)_1TX	-	-	-	-
5180MHz	Pass	Inf	21.63M	18.981M
5200MHz	Pass	Inf	21.66M	19.01M
5240MHz	Pass	Inf	21.66M	18.981M
5745MHz	Pass	500k	18.87M	28.936M
5785MHz	Pass	500k	18.87M	28.756M
5825MHz	Pass	500k	18.9M	29.355M
802.11ax HEW40_Nss1,(MCS0)_1TX	-	-	-	-
5190MHz	Pass	Inf	40.14M	37.541M
5230MHz	Pass	Inf	40.08M	37.541M
5755MHz	Pass	500k	37.5M	42.699M
5795MHz	Pass	500k	37.26M	48.936M
802.11ax HEW80_Nss1,(MCS0)_1TX	-	-	-	-
5210MHz	Pass	Inf	82.32M	76.882M
5775MHz	Pass	500k	76.8M	76.882M

Port X-N dB = Port X 6dB down bandwidth for 5.725-5.85GHz band / 26dB down bandwidth for other band

Port X-OBW = Port X 99% occupied bandwidth;

802.11a_Nss1,(6Mbps)_1TX

EBW

5180MHz

24/09/2019

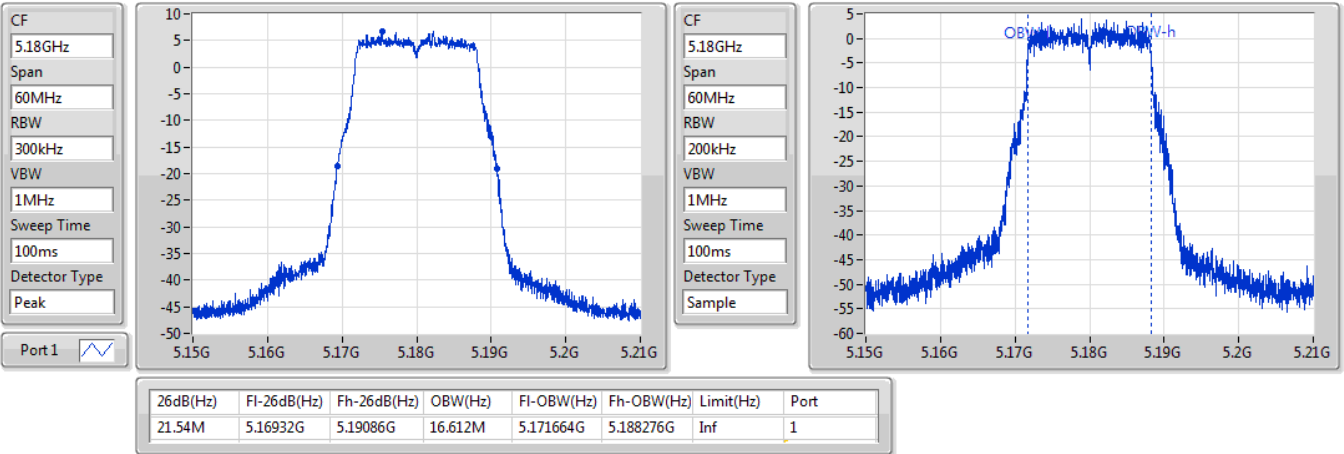

802.11a_Nss1,(6Mbps)_1TX

EBW

5200MHz

24/09/2019

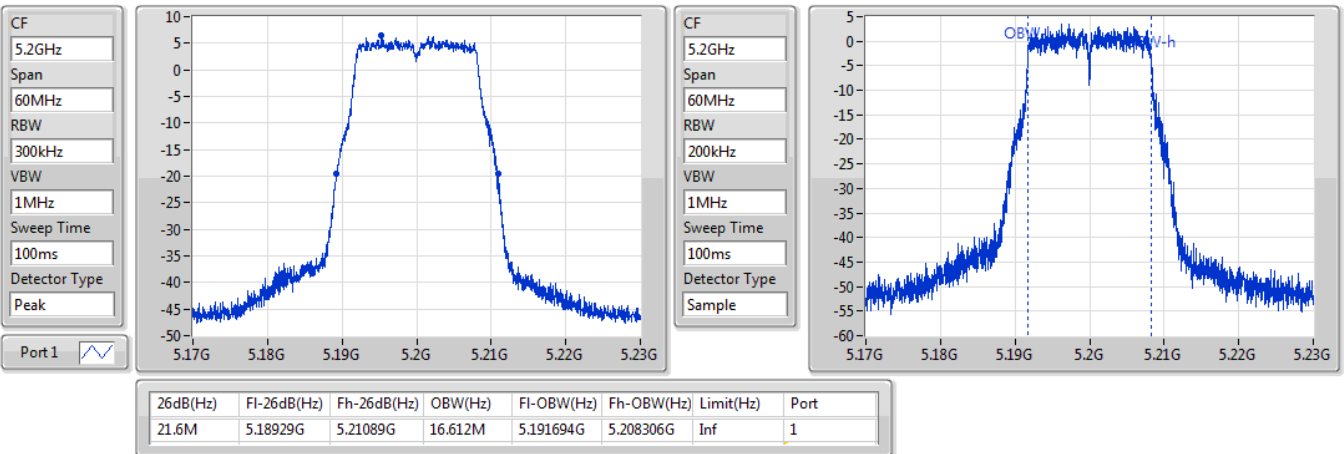

802.11a_Nss1,(6Mbps)_1TX

EBW

5240MHz

24/09/2019

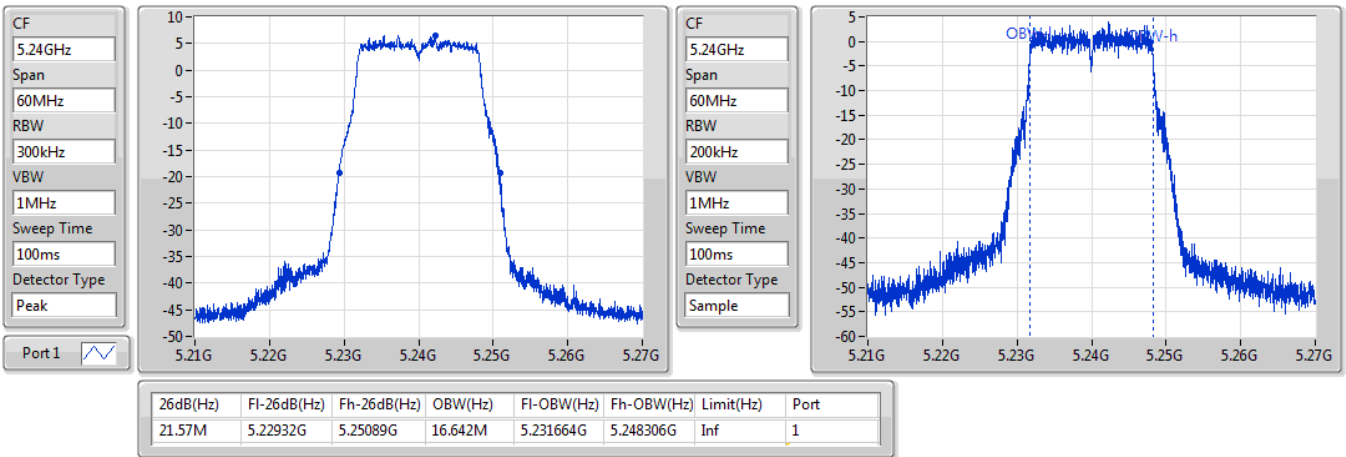

802.11a_Nss1,(6Mbps)_1TX

EBW

5745MHz

24/09/2019

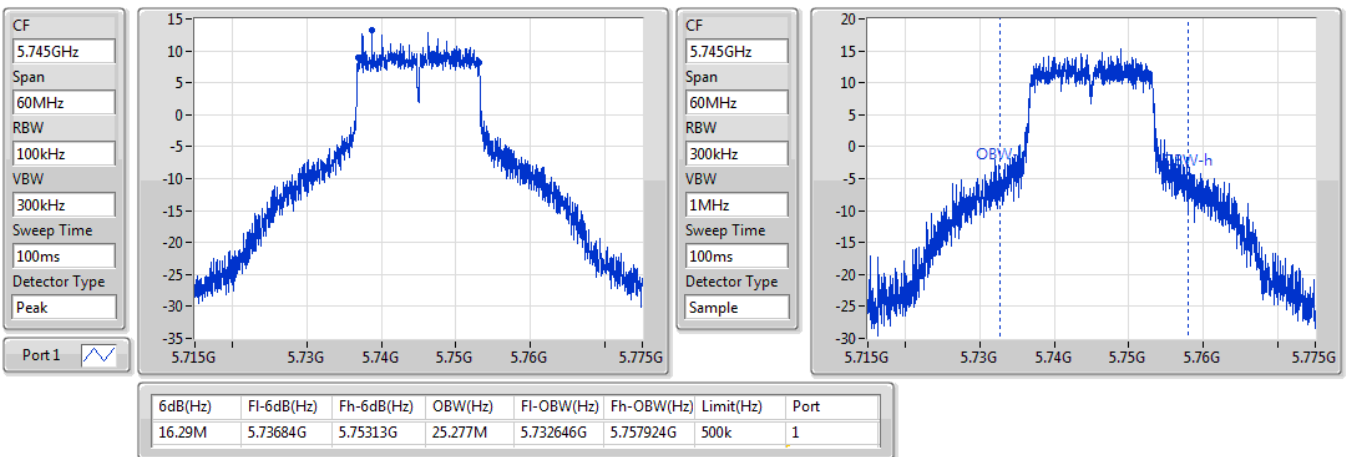

802.11a_Nss1,(6Mbps)_1TX

EBW

5785MHz

24/09/2019

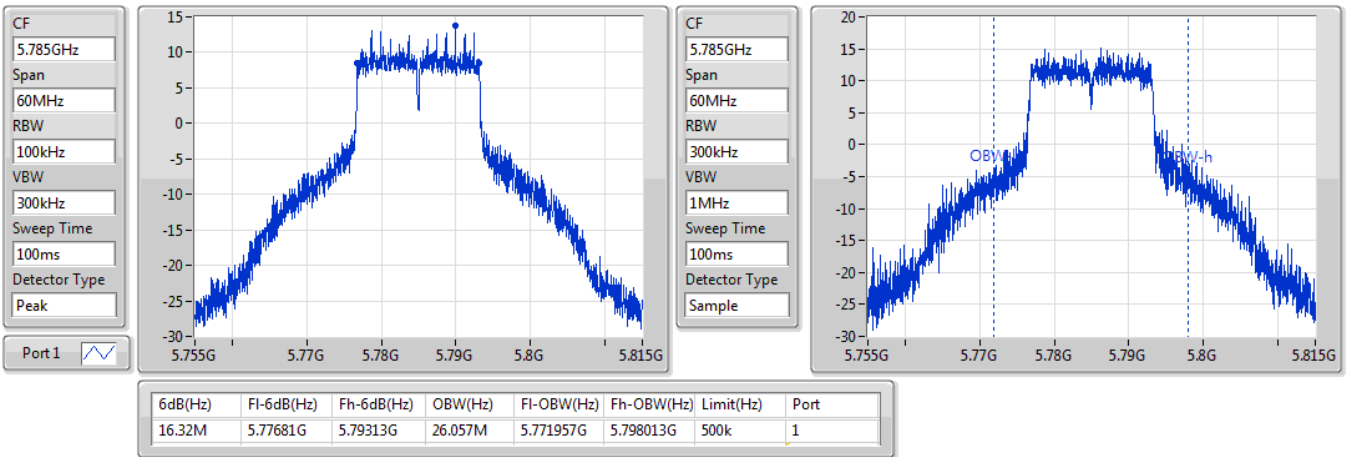

802.11a_Nss1,(6Mbps)_1TX

EBW

5825MHz

24/09/2019

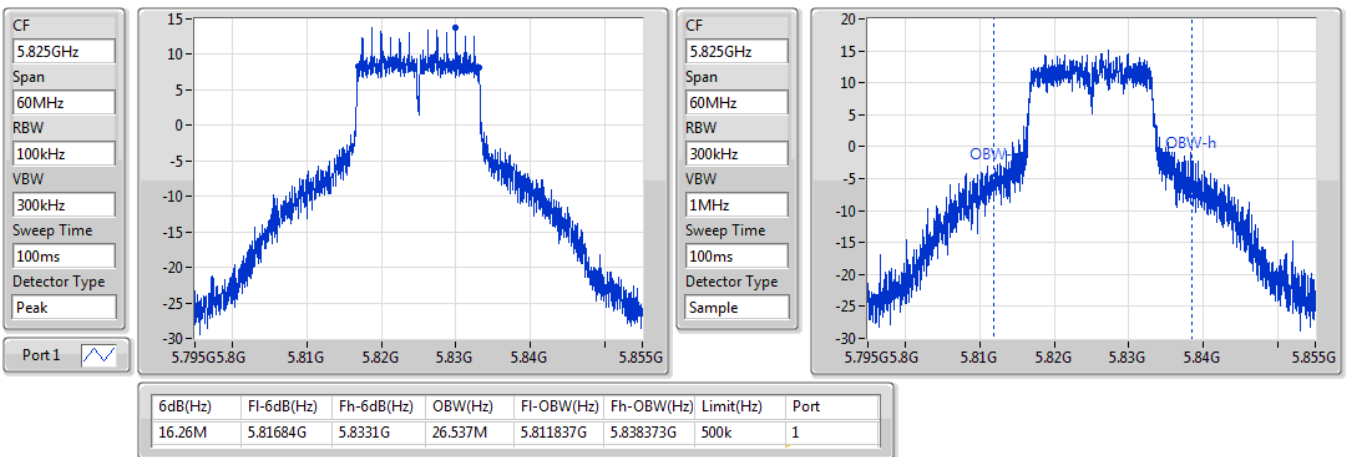

802.11ac VHT20_Nss1,(MCS0)_1TX

EBW

5180MHz

24/09/2019

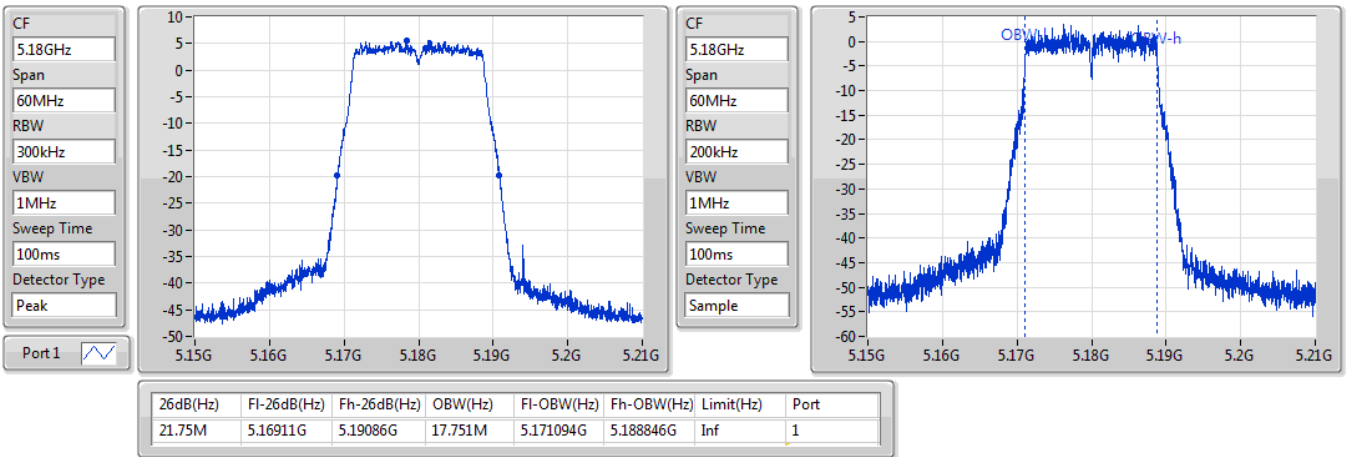

802.11ac VHT20_Nss1,(MCS0)_1TX

EBW

5200MHz

24/09/2019

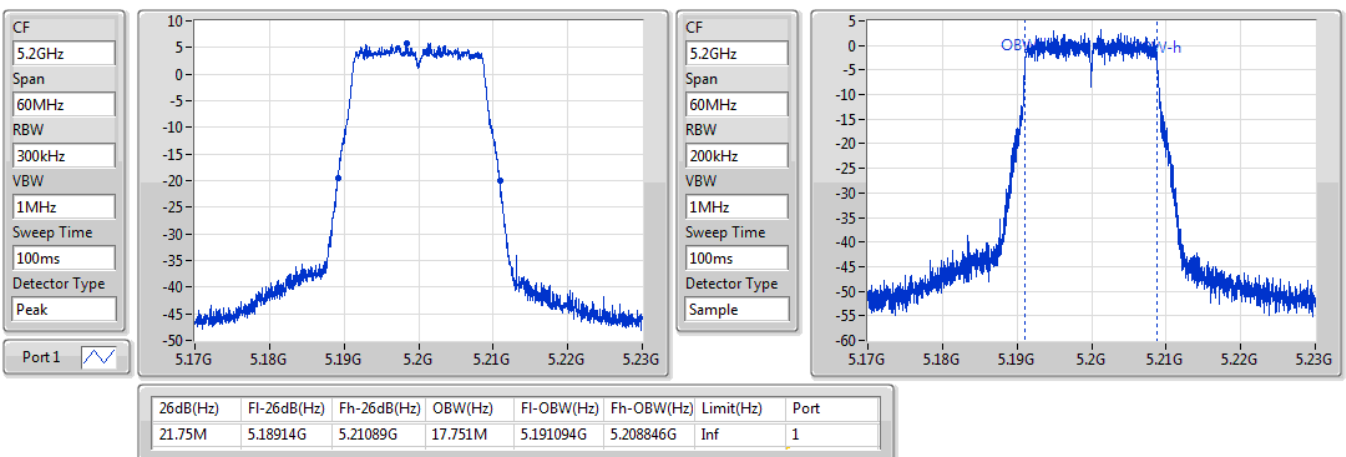

802.11ac VHT20_Nss1,(MCS0)_1TX

EBW

5240MHz

24/09/2019

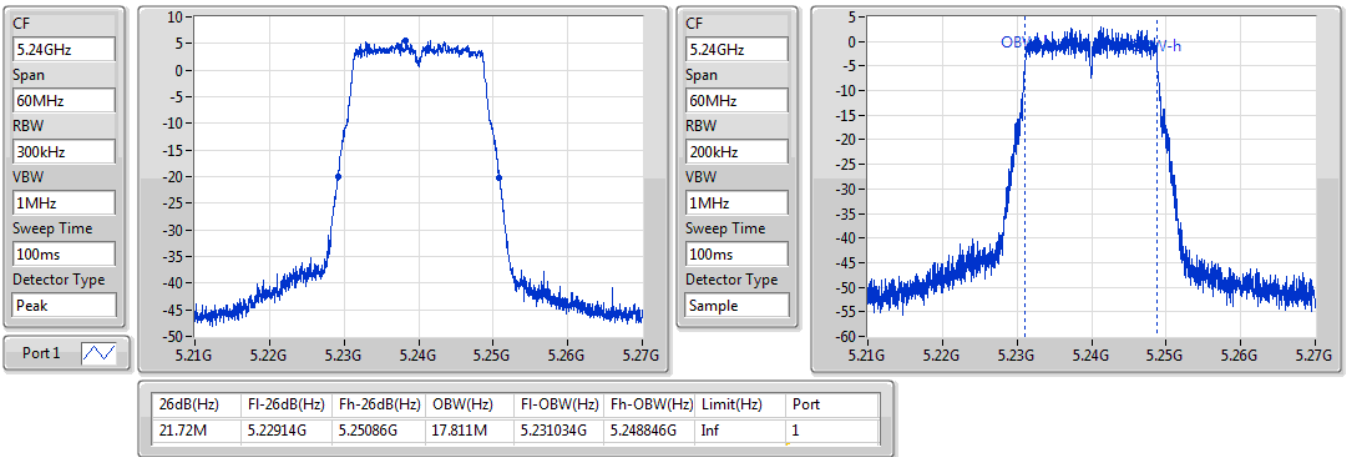

802.11ac VHT20_Nss1,(MCS0)_1TX

EBW

5745MHz

24/09/2019

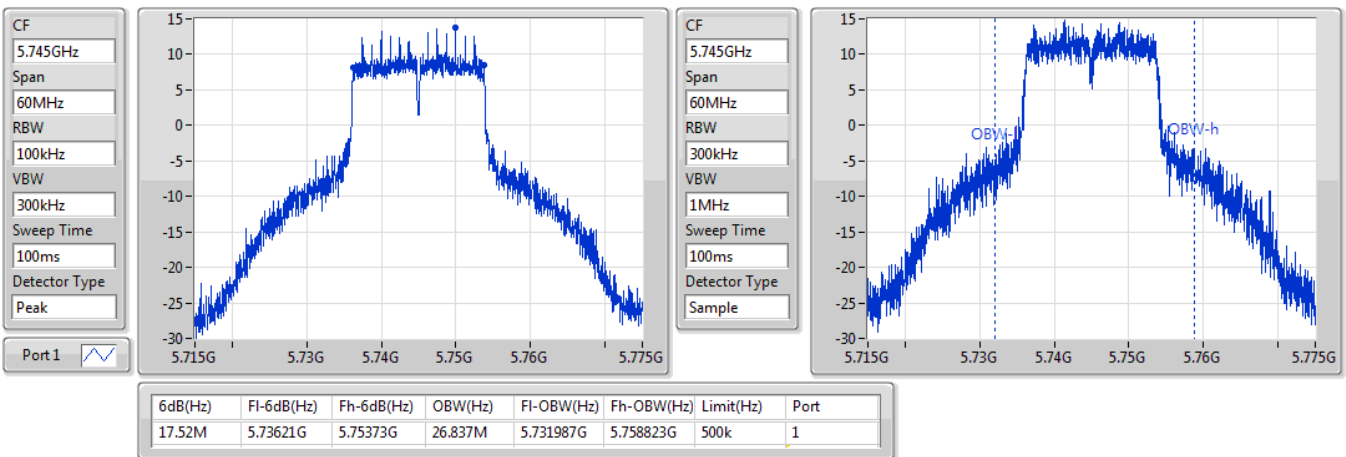

802.11ac VHT20_Nss1,(MCS0)_1TX

EBW

5785MHz

24/09/2019

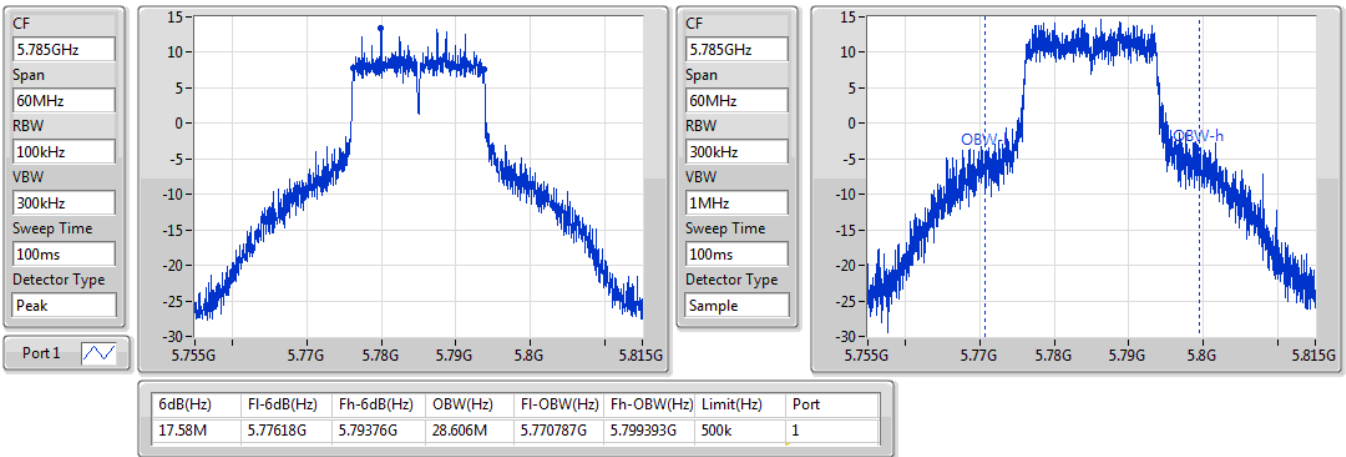

802.11ac VHT20_Nss1,(MCS0)_1TX

EBW

5825MHz

24/09/2019

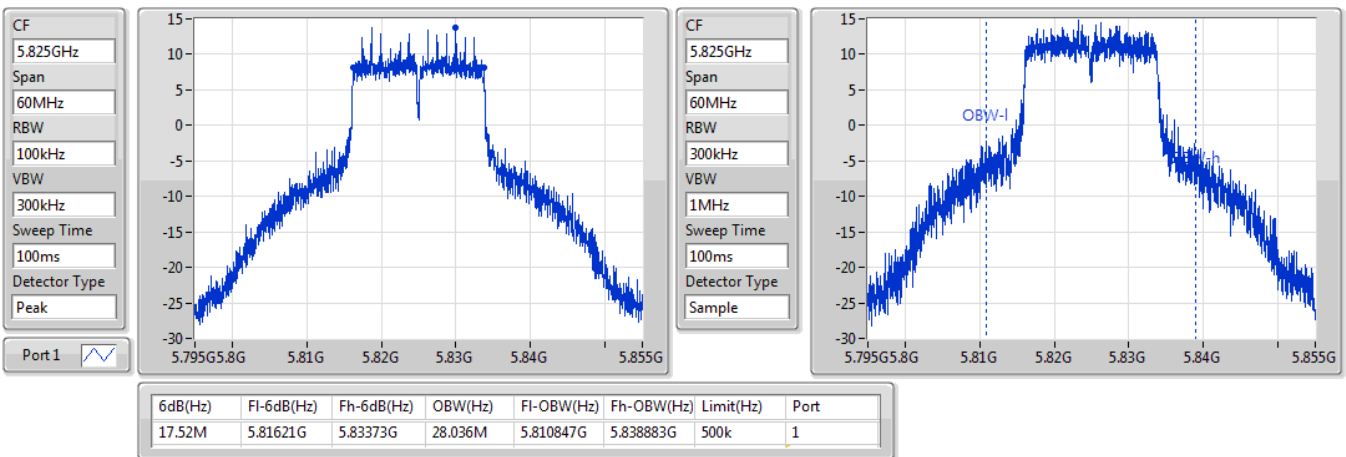

802.11ac VHT40_Nss1,(MCS0)_1TX

EBW

5190MHz

24/09/2019

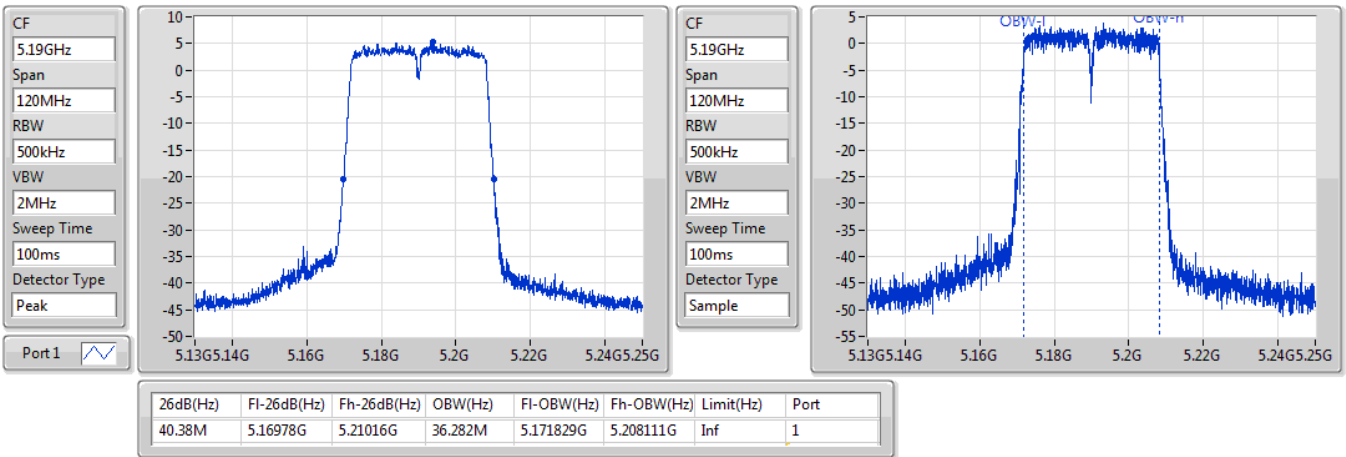

802.11ac VHT40_Nss1,(MCS0)_1TX

EBW

5230MHz

24/09/2019

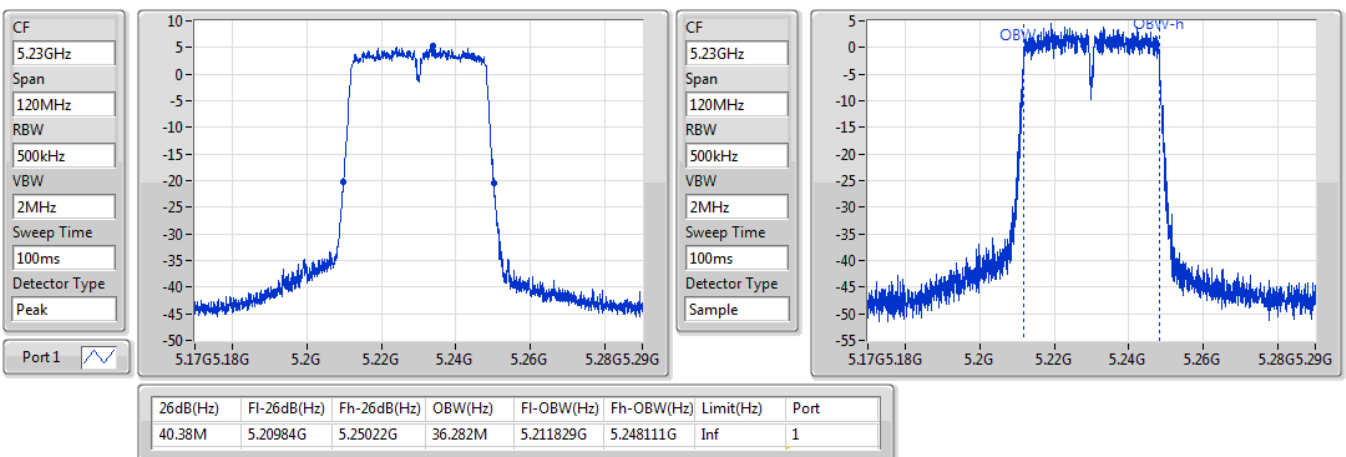

802.11ac VHT40_Nss1,(MCS0)_1TX

EBW

5755MHz

24/09/2019

CF
5.755GHz
Span
120MHz
RBW
100kHz
VBW
300kHz
Sweep Time
100ms
Detector Type
Peak
Port 1

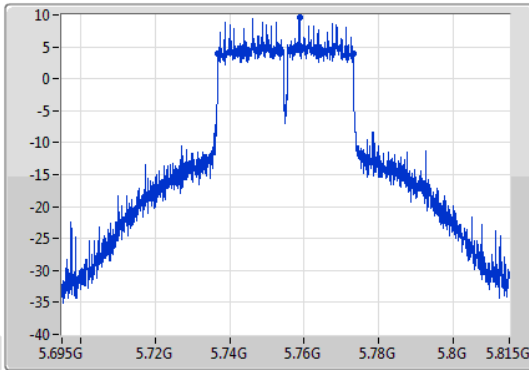

CF
5.755GHz
Span
120MHz
RBW
500kHz
VBW
2MHz
Sweep Time
100ms
Detector Type
Sample

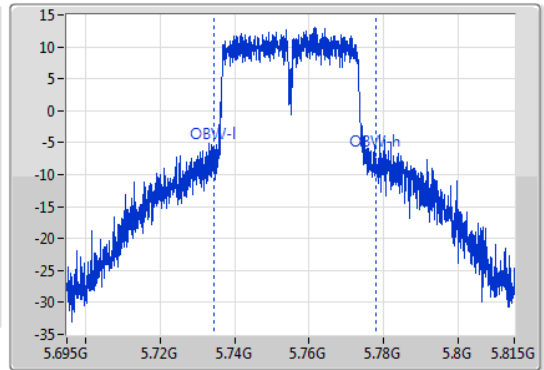

6dB(Hz)	Fl-6dB(Hz)	Fh-6dB(Hz)	OBW(Hz)	Fl-OBW(Hz)	Fh-OBW(Hz)	Limit(Hz)	Port
36.3M	5.73682G	5.77312G	43.478M	5.73449G	5.777969G	500k	1

802.11ac VHT40_Nss1,(MCS0)_1TX

EBW

5795MHz

24/09/2019

CF
5.795GHz
Span
120MHz
RBW
100kHz
VBW
300kHz
Sweep Time
100ms
Detector Type
Peak
Port 1

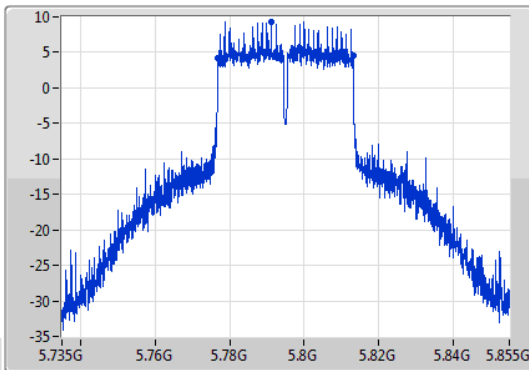

CF
5.795GHz
Span
120MHz
RBW
1MHz
VBW
3MHz
Sweep Time
100ms
Detector Type
Sample

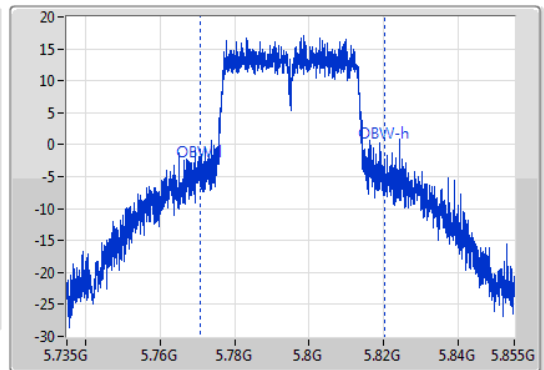

6dB(Hz)	Fl-6dB(Hz)	Fh-6dB(Hz)	OBW(Hz)	Fl-OBW(Hz)	Fh-OBW(Hz)	Limit(Hz)	Port
36.3M	5.77682G	5.81312G	49.355M	5.770772G	5.820127G	500k	1

802.11ac VHT80_Nss1,(MCS0)_1TX

EBW

5210MHz

24/09/2019

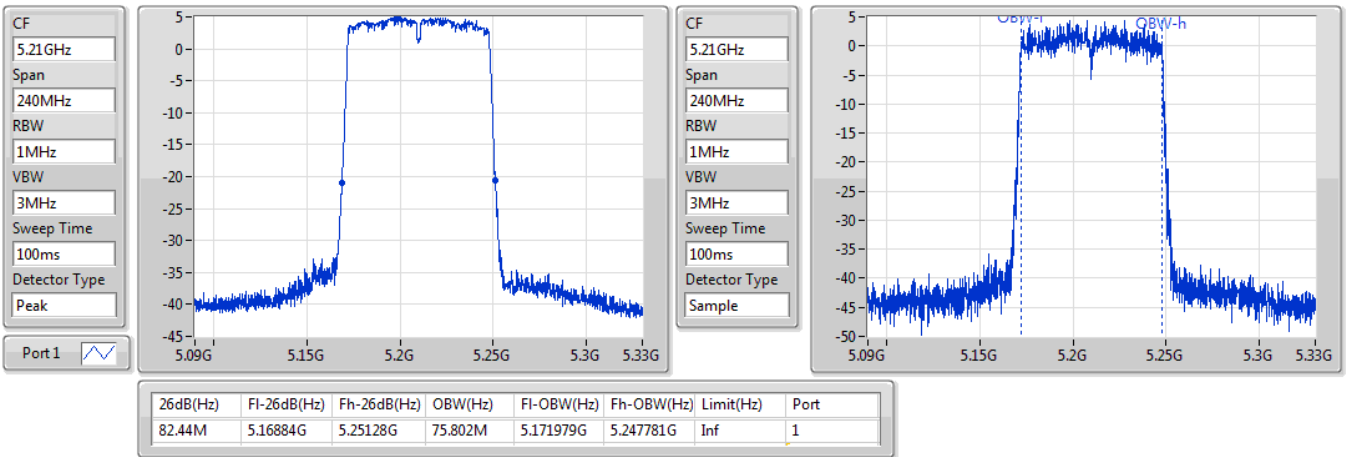

802.11ac VHT80_Nss1,(MCS0)_1TX

EBW

5775MHz

24/09/2019

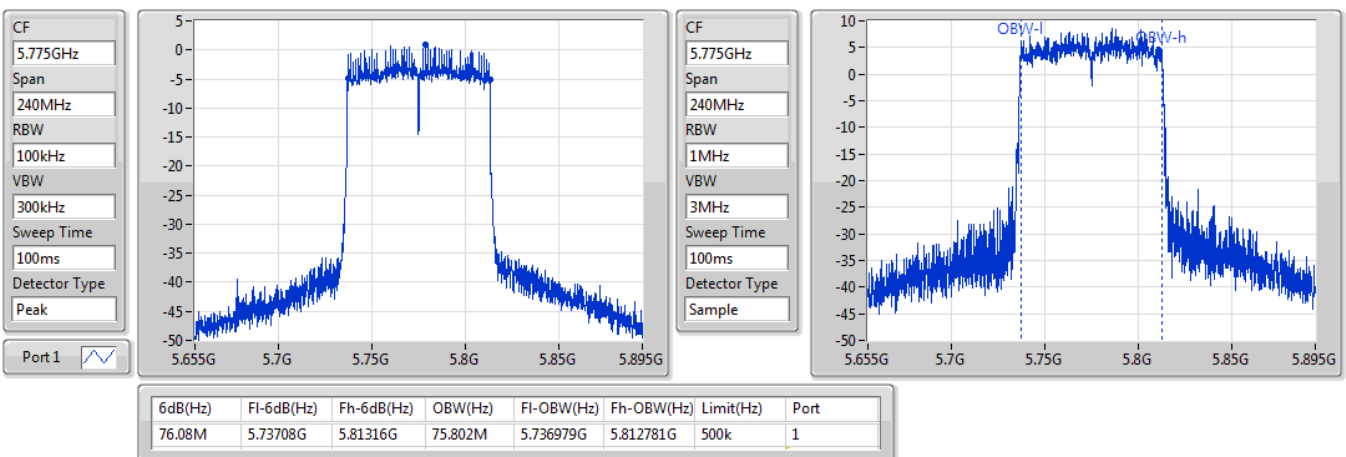

802.11ax HEW20_Nss1,(MCS0)_1TX

EBW

5180MHz

24/09/2019

CF
5.18GHz
Span
60MHz
RBW
300kHz
VBW
1MHz
Sweep Time
100ms
Detector Type
Peak
Port 1

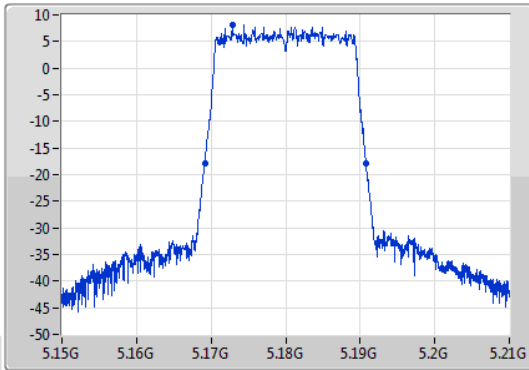

CF
5.18GHz
Span
60MHz
RBW
200kHz
VBW
1MHz
Sweep Time
100ms
Detector Type
Sample

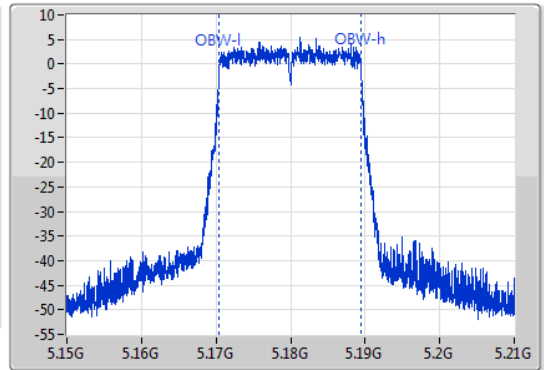

26dB(Hz)	Fl-26dB(Hz)	Fh-26dB(Hz)	OBW(Hz)	Fl-OBW(Hz)	Fh-OBW(Hz)	Limit(Hz)	Port
21.63M	5.16914G	5.19077G	18.981M	5.170465G	5.189445G	Inf	1

802.11ax HEW20_Nss1,(MCS0)_1TX

EBW

5200MHz

24/09/2019

CF
5.2GHz
Span
60MHz
RBW
300kHz
VBW
1MHz
Sweep Time
100ms
Detector Type
Peak
Port 1

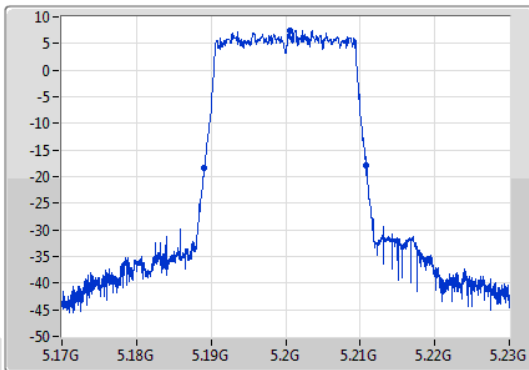

CF
5.2GHz
Span
60MHz
RBW
200kHz
VBW
1MHz
Sweep Time
100ms
Detector Type
Sample

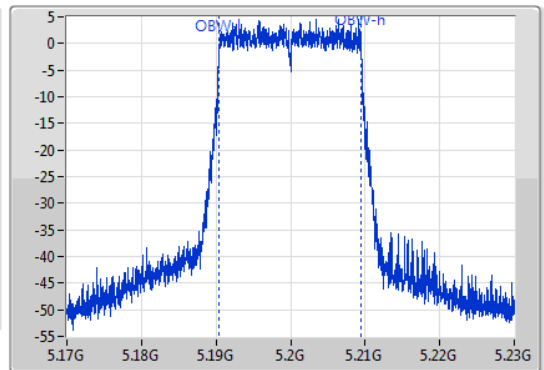

26dB(Hz)	Fl-26dB(Hz)	Fh-26dB(Hz)	OBW(Hz)	Fl-OBW(Hz)	Fh-OBW(Hz)	Limit(Hz)	Port
21.66M	5.18911G	5.21077G	19.01M	5.190435G	5.209445G	Inf	1

802.11ax HEW20_Nss1,(MCS0)_1TX

EBW

5240MHz

24/09/2019

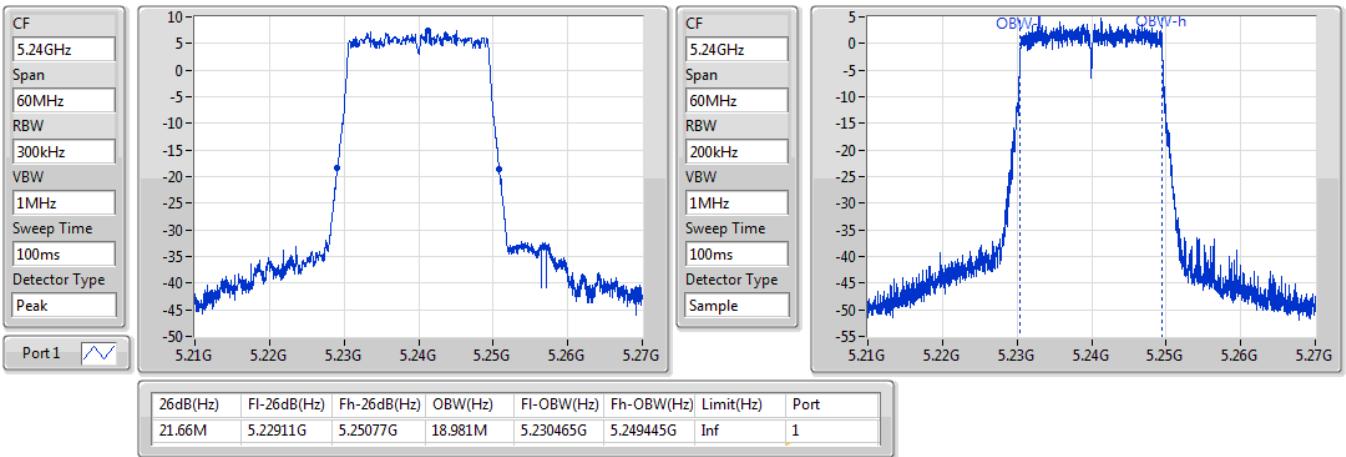

802.11ax HEW20_Nss1,(MCS0)_1TX

EBW

5745MHz

24/09/2019

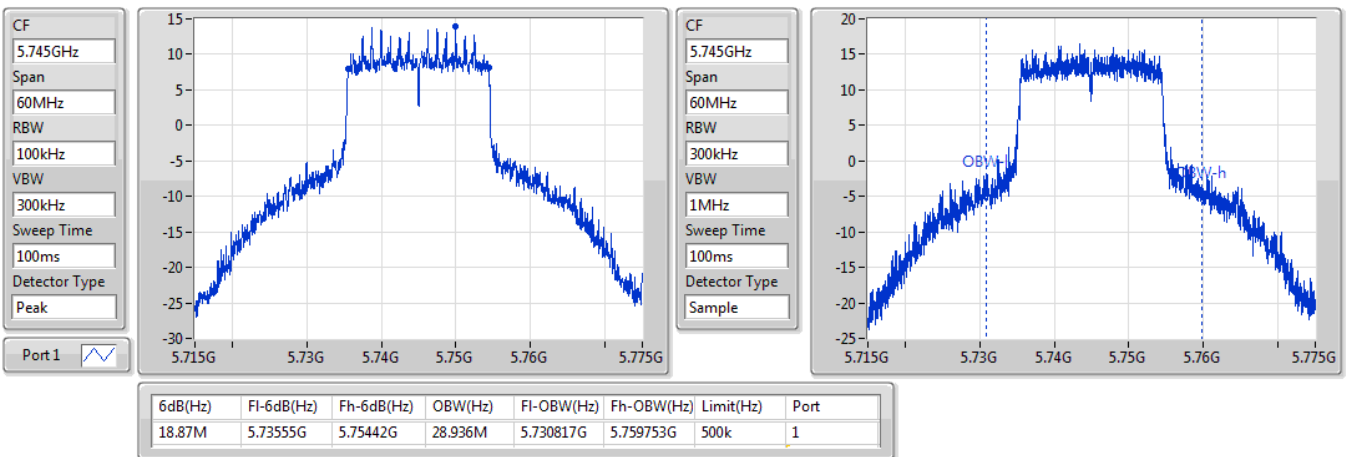

802.11ax HEW20_Nss1,(MCS0)_1TX

EBW

5785MHz

24/09/2019

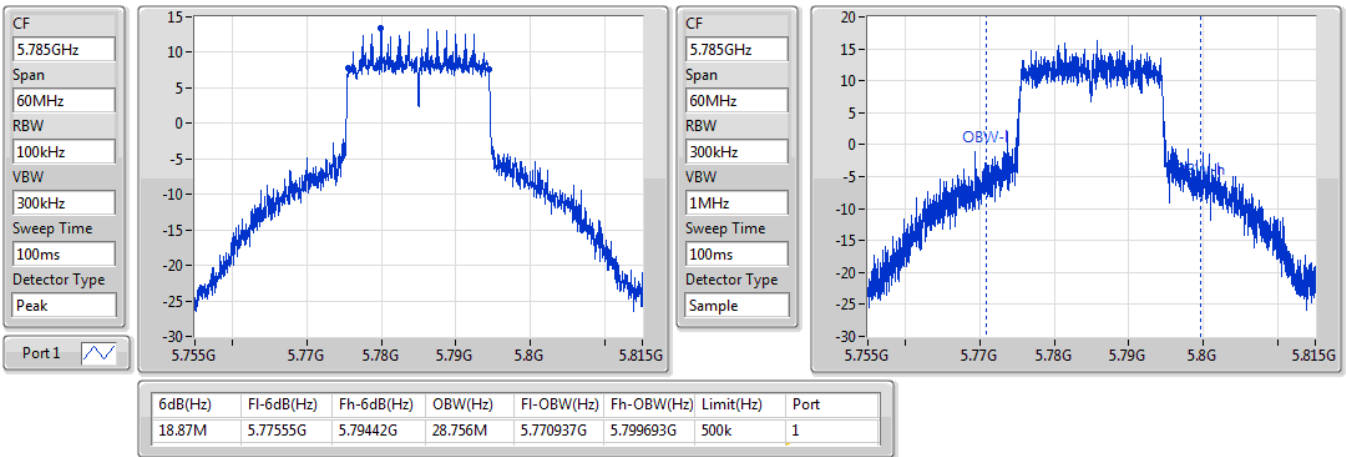

802.11ax HEW20_Nss1,(MCS0)_1TX

EBW

5825MHz

24/09/2019

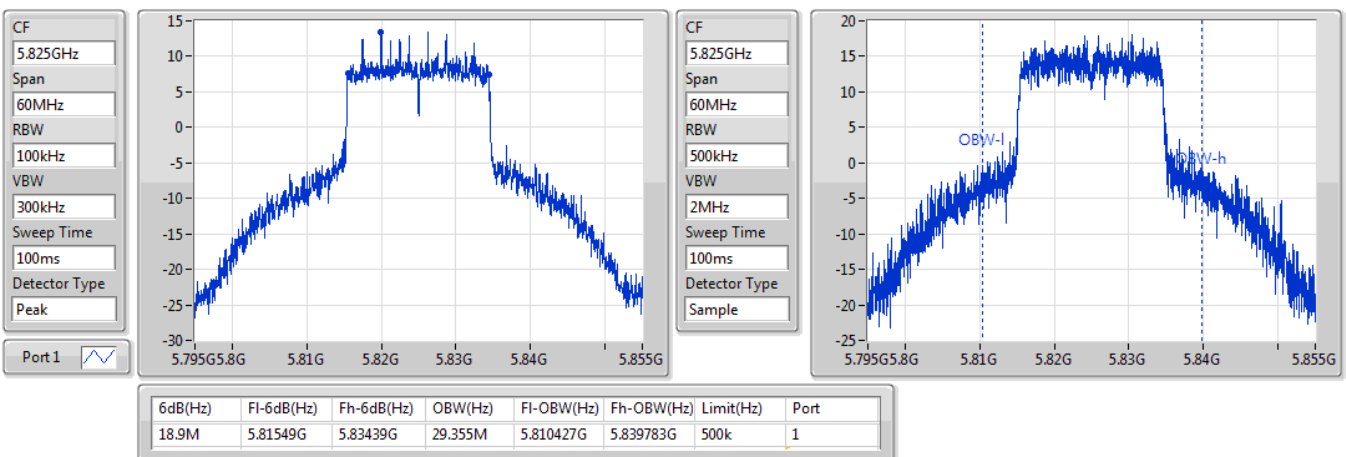

802.11ax HEW40_Nss1,(MCS0)_1TX

EBW

5190MHz

24/09/2019

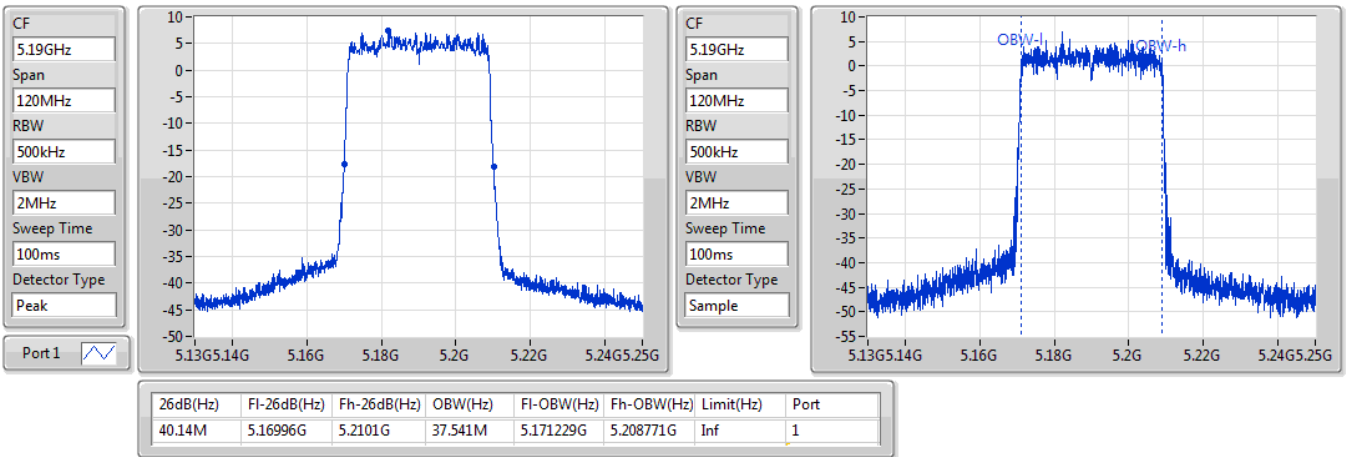

802.11ax HEW40_Nss1,(MCS0)_1TX

EBW

5230MHz

24/09/2019

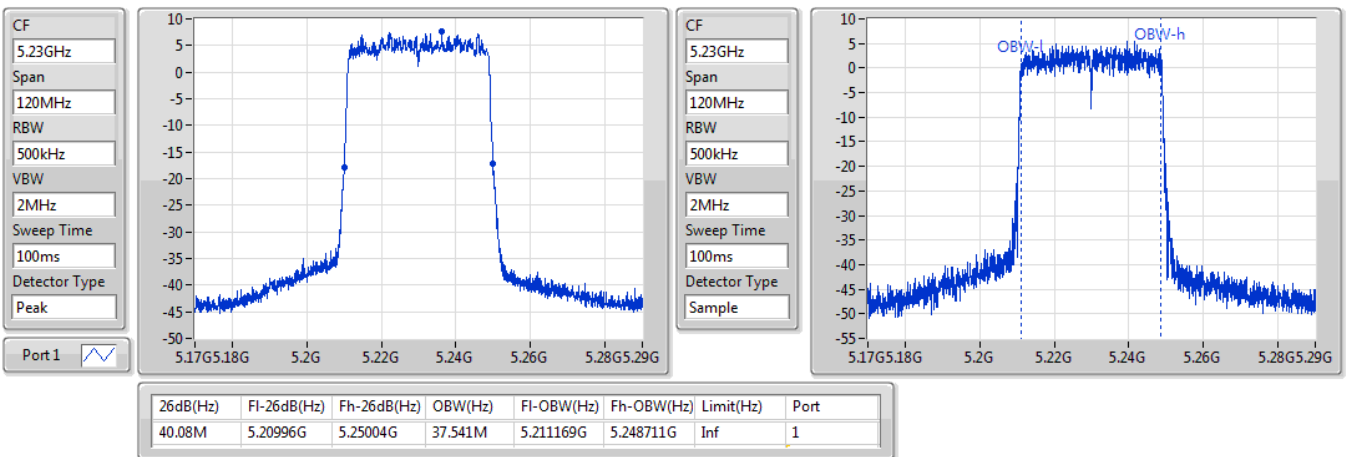

802.11ax HEW40_Nss1,(MCS0)_1TX

EBW

5755MHz

24/09/2019

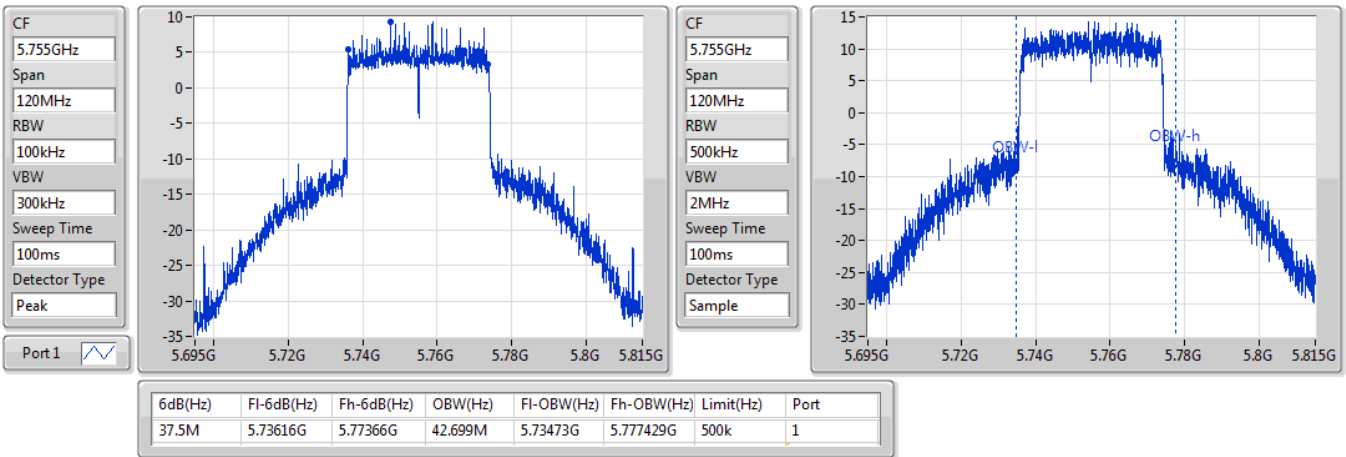

802.11ax HEW40_Nss1,(MCS0)_1TX

EBW

5795MHz

24/09/2019

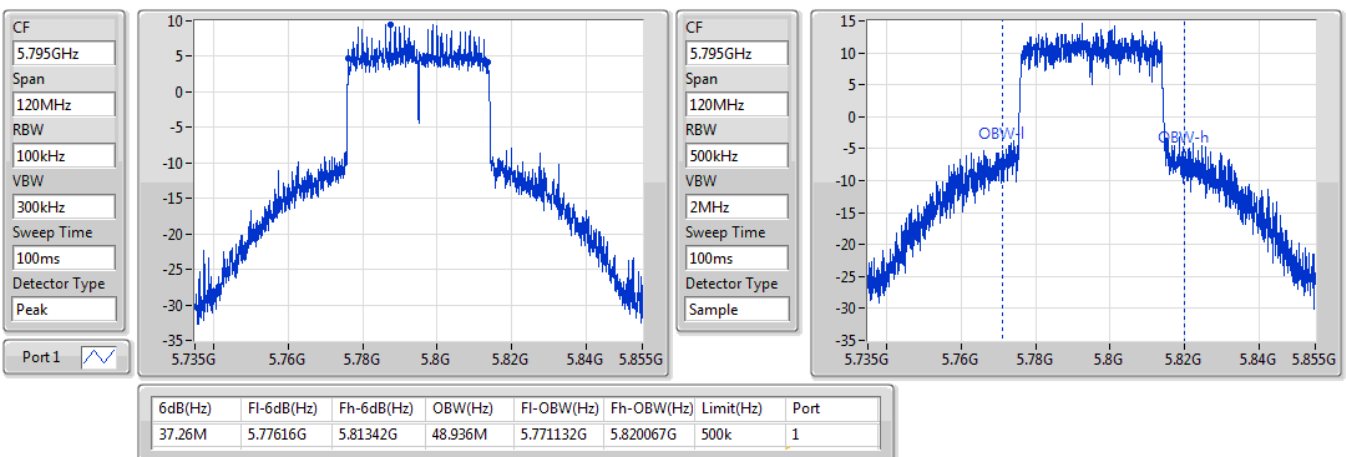

802.11ax HEW80_Nss1,(MCS0)_1TX

EBW

5210MHz

24/09/2019

CF: 5.21GHz
 Span: 240MHz
 RBW: 1MHz
 VBW: 3MHz
 Sweep Time: 100ms
 Detector Type: Peak
 Port 1

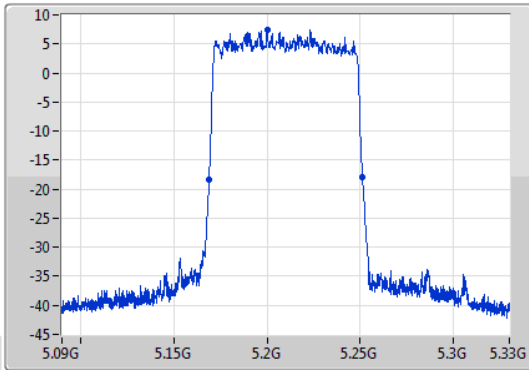

CF: 5.21GHz
 Span: 240MHz
 RBW: 1MHz
 VBW: 3MHz
 Sweep Time: 100ms
 Detector Type: Sample

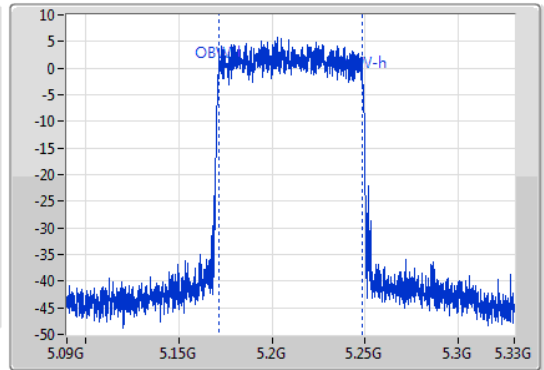

26dB(Hz)	Fl-26dB(Hz)	Fh-26dB(Hz)	OBW(Hz)	Fl-OBW(Hz)	Fh-OBW(Hz)	Limit(Hz)	Port
82.32M	5.16896G	5.25128G	76.882M	5.171379G	5.248261G	Inf	1

802.11ax HEW80_Nss1,(MCS0)_1TX

EBW

5775MHz

24/09/2019

CF: 5.775GHz
 Span: 240MHz
 RBW: 100kHz
 VBW: 300kHz
 Sweep Time: 100ms
 Detector Type: Peak
 Port 1

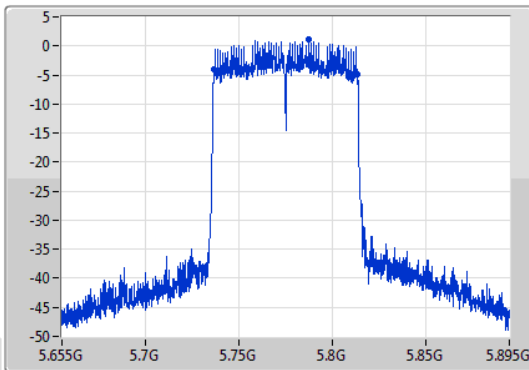

CF: 5.775GHz
 Span: 240MHz
 RBW: 1MHz
 VBW: 3MHz
 Sweep Time: 100ms
 Detector Type: Sample

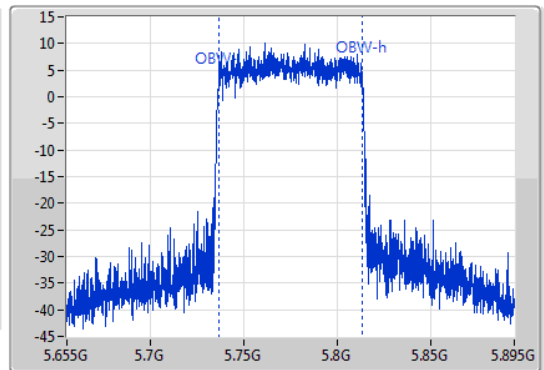

6dB(Hz)	Fl-6dB(Hz)	Fh-6dB(Hz)	OBW(Hz)	Fl-OBW(Hz)	Fh-OBW(Hz)	Limit(Hz)	Port
76.8M	5.73648G	5.81328G	76.882M	5.736499G	5.813381G	500k	1



Summary

Mode	Max-N dB (Hz)	Max-OBW (Hz)	ITU-Code	Min-N dB (Hz)	Min-OBW (Hz)
5.15-5.25GHz	-	-	-	-	-
802.11a_Nss1,(6Mbps)_2TX	21.69M	16.642M	16M6D1D	21.48M	16.552M
802.11ac VHT20_Nss2,(MCS0)_2TX	21.96M	17.811M	17M8D1D	21.6M	17.691M
802.11ac VHT40_Nss2,(MCS0)_2TX	40.14M	36.222M	36M2D1D	39.84M	36.162M
802.11ac VHT80_Nss2,(MCS0)_2TX	81.72M	75.802M	75M8D1D	81.6M	75.682M
802.11ax HEW20_Nss2,(MCS0)_2TX	21.9M	18.981M	19M0D1D	21.48M	18.951M
802.11ax HEW40_Nss2,(MCS0)_2TX	40.02M	37.541M	37M5D1D	39.72M	37.541M
802.11ax HEW80_Nss2,(MCS0)_2TX	81.36M	77.121M	77M1D1D	81.24M	76.882M
5.725-5.85GHz	-	-	-	-	-
802.11a_Nss1,(6Mbps)_2TX	16.32M	33.013M	33M0D1D	16.29M	23.358M
802.11ac VHT20_Nss2,(MCS0)_2TX	17.55M	34.753M	34M8D1D	16.32M	27.286M
802.11ac VHT40_Nss2,(MCS0)_2TX	36.3M	44.018M	44M0D1D	36.12M	36.402M
802.11ac VHT80_Nss2,(MCS0)_2TX	76.32M	75.682M	75M7D1D	75.72M	75.682M
802.11ax HEW20_Nss2,(MCS0)_2TX	18.84M	35.862M	35M9D1D	17.7M	27.706M
802.11ax HEW40_Nss2,(MCS0)_2TX	37.62M	45.037M	45M0D1D	37.5M	37.841M
802.11ax HEW80_Nss2,(MCS0)_2TX	76.68M	77.121M	77M1D1D	75.36M	77.001M

Max-N dB = Maximum 6dB down bandwidth for 5.725-5.85GHz band / Maximum 26dB down bandwidth for other band;

Max-OBW = Maximum 99% occupied bandwidth;

Min-N dB = Minimum 6dB down bandwidth for 5.725-5.85GHz band / Maximum 26dB down bandwidth for other band;

Min-OBW = Minimum 99% occupied bandwidth;



Result

Mode	Result	Limit (Hz)	Port 1-N dB (Hz)	Port 1-OBW (Hz)	Port 2-N dB (Hz)	Port 2-OBW (Hz)
802.11a_Nss1,(6Mbps)_2TX	-	-	-	-	-	-
5180MHz	Pass	Inf	21.48M	16.642M	21.63M	16.642M
5200MHz	Pass	Inf	21.54M	16.552M	21.69M	16.612M
5240MHz	Pass	Inf	21.57M	16.582M	21.66M	16.612M
5745MHz	Pass	500k	16.32M	23.358M	16.29M	27.826M
5785MHz	Pass	500k	16.32M	26.897M	16.32M	31.424M
5825MHz	Pass	500k	16.29M	27.526M	16.29M	33.013M
802.11ac VHT20_Nss2,(MCS0)_2TX	-	-	-	-	-	-
5180MHz	Pass	Inf	21.96M	17.781M	21.63M	17.721M
5200MHz	Pass	Inf	21.96M	17.781M	21.6M	17.691M
5240MHz	Pass	Inf	21.96M	17.811M	21.63M	17.751M
5745MHz	Pass	500k	17.52M	27.286M	17.55M	31.754M
5785MHz	Pass	500k	17.55M	27.946M	17.55M	33.913M
5825MHz	Pass	500k	17.55M	28.906M	16.32M	34.753M
802.11ac VHT40_Nss2,(MCS0)_2TX	-	-	-	-	-	-
5190MHz	Pass	Inf	39.84M	36.162M	40.08M	36.162M
5230MHz	Pass	Inf	39.84M	36.222M	40.14M	36.222M
5755MHz	Pass	500k	36.3M	36.402M	36.3M	36.642M
5795MHz	Pass	500k	36.3M	36.942M	36.12M	44.018M
802.11ac VHT80_Nss2,(MCS0)_2TX	-	-	-	-	-	-
5210MHz	Pass	Inf	81.72M	75.802M	81.6M	75.682M
5775MHz	Pass	500k	76.32M	75.682M	75.72M	75.682M
802.11ax HEW20_Nss2,(MCS0)_2TX	-	-	-	-	-	-
5180MHz	Pass	Inf	21.84M	18.951M	21.48M	18.951M
5200MHz	Pass	Inf	21.9M	18.951M	21.51M	18.981M
5240MHz	Pass	Inf	21.87M	18.951M	21.51M	18.981M
5745MHz	Pass	500k	18.84M	27.706M	18.24M	32.564M
5785MHz	Pass	500k	18.57M	29.355M	17.7M	35.022M
5825MHz	Pass	500k	18.6M	28.996M	18.15M	35.862M
802.11ax HEW40_Nss2,(MCS0)_2TX	-	-	-	-	-	-
5190MHz	Pass	Inf	40.02M	37.541M	39.72M	37.541M
5230MHz	Pass	Inf	40.02M	37.541M	39.72M	37.541M
5755MHz	Pass	500k	37.62M	37.841M	37.5M	37.961M
5795MHz	Pass	500k	37.62M	38.261M	37.5M	45.037M
802.11ax HEW80_Nss2,(MCS0)_2TX	-	-	-	-	-	-
5210MHz	Pass	Inf	81.24M	76.882M	81.36M	77.121M
5775MHz	Pass	500k	76.68M	77.001M	75.36M	77.121M

Port X-N dB = Port X 6dB down bandwidth for 5.725-5.85GHz band / 26dB down bandwidth for other band

Port X-OBW = Port X 99% occupied bandwidth;

802.11a_Nss1,(6Mbps)_2TX

EBW

5180MHz

24/09/2019

CF: 5.18GHz
 Span: 60MHz
 RBW: 300kHz
 VBW: 1MHz
 Sweep Time: 100ms
 Detector Type: Peak

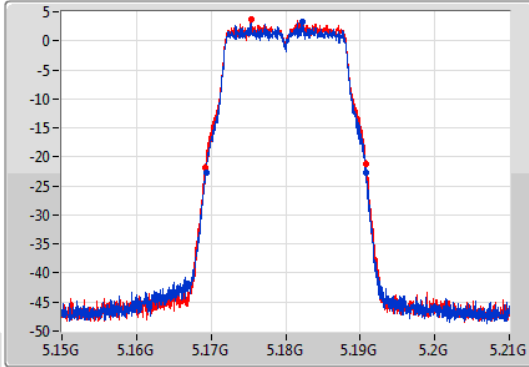

CF: 5.18GHz
 Span: 60MHz
 RBW: 200kHz
 VBW: 1MHz
 Sweep Time: 100ms
 Detector Type: Sample

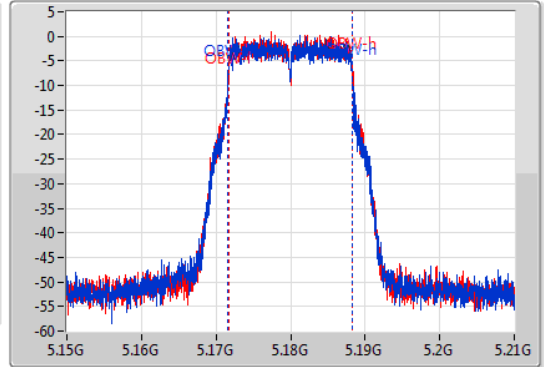

26dB(Hz)	Fl-26dB(Hz)	Fh-26dB(Hz)	OBW(Hz)	Fl-OBW(Hz)	Fh-OBW(Hz)	Limit(Hz)	Port
21.48M	5.16932G	5.1908G	16.642M	5.171634G	5.188276G	Inf	1
21.63M	5.1692G	5.19083G	16.642M	5.171664G	5.188306G	Inf	2

802.11a_Nss1,(6Mbps)_2TX

EBW

5200MHz

24/09/2019

CF: 5.2GHz
 Span: 60MHz
 RBW: 300kHz
 VBW: 1MHz
 Sweep Time: 100ms
 Detector Type: Peak

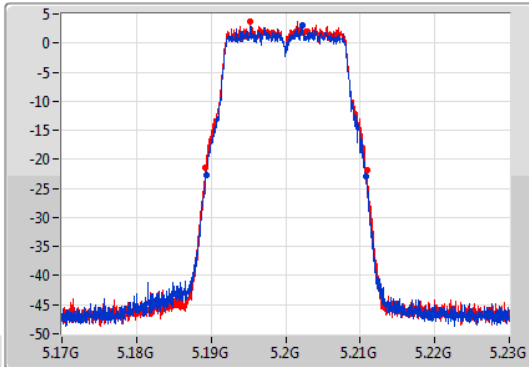

CF: 5.2GHz
 Span: 60MHz
 RBW: 200kHz
 VBW: 1MHz
 Sweep Time: 100ms
 Detector Type: Sample

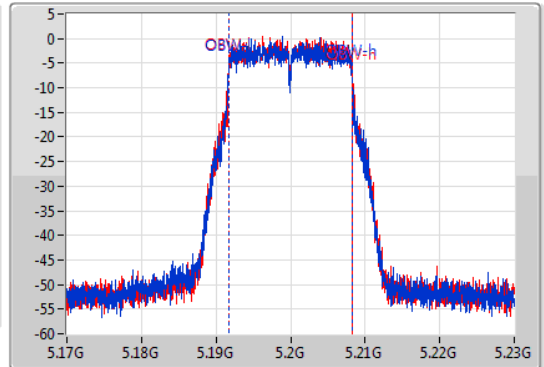

26dB(Hz)	Fl-26dB(Hz)	Fh-26dB(Hz)	OBW(Hz)	Fl-OBW(Hz)	Fh-OBW(Hz)	Limit(Hz)	Port
21.54M	5.18932G	5.21086G	16.552M	5.191664G	5.208216G	Inf	1
21.69M	5.18923G	5.21092G	16.612M	5.191664G	5.208276G	Inf	2

802.11a_Nss1,(6Mbps)_2TX

EBW

5240MHz

24/09/2019

CF
5.24GHz
Span
60MHz
RBW
300kHz
VBW
1MHz
Sweep Time
100ms
Detector Type
Peak

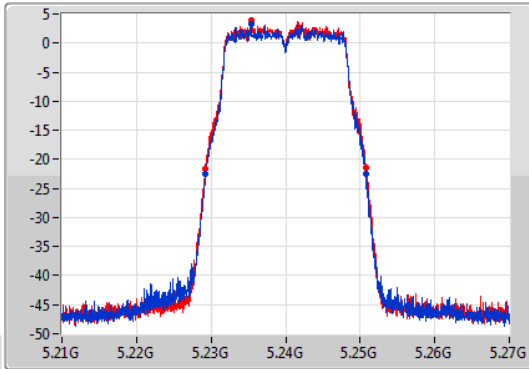

CF
5.24GHz
Span
60MHz
RBW
200kHz
VBW
1MHz
Sweep Time
100ms
Detector Type
Sample

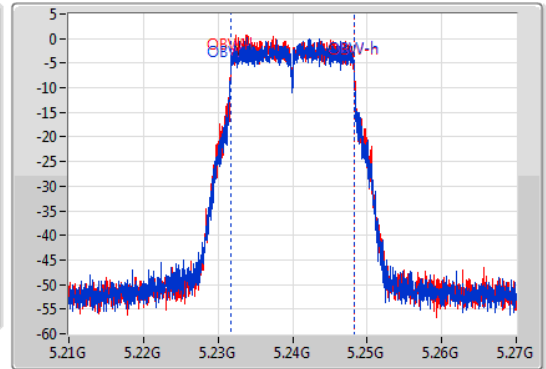

26dB(Hz)	Fl-26dB(Hz)	Fh-26dB(Hz)	OBW(Hz)	Fl-OBW(Hz)	Fh-OBW(Hz)	Limit(Hz)	Port
21.57M	5.22926G	5.25083G	16.582M	5.231664G	5.248246G	Inf	1
21.66M	5.2292G	5.25086G	16.612M	5.231664G	5.248276G	Inf	2

802.11a_Nss1,(6Mbps)_2TX

EBW

5745MHz

27/09/2019

CF
5.745GHz
Span
60MHz
RBW
100kHz
VBW
300kHz
Sweep Time
100ms
Detector Type
Peak

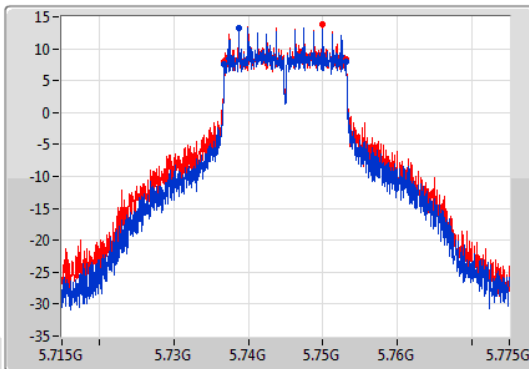

CF
5.745GHz
Span
60MHz
RBW
300kHz
VBW
1MHz
Sweep Time
100ms
Detector Type
Sample

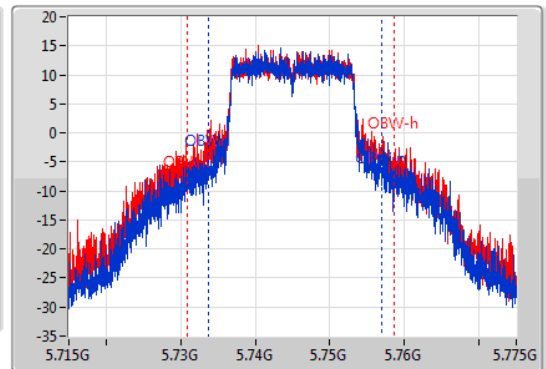

6dB(Hz)	Fl-6dB(Hz)	Fh-6dB(Hz)	OBW(Hz)	Fl-OBW(Hz)	Fh-OBW(Hz)	Limit(Hz)	Port
16.32M	5.73681G	5.75313G	23.358M	5.733666G	5.757024G	500k	1
16.29M	5.73681G	5.7531G	27.826M	5.730877G	5.758703G	500k	2

802.11a_Nss1,(6Mbps)_2TX

EBW

5785MHz

24/09/2019

CF
5.785GHz
Span
60MHz
RBW
100kHz
VBW
300kHz
Sweep Time
100ms
Detector Type
Peak

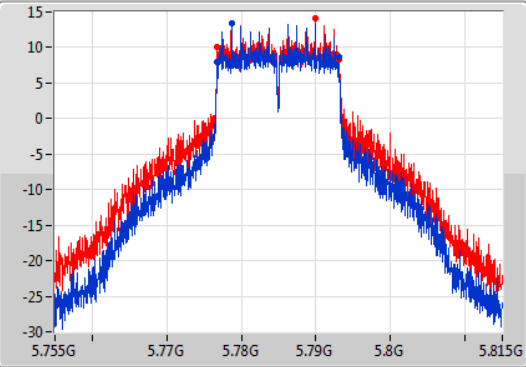

CF
5.785GHz
Span
60MHz
RBW
500kHz
VBW
2MHz
Sweep Time
100ms
Detector Type
Sample

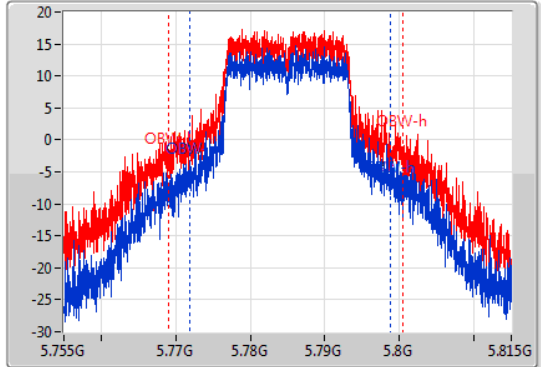

6dB(Hz)	Fl-6dB(Hz)	Fh-6dB(Hz)	OBW(Hz)	Fl-OBW(Hz)	Fh-OBW(Hz)	Limit(Hz)	Port
16.32M	5.77678G	5.7931G	26.897M	5.771837G	5.798733G	500k	1
16.32M	5.77681G	5.79313G	31.424M	5.769018G	5.800442G	500k	2

802.11a_Nss1,(6Mbps)_2TX

EBW

5825MHz

24/09/2019

CF
5.825GHz
Span
60MHz
RBW
100kHz
VBW
300kHz
Sweep Time
100ms
Detector Type
Peak

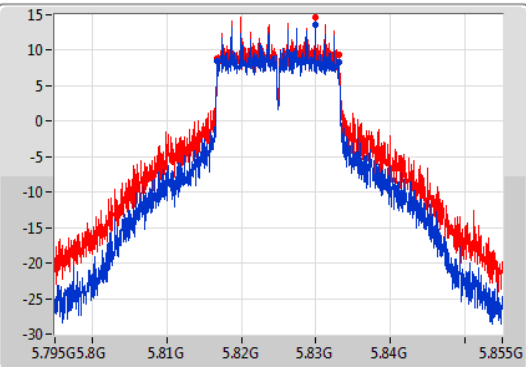

CF
5.825GHz
Span
60MHz
RBW
500kHz
VBW
2MHz
Sweep Time
100ms
Detector Type
Sample

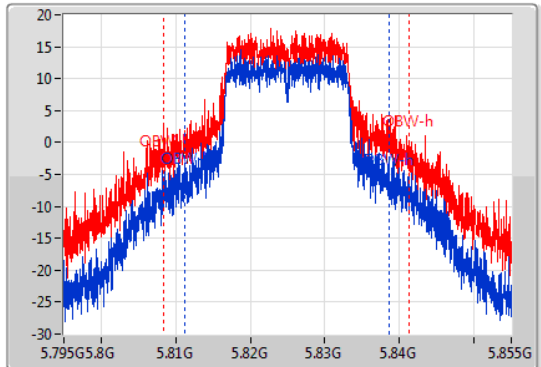

6dB(Hz)	Fl-6dB(Hz)	Fh-6dB(Hz)	OBW(Hz)	Fl-OBW(Hz)	Fh-OBW(Hz)	Limit(Hz)	Port
16.29M	5.81681G	5.8331G	27.526M	5.811177G	5.838703G	500k	1
16.29M	5.81681G	5.8331G	33.013M	5.808358G	5.841372G	500k	2

802.11ac VHT20_Nss2,(MCS0)_2TX

EBW

5180MHz

24/09/2019

CF
5.18GHz
Span
60MHz
RBW
300kHz
VBW
1MHz
Sweep Time
100ms
Detector Type
Peak

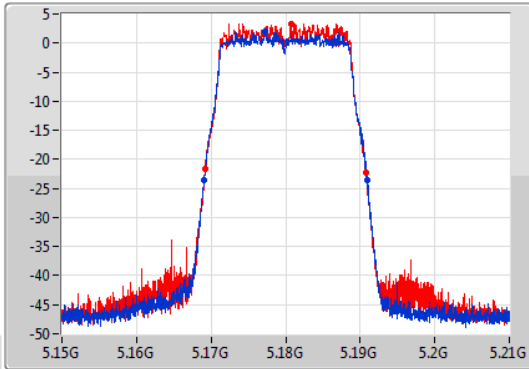

CF
5.18GHz
Span
60MHz
RBW
200kHz
VBW
1MHz
Sweep Time
100ms
Detector Type
Sample

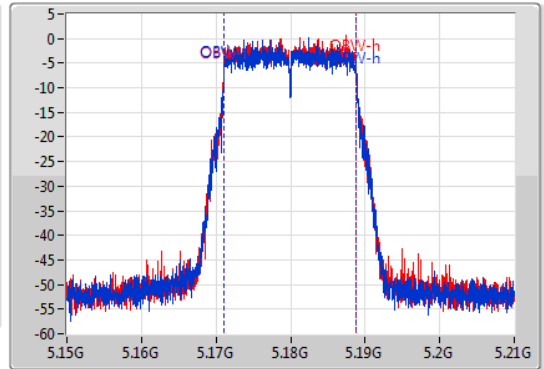

26dB(Hz)	Fl-26dB(Hz)	Fh-26dB(Hz)	OBW(Hz)	Fl-OBW(Hz)	Fh-OBW(Hz)	Limit(Hz)	Port
21.96M	5.16902G	5.19098G	17.781M	5.171064G	5.188846G	Inf	1
21.63M	5.16917G	5.1908G	17.721M	5.171094G	5.188816G	Inf	2

802.11ac VHT20_Nss2,(MCS0)_2TX

EBW

5200MHz

24/09/2019

CF
5.2GHz
Span
60MHz
RBW
300kHz
VBW
1MHz
Sweep Time
100ms
Detector Type
Peak

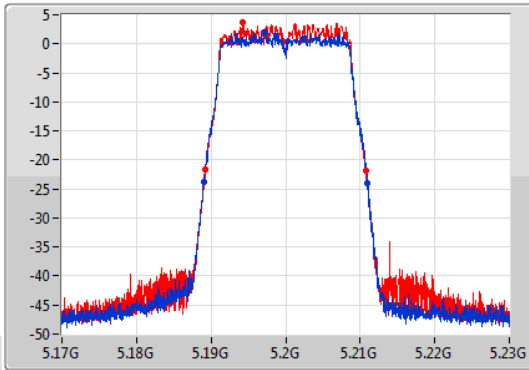

CF
5.2GHz
Span
60MHz
RBW
200kHz
VBW
1MHz
Sweep Time
100ms
Detector Type
Sample

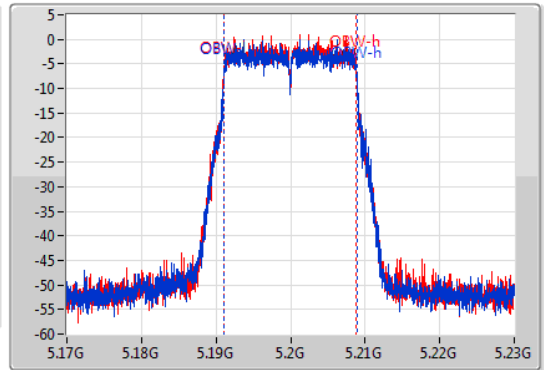

26dB(Hz)	Fl-26dB(Hz)	Fh-26dB(Hz)	OBW(Hz)	Fl-OBW(Hz)	Fh-OBW(Hz)	Limit(Hz)	Port
21.96M	5.18905G	5.21101G	17.781M	5.191094G	5.208876G	Inf	1
21.6M	5.1892G	5.2108G	17.691M	5.191094G	5.208786G	Inf	2

802.11ac VHT20_Nss2,(MCS0)_2TX

EBW

5240MHz

24/09/2019

CF
5.24GHz
Span
60MHz
RBW
300kHz
VBW
1MHz
Sweep Time
100ms
Detector Type
Peak

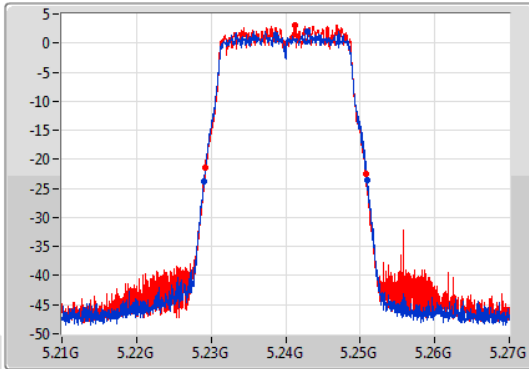

CF
5.24GHz
Span
60MHz
RBW
200kHz
VBW
1MHz
Sweep Time
100ms
Detector Type
Sample

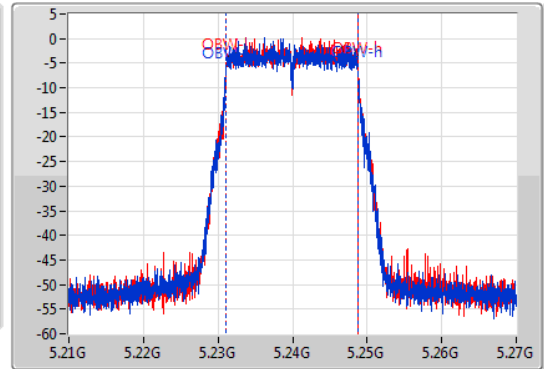

26dB(Hz)	Fl-26dB(Hz)	Fh-26dB(Hz)	OBW(Hz)	Fl-OBW(Hz)	Fh-OBW(Hz)	Limit(Hz)	Port
21.96M	5.22902G	5.25098G	17.811M	5.231034G	5.248846G	Inf	1
21.63M	5.22917G	5.2508G	17.751M	5.231094G	5.248846G	Inf	2

802.11ac VHT20_Nss2,(MCS0)_2TX

EBW

5745MHz

24/09/2019

CF
5.745GHz
Span
60MHz
RBW
100kHz
VBW
300kHz
Sweep Time
100ms
Detector Type
Peak

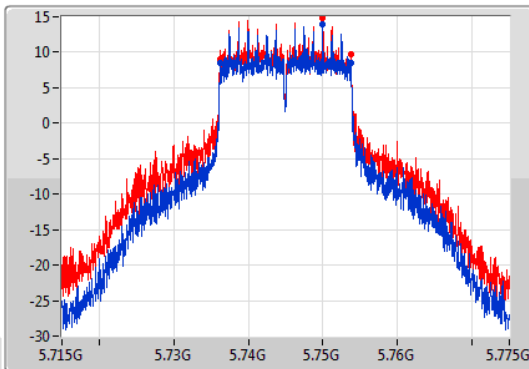

CF
5.745GHz
Span
60MHz
RBW
500kHz
VBW
2MHz
Sweep Time
100ms
Detector Type
Sample

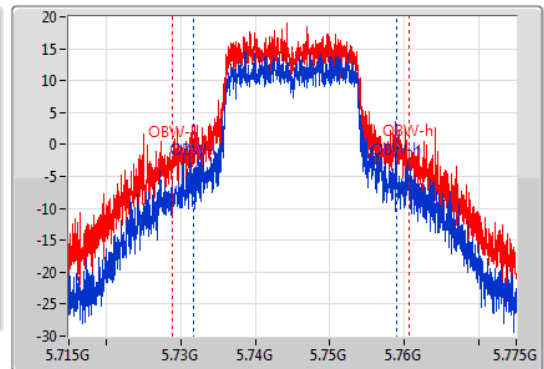

6dB(Hz)	Fl-6dB(Hz)	Fh-6dB(Hz)	OBW(Hz)	Fl-OBW(Hz)	Fh-OBW(Hz)	Limit(Hz)	Port
17.52M	5.73621G	5.75373G	27.286M	5.731657G	5.758943G	500k	1
17.55M	5.73618G	5.75373G	31.754M	5.728868G	5.760622G	500k	2

802.11ac VHT20_Nss2,(MCS0)_2TX

EBW

5785MHz

24/09/2019

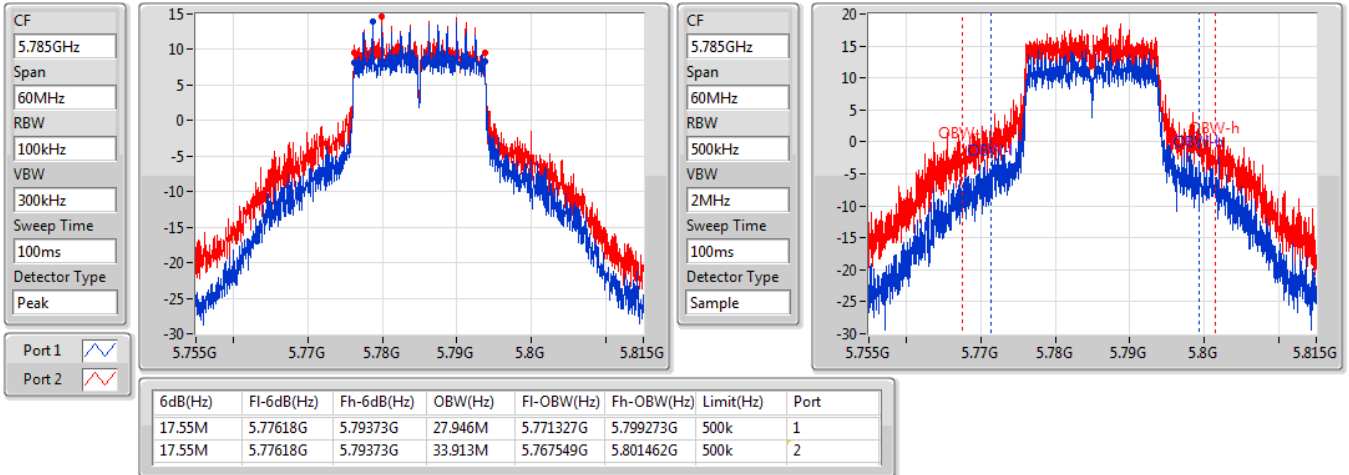

802.11ac VHT20_Nss2,(MCS0)_2TX

EBW

5825MHz

24/09/2019

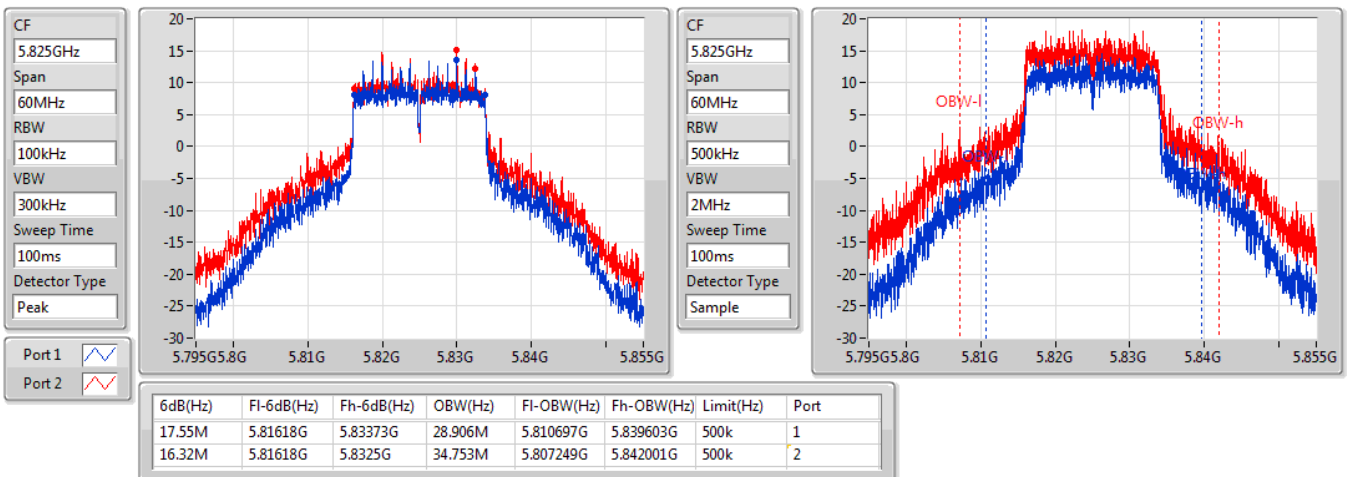

802.11ac VHT40_Nss2,(MCS0)_2TX

EBW

5190MHz

24/09/2019

CF
5.19GHz
Span
120MHz
RBW
500kHz
VBW
2MHz
Sweep Time
100ms
Detector Type
Peak

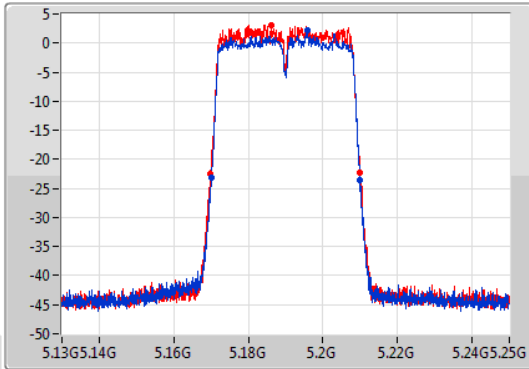

CF
5.19GHz
Span
120MHz
RBW
500kHz
VBW
2MHz
Sweep Time
100ms
Detector Type
Sample

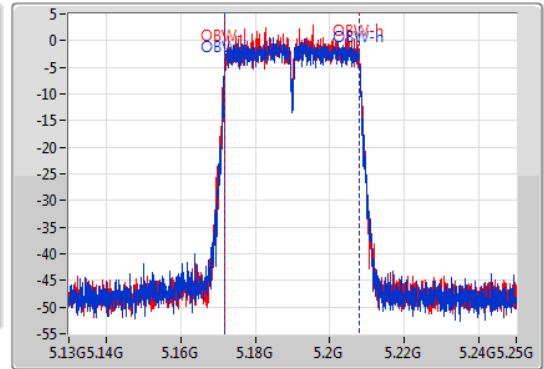

Port 1
Port 2

26dB(Hz)	Fl-26dB(Hz)	Fh-26dB(Hz)	OBW(Hz)	Fl-OBW(Hz)	Fh-OBW(Hz)	Limit(Hz)	Port
39.84M	5.17008G	5.20992G	36.162M	5.171829G	5.207991G	Inf	1
40.08M	5.16984G	5.20992G	36.162M	5.171829G	5.207991G	Inf	2

802.11ac VHT40_Nss2,(MCS0)_2TX

EBW

5230MHz

24/09/2019

CF
5.23GHz
Span
120MHz
RBW
500kHz
VBW
2MHz
Sweep Time
100ms
Detector Type
Peak

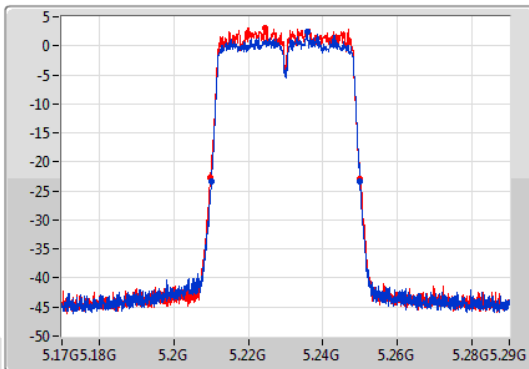

CF
5.23GHz
Span
120MHz
RBW
500kHz
VBW
2MHz
Sweep Time
100ms
Detector Type
Sample

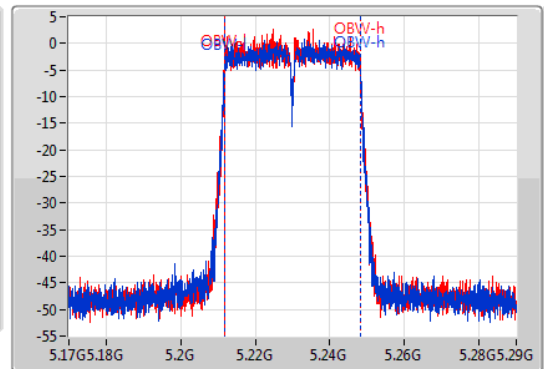

Port 1
Port 2

26dB(Hz)	Fl-26dB(Hz)	Fh-26dB(Hz)	OBW(Hz)	Fl-OBW(Hz)	Fh-OBW(Hz)	Limit(Hz)	Port
39.84M	5.21008G	5.24992G	36.222M	5.211829G	5.248051G	Inf	1
40.14M	5.20984G	5.24998G	36.222M	5.211829G	5.248051G	Inf	2

802.11ac VHT40_Nss2,(MCS0)_2TX

EBW

5755MHz

24/09/2019

CF
5.755GHz
Span
120MHz
RBW
100kHz
VBW
300kHz
Sweep Time
100ms
Detector Type
Peak

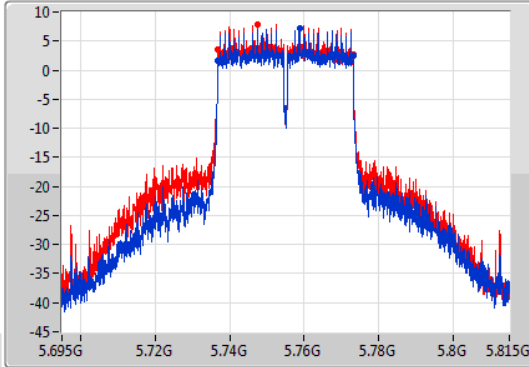

CF
5.755GHz
Span
120MHz
RBW
500kHz
VBW
2MHz
Sweep Time
100ms
Detector Type
Sample

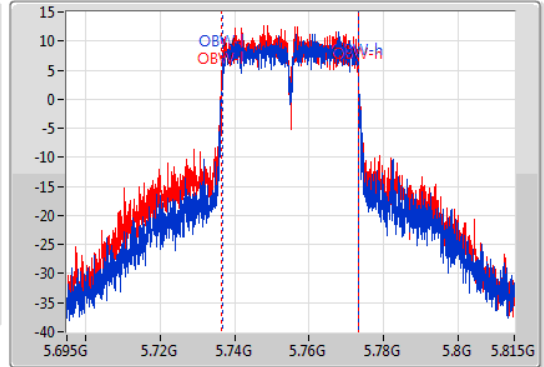

6dB(Hz)	Fl-6dB(Hz)	Fh-6dB(Hz)	OBW(Hz)	Fl-OBW(Hz)	Fh-OBW(Hz)	Limit(Hz)	Port
36.3M	5.73682G	5.77312G	36.402M	5.736769G	5.773171G	500k	1
36.3M	5.73682G	5.77312G	36.642M	5.736589G	5.773231G	500k	2

802.11ac VHT40_Nss2,(MCS0)_2TX

EBW

5795MHz

24/09/2019

CF
5.795GHz
Span
120MHz
RBW
100kHz
VBW
300kHz
Sweep Time
100ms
Detector Type
Peak

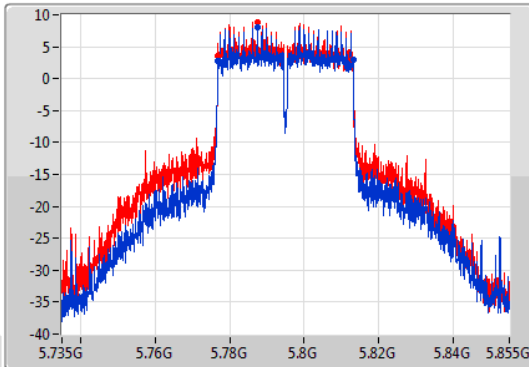

CF
5.795GHz
Span
120MHz
RBW
500kHz
VBW
2MHz
Sweep Time
100ms
Detector Type
Sample

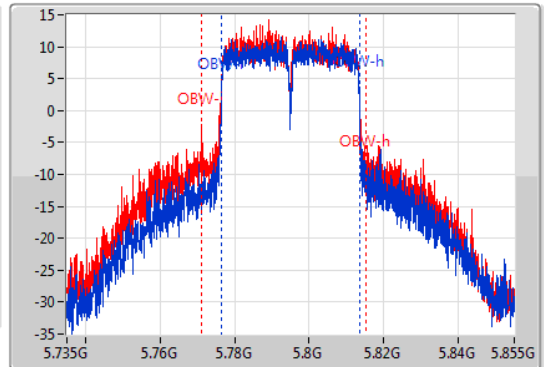

6dB(Hz)	Fl-6dB(Hz)	Fh-6dB(Hz)	OBW(Hz)	Fl-OBW(Hz)	Fh-OBW(Hz)	Limit(Hz)	Port
36.3M	5.77682G	5.81312G	36.942M	5.776529G	5.813471G	500k	1
36.12M	5.77676G	5.81288G	44.018M	5.771072G	5.81509G	500k	2

802.11ac VHT80_Nss2,(MCS0)_2TX

EBW

5210MHz

24/09/2019

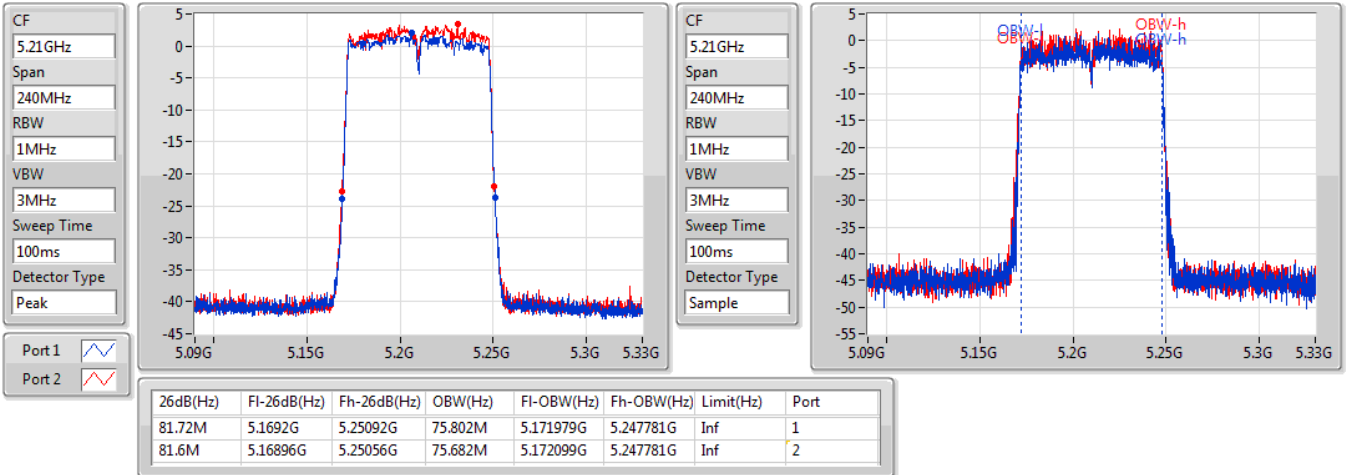

802.11ac VHT80_Nss2,(MCS0)_2TX

EBW

5775MHz

24/09/2019

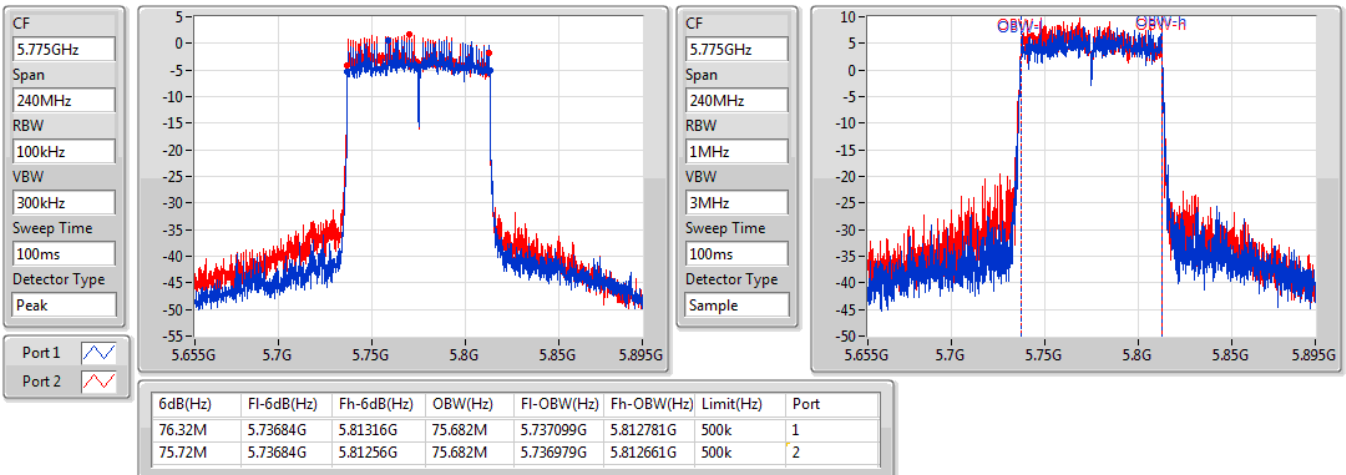

802.11ax HEW20_Nss2,(MCS0)_2TX

EBW

5180MHz

24/09/2019

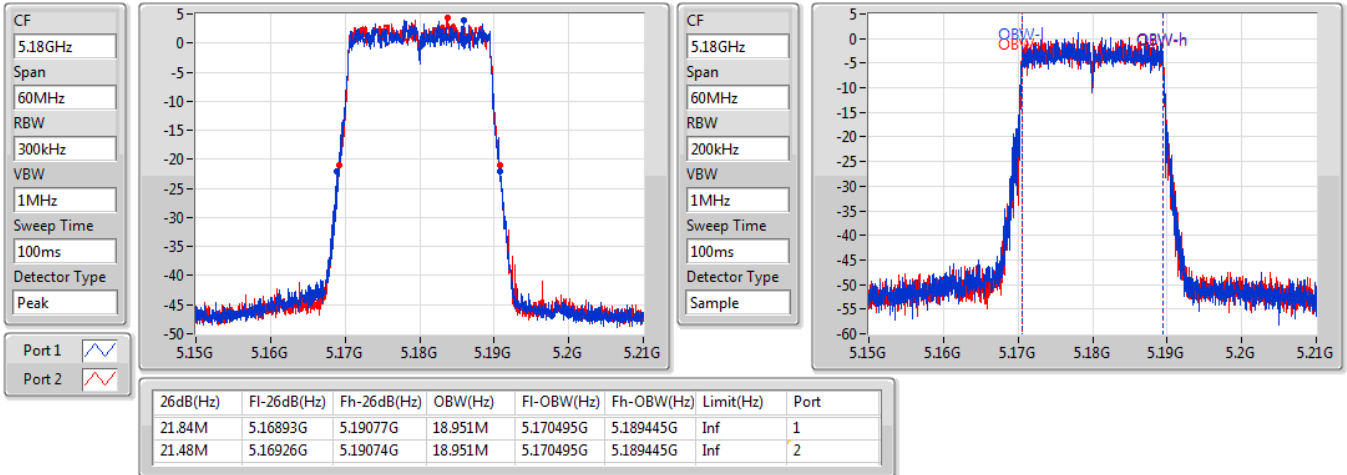

802.11ax HEW20_Nss2,(MCS0)_2TX

EBW

5200MHz

24/09/2019

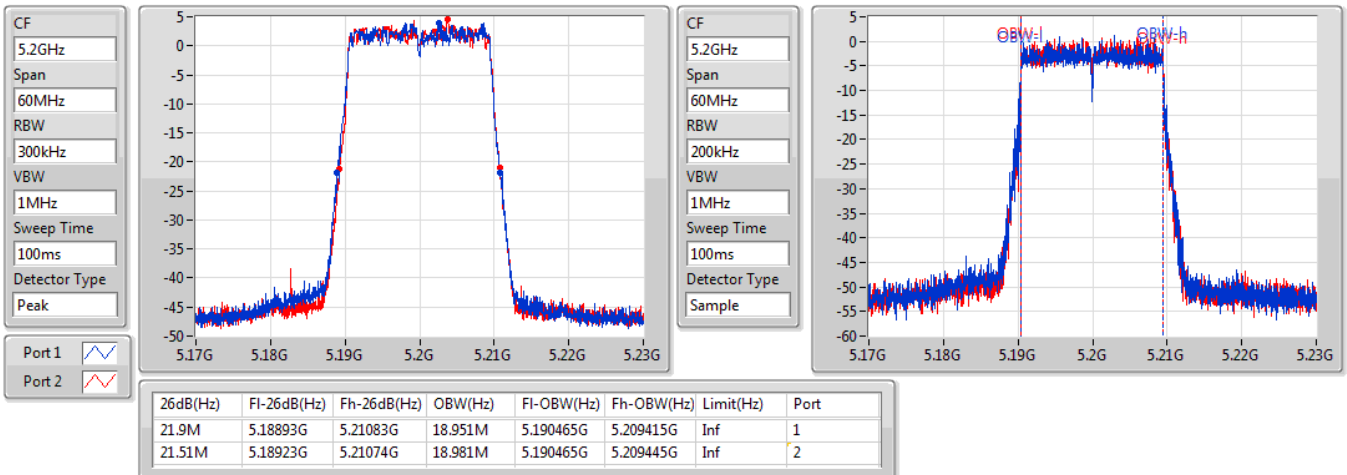

802.11ax HEW20_Nss2,(MCS0)_2TX

EBW

5240MHz

24/09/2019

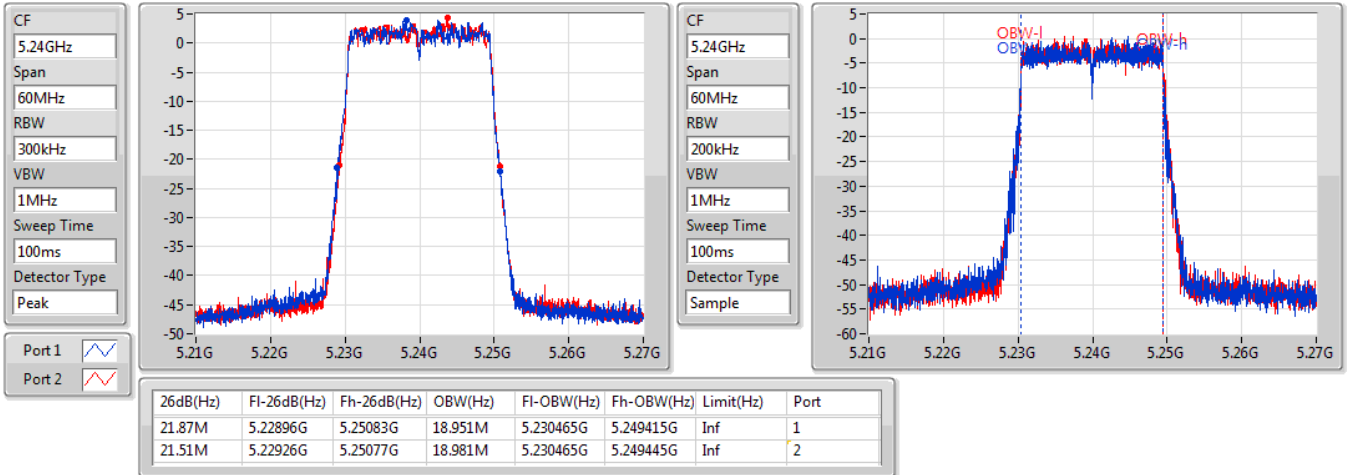

802.11ax HEW20_Nss2,(MCS0)_2TX

EBW

5745MHz

24/09/2019

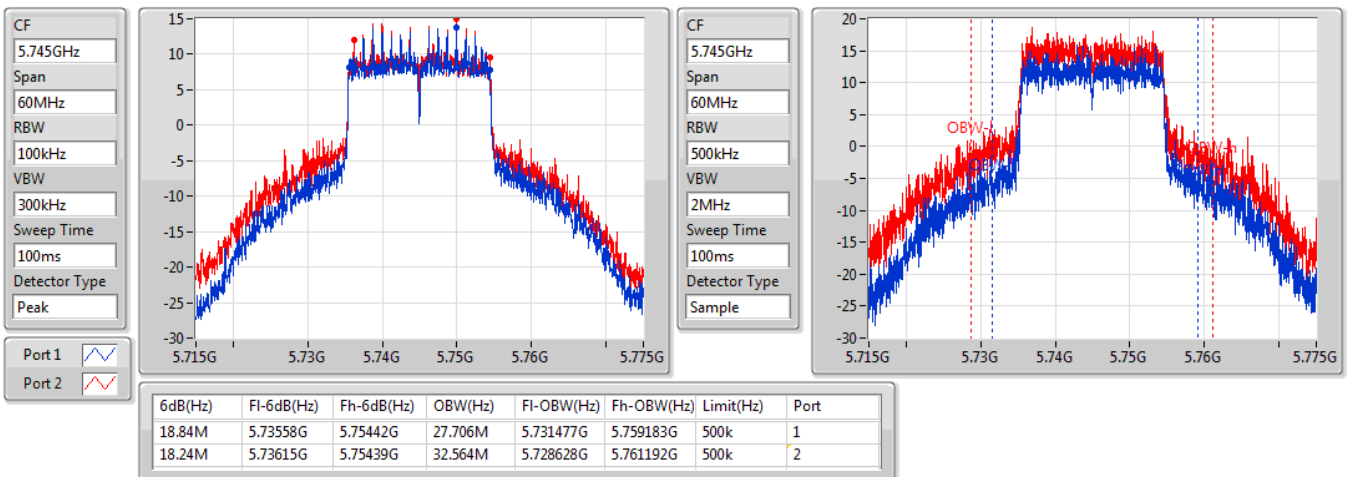

802.11ax HEW20_Nss2,(MCS0)_2TX

EBW

5785MHz

24/09/2019

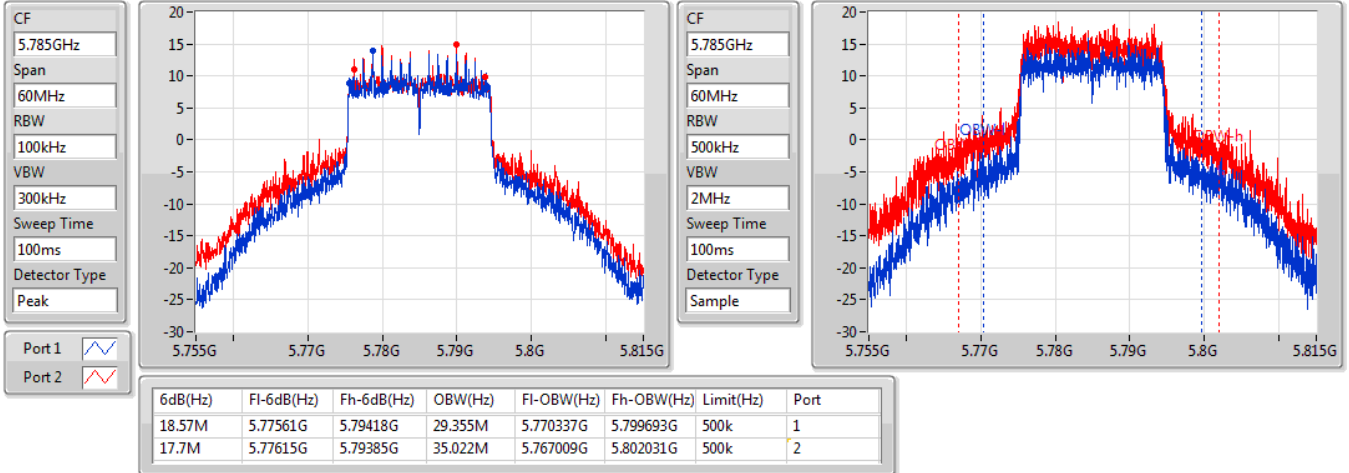

802.11ax HEW20_Nss2,(MCS0)_2TX

EBW

5825MHz

24/09/2019

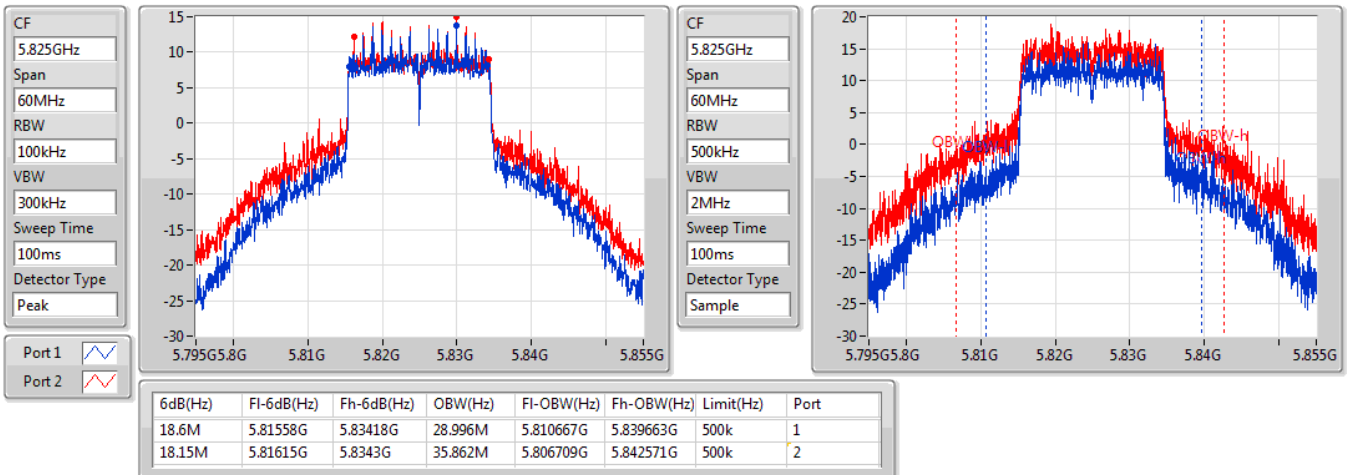

802.11ax HEW40_Nss2,(MCS0)_2TX

EBW

5190MHz

24/09/2019

CF
5.19GHz
Span
120MHz
RBW
500kHz
VBW
2MHz
Sweep Time
100ms
Detector Type
Peak

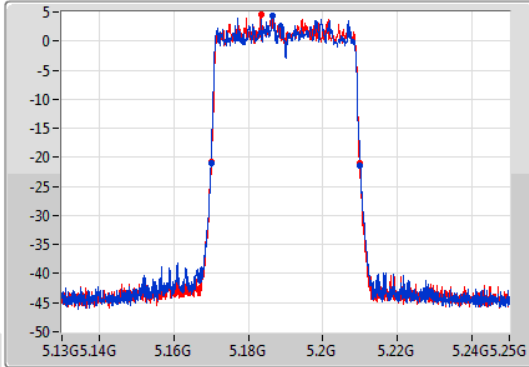

CF
5.19GHz
Span
120MHz
RBW
500kHz
VBW
2MHz
Sweep Time
100ms
Detector Type
Sample

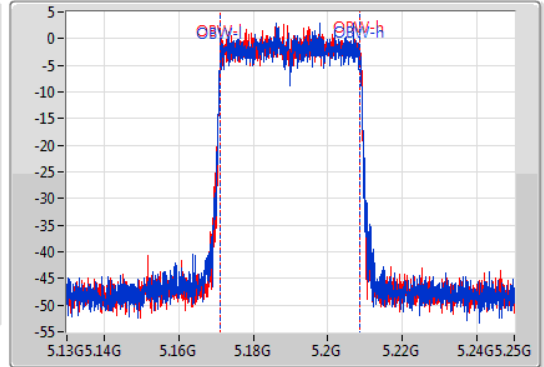

26dB(Hz)	Fl-26dB(Hz)	Fh-26dB(Hz)	OBW(Hz)	Fl-OBW(Hz)	Fh-OBW(Hz)	Limit(Hz)	Port
40.02M	5.17002G	5.21004G	37.541M	5.171169G	5.208711G	Inf	1
39.72M	5.17008G	5.2098G	37.541M	5.171169G	5.208711G	Inf	2

802.11ax HEW40_Nss2,(MCS0)_2TX

EBW

5230MHz

24/09/2019

CF
5.23GHz
Span
120MHz
RBW
500kHz
VBW
2MHz
Sweep Time
100ms
Detector Type
Peak

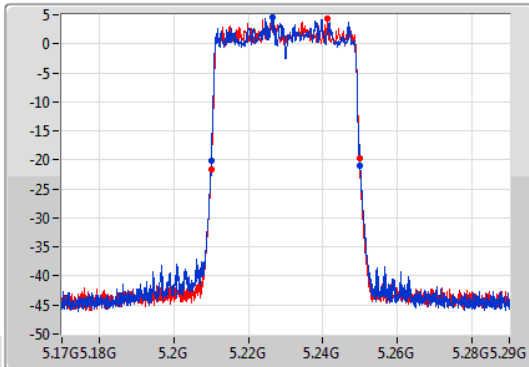

CF
5.23GHz
Span
120MHz
RBW
500kHz
VBW
2MHz
Sweep Time
100ms
Detector Type
Sample

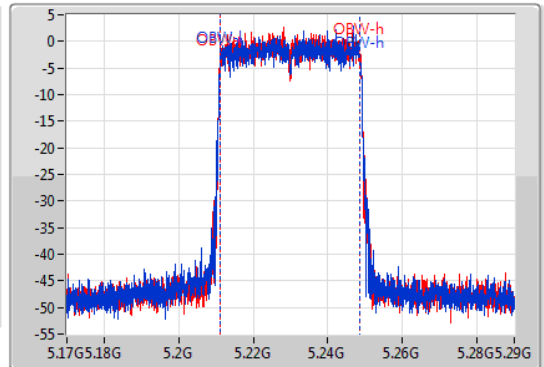

26dB(Hz)	Fl-26dB(Hz)	Fh-26dB(Hz)	OBW(Hz)	Fl-OBW(Hz)	Fh-OBW(Hz)	Limit(Hz)	Port
40.02M	5.21002G	5.25004G	37.541M	5.211169G	5.248711G	Inf	1
39.72M	5.21008G	5.2498G	37.541M	5.211169G	5.248711G	Inf	2

802.11ax HEW40_Nss2,(MCS0)_2TX

EBW

5755MHz

24/09/2019

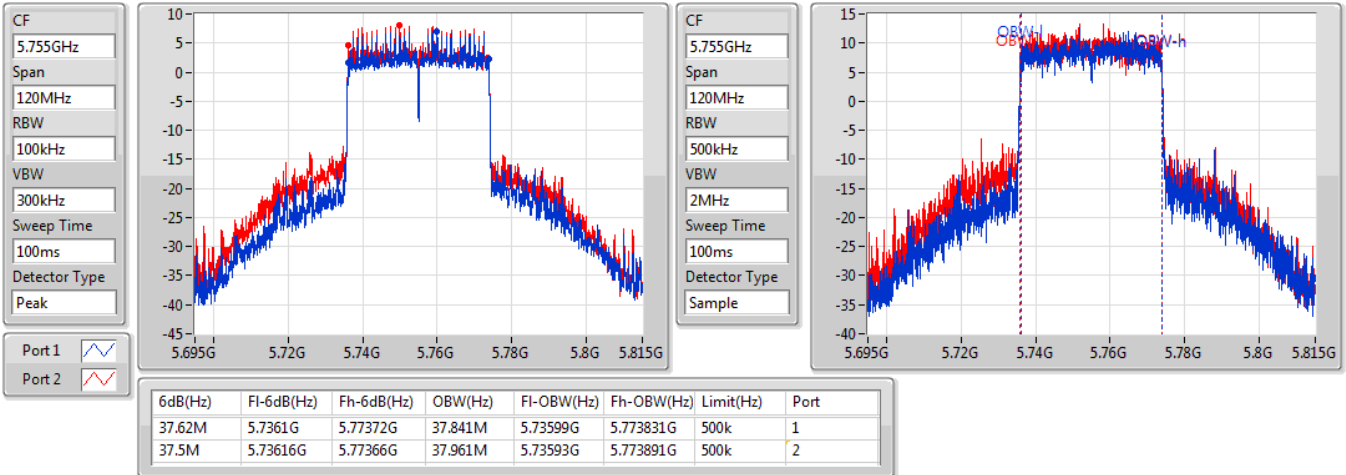

802.11ax HEW40_Nss2,(MCS0)_2TX

EBW

5795MHz

24/09/2019

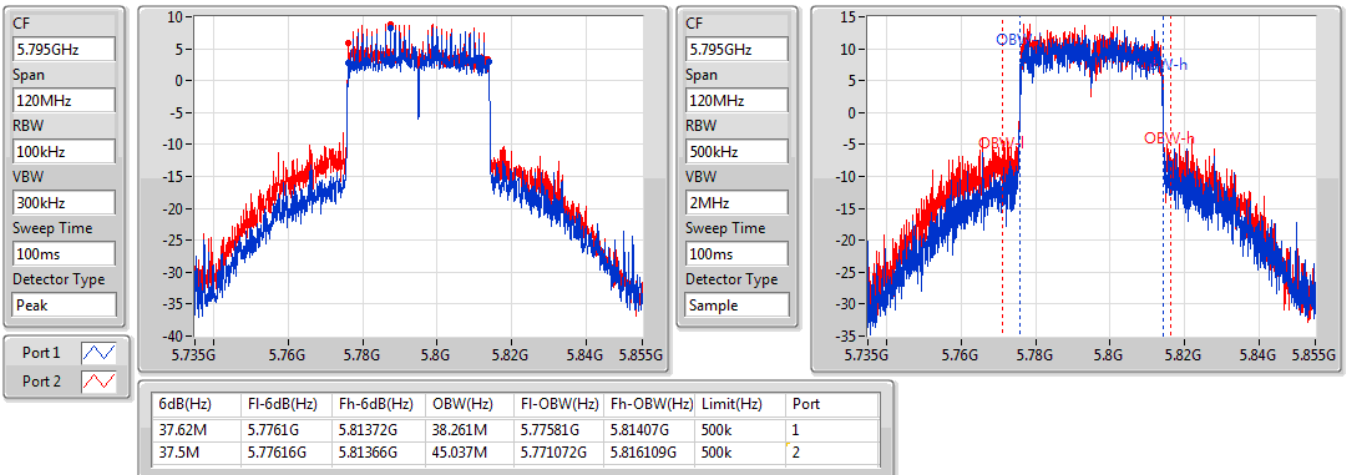

802.11ax HEW80_Nss2,(MCS0)_2TX

EBW

5210MHz

24/09/2019

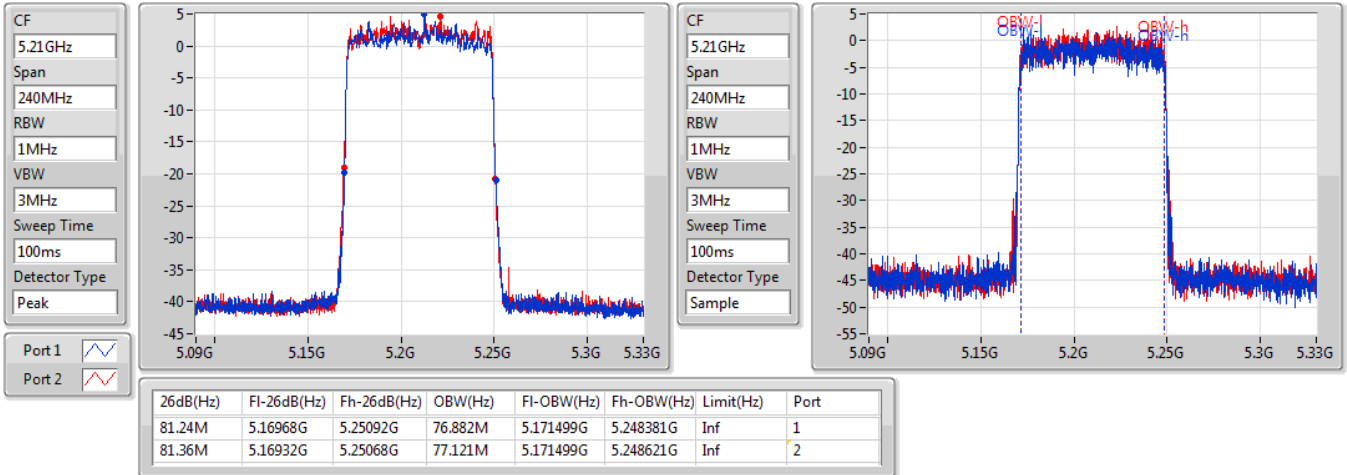

802.11ax HEW80_Nss2,(MCS0)_2TX

EBW

5775MHz

24/09/2019

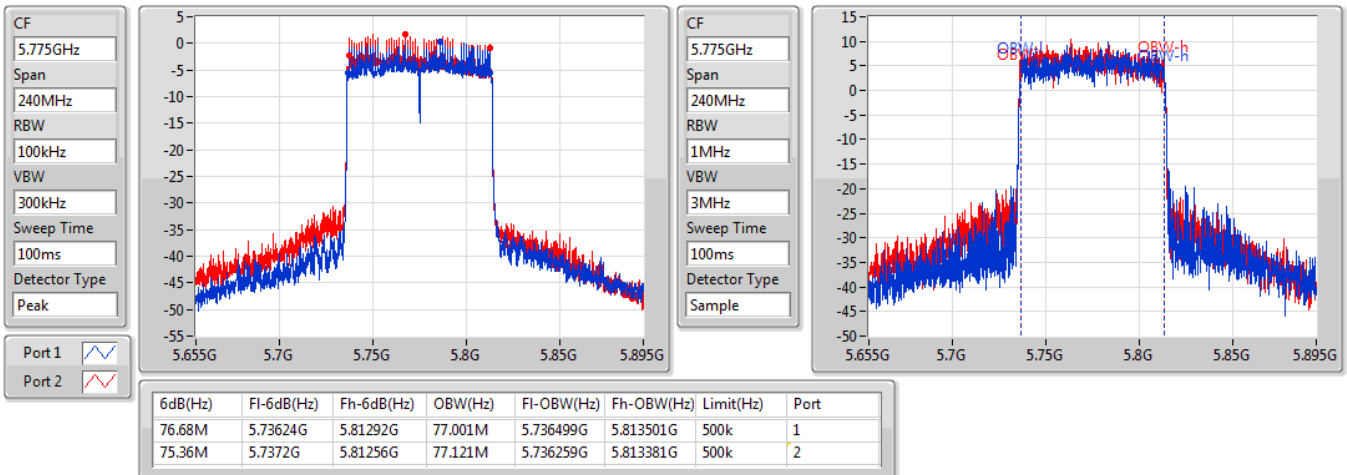



Summary

Mode	Max-N dB (Hz)	Max-OBW (Hz)	ITU-Code	Min-N dB (Hz)	Min-OBW (Hz)
5.15-5.25GHz	-	-	-	-	-
802.11a_Nss1,(6Mbps)_4TX	21.72M	16.642M	16M6D1D	21.39M	16.522M
802.11ac VHT20_Nss1,(MCS0)_4TX	21.78M	17.811M	17M8D1D	21.42M	17.751M
802.11ac VHT40_Nss1,(MCS0)_4TX	40.26M	36.282M	36M3D1D	39.72M	36.162M
802.11ac VHT80_Nss1,(MCS0)_4TX	82.2M	75.802M	75M8D1D	81.48M	75.562M
802.11ax HEW20_Nss1,(MCS0)_4TX	21.78M	19.01M	19M0D1D	21.54M	18.951M
802.11ax HEW40_Nss1,(MCS0)_4TX	40.2M	37.661M	37M7D1D	39.84M	37.541M
802.11ax HEW80_Nss1,(MCS0)_4TX	82.2M	77.121M	77M1D1D	81.72M	77.001M
5.725-5.85GHz	-	-	-	-	-
802.11a_Nss1,(6Mbps)_4TX	16.38M	26.597M	26M6D1D	16.29M	20.69M
802.11ac VHT20_Nss1,(MCS0)_4TX	17.58M	26.447M	26M4D1D	17.55M	20.27M
802.11ac VHT40_Nss1,(MCS0)_4TX	36.36M	49.835M	49M8D1D	36.06M	36.342M
802.11ac VHT80_Nss1,(MCS0)_4TX	76.32M	75.922M	75M9D1D	75.84M	75.682M
802.11ax HEW20_Nss1,(MCS0)_4TX	18.96M	28.456M	28M5D1D	18.48M	21.019M
802.11ax HEW40_Nss1,(MCS0)_4TX	37.62M	51.214M	51M2D1D	37.14M	37.601M
802.11ax HEW80_Nss1,(MCS0)_4TX	77.52M	77.241M	77M2D1D	76.32M	76.762M

Max-N dB = Maximum 6dB down bandwidth for 5.725-5.85GHz band / Maximum 26dB down bandwidth for other band;

Max-OBW = Maximum 99% occupied bandwidth;

Min-N dB = Minimum 6dB down bandwidth for 5.725-5.85GHz band / Maximum 26dB down bandwidth for other band;

Min-OBW = Minimum 99% occupied bandwidth;



Result

Mode	Result	Limit (Hz)	Port 1-N dB (Hz)	Port 1-OBW (Hz)	Port 2-N dB (Hz)	Port 2-OBW (Hz)	Port 3-N dB (Hz)	Port 3-OBW (Hz)	Port 4-N dB (Hz)	Port 4-OBW (Hz)
802.11a_Nss1,(6Mbps)_4TX	-	-	-	-	-	-	-	-	-	-
5180MHz	Pass	Inf	21.51M	16.612M	21.57M	16.582M	21.63M	16.612M	21.54M	16.522M
5200MHz	Pass	Inf	21.45M	16.582M	21.6M	16.582M	21.69M	16.582M	21.54M	16.582M
5240MHz	Pass	Inf	21.39M	16.552M	21.72M	16.642M	21.57M	16.612M	21.54M	16.552M
5745MHz	Pass	500k	16.35M	20.69M	16.29M	23.838M	16.32M	24.948M	16.32M	22.669M
5785MHz	Pass	500k	16.35M	20.87M	16.29M	24.948M	16.32M	25.637M	16.32M	23.238M
5825MHz	Pass	500k	16.38M	22.069M	16.29M	26.597M	16.32M	25.847M	16.32M	24.498M
802.11ac VHT20_Nss1,(MCS0)_4TX	-	-	-	-	-	-	-	-	-	-
5180MHz	Pass	Inf	21.75M	17.781M	21.57M	17.781M	21.51M	17.781M	21.69M	17.751M
5200MHz	Pass	Inf	21.75M	17.811M	21.54M	17.781M	21.48M	17.811M	21.72M	17.781M
5240MHz	Pass	Inf	21.78M	17.751M	21.6M	17.751M	21.42M	17.781M	21.63M	17.781M
5745MHz	Pass	500k	17.55M	20.27M	17.55M	24.498M	17.55M	25.997M	17.58M	22.939M
5785MHz	Pass	500k	17.55M	21.139M	17.55M	25.577M	17.58M	25.817M	17.58M	24.168M
5825MHz	Pass	500k	17.55M	22.099M	17.55M	26.447M	17.55M	26.147M	17.55M	23.208M
802.11ac VHT40_Nss1,(MCS0)_4TX	-	-	-	-	-	-	-	-	-	-
5190MHz	Pass	Inf	40.26M	36.222M	39.9M	36.162M	40.08M	36.282M	39.84M	36.222M
5230MHz	Pass	Inf	40.26M	36.222M	39.72M	36.222M	40.02M	36.222M	39.84M	36.222M
5755MHz	Pass	500k	36.3M	36.462M	36.3M	36.522M	36.36M	36.522M	36.06M	36.342M
5795MHz	Pass	500k	36.36M	38.021M	36.36M	49.715M	36.3M	49.835M	36.3M	40.54M
802.11ac VHT80_Nss1,(MCS0)_4TX	-	-	-	-	-	-	-	-	-	-
5210MHz	Pass	Inf	82.2M	75.682M	81.48M	75.682M	81.48M	75.562M	82.08M	75.802M
5775MHz	Pass	500k	76.08M	75.682M	76.32M	75.682M	76.32M	75.682M	75.84M	75.922M
802.11ax HEW20_Nss1,(MCS0)_4TX	-	-	-	-	-	-	-	-	-	-
5180MHz	Pass	Inf	21.54M	18.981M	21.6M	18.981M	21.78M	18.981M	21.63M	18.981M
5200MHz	Pass	Inf	21.69M	18.951M	21.66M	18.981M	21.72M	19.01M	21.66M	18.981M
5240MHz	Pass	Inf	21.6M	18.951M	21.72M	18.981M	21.72M	18.981M	21.75M	18.981M
5745MHz	Pass	500k	18.96M	21.019M	18.63M	25.787M	18.57M	26.987M	18.75M	23.868M
5785MHz	Pass	500k	18.87M	21.829M	18.72M	26.957M	18.6M	27.556M	18.78M	21.589M
5825MHz	Pass	500k	18.6M	22.789M	18.48M	28.456M	18.48M	27.076M	18.72M	24.438M
802.11ax HEW40_Nss1,(MCS0)_4TX	-	-	-	-	-	-	-	-	-	-
5190MHz	Pass	Inf	39.9M	37.541M	39.84M	37.661M	40.08M	37.541M	40.14M	37.541M
5230MHz	Pass	Inf	40.2M	37.541M	39.84M	37.541M	40.08M	37.541M	40.02M	37.601M
5755MHz	Pass	500k	37.62M	37.601M	37.26M	37.781M	37.5M	37.781M	37.32M	37.661M
5795MHz	Pass	500k	37.5M	38.381M	37.14M	50.375M	37.56M	51.214M	37.32M	39.04M
802.11ax HEW80_Nss1,(MCS0)_4TX	-	-	-	-	-	-	-	-	-	-
5210MHz	Pass	Inf	82.08M	77.001M	82.2M	77.001M	81.84M	77.121M	81.72M	77.001M
5775MHz	Pass	500k	76.56M	77.001M	76.32M	77.121M	77.16M	77.241M	77.52M	76.762M

Port X-N dB = Port X 6dB down bandwidth for 5.725-5.85GHz band / 26dB down bandwidth for other band

Port X-OBW = Port X 99% occupied bandwidth;

802.11a_Nss1,(6Mbps)_4TX

EBW

5180MHz

11/10/2019

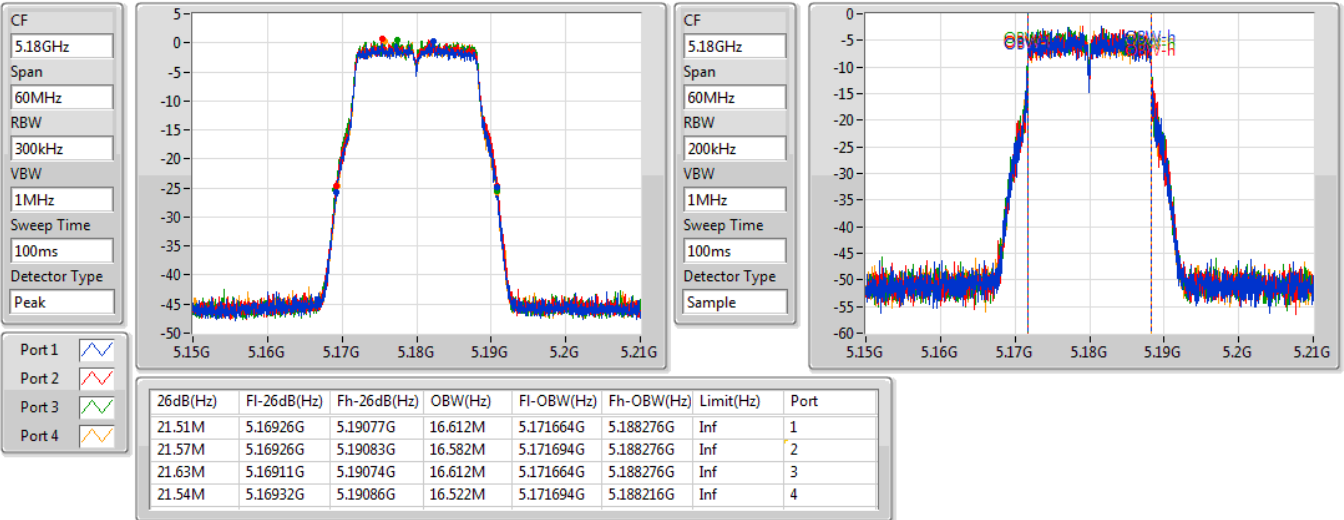

802.11a_Nss1,(6Mbps)_4TX

EBW

5200MHz

11/10/2019

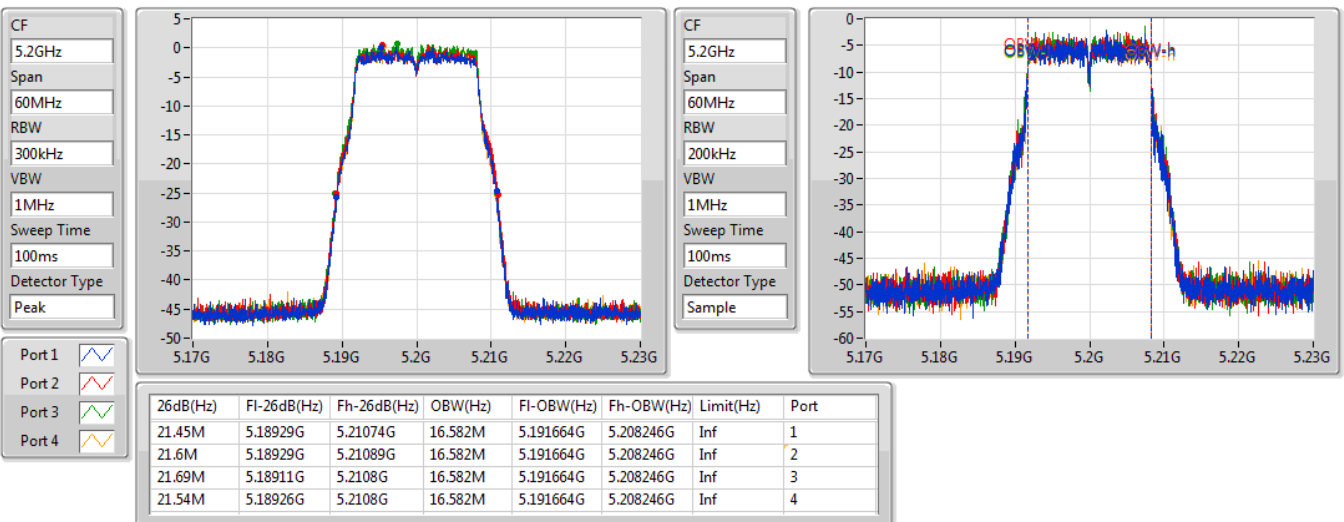

802.11a_Nss1,(6Mbps)_4TX

EBW

5240MHz

11/10/2019

CF
5.24GHz
Span
60MHz
RBW
300kHz
VBW
1MHz
Sweep Time
100ms
Detector Type
Peak

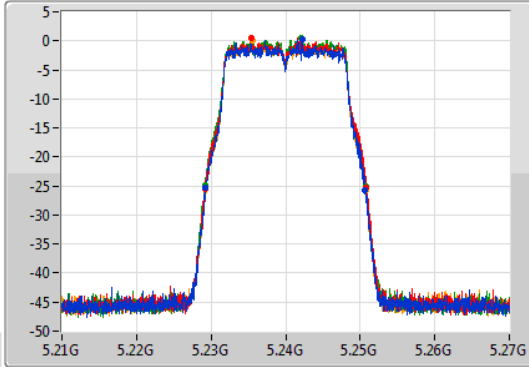

CF
5.24GHz
Span
60MHz
RBW
200kHz
VBW
1MHz
Sweep Time
100ms
Detector Type
Sample

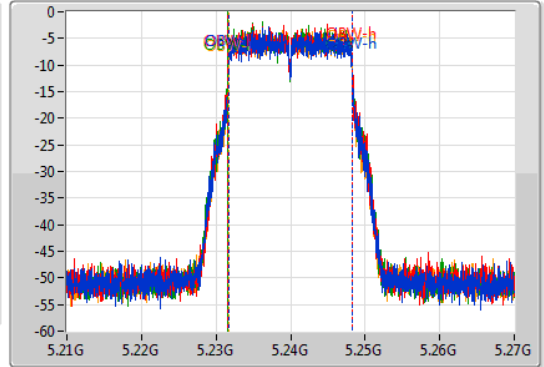

Port 1
Port 2
Port 3
Port 4

26dB(Hz)	Fl-26dB(Hz)	Fh-26dB(Hz)	OBW(Hz)	Fl-OBW(Hz)	Fh-OBW(Hz)	Limit(Hz)	Port
21.39M	5.22929G	5.25068G	16.552M	5.231694G	5.248246G	Inf	1
21.72M	5.22914G	5.25086G	16.642M	5.231634G	5.248276G	Inf	2
21.57M	5.2292G	5.25077G	16.612M	5.231634G	5.248246G	Inf	3
21.54M	5.22929G	5.25083G	16.552M	5.231664G	5.248216G	Inf	4

802.11a_Nss1,(6Mbps)_4TX

EBW

5745MHz

23/09/2019

CF
5.745GHz
Span
60MHz
RBW
100kHz
VBW
300kHz
Sweep Time
100ms
Detector Type
Peak

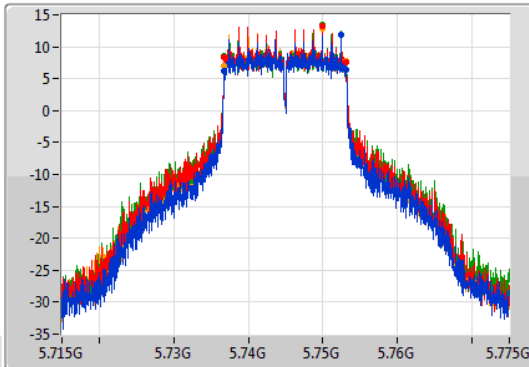

CF
5.745GHz
Span
60MHz
RBW
300kHz
VBW
1MHz
Sweep Time
100ms
Detector Type
Sample

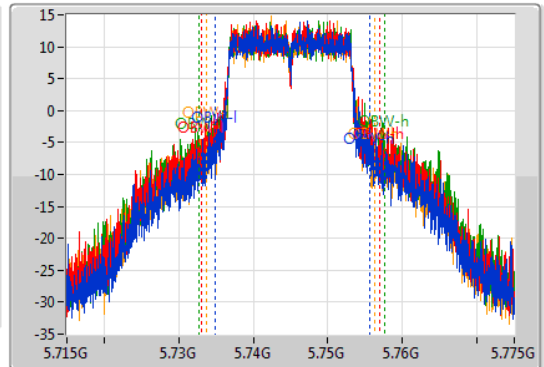

Port 1
Port 2
Port 3
Port 4

6dB(Hz)	Fl-6dB(Hz)	Fh-6dB(Hz)	OBW(Hz)	Fl-OBW(Hz)	Fh-OBW(Hz)	Limit(Hz)	Port
16.35M	5.73678G	5.75313G	20.69M	5.734925G	5.755615G	500k	1
16.29M	5.73681G	5.7531G	23.838M	5.733036G	5.756874G	500k	2
16.32M	5.73681G	5.75313G	24.948M	5.732706G	5.757654G	500k	3
16.32M	5.73678G	5.7531G	22.669M	5.733696G	5.756364G	500k	4

802.11a_Nss1,(6Mbps)_4TX

EBW

5785MHz

23/09/2019

CF: 5.785GHz
 Span: 60MHz
 RBW: 100kHz
 VBW: 300kHz
 Sweep Time: 100ms
 Detector Type: Peak

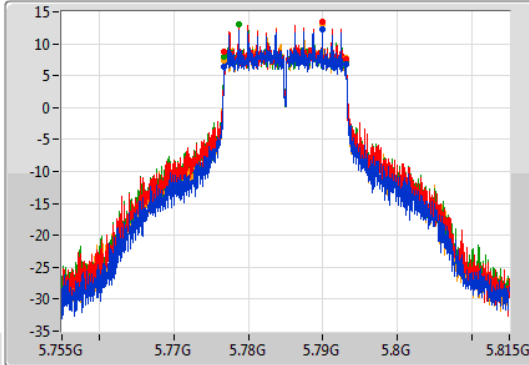

CF: 5.785GHz
 Span: 60MHz
 RBW: 300kHz
 VBW: 1MHz
 Sweep Time: 100ms
 Detector Type: Sample

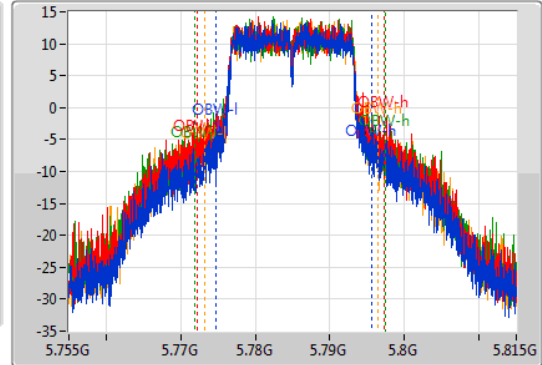

Port 1: [Waveform icon]
 Port 2: [Waveform icon]
 Port 3: [Waveform icon]
 Port 4: [Waveform icon]

6dB(Hz)	Fl-6dB(Hz)	Fh-6dB(Hz)	OBW(Hz)	Fl-OBW(Hz)	Fh-OBW(Hz)	Limit(Hz)	Port
16.35M	5.77678G	5.79313G	20.87M	5.774745G	5.795615G	500k	1
16.29M	5.77681G	5.7931G	24.948M	5.772256G	5.797204G	500k	2
16.32M	5.77678G	5.7931G	25.637M	5.771867G	5.797504G	500k	3
16.32M	5.77678G	5.7931G	23.238M	5.773276G	5.796514G	500k	4

802.11a_Nss1,(6Mbps)_4TX

EBW

5825MHz

23/09/2019

CF: 5.825GHz
 Span: 60MHz
 RBW: 100kHz
 VBW: 300kHz
 Sweep Time: 100ms
 Detector Type: Peak

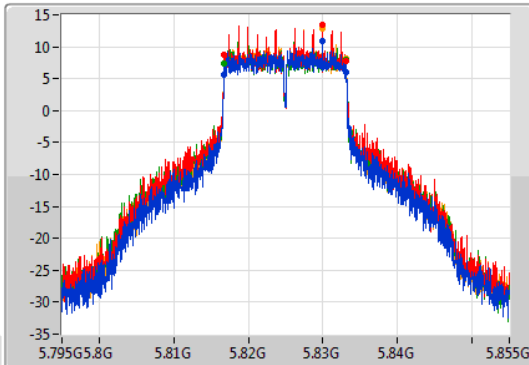

CF: 5.825GHz
 Span: 60MHz
 RBW: 300kHz
 VBW: 1MHz
 Sweep Time: 100ms
 Detector Type: Sample

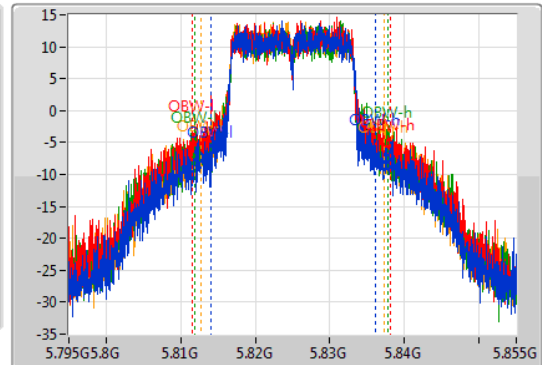

Port 1: [Waveform icon]
 Port 2: [Waveform icon]
 Port 3: [Waveform icon]
 Port 4: [Waveform icon]

6dB(Hz)	Fl-6dB(Hz)	Fh-6dB(Hz)	OBW(Hz)	Fl-OBW(Hz)	Fh-OBW(Hz)	Limit(Hz)	Port
16.38M	5.81675G	5.83313G	22.069M	5.814115G	5.836184G	500k	1
16.29M	5.81681G	5.8331G	26.597M	5.811567G	5.838163G	500k	2
16.32M	5.81678G	5.8331G	25.847M	5.811927G	5.837774G	500k	3
16.32M	5.81678G	5.8331G	24.498M	5.812796G	5.837294G	500k	4

802.11ac VHT20_Nss1,(MCS0)_4TX

EBW

5180MHz

11/10/2019

CF
5.18GHz
Span
60MHz
RBW
300kHz
VBW
1MHz
Sweep Time
100ms
Detector Type
Peak

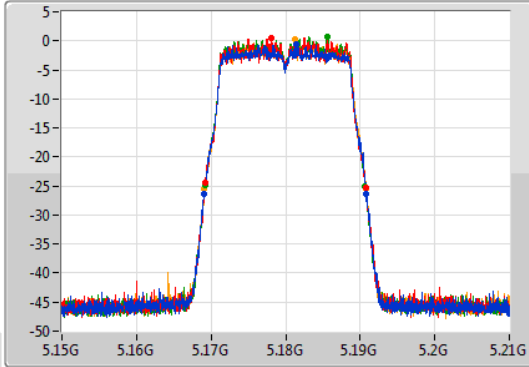

CF
5.18GHz
Span
60MHz
RBW
200kHz
VBW
1MHz
Sweep Time
100ms
Detector Type
Sample

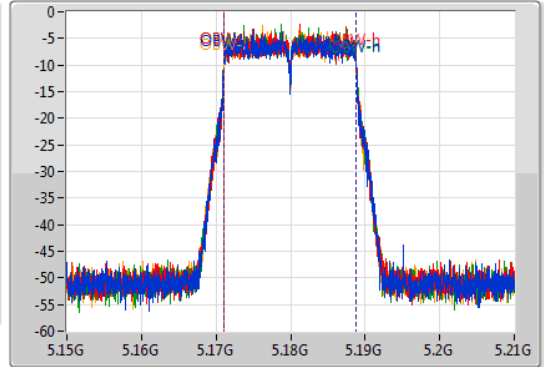

Port 1
Port 2
Port 3
Port 4

26dB(Hz)	Fl-26dB(Hz)	Fh-26dB(Hz)	OBW(Hz)	Fl-OBW(Hz)	Fh-OBW(Hz)	Limit(Hz)	Port
21.75M	5.16908G	5.19083G	17.781M	5.171064G	5.188846G	Inf	1
21.57M	5.1692G	5.19077G	17.781M	5.171064G	5.188846G	Inf	2
21.51M	5.16917G	5.19068G	17.781M	5.171064G	5.188846G	Inf	3
21.69M	5.16911G	5.1908G	17.751M	5.171064G	5.188816G	Inf	4

802.11ac VHT20_Nss1,(MCS0)_4TX

EBW

5200MHz

11/10/2019

CF
5.2GHz
Span
60MHz
RBW
300kHz
VBW
1MHz
Sweep Time
100ms
Detector Type
Peak

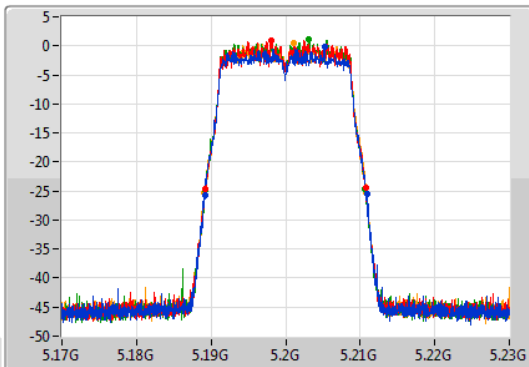

CF
5.2GHz
Span
60MHz
RBW
200kHz
VBW
1MHz
Sweep Time
100ms
Detector Type
Sample

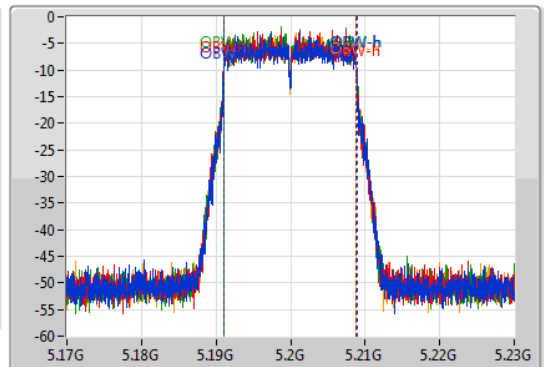

Port 1
Port 2
Port 3
Port 4

26dB(Hz)	Fl-26dB(Hz)	Fh-26dB(Hz)	OBW(Hz)	Fl-OBW(Hz)	Fh-OBW(Hz)	Limit(Hz)	Port
21.75M	5.18914G	5.21089G	17.811M	5.191064G	5.208876G	Inf	1
21.54M	5.18923G	5.21077G	17.781M	5.191064G	5.208846G	Inf	2
21.48M	5.18917G	5.21065G	17.811M	5.191034G	5.208846G	Inf	3
21.72M	5.18908G	5.2108G	17.781M	5.191064G	5.208846G	Inf	4

802.11ac VHT20_Nss1,(MCS0)_4TX

EBW

5240MHz

11/10/2019

CF
5.24GHz
Span
60MHz
RBW
300kHz
VBW
1MHz
Sweep Time
100ms
Detector Type
Peak

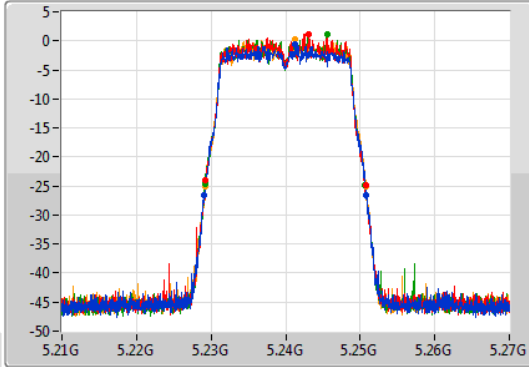

CF
5.24GHz
Span
60MHz
RBW
200kHz
VBW
1MHz
Sweep Time
100ms
Detector Type
Sample

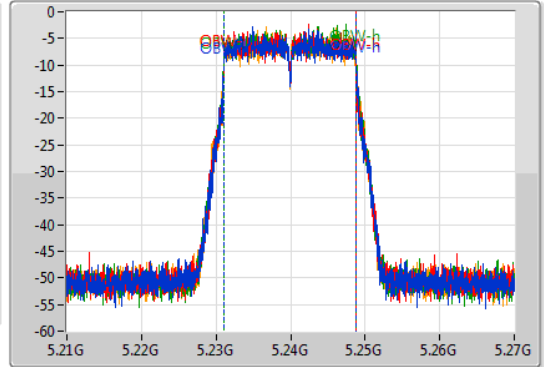

Port 1
Port 2
Port 3
Port 4

26dB(Hz)	Fl-26dB(Hz)	Fh-26dB(Hz)	OBW(Hz)	Fl-OBW(Hz)	Fh-OBW(Hz)	Limit(Hz)	Port
21.78M	5.22902G	5.2508G	17.751M	5.231064G	5.248816G	Inf	1
21.6M	5.2292G	5.2508G	17.751M	5.231064G	5.248816G	Inf	2
21.42M	5.22923G	5.25065G	17.781M	5.231064G	5.248846G	Inf	3
21.63M	5.22917G	5.2508G	17.781M	5.231064G	5.248846G	Inf	4

802.11ac VHT20_Nss1,(MCS0)_4TX

EBW

5745MHz

23/09/2019

CF
5.745GHz
Span
60MHz
RBW
100kHz
VBW
300kHz
Sweep Time
100ms
Detector Type
Peak

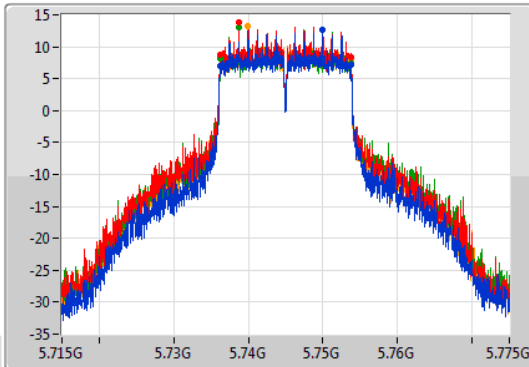

CF
5.745GHz
Span
60MHz
RBW
300kHz
VBW
1MHz
Sweep Time
100ms
Detector Type
Sample

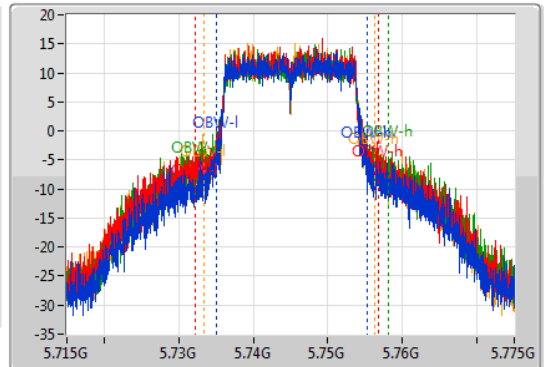

Port 1
Port 2
Port 3
Port 4

6dB(Hz)	Fl-6dB(Hz)	Fh-6dB(Hz)	OBW(Hz)	Fl-OBW(Hz)	Fh-OBW(Hz)	Limit(Hz)	Port
17.55M	5.73621G	5.75376G	20.27M	5.735045G	5.755315G	500k	1
17.55M	5.73621G	5.75376G	24.498M	5.732256G	5.756754G	500k	2
17.55M	5.73621G	5.75376G	25.997M	5.732166G	5.758163G	500k	3
17.58M	5.73618G	5.75376G	22.939M	5.733306G	5.756244G	500k	4

802.11ac VHT20_Nss1,(MCS0)_4TX

EBW

5785MHz

24/09/2019

CF
5.785GHz
Span
60MHz
RBW
100kHz
VBW
300kHz
Sweep Time
100ms
Detector Type
Peak

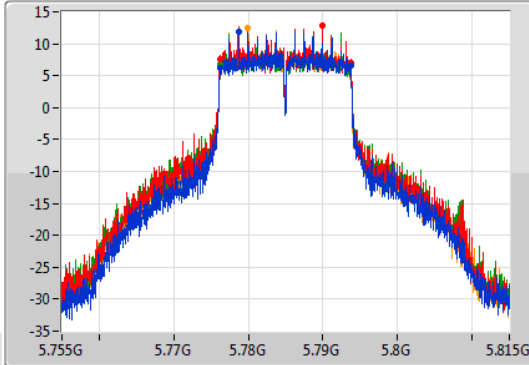

CF
5.785GHz
Span
60MHz
RBW
300kHz
VBW
1MHz
Sweep Time
100ms
Detector Type
Sample

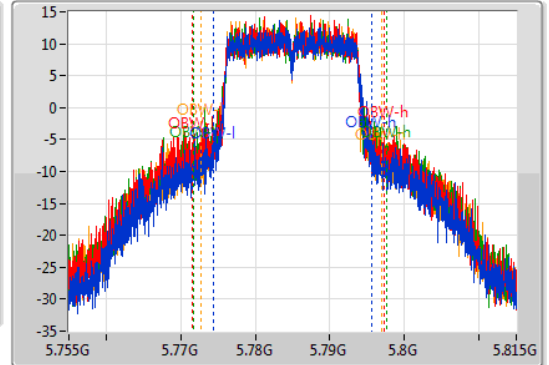

Port 1
Port 2
Port 3
Port 4

6dB(Hz)	Fl-6dB(Hz)	Fh-6dB(Hz)	OBW(Hz)	Fl-OBW(Hz)	Fh-OBW(Hz)	Limit(Hz)	Port
17.55M	5.77618G	5.79373G	21.139M	5.774445G	5.795585G	500k	1
17.55M	5.77618G	5.79373G	25.577M	5.771627G	5.797204G	500k	2
17.58M	5.77615G	5.79373G	25.817M	5.771777G	5.797594G	500k	3
17.58M	5.77615G	5.79373G	24.168M	5.772706G	5.796874G	500k	4

802.11ac VHT20_Nss1,(MCS0)_4TX

EBW

5825MHz

24/09/2019

CF
5.825GHz
Span
60MHz
RBW
100kHz
VBW
300kHz
Sweep Time
100ms
Detector Type
Peak

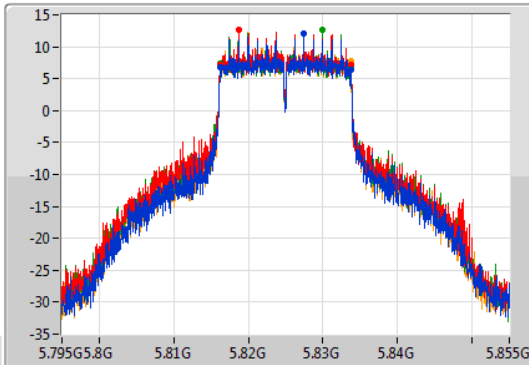

CF
5.825GHz
Span
60MHz
RBW
300kHz
VBW
1MHz
Sweep Time
100ms
Detector Type
Sample

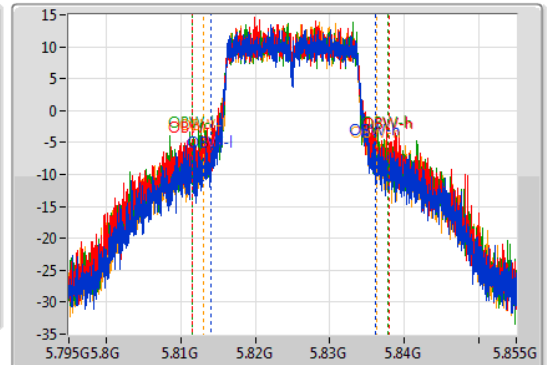

Port 1
Port 2
Port 3
Port 4

6dB(Hz)	Fl-6dB(Hz)	Fh-6dB(Hz)	OBW(Hz)	Fl-OBW(Hz)	Fh-OBW(Hz)	Limit(Hz)	Port
17.55M	5.81618G	5.83373G	22.099M	5.814025G	5.836124G	500k	1
17.55M	5.81618G	5.83373G	26.447M	5.811477G	5.837924G	500k	2
17.55M	5.81618G	5.83373G	26.147M	5.811597G	5.837744G	500k	3
17.55M	5.81618G	5.83373G	23.208M	5.813126G	5.836334G	500k	4

802.11ac VHT40_Nss1,(MCS0)_4TX

EBW

5190MHz

11/10/2019

CF
5.19GHz
Span
120MHz
RBW
500kHz
VBW
2MHz
Sweep Time
100ms
Detector Type
Peak

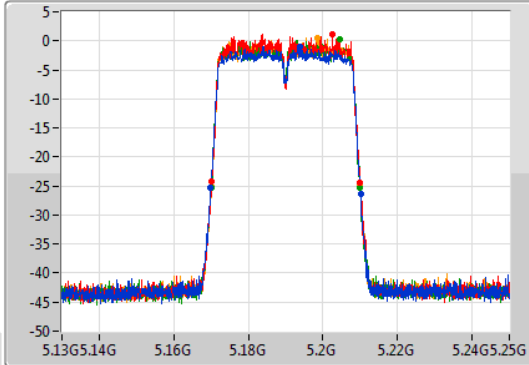

CF
5.19GHz
Span
120MHz
RBW
500kHz
VBW
2MHz
Sweep Time
100ms
Detector Type
Sample

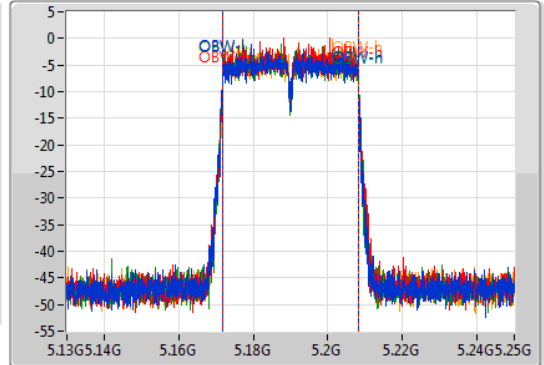

Port 1
Port 2
Port 3
Port 4

26dB(Hz)	Fl-26dB(Hz)	Fh-26dB(Hz)	OBW(Hz)	Fl-OBW(Hz)	Fh-OBW(Hz)	Limit(Hz)	Port
40.26M	5.16984G	5.2101G	36.222M	5.171829G	5.208051G	Inf	1
39.9M	5.17014G	5.21004G	36.162M	5.171889G	5.208051G	Inf	2
40.08M	5.16996G	5.21004G	36.282M	5.171829G	5.208111G	Inf	3
39.84M	5.17014G	5.20998G	36.222M	5.171829G	5.208051G	Inf	4

802.11ac VHT40_Nss1,(MCS0)_4TX

EBW

5230MHz

11/10/2019

CF
5.23GHz
Span
120MHz
RBW
500kHz
VBW
2MHz
Sweep Time
100ms
Detector Type
Peak

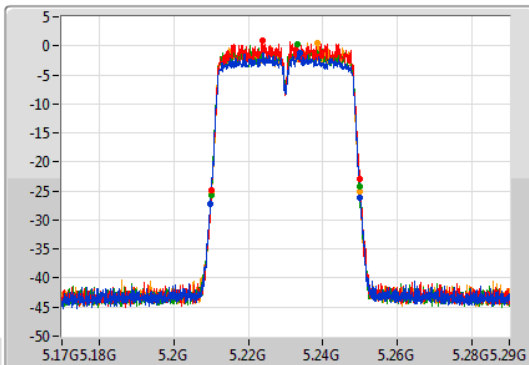

CF
5.23GHz
Span
120MHz
RBW
500kHz
VBW
2MHz
Sweep Time
100ms
Detector Type
Sample

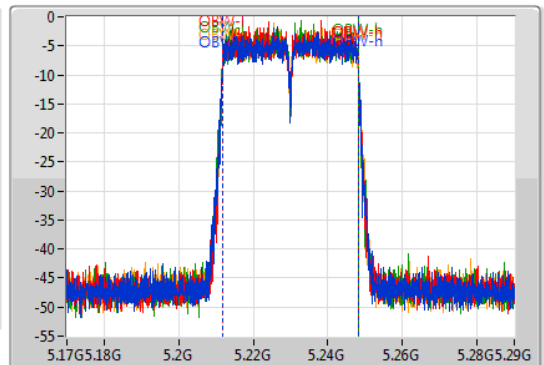

Port 1
Port 2
Port 3
Port 4

26dB(Hz)	Fl-26dB(Hz)	Fh-26dB(Hz)	OBW(Hz)	Fl-OBW(Hz)	Fh-OBW(Hz)	Limit(Hz)	Port
40.26M	5.20978G	5.25004G	36.222M	5.211829G	5.248051G	Inf	1
39.72M	5.21014G	5.24986G	36.222M	5.211829G	5.248051G	Inf	2
40.02M	5.20996G	5.24998G	36.222M	5.211829G	5.248051G	Inf	3
39.84M	5.21014G	5.24998G	36.222M	5.211829G	5.248051G	Inf	4

802.11ac VHT40_Nss1,(MCS0)_4TX

EBW

5755MHz

24/09/2019

CF
5.755GHz
Span
120MHz
RBW
100kHz
VBW
300kHz
Sweep Time
100ms
Detector Type
Peak

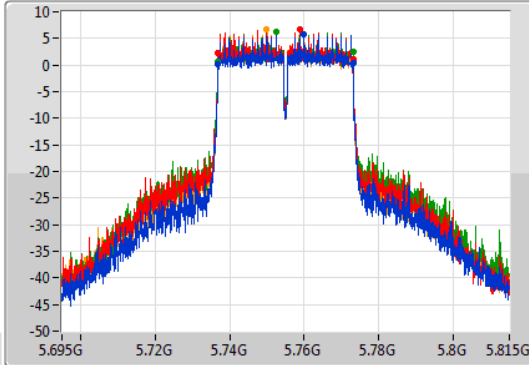

CF
5.755GHz
Span
120MHz
RBW
500kHz
VBW
2MHz
Sweep Time
100ms
Detector Type
Sample

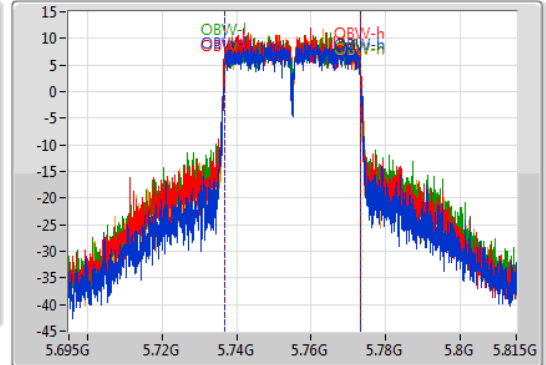

Port 1
Port 2
Port 3
Port 4

6dB(Hz)	Fl-6dB(Hz)	Fh-6dB(Hz)	OBW(Hz)	Fl-OBW(Hz)	Fh-OBW(Hz)	Limit(Hz)	Port
36.3M	5.73682G	5.77312G	36.462M	5.736769G	5.773231G	500k	1
36.3M	5.73682G	5.77312G	36.522M	5.736649G	5.773171G	500k	2
36.36M	5.73676G	5.77312G	36.522M	5.736649G	5.773171G	500k	3
36.06M	5.73682G	5.77288G	36.342M	5.736769G	5.773111G	500k	4

802.11ac VHT40_Nss1,(MCS0)_4TX

EBW

5795MHz

24/09/2019

CF
5.795GHz
Span
120MHz
RBW
100kHz
VBW
300kHz
Sweep Time
100ms
Detector Type
Peak

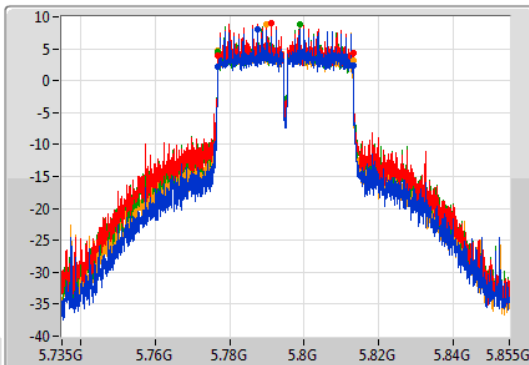

CF
5.795GHz
Span
120MHz
RBW
1MHz
VBW
3MHz
Sweep Time
100ms
Detector Type
Sample

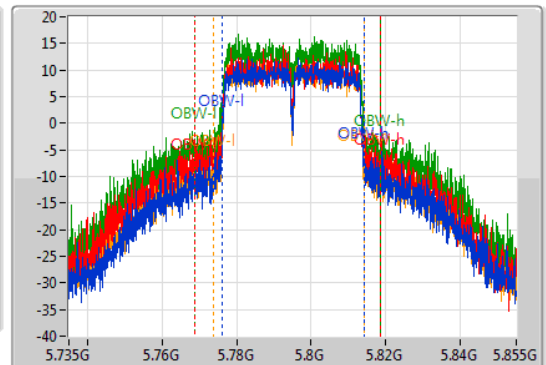

Port 1
Port 2
Port 3
Port 4

6dB(Hz)	Fl-6dB(Hz)	Fh-6dB(Hz)	OBW(Hz)	Fl-OBW(Hz)	Fh-OBW(Hz)	Limit(Hz)	Port
36.36M	5.77676G	5.81312G	38.021M	5.776109G	5.81413G	500k	1
36.36M	5.77676G	5.81312G	49.715M	5.768793G	5.818508G	500k	2
36.3M	5.77682G	5.81312G	49.835M	5.768793G	5.818628G	500k	3
36.3M	5.77682G	5.81312G	40.54M	5.773651G	5.81419G	500k	4

802.11ac VHT80_Nss1,(MCS0)_4TX

EBW

5210MHz

24/09/2019

CF
5.21GHz
Span
240MHz
RBW
1MHz
VBW
3MHz
Sweep Time
100ms
Detector Type
Peak

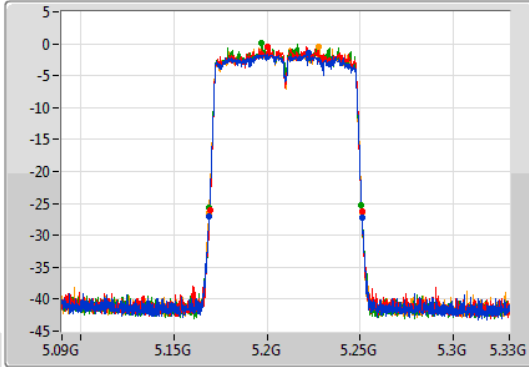

CF
5.21GHz
Span
240MHz
RBW
1MHz
VBW
3MHz
Sweep Time
100ms
Detector Type
Sample

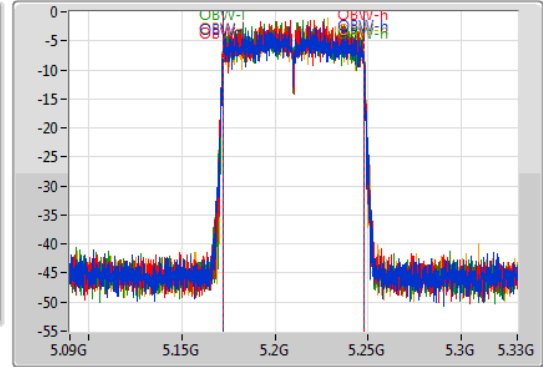

Port 1
Port 2
Port 3
Port 4

26dB(Hz)	Fl-26dB(Hz)	Fh-26dB(Hz)	OBW(Hz)	Fl-OBW(Hz)	Fh-OBW(Hz)	Limit(Hz)	Port
82.2M	5.16896G	5.25116G	75.682M	5.171979G	5.247661G	Inf	1
81.48M	5.16932G	5.2508G	75.682M	5.172099G	5.247781G	Inf	2
81.48M	5.1692G	5.25068G	75.562M	5.172219G	5.247781G	Inf	3
82.08M	5.16884G	5.25092G	75.802M	5.171979G	5.247781G	Inf	4

802.11ac VHT80_Nss1,(MCS0)_4TX

EBW

5775MHz

24/09/2019

CF
5.775GHz
Span
240MHz
RBW
100kHz
VBW
300kHz
Sweep Time
100ms
Detector Type
Peak

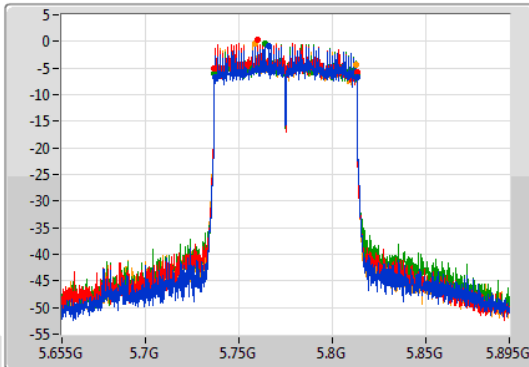

CF
5.775GHz
Span
240MHz
RBW
1MHz
VBW
3MHz
Sweep Time
100ms
Detector Type
Sample

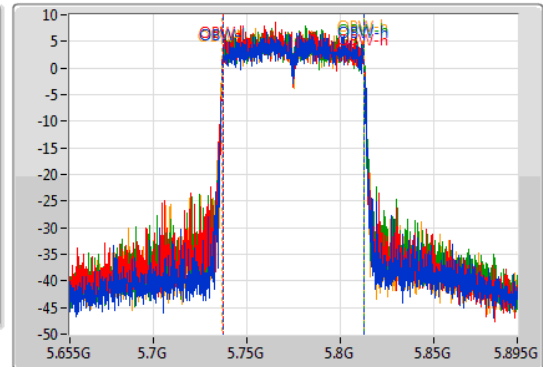

Port 1
Port 2
Port 3
Port 4

6dB(Hz)	Fl-6dB(Hz)	Fh-6dB(Hz)	OBW(Hz)	Fl-OBW(Hz)	Fh-OBW(Hz)	Limit(Hz)	Port
76.08M	5.73708G	5.81316G	75.682M	5.736979G	5.812661G	500k	1
76.32M	5.73684G	5.81316G	75.682M	5.736979G	5.812661G	500k	2
76.32M	5.73684G	5.81316G	75.682M	5.737099G	5.812781G	500k	3
75.84M	5.73672G	5.81256G	75.922M	5.736859G	5.812781G	500k	4

802.11ax HEW20_Nss1,(MCS0)_4TX

EBW

5180MHz

11/10/2019

CF
5.18GHz
Span
60MHz
RBW
300kHz
VBW
1MHz
Sweep Time
100ms
Detector Type
Peak

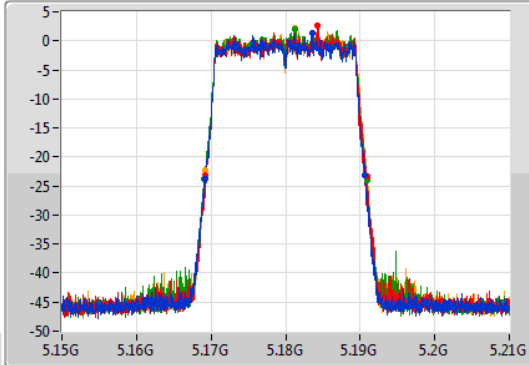

CF
5.18GHz
Span
60MHz
RBW
200kHz
VBW
1MHz
Sweep Time
100ms
Detector Type
Sample

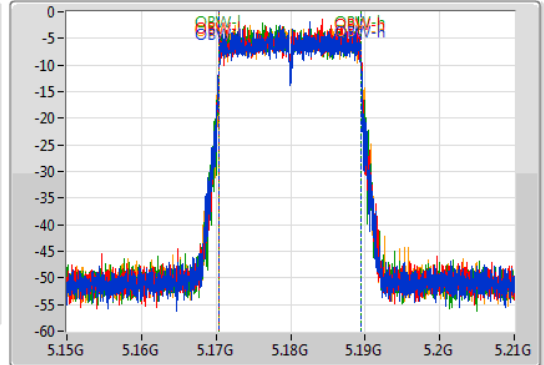

Port 1
Port 2
Port 3
Port 4

26dB(Hz)	Fl-26dB(Hz)	Fh-26dB(Hz)	OBW(Hz)	Fl-OBW(Hz)	Fh-OBW(Hz)	Limit(Hz)	Port
21.54M	5.16914G	5.19068G	18.981M	5.170435G	5.189415G	Inf	1
21.6M	5.16929G	5.19089G	18.981M	5.170465G	5.189445G	Inf	2
21.78M	5.16911G	5.19089G	18.981M	5.170465G	5.189445G	Inf	3
21.63M	5.16929G	5.19092G	18.981M	5.170465G	5.189445G	Inf	4

802.11ax HEW20_Nss1,(MCS0)_4TX

EBW

5200MHz

11/10/2019

CF
5.2GHz
Span
60MHz
RBW
300kHz
VBW
1MHz
Sweep Time
100ms
Detector Type
Peak

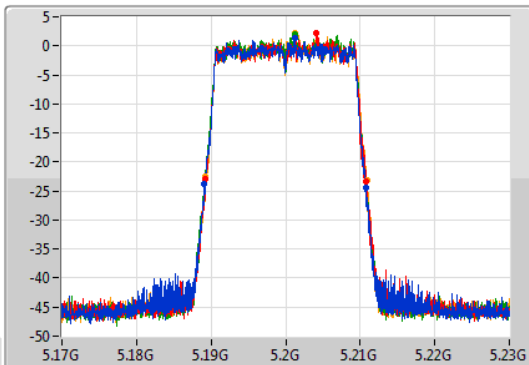

CF
5.2GHz
Span
60MHz
RBW
200kHz
VBW
1MHz
Sweep Time
100ms
Detector Type
Sample

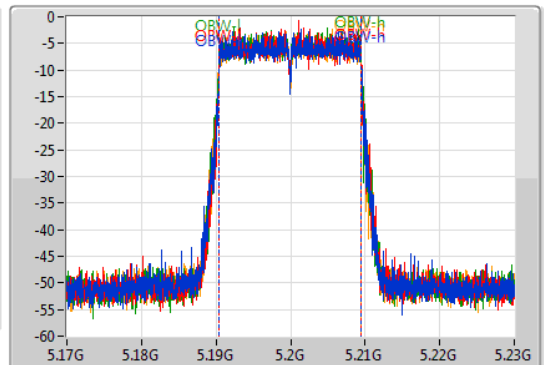

Port 1
Port 2
Port 3
Port 4

26dB(Hz)	Fl-26dB(Hz)	Fh-26dB(Hz)	OBW(Hz)	Fl-OBW(Hz)	Fh-OBW(Hz)	Limit(Hz)	Port
21.69M	5.18911G	5.2108G	18.951M	5.190465G	5.209415G	Inf	1
21.66M	5.1892G	5.21086G	18.981M	5.190465G	5.209445G	Inf	2
21.72M	5.18911G	5.21083G	19.01M	5.190435G	5.209445G	Inf	3
21.66M	5.18926G	5.21092G	18.981M	5.190435G	5.209415G	Inf	4

802.11ax HEW20_Nss1,(MCS0)_4TX

EBW

5240MHz

11/10/2019

CF
5.24GHz
Span
60MHz
RBW
300kHz
VBW
1MHz
Sweep Time
100ms
Detector Type
Peak

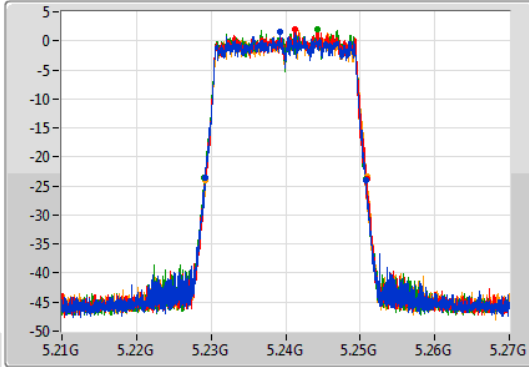

CF
5.24GHz
Span
60MHz
RBW
200kHz
VBW
1MHz
Sweep Time
100ms
Detector Type
Sample

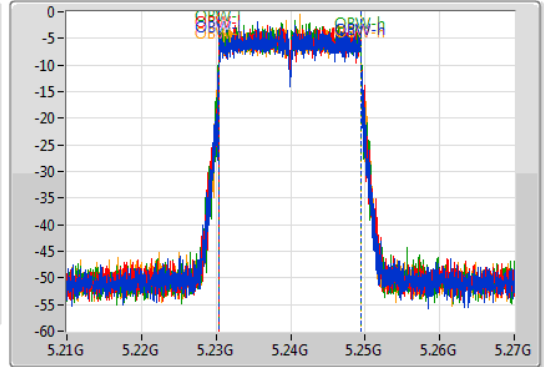

Port 1
Port 2
Port 3
Port 4

26dB(Hz)	Fl-26dB(Hz)	Fh-26dB(Hz)	OBW(Hz)	Fl-OBW(Hz)	Fh-OBW(Hz)	Limit(Hz)	Port
21.6M	5.22914G	5.25074G	18.951M	5.230465G	5.249415G	Inf	1
21.72M	5.2292G	5.25092G	18.981M	5.230465G	5.249445G	Inf	2
21.72M	5.22911G	5.25083G	18.981M	5.230465G	5.249445G	Inf	3
21.75M	5.22917G	5.25092G	18.981M	5.230465G	5.249445G	Inf	4

802.11ax HEW20_Nss1,(MCS0)_4TX

EBW

5745MHz

23/09/2019

CF
5.745GHz
Span
60MHz
RBW
100kHz
VBW
300kHz
Sweep Time
100ms
Detector Type
Peak

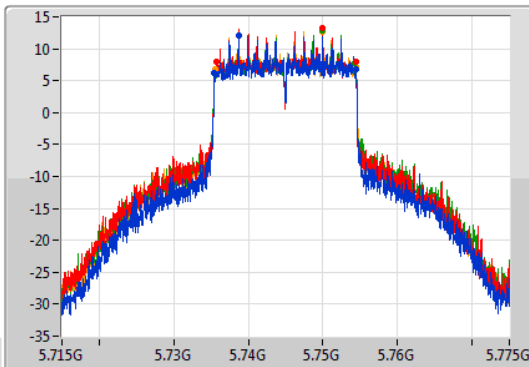

CF
5.745GHz
Span
60MHz
RBW
300kHz
VBW
1MHz
Sweep Time
100ms
Detector Type
Sample

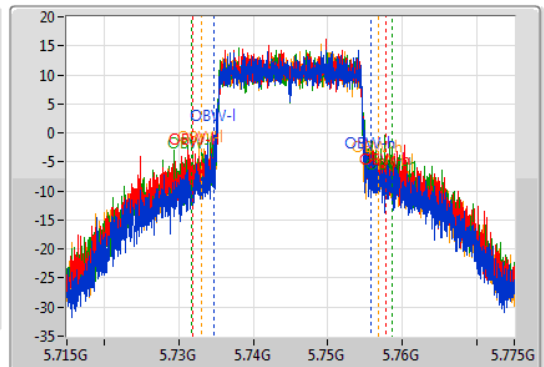

Port 1
Port 2
Port 3
Port 4

6dB(Hz)	Fl-6dB(Hz)	Fh-6dB(Hz)	OBW(Hz)	Fl-OBW(Hz)	Fh-OBW(Hz)	Limit(Hz)	Port
18.96M	5.73546G	5.75442G	21.019M	5.734775G	5.755795G	500k	1
18.63M	5.73573G	5.75436G	25.787M	5.731957G	5.757744G	500k	2
18.57M	5.73573G	5.7543G	26.987M	5.731657G	5.758643G	500k	3
18.75M	5.73564G	5.75439G	23.868M	5.732976G	5.756844G	500k	4

802.11ax HEW20_Nss1,(MCS0)_4TX

EBW

5785MHz

23/09/2019

CF
5.785GHz
Span
60MHz
RBW
100kHz
VBW
300kHz
Sweep Time
100ms
Detector Type
Peak

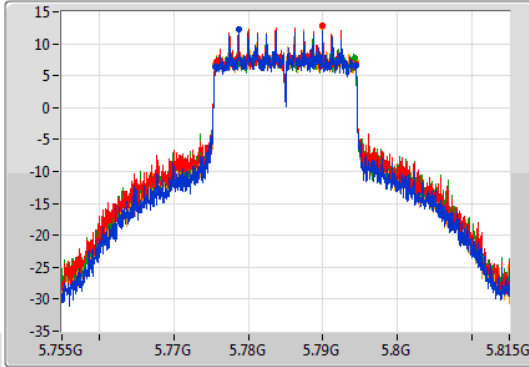

CF
5.785GHz
Span
60MHz
RBW
300kHz
VBW
1MHz
Sweep Time
100ms
Detector Type
Sample

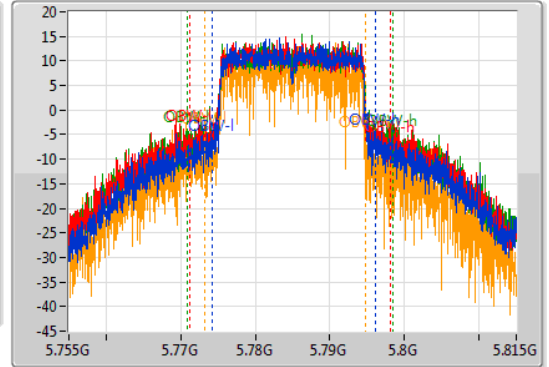

Port 1
Port 2
Port 3
Port 4

6dB(Hz)	Fl-6dB(Hz)	Fh-6dB(Hz)	OBW(Hz)	Fl-OBW(Hz)	Fh-OBW(Hz)	Limit(Hz)	Port
18.87M	5.77552G	5.79439G	21.829M	5.774265G	5.796094G	500k	1
18.72M	5.77567G	5.79439G	26.957M	5.771147G	5.798103G	500k	2
18.6M	5.77567G	5.79427G	27.556M	5.770907G	5.798463G	500k	3
18.78M	5.77558G	5.79436G	21.589M	5.773186G	5.794775G	500k	4

802.11ax HEW20_Nss1,(MCS0)_4TX

EBW

5825MHz

23/09/2019

CF
5.825GHz
Span
60MHz
RBW
100kHz
VBW
300kHz
Sweep Time
100ms
Detector Type
Peak

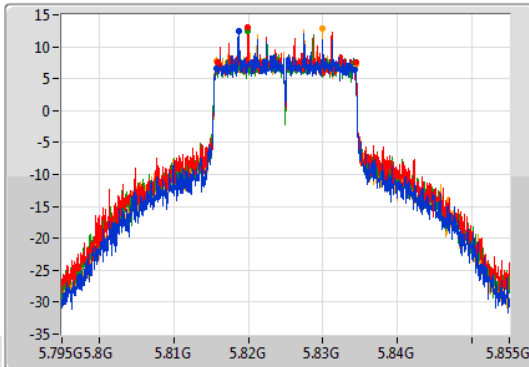

CF
5.825GHz
Span
60MHz
RBW
300kHz
VBW
1MHz
Sweep Time
100ms
Detector Type
Sample

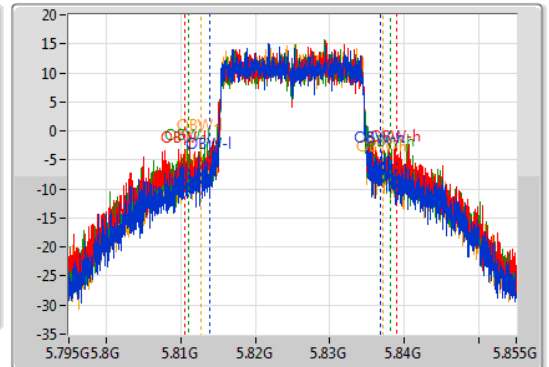

Port 1
Port 2
Port 3
Port 4

6dB(Hz)	Fl-6dB(Hz)	Fh-6dB(Hz)	OBW(Hz)	Fl-OBW(Hz)	Fh-OBW(Hz)	Limit(Hz)	Port
18.6M	5.81567G	5.83427G	22.789M	5.813966G	5.836754G	500k	1
18.48M	5.81594G	5.83442G	28.456M	5.810547G	5.839003G	500k	2
18.48M	5.81573G	5.83421G	27.076M	5.811057G	5.838133G	500k	3
18.72M	5.81567G	5.83439G	24.438M	5.812676G	5.837114G	500k	4

802.11ax HEW40_Nss1,(MCS0)_4TX

EBW

5190MHz

11/10/2019

CF
5.19GHz
Span
120MHz
RBW
500kHz
VBW
2MHz
Sweep Time
100ms
Detector Type
Peak

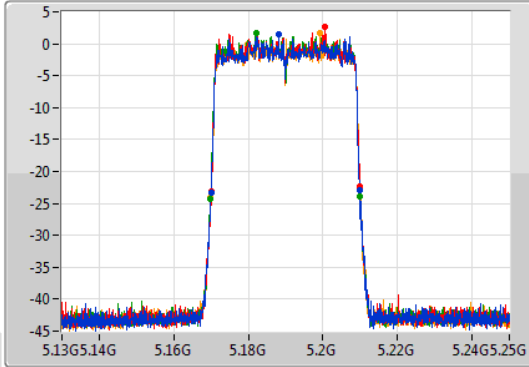

CF
5.19GHz
Span
120MHz
RBW
500kHz
VBW
2MHz
Sweep Time
100ms
Detector Type
Sample

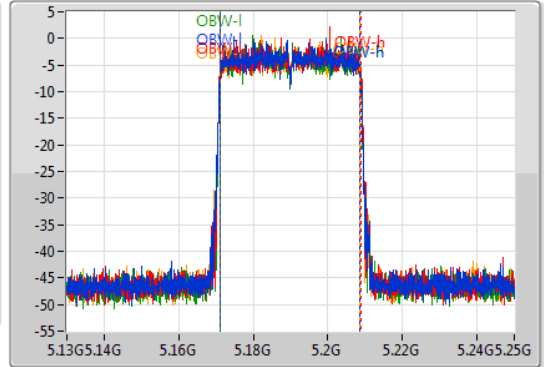

Port 1
Port 2
Port 3
Port 4

26dB(Hz)	Fl-26dB(Hz)	Fh-26dB(Hz)	OBW(Hz)	Fl-OBW(Hz)	Fh-OBW(Hz)	Limit(Hz)	Port
39.9M	5.17002G	5.20992G	37.541M	5.171169G	5.208711G	Inf	1
39.84M	5.17008G	5.20992G	37.661M	5.171109G	5.208771G	Inf	2
40.08M	5.16984G	5.20992G	37.541M	5.171169G	5.208711G	Inf	3
40.14M	5.1699G	5.21004G	37.541M	5.171169G	5.208711G	Inf	4

802.11ax HEW40_Nss1,(MCS0)_4TX

EBW

5230MHz

11/10/2019

CF
5.23GHz
Span
120MHz
RBW
500kHz
VBW
2MHz
Sweep Time
100ms
Detector Type
Peak

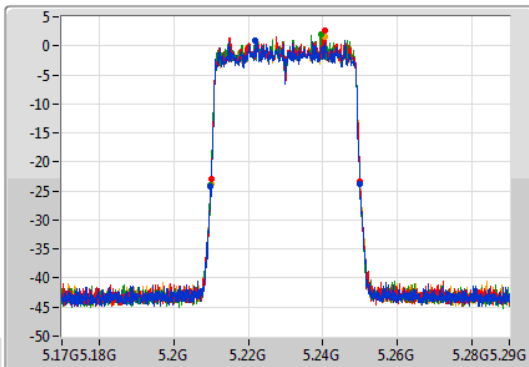

CF
5.23GHz
Span
120MHz
RBW
500kHz
VBW
2MHz
Sweep Time
100ms
Detector Type
Sample

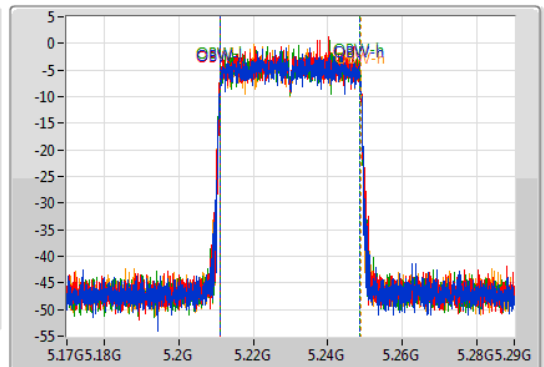

Port 1
Port 2
Port 3
Port 4

26dB(Hz)	Fl-26dB(Hz)	Fh-26dB(Hz)	OBW(Hz)	Fl-OBW(Hz)	Fh-OBW(Hz)	Limit(Hz)	Port
40.2M	5.20984G	5.25004G	37.541M	5.211169G	5.248711G	Inf	1
39.84M	5.21008G	5.24992G	37.541M	5.211169G	5.248711G	Inf	2
40.08M	5.20984G	5.24992G	37.541M	5.211169G	5.248711G	Inf	3
40.02M	5.21002G	5.25004G	37.601M	5.211169G	5.248771G	Inf	4

802.11ax HEW40_Nss1,(MCS0)_4TX

EBW

5755MHz

23/09/2019

CF
5.755GHz
Span
120MHz
RBW
100kHz
VBW
300kHz
Sweep Time
100ms
Detector Type
Peak

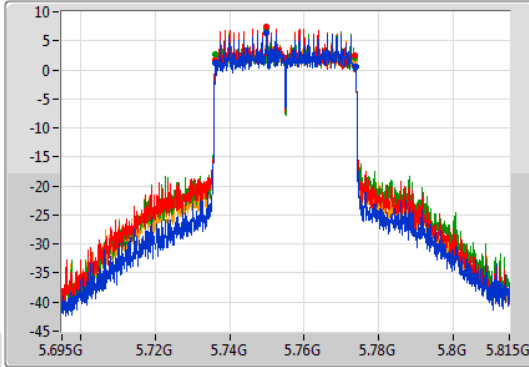

CF
5.755GHz
Span
120MHz
RBW
500kHz
VBW
2MHz
Sweep Time
100ms
Detector Type
Sample

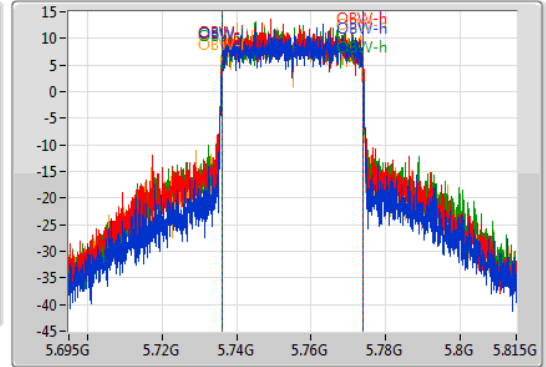

Port 1
Port 2
Port 3
Port 4

6dB(Hz)	Fl-6dB(Hz)	Fh-6dB(Hz)	OBW(Hz)	Fl-OBW(Hz)	Fh-OBW(Hz)	Limit(Hz)	Port
37.62M	5.73616G	5.77378G	37.601M	5.736229G	5.773831G	500k	1
37.26M	5.73616G	5.77342G	37.781M	5.736049G	5.773831G	500k	2
37.5M	5.73616G	5.77366G	37.781M	5.736049G	5.773831G	500k	3
37.32M	5.73616G	5.77348G	37.661M	5.736109G	5.773771G	500k	4

802.11ax HEW40_Nss1,(MCS0)_4TX

EBW

5795MHz

23/09/2019

CF
5.795GHz
Span
120MHz
RBW
100kHz
VBW
300kHz
Sweep Time
100ms
Detector Type
Peak

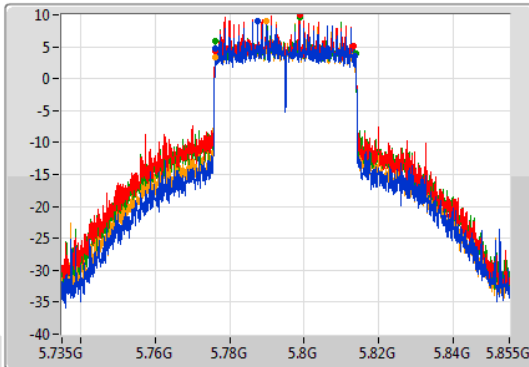

CF
5.795GHz
Span
120MHz
RBW
1MHz
VBW
3MHz
Sweep Time
100ms
Detector Type
Sample

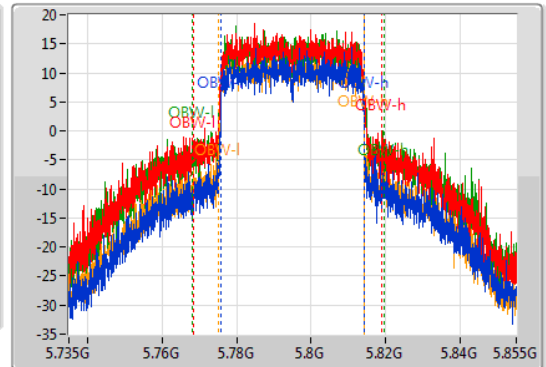

Port 1
Port 2
Port 3
Port 4

6dB(Hz)	Fl-6dB(Hz)	Fh-6dB(Hz)	OBW(Hz)	Fl-OBW(Hz)	Fh-OBW(Hz)	Limit(Hz)	Port
37.5M	5.77616G	5.81366G	38.381M	5.77575G	5.81413G	500k	1
37.14M	5.77622G	5.81336G	50.375M	5.768553G	5.818928G	500k	2
37.56M	5.77616G	5.81372G	51.214M	5.768193G	5.819408G	500k	3
37.32M	5.7761G	5.81342G	39.04M	5.77515G	5.81419G	500k	4

802.11ax HEW80_Nss1,(MCS0)_4TX

EBW

5210MHz

23/09/2019

CF
5.21GHz
Span
240MHz
RBW
1MHz
VBW
3MHz
Sweep Time
100ms
Detector Type
Peak

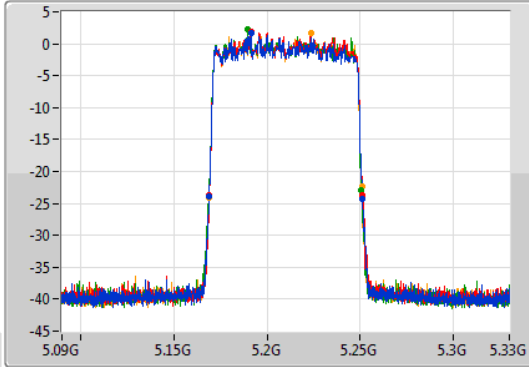

CF
5.21GHz
Span
240MHz
RBW
1MHz
VBW
3MHz
Sweep Time
100ms
Detector Type
Sample

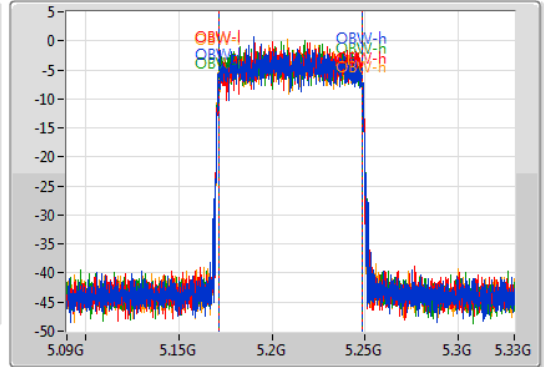

Port 1
Port 2
Port 3
Port 4

26dB(Hz)	Fl-26dB(Hz)	Fh-26dB(Hz)	OBW(Hz)	Fl-OBW(Hz)	Fh-OBW(Hz)	Limit(Hz)	Port
82.08M	5.16908G	5.25116G	77.001M	5.171379G	5.248381G	Inf	1
82.2M	5.16908G	5.25128G	77.001M	5.171499G	5.248501G	Inf	2
81.84M	5.16884G	5.25068G	77.121M	5.171259G	5.248381G	Inf	3
81.72M	5.16908G	5.2508G	77.001M	5.171379G	5.248381G	Inf	4

802.11ax HEW80_Nss1,(MCS0)_4TX

EBW

5775MHz

23/09/2019

CF
5.775GHz
Span
240MHz
RBW
100kHz
VBW
300kHz
Sweep Time
100ms
Detector Type
Peak



CF
5.775GHz
Span
240MHz
RBW
1MHz
VBW
3MHz
Sweep Time
100ms
Detector Type
Sample

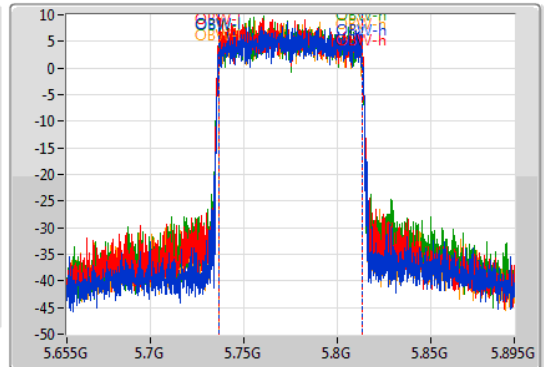

Port 1
Port 2
Port 3
Port 4

6dB(Hz)	Fl-6dB(Hz)	Fh-6dB(Hz)	OBW(Hz)	Fl-OBW(Hz)	Fh-OBW(Hz)	Limit(Hz)	Port
76.56M	5.73648G	5.81304G	77.001M	5.736379G	5.813381G	500k	1
76.32M	5.73624G	5.81256G	77.121M	5.736259G	5.813381G	500k	2
77.16M	5.73612G	5.81328G	77.241M	5.736259G	5.813501G	500k	3
77.52M	5.73624G	5.81376G	76.762M	5.736379G	5.813141G	500k	4



Summary

Mode	Max-N dB (Hz)	Max-OBW (Hz)	ITU-Code	Min-N dB (Hz)	Min-OBW (Hz)
5.15-5.25GHz	-	-	-	-	-
802.11ac VHT20_Nss4,(MCS0)_4TX	21.81M	17.781M	17M8D1D	21.51M	17.691M
802.11ac VHT40_Nss4,(MCS0)_4TX	40.2M	36.402M	36M4D1D	39.66M	36.102M
802.11ac VHT80_Nss4,(MCS0)_4TX	82.08M	75.802M	75M8D1D	81.12M	75.682M
802.11ax HEW20_Nss4,(MCS0)_4TX	21.96M	19.01M	19M0D1D	21.3M	18.951M
802.11ax HEW40_Nss4,(MCS0)_4TX	40.14M	37.661M	37M7D1D	39.72M	37.481M
802.11ax HEW80_Nss4,(MCS0)_4TX	82.08M	77.121M	77M1D1D	81M	77.001M
5.725-5.85GHz	-	-	-	-	-
802.11ac VHT20_Nss4,(MCS0)_4TX	17.55M	27.166M	27M2D1D	17.16M	18.231M
802.11ac VHT40_Nss4,(MCS0)_4TX	36.36M	53.253M	53M3D1D	35.88M	36.642M
802.11ac VHT80_Nss4,(MCS0)_4TX	76.32M	75.922M	75M9D1D	75.12M	75.682M
802.11ax HEW20_Nss4,(MCS0)_4TX	18.81M	28.546M	28M5D1D	18.12M	19.28M
802.11ax HEW40_Nss4,(MCS0)_4TX	37.68M	54.993M	55M0D1D	36.42M	37.901M
802.11ax HEW80_Nss4,(MCS0)_4TX	76.68M	77.241M	77M2D1D	76.32M	76.762M

Max-N dB = Maximum 6dB down bandwidth for 5.725-5.85GHz band / Maximum 26dB down bandwidth for other band;

Max-OBW = Maximum 99% occupied bandwidth;

Min-N dB = Minimum 6dB down bandwidth for 5.725-5.85GHz band / Maximum 26dB down bandwidth for other band;

Min-OBW = Minimum 99% occupied bandwidth;



Result

Mode	Result	Limit (Hz)	Port 1-N dB (Hz)	Port 1-OBW (Hz)	Port 2-N dB (Hz)	Port 2-OBW (Hz)	Port 3-N dB (Hz)	Port 3-OBW (Hz)	Port 4-N dB (Hz)	Port 4-OBW (Hz)
802.11ac VHT20_Nss4,(MCS0)_4TX	-	-	-	-	-	-	-	-	-	-
5180MHz	Pass	Inf	21.6M	17.751M	21.63M	17.781M	21.66M	17.781M	21.6M	17.691M
5200MHz	Pass	Inf	21.72M	17.781M	21.51M	17.721M	21.81M	17.721M	21.66M	17.691M
5240MHz	Pass	Inf	21.69M	17.691M	21.57M	17.781M	21.75M	17.751M	21.57M	17.691M
5745MHz	Pass	500k	17.55M	18.231M	17.55M	19.85M	17.55M	21.499M	17.55M	19.37M
5785MHz	Pass	500k	17.49M	21.739M	17.31M	26.807M	17.16M	26.777M	17.55M	24.948M
5825MHz	Pass	500k	17.55M	21.769M	17.55M	27.166M	17.52M	25.937M	17.55M	23.358M
802.11ac VHT40_Nss4,(MCS0)_4TX	-	-	-	-	-	-	-	-	-	-
5190MHz	Pass	Inf	40.2M	36.282M	39.72M	36.102M	39.78M	36.222M	39.78M	36.402M
5230MHz	Pass	Inf	40.2M	36.222M	39.66M	36.282M	39.72M	36.162M	40.02M	36.282M
5755MHz	Pass	500k	36.3M	36.642M	36.3M	37.121M	36.06M	37.841M	36.3M	36.702M
5795MHz	Pass	500k	36.3M	39.58M	36.24M	51.934M	35.88M	53.253M	36.36M	45.337M
802.11ac VHT80_Nss4,(MCS0)_4TX	-	-	-	-	-	-	-	-	-	-
5210MHz	Pass	Inf	82.08M	75.802M	81.36M	75.682M	81.12M	75.802M	81.72M	75.802M
5775MHz	Pass	500k	75.12M	75.802M	76.32M	75.922M	75.72M	75.682M	75.72M	75.682M
802.11ax HEW20_Nss4,(MCS0)_4TX	-	-	-	-	-	-	-	-	-	-
5180MHz	Pass	Inf	21.39M	18.981M	21.87M	19.01M	21.45M	19.01M	21.78M	19.01M
5200MHz	Pass	Inf	21.3M	18.951M	21.9M	19.01M	21.39M	19.01M	21.75M	19.01M
5240MHz	Pass	Inf	21.33M	18.981M	21.96M	19.01M	21.45M	19.01M	21.69M	19.01M
5745MHz	Pass	500k	18.81M	19.28M	18.39M	19.91M	18.36M	21.889M	18.81M	19.76M
5785MHz	Pass	500k	18.75M	22.669M	18.24M	27.586M	18.3M	28.546M	18.12M	25.547M
5825MHz	Pass	500k	18.72M	23.178M	18.18M	27.526M	18.33M	27.526M	18.18M	24.348M
802.11ax HEW40_Nss4,(MCS0)_4TX	-	-	-	-	-	-	-	-	-	-
5190MHz	Pass	Inf	39.96M	37.541M	40.08M	37.541M	39.78M	37.601M	40.08M	37.661M
5230MHz	Pass	Inf	39.96M	37.541M	39.9M	37.601M	39.72M	37.481M	40.14M	37.601M
5755MHz	Pass	500k	37.68M	37.901M	36.72M	38.141M	37.56M	38.381M	36.48M	38.021M
5795MHz	Pass	500k	37.62M	38.681M	36.48M	54.993M	37.62M	53.433M	36.42M	44.198M
802.11ax HEW80_Nss4,(MCS0)_4TX	-	-	-	-	-	-	-	-	-	-
5210MHz	Pass	Inf	81.36M	77.001M	81M	77.121M	81.36M	77.001M	82.08M	77.121M
5775MHz	Pass	500k	76.32M	76.762M	76.68M	76.882M	76.44M	77.241M	76.68M	77.121M

Port X-N dB = Port X 6dB down bandwidth for 5.725-5.85GHz band / 26dB down bandwidth for other band

Port X-OBW = Port X 99% occupied bandwidth;

802.11ac VHT20_Nss4,(MCS0)_4TX

EBW

5180MHz

23/09/2019

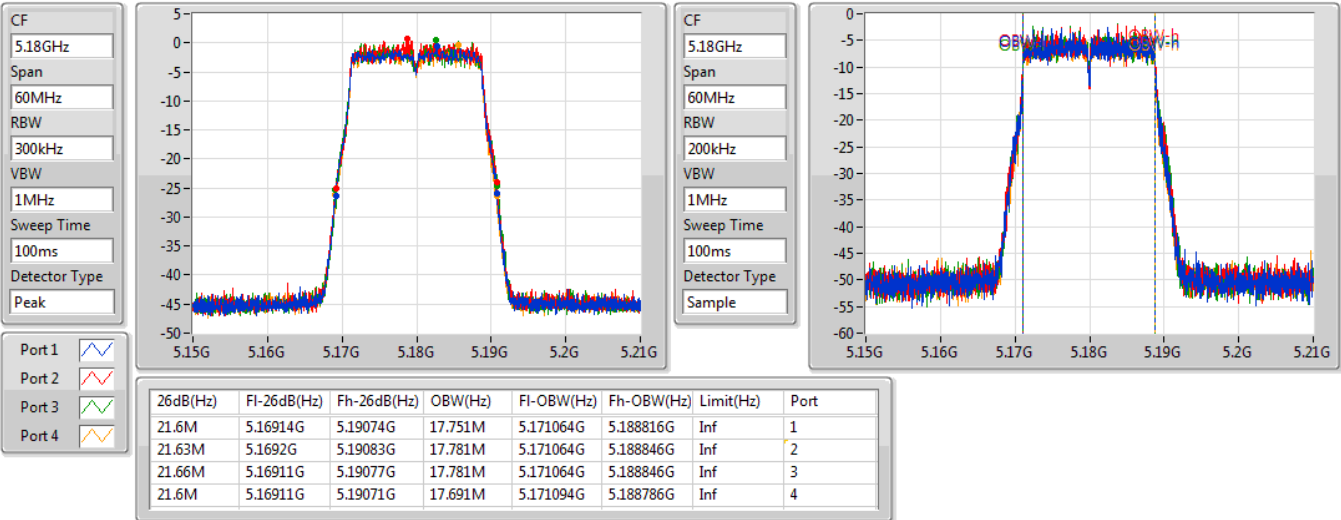

802.11ac VHT20_Nss4,(MCS0)_4TX

EBW

5200MHz

23/09/2019

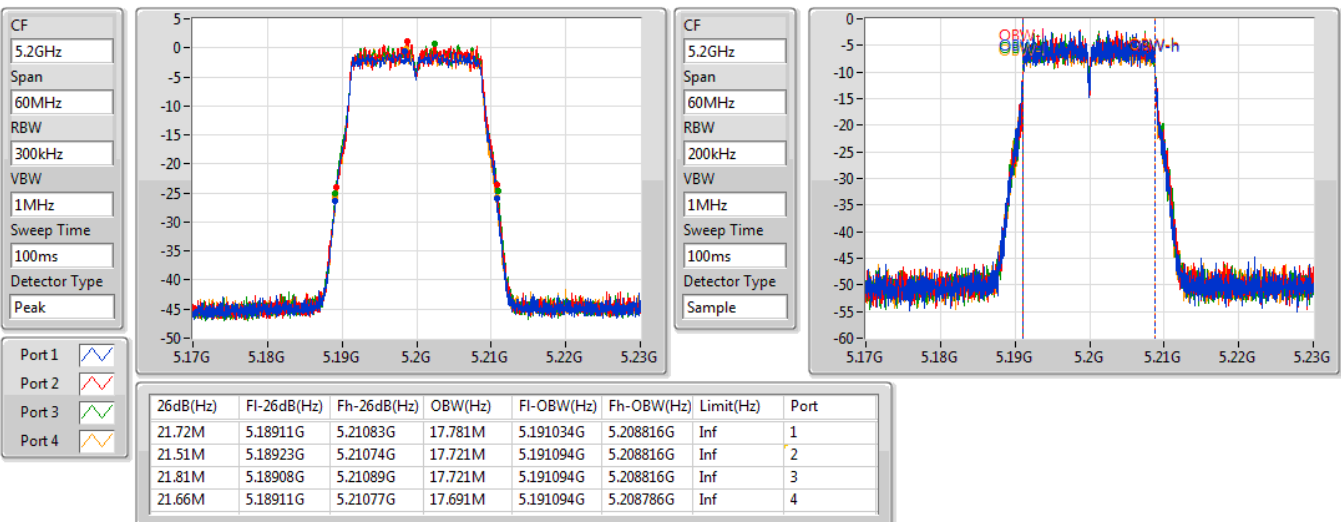

802.11ac VHT20_Nss4,(MCS0)_4TX

EBW

5240MHz

23/09/2019

CF
5.24GHz
Span
60MHz
RBW
300kHz
VBW
1MHz
Sweep Time
100ms
Detector Type
Peak

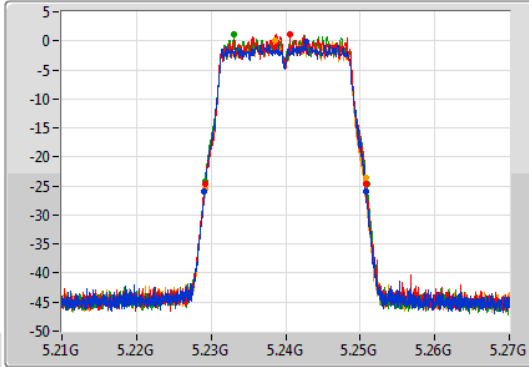

CF
5.24GHz
Span
60MHz
RBW
200kHz
VBW
1MHz
Sweep Time
100ms
Detector Type
Sample

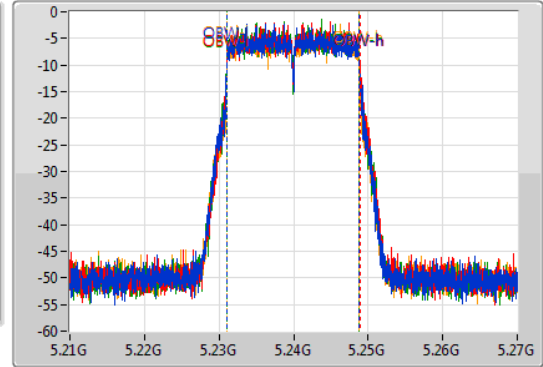

Port 1
Port 2
Port 3
Port 4

26dB(Hz)	Fl-26dB(Hz)	Fh-26dB(Hz)	OBW(Hz)	Fl-OBW(Hz)	Fh-OBW(Hz)	Limit(Hz)	Port
21.69M	5.22911G	5.2508G	17.691M	5.231124G	5.248816G	Inf	1
21.57M	5.22923G	5.2508G	17.781M	5.231094G	5.248876G	Inf	2
21.75M	5.22914G	5.25089G	17.751M	5.231094G	5.248846G	Inf	3
21.57M	5.22914G	5.25071G	17.691M	5.231094G	5.248786G	Inf	4

802.11ac VHT20_Nss4,(MCS0)_4TX

EBW

5745MHz

23/09/2019

CF
5.745GHz
Span
60MHz
RBW
100kHz
VBW
300kHz
Sweep Time
100ms
Detector Type
Peak

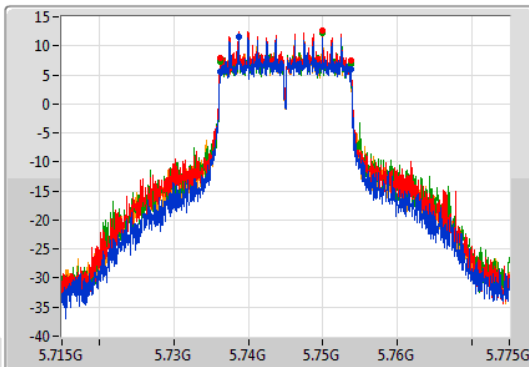

CF
5.745GHz
Span
60MHz
RBW
300kHz
VBW
1MHz
Sweep Time
100ms
Detector Type
Sample

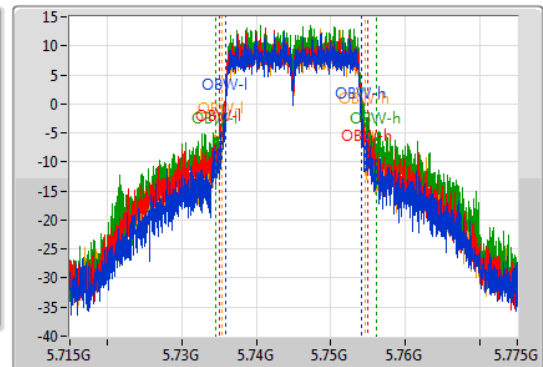

Port 1
Port 2
Port 3
Port 4

6dB(Hz)	Fl-6dB(Hz)	Fh-6dB(Hz)	OBW(Hz)	Fl-OBW(Hz)	Fh-OBW(Hz)	Limit(Hz)	Port
17.55M	5.73618G	5.75373G	18.231M	5.735855G	5.754085G	500k	1
17.55M	5.73618G	5.75373G	19.85M	5.735015G	5.754865G	500k	2
17.55M	5.73618G	5.75373G	21.499M	5.734565G	5.756064G	500k	3
17.55M	5.73618G	5.75373G	19.37M	5.735315G	5.754685G	500k	4

802.11ac VHT20_Nss4,(MCS0)_4TX

EBW

5785MHz

23/09/2019

CF
5.785GHz
Span
60MHz
RBW
100kHz
VBW
300kHz
Sweep Time
100ms
Detector Type
Peak

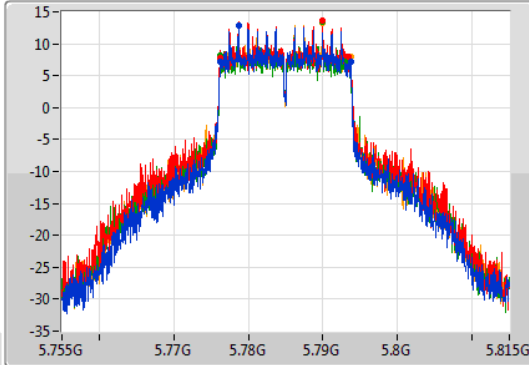

CF
5.785GHz
Span
60MHz
RBW
300kHz
VBW
1MHz
Sweep Time
100ms
Detector Type
Sample

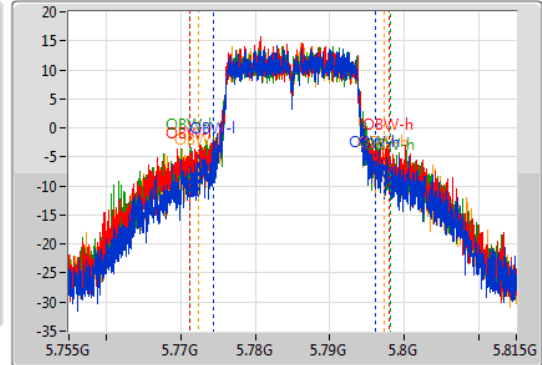

Port 1
Port 2
Port 3
Port 4

6dB(Hz)	Fl-6dB(Hz)	Fh-6dB(Hz)	OBW(Hz)	Fl-OBW(Hz)	Fh-OBW(Hz)	Limit(Hz)	Port
17.49M	5.77621G	5.7937G	21.739M	5.774325G	5.796064G	500k	1
17.31M	5.77618G	5.79349G	26.807M	5.771207G	5.798013G	500k	2
17.16M	5.77618G	5.79334G	26.777M	5.771267G	5.798043G	500k	3
17.55M	5.77618G	5.79373G	24.948M	5.772346G	5.797294G	500k	4

802.11ac VHT20_Nss4,(MCS0)_4TX

EBW

5825MHz

23/09/2019

CF
5.825GHz
Span
60MHz
RBW
100kHz
VBW
300kHz
Sweep Time
100ms
Detector Type
Peak

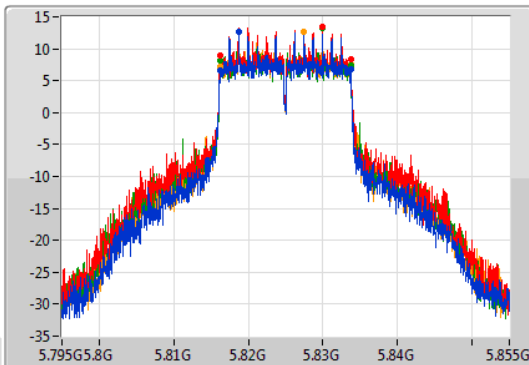

CF
5.825GHz
Span
60MHz
RBW
300kHz
VBW
1MHz
Sweep Time
100ms
Detector Type
Sample

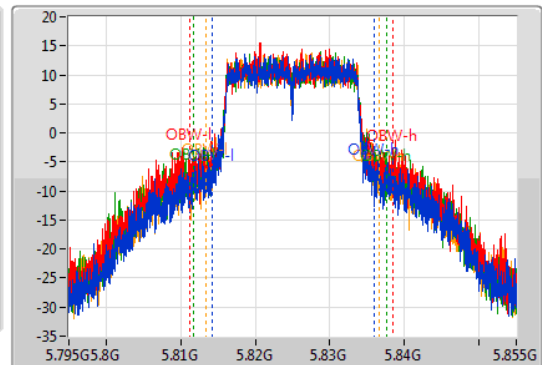

Port 1
Port 2
Port 3
Port 4

6dB(Hz)	Fl-6dB(Hz)	Fh-6dB(Hz)	OBW(Hz)	Fl-OBW(Hz)	Fh-OBW(Hz)	Limit(Hz)	Port
17.55M	5.81618G	5.83373G	21.769M	5.814235G	5.836004G	500k	1
17.55M	5.81618G	5.83373G	27.166M	5.811237G	5.838403G	500k	2
17.52M	5.81618G	5.8337G	25.937M	5.811717G	5.837654G	500k	3
17.55M	5.81618G	5.83373G	23.358M	5.813306G	5.836664G	500k	4

802.11ac VHT40_Nss4,(MCS0)_4TX

EBW

5190MHz

23/09/2019

CF
5.19GHz
Span
120MHz
RBW
500kHz
VBW
2MHz
Sweep Time
100ms
Detector Type
Peak

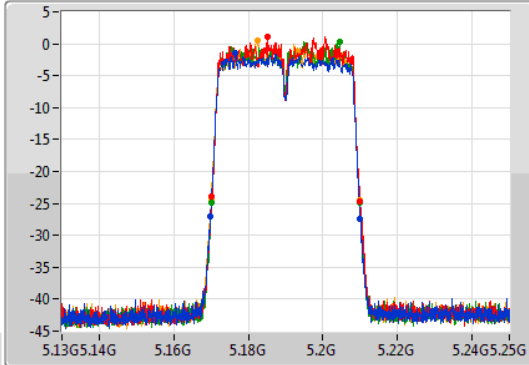

CF
5.19GHz
Span
120MHz
RBW
500kHz
VBW
2MHz
Sweep Time
100ms
Detector Type
Sample



Port 1
Port 2
Port 3
Port 4

26dB(Hz)	Fl-26dB(Hz)	Fh-26dB(Hz)	OBW(Hz)	Fl-OBW(Hz)	Fh-OBW(Hz)	Limit(Hz)	Port
40.2M	5.16984G	5.21004G	36.282M	5.171769G	5.208051G	Inf	1
39.72M	5.17026G	5.20998G	36.102M	5.171889G	5.207991G	Inf	2
39.78M	5.17014G	5.20992G	36.222M	5.171829G	5.208051G	Inf	3
39.78M	5.17002G	5.2098G	36.402M	5.171769G	5.208171G	Inf	4

802.11ac VHT40_Nss4,(MCS0)_4TX

EBW

5230MHz

23/09/2019

CF
5.23GHz
Span
120MHz
RBW
500kHz
VBW
2MHz
Sweep Time
100ms
Detector Type
Peak

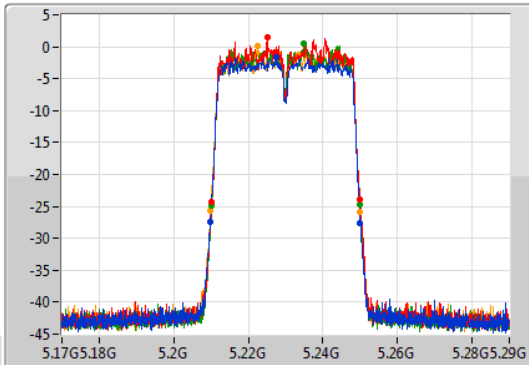

CF
5.23GHz
Span
120MHz
RBW
500kHz
VBW
2MHz
Sweep Time
100ms
Detector Type
Sample



Port 1
Port 2
Port 3
Port 4

26dB(Hz)	Fl-26dB(Hz)	Fh-26dB(Hz)	OBW(Hz)	Fl-OBW(Hz)	Fh-OBW(Hz)	Limit(Hz)	Port
40.2M	5.20984G	5.25004G	36.222M	5.211829G	5.248051G	Inf	1
39.66M	5.21026G	5.24992G	36.282M	5.211829G	5.248111G	Inf	2
39.72M	5.2102G	5.24992G	36.162M	5.211889G	5.248051G	Inf	3
40.02M	5.2099G	5.24992G	36.282M	5.211829G	5.248111G	Inf	4

802.11ac VHT40_Nss4,(MCS0)_4TX

EBW

5755MHz

23/09/2019

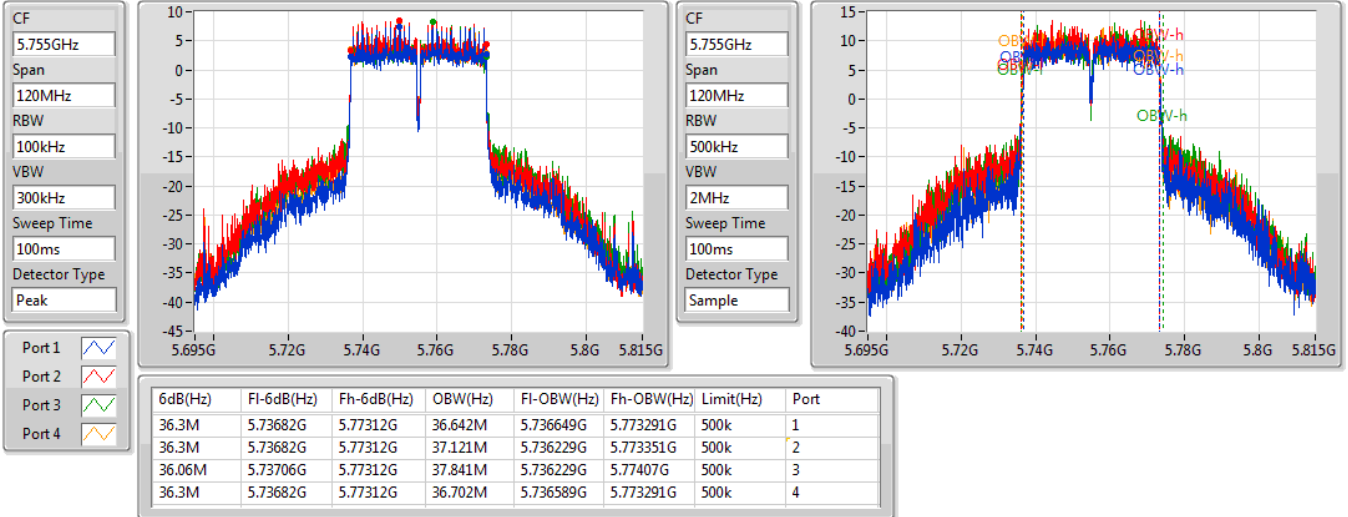

802.11ac VHT40_Nss4,(MCS0)_4TX

EBW

5795MHz

23/09/2019

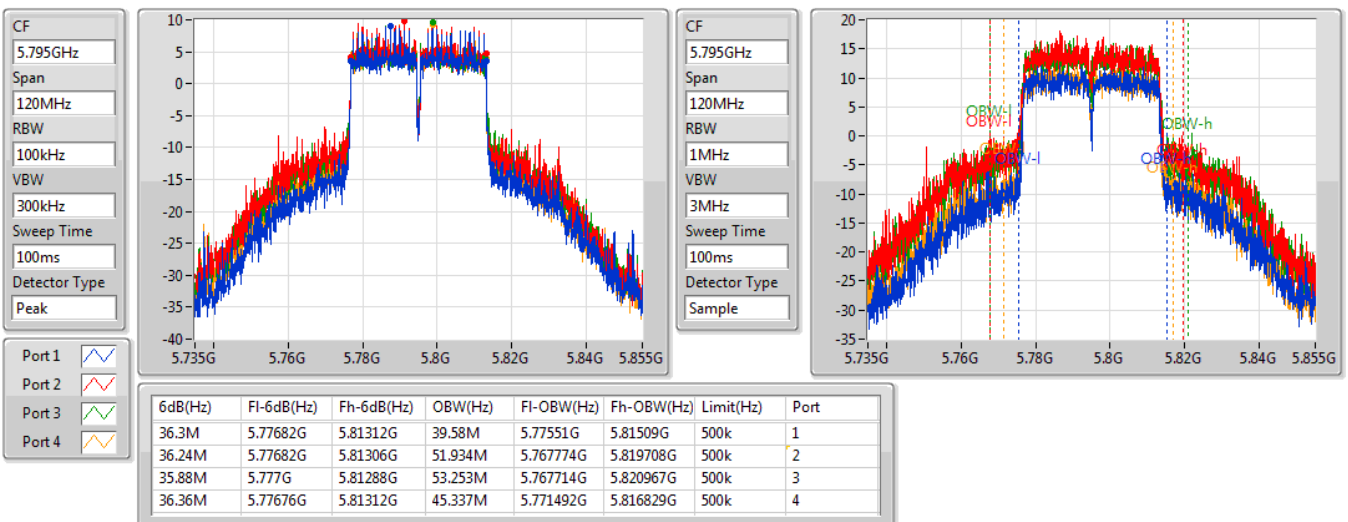

802.11ac VHT80_Nss4,(MCS0)_4TX

EBW

5210MHz

23/09/2019

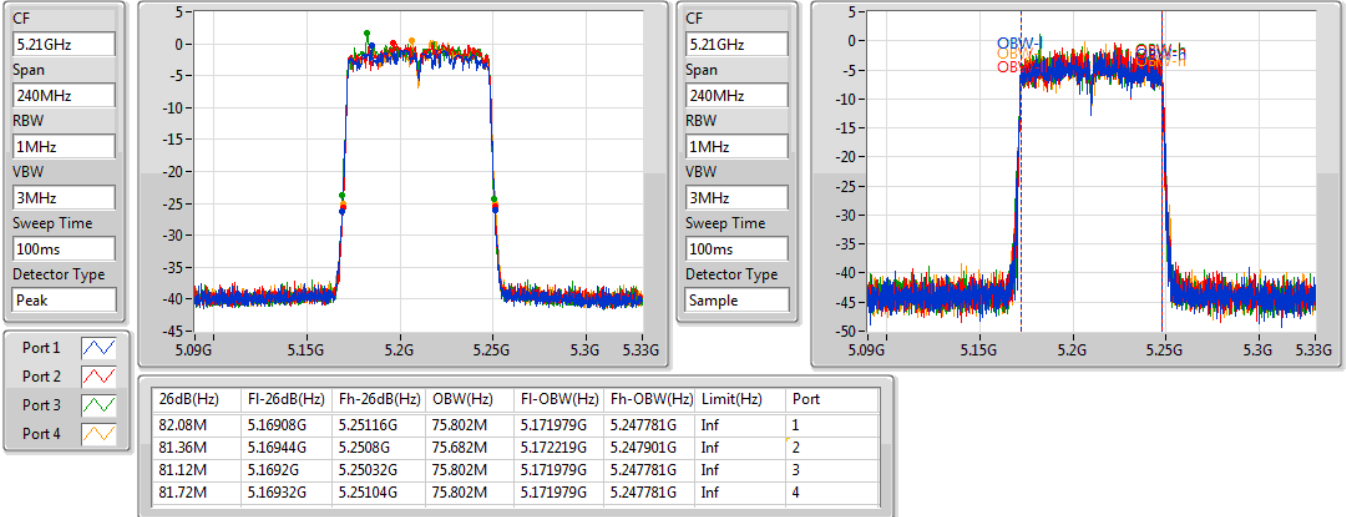

802.11ac VHT80_Nss4,(MCS0)_4TX

EBW

5775MHz

23/09/2019

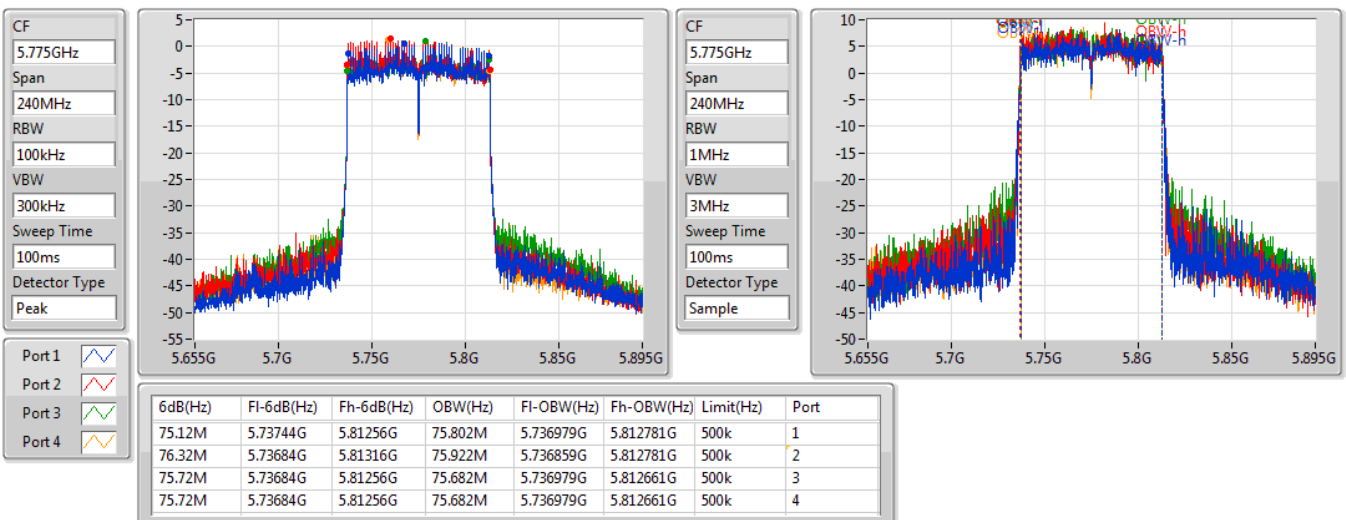

802.11ax HEW20_Nss4,(MCS0)_4TX

EBW

5180MHz

23/09/2019

CF
5.18GHz
Span
60MHz
RBW
300kHz
VBW
1MHz
Sweep Time
100ms
Detector Type
Peak

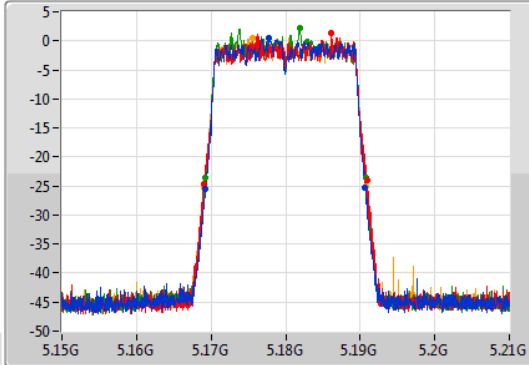

CF
5.18GHz
Span
60MHz
RBW
200kHz
VBW
1MHz
Sweep Time
100ms
Detector Type
Sample

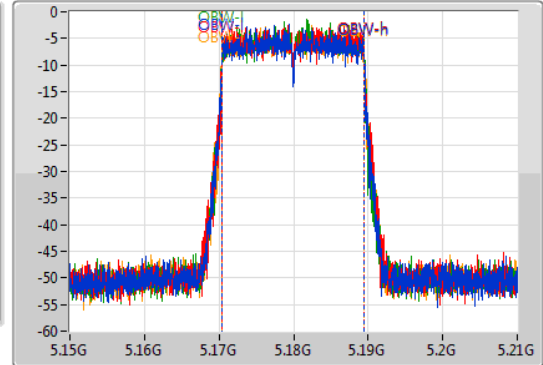

Port 1
Port 2
Port 3
Port 4

26dB(Hz)	Fl-26dB(Hz)	Fh-26dB(Hz)	OBW(Hz)	Fl-OBW(Hz)	Fh-OBW(Hz)	Limit(Hz)	Port
21.39M	5.16929G	5.19068G	18.981M	5.170435G	5.189415G	Inf	1
21.87M	5.16905G	5.19092G	19.01M	5.170435G	5.189445G	Inf	2
21.45M	5.16926G	5.19071G	19.01M	5.170435G	5.189445G	Inf	3
21.78M	5.16908G	5.19086G	19.01M	5.170405G	5.189415G	Inf	4

802.11ax HEW20_Nss4,(MCS0)_4TX

EBW

5200MHz

23/09/2019

CF
5.2GHz
Span
60MHz
RBW
300kHz
VBW
1MHz
Sweep Time
100ms
Detector Type
Peak

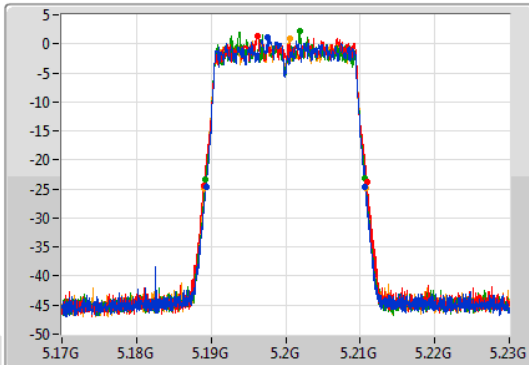

CF
5.2GHz
Span
60MHz
RBW
200kHz
VBW
1MHz
Sweep Time
100ms
Detector Type
Sample

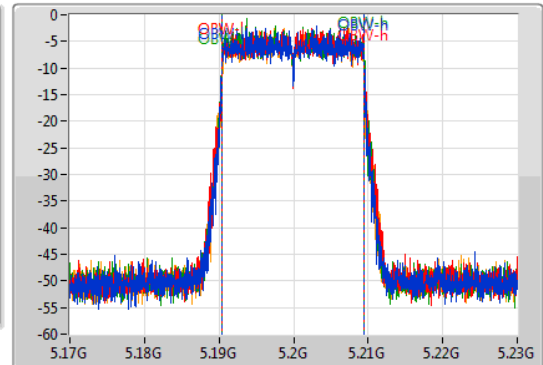

Port 1
Port 2
Port 3
Port 4

26dB(Hz)	Fl-26dB(Hz)	Fh-26dB(Hz)	OBW(Hz)	Fl-OBW(Hz)	Fh-OBW(Hz)	Limit(Hz)	Port
21.3M	5.18932G	5.21062G	18.951M	5.190465G	5.209415G	Inf	1
21.9M	5.18902G	5.21092G	19.01M	5.190435G	5.209445G	Inf	2
21.39M	5.18929G	5.21068G	19.01M	5.190435G	5.209445G	Inf	3
21.75M	5.18908G	5.21083G	19.01M	5.190435G	5.209445G	Inf	4

802.11ax HEW20_Nss4,(MCS0)_4TX

EBW

5240MHz

23/09/2019

CF
5.24GHz
Span
60MHz
RBW
300kHz
VBW
1MHz
Sweep Time
100ms
Detector Type
Peak

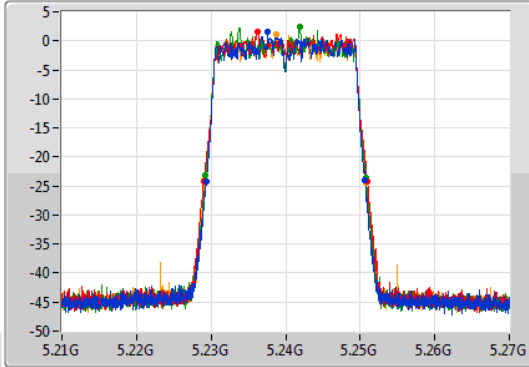

CF
5.24GHz
Span
60MHz
RBW
200kHz
VBW
1MHz
Sweep Time
100ms
Detector Type
Sample

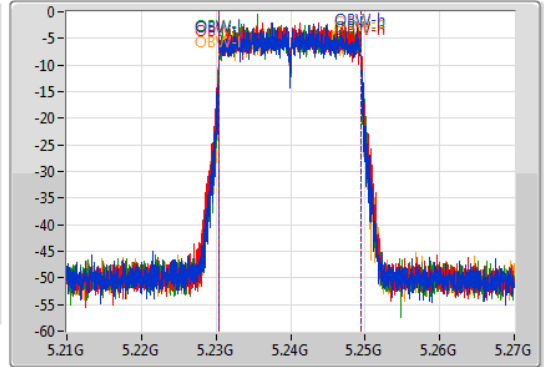

Port 1
Port 2
Port 3
Port 4

26dB(Hz)	Fl-26dB(Hz)	Fh-26dB(Hz)	OBW(Hz)	Fl-OBW(Hz)	Fh-OBW(Hz)	Limit(Hz)	Port
21.33M	5.22935G	5.25068G	18.981M	5.230465G	5.249445G	Inf	1
21.96M	5.22902G	5.25098G	19.01M	5.230465G	5.249475G	Inf	2
21.45M	5.22929G	5.25074G	19.01M	5.230435G	5.249445G	Inf	3
21.69M	5.22911G	5.2508G	19.01M	5.230435G	5.249445G	Inf	4

802.11ax HEW20_Nss4,(MCS0)_4TX

EBW

5745MHz

23/09/2019

CF
5.745GHz
Span
60MHz
RBW
100kHz
VBW
300kHz
Sweep Time
100ms
Detector Type
Peak

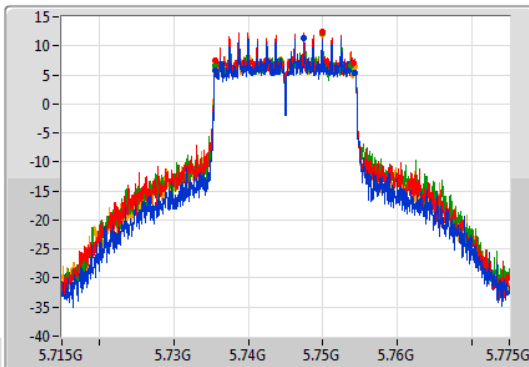

CF
5.745GHz
Span
60MHz
RBW
300kHz
VBW
1MHz
Sweep Time
100ms
Detector Type
Sample

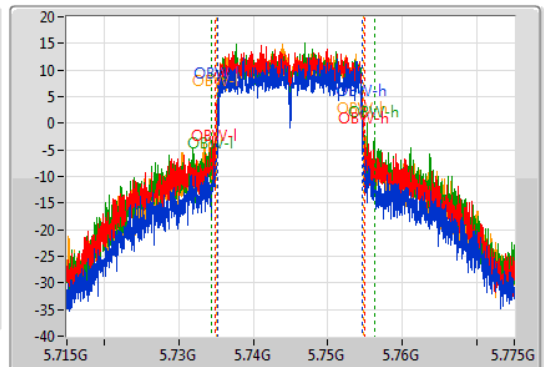

Port 1
Port 2
Port 3
Port 4

6dB(Hz)	Fl-6dB(Hz)	Fh-6dB(Hz)	OBW(Hz)	Fl-OBW(Hz)	Fh-OBW(Hz)	Limit(Hz)	Port
18.81M	5.73552G	5.75433G	19.28M	5.735285G	5.754565G	500k	1
18.39M	5.73564G	5.75403G	19.91M	5.734955G	5.754865G	500k	2
18.36M	5.73549G	5.75385G	21.889M	5.734385G	5.756274G	500k	3
18.81M	5.73552G	5.75433G	19.76M	5.734985G	5.754745G	500k	4

802.11ax HEW20_Nss4,(MCS0)_4TX

EBW

5785MHz

23/09/2019

CF
5.785GHz
Span
60MHz
RBW
100kHz
VBW
300kHz
Sweep Time
100ms
Detector Type
Peak

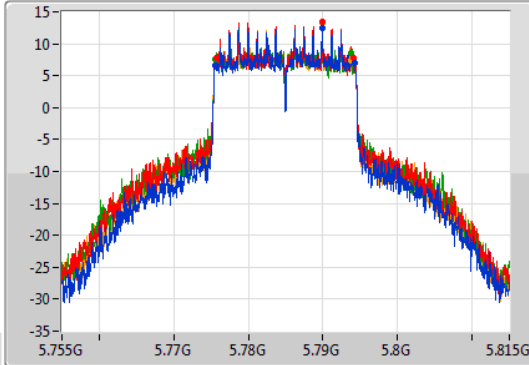

CF
5.785GHz
Span
60MHz
RBW
300kHz
VBW
1MHz
Sweep Time
100ms
Detector Type
Sample

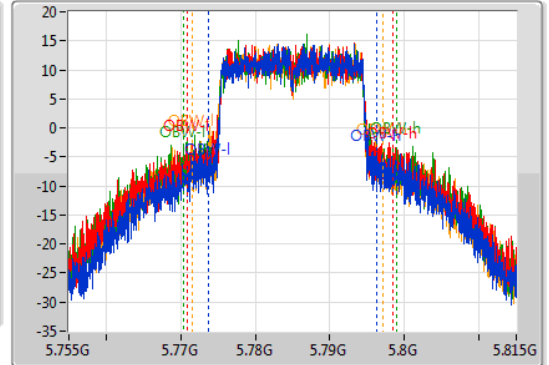

Port 1
Port 2
Port 3
Port 4

6dB(Hz)	Fl-6dB(Hz)	Fh-6dB(Hz)	OBW(Hz)	Fl-OBW(Hz)	Fh-OBW(Hz)	Limit(Hz)	Port
18.75M	5.77555G	5.7943G	22.669M	5.773696G	5.796364G	500k	1
18.24M	5.77579G	5.79403G	27.586M	5.770847G	5.798433G	500k	2
18.3M	5.77549G	5.79379G	28.546M	5.770367G	5.798913G	500k	3
18.12M	5.77564G	5.79376G	25.547M	5.771627G	5.797174G	500k	4

802.11ax HEW20_Nss4,(MCS0)_4TX

EBW

5825MHz

23/09/2019

CF
5.825GHz
Span
60MHz
RBW
100kHz
VBW
300kHz
Sweep Time
100ms
Detector Type
Peak

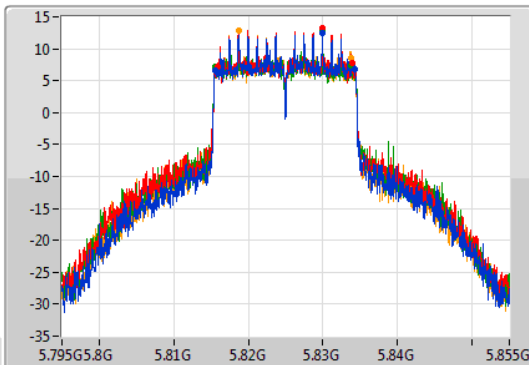

CF
5.825GHz
Span
60MHz
RBW
300kHz
VBW
1MHz
Sweep Time
100ms
Detector Type
Sample

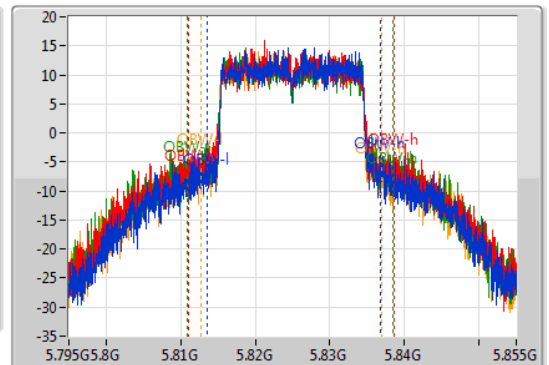

Port 1
Port 2
Port 3
Port 4

6dB(Hz)	Fl-6dB(Hz)	Fh-6dB(Hz)	OBW(Hz)	Fl-OBW(Hz)	Fh-OBW(Hz)	Limit(Hz)	Port
18.72M	5.81558G	5.8343G	23.178M	5.813546G	5.836724G	500k	1
18.18M	5.81582G	5.834G	27.526M	5.811087G	5.838613G	500k	2
18.33M	5.81549G	5.83382G	27.526M	5.810937G	5.838463G	500k	3
18.18M	5.81555G	5.83373G	24.348M	5.812646G	5.836994G	500k	4

802.11ax HEW40_Nss4,(MCS0)_4TX

EBW

5190MHz

23/09/2019

CF
5.19GHz
Span
120MHz
RBW
500kHz
VBW
2MHz
Sweep Time
100ms
Detector Type
Peak

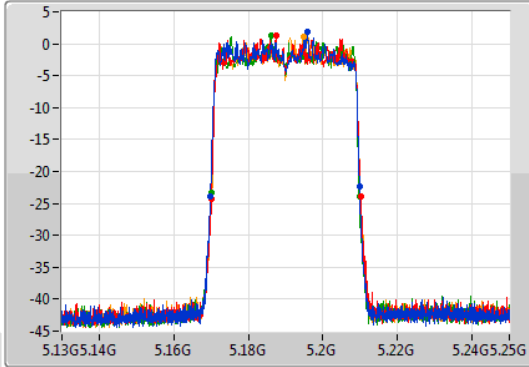

CF
5.19GHz
Span
120MHz
RBW
500kHz
VBW
2MHz
Sweep Time
100ms
Detector Type
Sample

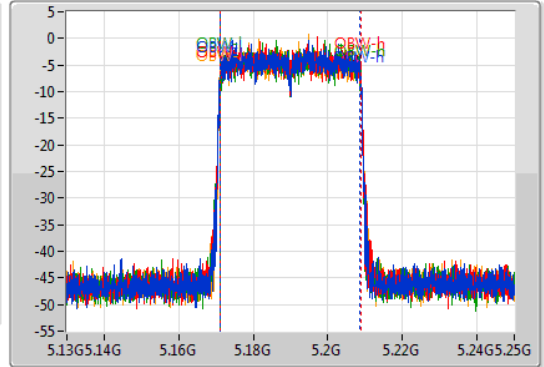

Port 1
Port 2
Port 3
Port 4

26dB(Hz)	Fl-26dB(Hz)	Fh-26dB(Hz)	OBW(Hz)	Fl-OBW(Hz)	Fh-OBW(Hz)	Limit(Hz)	Port
39.96M	5.16984G	5.2098G	37.541M	5.171169G	5.208711G	Inf	1
40.08M	5.17008G	5.21016G	37.541M	5.171229G	5.208771G	Inf	2
39.78M	5.17002G	5.2098G	37.601M	5.171169G	5.208771G	Inf	3
40.08M	5.17002G	5.2101G	37.661M	5.171109G	5.208771G	Inf	4

802.11ax HEW40_Nss4,(MCS0)_4TX

EBW

5230MHz

23/09/2019

CF
5.23GHz
Span
120MHz
RBW
500kHz
VBW
2MHz
Sweep Time
100ms
Detector Type
Peak

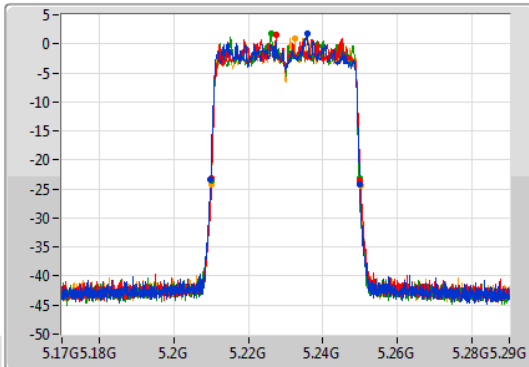

CF
5.23GHz
Span
120MHz
RBW
500kHz
VBW
2MHz
Sweep Time
100ms
Detector Type
Sample

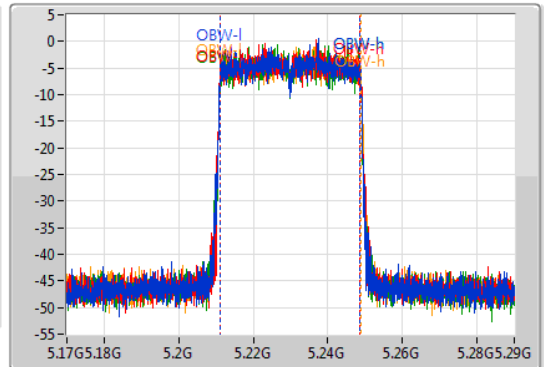

Port 1
Port 2
Port 3
Port 4

26dB(Hz)	Fl-26dB(Hz)	Fh-26dB(Hz)	OBW(Hz)	Fl-OBW(Hz)	Fh-OBW(Hz)	Limit(Hz)	Port
39.96M	5.2099G	5.24986G	37.541M	5.211169G	5.248711G	Inf	1
39.9M	5.21014G	5.25004G	37.601M	5.211109G	5.248711G	Inf	2
39.72M	5.21008G	5.2498G	37.481M	5.211229G	5.248711G	Inf	3
40.14M	5.20996G	5.2501G	37.601M	5.211169G	5.248771G	Inf	4

802.11ax HEW40_Nss4,(MCS0)_4TX

EBW

5755MHz

23/09/2019

CF
5.755GHz
Span
120MHz
RBW
100kHz
VBW
300kHz
Sweep Time
100ms
Detector Type
Peak

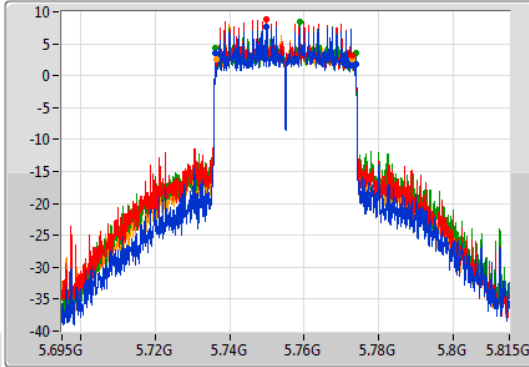

CF
5.755GHz
Span
120MHz
RBW
500kHz
VBW
2MHz
Sweep Time
100ms
Detector Type
Sample

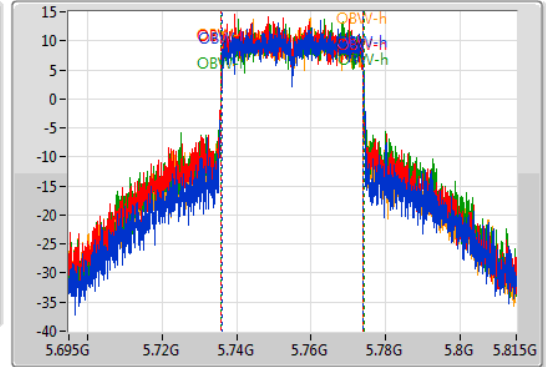

Port 1
Port 2
Port 3
Port 4

6dB(Hz)	Fl-6dB(Hz)	Fh-6dB(Hz)	OBW(Hz)	Fl-OBW(Hz)	Fh-OBW(Hz)	Limit(Hz)	Port
37.68M	5.73622G	5.7739G	37.901M	5.736049G	5.773951G	500k	1
36.72M	5.73616G	5.77288G	38.141M	5.73581G	5.773951G	500k	2
37.56M	5.73616G	5.77372G	38.381M	5.73581G	5.77419G	500k	3
36.48M	5.73634G	5.77282G	38.021M	5.73587G	5.773891G	500k	4

802.11ax HEW40_Nss4,(MCS0)_4TX

EBW

5795MHz

23/09/2019

CF
5.795GHz
Span
120MHz
RBW
100kHz
VBW
300kHz
Sweep Time
100ms
Detector Type
Peak

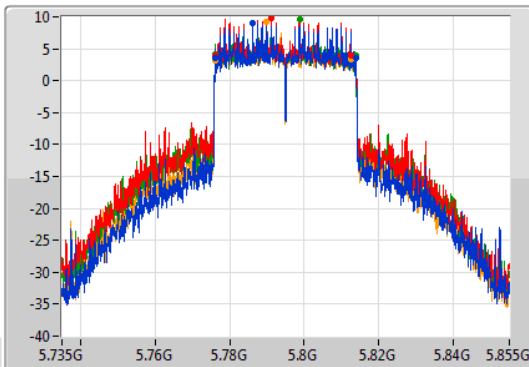

CF
5.795GHz
Span
120MHz
RBW
1MHz
VBW
3MHz
Sweep Time
100ms
Detector Type
Sample

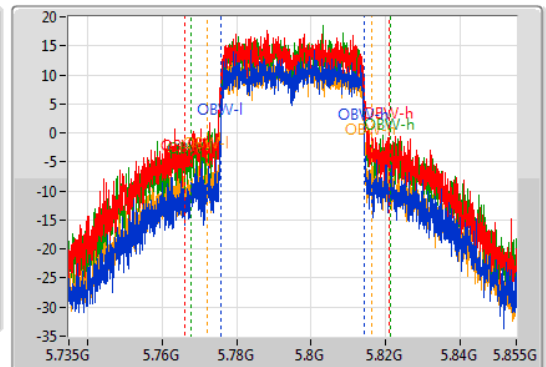

Port 1
Port 2
Port 3
Port 4

6dB(Hz)	Fl-6dB(Hz)	Fh-6dB(Hz)	OBW(Hz)	Fl-OBW(Hz)	Fh-OBW(Hz)	Limit(Hz)	Port
37.62M	5.7761G	5.81372G	38.681M	5.77569G	5.81437G	500k	1
36.48M	5.7761G	5.81258G	54.993M	5.765975G	5.820967G	500k	2
37.62M	5.7761G	5.81372G	53.433M	5.767714G	5.821147G	500k	3
36.42M	5.77622G	5.81264G	44.198M	5.772091G	5.816289G	500k	4

802.11ax HEW80_Nss4,(MCS0)_4TX

EBW

5210MHz

23/09/2019

CF
5.21GHz
Span
240MHz
RBW
1MHz
VBW
3MHz
Sweep Time
100ms
Detector Type
Peak

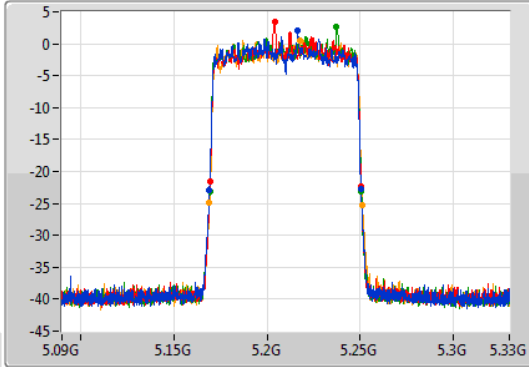

CF
5.21GHz
Span
240MHz
RBW
1MHz
VBW
3MHz
Sweep Time
100ms
Detector Type
Sample

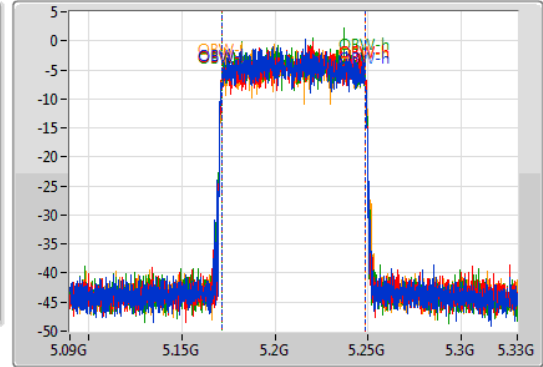

Port 1
Port 2
Port 3
Port 4

26dB(Hz)	Fl-26dB(Hz)	Fh-26dB(Hz)	OBW(Hz)	Fl-OBW(Hz)	Fh-OBW(Hz)	Limit(Hz)	Port
81.36M	5.16908G	5.25044G	77.001M	5.171379G	5.248381G	Inf	1
81M	5.16944G	5.25044G	77.121M	5.171379G	5.248501G	Inf	2
81.36M	5.16932G	5.25068G	77.001M	5.171499G	5.248501G	Inf	3
82.08M	5.1692G	5.25128G	77.121M	5.171379G	5.248501G	Inf	4

802.11ax HEW80_Nss4,(MCS0)_4TX

EBW

5775MHz

23/09/2019

CF
5.775GHz
Span
240MHz
RBW
100kHz
VBW
300kHz
Sweep Time
100ms
Detector Type
Peak

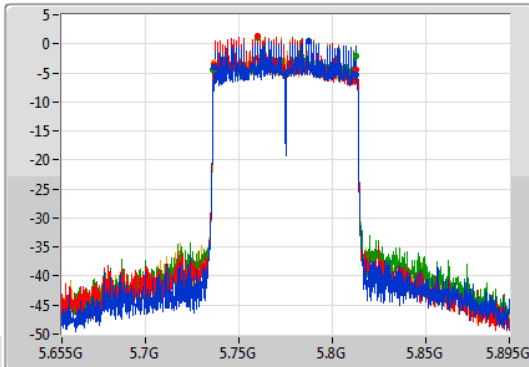

CF
5.775GHz
Span
240MHz
RBW
1MHz
VBW
3MHz
Sweep Time
100ms
Detector Type
Sample



Port 1
Port 2
Port 3
Port 4

6dB(Hz)	Fl-6dB(Hz)	Fh-6dB(Hz)	OBW(Hz)	Fl-OBW(Hz)	Fh-OBW(Hz)	Limit(Hz)	Port
76.32M	5.73648G	5.8128G	76.762M	5.736499G	5.813261G	500k	1
76.68M	5.73624G	5.81292G	76.882M	5.736379G	5.813261G	500k	2
76.44M	5.73612G	5.81256G	77.241M	5.736139G	5.813381G	500k	3
76.68M	5.73624G	5.81292G	77.121M	5.736259G	5.813381G	500k	4



Summary

Mode	Max-N dB (Hz)	Max-OBW (Hz)	ITU-Code	Min-N dB (Hz)	Min-OBW (Hz)
5.15-5.25GHz	-	-	-	-	-
802.11a_Nss1,(6Mbps)_1TX	21.57M	16.582M	16M6D1D	21.54M	16.552M
802.11ac VHT20_Nss1,(MCS0)_1TX	21.78M	17.811M	17M8D1D	21.75M	17.811M
802.11ac VHT40_Nss1,(MCS0)_1TX	40.32M	36.342M	36M3D1D	40.26M	36.282M
802.11ac VHT80_Nss1,(MCS0)_1TX	81.96M	75.682M	75M7D1D	81.96M	75.682M
802.11ax HEW20_Nss1,(MCS0)_1TX	21.72M	19.01M	19M0D1D	21.6M	18.981M
802.11ax HEW40_Nss1,(MCS0)_1TX	40.08M	37.601M	37M6D1D	39.96M	37.481M
802.11ax HEW80_Nss1,(MCS0)_1TX	81.96M	77.121M	77M1D1D	81.96M	77.121M
5.725-5.85GHz	-	-	-	-	-
802.11a_Nss1,(6Mbps)_1TX	16.35M	20.99M	21M0D1D	16.32M	16.612M
802.11ac VHT20_Nss1,(MCS0)_1TX	17.58M	18.141M	18M1D1D	17.58M	17.811M
802.11ac VHT40_Nss1,(MCS0)_1TX	36.3M	36.642M	36M6D1D	36.3M	36.522M
802.11ac VHT80_Nss1,(MCS0)_1TX	75.24M	76.162M	76M2D1D	75.24M	76.162M
802.11ax HEW20_Nss1,(MCS0)_1TX	18.96M	19.22M	19M2D1D	18.9M	19.04M
802.11ax HEW40_Nss1,(MCS0)_1TX	37.5M	37.841M	37M8D1D	37.5M	37.781M
802.11ax HEW80_Nss1,(MCS0)_1TX	77.04M	77.481M	77M5D1D	77.04M	77.481M

Max-N dB = Maximum 6dB down bandwidth for 5.725-5.85GHz band / Maximum 26dB down bandwidth for other band;

Max-OBW = Maximum 99% occupied bandwidth;

Min-N dB = Minimum 6dB down bandwidth for 5.725-5.85GHz band / Maximum 26dB down bandwidth for other band;

Min-OBW = Minimum 99% occupied bandwidth;



Result

Mode	Result	Limit (Hz)	Port 1-N dB (Hz)	Port 1-OBW (Hz)
802.11a_Nss1,(6Mbps)_1TX	-	-	-	-
5180MHz	Pass	Inf	21.57M	16.582M
5200MHz	Pass	Inf	21.54M	16.552M
5240MHz	Pass	Inf	21.54M	16.552M
5745MHz	Pass	500k	16.32M	20.99M
5785MHz	Pass	500k	16.35M	16.642M
5825MHz	Pass	500k	16.35M	16.612M
802.11ac VHT20_Nss1,(MCS0)_1TX	-	-	-	-
5180MHz	Pass	Inf	21.75M	17.811M
5200MHz	Pass	Inf	21.78M	17.811M
5240MHz	Pass	Inf	21.78M	17.811M
5745MHz	Pass	500k	17.58M	18.141M
5785MHz	Pass	500k	17.58M	17.811M
5825MHz	Pass	500k	17.58M	17.871M
802.11ac VHT40_Nss1,(MCS0)_1TX	-	-	-	-
5190MHz	Pass	Inf	40.26M	36.282M
5230MHz	Pass	Inf	40.32M	36.342M
5755MHz	Pass	500k	36.3M	36.642M
5795MHz	Pass	500k	36.3M	36.522M
802.11ac VHT80_Nss1,(MCS0)_1TX	-	-	-	-
5210MHz	Pass	Inf	81.96M	75.682M
5775MHz	Pass	500k	75.24M	76.162M
802.11ax HEW20_Nss1,(MCS0)_1TX	-	-	-	-
5180MHz	Pass	Inf	21.69M	19.01M
5200MHz	Pass	Inf	21.6M	19.01M
5240MHz	Pass	Inf	21.72M	18.981M
5745MHz	Pass	500k	18.9M	19.22M
5785MHz	Pass	500k	18.96M	19.07M
5825MHz	Pass	500k	18.96M	19.04M
802.11ax HEW40_Nss1,(MCS0)_1TX	-	-	-	-
5190MHz	Pass	Inf	39.96M	37.481M
5230MHz	Pass	Inf	40.08M	37.601M
5755MHz	Pass	500k	37.5M	37.841M
5795MHz	Pass	500k	37.5M	37.781M
802.11ax HEW80_Nss1,(MCS0)_1TX	-	-	-	-
5210MHz	Pass	Inf	81.96M	77.121M
5775MHz	Pass	500k	77.04M	77.481M

Port X-N dB = Port X 6dB down bandwidth for 5.725-5.85GHz band / 26dB down bandwidth for other band

Port X-OBW = Port X 99% occupied bandwidth;

802.11a_Nss1,(6Mbps)_1TX

EBW

5180MHz

24/09/2019

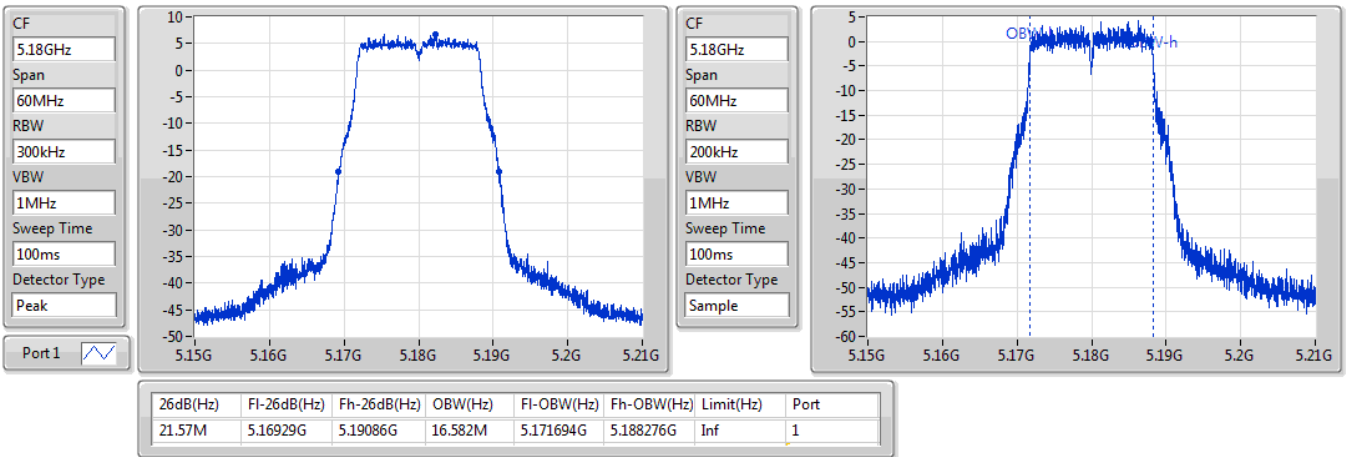

802.11a_Nss1,(6Mbps)_1TX

EBW

5200MHz

24/09/2019

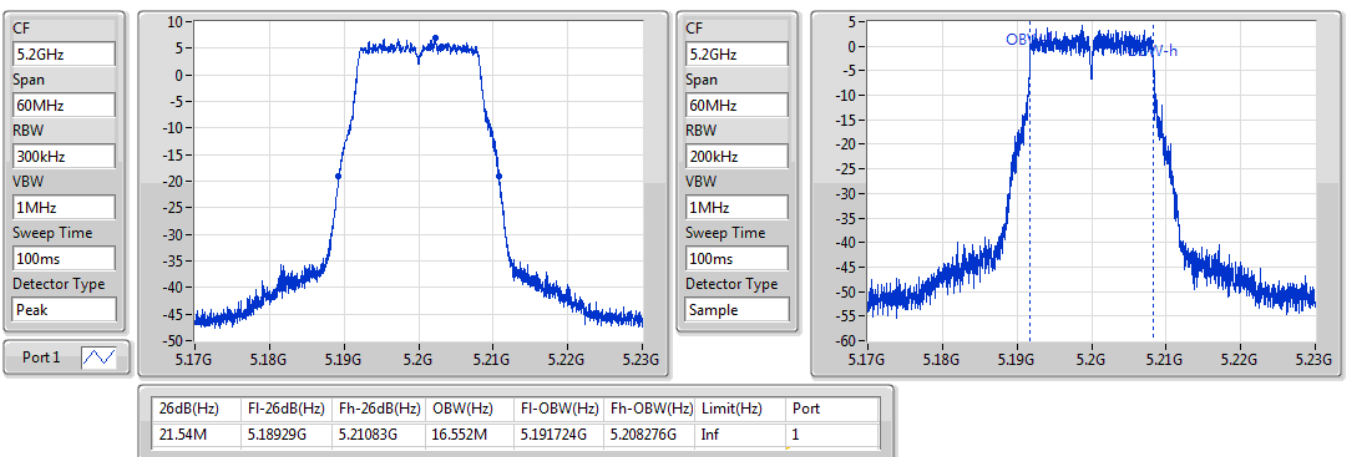

802.11a_Nss1,(6Mbps)_1TX

EBW

5240MHz

24/09/2019

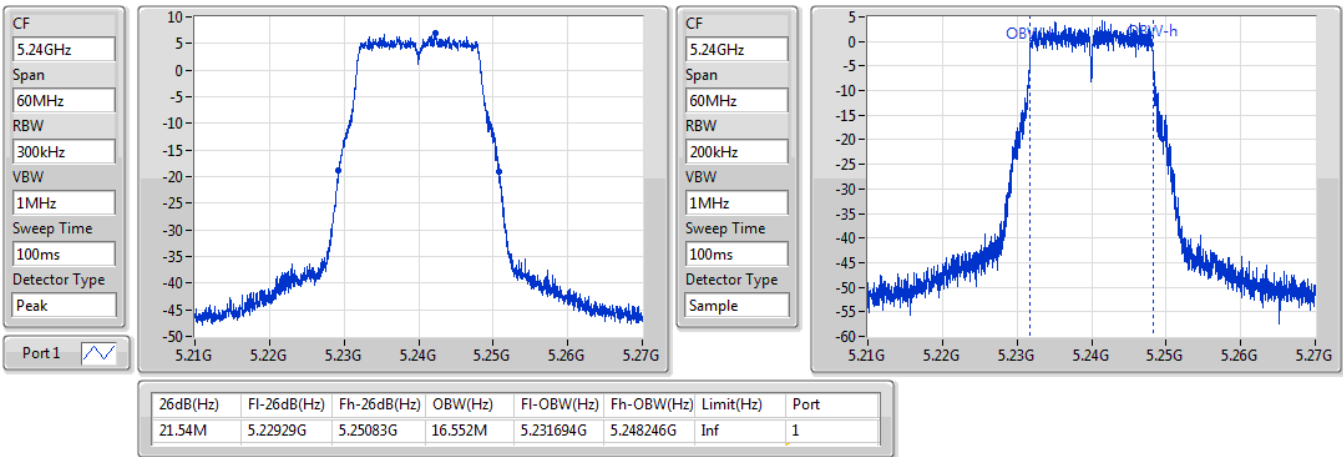

802.11a_Nss1,(6Mbps)_1TX

EBW

5745MHz

24/09/2019

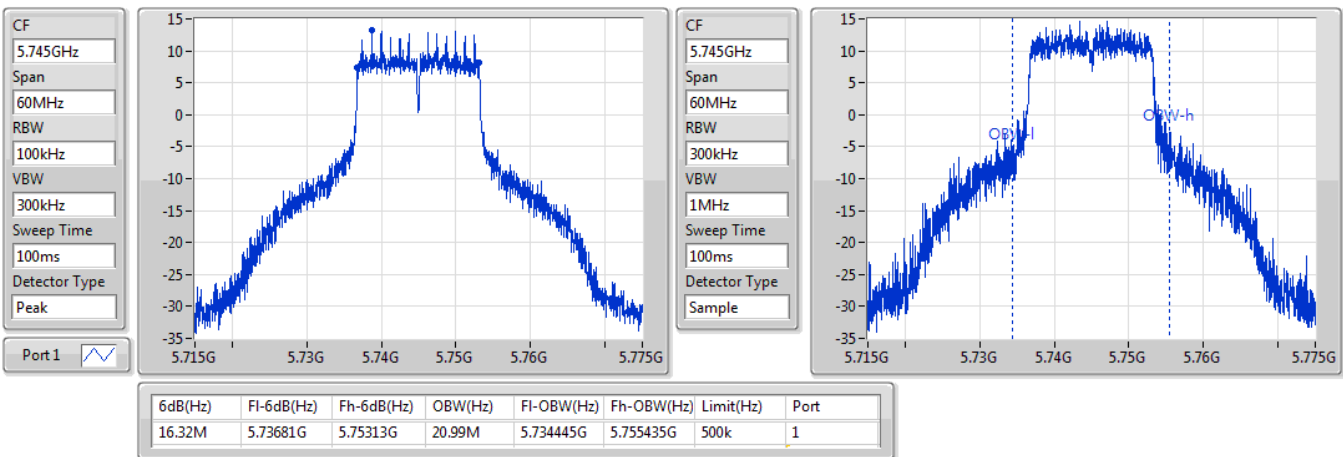

802.11a_Nss1,(6Mbps)_1TX

EBW

5785MHz

24/09/2019

CF: 5.785GHz
 Span: 60MHz
 RBW: 100kHz
 VBW: 300kHz
 Sweep Time: 100ms
 Detector Type: Peak
 Port 1

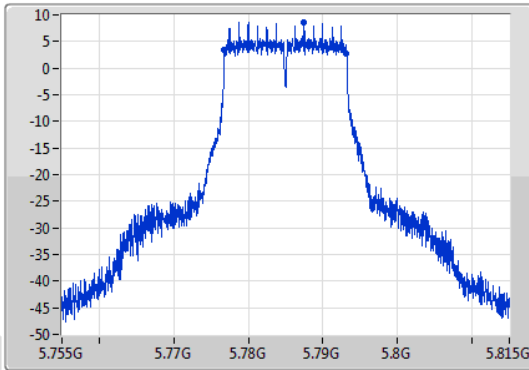

CF: 5.785GHz
 Span: 60MHz
 RBW: 200kHz
 VBW: 1MHz
 Sweep Time: 100ms
 Detector Type: Sample

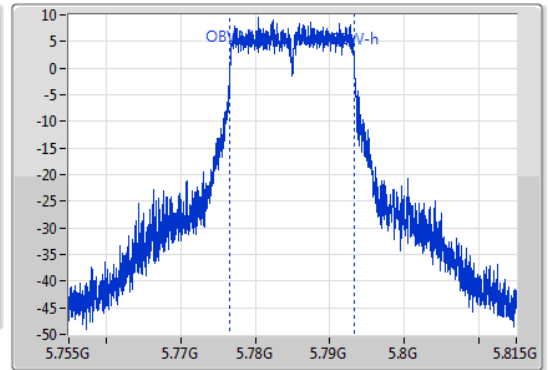

6dB(Hz)	Fl-6dB(Hz)	Fh-6dB(Hz)	OBW(Hz)	Fl-OBW(Hz)	Fh-OBW(Hz)	Limit(Hz)	Port
16.35M	5.77681G	5.79316G	16.642M	5.776634G	5.793276G	500k	1

802.11a_Nss1,(6Mbps)_1TX

EBW

5825MHz

24/09/2019

CF: 5.825GHz
 Span: 60MHz
 RBW: 100kHz
 VBW: 300kHz
 Sweep Time: 100ms
 Detector Type: Peak
 Port 1

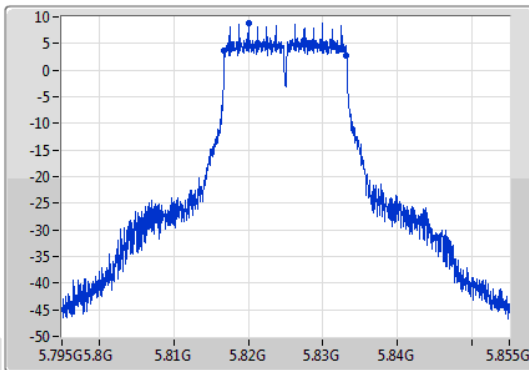

CF: 5.825GHz
 Span: 60MHz
 RBW: 200kHz
 VBW: 1MHz
 Sweep Time: 100ms
 Detector Type: Sample

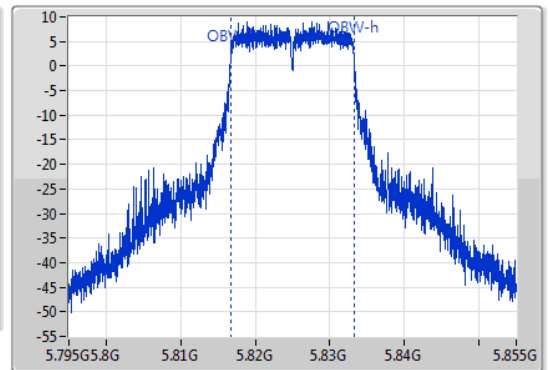

6dB(Hz)	Fl-6dB(Hz)	Fh-6dB(Hz)	OBW(Hz)	Fl-OBW(Hz)	Fh-OBW(Hz)	Limit(Hz)	Port
16.35M	5.81681G	5.83316G	16.612M	5.816664G	5.833276G	500k	1

802.11ac VHT20_Nss1,(MCS0)_1TX

EBW

5180MHz

24/09/2019

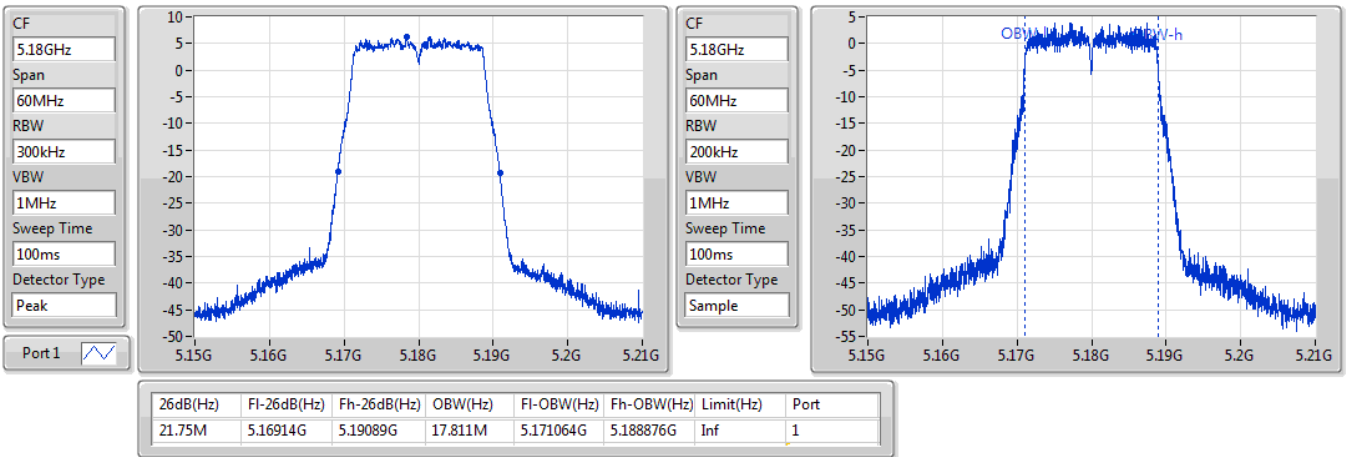

802.11ac VHT20_Nss1,(MCS0)_1TX

EBW

5200MHz

24/09/2019

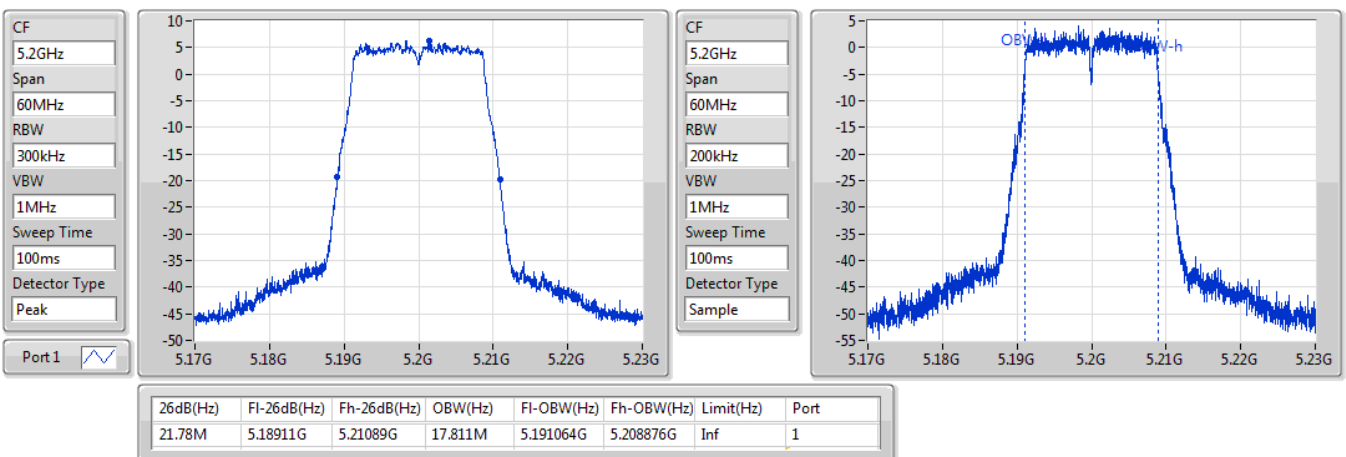

802.11ac VHT20_Nss1,(MCS0)_1TX

EBW

5240MHz

24/09/2019

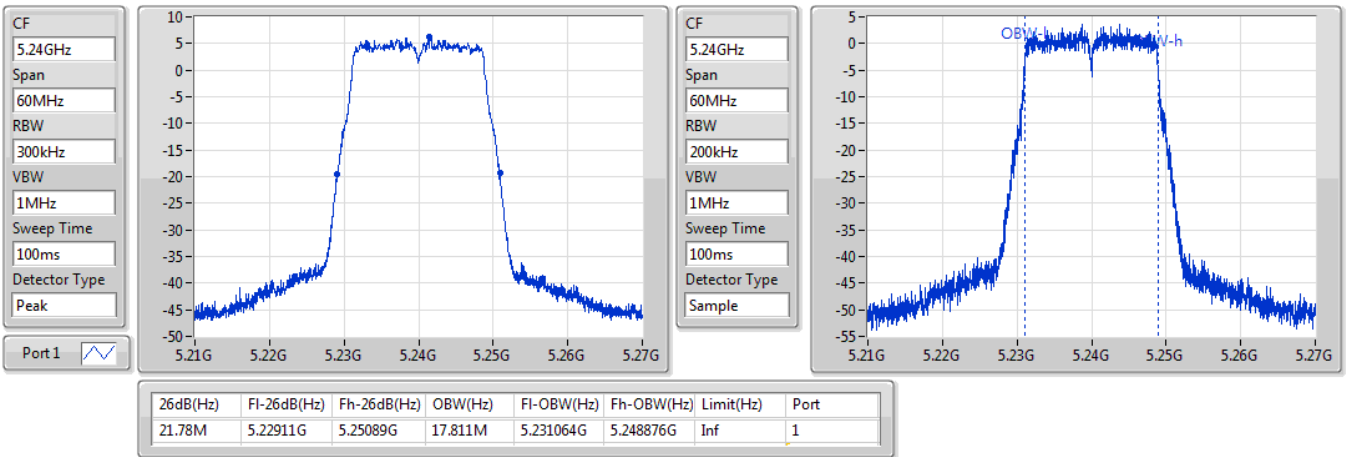

802.11ac VHT20_Nss1,(MCS0)_1TX

EBW

5745MHz

24/09/2019

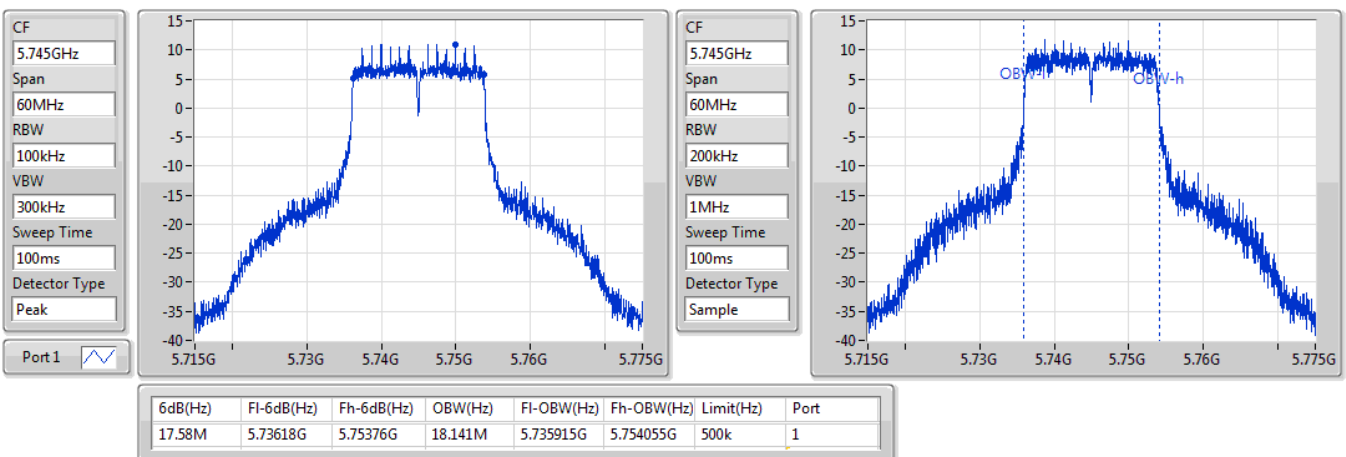

802.11ac VHT20_Nss1,(MCS0)_1TX

EBW

5785MHz

24/09/2019

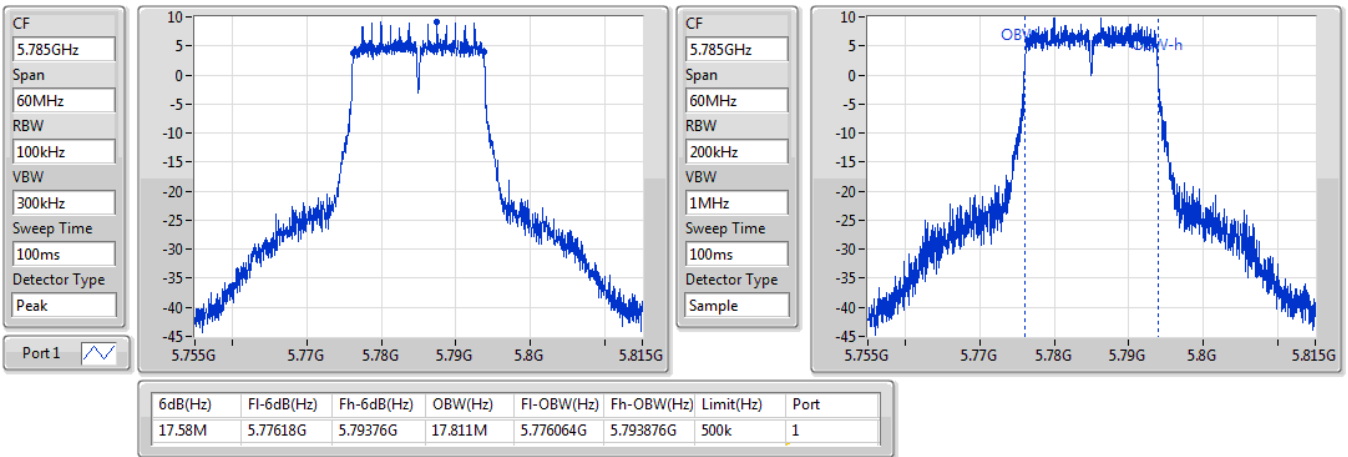

802.11ac VHT20_Nss1,(MCS0)_1TX

EBW

5825MHz

24/09/2019

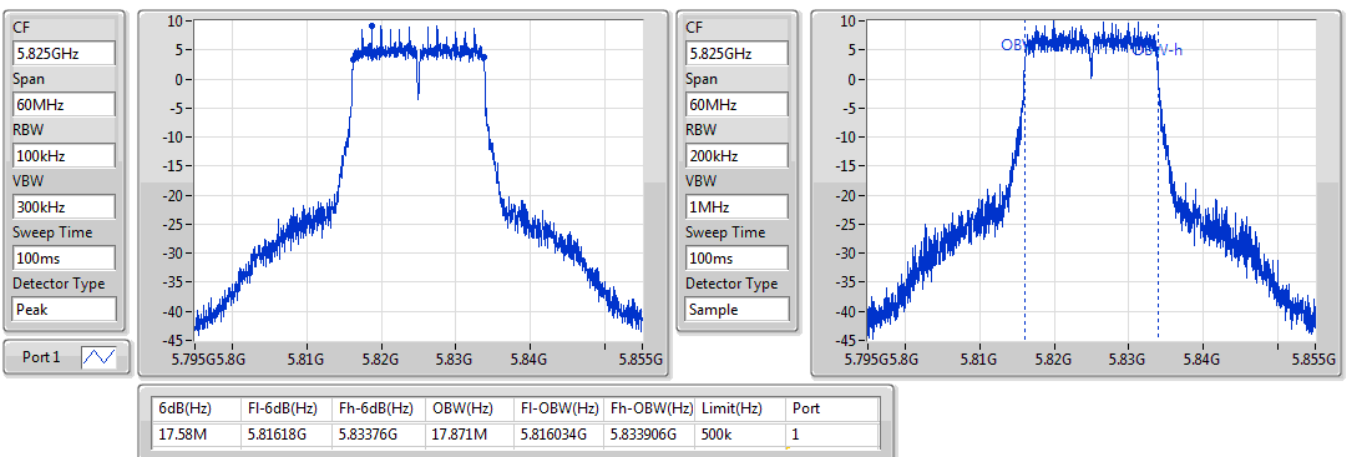

802.11ac VHT40_Nss1,(MCS0)_1TX

EBW

5190MHz

24/09/2019

CF: 5.19GHz
 Span: 120MHz
 RBW: 500kHz
 VBW: 2MHz
 Sweep Time: 100ms
 Detector Type: Peak
 Port 1

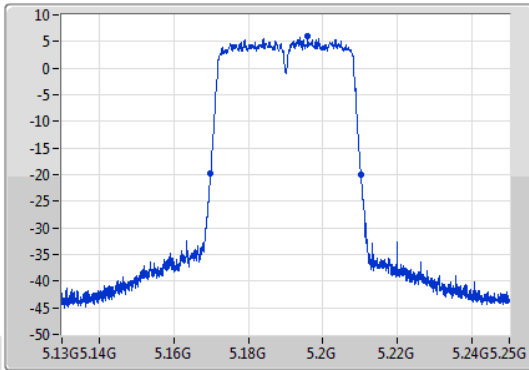

CF: 5.19GHz
 Span: 120MHz
 RBW: 500kHz
 VBW: 2MHz
 Sweep Time: 100ms
 Detector Type: Sample

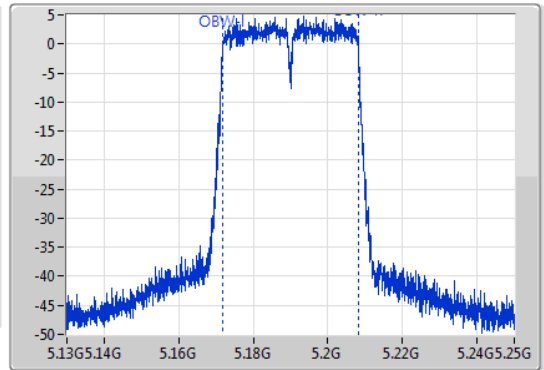

26dB(Hz)	Fl-26dB(Hz)	Fh-26dB(Hz)	OBW(Hz)	Fl-OBW(Hz)	Fh-OBW(Hz)	Limit(Hz)	Port
40.26M	5.1699G	5.21016G	36.282M	5.171829G	5.208111G	Inf	1

802.11ac VHT40_Nss1,(MCS0)_1TX

EBW

5230MHz

24/09/2019

CF: 5.23GHz
 Span: 120MHz
 RBW: 500kHz
 VBW: 2MHz
 Sweep Time: 100ms
 Detector Type: Peak
 Port 1

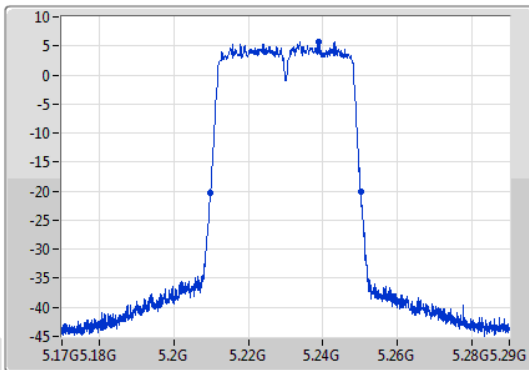

CF: 5.23GHz
 Span: 120MHz
 RBW: 500kHz
 VBW: 2MHz
 Sweep Time: 100ms
 Detector Type: Sample

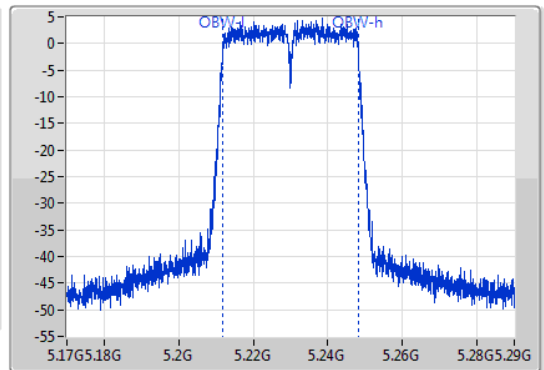

26dB(Hz)	Fl-26dB(Hz)	Fh-26dB(Hz)	OBW(Hz)	Fl-OBW(Hz)	Fh-OBW(Hz)	Limit(Hz)	Port
40.32M	5.20984G	5.25016G	36.342M	5.211769G	5.248111G	Inf	1

802.11ac VHT40_Nss1,(MCS0)_1TX

EBW

5755MHz

24/09/2019

CF
5.755GHz
Span
120MHz
RBW
100kHz
VBW
300kHz
Sweep Time
100ms
Detector Type
Peak
Port 1

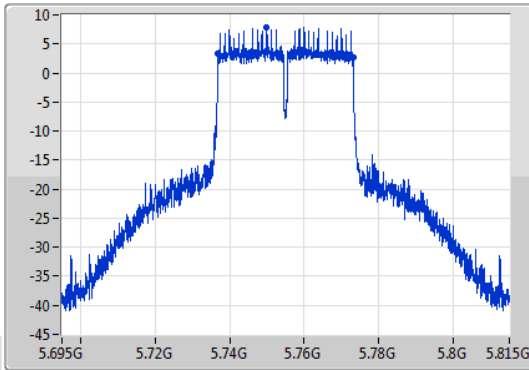

CF
5.755GHz
Span
120MHz
RBW
500kHz
VBW
2MHz
Sweep Time
100ms
Detector Type
Sample

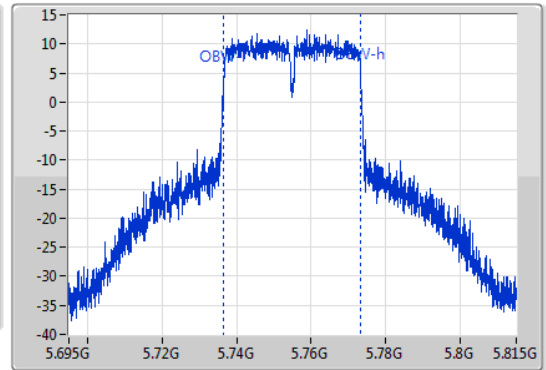

6dB(Hz)	Fl-6dB(Hz)	Fh-6dB(Hz)	OBW(Hz)	Fl-OBW(Hz)	Fh-OBW(Hz)	Limit(Hz)	Port
36.3M	5.73682G	5.77312G	36.642M	5.736589G	5.773231G	500k	1

802.11ac VHT40_Nss1,(MCS0)_1TX

EBW

5795MHz

24/09/2019

CF
5.795GHz
Span
120MHz
RBW
100kHz
VBW
300kHz
Sweep Time
100ms
Detector Type
Peak
Port 1

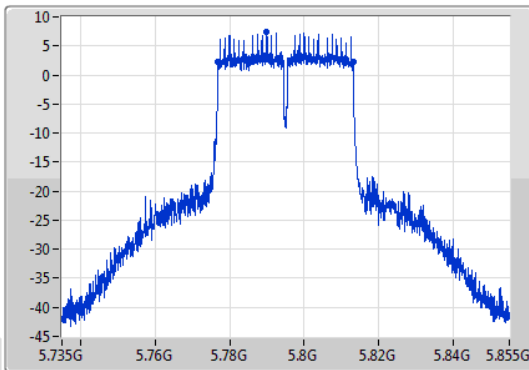

CF
5.795GHz
Span
120MHz
RBW
500kHz
VBW
2MHz
Sweep Time
100ms
Detector Type
Sample

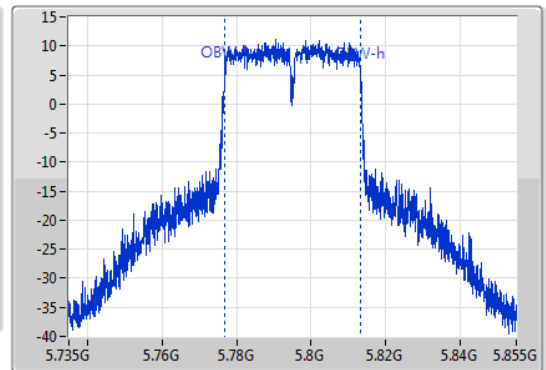

6dB(Hz)	Fl-6dB(Hz)	Fh-6dB(Hz)	OBW(Hz)	Fl-OBW(Hz)	Fh-OBW(Hz)	Limit(Hz)	Port
36.3M	5.77682G	5.81312G	36.522M	5.776709G	5.813231G	500k	1

802.11ac VHT80_Nss1,(MCS0)_1TX

EBW

5210MHz

24/09/2019

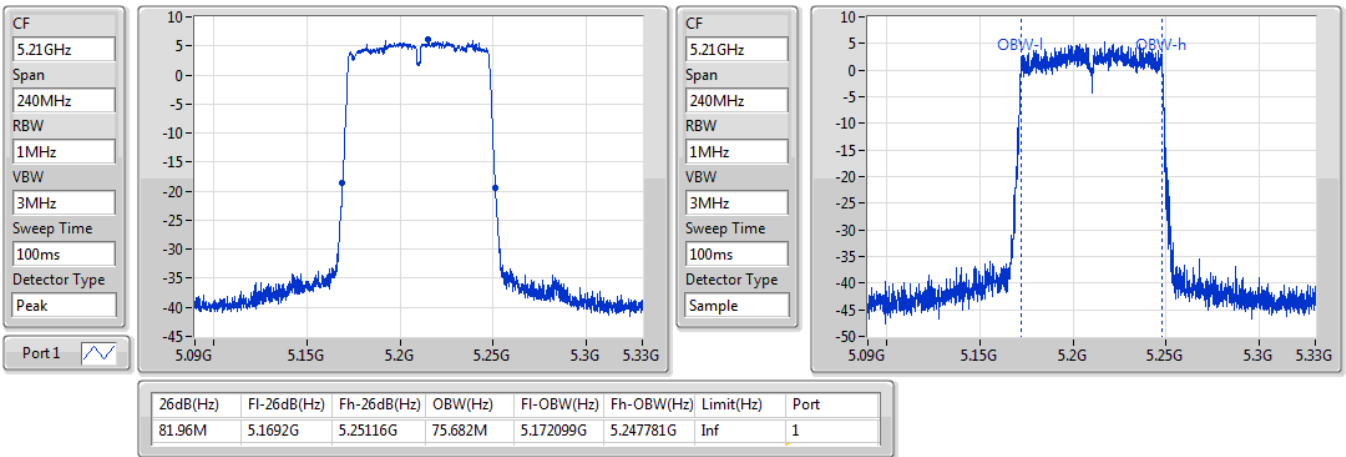

802.11ac VHT80_Nss1,(MCS0)_1TX

EBW

5775MHz

24/09/2019

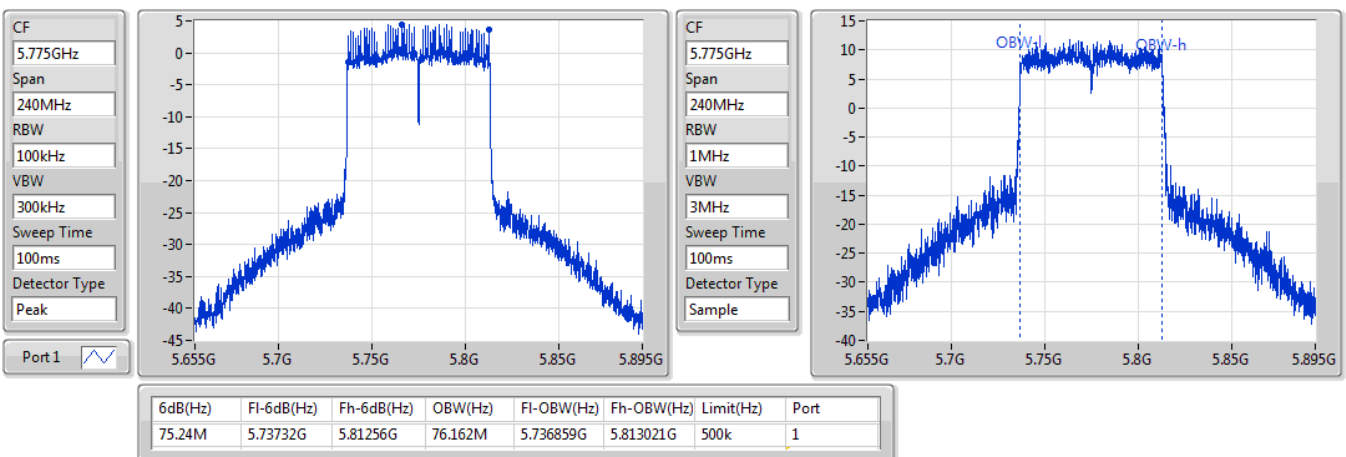

802.11ax HEW20_Nss1,(MCS0)_1TX

EBW

5180MHz

24/09/2019

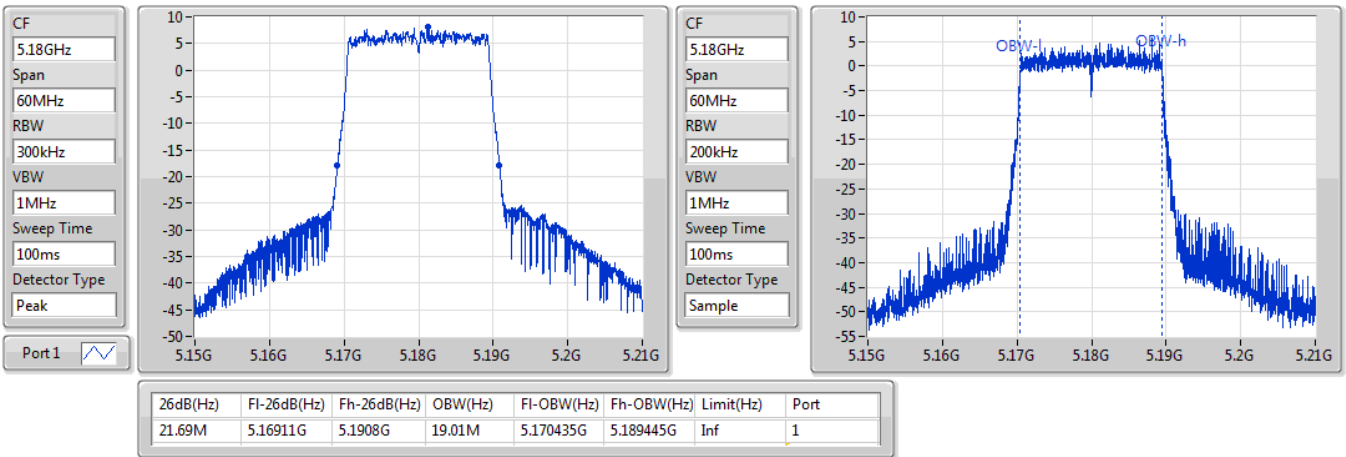

802.11ax HEW20_Nss1,(MCS0)_1TX

EBW

5200MHz

24/09/2019

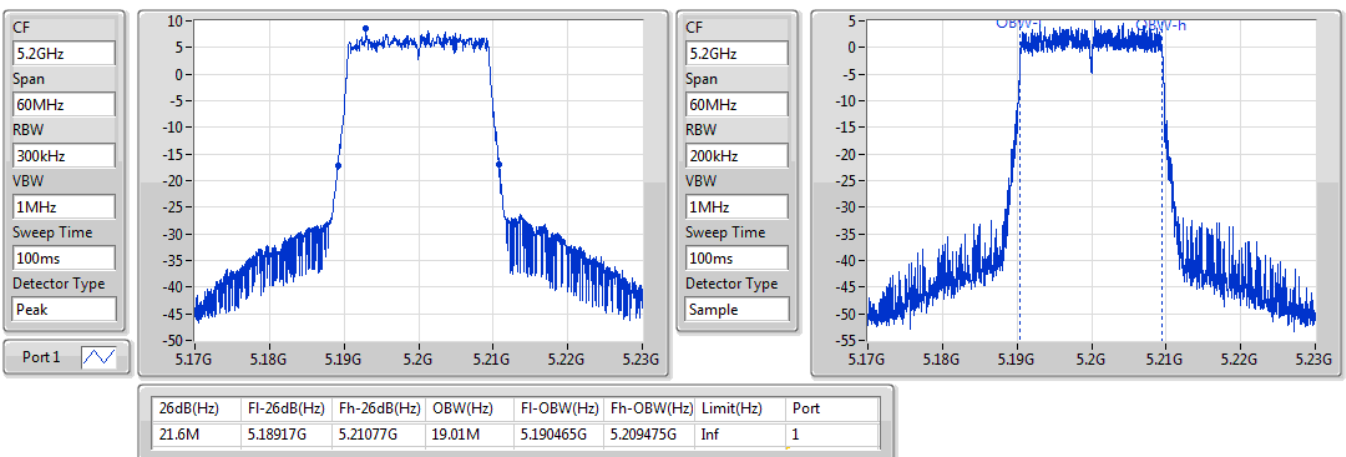

802.11ax HEW20_Nss1,(MCS0)_1TX

EBW

5240MHz

24/09/2019

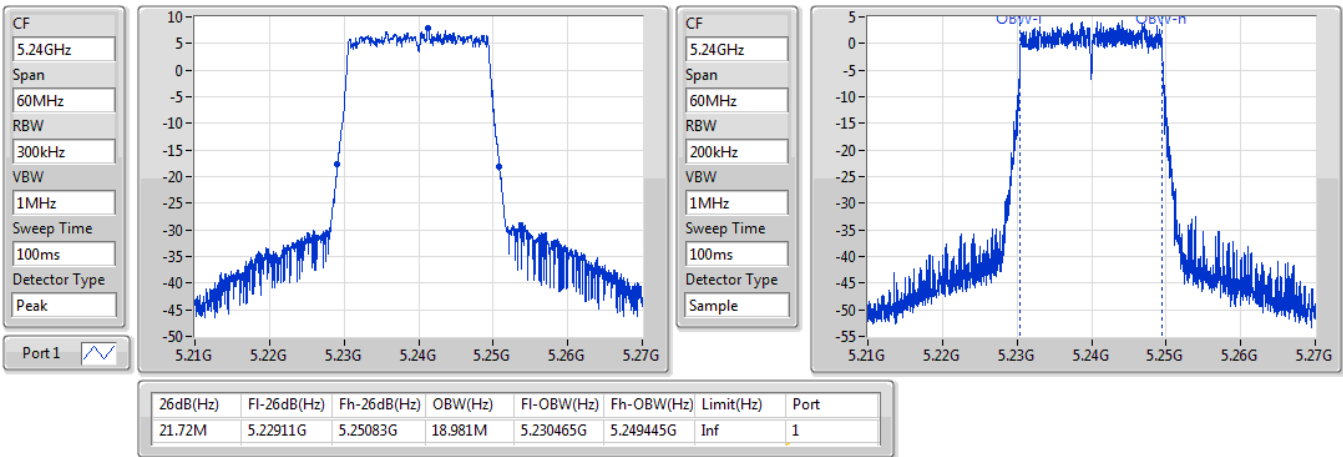

802.11ax HEW20_Nss1,(MCS0)_1TX

EBW

5745MHz

24/09/2019

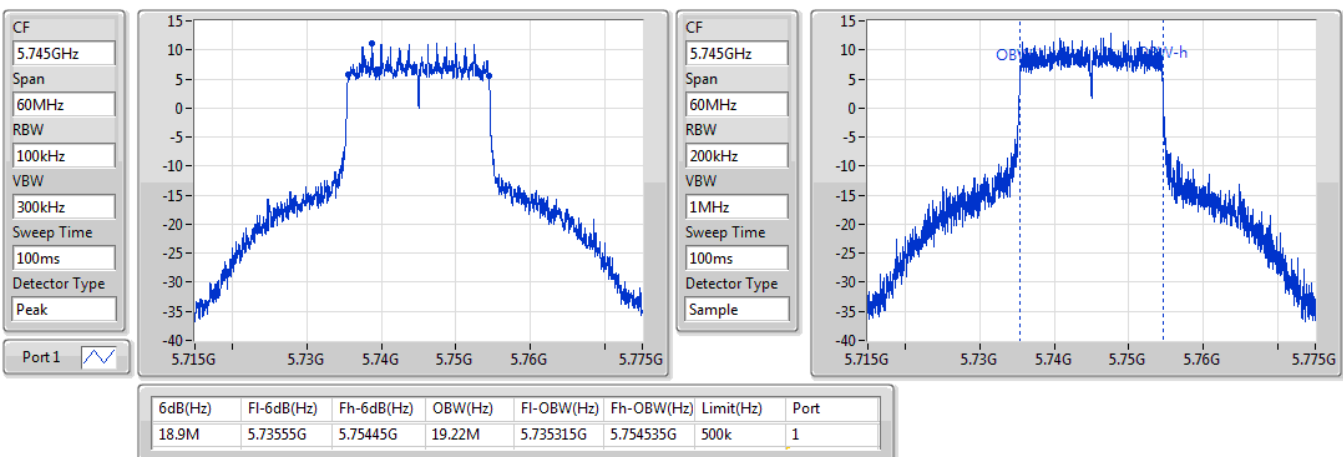

802.11ax HEW20_Nss1,(MCS0)_1TX

EBW

5785MHz

24/09/2019

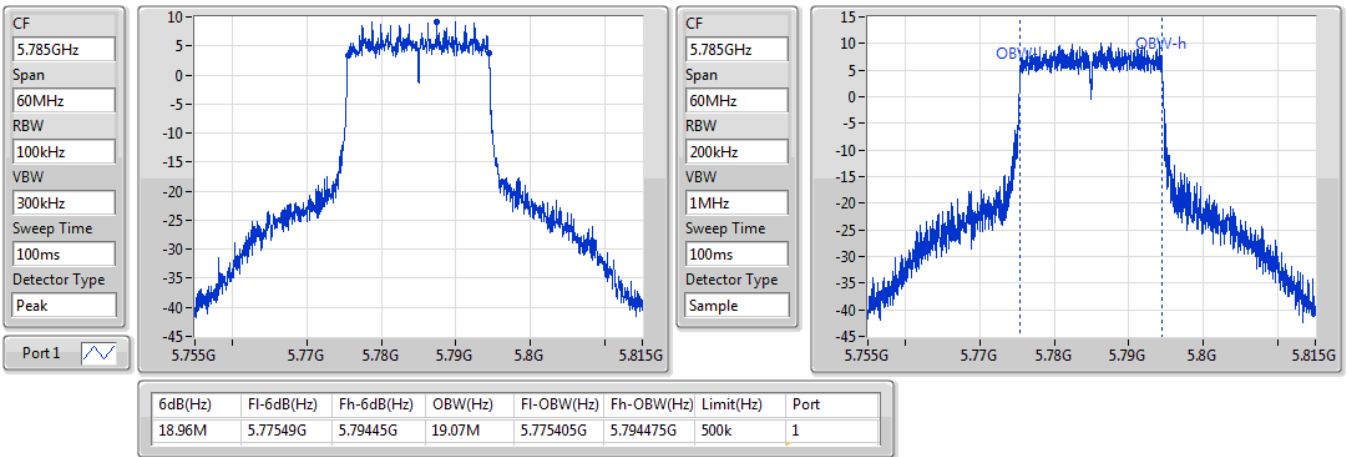

802.11ax HEW20_Nss1,(MCS0)_1TX

EBW

5825MHz

24/09/2019

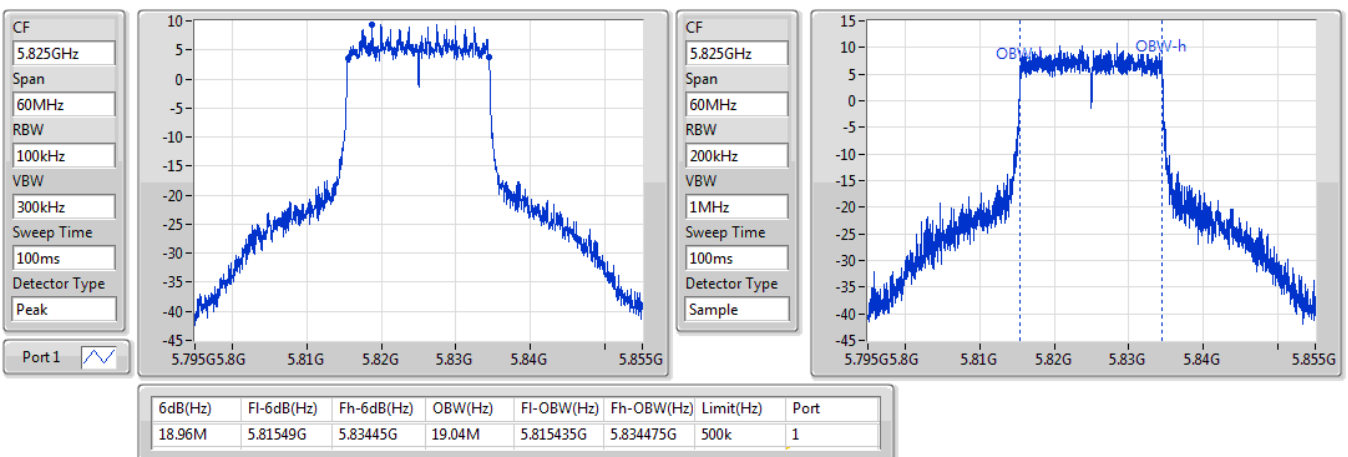

802.11ax HEW40_Nss1,(MCS0)_1TX

EBW

5190MHz

24/09/2019

CF: 5.19GHz
 Span: 120MHz
 RBW: 500kHz
 VBW: 2MHz
 Sweep Time: 100ms
 Detector Type: Peak
 Port 1

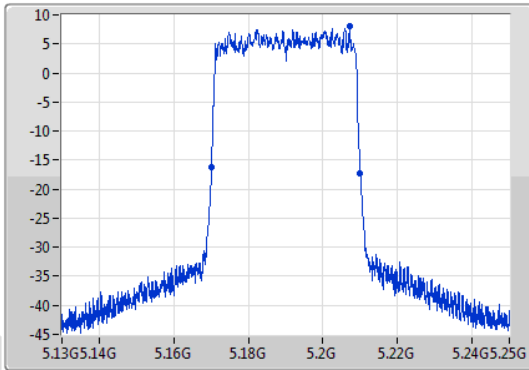

CF: 5.19GHz
 Span: 120MHz
 RBW: 500kHz
 VBW: 2MHz
 Sweep Time: 100ms
 Detector Type: Sample

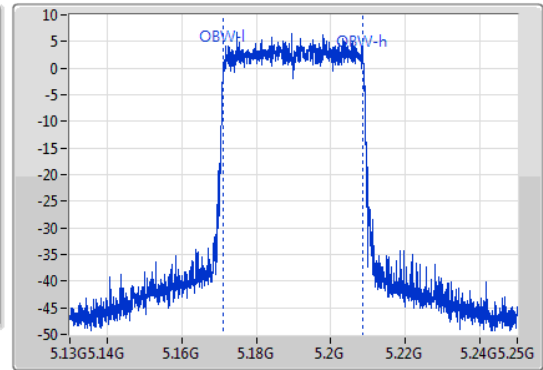

26dB(Hz)	Fl-26dB(Hz)	Fh-26dB(Hz)	OBW(Hz)	Fl-OBW(Hz)	Fh-OBW(Hz)	Limit(Hz)	Port
39.96M	5.17008G	5.21004G	37.481M	5.171229G	5.208711G	Inf	1

802.11ax HEW40_Nss1,(MCS0)_1TX

EBW

5230MHz

24/09/2019

CF: 5.23GHz
 Span: 120MHz
 RBW: 500kHz
 VBW: 2MHz
 Sweep Time: 100ms
 Detector Type: Peak
 Port 1

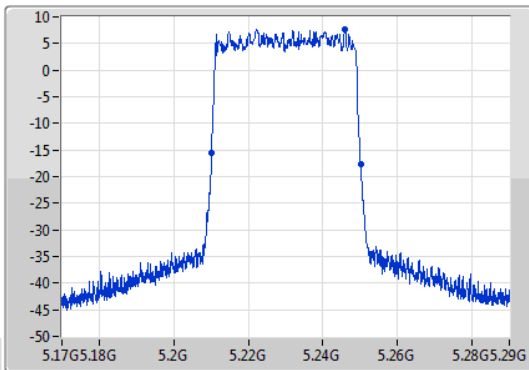

CF: 5.23GHz
 Span: 120MHz
 RBW: 500kHz
 VBW: 2MHz
 Sweep Time: 100ms
 Detector Type: Sample

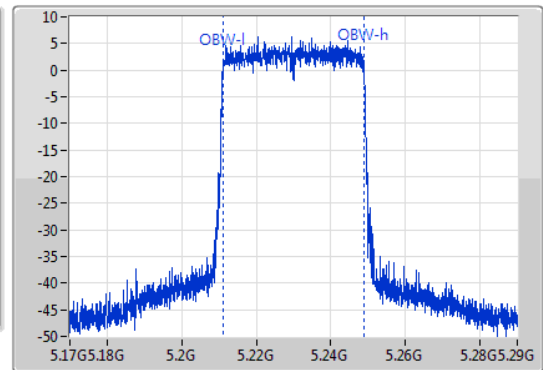

26dB(Hz)	Fl-26dB(Hz)	Fh-26dB(Hz)	OBW(Hz)	Fl-OBW(Hz)	Fh-OBW(Hz)	Limit(Hz)	Port
40.08M	5.21002G	5.2501G	37.601M	5.211169G	5.248771G	Inf	1

802.11ax HEW40_Nss1,(MCS0)_1TX

EBW

5755MHz

24/09/2019

CF
5.755GHz
Span
120MHz
RBW
100kHz
VBW
300kHz
Sweep Time
100ms
Detector Type
Peak
Port 1

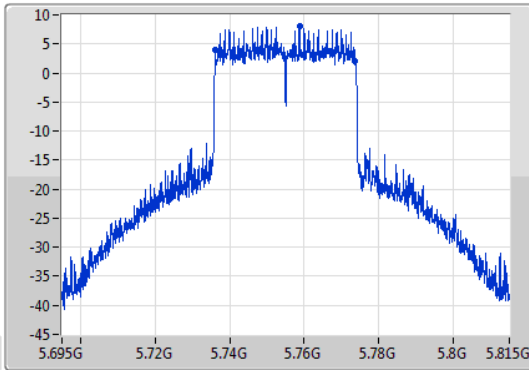

CF
5.755GHz
Span
120MHz
RBW
500kHz
VBW
2MHz
Sweep Time
100ms
Detector Type
Sample

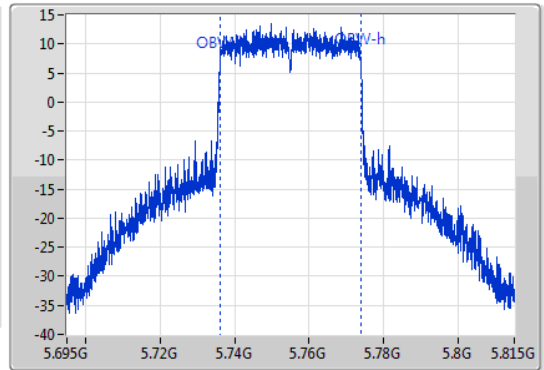

6dB(Hz)	Fl-6dB(Hz)	Fh-6dB(Hz)	OBW(Hz)	Fl-OBW(Hz)	Fh-OBW(Hz)	Limit(Hz)	Port
37.5M	5.73616G	5.77366G	37.841M	5.73599G	5.773831G	500k	1

802.11ax HEW40_Nss1,(MCS0)_1TX

EBW

5795MHz

24/09/2019

CF
5.795GHz
Span
120MHz
RBW
100kHz
VBW
300kHz
Sweep Time
100ms
Detector Type
Peak
Port 1

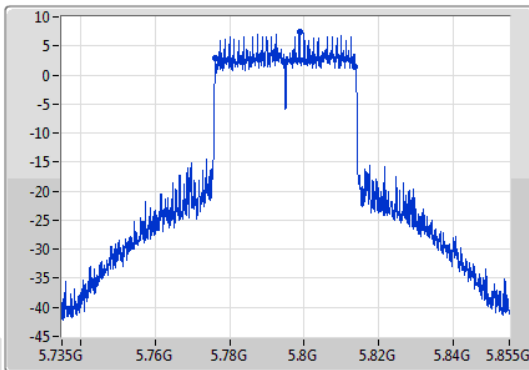

CF
5.795GHz
Span
120MHz
RBW
500kHz
VBW
2MHz
Sweep Time
100ms
Detector Type
Sample

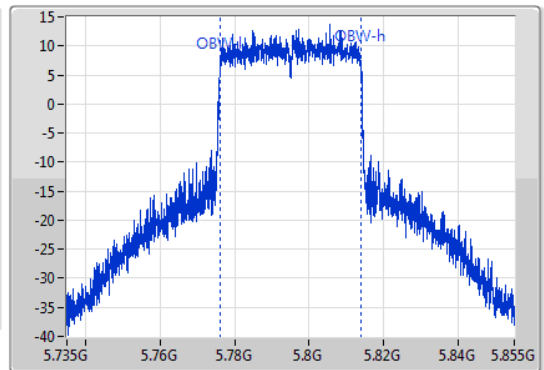

6dB(Hz)	Fl-6dB(Hz)	Fh-6dB(Hz)	OBW(Hz)	Fl-OBW(Hz)	Fh-OBW(Hz)	Limit(Hz)	Port
37.5M	5.77616G	5.81366G	37.781M	5.776049G	5.813831G	500k	1

802.11ax HEW80_Nss1,(MCS0)_1TX

EBW

5210MHz

24/09/2019

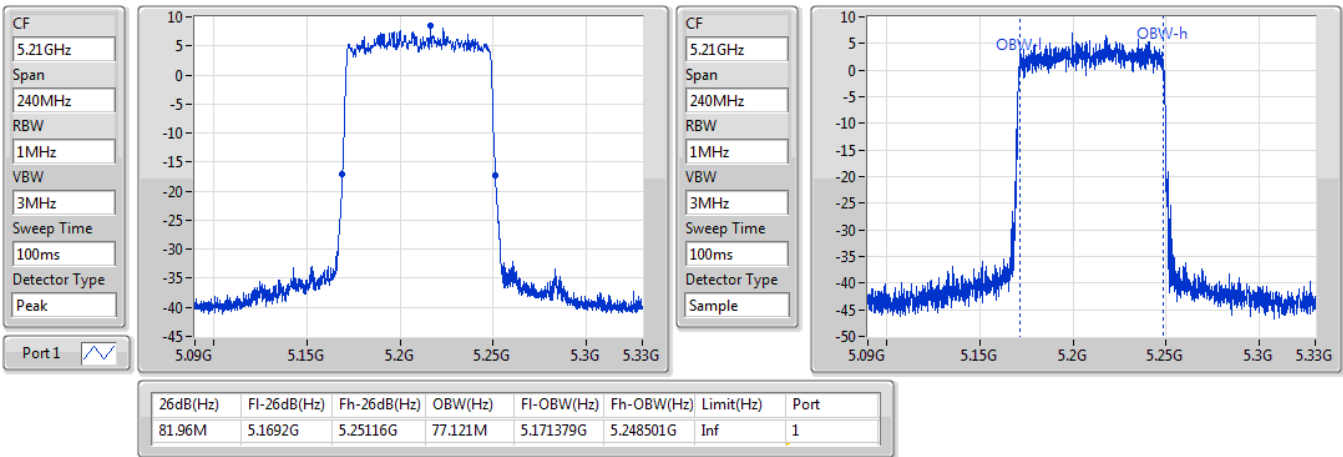

802.11ax HEW80_Nss1,(MCS0)_1TX

EBW

5775MHz

24/09/2019

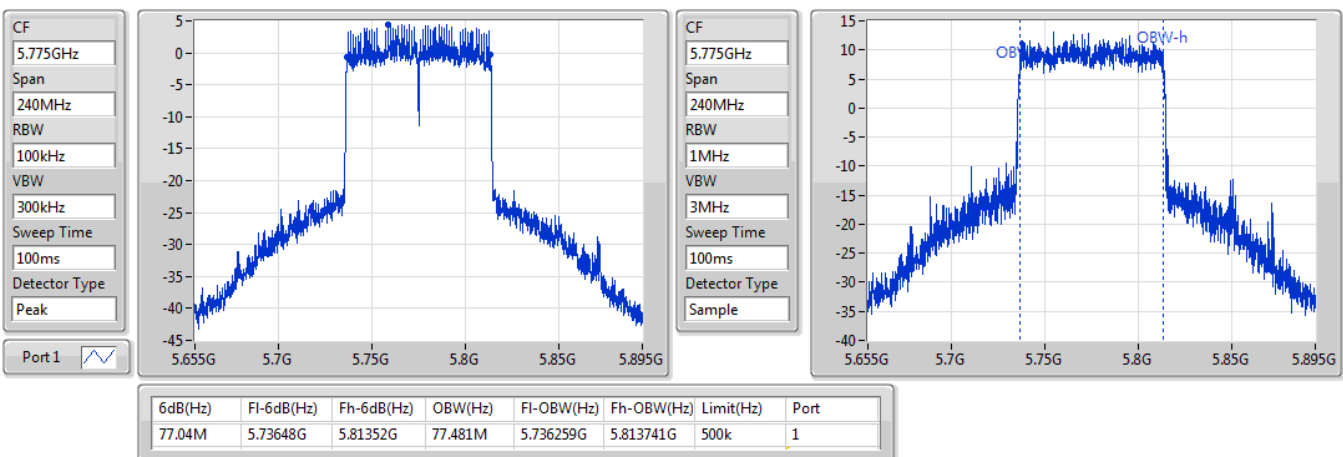



Summary

Mode	Max-N dB (Hz)	Max-OBW (Hz)	ITU-Code	Min-N dB (Hz)	Min-OBW (Hz)
5.15-5.25GHz	-	-	-	-	-
802.11a_Nss1,(6Mbps)_2TX	21.57M	16.642M	16M6D1D	21.24M	16.582M
802.11ac VHT20_Nss2,(MCS0)_2TX	21.99M	17.811M	17M8D1D	21.63M	17.751M
802.11ac VHT40_Nss2,(MCS0)_2TX	40.14M	36.282M	36M3D1D	39.9M	36.222M
802.11ac VHT80_Nss2,(MCS0)_2TX	81.72M	75.802M	75M8D1D	81.6M	75.802M
802.11ax HEW20_Nss2,(MCS0)_2TX	21.87M	19.01M	19M0D1D	21.33M	18.951M
802.11ax HEW40_Nss2,(MCS0)_2TX	40.14M	37.601M	37M6D1D	39.84M	37.421M
802.11ax HEW80_Nss2,(MCS0)_2TX	81.6M	77.001M	77M0D1D	81.24M	77.001M
5.725-5.85GHz	-	-	-	-	-
802.11a_Nss1,(6Mbps)_2TX	16.35M	17.841M	17M8D1D	16.32M	16.612M
802.11ac VHT20_Nss2,(MCS0)_2TX	17.58M	18.261M	18M3D1D	17.58M	17.751M
802.11ac VHT40_Nss2,(MCS0)_2TX	36.3M	36.342M	36M3D1D	36.3M	36.282M
802.11ac VHT80_Nss2,(MCS0)_2TX	75.96M	75.922M	75M9D1D	75.96M	75.802M
802.11ax HEW20_Nss2,(MCS0)_2TX	18.99M	19.22M	19M2D1D	18.81M	18.951M
802.11ax HEW40_Nss2,(MCS0)_2TX	37.62M	37.721M	37M7D1D	37.5M	37.541M
802.11ax HEW80_Nss2,(MCS0)_2TX	76.56M	77.121M	77M1D1D	76.08M	77.121M

Max-N dB = Maximum 6dB down bandwidth for 5.725-5.85GHz band / Maximum 26dB down bandwidth for other band;

Max-OBW = Maximum 99% occupied bandwidth;

Min-N dB = Minimum 6dB down bandwidth for 5.725-5.85GHz band / Maximum 26dB down bandwidth for other band;

Min-OBW = Minimum 99% occupied bandwidth;



Result

Mode	Result	Limit (Hz)	Port 1-N dB (Hz)	Port 1-OBW (Hz)	Port 2-N dB (Hz)	Port 2-OBW (Hz)
802.11a_Nss1,(6Mbps)_2TX	-	-	-	-	-	-
5180MHz	Pass	Inf	21.48M	16.612M	21.36M	16.582M
5200MHz	Pass	Inf	21.54M	16.642M	21.24M	16.642M
5240MHz	Pass	Inf	21.57M	16.612M	21.33M	16.612M
5745MHz	Pass	500k	16.32M	17.841M	16.32M	16.852M
5785MHz	Pass	500k	16.32M	16.702M	16.32M	16.672M
5825MHz	Pass	500k	16.35M	16.612M	16.35M	16.642M
802.11ac VHT20_Nss2,(MCS0)_2TX	-	-	-	-	-	-
5180MHz	Pass	Inf	21.96M	17.811M	21.63M	17.781M
5200MHz	Pass	Inf	21.9M	17.811M	21.69M	17.751M
5240MHz	Pass	Inf	21.99M	17.811M	21.78M	17.751M
5745MHz	Pass	500k	17.58M	18.261M	17.58M	17.871M
5785MHz	Pass	500k	17.58M	17.871M	17.58M	17.811M
5825MHz	Pass	500k	17.58M	17.841M	17.58M	17.751M
802.11ac VHT40_Nss2,(MCS0)_2TX	-	-	-	-	-	-
5190MHz	Pass	Inf	40.02M	36.222M	39.96M	36.282M
5230MHz	Pass	Inf	39.9M	36.222M	40.14M	36.222M
5755MHz	Pass	500k	36.3M	36.342M	36.3M	36.282M
5795MHz	Pass	500k	36.3M	36.342M	36.3M	36.282M
802.11ac VHT80_Nss2,(MCS0)_2TX	-	-	-	-	-	-
5210MHz	Pass	Inf	81.6M	75.802M	81.72M	75.802M
5775MHz	Pass	500k	75.96M	75.922M	75.96M	75.802M
802.11ax HEW20_Nss2,(MCS0)_2TX	-	-	-	-	-	-
5180MHz	Pass	Inf	21.69M	19.01M	21.54M	18.951M
5200MHz	Pass	Inf	21.87M	18.981M	21.51M	19.01M
5240MHz	Pass	Inf	21.84M	18.981M	21.33M	18.981M
5745MHz	Pass	500k	18.96M	19.22M	18.81M	19.1M
5785MHz	Pass	500k	18.96M	19.07M	18.87M	19.01M
5825MHz	Pass	500k	18.99M	19.01M	18.87M	18.951M
802.11ax HEW40_Nss2,(MCS0)_2TX	-	-	-	-	-	-
5190MHz	Pass	Inf	40.14M	37.601M	39.9M	37.481M
5230MHz	Pass	Inf	40.14M	37.601M	39.84M	37.421M
5755MHz	Pass	500k	37.56M	37.721M	37.62M	37.541M
5795MHz	Pass	500k	37.5M	37.601M	37.62M	37.541M
802.11ax HEW80_Nss2,(MCS0)_2TX	-	-	-	-	-	-
5210MHz	Pass	Inf	81.24M	77.001M	81.6M	77.001M
5775MHz	Pass	500k	76.56M	77.121M	76.08M	77.121M

Port X-N dB = Port X 6dB down bandwidth for 5.725-5.85GHz band / 26dB down bandwidth for other band

Port X-OBW = Port X 99% occupied bandwidth;

802.11a_Nss1,(6Mbps)_2TX

EBW

5180MHz

20/09/2019

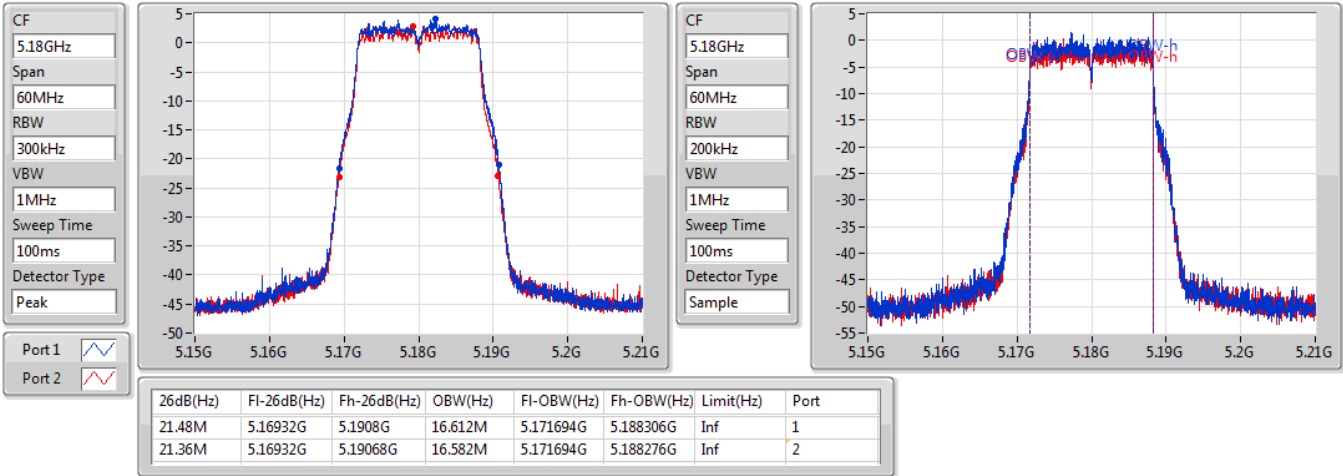

802.11a_Nss1,(6Mbps)_2TX

EBW

5200MHz

20/09/2019

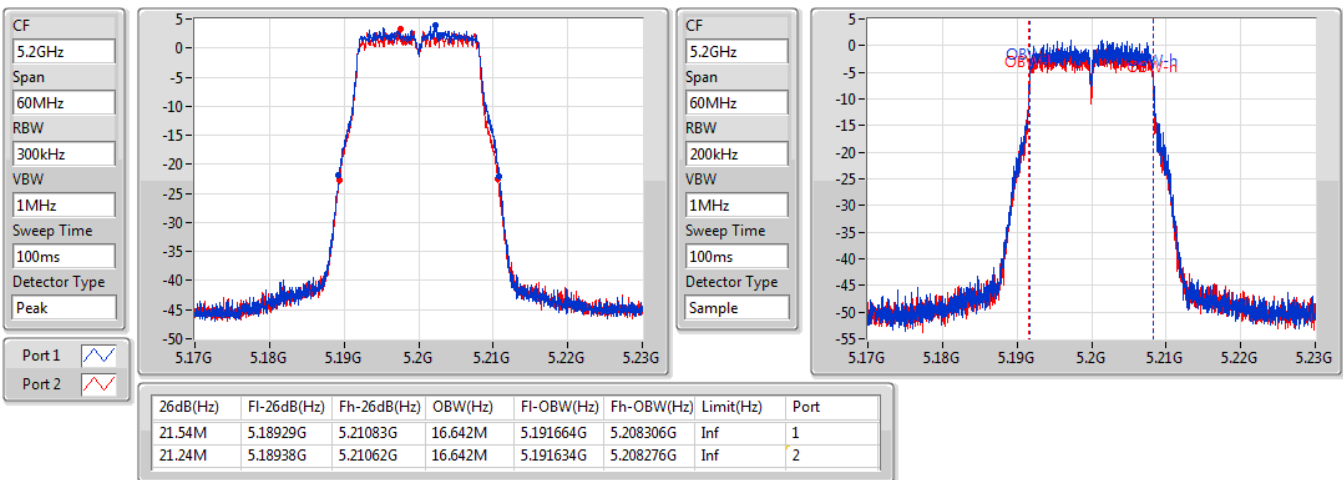

802.11a_Nss1,(6Mbps)_2TX

EBW

5240MHz

20/09/2019

CF
5.24GHz
Span
60MHz
RBW
300kHz
VBW
1MHz
Sweep Time
100ms
Detector Type
Peak

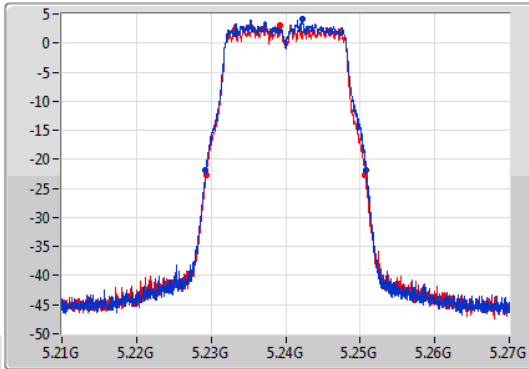

CF
5.24GHz
Span
60MHz
RBW
200kHz
VBW
1MHz
Sweep Time
100ms
Detector Type
Sample

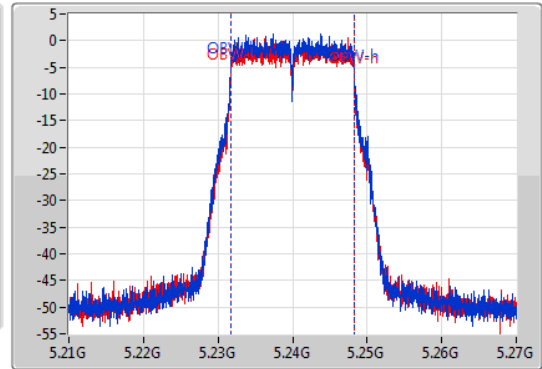

6dB(Hz)	Fl-26dB(Hz)	Fh-26dB(Hz)	OBW(Hz)	Fl-OBW(Hz)	Fh-OBW(Hz)	Limit(Hz)	Port
21.57M	5.22926G	5.25083G	16.612M	5.231664G	5.248276G	Inf	1
21.33M	5.22935G	5.25068G	16.612M	5.231664G	5.248276G	Inf	2

802.11a_Nss1,(6Mbps)_2TX

EBW

5745MHz

20/09/2019

CF
5.745GHz
Span
60MHz
RBW
100kHz
VBW
300kHz
Sweep Time
100ms
Detector Type
Peak

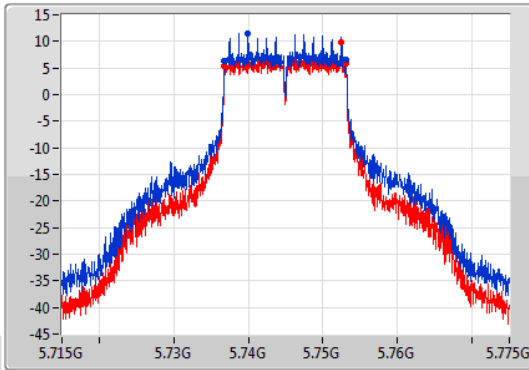

CF
5.745GHz
Span
60MHz
RBW
200kHz
VBW
1MHz
Sweep Time
100ms
Detector Type
Sample

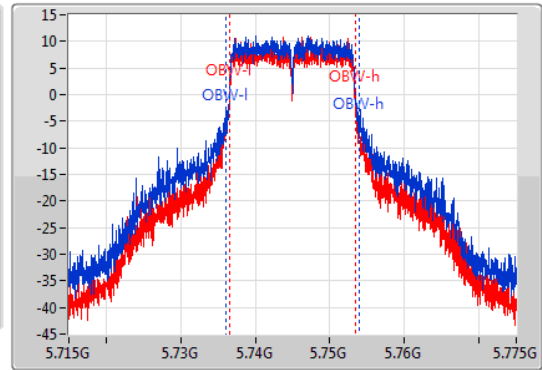

6dB(Hz)	Fl-6dB(Hz)	Fh-6dB(Hz)	OBW(Hz)	Fl-OBW(Hz)	Fh-OBW(Hz)	Limit(Hz)	Port
16.32M	5.73681G	5.75313G	17.841M	5.736064G	5.753906G	500k	1
16.32M	5.73681G	5.75313G	16.852M	5.736514G	5.753366G	500k	2

802.11a_Nss1,(6Mbps)_2TX

EBW

5785MHz

20/09/2019

CF
5.785GHz
Span
60MHz
RBW
100kHz
VBW
300kHz
Sweep Time
100ms
Detector Type
Peak

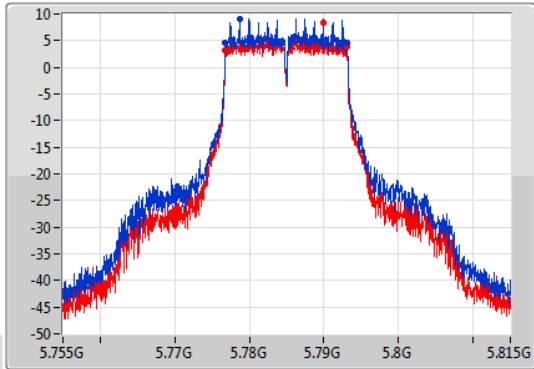

CF
5.785GHz
Span
60MHz
RBW
200kHz
VBW
1MHz
Sweep Time
100ms
Detector Type
Sample

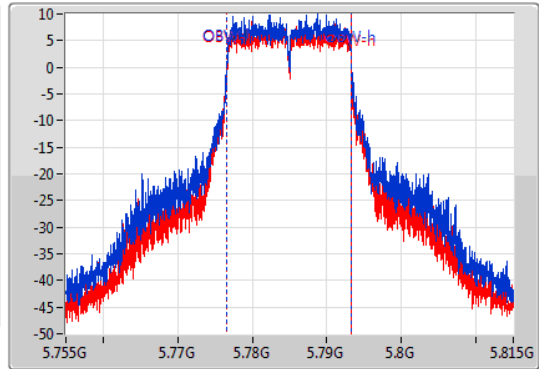

6dB(Hz)	Fl-6dB(Hz)	Fh-6dB(Hz)	OBW(Hz)	Fl-OBW(Hz)	Fh-OBW(Hz)	Limit(Hz)	Port
16.32M	5.77681G	5.79313G	16.702M	5.776604G	5.793306G	500k	1
16.32M	5.77681G	5.79313G	16.672M	5.776604G	5.793276G	500k	2

802.11a_Nss1,(6Mbps)_2TX

EBW

5825MHz

20/09/2019

CF
5.825GHz
Span
60MHz
RBW
100kHz
VBW
300kHz
Sweep Time
100ms
Detector Type
Peak

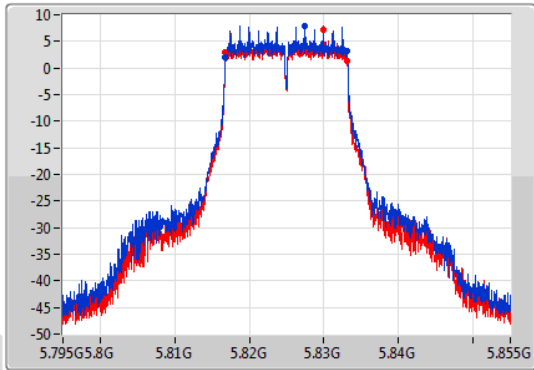

CF
5.825GHz
Span
60MHz
RBW
200kHz
VBW
1MHz
Sweep Time
100ms
Detector Type
Sample

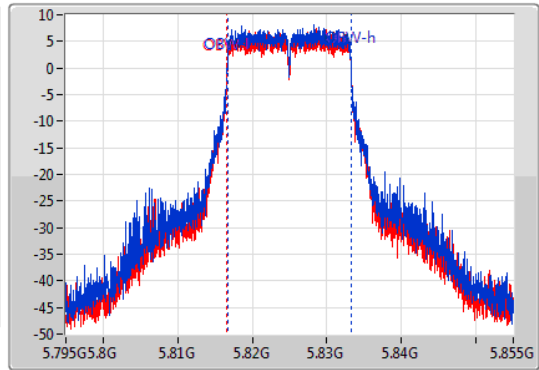

6dB(Hz)	Fl-6dB(Hz)	Fh-6dB(Hz)	OBW(Hz)	Fl-OBW(Hz)	Fh-OBW(Hz)	Limit(Hz)	Port
16.35M	5.81678G	5.83313G	16.612M	5.816664G	5.833276G	500k	1
16.35M	5.81681G	5.83316G	16.642M	5.816604G	5.833246G	500k	2

802.11ac VHT20_Nss2,(MCS0)_2TX

EBW

5180MHz

20/09/2019

CF
5.18GHz
Span
60MHz
RBW
300kHz
VBW
1MHz
Sweep Time
100ms
Detector Type
Peak

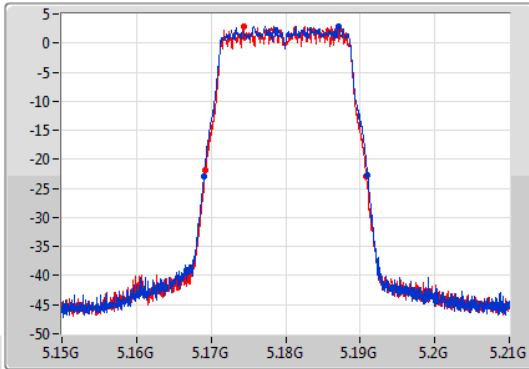

CF
5.18GHz
Span
60MHz
RBW
200kHz
VBW
1MHz
Sweep Time
100ms
Detector Type
Sample

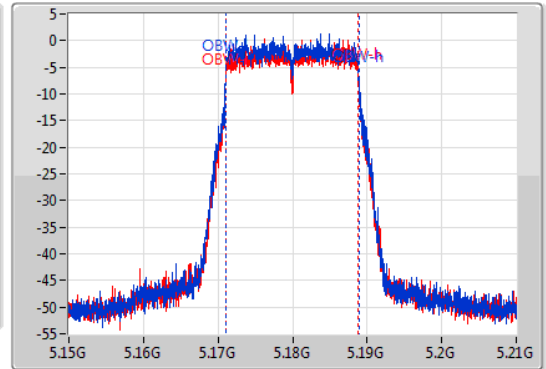

26dB(Hz)	Fl-26dB(Hz)	Fh-26dB(Hz)	OBW(Hz)	Fl-OBW(Hz)	Fh-OBW(Hz)	Limit(Hz)	Port
21.96M	5.16905G	5.19101G	17.811M	5.171064G	5.188876G	Inf	1
21.63M	5.1692G	5.19083G	17.781M	5.171064G	5.188846G	Inf	2

802.11ac VHT20_Nss2,(MCS0)_2TX

EBW

5200MHz

20/09/2019

CF
5.2GHz
Span
60MHz
RBW
300kHz
VBW
1MHz
Sweep Time
100ms
Detector Type
Peak

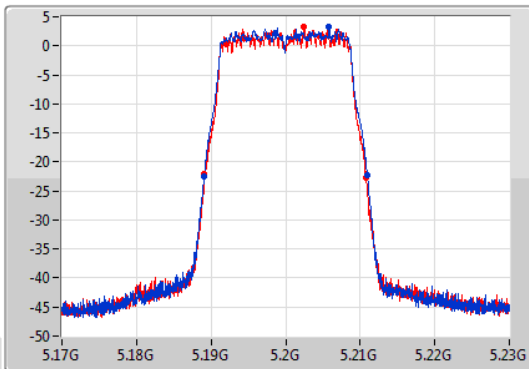

CF
5.2GHz
Span
60MHz
RBW
200kHz
VBW
1MHz
Sweep Time
100ms
Detector Type
Sample

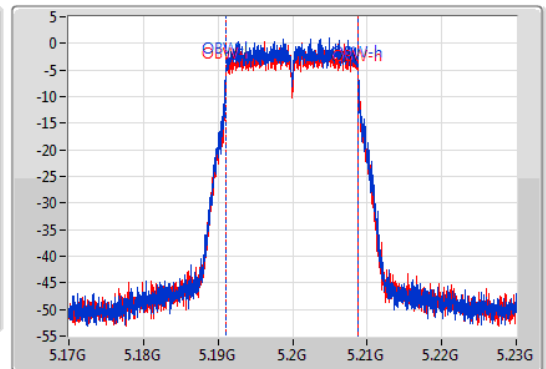

26dB(Hz)	Fl-26dB(Hz)	Fh-26dB(Hz)	OBW(Hz)	Fl-OBW(Hz)	Fh-OBW(Hz)	Limit(Hz)	Port
21.9M	5.18908G	5.21098G	17.811M	5.191034G	5.208846G	Inf	1
21.69M	5.18911G	5.2108G	17.751M	5.191094G	5.208846G	Inf	2

802.11ac VHT20_Nss2,(MCS0)_2TX

EBW

5240MHz

20/09/2019

CF
5.24GHz
Span
60MHz
RBW
300kHz
VBW
1MHz
Sweep Time
100ms
Detector Type
Peak

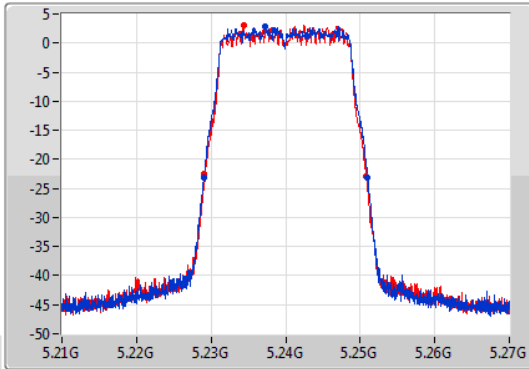

CF
5.24GHz
Span
60MHz
RBW
200kHz
VBW
1MHz
Sweep Time
100ms
Detector Type
Sample

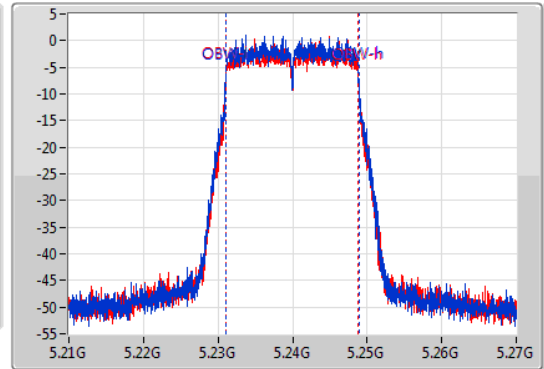

26dB(Hz)	Fl-26dB(Hz)	Fh-26dB(Hz)	OBW(Hz)	Fl-OBW(Hz)	Fh-OBW(Hz)	Limit(Hz)	Port
21.99M	5.22902G	5.25101G	17.811M	5.231064G	5.248876G	Inf	1
21.78M	5.22905G	5.25083G	17.751M	5.231094G	5.248846G	Inf	2

802.11ac VHT20_Nss2,(MCS0)_2TX

EBW

5745MHz

20/09/2019

CF
5.745GHz
Span
60MHz
RBW
100kHz
VBW
300kHz
Sweep Time
100ms
Detector Type
Peak

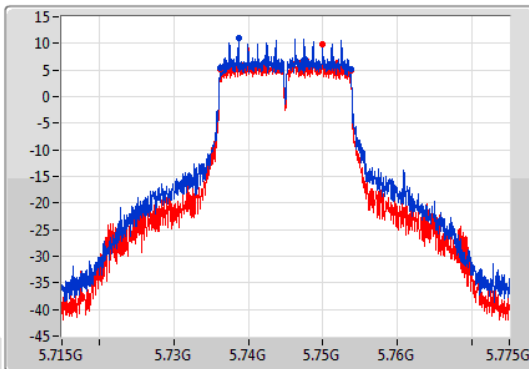

CF
5.745GHz
Span
60MHz
RBW
200kHz
VBW
1MHz
Sweep Time
100ms
Detector Type
Sample

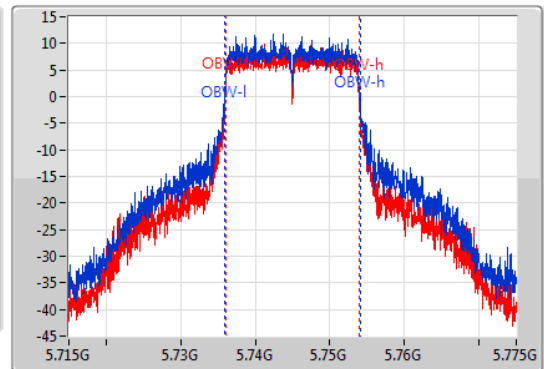

6dB(Hz)	Fl-6dB(Hz)	Fh-6dB(Hz)	OBW(Hz)	Fl-OBW(Hz)	Fh-OBW(Hz)	Limit(Hz)	Port
17.58M	5.73618G	5.75376G	18.261M	5.735825G	5.754085G	500k	1
17.58M	5.73618G	5.75376G	17.871M	5.736004G	5.753876G	500k	2

802.11ac VHT20_Nss2,(MCS0)_2TX

EBW

5785MHz

20/09/2019

CF
5.785GHz
Span
60MHz
RBW
100kHz
VBW
300kHz
Sweep Time
100ms
Detector Type
Peak

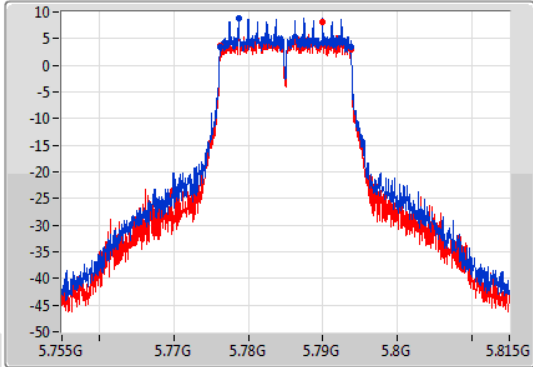

CF
5.785GHz
Span
60MHz
RBW
200kHz
VBW
1MHz
Sweep Time
100ms
Detector Type
Sample

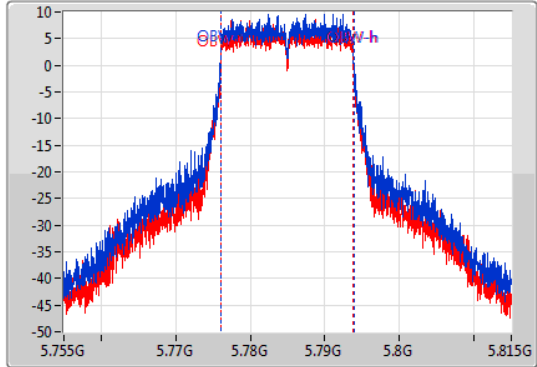

6dB(Hz)	Fl-6dB(Hz)	Fh-6dB(Hz)	OBW(Hz)	Fl-OBW(Hz)	Fh-OBW(Hz)	Limit(Hz)	Port
17.58M	5.77618G	5.79376G	17.871M	5.776004G	5.793876G	500k	1
17.58M	5.77618G	5.79376G	17.811M	5.776034G	5.793846G	500k	2

802.11ac VHT20_Nss2,(MCS0)_2TX

EBW

5825MHz

20/09/2019

CF
5.825GHz
Span
60MHz
RBW
100kHz
VBW
300kHz
Sweep Time
100ms
Detector Type
Peak

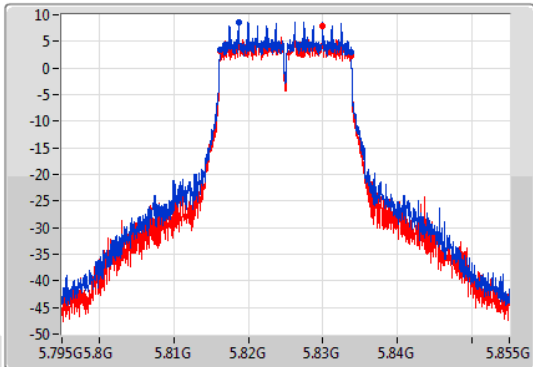

CF
5.825GHz
Span
60MHz
RBW
200kHz
VBW
1MHz
Sweep Time
100ms
Detector Type
Sample

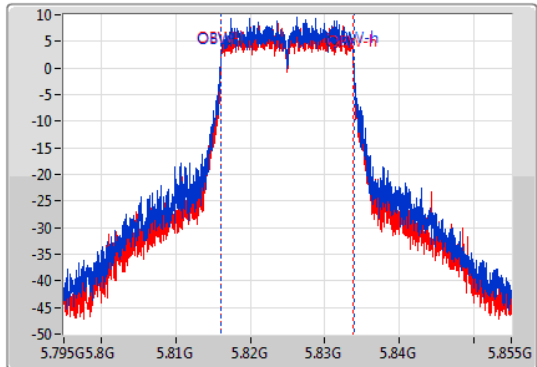

6dB(Hz)	Fl-6dB(Hz)	Fh-6dB(Hz)	OBW(Hz)	Fl-OBW(Hz)	Fh-OBW(Hz)	Limit(Hz)	Port
17.58M	5.81618G	5.83376G	17.841M	5.816034G	5.833876G	500k	1
17.58M	5.81618G	5.83376G	17.751M	5.816064G	5.833816G	500k	2

802.11ac VHT40_Nss2,(MCS0)_2TX

EBW

5190MHz

20/09/2019

CF
5.19GHz
Span
120MHz
RBW
500kHz
VBW
2MHz
Sweep Time
100ms
Detector Type
Peak

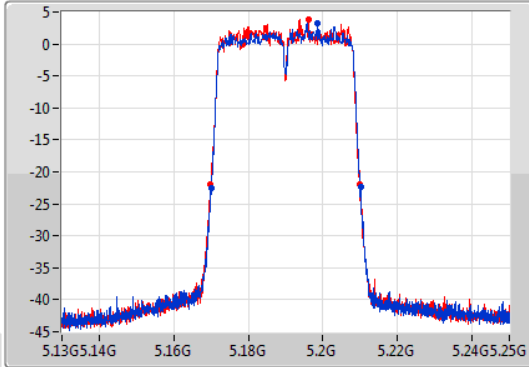

CF
5.19GHz
Span
120MHz
RBW
500kHz
VBW
2MHz
Sweep Time
100ms
Detector Type
Sample

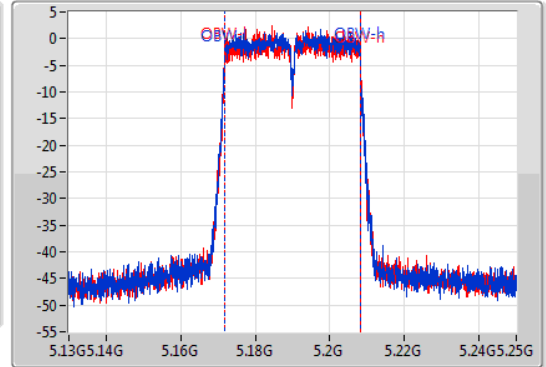

26dB(Hz)	Fl-26dB(Hz)	Fh-26dB(Hz)	OBW(Hz)	Fl-OBW(Hz)	Fh-OBW(Hz)	Limit(Hz)	Port
40.02M	5.17008G	5.2101G	36.222M	5.171829G	5.208051G	Inf	1
39.96M	5.1699G	5.20986G	36.282M	5.171829G	5.208111G	Inf	2

802.11ac VHT40_Nss2,(MCS0)_2TX

EBW

5230MHz

20/09/2019

CF
5.23GHz
Span
120MHz
RBW
500kHz
VBW
2MHz
Sweep Time
100ms
Detector Type
Peak

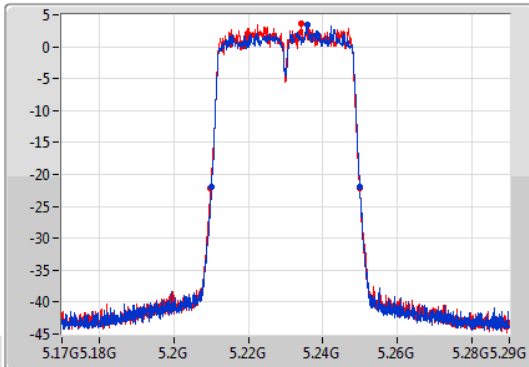

CF
5.23GHz
Span
120MHz
RBW
500kHz
VBW
2MHz
Sweep Time
100ms
Detector Type
Sample

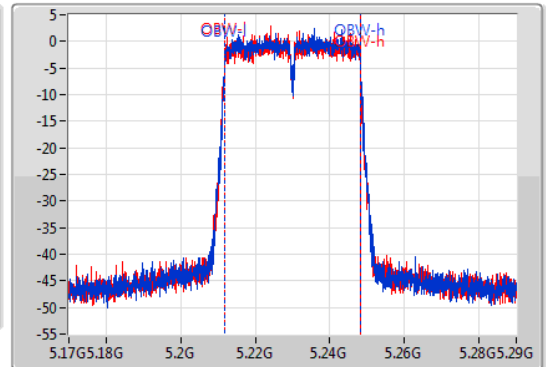

26dB(Hz)	Fl-26dB(Hz)	Fh-26dB(Hz)	OBW(Hz)	Fl-OBW(Hz)	Fh-OBW(Hz)	Limit(Hz)	Port
39.9M	5.21008G	5.24998G	36.222M	5.211829G	5.248051G	Inf	1
40.14M	5.20984G	5.24998G	36.222M	5.211829G	5.248051G	Inf	2

802.11ac VHT40_Nss2,(MCS0)_2TX

EBW

5755MHz

20/09/2019

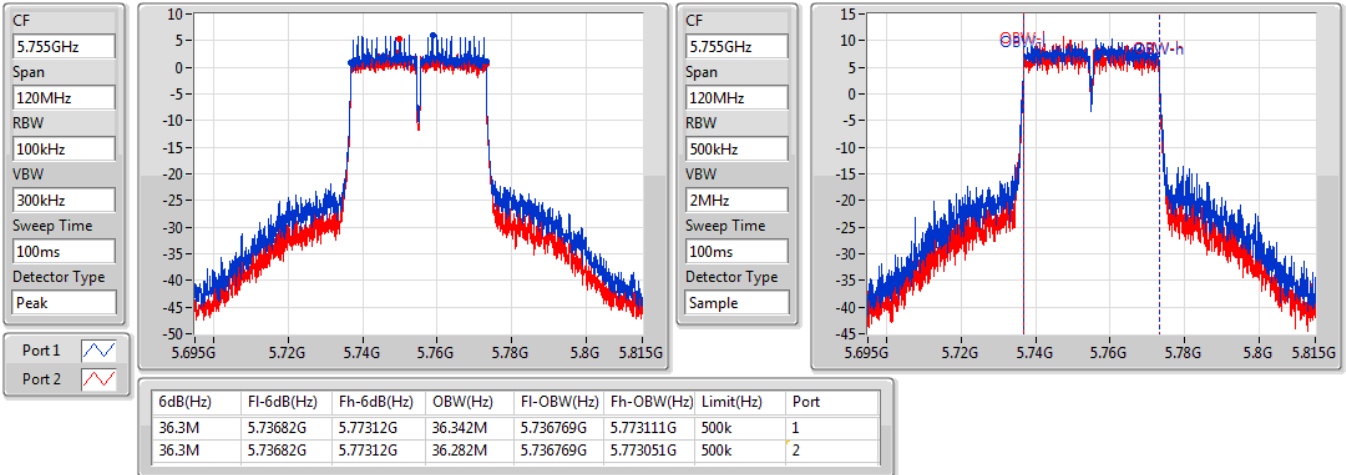

802.11ac VHT40_Nss2,(MCS0)_2TX

EBW

5795MHz

20/09/2019

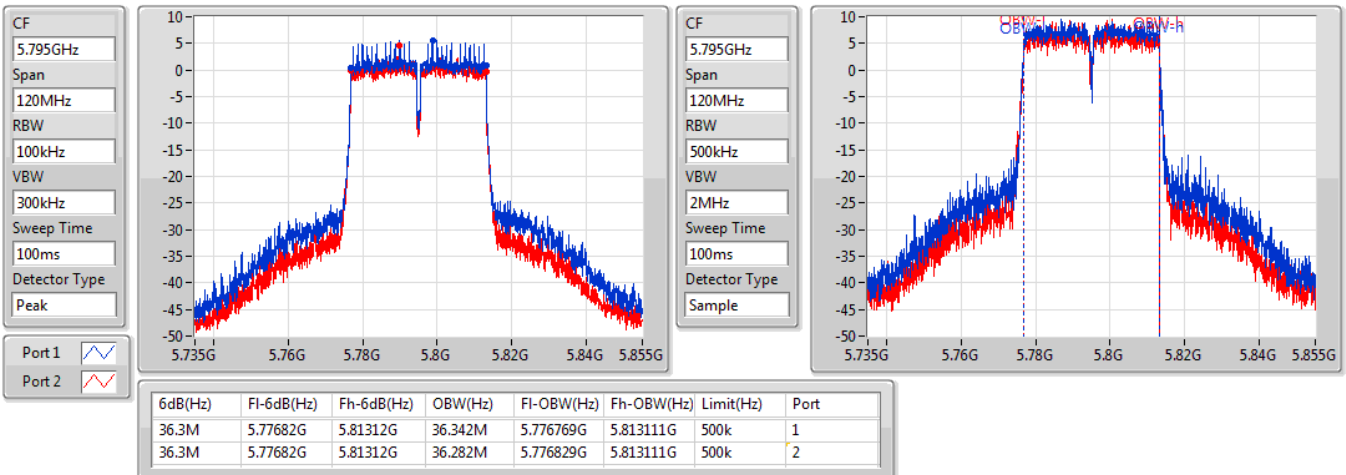

802.11ac VHT80_Nss2,(MCS0)_2TX

EBW

5210MHz

20/09/2019

CF
5.21GHz
Span
240MHz
RBW
1MHz
VBW
3MHz
Sweep Time
100ms
Detector Type
Peak

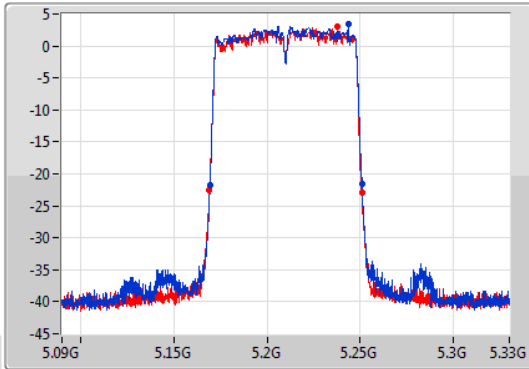

CF
5.21GHz
Span
240MHz
RBW
1MHz
VBW
3MHz
Sweep Time
100ms
Detector Type
Sample

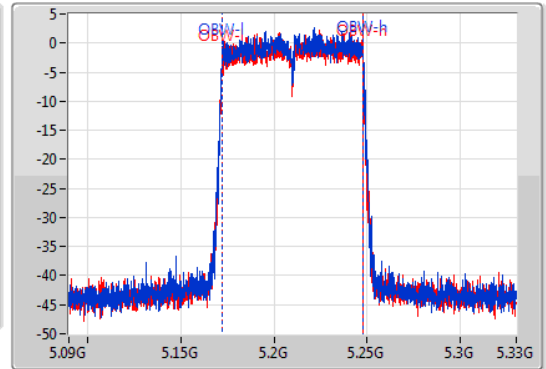

26dB(Hz)	Fl-26dB(Hz)	Fh-26dB(Hz)	OBW(Hz)	Fl-OBW(Hz)	Fh-OBW(Hz)	Limit(Hz)	Port
81.6M	5.16944G	5.25104G	75.802M	5.172099G	5.247901G	Inf	1
81.72M	5.16908G	5.2508G	75.802M	5.172099G	5.247901G	Inf	2

802.11ac VHT80_Nss2,(MCS0)_2TX

EBW

5775MHz

20/09/2019

CF
5.775GHz
Span
240MHz
RBW
100kHz
VBW
300kHz
Sweep Time
100ms
Detector Type
Peak

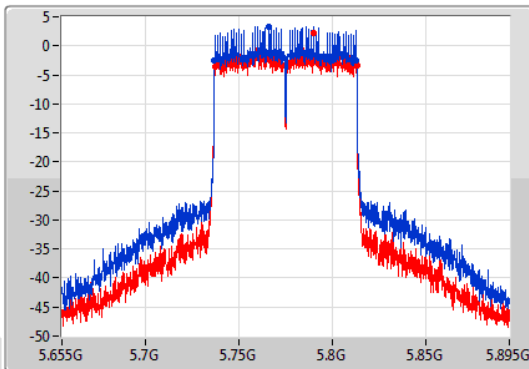

CF
5.775GHz
Span
240MHz
RBW
1MHz
VBW
3MHz
Sweep Time
100ms
Detector Type
Sample

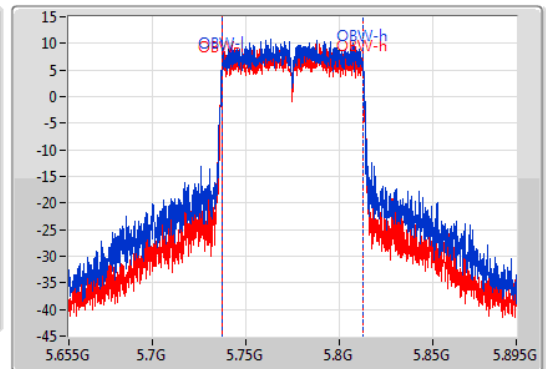

6dB(Hz)	Fl-6dB(Hz)	Fh-6dB(Hz)	OBW(Hz)	Fl-OBW(Hz)	Fh-OBW(Hz)	Limit(Hz)	Port
75.96M	5.73684G	5.8128G	75.922M	5.736979G	5.812901G	500k	1
75.96M	5.7372G	5.81316G	75.802M	5.736979G	5.812781G	500k	2

802.11ax HEW20_Nss2,(MCS0)_2TX

EBW

5180MHz

20/09/2019

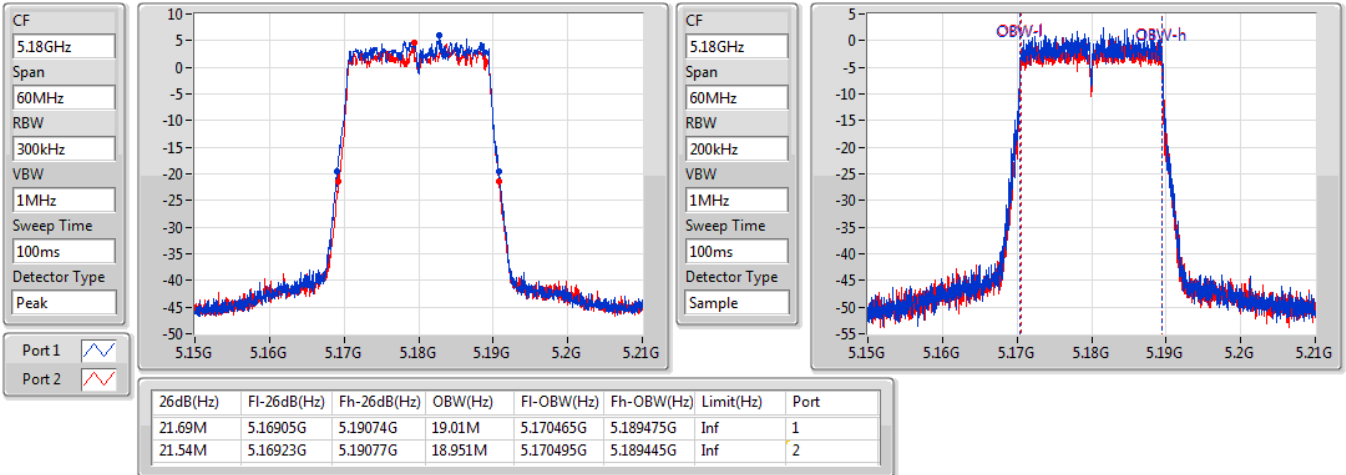

802.11ax HEW20_Nss2,(MCS0)_2TX

EBW

5200MHz

20/09/2019

