



RADIO TEST REPORT

FCC ID : QXO-AP4000
Equipment : Access Point
Brand Name : Extreme Networks
Model Name : AP4000
Applicant : Extreme Networks, Inc.
 6480 Via Del Oro, San Jose, CA 95119
Manufacturer : Extreme Networks, Inc.
 6480 Via Del Oro, San Jose, CA 95119
Standard : 47 CFR FCC Part 15.247

The product was received on May 13, 2021, and testing was started from May 21, 2021 and completed on Oct. 25, 2021. We, Sporton International Inc. Hsinchu Laboratory, would like to declare that the tested sample has been evaluated in accordance with the procedures given in ANSI C63.10-2013 and shown compliance with the applicable technical standards.

The test results in this report apply exclusively to the tested model / sample. Without written approval of Sporton International Inc. Hsinchu Laboratory, the test report shall not be reproduced except in full.

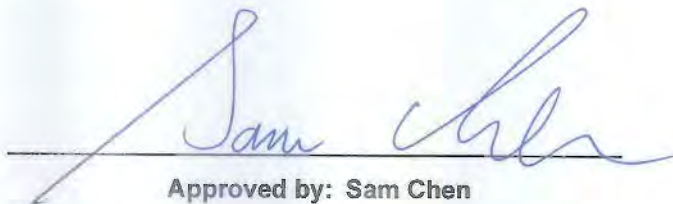

Approved by: Sam Chen

Sporton International Inc. Hsinchu Laboratory
 No.8, Ln. 724, Bo'ai St., Zhubei City, Hsinchu County 302010, Taiwan (R.O.C.)



Table of Contents

History of this test report.....3

Summary of Test Result.....4

1 General Description5

1.1 Information.....5

1.2 Applicable Standards10

1.3 Testing Location Information.....10

1.4 Measurement Uncertainty10

2 Test Configuration of EUT11

2.1 Test Channel Mode11

2.2 The Worst Case Measurement Configuration.....12

2.3 EUT Operation during Test14

2.4 Accessories14

2.5 Support Equipment.....15

2.6 Test Setup Diagram16

3 Transmitter Test Result19

3.1 AC Power-line Conducted Emissions19

3.2 DTS Bandwidth21

3.3 Maximum Conducted Output Power22

3.4 Power Spectral Density25

3.5 Emissions in Non-restricted Frequency Bands27

3.6 Emissions in Restricted Frequency Bands.....28

4 Test Equipment and Calibration Data32

Appendix A. Test Results of AC Power-line Conducted Emissions

Appendix B. Test Results of DTS Bandwidth

Appendix C. Test Results of Maximum Conducted Output Power

Appendix D. Test Results of Power Spectral Density

Appendix E. Test Results of Emissions in Non-restricted Frequency Bands

Appendix F. Test Results of Emissions in Restricted Frequency Bands

Appendix G. Test Photos

Photographs of EUT v01



History of this test report

Report No.	Version	Description	Issued Date
FR151220-03AE	01	Initial issue of report	Sep. 09, 2021
FR151220-03AE	02	Add the information of verifying the worst mode.	Oct. 27, 2021



Summary of Test Result

Report Clause	Ref Std. Clause	Test Items	Result (PASS/FAIL)	Remark
1.1.2	15.203	Antenna Requirement	PASS	-
3.1	15.207	AC Power-line Conducted Emissions	PASS	-
3.2	15.247(a)	DTS Bandwidth	PASS	-
3.3	15.247(b)	Maximum Conducted Output Power	PASS	-
3.4	15.247(e)	Power Spectral Density	PASS	-
3.5	15.247(d)	Emissions in Non-restricted Frequency Bands	PASS	-
3.6	15.247(d)	Emissions in Restricted Frequency Bands	PASS	-
Reference to Sporton Project No.: FR151220AE				

Declaration of Conformity:

The test results with all measurement uncertainty excluded are presented in accordance with the regulation limits or requirements declared by manufacturers.

Comments and Explanations:

1. The test configuration, test mode and test software were written in this test report are declared by the manufacturer.
2. The declared of product specification for EUT presented in the report are provided by the manufacturer, and the manufacturer takes all the responsibilities for the accuracy of product specification.

Reviewed by: Sam Chen

Report Producer: Viola Huang



1 General Description

1.1 Information

1.1.1 RF General Information

Frequency Range (MHz)	IEEE Std.	Ch. Frequency (MHz)	Channel Number
2400-2483.5	802.15.4	2405-2480	11-26 [26]

For Radio 4

Band	Mode	BWch (MHz)	Nant
2.4-2.4835GHz	802.15.4	3	1

Note:

- 802.15.4 uses a O-QPSK (250kbps) modulation.
- BWch is the nominal channel bandwidth.



1.1.2 Antenna Information

Ant.	Radio	Model Name	Antenna Type	Connector	Gain (dBi)
1	1, 2	N/A	PIFA	I-PEX	Note 1
2	1, 2	N/A	PIFA	I-PEX	
3	3	N/A	PIFA	I-PEX	
4	3	N/A	PIFA	I-PEX	
5	3	N/A	PIFA	I-PEX	
6	3	N/A	PIFA	I-PEX	
7	4	N/A	PIFA	I-PEX	

Ant.	WLAN 2.4GHz Port	WLAN 5GHz UNII 1~3 Port	Scanning radio (WLAN 2.4GHz) Port	Scanning radio (5GHz UNII 1~3) Port	Scanning radio (6E UNII 5~8) Port	Bluetooth / IEEE802.15.4 Port
1	2	2	-	-	-	-
2	1	1	-	-	-	-
3	-	-	2	2	-	-
4	-	-	1	1	-	-
5	-	-	-	-	1	-
6	-	-	-	-	2	-
7	-	-	-	-	-	1

Note 1:

Ant.	Gain (dBi)			
	WLAN 2.4GHz	Scanning radio (WLAN 2.4GHz)	Bluetooth	IEEE802.15.4
1	4	-	-	-
2	3.61	-	-	-
3	-	5.20	-	-
4	-	5.32	-	-
5	-	-	-	-
6	-	-	-	-
7	-	-	5.26	5.26



Ant.	WLAN 5GHz UNII 1~3				Scanning radio (5GHz UNII 1~3)				Scanning radio (6E UNII 5~8)			
	Band 1	Band 2	Band 3	Band 4	Band 1	Band 2	Band 3	Band 4	Band 5	Band 6	Band 7	Band 8
1	5.14	5.14	4.23	4.43	-	-	-	-	-	-	-	-
2	4.53	4.53	3.49	3.08	-	-	-	-	-	-	-	-
3	-	-	-	-	5.91	5.91	5.39	5.80	-	-	-	-
4	-	-	-	-	5.11	5.11	5.11	5.62	-	-	-	-
5	-	-	-	-	-	-	-	-	4.34	4.56	4.56	4.50
6	-	-	-	-	-	-	-	-	4.88	5.25	5.25	5.05

Ant.	Radio	Directional Gain (dBi)									
		WLAN 2.4GHz		5GHz Band 1		5GHz Band 2		5GHz Band 3		5GHz Band 4	
		2T1S	2T2S	2T1S	2T2S	2T1S	2T2S	2T1S	2T2S	2T1S	2T2S
1	1, 2	4.7	1.87	3.77	1.20	3.36	1.37	3.85	1.42	2.96	1.05
2											

Note 2: The EUT has seven antennas.

Note 3: The above information was declared by manufacturer.

Note 4: Radio 1, 2: Maximum Directional Gain following KDB662911 D03.

Note 5: Radio 3: Maximum Directional Gain following KDB662911 D01.

For Radio 1

For 2.4GHz:

For IEEE 802.11b/g/n/VHT/ax mode (1TX, 2TX/2RX):

For 1TX

The EUT supports the antenna with TX diversity functions.

Both Port 1 and Port 2 support transmit and receive functions, but only one of them will be used at one time.

The Port 1 generated the worst case, so it was selected to test and record in the report.

For 2TX/2RX

Port 1 and Port 2 can be used as transmitting/receiving antenna.

Port 1 and Port 2 could transmit/receive simultaneously.



For Radio 2

For 5GHz UNII 1~3:

For IEEE 802.11a/n/ac/ax mode (1TX, 2TX/2RX):

For 1TX

The EUT supports the antenna with TX diversity functions.

Both Port 1 and Port 2 support transmit and receive functions, but only one of them will be used at one time.

The Port 1 generated the worst case, so it was selected to test and record in the report.

For 2TX/2RX

Port 1 and Port 2 can be used as transmitting/receiving antenna.

Port 1 and Port 2 could transmit/receive simultaneously.

For Scanning radio 3

For 2.4GHz:

For IEEE 802.11b/g/n/VHT/ax mode (2TX/2RX):

For 5GHz UNII 1~3:

For IEEE 802.11a/n/ac/ax mode (2TX/2RX):

Port 1 and Port 2 can be used as transmitting/receiving antenna.

Port 1 and Port 2 could transmit/receive simultaneously.

For 6E UNII 5~8 (1TX, 2TX/2RX):

For 1TX

The EUT supports the antenna with TX diversity functions.

Both Port 1 and Port 2 support transmit and receive functions, but only one of them will be used at one time.

The Port 2 generated the worst case, so it was selected to test and record in the report.

For 2TX/2RX

Port 1 and Port 2 can be used as transmitting/receiving antenna.

Port 1 and Port 2 could transmit/receive simultaneously.

For Radio 4

Bluetooth / IEEE802.15.4 (1TX/1RX):

Only Port 1 can be used as transmitting/receiving antenna.



1.1.3 Mode Test Duty Cycle

Mode	DC	DCF(dB)	T(s)	VBW(Hz) ≥ 1/T
802.15.4	1	0	n/a (DC>=0.98)	n/a (DC>=0.98)

Note:

- ◆ DC is Duty Cycle.
- ◆ DCF is Duty Cycle Factor.

1.1.4 EUT Operational Condition

EUT Power Type	From PoE			
Beamforming Function	<input checked="" type="checkbox"/> With beamforming	<input type="checkbox"/> Without beamforming	The product has beamforming function for n/VHT/ax in 2.4GHz of radio 1, n/ac/ax in 5GHz UNII 1~UNII 3 of radio 2, and ax in 6GHz UNII 5~UNII 8 of radio 3.	
Function	<input checked="" type="checkbox"/> Point-to-multipoint	<input type="checkbox"/> Point-to-point		
Test Software Version	accessMtool [version 3.2.1.0]			

Note: The above information was declared by manufacturer.

1.1.5 Table for Radio function

Radio	WLAN 2.4GHz	5GHz UNII 1, 3	Scanning radio (WLAN 2.4GHz / 5GHz UNII 1, 3 / 6E (UNII 5~8))	Bluetooth / IEEE802.15.4
1	V (AP, Bridge, Mesh)	-	-	-
2	-	V AP for UNII 1, 3 Bridge, Mesh for UNII 1, 3	-	-
3	-	-	V (AP)	-
4	-	-	-	V

Note: The above information was declared by manufacturer.

1.1.6 Table for EUT support function

Function
AP
Bridge
Mesh

Note: For above table list, only AP mode was tested and recorded in this test.

Note: The above information was declared by manufacturer.



1.2 Applicable Standards

According to the specifications of the manufacturer, the EUT must comply with the requirements of the following standards:

- ♦ 47 CFR FCC Part 15.247
- ♦ ANSI C63.10-2013

The following reference test guidance is not within the scope of accreditation of TAF.

- ♦ FCC KDB 558074 D01 v05r02
- ♦ FCC KDB 414788 D01 v01r01

1.3 Testing Location Information

Testing Location Information	
Test Lab. : Sporton International Inc. Hsinchu Laboratory	
Hsinchu	ADD: No.8, Ln. 724, Bo'ai St., Zhubei City, Hsinchu County 302010, Taiwan (R.O.C.)
(TAF: 3787)	TEL: 886-3-656-9065 FAX: 886-3-656-9085
	Test site Designation No. TW3787 with FCC.
	Conformity Assessment Body Identifier (CABID) TW3787 with ISED.

Test Condition	Test Site No.	Test Engineer	Test Environment (°C / %)	Test Date
RF Conducted	TH02-CB	Paul Chen	23.4~24 / 55~60	May 22, 2021~Jun. 29, 2021
Radiated below 1GHz	03CH01-CB	Eddie Weng	25.4~27.1 / 60~65	Jun. 17, 2021, Oct. 25, 2021
Radiated above 1GHz	03CH01-CB	Kevin Huang	25.2~27.7 / 65~69	May 21, 2021~Jul. 14, 2021
AC Conduction	CO02-CB	Peter Wu	22~23 / 59~60	Jun. 22, 2021

1.4 Measurement Uncertainty

ISO/IEC 17025 requires that an estimate of the measurement uncertainties associated with the emissions test results be included in the report. The measurement uncertainties given below are based on a 95% confidence level (based on a coverage factor (k=2))

Test Items	Uncertainty	Remark
Conducted Emission (150kHz ~ 30MHz)	2.0 dB	Confidence levels of 95%
Radiated Emission (9kHz ~ 30MHz)	4.2 dB	Confidence levels of 95%
Radiated Emission (30MHz ~ 1,000MHz)	5.5 dB	Confidence levels of 95%
Radiated Emission (1GHz ~ 18GHz)	4.7 dB	Confidence levels of 95%
Radiated Emission (18GHz ~ 40GHz)	4.2 dB	Confidence levels of 95%
Conducted Emission	2.5 dB	Confidence levels of 95%
Output Power Measurement	1.3 dB	Confidence levels of 95%
Power Density Measurement	2.5 dB	Confidence levels of 95%
Bandwidth Measurement	0.9%	Confidence levels of 95%



2 Test Configuration of EUT

2.1 Test Channel Mode

Mode	Power Setting
802.15.4	-
2405MHz	5
2440MHz	5
2475MHz	5
2480MHz	-1



2.2 The Worst Case Measurement Configuration

The Worst Case Mode for Following Conformance Tests	
Tests Item	AC power-line conducted emissions
Condition	AC power-line conducted measurement for line and neutral Test Voltage: 120Vac / 60Hz
Operating Mode	Normal Link
1	Normal Link (Radio 1 + Radio 2 + Radio 3 (2.4GHz)) + CTX (Radio 4 (Bluetooth))
2	Normal Link (Radio 1 + Radio 2 + Radio 3 (2.4GHz)) + CTX Radio 4 (IEEE802.15.4)
Mode 1 has been evaluated to be the worst case among Mode 1~2, thus measurement for Mode 3~4 will follow this same test mode.	
3	Normal Link (Radio 1 + Radio 2 + Radio 3 (5GHz UNII)) + CTX Radio 4 (Bluetooth)
4	Normal Link (Radio 1 + Radio 2 + Radio 3 (6E)) + CTX Radio 4 (Bluetooth)
For operating mode 4 is the worst case and it was record in this test report.	

The Worst Case Mode for Following Conformance Tests	
Tests Item	DTS Bandwidth Maximum Conducted Output Power Power Spectral Density Emissions in Non-restricted Frequency Bands
Test Condition	Conducted measurement at transmit chains



The Worst Case Mode for Following Conformance Tests	
Tests Item	Emissions in Restricted Frequency Bands
Test Condition	Radiated measurement If EUT consist of multiple antenna assembly (multiple antenna are used in EUT regardless of spatial multiplexing MIMO configuration), the radiated test should be performed with highest antenna gain of each antenna type.
Operating Mode < 1GHz	Normal Link for Radio 1 + Radio 2 + Radio 3 CTX for Radio 4
1	EUT in Z axis-Normal Link (Radio 1 + Radio 2 + Radio 3 (2.4GHz)) + CTX (Radio 4 (Bluetooth))
2	EUT in Z axis-Normal Link (Radio 1 + Radio 2 + Radio 3 (2.4GHz)) + CTX Radio 4 (IEEE802.15.4)
Mode 2 has been evaluated to be the worst case among Mode 1~2, thus measurement for Mode 3~4 will follow this same test mode.	
3	EUT in Z axis-Normal Link (Radio 1 + Radio 2 + Radio 3 (5GHz UNII)) + CTX Radio 4 (IEEE802.15.4)
4	EUT in Z axis-Normal Link (Radio 1 + Radio 2 + Radio 3 (6E)) + CTX Radio 4 (IEEE802.15.4)
Mode 2 has been evaluated to be the worst case among Mode 1~4, thus measurement for Mode 5 and Mode 6 will follow this same test mode.	
5	EUT in Y axis-Normal Link (Radio 1 + Radio 2 + Radio 3 (2.4GHz)) + CTX Radio 4 (IEEE802.15.4)
6	EUT in X axis-Normal Link (Radio 1 + Radio 2 + Radio 3 (2.4GHz)) + CTX Radio 4 (IEEE802.15.4)
For operating mode 2 is the worst case and it was record in this test report.	
Operating Mode > 1GHz	CTX
	1. The EUT was performed at X axis, Y axis and Z axis and the worst case was found at Y axis. So the measurement will follow this same test configuration. 2. Refer to note 1 for detail operating mode
1	Radio 4_EUT in Y axis



The Worst Case Mode for Following Conformance Tests	
Tests Item	Simultaneous Transmission Analysis - Co-location RF Exposure Evaluation
Operating Mode	
1	Radio 1_2.4GHz + Radio 2_5GHz + Scanning radio 3_2.4GHz + Radio 4_Bluetooth
2	Radio 1_2.4GHz + Radio 2_5GHz + Scanning radio 3_2.4GHz + Radio 4_802.15.4
3	Radio 1_2.4GHz + Radio 2_5GHz + Scanning radio 3_5GHz + Radio 4_Bluetooth
4	Radio 1_2.4GHz + Radio 2_5GHz + Scanning radio 3_5GHz + Radio 4_802.15.4
5	Radio 1_2.4GHz + Radio 2_5GHz + Scanning radio 3_6E + Radio 4_Bluetooth
6	Radio 1_2.4GHz + Radio 2_5GHz + Scanning radio 3_6E + Radio 4_802.15.4
Refer to Sporton Test Report No.: FA151220-03 for Co-location RF Exposure Evaluation.	

Note 1: The PoE is for measurement only, would not be marketed.

PoE information as below:

Power	Brand	Model
PoE	Microsemi	PD-9001-10GC/AC

2.3 EUT Operation during Test

For CTX Mode:

The EUT was programmed to be in continuously transmitting mode.

For Normal Link:

During the test, the EUT operation to normal function.

2.4 Accessories

Accessories
Cradle*1



2.5 Support Equipment

For AC Conduction:

Support Equipment				
No.	Equipment	Brand Name	Model Name	FCC ID
A	ETH0/POE+NB	DELL	E6430	N/A
B	ETH1 NB	DELL	E6430	N/A
C	2.4G NB	DELL	E6430	N/A
D	5G NB	DELL	E6430	N/A
E	6E clinet	Extreme Networks	AP4000U	N/A
F	PoE	Microsemi	PD-9001-10GC/AC	N/A
G	Flash disk3.0	Transcend	JetFlash-700	N/A

For Radiated (below 1GHz):

Support Equipment				
No.	Equipment	Brand Name	Model Name	FCC ID
A	PoE	Microsemi	PD-9001-10GC/AC	N/A
B	PC	DELL	OPTIPLEX 3010	N/A
C	Notebook	Apple	Mac Book	N/A
D	Notebook	Apple	Mac Book	N/A
E	Notebook	Apple	Mac Book	N/A
F	Flash disk3.0	Silicon Power	B06	N/A
G	Notebook	DELL	E4300	N/A

For Radiated (above 1GHz):

Support Equipment				
No.	Equipment	Brand Name	Model Name	FCC ID
A	Notebook	DELL	E4300	N/A
B	PoE	Microsemi	PD-9001-10GC/AC	N/A

For RF Conducted:

Support Equipment				
No.	Equipment	Brand Name	Model Name	FCC ID
A	Notebook	DELL	E4300	N/A
B	PoE	Microsemi	PD-9001-10GC/AC	N/A

2.6 Test Setup Diagram

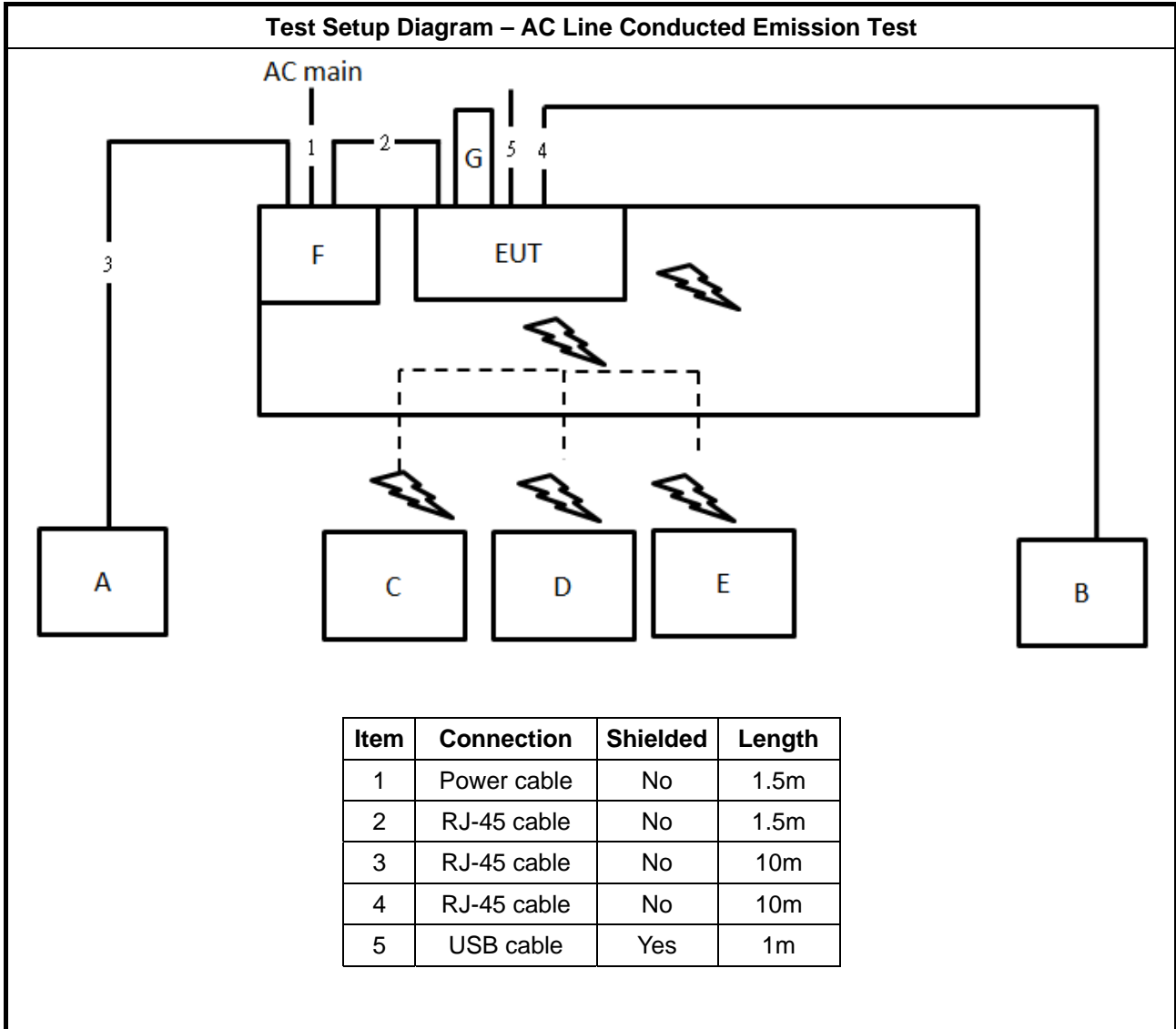

Test Setup Diagram - Radiated Test < 1GHz

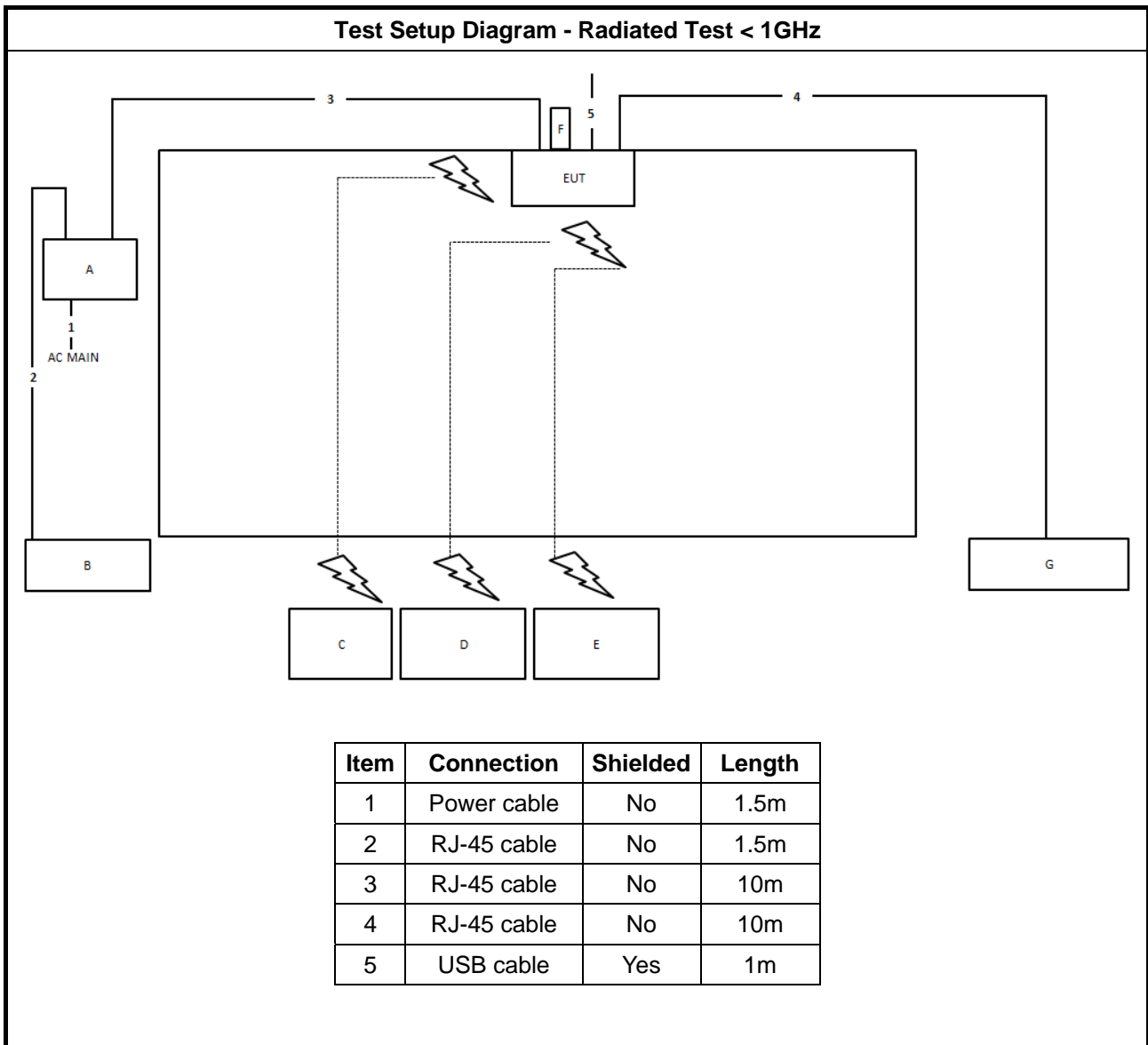

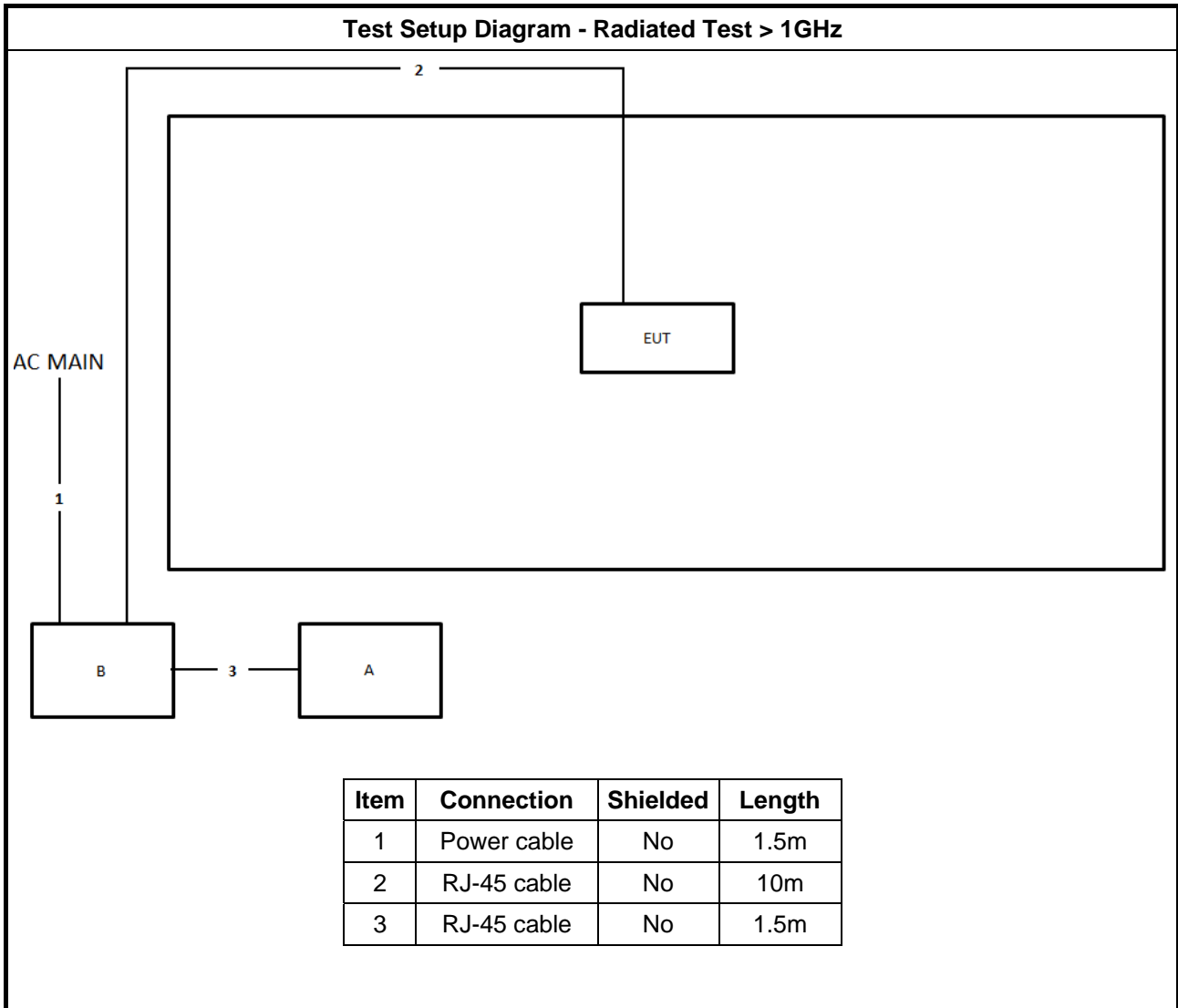



3 Transmitter Test Result

3.1 AC Power-line Conducted Emissions

3.1.1 AC Power-line Conducted Emissions Limit

AC Power-line Conducted Emissions Limit		
Frequency Emission (MHz)	Quasi-Peak	Average
0.15-0.5	66 - 56 *	56 - 46 *
0.5-5	56	46
5-30	60	50

Note 1: * Decreases with the logarithm of the frequency.

3.1.2 Measuring Instruments

Refer a test equipment and calibration data table in this test report.

3.1.3 Test Procedures

Test Method
<input checked="" type="checkbox"/> Refer as ANSI C63.10-2013, clause 6.2 for AC power-line conducted emissions.

3.1.4 Test Setup

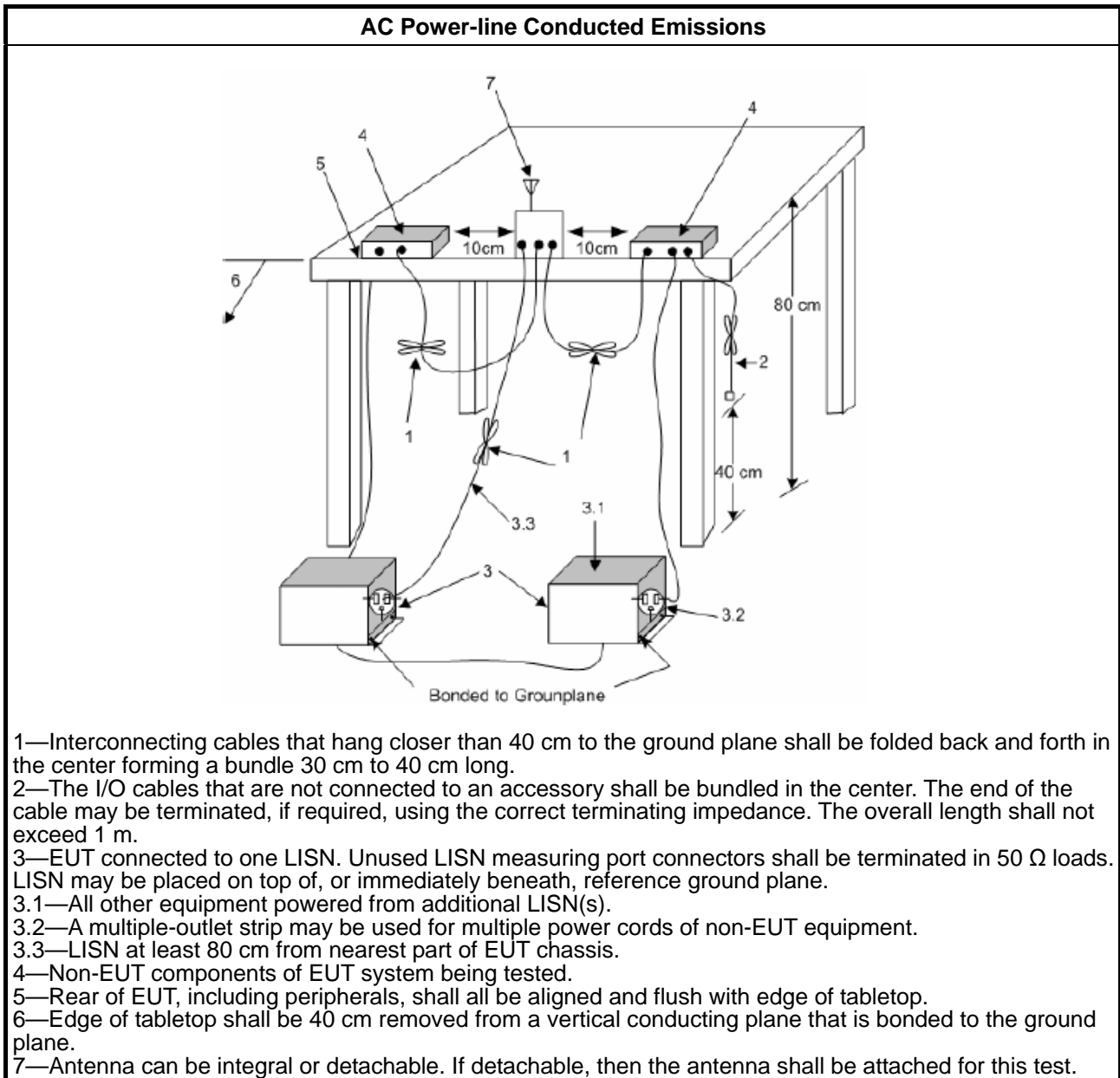

3.1.5 Measurement Results Calculation

The measured Level is calculated using:

- a. Corrected Reading: LISN Factor (LISN) + Attenuator (AT/AUX) + Cable Loss (CL) + Read Level (Raw) = Level
- b. Margin = -Limit + Level

3.1.6 Test Result of AC Power-line Conducted Emissions

Refer as Appendix A

3.2 DTS Bandwidth

3.2.1 6dB Bandwidth Limit

6dB Bandwidth Limit
Systems using digital modulation techniques:
<ul style="list-style-type: none"> ▪ 6 dB bandwidth \geq 500 kHz.

3.2.2 Measuring Instruments

Refer a test equipment and calibration data table in this test report.

3.2.3 Test Procedures

Test Method
<ul style="list-style-type: none"> ▪ For the emission bandwidth shall be measured using one of the options below:
<input checked="" type="checkbox"/> Refer as FCC KDB 558074, clause 8.2 & C63.10 clause 11.8.1 Option 1 for 6 dB bandwidth measurement.
<input type="checkbox"/> Refer as FCC KDB 558074, clause 8.2 & C63.10 clause 11.8.2 Option 2 for 6 dB bandwidth measurement.
<input type="checkbox"/> Refer as ANSI C63.10, clause 6.9.1 for occupied bandwidth testing.

3.2.4 Test Setup

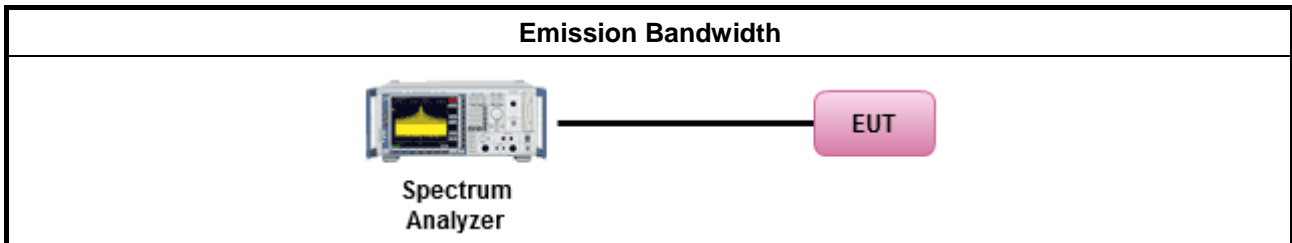

3.2.5 Test Result of Emission Bandwidth

Refer as Appendix B



3.3 Maximum Conducted Output Power

3.3.1 Maximum Conducted Output Power Limit

Maximum Conducted Output Power Limit	
	<ul style="list-style-type: none"> ▪ If $G_{TX} \leq 6$ dBi, then $P_{Out} \leq 30$ dBm (1 W)
	<ul style="list-style-type: none"> ▪ Point-to-multipoint systems (P2M): If $G_{TX} > 6$ dBi, then $P_{Out} = 30 - (G_{TX} - 6)$ dBm
	<ul style="list-style-type: none"> ▪ Point-to-point systems (P2P): If $G_{TX} > 6$ dBi, then $P_{Out} = 30 - (G_{TX} - 6)/3$ dBm
	<ul style="list-style-type: none"> ▪ Smart antenna system (SAS):
	<ul style="list-style-type: none"> - Single beam: If $G_{TX} > 6$ dBi, then $P_{Out} = 30 - (G_{TX} - 6)/3$ dBm
	<ul style="list-style-type: none"> - Overlap beam: If $G_{TX} > 6$ dBi, then $P_{Out} = 30 - (G_{TX} - 6)/3$ dBm
	<ul style="list-style-type: none"> - Aggregate power on all beams: If $G_{TX} > 6$ dBi, then $P_{Out} = 30 - (G_{TX} - 6)/3 + 8$ dB dBm
<p>P_{Out} = maximum peak conducted output power or maximum conducted output power in dBm, G_{TX} = the maximum transmitting antenna directional gain in dBi.</p>	

3.3.2 Measuring Instruments

Refer a test equipment and calibration data table in this test report.



3.3.3 Test Procedures

Test Method	
<ul style="list-style-type: none"> ▪ Maximum Peak Conducted Output Power 	
<input type="checkbox"/>	Refer as FCC KDB 558074, clause 8.3.1.1 & C63.10 clause 11.9.1.1 (RBW ≥ EBW method).
<input type="checkbox"/>	Refer as FCC KDB 558074, clause 8.3.1.3 & C63.10 clause 11.9.1.3 (peak power meter).
<ul style="list-style-type: none"> ▪ Maximum Conducted Output Power 	
[duty cycle ≥ 98% or external video / power trigger]	
<input type="checkbox"/>	Refer as FCC KDB 558074, clause 8.3.2.2 & C63.10 clause 11.9.2.2 Method AVGSA-1.
<input type="checkbox"/>	Refer as FCC KDB 558074, clause 8.3.2.2 & C63.10 clause 11.9.2.2.3 Method AVGSA-1A. (alternative)
duty cycle < 98% and average over on/off periods with duty factor	
<input type="checkbox"/>	Refer as FCC KDB 558074, clause 8.3.2.2 & C63.10 clause 11.9.2.2.4 Method AVGSA-2.
<input type="checkbox"/>	Refer as FCC KDB 558074, clause 8.3.2.2 & C63.10 clause 11.9.2.2.5 Method AVGSA-2A (alternative)
<input type="checkbox"/>	Refer as FCC KDB 558074, clause 8.3.2.2 & C63.10 clause 11.9.2.2.6 Method AVGSA-3
<input type="checkbox"/>	Refer as FCC KDB 558074, clause 8.3.2.2 & C63.10 clause 11.9.2.2.7 Method AVGSA-3A (alternative)
Measurement using a power meter (PM)	
<input type="checkbox"/>	Refer as FCC KDB 558074, clause 8.3.2.3 & C63.10 clause 11.9.2.3.1 Method AVGPM (using an RF average power meter).
<input checked="" type="checkbox"/>	Refer as FCC KDB 558074, clause 8.3.2.3 & C63.10 clause 11.9.2.3.2 Method AVGPM-G (using an gate RF average power meter).
<ul style="list-style-type: none"> ▪ For conducted measurement. 	
<ul style="list-style-type: none"> ▪ If the EUT supports multiple transmit chains using options given below: Refer as FCC KDB 662911, In-band power measurements. Using the measure-and-sum approach, measured all transmit ports individually. Sum the power (in linear power units e.g., mW) of all ports for each individual sample and save them. 	
<ul style="list-style-type: none"> ▪ If multiple transmit chains, EIRP calculation could be following as methods: $P_{total} = P_1 + P_2 + \dots + P_n$ (calculated in linear unit [mW] and transfer to log unit [dBm]) $EIRP_{total} = P_{total} + DG$ 	

3.3.4 Test Setup

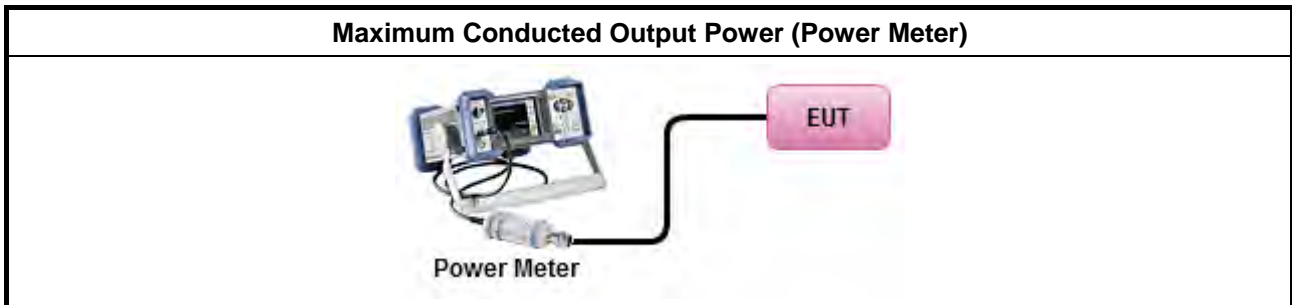

3.3.5 Test Result of Maximum Conducted Output Power

Refer as Appendix C



3.4 Power Spectral Density

3.4.1 Power Spectral Density Limit

Power Spectral Density Limit
<ul style="list-style-type: none"> Power Spectral Density (PSD) \leq 8 dBm/3kHz

3.4.2 Measuring Instruments

Refer a test equipment and calibration data table in this test report.

3.4.3 Test Procedures

Test Method			
<ul style="list-style-type: none"> Peak power spectral density procedures that the same method as used to determine the conducted output power. If maximum peak conducted output power was measured to demonstrate compliance to the output power limit, then the peak PSD procedure below (Method PKPSD) shall be used. If maximum conducted output power was measured to demonstrate compliance to the output power limit, then one of the average PSD procedures shall be used, as applicable based on the following criteria (the peak PSD procedure is also an acceptable option). 			
<input checked="" type="checkbox"/> Refer as FCC KDB 558074, clause 8.4 & C63.10 clause 11.10 Method Max. PSD.			
<ul style="list-style-type: none"> For conducted measurement. <ul style="list-style-type: none"> If The EUT supports multiple transmit chains using options given below: <table border="1"> <tbody> <tr> <td> <input type="checkbox"/> Option 1: Measure and sum the spectra across the outputs. Refer as FCC KDB 662911, In-band power spectral density (PSD). Sample all transmit ports simultaneously using a spectrum analyzer for each transmit port. Where the trace bin-by-bin of each transmit port summing can be performed. (i.e., in the first spectral bin of output 1 is summed with that in the first spectral bin of output 2 and that from the first spectral bin of output 3, and so on up to the NTX output to obtain the value for the first frequency bin of the summed spectrum.). Add up the amplitude (power) values for the different transmit chains and use this as the new data trace. </td> </tr> <tr> <td> <input type="checkbox"/> Option 2: Measure and sum spectral maxima across the outputs. With this technique, spectra are measured at each output of the device at the required resolution bandwidth. The maximum value (peak) of each spectrum is determined. These maximum values are then summed mathematically in linear power units across the outputs. These operations shall be performed separately over frequency spans that have different out-of-band or spurious emission limits, </td> </tr> <tr> <td> <input type="checkbox"/> Option 3: Measure and add 10 log(N) dB, where N is the number of transmit chains. Refer as FCC KDB 662911, In-band power spectral density (PSD). Performed at each transmit chains and each transmit chains shall be compared with the limit have been reduced with 10 log(N). Or each transmit chains shall be add 10 log(N) to compared with the limit. </td> </tr> </tbody> </table> 	<input type="checkbox"/> Option 1: Measure and sum the spectra across the outputs. Refer as FCC KDB 662911, In-band power spectral density (PSD). Sample all transmit ports simultaneously using a spectrum analyzer for each transmit port. Where the trace bin-by-bin of each transmit port summing can be performed. (i.e., in the first spectral bin of output 1 is summed with that in the first spectral bin of output 2 and that from the first spectral bin of output 3, and so on up to the NTX output to obtain the value for the first frequency bin of the summed spectrum.). Add up the amplitude (power) values for the different transmit chains and use this as the new data trace.	<input type="checkbox"/> Option 2: Measure and sum spectral maxima across the outputs. With this technique, spectra are measured at each output of the device at the required resolution bandwidth. The maximum value (peak) of each spectrum is determined. These maximum values are then summed mathematically in linear power units across the outputs. These operations shall be performed separately over frequency spans that have different out-of-band or spurious emission limits,	<input type="checkbox"/> Option 3: Measure and add 10 log(N) dB, where N is the number of transmit chains. Refer as FCC KDB 662911, In-band power spectral density (PSD). Performed at each transmit chains and each transmit chains shall be compared with the limit have been reduced with 10 log(N). Or each transmit chains shall be add 10 log(N) to compared with the limit.
<input type="checkbox"/> Option 1: Measure and sum the spectra across the outputs. Refer as FCC KDB 662911, In-band power spectral density (PSD). Sample all transmit ports simultaneously using a spectrum analyzer for each transmit port. Where the trace bin-by-bin of each transmit port summing can be performed. (i.e., in the first spectral bin of output 1 is summed with that in the first spectral bin of output 2 and that from the first spectral bin of output 3, and so on up to the NTX output to obtain the value for the first frequency bin of the summed spectrum.). Add up the amplitude (power) values for the different transmit chains and use this as the new data trace.			
<input type="checkbox"/> Option 2: Measure and sum spectral maxima across the outputs. With this technique, spectra are measured at each output of the device at the required resolution bandwidth. The maximum value (peak) of each spectrum is determined. These maximum values are then summed mathematically in linear power units across the outputs. These operations shall be performed separately over frequency spans that have different out-of-band or spurious emission limits,			
<input type="checkbox"/> Option 3: Measure and add 10 log(N) dB, where N is the number of transmit chains. Refer as FCC KDB 662911, In-band power spectral density (PSD). Performed at each transmit chains and each transmit chains shall be compared with the limit have been reduced with 10 log(N). Or each transmit chains shall be add 10 log(N) to compared with the limit.			

3.4.4 Test Setup

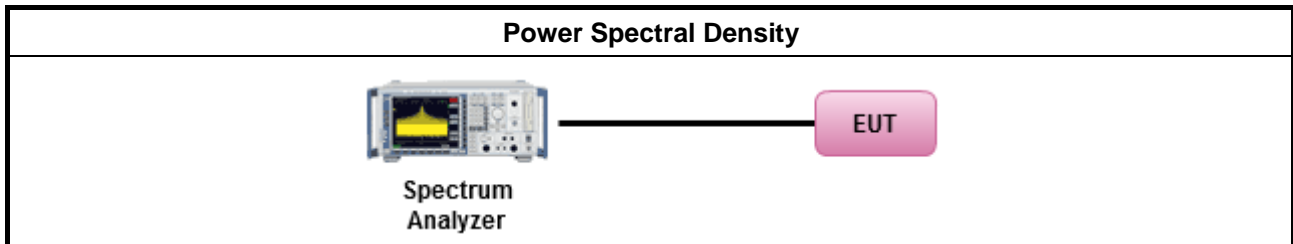

3.4.5 Test Result of Power Spectral Density

Refer as Appendix D

3.5 Emissions in Non-restricted Frequency Bands

3.5.1 Emissions in Non-restricted Frequency Bands Limit

Un-restricted Band Emissions Limit	
RF output power procedure	Limit (dBc)
Peak output power procedure	20
Average output power procedure	30

Note 1: If the peak output power procedure is used to measure the fundamental emission power to demonstrate compliance to requirements, then the peak conducted output power measured within any 100 kHz outside the authorized frequency band shall be attenuated by at least 20 dB relative to the maximum measured in-band peak PSD level.

Note 2: If the average output power procedure is used to measure the fundamental emission power to demonstrate compliance to requirements, then the power in any 100 kHz outside of the authorized frequency band shall be attenuated by at least 30 dB relative to the maximum measured in-band average PSD level.

3.5.2 Measuring Instruments

Refer a test equipment and calibration data table in this test report.

3.5.3 Test Procedures

Test Method
<ul style="list-style-type: none"> Refer as FCC KDB 558074, clause 8.5 for unwanted emissions into non-restricted bands.

3.5.4 Test Setup

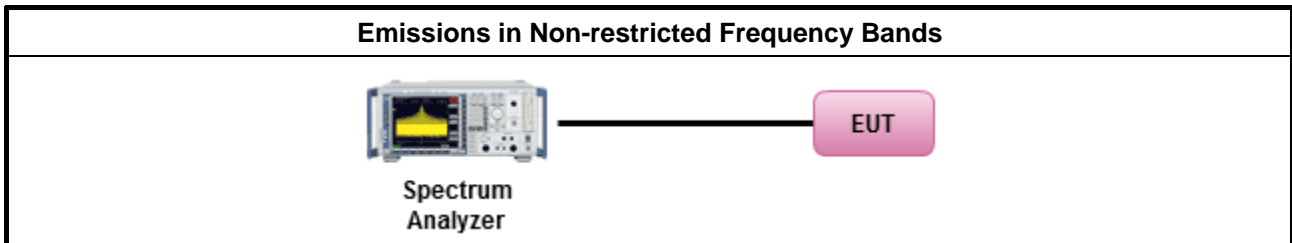

3.5.5 Test Result of Emissions in Non-restricted Frequency Bands

Refer as Appendix E



3.6 Emissions in Restricted Frequency Bands

3.6.1 Emissions in Restricted Frequency Bands Limit

Restricted Band Emissions Limit			
Frequency Range (MHz)	Field Strength (uV/m)	Field Strength (dBuV/m)	Measure Distance (m)
0.009~0.490	2400/F(kHz)	48.5 - 13.8	300
0.490~1.705	24000/F(kHz)	33.8 - 23	30
1.705~30.0	30	29	30
30~88	100	40	3
88~216	150	43.5	3
216~960	200	46	3
Above 960	500	54	3

Note 1: Test distance for frequencies at or above 30 MHz, measurements may be performed at a distance other than the limit distance provided they are not performed in the near field and the emissions to be measured can be detected by the measurement equipment. When performing measurements at a distance other than that specified, the results shall be extrapolated to the specified distance using an extrapolation factor of 20 dB/decade (inverse of linear distance for field-strength measurements, inverse of linear distance-squared for power-density measurements).

Note 2: Test distance for frequencies at below 30 MHz, measurements may be performed at a distance closer than the EUT limit distance; however, an attempt should be made to avoid making measurements in the near field. When performing measurements below 30 MHz at a closer distance than the limit distance, the results shall be extrapolated to the specified distance by either making measurements at a minimum of two or more distances on at least one radial to determine the proper extrapolation factor or by using the square of an inverse linear distance extrapolation factor (40 dB/decade). The test report shall specify the extrapolation method used to determine compliance of the EUT.

Note 3: Using the distance of 1m during the test for above 18 GHz, and the test value to correct for the distance factor at 3m.

3.6.2 Measuring Instruments

Refer a test equipment and calibration data table in this test report.



3.6.3 Test Procedures

Test Method	
<ul style="list-style-type: none"> ▪ The average emission levels shall be measured in [duty cycle \geq 98 or duty factor]. 	
<ul style="list-style-type: none"> ▪ Refer as ANSI C63.10, clause 6.10.3 band-edge testing shall be performed at the lowest frequency channel and highest frequency channel within the allowed operating band. 	
<ul style="list-style-type: none"> ▪ For the transmitter unwanted emissions shall be measured using following options below: 	
	<ul style="list-style-type: none"> ▪ Refer as FCC KDB 558074, clause 8.6 for unwanted emissions into restricted bands.
	<input type="checkbox"/> Refer as FCC KDB 558074, clause 8.6 & C63.10 clause 11.12.2.5.1(trace averaging for duty cycle \geq 98%).
	<input type="checkbox"/> Refer as FCC KDB 558074, clause 8.6 & C63.10 clause 11.12.2.5.2(trace averaging + duty factor).
	<input checked="" type="checkbox"/> Refer as FCC KDB 558074, clause 8.6 & C63.10 clause 11.12.2.5.3(Reduced VBW \geq 1/T).
	<input type="checkbox"/> Refer as ANSI C63.10, clause 11.12.2.5.3 (Reduced VBW). VBW \geq 1/T, where T is pulse time.
	<input type="checkbox"/> Refer as ANSI C63.10, clause 7.5 average value of pulsed emissions.
	<input checked="" type="checkbox"/> Refer as FCC KDB 558074, clause 8.6 & C63.10 clause 11.12.2.4 measurement procedure peak limit.
<ul style="list-style-type: none"> ▪ For the transmitter band-edge emissions shall be measured using following options below: 	
	<ul style="list-style-type: none"> ▪ Refer as FCC KDB 558074 clause 8.7 & c63.10 clause 11.13.1, When the performing peak or average radiated measurements, emissions within 2 MHz of the authorized band edge may be measured using the marker-delta method described below.
	<ul style="list-style-type: none"> ▪ Refer as FCC KDB 558074, clause 8.7 (ANSI C63.10, clause 6.10.6) for marker-delta method for band-edge measurements.
	<ul style="list-style-type: none"> ▪ Refer as FCC KDB 558074, clause 8.7 for narrower resolution bandwidth (100kHz) using the band power and summing the spectral levels (i.e., 1 MHz).
	<ul style="list-style-type: none"> ▪ For conducted unwanted emissions into restricted bands (absolute emission limits). Devices with multiple transmit chains using options given below: (1) Measure and sum the spectra across the outputs or (2) Measure and add 10 log(N) dB
	<ul style="list-style-type: none"> ▪ For FCC KDB 662911 The methodology described here may overestimate array gain, thereby resulting in apparent failures to satisfy the out-of-band limits even if the device is actually compliant. In such cases, compliance may be demonstrated by performing radiated tests around the frequencies at which the apparent failures occurred.

3.6.4 Test Setup

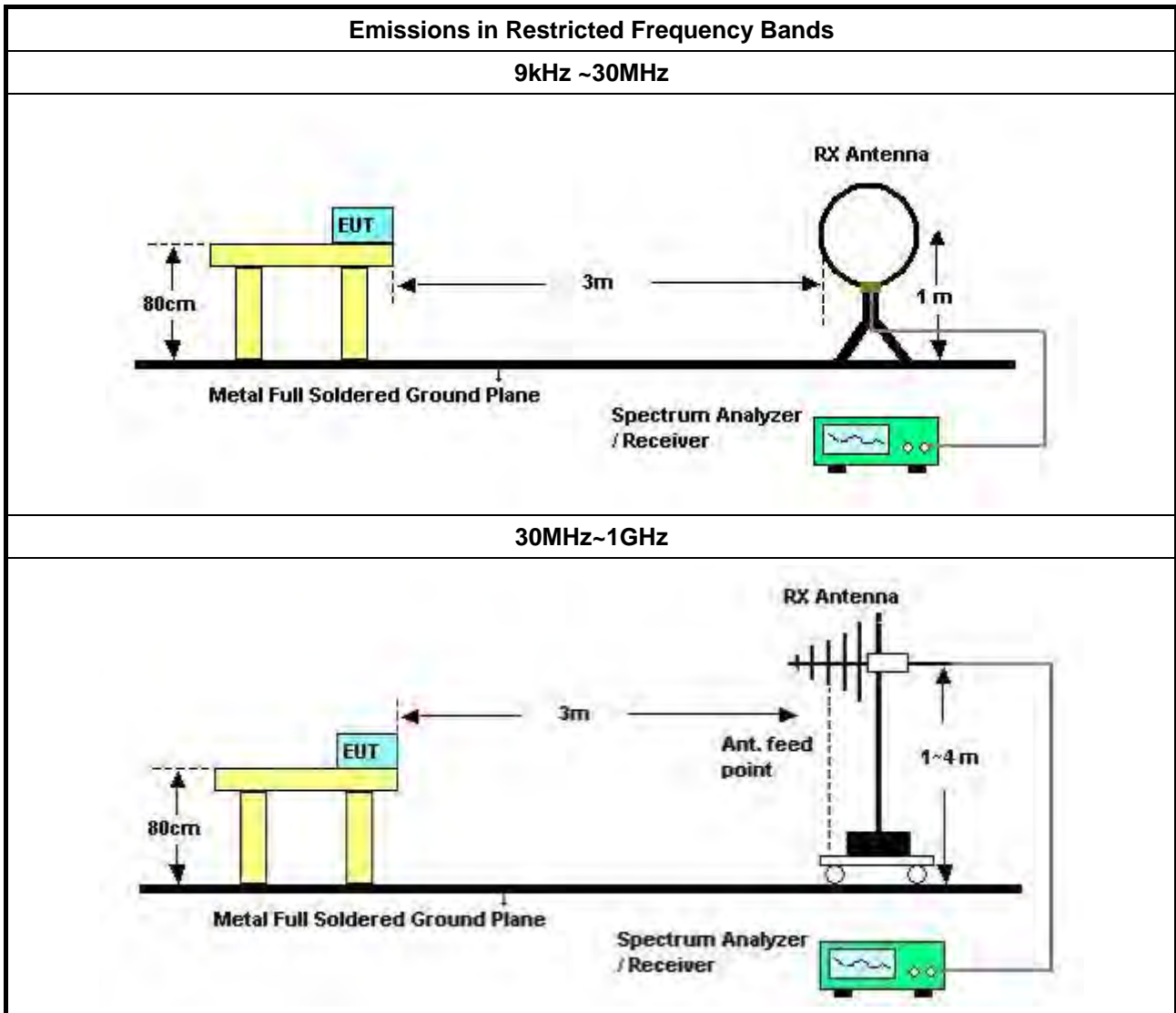

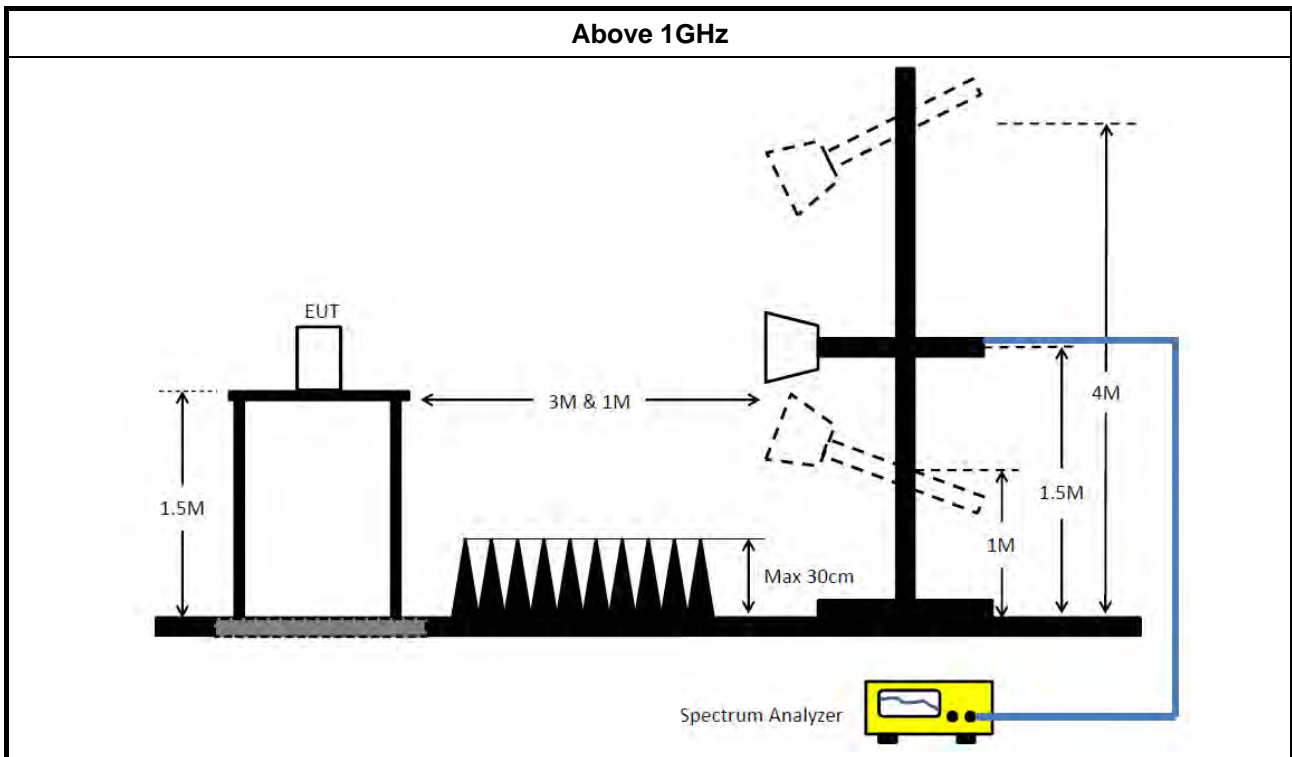

3.6.5 Measurement Results Calculation

The measured Level is calculated using:

Corrected Reading: Antenna factor (AF) + Cable loss (CL) + Read level (Raw) - Preamp factor (PA)(if applicable) = Level.

3.6.6 Emissions in Restricted Frequency Bands (Below 30MHz)

There is a comparison data of both open-field test site and alternative test site - semi-Anechoic chamber according to KDB414788 Radiated Test Site, and the result came out very similar.

All amplitude of spurious emissions that are attenuated by more than 20 dB below the permissible value has no need to be reported.

The radiated emissions were investigated from 9 kHz or the lowest frequency generated within the device, up to the 10th harmonic or 40 GHz, whichever is appropriate.

3.6.7 Test Result of Emissions in Restricted Frequency Bands

Refer as Appendix F



4 Test Equipment and Calibration Data

Instrument	Brand	Model No.	Serial No.	Characteristics	Calibration Date	Calibration Due Date	Remark
LISN	Schwarzbeck	NSLK 8127	8127650	9kHz ~ 30MHz	Dec. 04, 2020	Dec. 03, 2021	Conduction (CO02-CB)
LISN	Schwarzbeck	NSLK 8127	8127478	9kHz ~ 30MHz	Nov. 20, 2020	Nov. 19, 2021	Conduction (CO02-CB)
EMI Receiver	Agilent	N9038A	MY52260140	9kHz ~ 8.4GHz	May 05, 2021	May 04, 2022	Conduction (CO02-CB)
COND Cable	Woken	Cable	2	0.15MHz ~ 30MHz	Oct. 20, 2020	Oct. 19, 2021	Conduction (CO02-CB)
Software	SPORTON	SENSE	V5.10	-	N.C.R.	N.C.R.	Conduction (CO02-CB)
Pulse Limiter	Schwarzbeck	VTSD 9561F-N	00378	9kHz ~ 30MHz	Mar. 18, 2021	Mar. 17, 2022	Conduction (CO02-CB)
3m Semi Anechoic Chamber NSA	TDK	SAC-3M	03CH01-CB	30 MHz ~ 1 GHz	Jan. 26, 2021	Jan. 25, 2022	Radiation (03CH01-CB)
Loop Antenna	Teseq	HLA 6120	24155	9kHz - 30 MHz	Apr. 14, 2021	Apr. 13, 2022	Radiation (03CH01-CB)
3m Semi Anechoic Chamber VSWR	TDK	SAC-3M	03CH01-CB	1GHz ~18GHz 3m	May 07, 2021	May 06, 2022	Radiation (03CH01-CB)
BILOG ANTENNA with 6dB Attenuator	TESEQ & EMC I	CBL6112D N-6-06	37880 & AT-N0609	20MHz ~ 2GHz	Feb. 22, 2021	Feb. 21, 2022	Radiation (03CH01-CB)
Horn Antenna	ETS-LINDGR EN	3115	00075790	750MHz ~ 18GHz	Nov. 06, 2020	Nov. 05, 2021	Radiation (03CH01-CB)
Horn Antenna	Schwarzbeck	BBHA 9170	BBHA9170252	15GHz ~ 40GHz	Jul. 21, 2020	Jul. 20, 2021	Radiation (03CH01-CB)
Amplifier	EMCI	EMC330N	980332	20MHz ~ 3GHz	Jul. 03, 2020	Jul. 02, 2021	Radiation (03CH01-CB)
Amplifier	EMCI	EMC330N	980332	20MHz ~ 3GHz	Jul. 02, 2021	Jul. 01, 2022	Radiation (03CH01-CB)
Pre-Amplifier	Agilent	8449B	3008A02121	1GHz ~ 26.5GHz	May 20, 2021	May 19, 2022	Radiation (03CH01-CB)
Pre-Amplifier	MITEQ	TTA1840-35-H G	1864479	18GHz ~ 40GHz	Jul. 08, 2020	Jul. 07, 2021	Radiation (03CH01-CB)
Amplifier	-	-	TF-130N-R1	18GHz ~ 40GHz	Jun.15, 2021	Jun. 14, 2022	Radiation (03CH01-CB)
Spectrum Analyzer	R&S	FSP40	100056	9kHz ~ 40GHz	May 03, 2021	May 02, 2022	Radiation (03CH01-CB)
EMI Test Receiver	R&S	ESR7	102171	9kHz ~ 7GHz	Jul. 01, 2020	Jun. 30, 2021	Radiation (03CH01-CB)
EMI Test Receiver	R&S	ESCS	826547/017	9kHz ~ 2.75GHz	Jun. 21, 2021	Jun. 20, 2022	Radiation (03CH01-CB)
RF Cable-low	Woken	RG402	Low Cable-16+17	30 MHz ~ 1 GHz	Oct. 05, 2020	Oct. 04, 2021	Radiation (03CH01-CB)



Instrument	Brand	Model No.	Serial No.	Characteristics	Calibration Date	Calibration Due Date	Remark
RF Cable-low	Woken	RG402	Low Cable-16+17	30 MHz ~ 1 GHz	Oct. 04, 2021	Oct. 03, 2022	Radiation (03CH01-CB)
RF Cable-high	Woken	RG402	High Cable-16	1 GHz ~ 18 GHz	Oct. 05, 2020	Oct. 04, 2021	Radiation (03CH01-CB)
RF Cable-high	Woken	RG402	High Cable-16+17	1 GHz ~ 18 GHz	Oct. 05, 2020	Oct. 04, 2021	Radiation (03CH01-CB)
RF Cable-high	Woken	RG402	High Cable-40G#1	18GHz ~ 40 GHz	Jul. 16, 2020	Jul. 15, 2021	Radiation (03CH01-CB)
RF Cable-high	Woken	RG402	High Cable-40G#2	18GHz ~ 40 GHz	Jul. 16, 2020	Jul. 15, 2021	Radiation (03CH01-CB)
Test Software	SPORTON	SENSE	V5.10	-	N.C.R.	N.C.R.	Radiation (03CH01-CB)
Spectrum analyzer	R&S	FSV40	101027	9kHz~40GHz	Jul. 27, 2020	Jul. 26, 2021	Conduction (TH02-CB)
Power Sensor	Anritsu	MA2411B	1126203	300MHz~40GHz	Sep. 17, 2020	Sep. 16, 2021	Conduction (TH02-CB)
Power Meter	Anritsu	ML2495A	1210004	300MHz~40GHz	Sep. 17, 2020	Sep. 16, 2021	Conduction (TH02-CB)
RF Cable-high	Woken	RG402	High Cable-01	1 GHz – 18 GHz	Oct. 05, 2020	Oct. 04, 2021	Conduction (TH02-CB)
RF Cable-high	Woken	RG402	High Cable-02	1 GHz – 18 GHz	Oct. 05, 2020	Oct. 04, 2021	Conduction (TH02-CB)
RF Cable-high	Woken	RG402	High Cable-03	1 GHz – 18 GHz	Oct. 05, 2020	Oct. 04, 2021	Conduction (TH02-CB)
RF Cable-high	Woken	RG402	High Cable-04	1 GHz – 18 GHz	Oct. 05, 2020	Oct. 04, 2021	Conduction (TH02-CB)
RF Cable-high	Woken	RG402	High Cable-05	1 GHz – 18 GHz	Oct. 05, 2020	Oct. 04, 2021	Conduction (TH02-CB)
Test Software	SPORTON	SENSE	V5.10	-	N.C.R.	N.C.R.	Conduction (TH02-CB)

Note: Calibration Interval of instruments listed above is one year.

N.C.R. means Non-Calibration required.



Summary

Mode	Result	Type	Freq (Hz)	Level (dBuV)	Limit (dBuV)	Margin (dB)	Condition
Mode 4	Pass	AV	424.5k	37.99	47.36	-9.37	Line

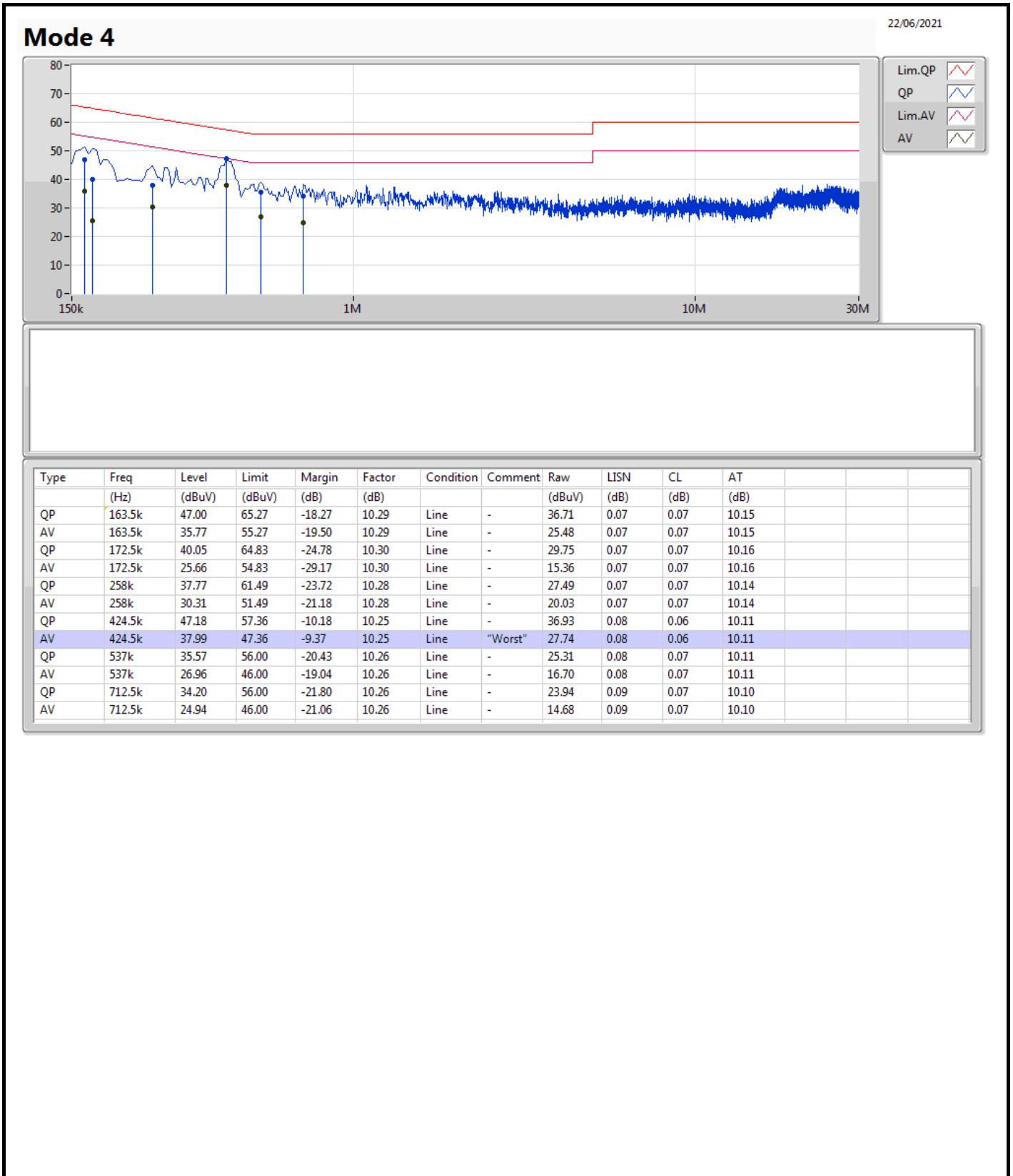

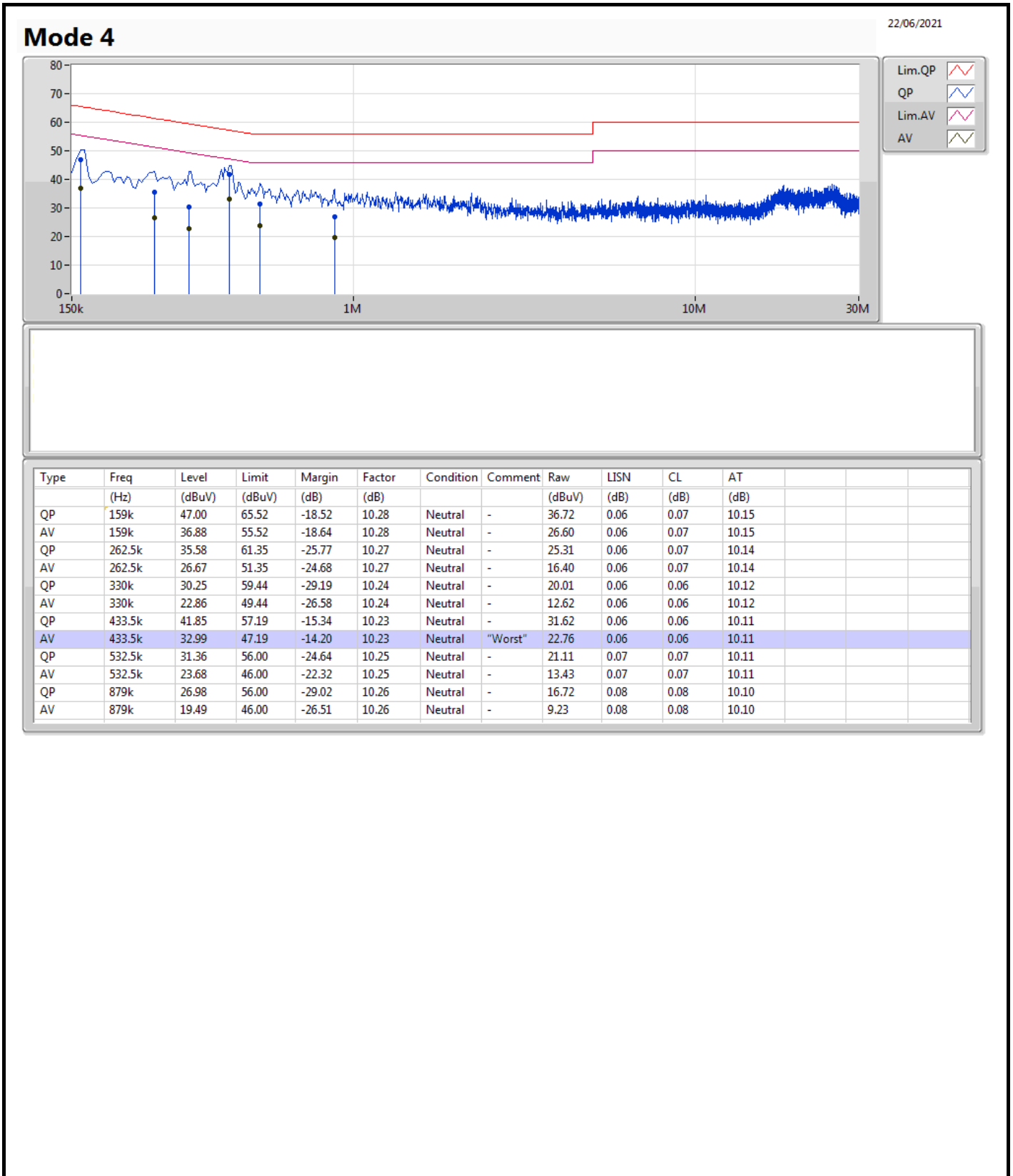



**For Radio 4
Summary**

Mode	Max-N dB (Hz)	Max-OBW (Hz)	ITU-Code	Min-N dB (Hz)	Min-OBW (Hz)
2.4-2.4835GHz	-	-	-	-	-
802.15.4	1.605M	2.601M	2M60D1D	1.586M	2.556M

Max-N dB = Maximum 6dB down bandwidth; **Max-OBW** = Maximum 99% occupied bandwidth;
Min-N dB = Minimum 6dB down bandwidth; **Min-OBW** = Minimum 99% occupied bandwidth;

Result

Mode	Result	Limit (Hz)	Port 1-N dB (Hz)	Port 1-OBW (Hz)
802.15.4	-	-	-	-
2405MHz	Pass	500k	1.601M	2.601M
2440MHz	Pass	500k	1.586M	2.556M
2475MHz	Pass	500k	1.605M	2.564M
2480MHz	Pass	500k	1.59M	2.582M

Port X-N dB = Port X 6dB down bandwidth; **Port X-OBW** = Port X 99% occupied bandwidth;

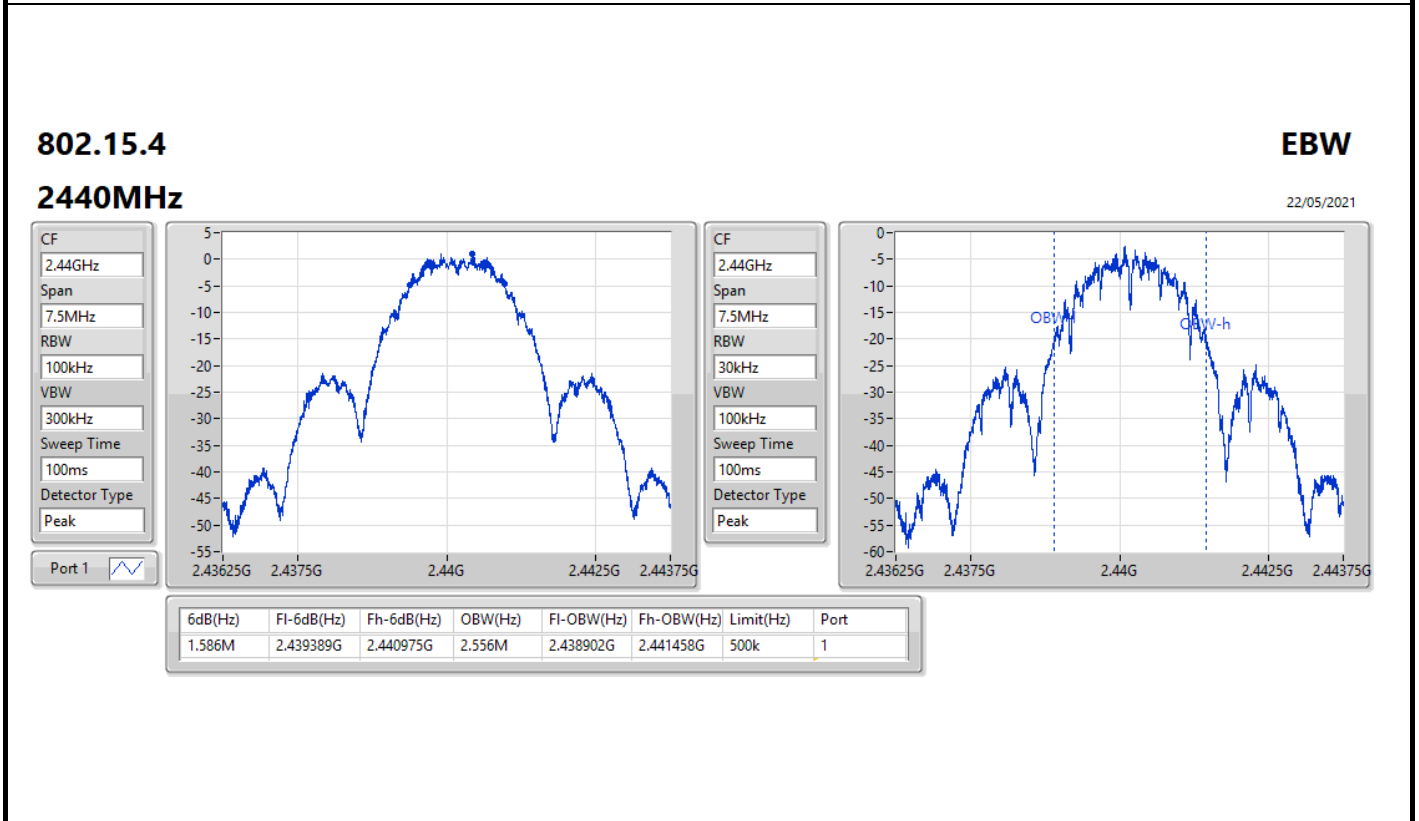
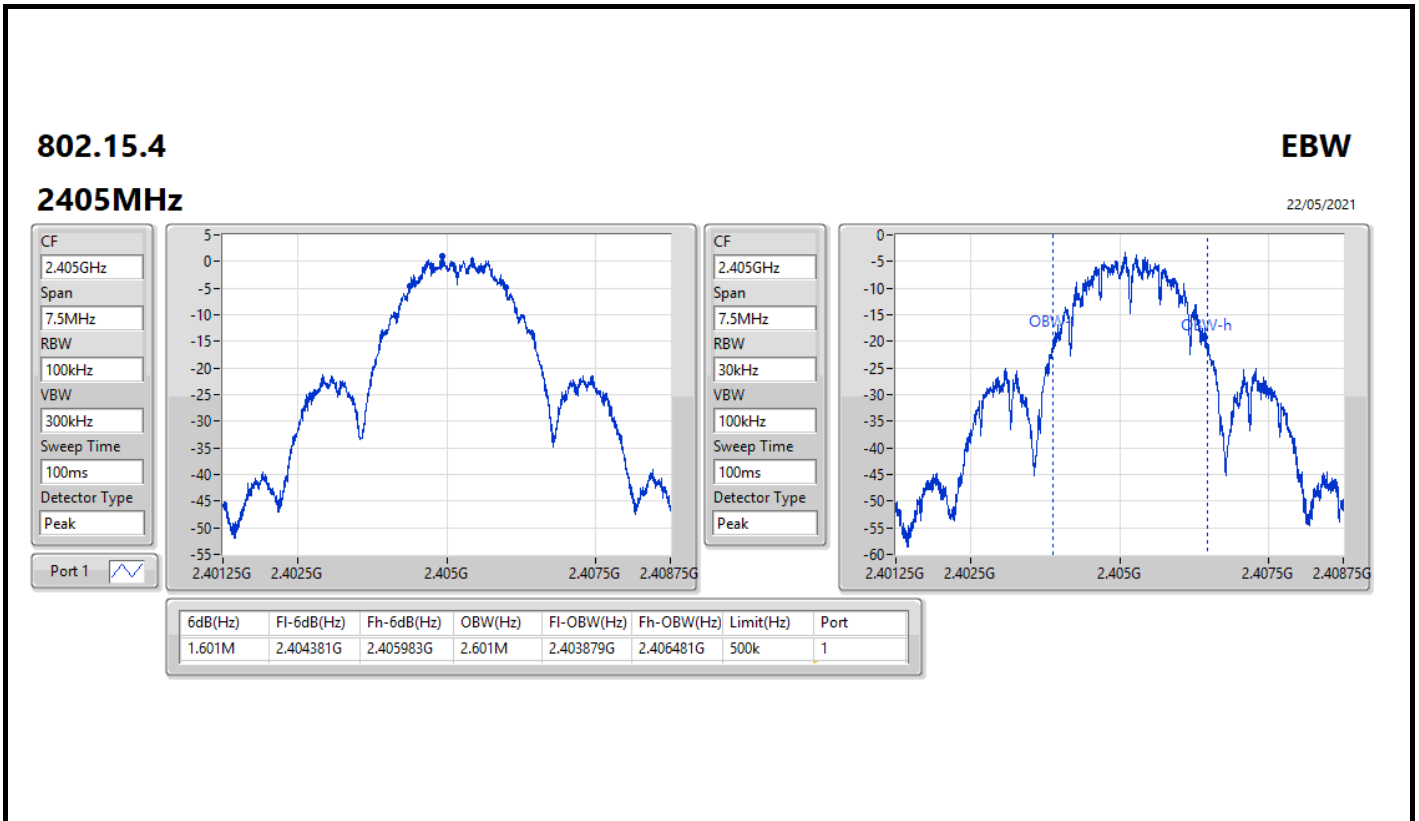

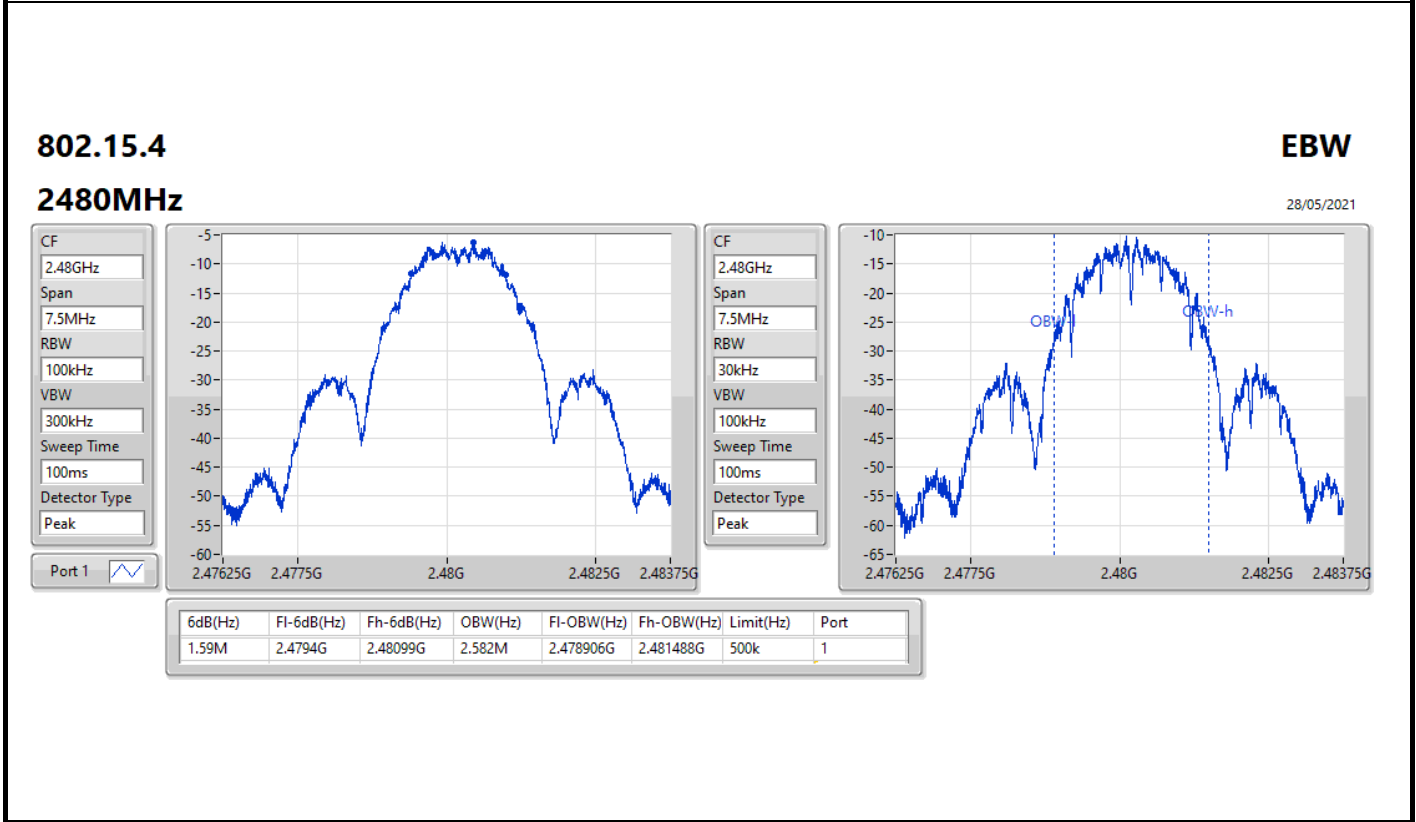
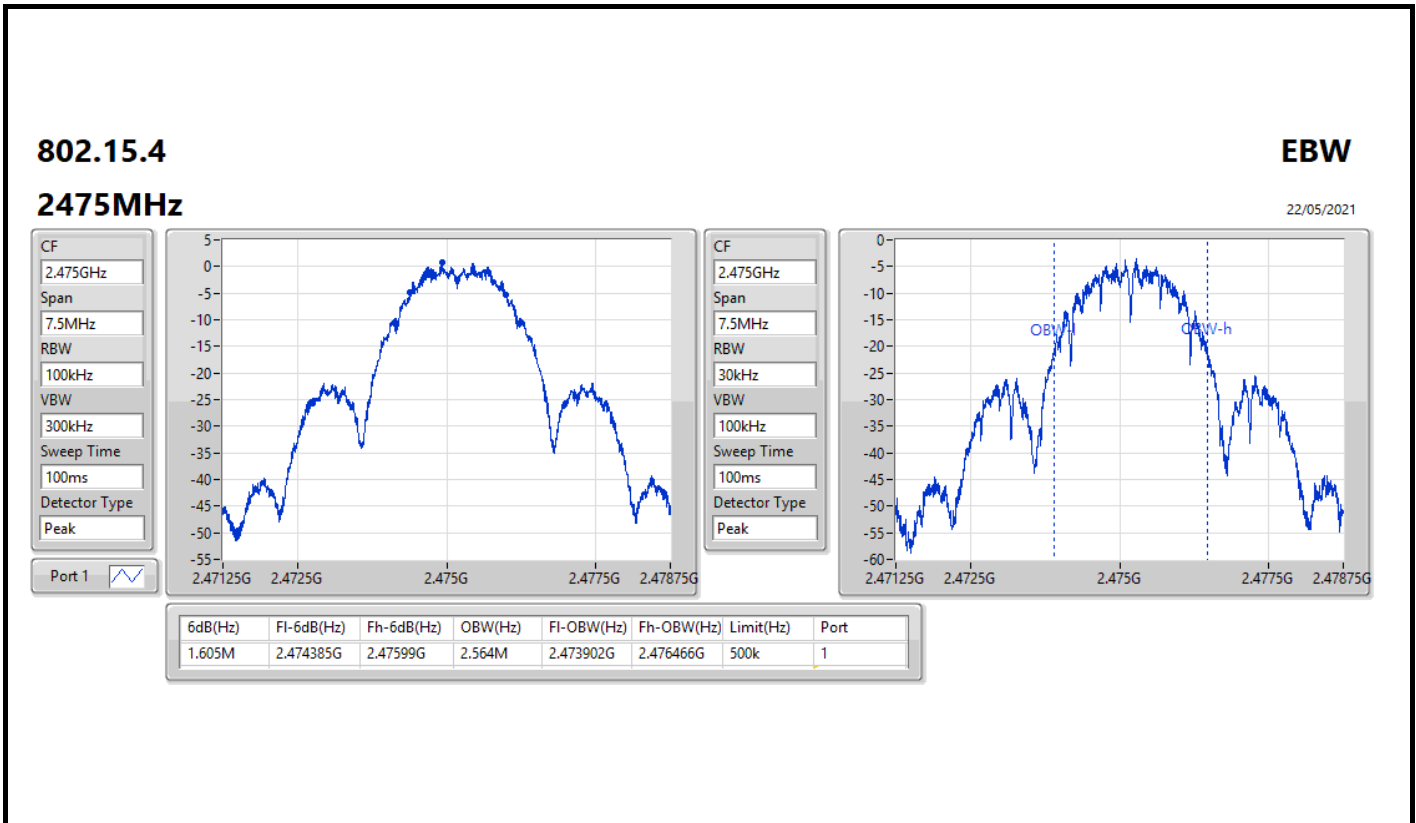



**For Radio 4
Summary**

Mode	Power (dBm)	Power (W)
2.4-2.4835GHz	-	-
802.15.4	4.47	0.00280



Result

Mode	Result	Gain (dBi)	Power (dBm)	Power Limit (dBm)
802.15.4	-	-	-	-
2405MHz	Pass	5.26	4.47	30.00
2440MHz	Pass	5.26	4.10	30.00
2475MHz	Pass	5.26	3.89	30.00
2480MHz	Pass	5.26	-3.18	30.00

DG = Directional Gain; **Port X** = Port X output power



**For Radio 4
Summary**

Mode	PD (dBm/RBW)
2.4-2.4835GHz	-
802.15.4	-11.64

RBW=3 kHz.



Result

Mode	Result	Gain (dBi)	PD (dBm/RBW)	PD Limit (dBm/RBW)
802.15.4	-	-	-	-
2405MHz	Pass	5.26	-11.64	8.00
2440MHz	Pass	5.26	-12.26	8.00
2475MHz	Pass	5.26	-12.74	8.00
2480MHz	Pass	5.26	-19.95	8.00

DG = Directional Gain; RBW=3 kHz;

PD = trace bin-by-bin of each transmits port summing can be performed maximum power density; Port X = Port X power density;

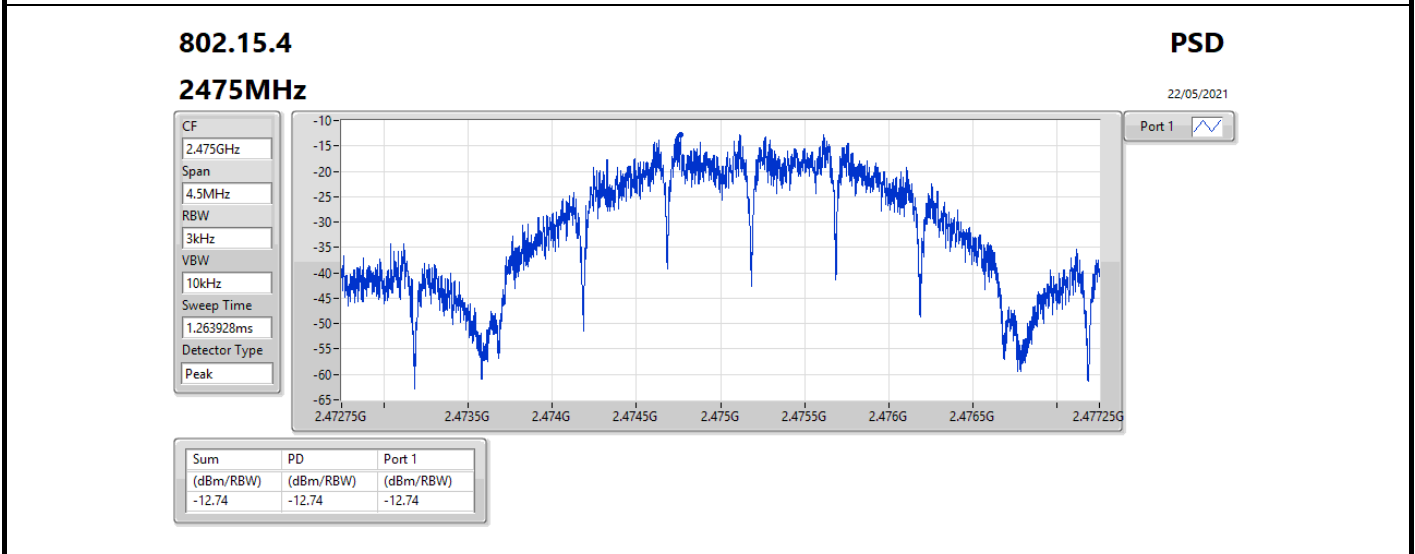
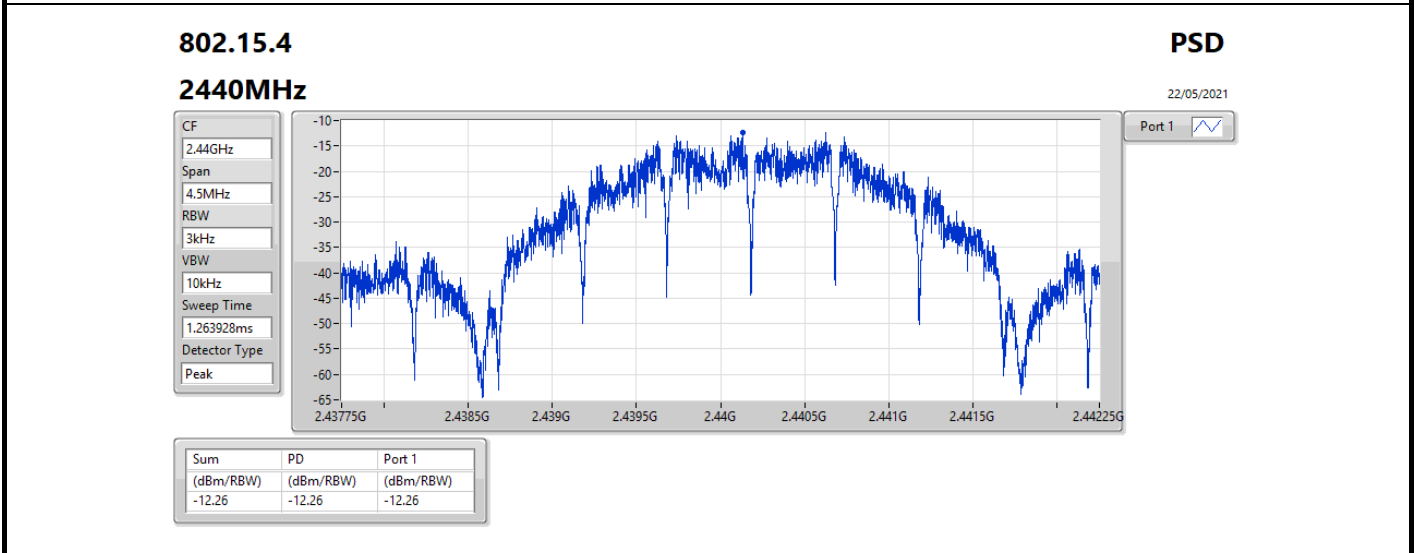
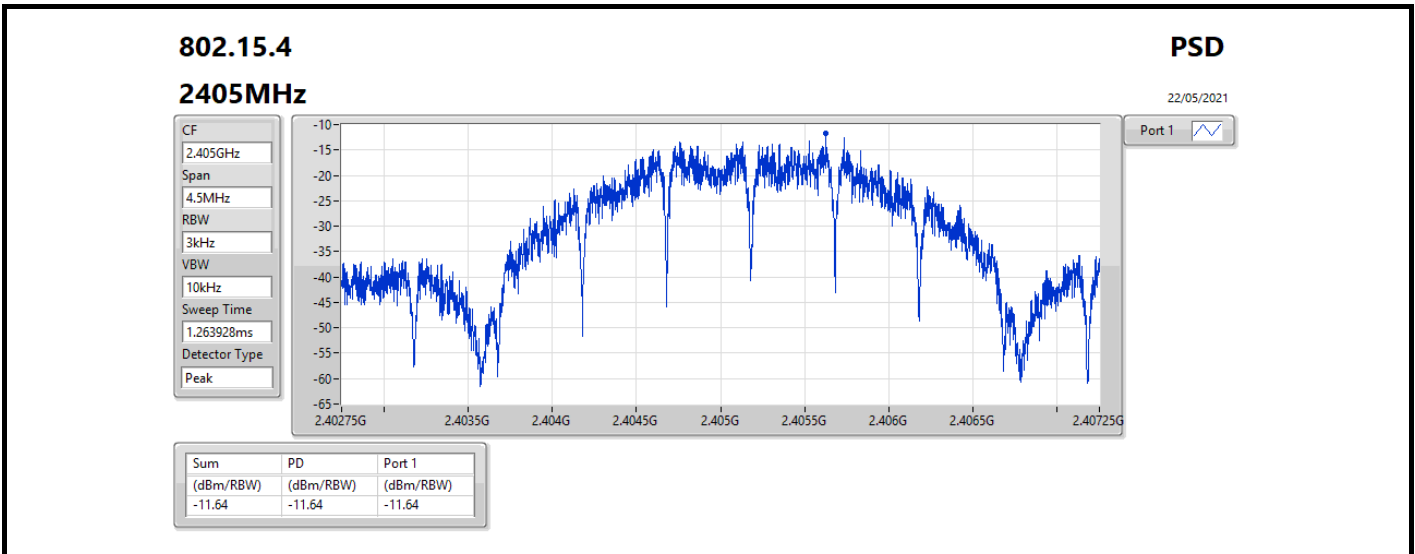

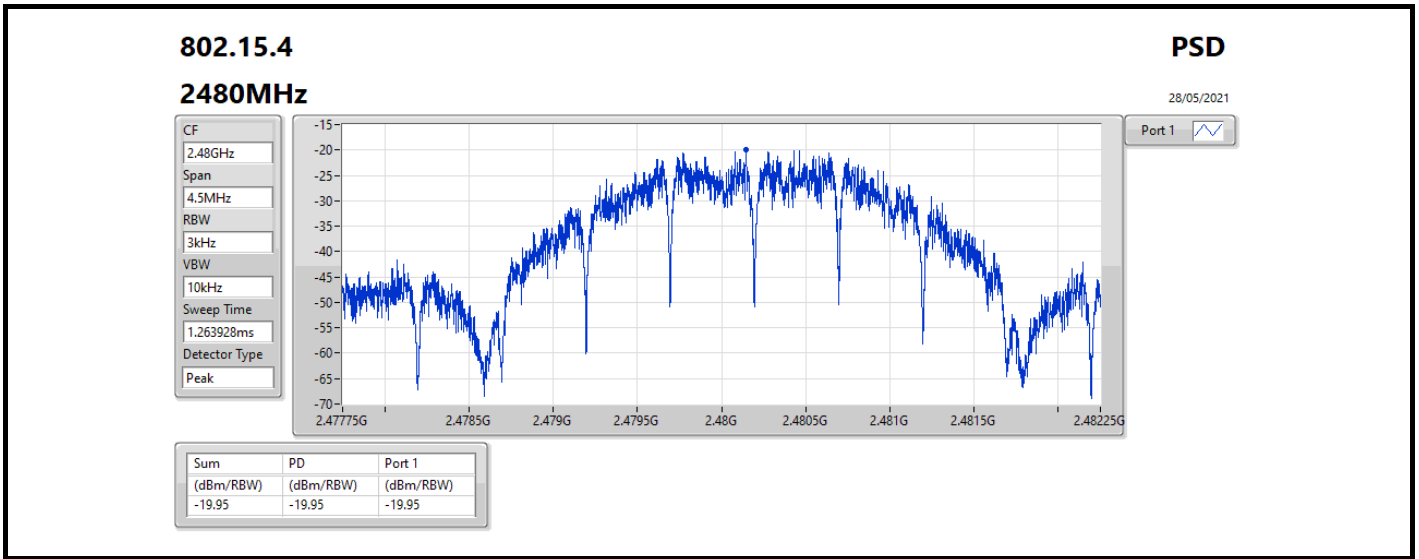



For Radio 4
Summary

Mode	Result	Ref (Hz)	Ref (dBm)	Limit (dBm)	Freq (Hz)	Level (dBm)	Freq (Hz)	Level (dBm)	Freq (Hz)	Level (dBm)	Freq (Hz)	Level (dBm)	Freq (Hz)	Level (dBm)	Port
2.4-2.4835GHz	-	-	-	-	-	-	-	-	-	-	-	-	-	-	-
802.15.4	Pass	2.40543G	0.86	-29.14	58.79M	-66.67	2.3926G	-66.90	2.4835G	-48.81	2.48351G	-48.64	5.17496G	-46.31	1



Result

Mode	Result	Ref (Hz)	Ref (dBm)	Limit (dBm)	Freq (Hz)	Level (dBm)	Freq (Hz)	Level (dBm)	Freq (Hz)	Level (dBm)	Freq (Hz)	Level (dBm)	Freq (Hz)	Level (dBm)	Port
802.15.4	-	-	-	-	-	-	-	-	-	-	-	-	-	-	-
2405MHz	Pass	2.40543G	0.86	-29.14	2.30921G	-65.01	2.39995G	-48.76	2.4G	-49.72	2.50114G	-62.51	9.62364G	-53.70	1
2440MHz	Pass	2.40543G	0.86	-29.14	692.7M	-68.00	2.39298G	-64.63	2.4G	-65.02	2.48814G	-63.11	9.76143G	-57.26	1
2475MHz	Pass	2.40543G	0.86	-29.14	503.23M	-67.89	2.39343G	-64.80	2.4835G	-57.08	2.48431G	-57.11	9.90204G	-59.02	1
2480MHz	Pass	2.40543G	0.86	-29.14	58.79M	-66.67	2.3926G	-66.90	2.4835G	-48.81	2.48351G	-48.64	5.17496G	-46.31	1

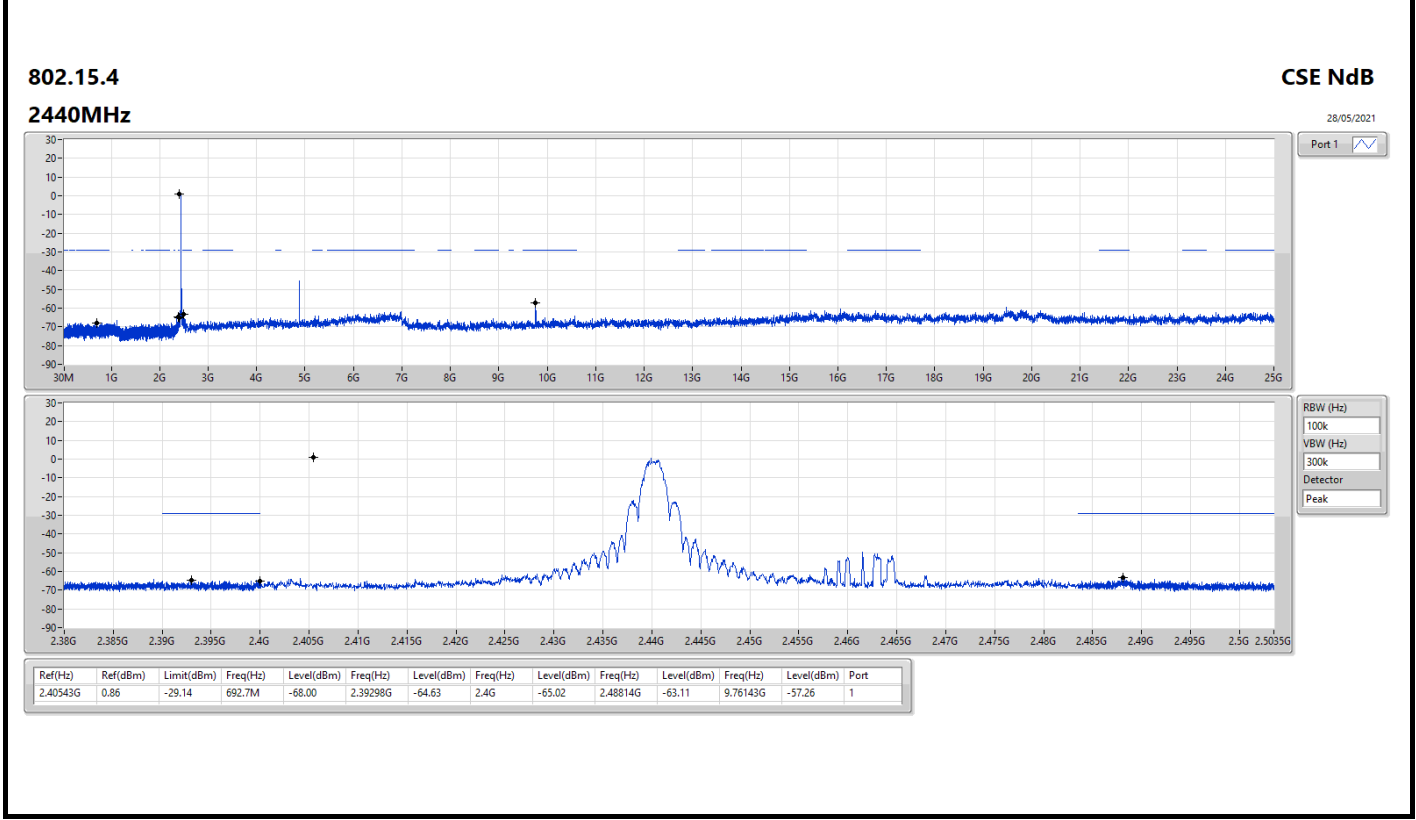
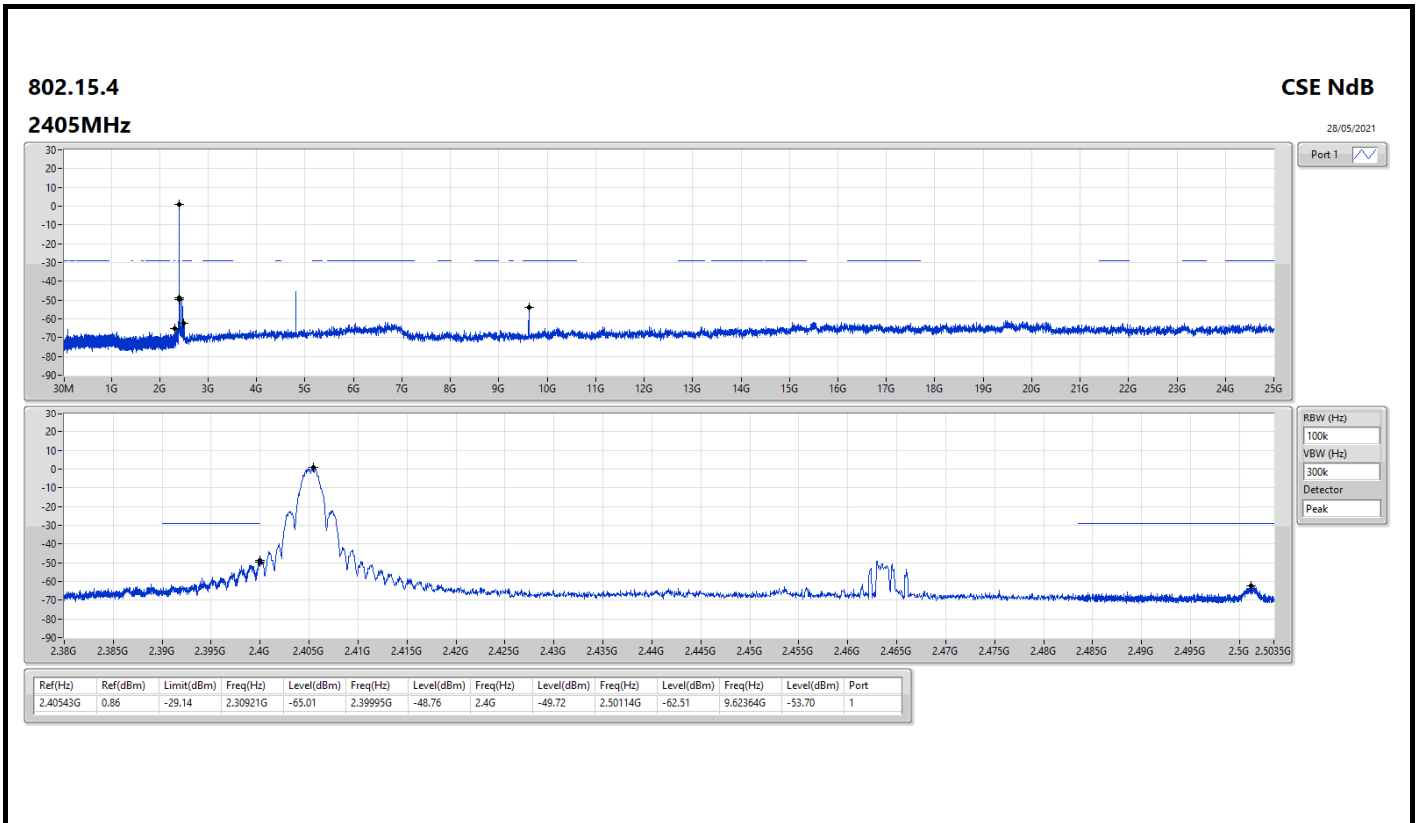

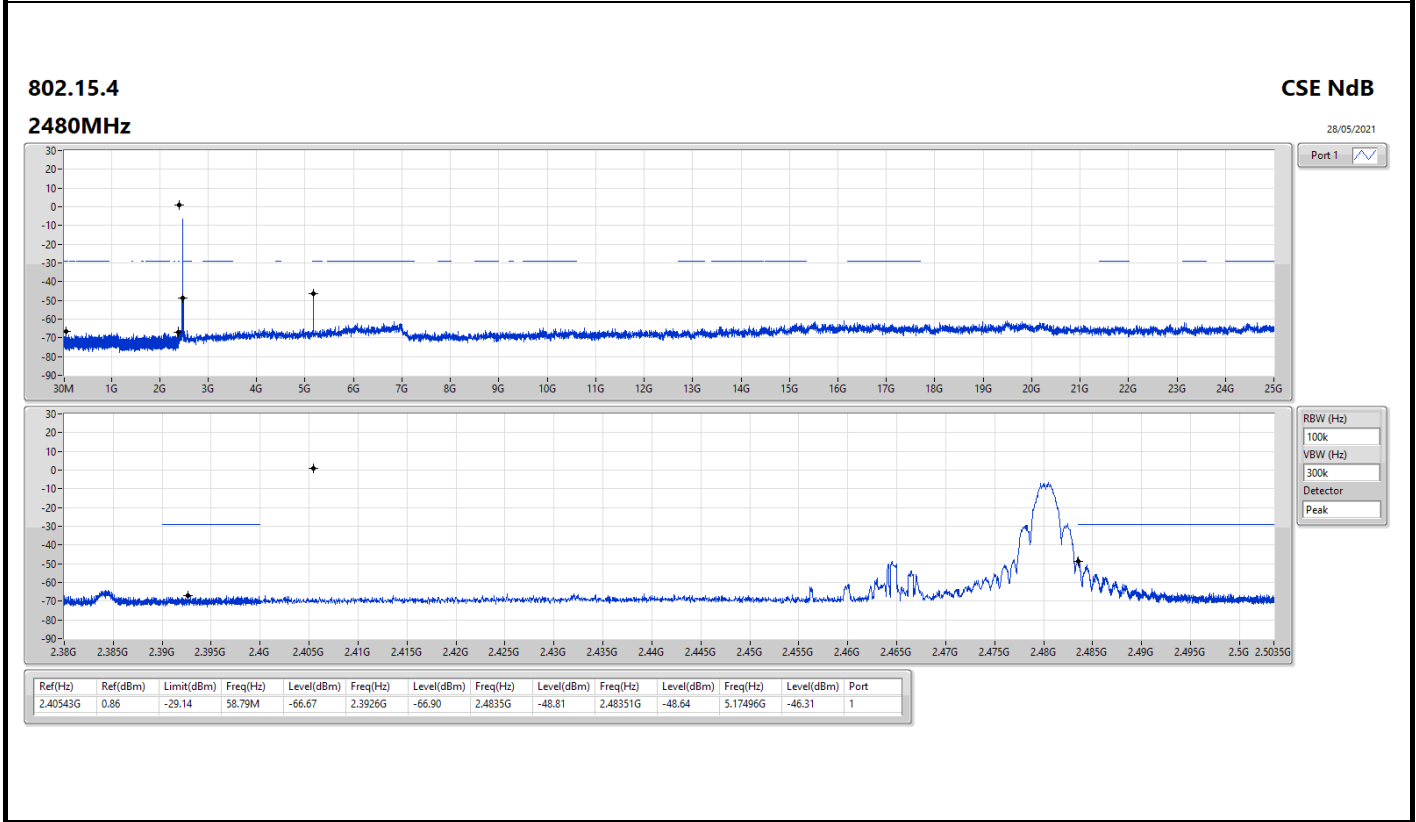
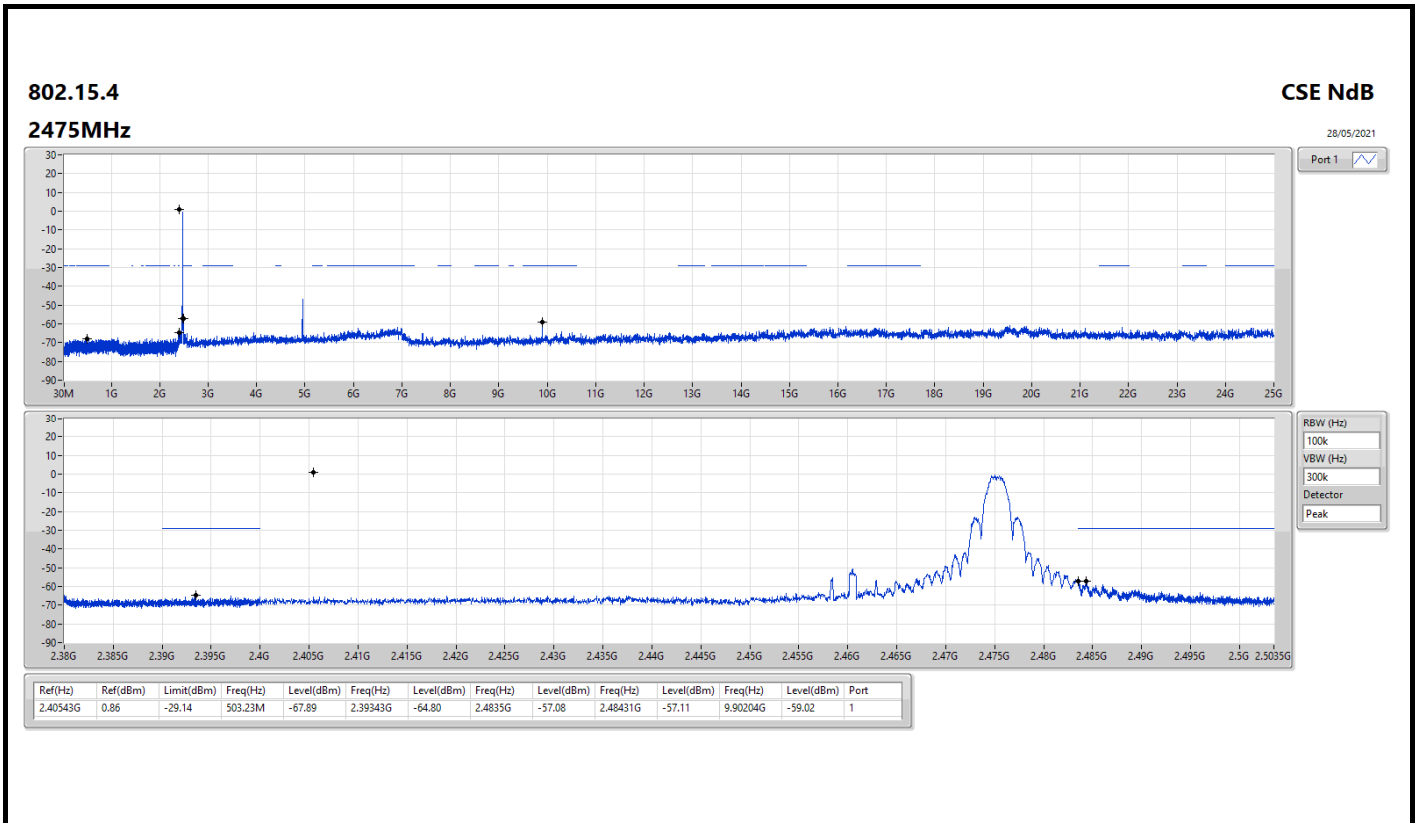



Summary

Mode	Result	Type	Freq (Hz)	Level (dBuV/m)	Limit (dBuV/m)	Margin (dB)	Condition
Mode 2	Pass	PK	33.88M	36.88	40.00	-3.12	Vertical

Mode 2

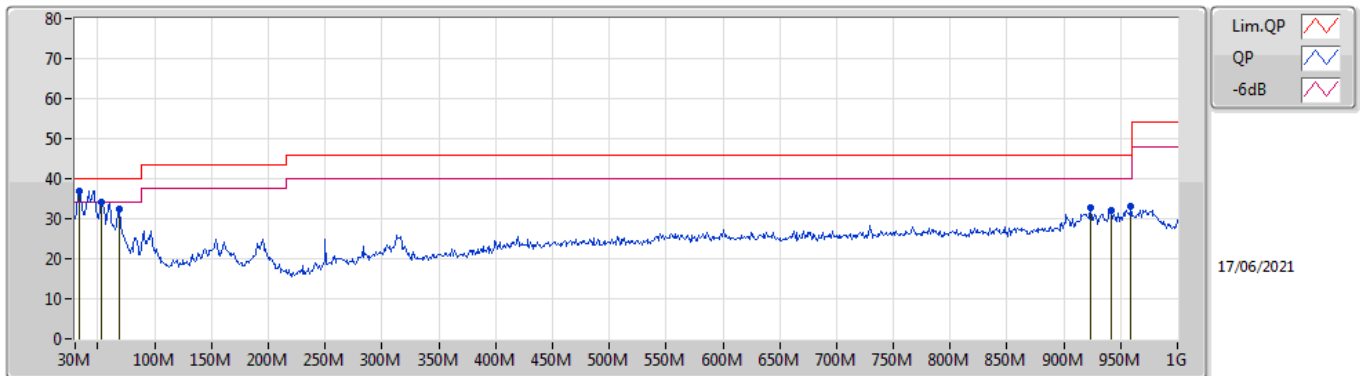

Type	Freq (Hz)	Level (dBuV/m)	Limit (dBuV/m)	Margin (dB)	Factor (dB/m)	Dist (m)	Condition	Azimuth (°)	Height (m)	Comment	Raw (dBuV/m)	AF (dB/m)	CL (dB)	PA (dB)
PK	33.88M	36.88	40.00	-3.12	-9.30	3	Vertical	218	1.00	"Worst"	46.18	21.56	0.58	31.44
PK	53.28M	34.25	40.00	-5.75	-18.87	3	Vertical	212	1.00	-	53.12	12.20	0.70	31.77
PK	68.8M	32.26	40.00	-7.74	-19.68	3	Vertical	334	1.25	-	51.94	11.36	0.78	31.82
PK	923.37M	32.74	46.00	-13.26	-4.42	3	Vertical	100	1.00	-	37.16	25.40	2.65	32.47
PK	941.8M	32.18	46.00	-13.82	-4.13	3	Vertical	100	1.00	-	36.31	25.64	2.68	32.45
PK	959.26M	33.00	46.00	-13.00	-3.87	3	Vertical	147	1.25	-	36.87	25.89	2.70	32.46

Mode 2

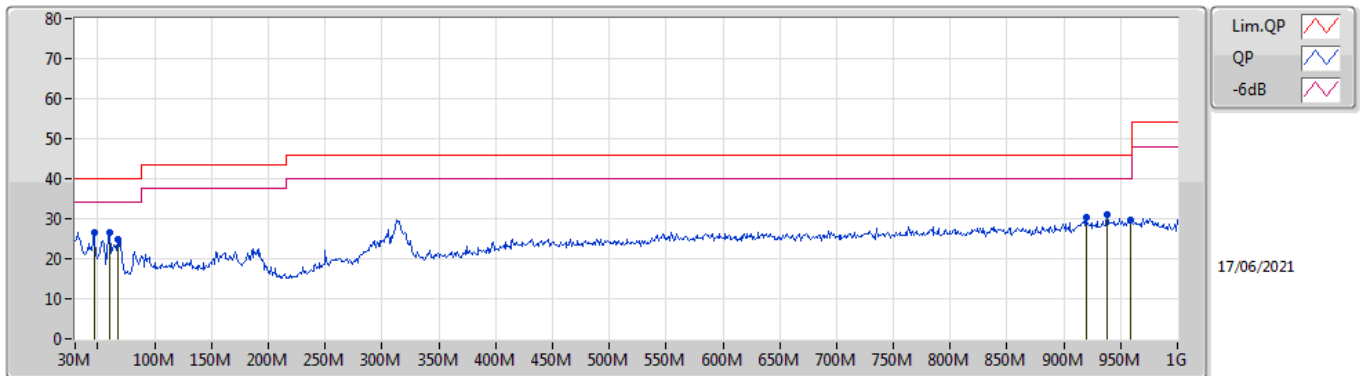

Type	Freq (Hz)	Level (dBuV/m)	Limit (dBuV/m)	Margin (dB)	Factor (dB/m)	Dist (m)	Condition	Azimuth (°)	Height (m)	Comment	Raw (dBuV/m)	AF (dB/m)	CL (dB)	PA (dB)
PK	46.49M	26.66	40.00	-13.34	-16.34	3	Horizontal	240	1.00	-	43.00	14.76	0.63	31.73
PK	60.07M	26.72	40.00	-13.28	-19.47	3	Horizontal	301	1.00	"Worst"	46.19	11.51	0.80	31.78
PK	67.83M	24.75	40.00	-15.25	-19.79	3	Horizontal	72	1.25	-	44.54	11.26	0.76	31.81
PK	919.49M	30.20	46.00	-15.80	-4.45	3	Horizontal	243	2.00	-	34.65	25.39	2.64	32.48
PK	937.92M	30.98	46.00	-15.02	-4.17	3	Horizontal	85	1.25	-	35.15	25.60	2.68	32.45
PK	958.29M	29.58	46.00	-16.42	-3.87	3	Horizontal	115	1.00	-	33.45	25.88	2.70	32.45



For Radio 4
Summary

Mode	Result	Type	Freq (Hz)	Level (dBuV/m)	Limit (dBuV/m)	Margin (dB)	Dist (m)	Condition	Azimuth (°)	Height (m)	Comments
2.4-2.4835GHz	-	-	-	-	-	-	-	-	-	-	-
802.15.4	Pass	AV	2.4835G	52.45	54.00	-1.55	3	Horizontal	312	1.69	-

802.15.4

22/05/2021

2405MHz_TX

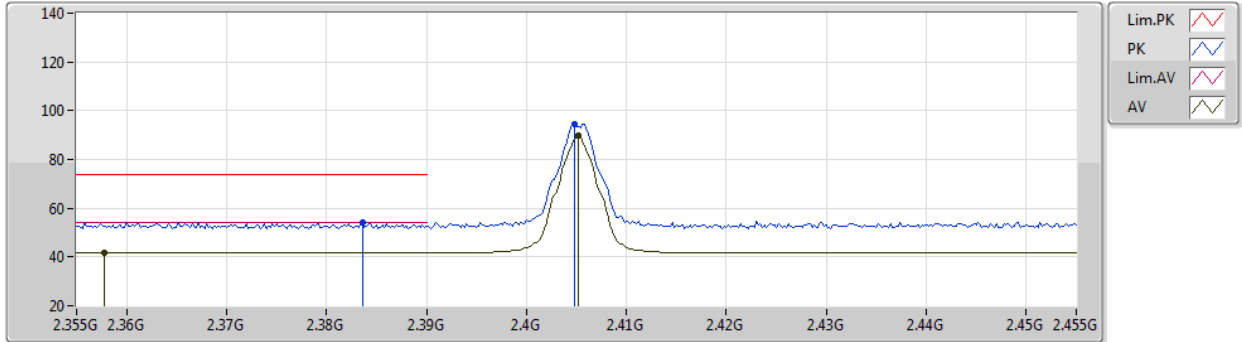

EUT Y_1TX
Setting 5
01-C-G-2

Type	Freq (Hz)	Level (dBuV/m)	Limit (dBuV/m)	Margin (dB)	Raw (dBuV)	Dist (m)	Condition	Azimuth (°)	Height (m)	Comment	AF (dB)	CL (dB)	PA (dB)
PK	2.3836G	54.27	74.00	-19.73	24.72	3	Vertical	37	2.87	-	27.37	2.18	-
AV	2.3578G	41.77	54.00	-12.23	12.29	3	Vertical	37	2.87	-	27.32	2.16	-
PK	2.4048G	94.48	Inf	-Inf	64.87	3	Vertical	37	2.87	-	27.41	2.20	-
AV	2.4052G	89.96	Inf	-Inf	60.34	3	Vertical	37	2.87	-	27.41	2.21	-

802.15.4

22/05/2021

2405MHz_TX

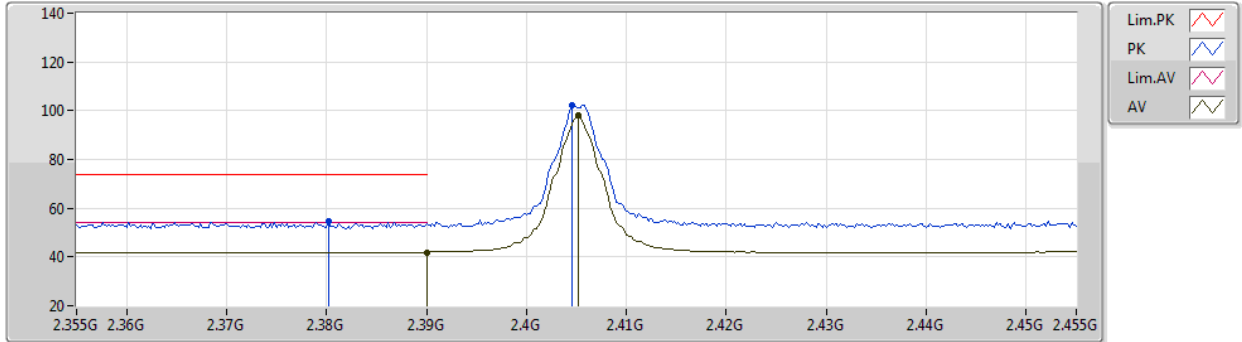

EUT Y_1TX
Setting 5
01-C-G-2

Type	Freq (Hz)	Level (dBuV/m)	Limit (dBuV/m)	Margin (dB)	Raw (dBuV)	Dist (m)	Condition	Azimuth (°)	Height (m)	Comment	AF (dB)	CL (dB)	PA (dB)
PK	2.3802G	54.55	74.00	-19.45	25.01	3	Horizontal	319	2.07	-	27.36	2.18	-
AV	2.39G	41.97	54.00	-12.03	12.40	3	Horizontal	319	2.07	-	27.38	2.19	-
PK	2.4046G	102.42	Inf	-Inf	72.81	3	Horizontal	319	2.07	-	27.41	2.20	-
AV	2.4052G	98.02	Inf	-Inf	68.40	3	Horizontal	319	2.07	-	27.41	2.21	-

802.15.4

22/05/2021

2405MHz_TX

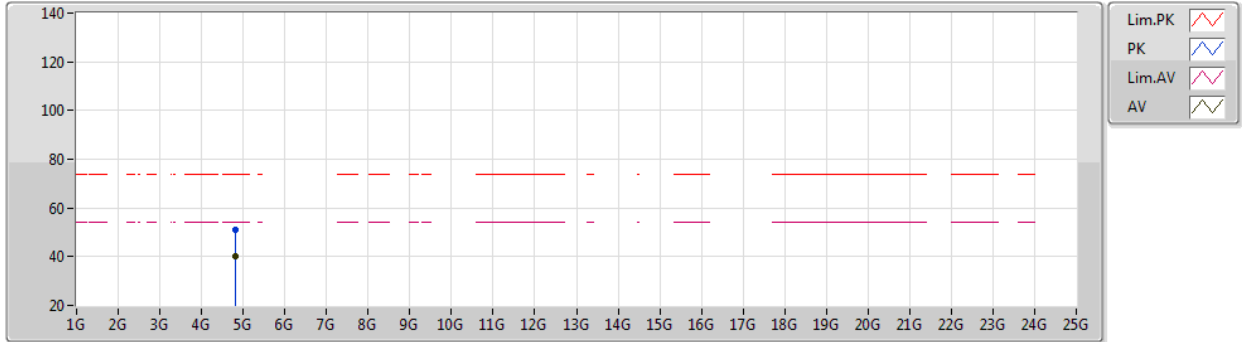

EUT_V_1TX
Setting 5
01-C-G-2

Type	Freq (Hz)	Level (dBuV/m)	Limit (dBuV/m)	Margin (dB)	Raw (dBuV)	Dist (m)	Condition	Azimuth (°)	Height (m)	Comment	AF (dB)	CL (dB)	PA (dB)
PK	4.80943G	51.13	74.00	-22.87	46.96	3	Vertical	333	1.99	-	32.16	5.00	32.99
AV	4.80935G	40.19	54.00	-13.81	36.02	3	Vertical	333	1.99	-	32.16	5.00	32.99

802.15.4

22/05/2021

2405MHz_TX

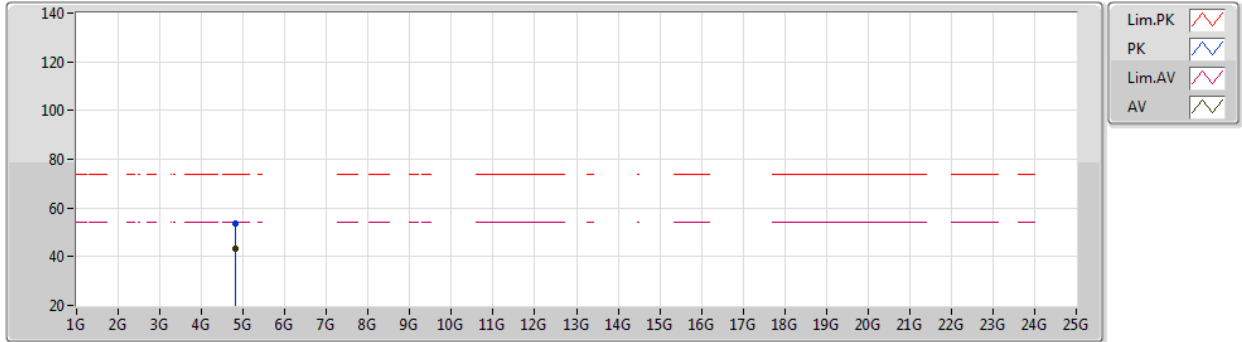

EUT Y_1TX
Setting 5
01-C-G-2

Type	Freq (Hz)	Level (dBuV/m)	Limit (dBuV/m)	Margin (dB)	Raw (dBuV)	Dist (m)	Condition	Azimuth (°)	Height (m)	Comment	AF (dB)	CL (dB)	PA (dB)
PK	4.80928G	53.53	74.00	-20.47	49.36	3	Horizontal	350	1.43	-	32.16	5.00	32.99
AV	4.80933G	43.28	54.00	-10.72	39.11	3	Horizontal	350	1.43	-	32.16	5.00	32.99

802.15.4

2440MHz_TX

22/05/2021

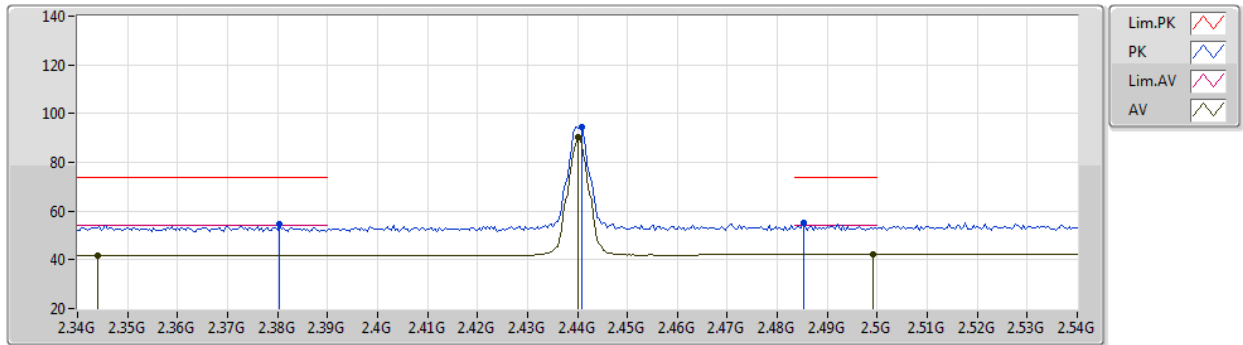

EUT Y_1TX
Setting 5
01-C-G-2

Type	Freq (Hz)	Level (dBuV/m)	Limit (dBuV/m)	Margin (dB)	Raw (dBuV)	Dist (m)	Condition	Azimuth (°)	Height (m)	Comment	AF (dB)	CL (dB)	PA (dB)
PK	2.3804G	54.58	74.00	-19.42	25.04	3	Vertical	34	3.00	-	27.36	2.18	-
AV	2.344G	41.90	54.00	-12.10	12.46	3	Vertical	34	3.00	-	27.30	2.14	-
PK	2.4408G	94.61	Inf	-Inf	64.89	3	Vertical	34	3.00	-	27.48	2.24	-
AV	2.44G	90.18	Inf	-Inf	60.46	3	Vertical	34	3.00	-	27.48	2.24	-
PK	2.4852G	55.06	74.00	-18.94	25.06	3	Vertical	34	3.00	-	27.71	2.29	-
AV	2.4992G	42.27	54.00	-11.73	12.17	3	Vertical	34	3.00	-	27.80	2.30	-

802.15.4

22/05/2021

2440MHz_TX

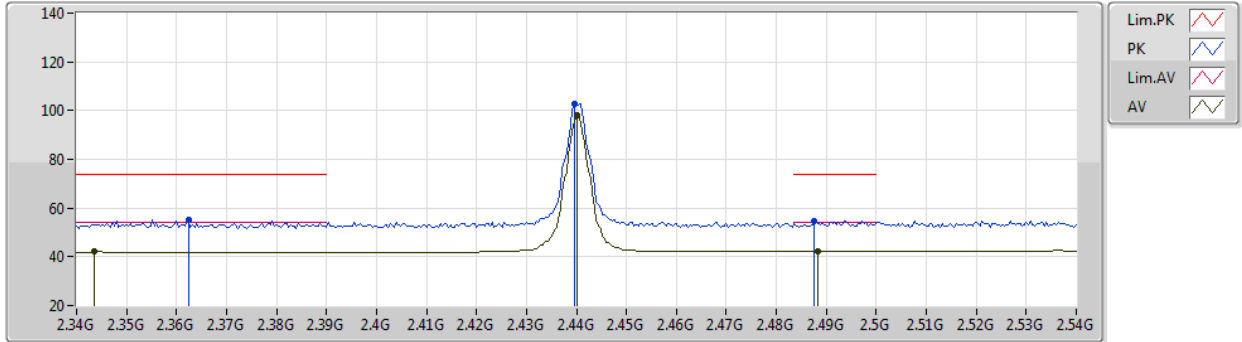

EUT Y_1TX
Setting 5
01-C-G-2

Type	Freq (Hz)	Level (dBuV/m)	Limit (dBuV/m)	Margin (dB)	Raw (dBuV)	Dist (m)	Condition	Azimuth (°)	Height (m)	Comment	AF (dB)	CL (dB)	PA (dB)
PK	2.3624G	55.20	74.00	-18.80	25.72	3	Horizontal	319	2.24	-	27.32	2.16	-
AV	2.3436G	42.14	54.00	-11.86	12.70	3	Horizontal	319	2.24	-	27.30	2.14	-
PK	2.4396G	102.59	Inf	-Inf	72.87	3	Horizontal	319	2.24	-	27.48	2.24	-
AV	2.44G	98.15	Inf	-Inf	68.43	3	Horizontal	319	2.24	-	27.48	2.24	-
PK	2.4876G	54.66	74.00	-19.34	24.64	3	Horizontal	319	2.24	-	27.73	2.29	-
AV	2.4884G	42.35	54.00	-11.65	12.33	3	Horizontal	319	2.24	-	27.73	2.29	-

802.15.4

22/05/2021

2440MHz_TX

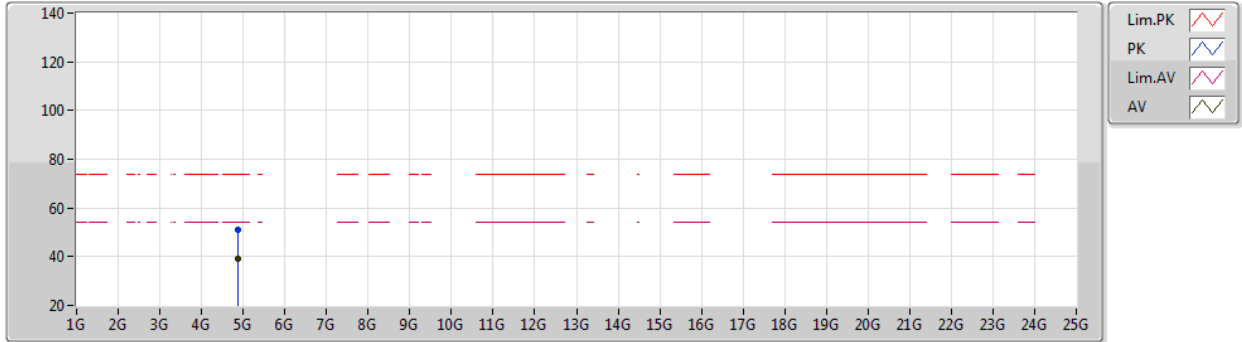

EUT Y_1TX
Setting 5
01-C-G-2

Type	Freq (Hz)	Level (dBuV/m)	Limit (dBuV/m)	Margin (dB)	Raw (dBuV)	Dist (m)	Condition	Azimuth (°)	Height (m)	Comment	AF (dB)	CL (dB)	PA (dB)
PK	4.88129G	50.82	74.00	-23.18	46.30	3	Vertical	336	2.16	-	32.46	5.04	32.98
AV	4.87937G	39.29	54.00	-14.71	34.77	3	Vertical	336	2.16	-	32.46	5.04	32.98

802.15.4

22/05/2021

2440MHz_TX

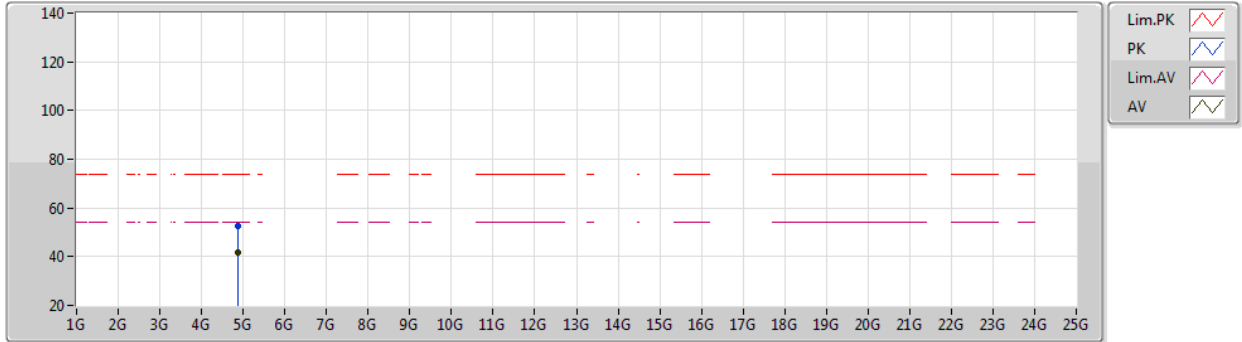

EUT_V_1TX
Setting 5
01-C-G-2

Type	Freq (Hz)	Level (dBuV/m)	Limit (dBuV/m)	Margin (dB)	Raw (dBuV)	Dist (m)	Condition	Azimuth (°)	Height (m)	Comment	AF (dB)	CL (dB)	PA (dB)
PK	4.88117G	52.57	74.00	-21.43	48.05	3	Horizontal	344	1.60	-	32.46	5.04	32.98
AV	4.87938G	41.74	54.00	-12.26	37.22	3	Horizontal	344	1.60	-	32.46	5.04	32.98

802.15.4

2475MHz_TX

22/05/2021

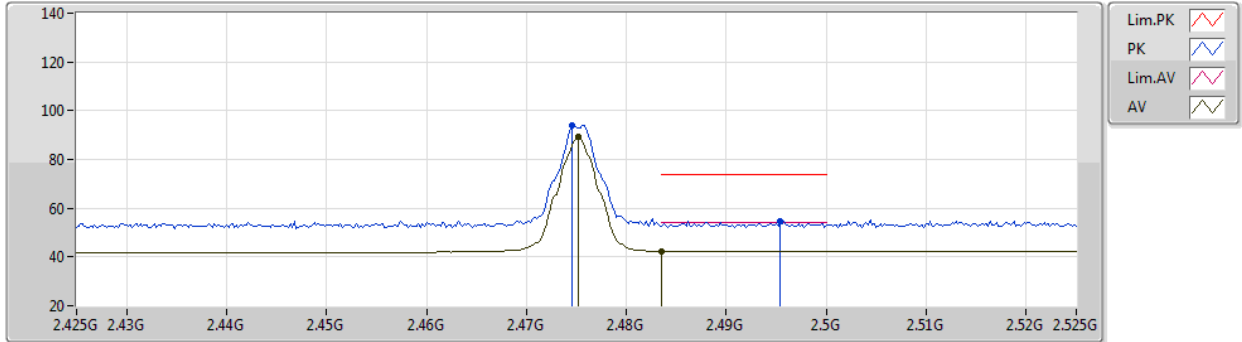

EUT Y_1TX
Setting 5
01-C-G-2

Type	Freq (Hz)	Level (dBuV/m)	Limit (dBuV/m)	Margin (dB)	Raw (dBuV)	Dist (m)	Condition	Azimuth (°)	Height (m)	Comment	AF (dB)	CL (dB)	PA (dB)
PK	2.4746G	93.97	Inf	-Inf	64.05	3	Vertical	16	1.62	-	27.65	2.27	-
AV	2.4752G	89.45	Inf	-Inf	59.52	3	Vertical	16	1.62	-	27.65	2.28	-
PK	2.4954G	54.85	74.00	-19.15	24.78	3	Vertical	16	1.62	-	27.77	2.30	-
AV	2.4835G	42.31	54.00	-11.69	12.33	3	Vertical	16	1.62	-	27.70	2.28	-

802.15.4

22/05/2021

2475MHz_TX

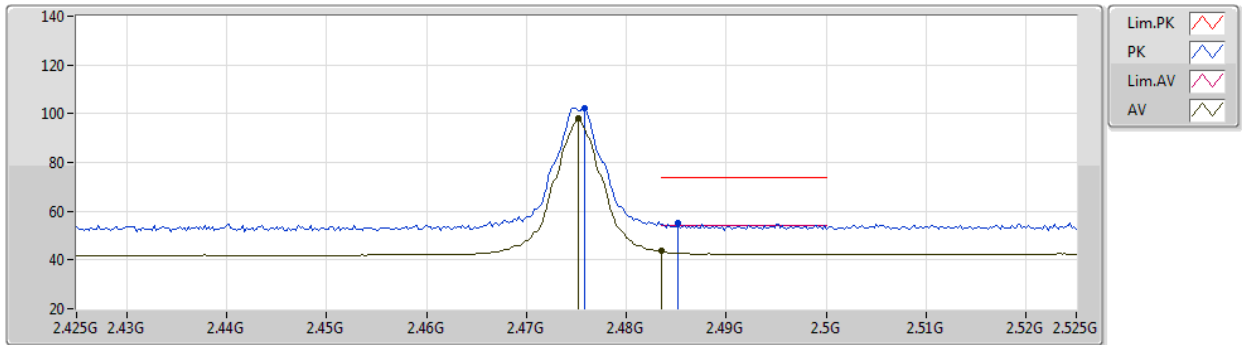

EUT Y_1TX
Setting 5
01-C-G-2

Type	Freq (Hz)	Level (dBuV/m)	Limit (dBuV/m)	Margin (dB)	Raw (dBuV)	Dist (m)	Condition	Azimuth (°)	Height (m)	Comment	AF (dB)	CL (dB)	PA (dB)
PK	2.4758G	102.46	Inf	-Inf	72.53	3	Horizontal	319	2.20	-	27.65	2.28	-
AV	2.4752G	97.97	Inf	-Inf	68.04	3	Horizontal	319	2.20	-	27.65	2.28	-
PK	2.4852G	55.03	74.00	-18.97	25.03	3	Horizontal	319	2.20	-	27.71	2.29	-
AV	2.4835G	43.64	54.00	-10.36	13.66	3	Horizontal	319	2.20	-	27.70	2.28	-

802.15.4

22/05/2021

2475MHz_TX

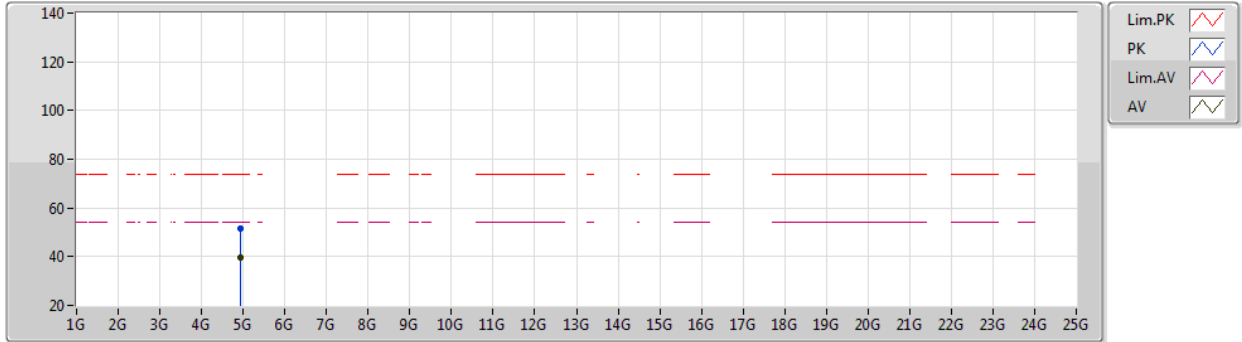

EUT V_1TX
Setting 5
01-C-G-2

Type	Freq (Hz)	Level (dBuV/m)	Limit (dBuV/m)	Margin (dB)	Raw (dBuV)	Dist (m)	Condition	Azimuth (°)	Height (m)	Comment	AF (dB)	CL (dB)	PA (dB)
PK	4.94922G	51.30	74.00	-22.70	46.40	3	Vertical	339	2.33	-	32.80	5.07	32.97
AV	4.94935G	39.74	54.00	-14.26	34.84	3	Vertical	339	2.33	-	32.80	5.07	32.97

802.15.4

22/05/2021

2475MHz_TX

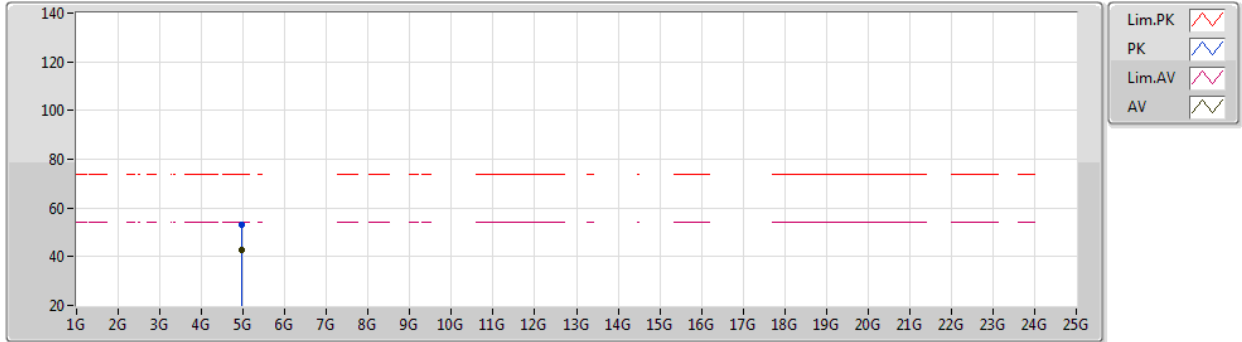

EUT Y_1TX
Setting 5
01-C-G-2

Type	Freq (Hz)	Level (dBuV/m)	Limit (dBuV/m)	Margin (dB)	Raw (dBuV)	Dist (m)	Condition	Azimuth (°)	Height (m)	Comment	AF (dB)	CL (dB)	PA (dB)
PK	4.95126G	53.17	74.00	-20.83	48.26	3	Horizontal	349	1.38	-	32.80	5.08	32.97
AV	4.95138G	42.55	54.00	-11.45	37.64	3	Horizontal	349	1.38	-	32.80	5.08	32.97

802.15.4

27/05/2021

2480MHz_TX

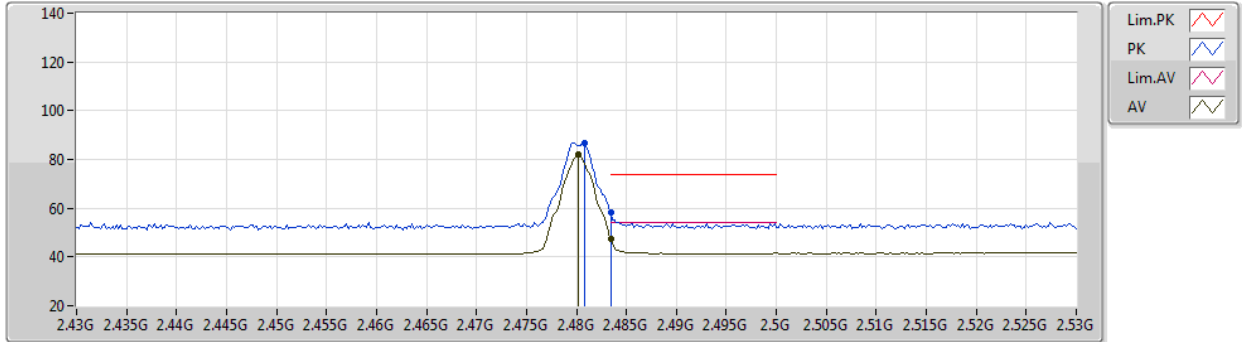

EUT Y_1TX
Setting -1
01-A-C-5

Type	Freq (Hz)	Level (dBuV/m)	Limit (dBuV/m)	Margin (dB)	Raw (dBuV)	Dist (m)	Condition	Azimuth (°)	Height (m)	Comment	AF (dB)	CL (dB)	PA (dB)
PK	2.4808G	86.74	Inf	-Inf	56.78	3	Vertical	16	2.88	-	27.68	2.28	-
AV	2.4802G	82.17	Inf	-Inf	52.21	3	Vertical	16	2.88	-	27.68	2.28	-
PK	2.4835G	58.03	74.00	-15.97	28.05	3	Vertical	16	2.88	-	27.70	2.28	-
AV	2.4835G	47.58	54.00	-6.42	17.60	3	Vertical	16	2.88	-	27.70	2.28	-

802.15.4

27/05/2021

2480MHz_TX

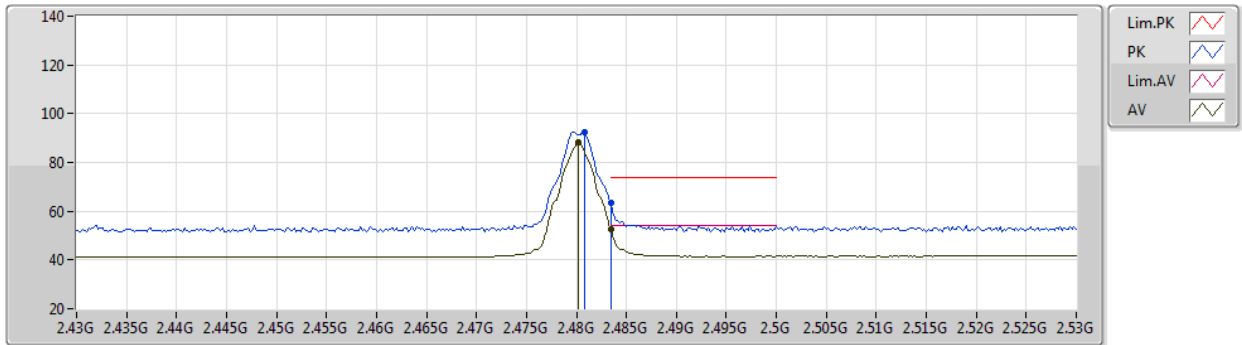

EUT Y_1TX
Setting -1
01-A-C-5

Type	Freq (Hz)	Level (dBuV/m)	Limit (dBuV/m)	Margin (dB)	Raw (dBuV)	Dist (m)	Condition	Azimuth (°)	Height (m)	Comment	AF (dB)	CL (dB)	PA (dB)
PK	2.4808G	92.63	Inf	-Inf	62.67	3	Horizontal	312	1.69	-	27.68	2.28	-
AV	2.4802G	88.08	Inf	-Inf	58.12	3	Horizontal	312	1.69	-	27.68	2.28	-
PK	2.4835G	63.31	74.00	-10.69	33.33	3	Horizontal	312	1.69	-	27.70	2.28	-
AV	2.4835G	52.45	54.00	-1.55	22.47	3	Horizontal	312	1.69	-	27.70	2.28	-

802.15.4

27/05/2021

2480MHz_TX

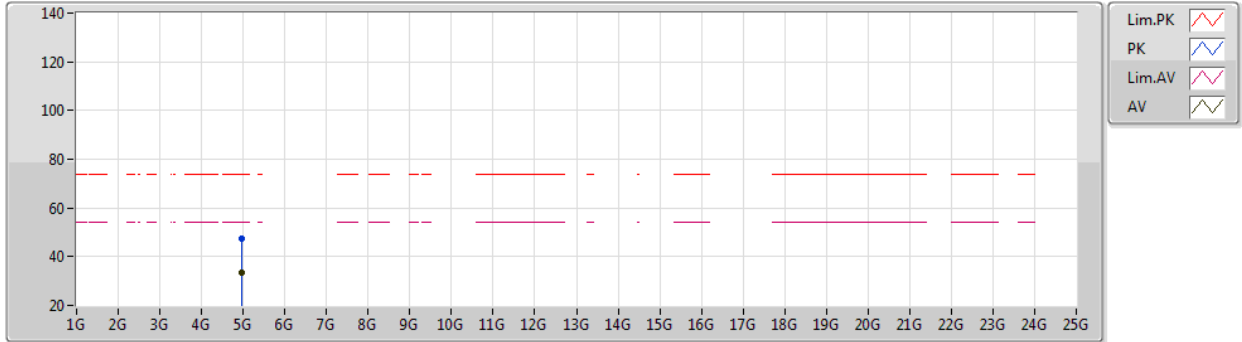

EUT Y_1TX
Setting -1
01-A-C-5

Type	Freq (Hz)	Level (dBuV/m)	Limit (dBuV/m)	Margin (dB)	Raw (dBuV)	Dist (m)	Condition	Azimuth (°)	Height (m)	Comment	AF (dB)	CL (dB)	PA (dB)
PK	4.96488G	47.26	74.00	-26.74	42.37	3	Vertical	327	1.23	-	32.77	5.08	32.96
AV	4.96536G	33.30	54.00	-20.70	28.41	3	Vertical	327	1.23	-	32.77	5.08	32.96

802.15.4

27/05/2021

2480MHz_TX

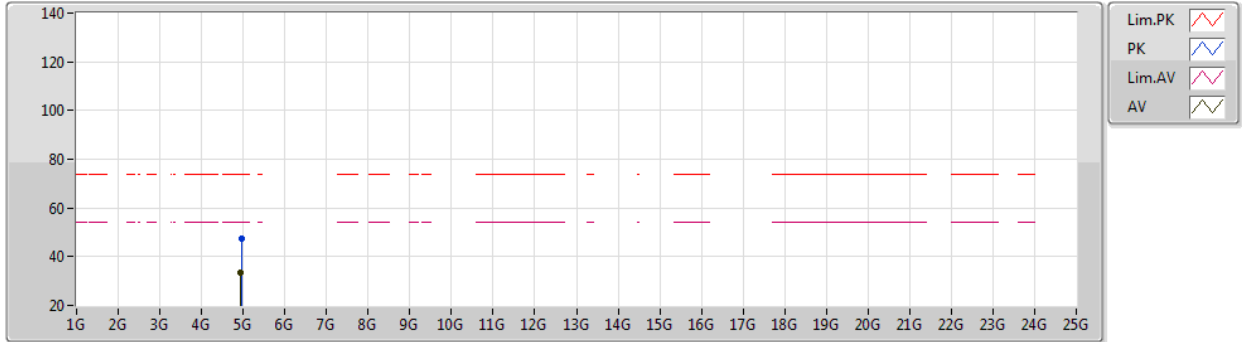

EUT V_1TX
Setting -1
01-A-C-5

Type	Freq (Hz)	Level (dBuV/m)	Limit (dBuV/m)	Margin (dB)	Raw (dBuV)	Dist (m)	Condition	Azimuth (°)	Height (m)	Comment	AF (dB)	CL (dB)	PA (dB)
PK	4.97068G	47.37	74.00	-26.63	42.48	3	Horizontal	201	1.63	-	32.76	5.09	32.96
AV	4.94644G	33.25	54.00	-20.75	28.37	3	Horizontal	201	1.63	-	32.78	5.07	32.97