

FCC Test Report

Report No.: RF170731C10-3

FCC ID: QXO-AP3917E

Test Model: AP3917e

Series Model: AP7662 (refer to item 3.1 for more details)

Received Date: Jul. 31, 2017

Test Date: Sep. 22 ~ Oct. 22, 2017

Issued Date: Nov. 08, 2017

Applicant: Extreme Networks, Inc.

Address: 6480 VIA DEL ORO SAN JOSE CA 95119 USA

Issued By: Bureau Veritas Consumer Products Services (H.K.) Ltd., Taoyuan Branch

Lab Address: No. 47-2, 14th Ling, Chia Pau Vil., Lin Kou Dist., New Taipei City, Taiwan (R.O.C.)

Test Location: No. 19, Hwa Ya 2nd Rd., Wen Hwa Vil., Kwei Shan Dist., Taoyuan City 33383, TAIWAN (R.O.C.)

**FCC Registration /
Designation Number:** 788550 / TW0003



This report is for your exclusive use. Any copying or replication of this report to or for any other person or entity, or use of our name or trademark, is permitted only with our prior written permission. This report sets forth our findings solely with respect to the test samples identified herein. The results set forth in this report are not indicative or representative of the quality or characteristics of the lot from which a test sample was taken or any similar or identical product unless specifically and expressly noted. Our report includes all of the tests requested by you and the results thereof based upon the information that you provided to us. You have 60 days from date of issuance of this report to notify us of any material error or omission caused by our negligence, provided, however, that such notice shall be in writing and shall specifically address the issue you wish to raise. A failure to raise such issue within the prescribed time shall constitute your unqualified acceptance of the completeness of this report, the tests conducted and the correctness of the report contents. Unless specifically mentioned, the uncertainty of measurement has been explicitly taken into account to declare the compliance or non-compliance to the specification. This report should not be used by the client to claim product certification, approval, or endorsement by TAF or any government agencies.

Table of Contents

Release Control Record	4
1 Certificate of Conformity	5
2 Summary of Test Results	6
2.1 Measurement Uncertainty.....	6
2.2 Modification Record.....	6
3 General Information	7
3.1 General Description of EUT.....	7
3.2 Description of Test Modes.....	8
3.2.1 Test Mode Applicability and Tested Channel Detail.....	9
3.3 Duty Cycle of Test Signal.....	10
3.4 Description of Support Units.....	10
3.4.1 Configuration of System under Test.....	11
3.5 General Description of Applied Standards.....	11
4 Test Types and Results	12
4.1 Radiated Emission and Bandedge Measurement.....	12
4.1.1 Limits of Radiated Emission and Bandedge Measurement.....	12
4.1.2 Test Instruments.....	13
4.1.3 Test Procedures.....	14
4.1.4 Deviation from Test Standard.....	14
4.1.5 Test Setup.....	15
4.1.6 EUT Operating Conditions.....	16
4.1.7 Test Results.....	17
4.2 Conducted Emission Measurement.....	25
4.2.1 Limits of Conducted Emission Measurement.....	25
4.2.2 Test Instruments.....	25
4.2.3 Test Procedures.....	26
4.2.4 Deviation from Test Standard.....	26
4.2.5 Test Setup.....	26
4.2.6 EUT Operating Conditions.....	26
4.2.7 Test Results.....	27
4.3 6dB Bandwidth Measurement.....	31
4.3.1 Limits of 6dB Bandwidth Measurement.....	31
4.3.2 Test Setup.....	31
4.3.3 Test Instruments.....	31
4.3.4 Test Procedure.....	31
4.3.5 Deviation from Test Standard.....	31
4.3.6 EUT Operating Conditions.....	31
4.3.7 Test Result.....	32
4.4 Conducted Output Power Measurement.....	34
4.4.1 Limits of Conducted Output Power Measurement.....	34
4.4.2 Test Setup.....	34
4.4.3 Test Instruments.....	34
4.4.4 Test Procedures.....	34
4.4.5 Deviation from Test Standard.....	34
4.4.6 EUT Operating Conditions.....	34
4.4.7 Test Results.....	34
4.5 Power Spectral Density Measurement.....	35
4.5.1 Limits of Power Spectral Density Measurement.....	35
4.5.2 Test Setup.....	35
4.5.3 Test Instruments.....	35
4.5.4 Test Procedure.....	35
4.5.5 Deviation from Test Standard.....	35
4.5.6 EUT Operating Condition.....	35

4.5.7 Test Results	36
4.6 Conducted Out of Band Emission Measurement.....	38
4.6.1 Limits of Conducted Out of Band Emission Measurement	38
4.6.2 Test Setup.....	38
4.6.3 Test Instruments	38
4.6.4 Test Procedure	38
4.6.5 Deviation from Test Standard	38
4.6.6 EUT Operating Condition	38
4.6.7 Test Results	38
5 Pictures of Test Arrangements.....	41
Appendix – Information on the Testing Laboratories	42

Release Control Record

Issue No.	Description	Date Issued
RF170731C10-3	Original release.	Nov. 08, 2017

1 Certificate of Conformity

Product: Wireless 802.11 a/ac+b/g/n Access Point

Brand: Extreme Networks

Test Model: AP3917e

Series Model: AP7662 (refer to item 3.1 for more details)

Sample Status: Engineering sample

Applicant: Extreme Networks, Inc.

Test Date: Sep. 22 ~ Oct. 22, 2017

Standards: 47 CFR FCC Part 15, Subpart C (Section 15.247)
ANSI C63.10:2013

The above equipment has been tested by **Bureau Veritas Consumer Products Services (H.K.) Ltd., Taoyuan Branch**, and found compliance with the requirement of the above standards. The test record, data evaluation & Equipment Under Test (EUT) configurations represented herein are true and accurate accounts of the measurements of the sample's EMC characteristics under the conditions specified in this report.

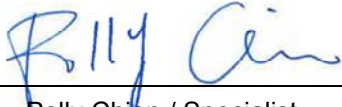
Prepared by : , **Date:** Nov. 08, 2017
Polly Chien / Specialist

Approved by : , **Date:** Nov. 08, 2017
Ken Liu / Senior Manager

2 Summary of Test Results

47 CFR FCC Part 15, Subpart C (Section 15.247)			
FCC Clause	Test Item	Result	Remarks
15.207	AC Power Conducted Emission	Pass	Meet the requirement of limit. Minimum passing margin is -5.07dB at 0.48550MHz.
15.205 / 15.209 / 15.247(d)	Radiated Emissions and Band Edge Measurement	Pass	Meet the requirement of limit. Minimum passing margin is -1.1dB at 2483.50MHz.
15.247(d)	Antenna Port Emission	Pass	Meet the requirement of limit.
15.247(a)(2)	6dB bandwidth	Pass	Meet the requirement of limit.
15.247(b)	Conducted power	Pass	Meet the requirement of limit.
15.247(e)	Power Spectral Density	Pass	Meet the requirement of limit.
15.203	Antenna Requirement	Pass	Antenna connectors are N Male and 4 N Male not a standard connector.

2.1 Measurement Uncertainty

Where relevant, the following measurement uncertainty levels have been estimated for tests performed on the EUT as specified in CISPR 16-4-2:

Measurement	Frequency	Expanded Uncertainty (k=2) (\pm)
Conducted Emissions at mains ports	150kHz ~ 30MHz	2.94 dB
Radiated Emissions up to 1 GHz	30MHz ~ 200MHz	3.86 dB
	200MHz ~ 1000MHz	3.87 dB
Radiated Emissions above 1 GHz	1GHz ~ 18GHz	2.29 dB
	18GHz ~ 40GHz	2.29 dB

2.2 Modification Record

There were no modifications required for compliance.

3 General Information

3.1 General Description of EUT

Product	Wireless 802.11 a/ac+b/g/n Access Point
Brand	Extreme Networks
Test Model	AP3917e
Series Model	AP7662
Model Difference	Refer to note for more details
Sample Status	Engineering sample
Power Supply Rating	54Vdc from POE
Modulation Type	O-QPSK
Transfer Rate	250kbps
Operating Frequency	2405 ~ 2480MHz
Number of Channel	16
Channel Spacing	5MHz
Output Power	ML-2499-HPA8-01 Ant.: 1.997mW ML-2452-PNA7-01R Ant.: 1.997mW
Antenna Type	Refer to Note
Antenna Connector	Refer to Note
Accessory Device	NA
Cable Supplied	1.75m non-shielded ground cable without core

Note:

1. All models are listed as below. Model: AP3917e was chosen for final test.

Brand	Model	Difference
Extreme Networks	AP3917e	All models are electrically identical, only cover printing different.
	AP7662	

2. The EUT consumes power from following POE. (Support unit only)

POE	
Brand	EnGenius
Model	EPA5006GP
Input Power	100-240Vac, 50-60Hz, 0.8A
Output Power	54Vdc, 0.6A Pin 4, 5: 54Vdc Pin 7, 8: Return

3. Power Setting as below.

ML-2499-HPA8-01 Ant.:

	Power Setting
CH 11	32
CH 18	32
CH 26	11

ML-2452-PNA7-01R Ant.:

	Power Setting
CH 11	32
CH 18	32
CH 26	12

4. The EUT uses following antennas.

Item	Function	Antenna Type	Part No	Connector	Gain (dBi)		
					2.4G	4.9G	5G
1	WLAN	Dipole	ML-2452-HPAG5A8-01	N Male	5	7.5	8
2	WLAN	Dipole	ML-2452-HPAG4A6-01	N Male	4		7.3
3	WLAN	Dipole	ML-2452-HPA6X6-036	N Male	4		6
4	WLAN	Dipole	WS-AO-DQ04360N	4 N Male	5.5		6
5	WLAN	Dipole	ML-2499-HPA4-01	N Male	4.5		
6	WLAN	Dipole	ML-2452-HPA6-01	N Male	5.3	4.6	6.1
7	WLAN	Dipole	ML-5299-HPA5-01	N Male			5.6
8	WLAN & BT LE & Zigbee	Dipole	ML-2499-HPA8-01	N Male	8		
9	WLAN	Dipole	ML-2499-FHPA5-01R	N Male	7.7		
10	WLAN	Dipole	ML-5299-FHPA6-01R	N Male		8.25	8.25
11	WLAN	Panel	ML-2452-PNA5-01R	N Male	4.5	5	5~4.5 MAX:5
12	WLAN & BT LE & Zigbee	Panel	ML-2452-PNA7-01R	N Male	7.8	7	10.7~7 MAX:10.7
13	WLAN	Polarized Panel	ML-2452-PNL6M4-N36	4 N Male	5.6	6.7	6.7
14	WLAN	Polarized Panel	ML-2452-SEC6M4-N36	4 N Male	6.92		7.23
15	WLAN	Polarized Panel	ML-2452-SEC6M4-N30	4 N Male	5.5		6
16	WLAN	Polarized Panel	ML-2452-PNL9M3-N36	N Male	11	7.3	10.7

5. 2.4GHz & 5GHz & BT LE / 2.4GHz & 5GHz & Zigbee technologies can transmit at same time.
BT LE & Zigbee technologies cannot transmit at same time.

6. Spurious emission of the simultaneous operation (2.4GHz & 5GHz & BT LE / 2.4GHz & 5GHz & Zigbee) has been evaluated and no non-compliance was found.

3.2 Description of Test Modes

16 channels are provided to this EUT:

Channel	Freq. (MHz)	Channel	Freq. (MHz)	Channel	Freq. (MHz)	Channel	Freq. (MHz)
11	2405	15	2425	19	2445	23	2465
12	2410	16	2430	20	2450	24	2470
13	2415	17	2435	21	2455	25	2475
14	2420	18	2440	22	2460	26	2480

3.2.1 Test Mode Applicability and Tested Channel Detail

EUT Configure Mode	Applicable to				Description Antenna Model
	RE \geq 1G	RE<1G	PLC	APCM	
A	√	√	√	√	ML-2499-HPA8-01
B	√	√	√	√	ML-2452-PNA7-01R

Where RE \geq 1G: Radiated Emission above 1GHz & Bandedge Measurement
 RE<1G: Radiated Emission below 1GHz
 PLC: Power Line Conducted Emission
 APCM: Antenna Port Conducted Measurement

Note: The EUT had been pre-tested on the positioned of each 3 axis. The worst case was found when positioned on **Z-plane for test mode A and Y-plane for test mode**.

Radiated Emission Test (Above 1GHz):

- Pre-Scan has been conducted to determine the worst-case mode from all possible combinations between available modulations, data rates and antenna ports (if EUT with antenna diversity architecture).
- Following channel(s) was (were) selected for the final test as listed below.

EUT Configure Mode	Available Channel	Tested Channel	Modulation Type
A, B	11 to 26	11, 18, 26	O-QPSK

Radiated Emission Test (Below 1GHz):

- Pre-Scan has been conducted to determine the worst-case mode from all possible combinations between available modulations, data rates and antenna ports (if EUT with antenna diversity architecture).
- Following channel(s) was (were) selected for the final test as listed below.

EUT Configure Mode	Available Channel	Tested Channel	Modulation Type
A, B	11 to 26	11	O-QPSK

Power Line Conducted Emission Test:

- Pre-Scan has been conducted to determine the worst-case mode from all possible combinations between available modulations, data rates and antenna ports (if EUT with antenna diversity architecture).
- Following channel(s) was (were) selected for the final test as listed below.

EUT Configure Mode	Available Channel	Tested Channel	Modulation Type
A, B	11 to 26	11	O-QPSK

Antenna Port Conducted Measurement:

- This item includes all test value of each mode, but only includes spectrum plot of worst value of each mode.
- Pre-Scan has been conducted to determine the worst-case mode from all possible combinations between available modulations, data rates and antenna ports (if EUT with antenna diversity architecture).
- Following channel(s) was (were) selected for the final test as listed below.

EUT Configure Mode	Available Channel	Tested Channel	Modulation Type
A, B	11 to 26	11, 18, 26	O-QPSK

Test Condition:

Applicable to	Environmental Conditions	Input Power (System)	Tested by
RE≥1G	22 deg. C, 64% RH	120Vac, 60Hz	Willy Cheng
RE<1G	22 deg. C, 64% RH	120Vac, 60Hz	Willy Cheng
PLC	25 deg. C, 68% RH	120Vac, 60Hz	Jones Chang
APCM	25 deg. C, 60% RH	120Vac, 60Hz	Cedric Wu

3.3 Duty Cycle of Test Signal

Duty cycle = 2.655/3.008 = 0.883, Duty factor = 10 * log(1/0.883) = 0.54

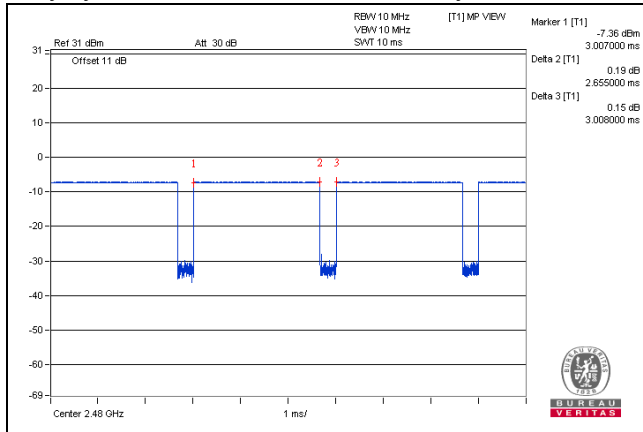

3.4 Description of Support Units

The EUT has been tested as an independent unit together with other necessary accessories or support units. The following support units or accessories were used to form a representative test configuration during the tests.

ID	Product	Brand	Model No.	Serial No.	FCC ID	Remarks
A.	Notebook	DELL	E5410	1HC2XM1	FCC DoC Approved	-
B.	POE	EnGenius	EPA5006GP	NA	NA	Provided by manufacturer
C.	Load	NA	NA	NA	NA	-

Note:

1. All power cords of the above support units are non-shielded (1.8m).
2. Item A acted as a communication partner to transfer data.

ID	Descriptions	Qty.	Length (m)	Shielding (Yes/No)	Cores (Qty.)	Remarks
1.	RJ45, Cat5e	1	3	N	0	-
2.	RJ45, Cat5e	1	1.8	N	0	-
3.	RJ45, Cat5e	1	1.8	N	0	-
4.	Console cable	1	0.2	N	0	Provided by manufacturer

3.4.1 Configuration of System under Test

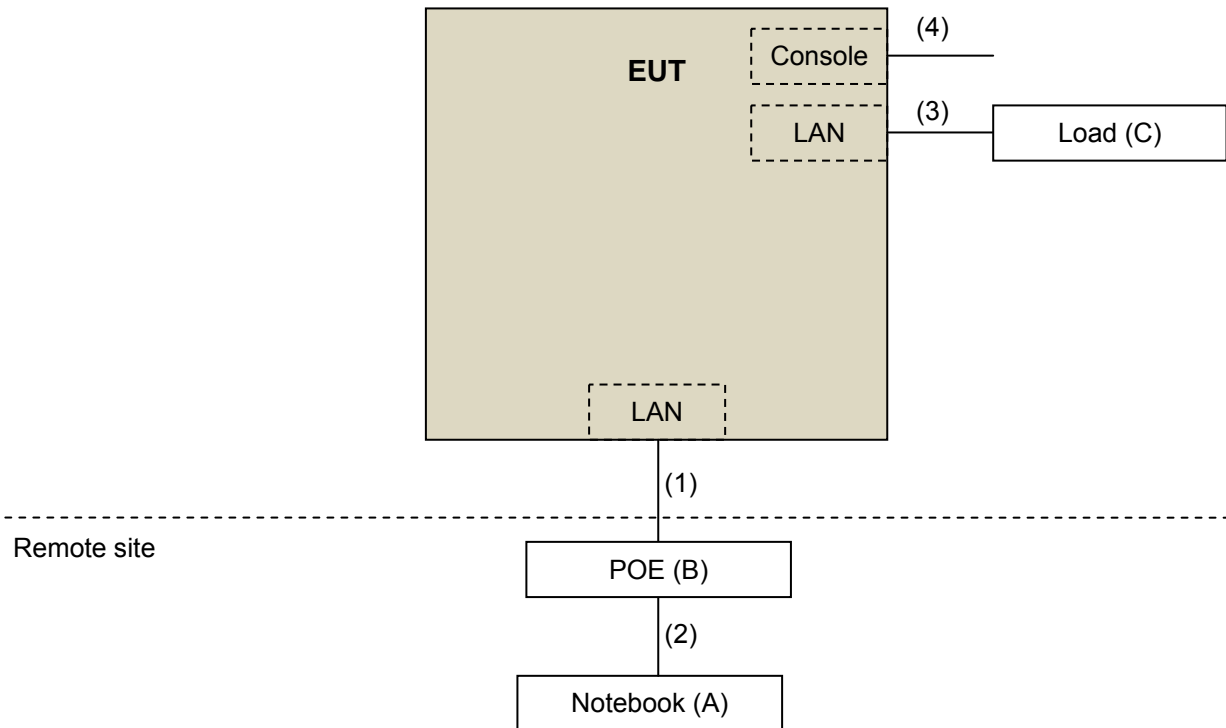

3.5 General Description of Applied Standards

The EUT is a RF Product. According to the specifications of the manufacturer, it must comply with the requirements of the following standards:

- FCC Part 15, Subpart C (15.247)**
- KDB 558074 D01 DTS Meas Guidance v04**
- ANSI C63.10-2013

All test items have been performed and recorded as per the above standards.

Note: The EUT has been verified to comply with the requirements of FCC Part 15, Subpart B, Class B (DoC). The test report has been issued separately.

4 Test Types and Results

4.1 Radiated Emission and Bandedge Measurement

4.1.1 Limits of Radiated Emission and Bandedge Measurement

Radiated emissions which fall in the restricted bands must comply with the radiated emission limits specified as below table. Other emissions shall be at least 20dB below the highest level of the desired power:

Frequencies (MHz)	Field Strength (microvolts/meter)	Measurement Distance (meters)
0.009 ~ 0.490	2400/F(kHz)	300
0.490 ~ 1.705	24000/F(kHz)	30
1.705 ~ 30.0	30	30
30 ~ 88	100	3
88 ~ 216	150	3
216 ~ 960	200	3
Above 960	500	3

Note:

1. The lower limit shall apply at the transition frequencies.
2. Emission level (dBuV/m) = 20 log Emission level (uV/m).
3. For frequencies above 1000MHz, the field strength limits are based on average detector, however, the peak field strength of any emission shall not exceed the maximum permitted average limits, specified above by more than 20dB under any condition of modulation.

4.1.2 Test Instruments

Description & Manufacturer	Model No.	Serial No.	Cal. Date	Cal. Due
Test Receiver ROHDE & SCHWARZ	ESIB7	100187	May 02, 2017	May 01, 2018
Spectrum Analyzer ROHDE & SCHWARZ	FSP40	100041	Nov. 16, 2016	Nov. 15, 2017
BILOG Antenna SCHWARZBECK	VULB9168	9168-171	Dec. 28, 2016	Dec. 27, 2017
HORN Antenna SCHWARZBECK	9120D	209	Dec. 27, 2016	Dec. 26, 2017
HORN Antenna SCHWARZBECK	BBHA 9170	BBHA9170241	Dec. 14, 2016	Dec. 13, 2017
Loop Antenna	EM-6879	269	Aug. 11, 2017	Aug. 10, 2018
Preamplifier Agilent	8447D	2944A10738	Aug. 21, 2017	Aug. 20, 2018
Preamplifier Agilent	8449B	3008A02465	Apr. 05, 2017	Apr. 04, 2018
RF signal cable HUBER+SUHNER	SUCOFLEX 104	Cable-CH3-03 (223653/4)	Aug. 21, 2017	Aug. 20, 2018
RF signal cable HUBER+SUHNER& EMCI	SUCOFLEX 104&EMC104-SM-S M-8000	Cable-CH3-03 (309224+170907)	Sep.11, 2017	Sep. 10, 2018
Software BV ADT	ADT_Radiated_ V7.6.15.9.4	NA	NA	NA
Antenna Tower inn-co GmbH	MA 4000	013303	NA	NA
Antenna Tower Controller BV ADT	AT100	AT93021702	NA	NA
Turn Table BV ADT	TT100	TT93021702	NA	NA
Turn Table Controller BV ADT	SC100	SC93021702	NA	NA
High Speed Peak Power Meter	ML2495A	0824012	Aug. 18, 2017	Aug. 17, 2018
Power Sensor	MA2411B	0738171	Aug. 18, 2017	Aug. 17, 2018

- Note:
1. The calibration interval of the above test instruments is 12 months and the calibrations are traceable to NML/ROC and NIST/USA.
 2. The test was performed in HwaYa Chamber 3.
 3. The horn antenna and preamplifier (model: 8449B) are used only for the measurement of emission frequency above 1GHz if tested.
 4. The FCC Designation Number is TW0003. The number will be varied with the Lab location and scope as attached.
 5. The IC Site Registration No. is IC 7450F-3.

4.1.3 Test Procedures

For Radiated emission below 30MHz

- a. The EUT was placed on the top of a rotating table 0.8 meters above the ground at a 3 meter chamber room. The table was rotated 360 degrees to determine the position of the highest radiation.
- b. The EUT was set 3 meters away from the interference-receiving antenna, which was mounted on the top of a variable-height antenna tower.
- c. Both X and Y axes of the antenna are set to make the measurement.
- d. For each suspected emission, the EUT was arranged to its worst case and the rotatable table was turned from 0 degrees to 360 degrees to find the maximum reading.
- e. The test-receiver system was set to Quasi-Peak Detect Function and Specified Bandwidth with Maximum Hold Mode.

Note:

1. The resolution bandwidth and video bandwidth of test receiver/spectrum analyzer is 9kHz at frequency below 30MHz.

For Radiated emission above 30MHz

- a. The EUT was placed on the top of a rotating table 0.8 meters (for 30MHz ~ 1GHz) / 1.5 meters (for above 1GHz) above the ground at 3 meter chamber room for test. The table was rotated 360 degrees to determine the position of the highest radiation.
- b. The EUT was set 3 meters away from the interference-receiving antenna, which was mounted on the top of a variable-height antenna tower.
- c. The height of antenna is varied from one meter to four meters above the ground to determine the maximum value of the field strength. Both horizontal and vertical polarizations of the antenna are set to make the measurement.
- d. For each suspected emission, the EUT was arranged to its worst case and then the antenna was tuned to heights from 1 meter to 4 meters and the rotatable table was turned from 0 degrees to 360 degrees to find the maximum reading.
- e. The test-receiver system was set to quasi-peak detect function and specified bandwidth with maximum hold mode when the test frequency is below 1 GHz.
- f. The test-receiver system was set to peak and average detect function and specified bandwidth with maximum hold mode when the test frequency is above 1 GHz. If the peak reading value also meets average limit, measurement with the average detector is unnecessary.

Note:

1. The resolution bandwidth and video bandwidth of test receiver/spectrum analyzer is 120kHz for Quasi-peak detection (QP) at frequency below 1GHz.
2. The resolution bandwidth of test receiver/spectrum analyzer is 1 MHz and the video bandwidth is 3 MHz for Peak detection (PK) at frequency above 1GHz.
3. The resolution bandwidth of test receiver/spectrum analyzer is 1 MHz and the video bandwidth is $\geq 1/T$ (Duty cycle < 98%) or 10 Hz (Duty cycle $\geq 98\%$) for Peak detection at frequency above 1GHz.
4. All modes of operation were investigated and the worst-case emissions are reported.

4.1.4 Deviation from Test Standard

No deviation.

4.1.5 Test Setup

For Radiated emission below 30MHz

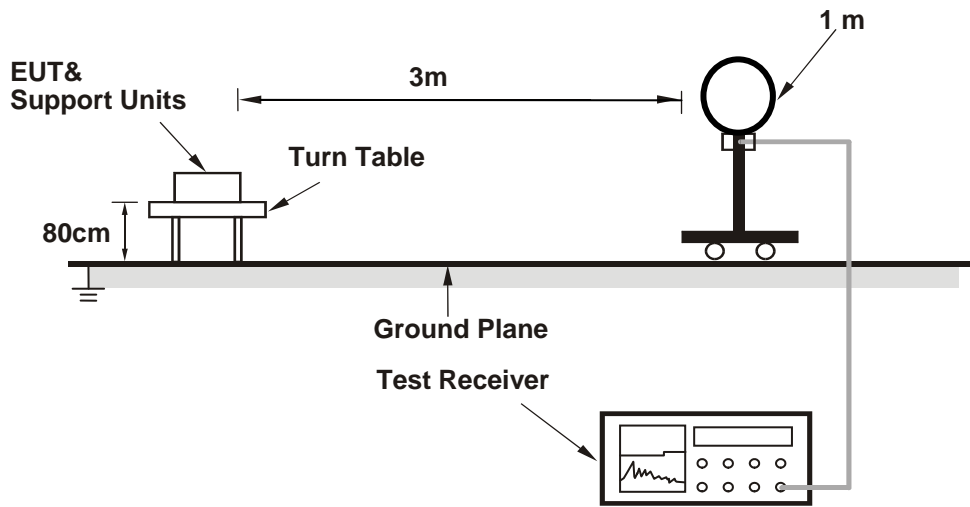

For Radiated emission 30MHz to 1GHz

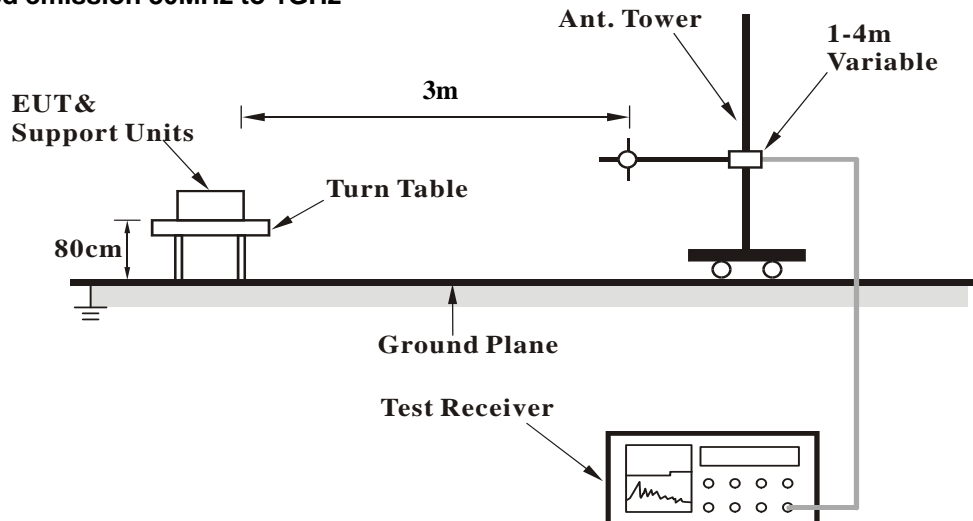

For Radiated emission above 1GHz

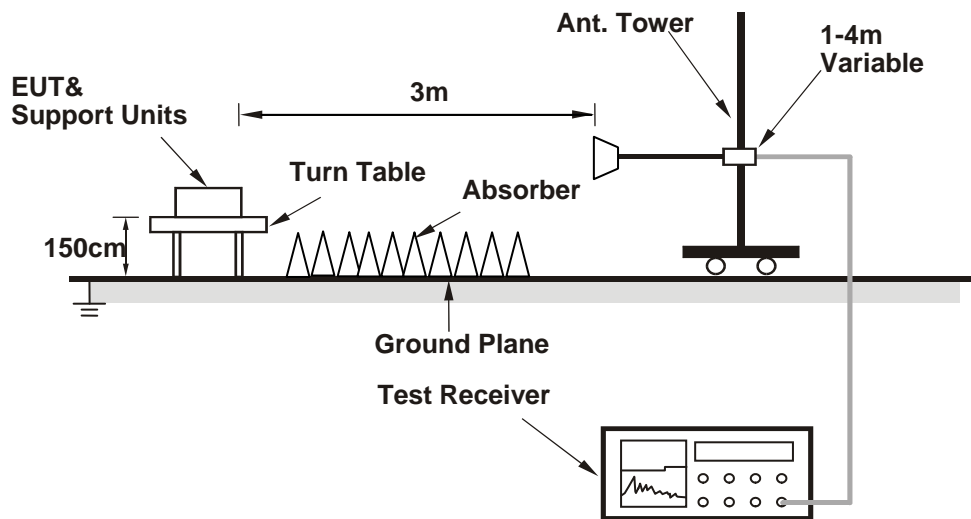

For the actual test configuration, please refer to the attached file (Test Setup Photo).

4.1.6 EUT Operating Conditions

- Placed the EUT on the testing table.
- Prepared a notebook to act as a communication partner and placed it outside of testing area.
- The communication partner connected with EUT via a RJ45 cable and ran a test program (provided by manufacturer) to enable EUT under transmission condition continuously at specific channel frequency.
- The communication partner sent data to EUT by command "PING".

4.1.7 Test Results

Above 1GHz Data:

Test Mode A

CHANNEL	TX Channel 11	DETECTOR	Peak (PK)
FREQUENCY RANGE	1GHz ~ 25GHz	FUNCTION	Average (AV)

ANTENNA POLARITY & TEST DISTANCE: HORIZONTAL AT 3 M								
NO.	FREQ. (MHz)	EMISSION LEVEL (dBuV/m)	LIMIT (dBuV/m)	MARGIN (dB)	ANTENNA HEIGHT (m)	TABLE ANGLE (Degree)	RAW VALUE (dBuV)	CORRECTION FACTOR (dB/m)
1	2390.00	57.3 PK	74.0	-16.7	1.81 H	111	24.40	32.90
2	2390.00	45.8 AV	54.0	-8.2	1.81 H	111	12.90	32.90
3	*2405.00	88.2 PK			1.44 H	145	55.20	33.00
4	*2405.00	84.0 AV			1.44 H	145	51.00	33.00
5	4810.00	48.5 PK	74.0	-25.5	1.48 H	4	44.90	3.60
6	4810.00	36.2 AV	54.0	-17.8	1.48 H	4	32.60	3.60
ANTENNA POLARITY & TEST DISTANCE: VERTICAL AT 3 M								
NO.	FREQ. (MHz)	EMISSION LEVEL (dBuV/m)	LIMIT (dBuV/m)	MARGIN (dB)	ANTENNA HEIGHT (m)	TABLE ANGLE (Degree)	RAW VALUE (dBuV)	CORRECTION FACTOR (dB/m)
1	2390.00	57.6 PK	74.0	-16.4	1.93 V	203	24.70	32.90
2	2390.00	45.8 AV	54.0	-8.2	1.93 V	203	12.90	32.90
3	*2405.00	103.6 PK			1.76 V	42	70.60	33.00
4	*2405.00	99.5 AV			1.76 V	42	66.50	33.00
5	4810.00	49.6 PK	74.0	-24.4	1.33 V	343	46.00	3.60
6	4810.00	38.5 AV	54.0	-15.5	1.33 V	343	34.90	3.60

Remarks:

1. Emission Level(dBuV/m) = Raw Value(dBuV) + Correction Factor(dB/m)
2. Correction Factor(dB/m) = Antenna Factor(dB/m) + Cable Factor(dB) – Pre-Amplifier Factor(dB)
3. The other emission levels were very low against the limit.
4. Margin value = Emission Level – Limit value
5. " * ": Fundamental frequency.

CHANNEL	TX Channel 18	DETECTOR FUNCTION	Peak (PK)
FREQUENCY RANGE	1GHz ~ 25GHz		Average (AV)

ANTENNA POLARITY & TEST DISTANCE: HORIZONTAL AT 3 M

NO.	FREQ. (MHz)	EMISSION LEVEL (dBuV/m)	LIMIT (dBuV/m)	MARGIN (dB)	ANTENNA HEIGHT (m)	TABLE ANGLE (Degree)	RAW VALUE (dBuV)	CORRECTION FACTOR (dB/m)
1	*2440.00	88.4 PK			1.59 H	148	55.20	33.20
2	*2440.00	84.2 AV			1.59 H	148	51.00	33.20
3	4880.00	49.4 PK	74.0	-24.6	1.56 H	4	45.80	3.60
4	4880.00	38.0 AV	54.0	-16.0	1.56 H	4	34.40	3.60

ANTENNA POLARITY & TEST DISTANCE: VERTICAL AT 3 M

NO.	FREQ. (MHz)	EMISSION LEVEL (dBuV/m)	LIMIT (dBuV/m)	MARGIN (dB)	ANTENNA HEIGHT (m)	TABLE ANGLE (Degree)	RAW VALUE (dBuV)	CORRECTION FACTOR (dB/m)
1	*2440.00	103.6 PK			1.68 V	171	70.40	33.20
2	*2440.00	99.5 AV			1.68 V	171	66.30	33.20
3	4880.00	49.8 PK	74.0	-24.2	1.66 V	340	46.20	3.60
4	4880.00	38.4 AV	54.0	-15.6	1.66 V	340	34.80	3.60

Remarks:

1. Emission Level(dBuV/m) = Raw Value(dBuV) + Correction Factor(dB/m)
2. Correction Factor(dB/m) = Antenna Factor(dB/m) + Cable Factor(dB) – Pre-Amplifier Factor(dB)
3. The other emission levels were very low against the limit.
4. Margin value = Emission Level – Limit value
5. " * ": Fundamental frequency.

CHANNEL	TX Channel 26	DETECTOR FUNCTION	Peak (PK)
FREQUENCY RANGE	1GHz ~ 25GHz		Average (AV)

ANTENNA POLARITY & TEST DISTANCE: HORIZONTAL AT 3 M								
NO.	FREQ. (MHz)	EMISSION LEVEL (dBuV/m)	LIMIT (dBuV/m)	MARGIN (dB)	ANTENNA HEIGHT (m)	TABLE ANGLE (Degree)	RAW VALUE (dBuV)	CORRECTION FACTOR (dB/m)
1	*2480.00	79.8 PK			1.73 H	130	46.40	33.40
2	*2480.00	75.4 AV			1.73 H	130	42.00	33.40
3	2483.50	57.7 PK	74.0	-16.3	1.92 H	111	24.30	33.40
4	2483.50	45.9 AV	54.0	-8.1	1.92 H	111	12.50	33.40
5	4960.00	49.0 PK	74.0	-25.0	1.77 H	56	45.30	3.70
6	4960.00	37.0 AV	54.0	-17.0	1.77 H	56	33.30	3.70
ANTENNA POLARITY & TEST DISTANCE: VERTICAL AT 3 M								
NO.	FREQ. (MHz)	EMISSION LEVEL (dBuV/m)	LIMIT (dBuV/m)	MARGIN (dB)	ANTENNA HEIGHT (m)	TABLE ANGLE (Degree)	RAW VALUE (dBuV)	CORRECTION FACTOR (dB/m)
1	*2480.00	96.0 PK			1.77 V	169	62.60	33.40
2	*2480.00	91.9 AV			1.77 V	169	58.50	33.40
3	2483.50	67.8 PK	74.0	-6.2	1.73 V	170	34.40	33.40
4	2483.50	52.9 AV	54.0	-1.1	1.73 V	170	19.50	33.40
5	4960.00	48.8 PK	74.0	-25.2	1.79 V	337	45.10	3.70
6	4960.00	37.0 AV	54.0	-17.0	1.79 V	337	33.30	3.70

Remarks:

1. Emission Level(dBuV/m) = Raw Value(dBuV) + Correction Factor(dB/m)
2. Correction Factor(dB/m) = Antenna Factor(dB/m) + Cable Factor(dB) – Pre-Amplifier Factor(dB)
3. The other emission levels were very low against the limit.
4. Margin value = Emission Level – Limit value
5. " * ": Fundamental frequency.

Test Mode B

CHANNEL	TX Channel 11	DETECTOR	Peak (PK)
FREQUENCY RANGE	1GHz ~ 25GHz	FUNCTION	Average (AV)

ANTENNA POLARITY & TEST DISTANCE: HORIZONTAL AT 3 M								
NO.	FREQ. (MHz)	EMISSION LEVEL (dBuV/m)	LIMIT (dBuV/m)	MARGIN (dB)	ANTENNA HEIGHT (m)	TABLE ANGLE (Degree)	RAW VALUE (dBuV)	CORRECTION FACTOR (dB/m)
1	2390.00	55.3 PK	74.0	-18.7	2.19 H	321	22.40	32.90
2	2390.00	45.3 AV	54.0	-8.7	2.19 H	321	12.40	32.90
3	*2405.00	103.3 PK			1.33 H	356	70.30	33.00
4	*2405.00	99.2 AV			1.33 H	356	66.20	33.00
5	4810.00	46.9 PK	74.0	-27.1	2.27 H	160	44.00	2.90
6	4810.00	34.5 AV	54.0	-19.5	2.27 H	160	31.60	2.90
ANTENNA POLARITY & TEST DISTANCE: VERTICAL AT 3 M								
NO.	FREQ. (MHz)	EMISSION LEVEL (dBuV/m)	LIMIT (dBuV/m)	MARGIN (dB)	ANTENNA HEIGHT (m)	TABLE ANGLE (Degree)	RAW VALUE (dBuV)	CORRECTION FACTOR (dB/m)
1	2390.00	57.3 PK	74.0	-16.7	2.67 V	311	24.40	32.90
2	2390.00	45.6 AV	54.0	-8.4	2.67 V	311	12.70	32.90
3	*2405.00	95.2 PK			3.48 V	269	62.20	33.00
4	*2405.00	91.2 AV			3.48 V	269	58.20	33.00
5	4810.00	47.9 PK	74.0	-26.1	2.81 V	145	45.00	2.90
6	4810.00	36.8 AV	54.0	-17.2	2.81 V	145	33.90	2.90

Remarks:

1. Emission Level(dBuV/m) = Raw Value(dBuV) + Correction Factor(dB/m)
2. Correction Factor(dB/m) = Antenna Factor(dB/m) + Cable Factor(dB) – Pre-Amplifier Factor(dB)
3. The other emission levels were very low against the limit.
4. Margin value = Emission Level – Limit value
5. " * ": Fundamental frequency.

CHANNEL	TX Channel 18	DETECTOR FUNCTION	Peak (PK)
FREQUENCY RANGE	1GHz ~ 25GHz		Average (AV)

ANTENNA POLARITY & TEST DISTANCE: HORIZONTAL AT 3 M

NO.	FREQ. (MHz)	EMISSION LEVEL (dBuV/m)	LIMIT (dBuV/m)	MARGIN (dB)	ANTENNA HEIGHT (m)	TABLE ANGLE (Degree)	RAW VALUE (dBuV)	CORRECTION FACTOR (dB/m)
1	*2440.00	103.6 PK			1.78 H	355	70.40	33.20
2	*2440.00	99.5 AV			1.78 H	355	66.30	33.20
3	4880.00	47.7 PK	74.0	-26.3	2.00 H	215	44.70	3.00
4	4880.00	35.4 AV	54.0	-18.6	2.00 H	215	32.40	3.00

ANTENNA POLARITY & TEST DISTANCE: VERTICAL AT 3 M

NO.	FREQ. (MHz)	EMISSION LEVEL (dBuV/m)	LIMIT (dBuV/m)	MARGIN (dB)	ANTENNA HEIGHT (m)	TABLE ANGLE (Degree)	RAW VALUE (dBuV)	CORRECTION FACTOR (dB/m)
1	*2440.00	93.6 PK			3.82 V	298	60.40	33.20
2	*2440.00	89.5 AV			3.82 V	298	56.30	33.20
3	4880.00	48.4 PK	74.0	-25.6	1.66 V	190	45.40	3.00
4	4880.00	36.3 AV	54.0	-17.7	1.66 V	190	33.30	3.00

Remarks:

1. Emission Level(dBuV/m) = Raw Value(dBuV) + Correction Factor(dB/m)
2. Correction Factor(dB/m) = Antenna Factor(dB/m) + Cable Factor(dB) – Pre-Amplifier Factor(dB)
3. The other emission levels were very low against the limit.
4. Margin value = Emission Level – Limit value
5. " * ": Fundamental frequency.

CHANNEL	TX Channel 26	DETECTOR FUNCTION	Peak (PK)
FREQUENCY RANGE	1GHz ~ 25GHz		Average (AV)

ANTENNA POLARITY & TEST DISTANCE: HORIZONTAL AT 3 M

NO.	FREQ. (MHz)	EMISSION LEVEL (dBuV/m)	LIMIT (dBuV/m)	MARGIN (dB)	ANTENNA HEIGHT (m)	TABLE ANGLE (Degree)	RAW VALUE (dBuV)	CORRECTION FACTOR (dB/m)
1	*2480.00	95.7 PK			2.16 H	354	62.30	33.40
2	*2480.00	91.9 AV			2.16 H	354	58.50	33.40
3	2483.50	30.1 PK	74.0	-43.9	1.58 H	350	33.20	-3.10
4	2483.50	52.8 AV	54.0	-1.2	1.58 H	350	19.40	33.40
5	4960.00	48.4 PK	74.0	-25.6	2.15 H	212	45.30	3.10
6	4960.00	36.7 AV	54.0	-17.3	2.15 H	212	33.60	3.10

ANTENNA POLARITY & TEST DISTANCE: VERTICAL AT 3 M

NO.	FREQ. (MHz)	EMISSION LEVEL (dBuV/m)	LIMIT (dBuV/m)	MARGIN (dB)	ANTENNA HEIGHT (m)	TABLE ANGLE (Degree)	RAW VALUE (dBuV)	CORRECTION FACTOR (dB/m)
1	*2480.00	84.6 PK			3.49 V	325	51.20	33.40
2	*2480.00	80.4 AV			3.49 V	325	47.00	33.40
3	2483.50	57.9 PK	74.0	-16.1	2.99 V	344	24.50	33.40
4	2483.50	46.5 AV	54.0	-7.5	2.99 V	344	13.10	33.40
5	4960.00	47.2 PK	74.0	-26.8	2.20 V	333	44.10	3.10
6	4960.00	34.1 AV	54.0	-19.9	2.20 V	333	31.00	3.10

Remarks:

1. Emission Level(dBuV/m) = Raw Value(dBuV) + Correction Factor(dB/m)
2. Correction Factor(dB/m) = Antenna Factor(dB/m) + Cable Factor(dB) – Pre-Amplifier Factor(dB)
3. The other emission levels were very low against the limit.
4. Margin value = Emission Level – Limit value
5. " * ": Fundamental frequency.

Below 1GHz worst-case data:

CHANNEL	TX Channel 11	DETECTOR FUNCTION	Quasi-Peak (QP)
FREQUENCY RANGE	9kHz ~ 1GHz		
TEST MODE	A		

ANTENNA POLARITY & TEST DISTANCE: HORIZONTAL AT 3 M

NO.	FREQ. (MHz)	EMISSION LEVEL (dBuV/m)	LIMIT (dBuV/m)	MARGIN (dB)	ANTENNA HEIGHT (m)	TABLE ANGLE (Degree)	RAW VALUE (dBuV)	CORRECTION FACTOR (dB/m)
1	57.12	27.2 QP	40.0	-12.8	2.00 H	340	41.80	-14.60
2	125.17	29.9 QP	43.5	-13.6	1.51 H	117	45.70	-15.80
3	216.55	27.2 QP	46.0	-18.8	1.01 H	132	43.30	-16.10
4	383.76	24.9 QP	46.0	-21.1	2.00 H	103	36.40	-11.50
5	547.08	28.3 QP	46.0	-17.7	1.01 H	14	37.10	-8.80
6	671.52	29.4 QP	46.0	-16.6	1.01 H	14	35.90	-6.50

ANTENNA POLARITY & TEST DISTANCE: VERTICAL AT 3 M

NO.	FREQ. (MHz)	EMISSION LEVEL (dBuV/m)	LIMIT (dBuV/m)	MARGIN (dB)	ANTENNA HEIGHT (m)	TABLE ANGLE (Degree)	RAW VALUE (dBuV)	CORRECTION FACTOR (dB/m)
1	33.79	38.0 QP	40.0	-2.0	1.00 V	117	54.00	-16.00
2	62.95	35.2 QP	40.0	-4.8	1.49 V	334	50.40	-15.20
3	125.17	27.7 QP	43.5	-15.8	1.00 V	158	43.50	-15.80
4	216.55	25.8 QP	46.0	-20.2	1.49 V	117	41.90	-16.10
5	519.86	30.1 QP	46.0	-15.9	1.00 V	4	39.20	-9.10
6	652.07	26.7 QP	46.0	-19.3	1.49 V	334	33.50	-6.80

Remarks:

1. Emission Level(dBuV/m) = Raw Value(dBuV) + Correction Factor(dB/m)
2. Correction Factor(dB/m) = Antenna Factor(dB/m) + Cable Factor(dB) – Pre-Amplifier Factor(dB)
3. The other emission levels were very low against the limit.
4. Margin value = Emission Level – Limit value

CHANNEL	TX Channel 11	DETECTOR FUNCTION	Quasi-Peak (QP)
FREQUENCY RANGE	9kHz ~ 1GHz		
TEST MODE	B		

ANTENNA POLARITY & TEST DISTANCE: HORIZONTAL AT 3 M

NO.	FREQ. (MHz)	EMISSION LEVEL (dBuV/m)	LIMIT (dBuV/m)	MARGIN (dB)	ANTENNA HEIGHT (m)	TABLE ANGLE (Degree)	RAW VALUE (dBuV)	CORRECTION FACTOR (dB/m)
1	57.12	27.5 QP	40.0	-12.5	2.00 H	299	42.10	-14.60
2	70.73	25.1 QP	40.0	-14.9	1.51 H	15	41.50	-16.40
3	179.61	29.3 QP	43.5	-14.2	2.00 H	231	44.40	-15.10
4	323.49	23.8 QP	46.0	-22.2	1.51 H	118	36.00	-12.20
5	383.76	25.5 QP	46.0	-20.5	1.01 H	164	37.00	-11.50
6	671.52	27.6 QP	46.0	-18.4	1.01 H	207	34.10	-6.50

ANTENNA POLARITY & TEST DISTANCE: VERTICAL AT 3 M

NO.	FREQ. (MHz)	EMISSION LEVEL (dBuV/m)	LIMIT (dBuV/m)	MARGIN (dB)	ANTENNA HEIGHT (m)	TABLE ANGLE (Degree)	RAW VALUE (dBuV)	CORRECTION FACTOR (dB/m)
1	35.73	37.2 QP	40.0	-2.8	1.00 V	147	53.20	-16.00
2	61.01	35.0 QP	40.0	-5.0	2.00 V	189	50.00	-15.00
3	179.61	24.6 QP	43.5	-18.9	1.49 V	42	39.70	-15.10
4	276.82	19.4 QP	46.0	-26.6	1.49 V	103	32.60	-13.20
5	383.76	22.6 QP	46.0	-23.4	1.49 V	267	34.10	-11.50
6	589.86	26.3 QP	46.0	-19.7	2.00 V	338	34.00	-7.70

Remarks:

1. Emission Level(dBuV/m) = Raw Value(dBuV) + Correction Factor(dB/m)
2. Correction Factor(dB/m) = Antenna Factor(dB/m) + Cable Factor(dB) – Pre-Amplifier Factor(dB)
3. The other emission levels were very low against the limit.
4. Margin value = Emission Level – Limit value

4.2 Conducted Emission Measurement

4.2.1 Limits of Conducted Emission Measurement

Frequency (MHz)	Conducted Limit (dBuV)	
	Quasi-peak	Average
0.15 - 0.5	66 - 56	56 - 46
0.50 - 5.0	56	46
5.0 - 30.0	60	50

- Note:** 1. The lower limit shall apply at the transition frequencies.
 2. The limit decreases in line with the logarithm of the frequency in the range of 0.15 to 0.50MHz.

4.2.2 Test Instruments

Tested date: Sep. 25, 2017

Description & Manufacturer	Model No.	Serial No.	Cal. Date	Cal. Due
Test Receiver ROHDE & SCHWARZ	ESCI	100613	Nov. 21, 2016	Nov. 20, 2017
RF signal cable (with 10dB PAD) Woken	5D-FB	Cable-cond1-01	Sep. 05, 2017	Sep. 04, 2018
LISN ROHDE & SCHWARZ (EUT)	ESH3-Z5	835239/001	Mar. 10, 2017	Mar. 09, 2018
LISN ROHDE & SCHWARZ (Peripheral)	ESH3-Z5	100311	Aug. 15, 2017	Aug. 14, 2018
Software ADT	BV ADT_Cond_ V7.3.7.3	NA	NA	NA

- Note:** 1. The calibration interval of the above test instruments is 12 months and the calibrations are traceable to NML/ROC and NIST/USA.
 2. The test was performed in HwaYa Shielded Room 1.
 3. The VCCI Site Registration No. is C-2040.

4.2.3 Test Procedures

- The EUT was placed 0.4 meters from the conducting wall of the shielded room with EUT being connected to the power mains through a line impedance stabilization network (LISN). Other support units were connected to the power mains through another LISN. The two LISNs provide 50 ohm/ 50uH of coupling impedance for the measuring instrument.
- Both lines of the power mains connected to the EUT were checked for maximum conducted interference.
- The frequency range from 150kHz to 30MHz was searched. Emission levels under (Limit - 20dB) was not recorded.

Note: The resolution bandwidth and video bandwidth of test receiver is 9kHz for quasi-peak detection (QP) and average detection (AV) at frequency 0.15MHz-30MHz.

4.2.4 Deviation from Test Standard

No deviation.

4.2.5 Test Setup

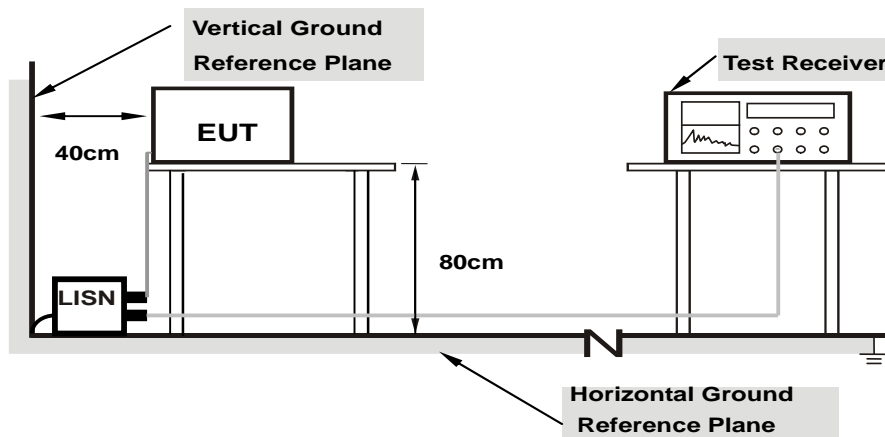

Note: 1.Support units were connected to second LISN.

For the actual test configuration, please refer to the attached file (Test Setup Photo).

4.2.6 EUT Operating Conditions

Same as 4.1.6.

4.2.7 Test Results

Phase	Line (L)	Detector Function	Quasi-Peak (QP) / Average (AV)
Test Mode	A		

No	Freq. [MHz]	Corr. Factor (dB)	Reading Value [dB (uV)]		Emission Level [dB (uV)]		Limit [dB (uV)]		Margin (dB)	
			Q.P.	AV.	Q.P.	AV.	Q.P.	AV.	Q.P.	AV.
			1	0.15391	10.45	36.85	24.06	47.30	34.51	65.79
2	0.16955	10.45	33.61	20.53	44.06	30.98	64.98	54.98	-20.92	-24.00
3	0.19692	10.45	28.27	14.78	38.72	25.23	63.74	53.74	-25.02	-28.51
4	0.47789	10.51	34.68	30.27	45.19	40.78	56.38	46.38	-11.19	-5.60
5	0.67785	10.50	21.97	17.37	32.47	27.87	56.00	46.00	-23.53	-18.13
6	21.29919	11.48	16.81	11.59	28.29	23.07	60.00	50.00	-31.71	-26.93

Remarks:

1. Q.P. and AV. are abbreviations of quasi-peak and average individually.
2. The emission levels of other frequencies were very low against the limit.
3. Margin value = Emission level - Limit value
4. Correction factor = Insertion loss + Cable loss
5. Emission Level = Correction Factor + Reading Value.

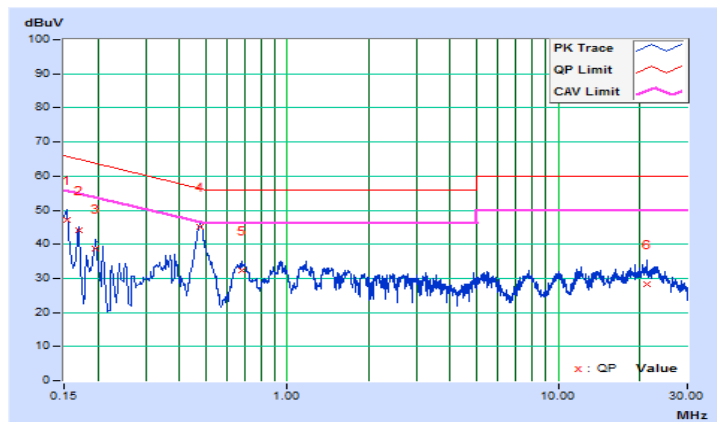

Phase	Neutral (N)	Detector Function	Quasi-Peak (QP) / Average (AV)
Test Mode	A		

No	Freq. [MHz]	Corr. Factor (dB)	Reading Value [dB (uV)]		Emission Level [dB (uV)]		Limit [dB (uV)]		Margin (dB)	
			Q.P.	AV.	Q.P.	AV.	Q.P.	AV.	Q.P.	AV.
			1	0.17737	10.21	32.03	20.37	42.24	30.58	64.61
2	0.20474	10.22	27.02	16.19	37.24	26.41	63.42	53.42	-26.18	-27.01
3	0.36526	10.23	25.02	19.24	35.25	29.47	58.61	48.61	-23.36	-19.14
4	0.47412	10.24	34.60	29.47	44.84	39.71	56.44	46.44	-11.60	-6.73
5	0.66605	10.25	23.01	19.47	33.26	29.72	56.00	46.00	-22.74	-16.28
6	1.66317	10.30	23.53	19.65	33.83	29.95	56.00	46.00	-22.17	-16.05

Remarks:

1. Q.P. and AV. are abbreviations of quasi-peak and average individually.
2. The emission levels of other frequencies were very low against the limit.
3. Margin value = Emission level - Limit value
4. Correction factor = Insertion loss + Cable loss
5. Emission Level = Correction Factor + Reading Value.

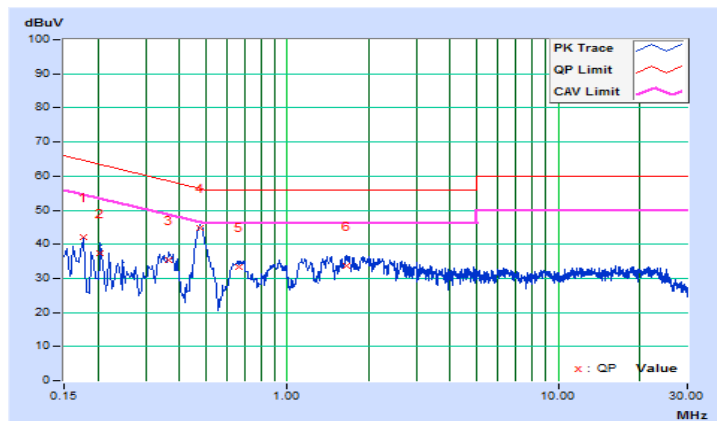

Phase	Line (L)	Detector Function	Quasi-Peak (QP) / Average (AV)
Test Mode	B		

No	Freq. [MHz]	Corr. Factor (dB)	Reading Value [dB (uV)]		Emission Level [dB (uV)]		Limit [dB (uV)]		Margin (dB)	
			Q.P.	AV.	Q.P.	AV.	Q.P.	AV.	Q.P.	AV.
			1	0.15782	10.45	35.83	22.90	46.28	33.35	65.58
2	0.18519	10.45	30.84	18.23	41.29	28.68	64.25	54.25	-22.96	-25.57
3	0.38851	10.51	24.62	18.90	35.13	29.41	58.10	48.10	-22.97	-18.69
4	0.48550	10.51	35.53	30.66	46.04	41.17	56.24	46.24	-10.20	-5.07
5	0.95937	10.48	23.86	20.35	34.34	30.83	56.00	46.00	-21.66	-15.17
6	20.38425	11.44	16.41	11.15	27.85	22.59	60.00	50.00	-32.15	-27.41

Remarks:

1. Q.P. and AV. are abbreviations of quasi-peak and average individually.
2. The emission levels of other frequencies were very low against the limit.
3. Margin value = Emission level - Limit value
4. Correction factor = Insertion loss + Cable loss
5. Emission Level = Correction Factor + Reading Value.

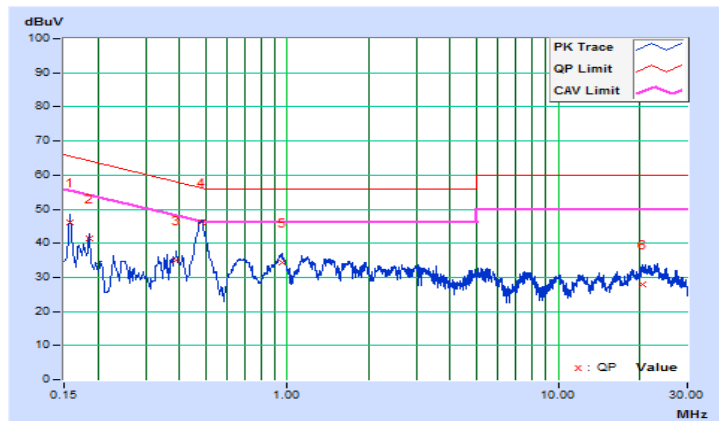

Phase	Neutral (N)	Detector Function	Quasi-Peak (QP) / Average (AV)
Test Mode	B		

No	Freq. [MHz]	Corr. Factor (dB)	Reading Value [dB (uV)]		Emission Level [dB (uV)]		Limit [dB (uV)]		Margin (dB)	
			Q.P.	AV.	Q.P.	AV.	Q.P.	AV.	Q.P.	AV.
			1	0.16173	10.21	35.86	21.95	46.07	32.16	65.37
2	0.18910	10.22	30.35	18.54	40.57	28.76	64.08	54.08	-23.51	-25.32
3	0.36526	10.23	25.00	19.08	35.23	29.31	58.61	48.61	-23.38	-19.30
4	0.47663	10.24	34.78	30.02	45.02	40.26	56.40	46.40	-11.38	-6.14
5	0.94764	10.26	22.98	20.11	33.24	30.37	56.00	46.00	-22.76	-15.63
6	20.91601	11.08	17.66	12.39	28.74	23.47	60.00	50.00	-31.26	-26.53

Remarks:

1. Q.P. and AV. are abbreviations of quasi-peak and average individually.
2. The emission levels of other frequencies were very low against the limit.
3. Margin value = Emission level - Limit value
4. Correction factor = Insertion loss + Cable loss
5. Emission Level = Correction Factor + Reading Value.

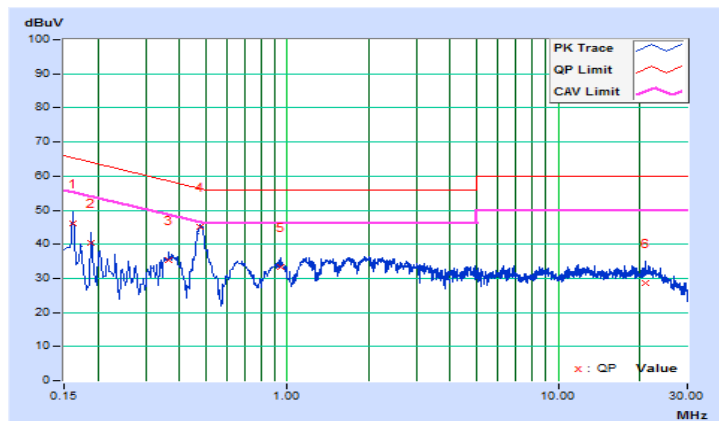

4.3 6dB Bandwidth Measurement

4.3.1 Limits of 6dB Bandwidth Measurement

The minimum of 6dB Bandwidth Measurement is 0.5 MHz.

4.3.2 Test Setup

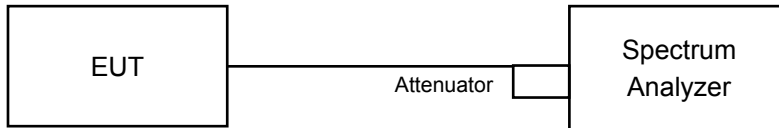

4.3.3 Test Instruments

Refer to section 4.1.2 to get information of above instrument.

4.3.4 Test Procedure

- Set resolution bandwidth (RBW) = 100kHz.
- Set the video bandwidth (VBW) $\geq 3 \times$ RBW, Detector = peak.
- Trace mode = max hold.
- Sweep = auto couple.
- Measure the maximum width of the emission that is constrained by the frequencies associated with the two amplitude points (upper and lower) that are attenuated by 6 dB relative to the maximum level measured in the fundamental emission.

4.3.5 Deviation from Test Standard

No deviation.

4.3.6 EUT Operating Conditions

The software provided by client to enable the EUT under transmission condition continuously at lowest, middle and highest channel frequencies individually.

4.3.7 Test Result

Test Mode A

Channel	Frequency (MHz)	6dB Bandwidth (MHz)	Minimum Limit (MHz)	Pass / Fail
11	2405	1.62	0.5	Pass
18	2440	1.60	0.5	Pass
26	2480	1.62	0.5	Pass

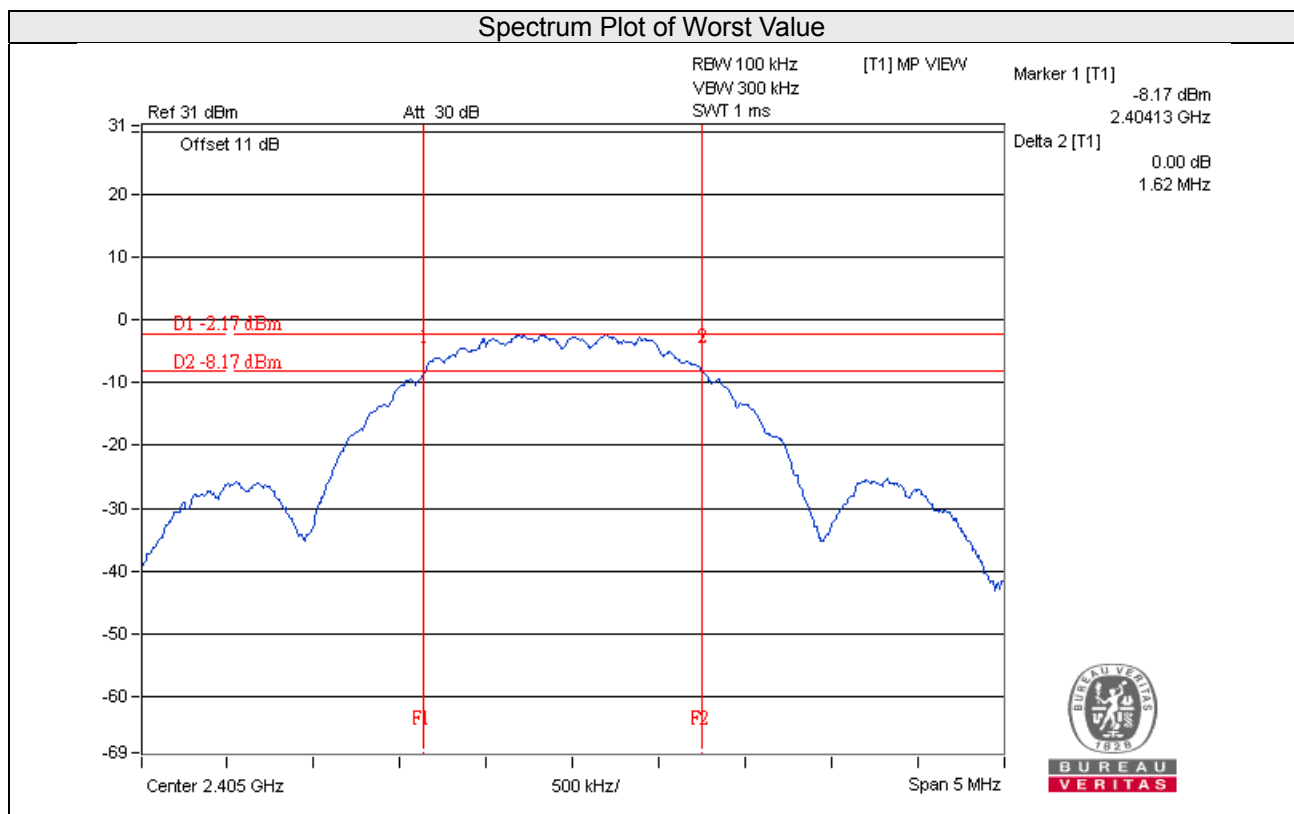

Test Mode B

Channel	Frequency (MHz)	6dB Bandwidth (MHz)	Minimum Limit (MHz)	Pass / Fail
11	2405	1.62	0.5	Pass
18	2440	1.60	0.5	Pass
26	2480	1.59	0.5	Pass

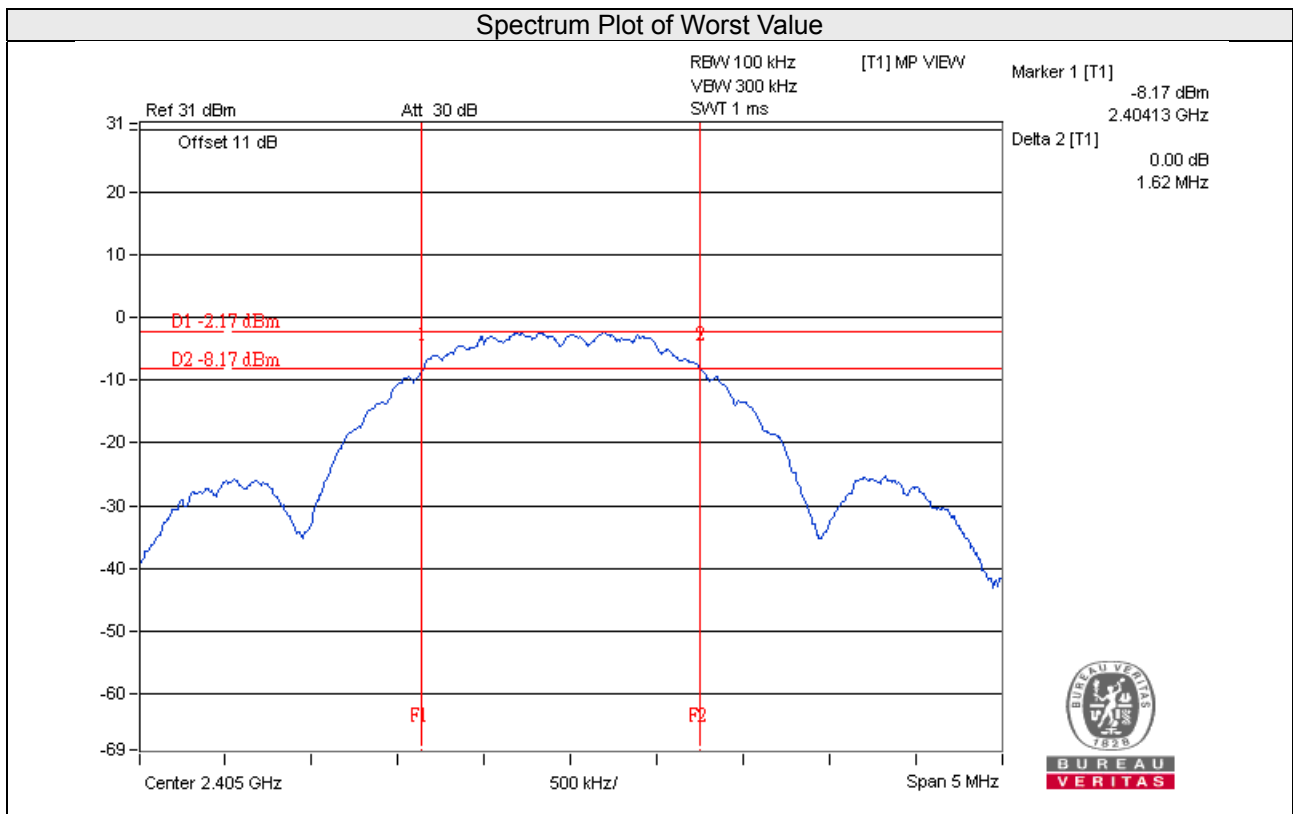

4.4 Conducted Output Power Measurement

4.4.1 Limits of Conducted Output Power Measurement

For systems using digital modulation in the 2400–2483.5 MHz bands: 1 Watt (30dBm)

4.4.2 Test Setup

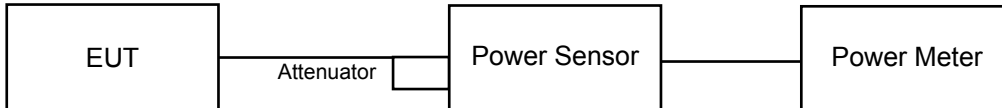

4.4.3 Test Instruments

Refer to section 4.1.2 to get information of above instrument.

4.4.4 Test Procedures

A peak power sensor was used on the output port of the EUT. A power meter was used to read the response of the peak power sensor. Record the power level.

4.4.5 Deviation from Test Standard

No deviation.

4.4.6 EUT Operating Conditions

Same as item 4.3.6.

4.4.7 Test Results

Test Mode A

Channel	Frequency (MHz)	Peak Power (mW)	Peak Power (dBm)	Limit (dBm)	Pass/Fail
11	2405	1.977	2.96	28.00	Pass
18	2440	1.941	2.88	28.00	Pass
26	2480	0.184	-7.36	28.00	Pass

Note: Gain = 8dBi > 6dBi, so the power limit shall be reduced to 30-(8-6) = 28.00dBm.

Test Mode B

Channel	Frequency (MHz)	Peak Power (mW)	Peak Power (dBm)	Limit (dBm)	Pass/Fail
11	2405	1.977	2.96	28.20	Pass
18	2440	1.941	2.88	28.20	Pass
26	2480	0.218	-6.61	28.20	Pass

Note: Gain = 7.8dBi > 6dBi, so the power limit shall be reduced to 30-(8-6) = 28.20dBm.

4.5 Power Spectral Density Measurement

4.5.1 Limits of Power Spectral Density Measurement

The Maximum of Power Spectral Density Measurement is 8dBm.

4.5.2 Test Setup

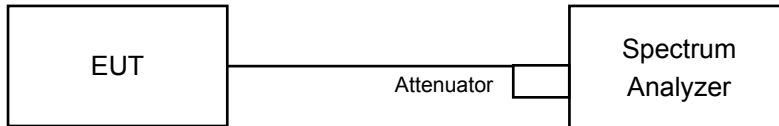

4.5.3 Test Instruments

Refer to section 4.1.2 to get information of above instrument.

4.5.4 Test Procedure

- a. Set analyzer center frequency to DTS channel center frequency.
- b. Set the span to 1.5 times the DTS bandwidth.
- c. Set the RBW to: $3 \text{ kHz} \leq \text{RBW} \leq 100 \text{ kHz}$.
- d. Set the VBW $\geq 3 \times \text{RBW}$.
- e. Detector = peak.
- f. Sweep time = auto couple.
- g. Trace mode = max hold.
- h. Allow trace to fully stabilize.
- i. Use the peak marker function to determine the maximum amplitude level within the RBW.

4.5.5 Deviation from Test Standard

No deviation.

4.5.6 EUT Operating Condition

Same as item 4.3.6

4.5.7 Test Results

Test Mode A

Channel	Frequency (MHz)	PSD (dBm/3kHz)	Limit (dBm/3kHz)	Pass / Fail
11	2405	-13.27	6.00	Pass
18	2440	-13.16	6.00	Pass
26	2480	-22.48	6.00	Pass

Note: Gain = 8dBi > 6dBi, so the power density limit shall be reduced to 8-(8-6) = 6.00dBm.

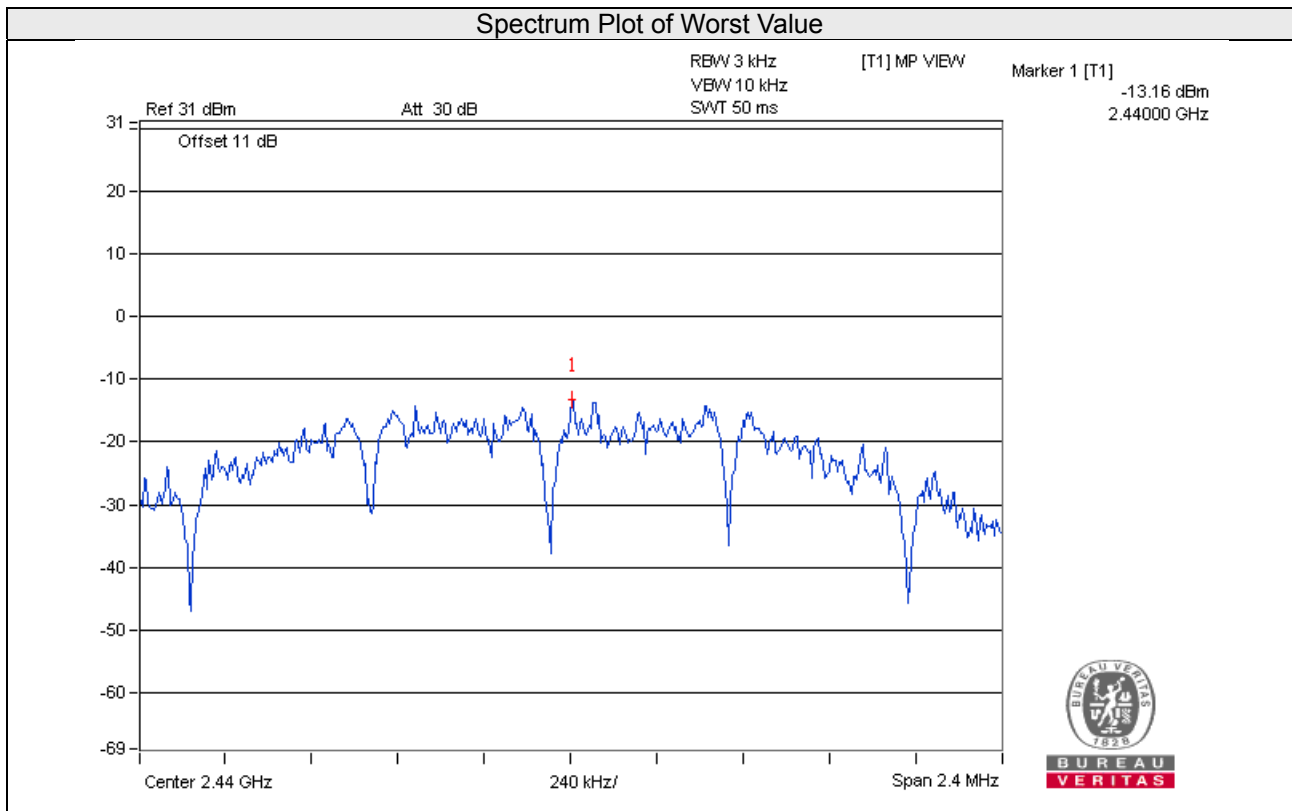

Test Mode B

Channel	Frequency (MHz)	PSD (dBm/3kHz)	Limit (dBm/3kHz)	Pass / Fail
11	2405	-13.27	6.00	Pass
18	2440	-13.16	6.00	Pass
26	2480	-21.48	6.00	Pass

Note: Gain = 8dBi > 6dBi, so the power density limit shall be reduced to 8-(8-6) = 6.00dBm.

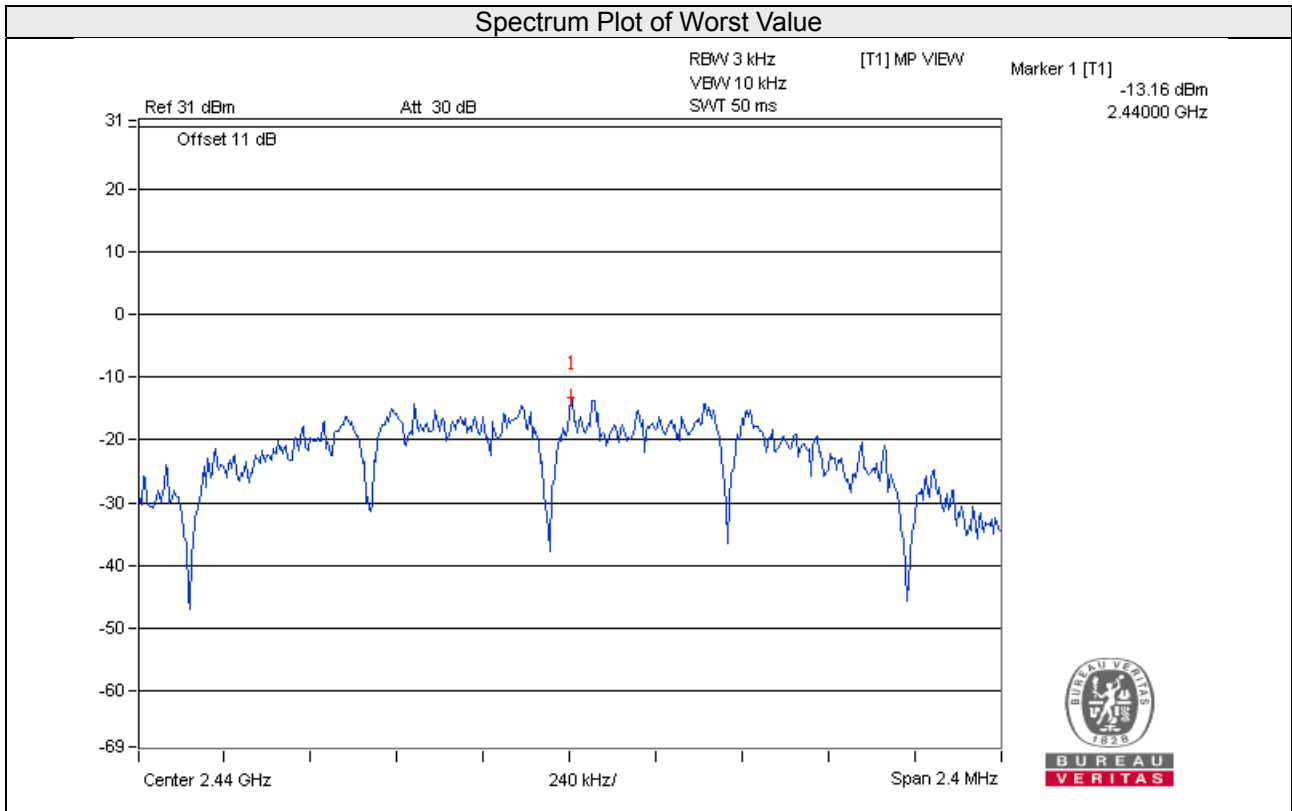

4.6 Conducted Out of Band Emission Measurement

4.6.1 Limits of Conducted Out of Band Emission Measurement

Below 20dB of the highest emission level of operating band (in 100kHz Resolution Bandwidth).

4.6.2 Test Setup

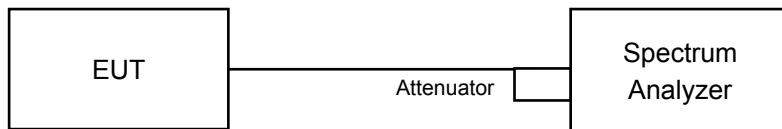

4.6.3 Test Instruments

Refer to section 4.1.2 to get information of above instrument.

4.6.4 Test Procedure

MEASUREMENT PROCEDURE REF

- Set the RBW = 100 kHz.
- Set the VBW \geq 300 kHz.
- Detector = peak.
- Sweep time = auto couple.
- Trace mode = max hold.
- Allow trace to fully stabilize.
- Use the peak marker function to determine the maximum power level in any 100 kHz band segment within the fundamental EBW.

MEASUREMENT PROCEDURE OOB

- Set RBW = 100 kHz.
- Set VBW \geq 300 kHz.
- Detector = peak.
- Sweep = auto couple.
- Trace Mode = max hold.
- Allow trace to fully stabilize.
- Use the peak marker function to determine the maximum amplitude level.

4.6.5 Deviation from Test Standard

No deviation.

4.6.6 EUT Operating Condition

Same as item 4.3.6

4.6.7 Test Results

The conducted emission test is performed on each TX port of operating mode without summing or adding 10log (N) since the limit is relative emission limit.

The spectrum plots are attached on the following pages. D1 line indicates the highest level, and D2 line indicates the 20dB offset below D1. It shows compliance with the requirement.

Test Mode A

CH 11

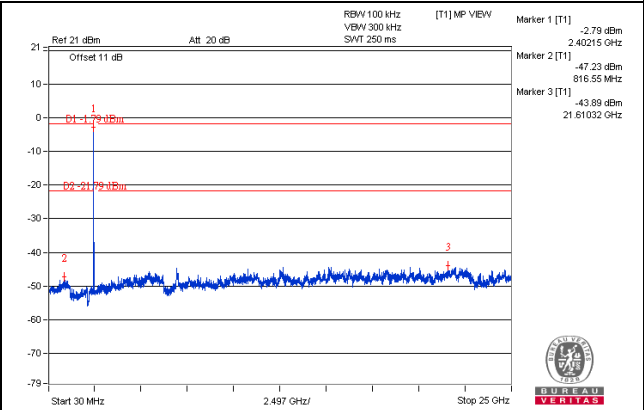
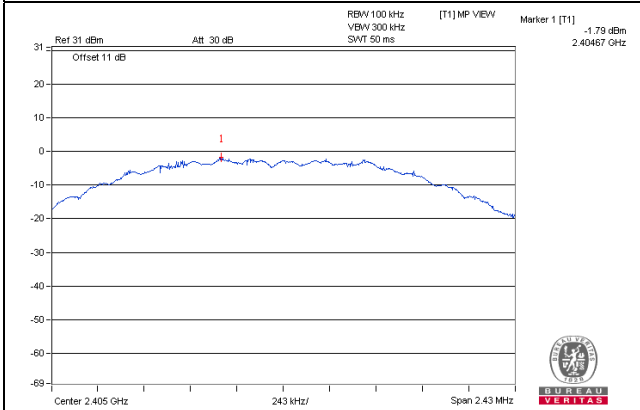

CH 18

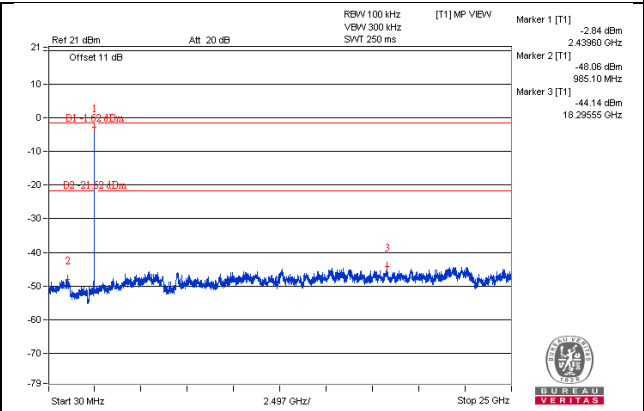
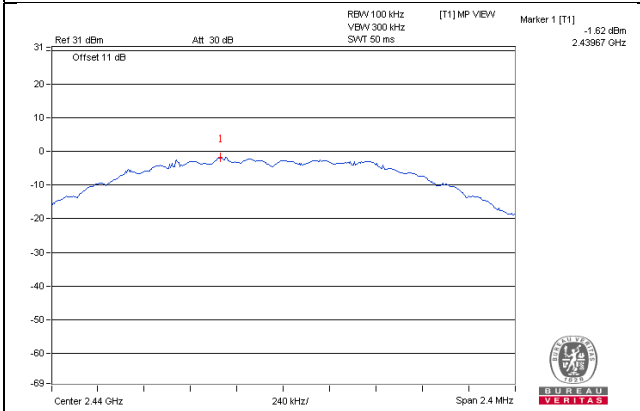

CH 26

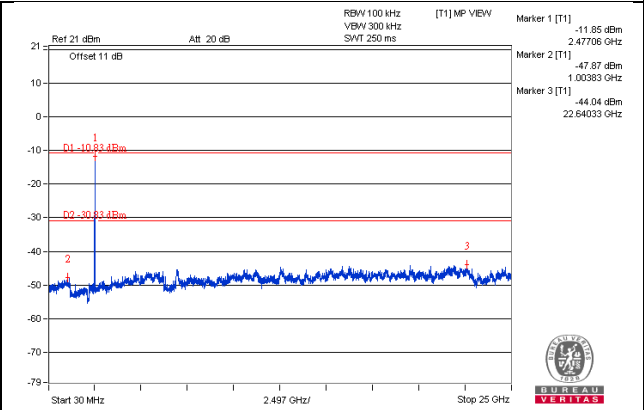
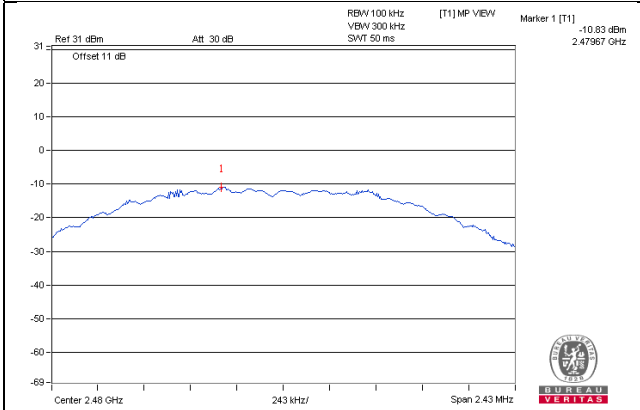

CH 11 Band edge

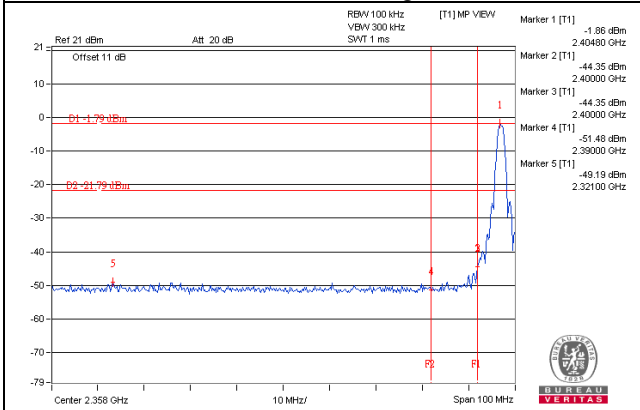

CH 26 Band edge

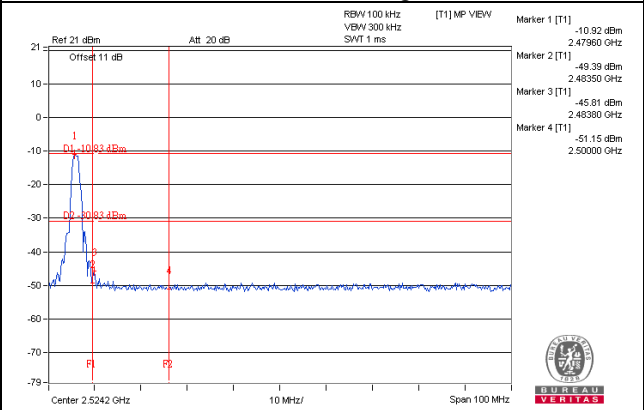

Test Mode B

CH 11

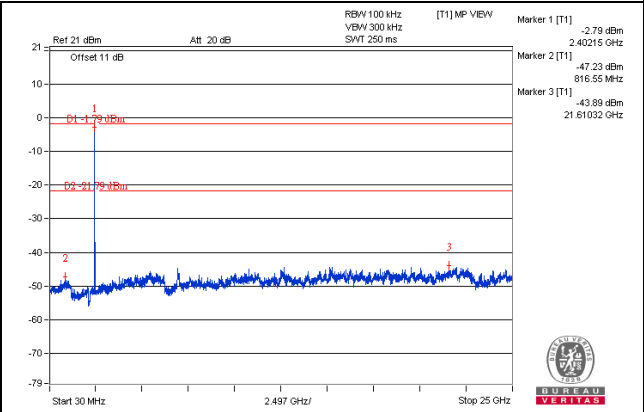
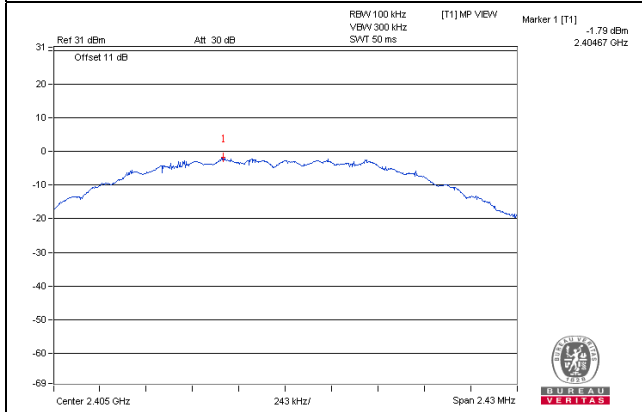

CH 18

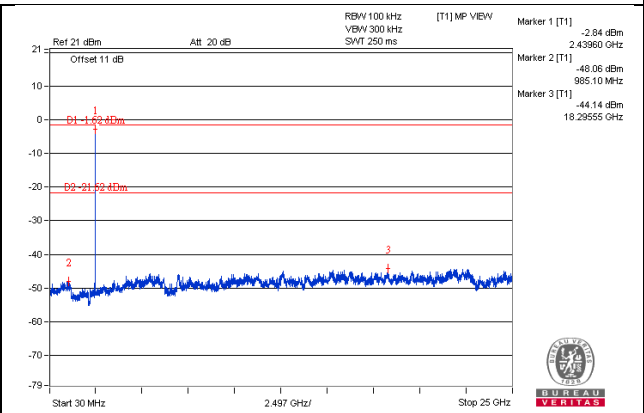
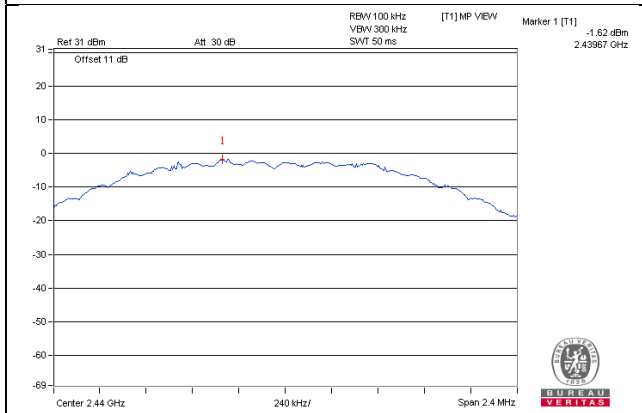

CH 26

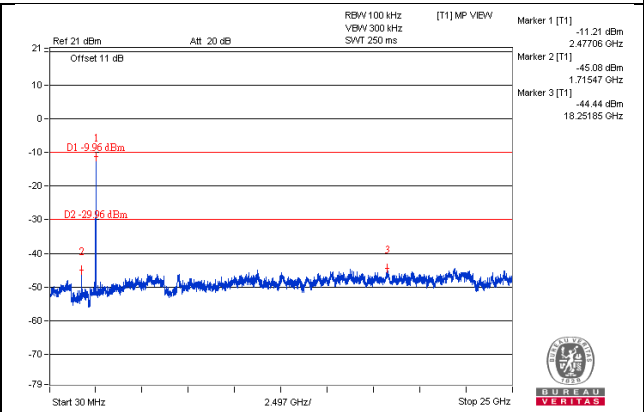
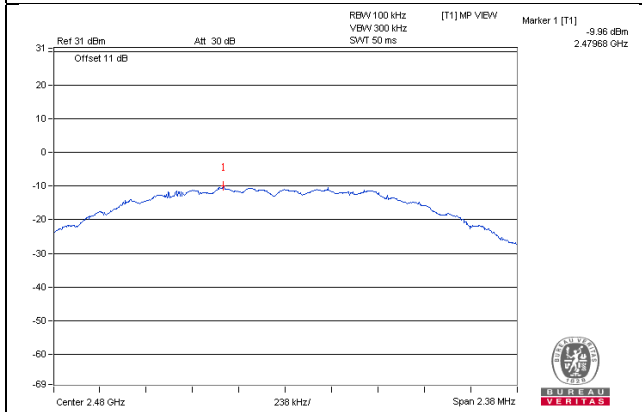

CH 11 Band edge

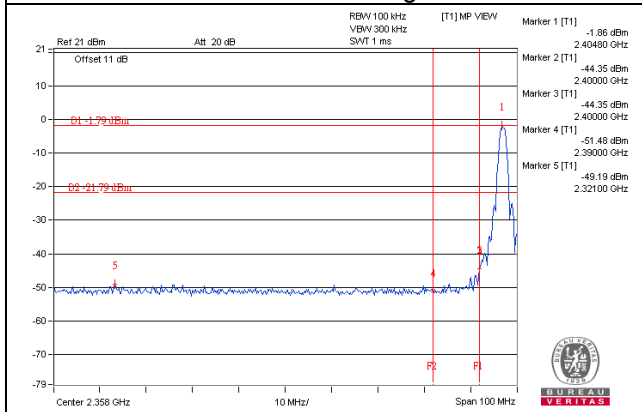

CH 26 Band edge

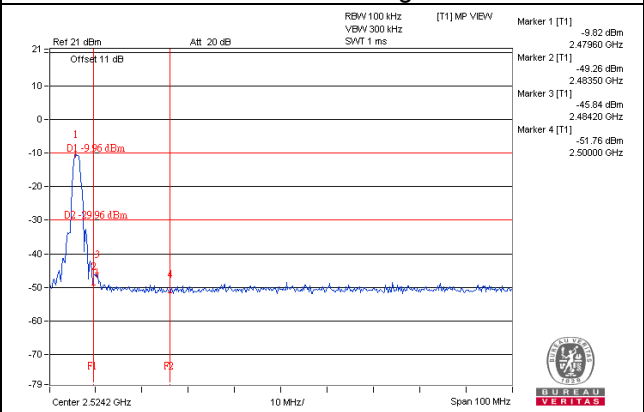

5 Pictures of Test Arrangements

Please refer to the attached file (Test Setup Photo).

Appendix – Information on the Testing Laboratories

We, Bureau Veritas Consumer Products Services (H.K.) Ltd., Taoyuan Branch, were founded in 1988 to provide our best service in EMC, Radio, Telecom and Safety consultation. Our laboratories are FCC recognized accredited test firms and accredited and approved according to ISO/IEC 17025.

If you have any comments, please feel free to contact us at the following:

Linko EMC/RF Lab

Tel: 886-2-26052180

Fax: 886-2-26051924

Hsin Chu EMC/RF/Telecom Lab

Tel: 886-3-6668565

Fax: 886-3-6668323

Hwa Ya EMC/RF/Safety Lab

Tel: 886-3-3183232

Fax: 886-3-3270892

Email: service.adt@tw.bureauveritas.com

Web Site: www.bureauveritas-adt.com

The address and road map of all our labs can be found in our web site also.

--- END ---